



Advanced Test Equipment Corp.
www.atecorp.com 800-404-ATEC (2832)

GAMRY INSTRUMENTS

Interface 5000™ Potentiostat/Galvanostat/ ZRA Operator's Manual



Copyright © 2015–2023 Gamry Instruments, Inc.
Revision 6.91
July 21, 2023
988-00034

If You Have Problems

Please visit our service and support page at <https://www.gamry.com/support-2/>. This page contains information on installation, software updates, and training. It also contains links to the latest available documentation. If you are unable to locate the information you need from our website, you can contact us via email using the link provided on our website. Alternatively, you can contact us one of the following ways:

Internet	https://www.gamry.com/support-2/
Telephone	(215) 682-9330 9:00 AM–5:00 PM US Eastern Standard Time (877) 367-4267 Toll-free US & Canada Only

Please have your instrument model and serial numbers available, as well as any applicable software and firmware revisions.

If you have problems in installation or use of a system containing an Interface 5000, please try to call from a phone next to your computer, where you can type and read the screen while talking to us.

We will be happy to provide a reasonable level of free support for registered users of the Interface 5000 Potentiostat/Galvanostat/ZRA. Reasonable support includes telephone assistance covering the normal installation, use, and simple customization of a computerized system containing an Interface 5000 connected to a Windows®-compatible computer.

A service contract that extends both the hardware warranty and software update period is available at an additional charge. Software updates **do not** include software enhancements offered to our customers at additional cost.

Enhancements to the Interface 5000 and Gamry's standard applications software that require significant engineering time on our part can be performed on a contract basis. Contact us with your requirements.

Limited Warranty

Gamry Instruments, Inc. warrants to the original user of this product that it shall be free of defects resulting from faulty manufacture of the product or its components for a period of two years from the original shipment date of your purchase.

Gamry Instruments, Inc. makes no warranties regarding either the satisfactory performance of the Interface 5000 Potentiostat/Galvanostat/ZRA including the software provided with this product or the fitness of the product for any particular purpose. The remedy for breach of this Limited Warranty shall be limited solely to repair or replacement, as determined by Gamry Instruments, Inc., and shall not include other damages.

Gamry Instruments, Inc. reserves the right to make revisions to the system at any time without incurring any obligation to install same on systems previously purchased. All system specifications are subject to change without notice.

There are no warranties which extend beyond the description herein. This warranty is in lieu of, and excludes any and all other warranties or representations, expressed, implied or statutory, including merchantability and fitness, as well as any and all other obligations or liabilities of Gamry Instruments, Inc., including but not limited to, special or consequential damages.

This Limited Warranty gives you specific legal rights and you may have others, which vary from state to state. Some states do not allow for the exclusion of incidental or consequential damages.

Disclaimers

No person, firm or corporation is authorized to assume for Gamry Instruments, Inc., any additional obligation, or liability not expressly provided herein except in writing duly executed by an officer of Gamry Instruments, Inc.

Disclaimers

Gamry Instruments, Inc. cannot guarantee that the Interface 5000 Potentiostat/Galvanostat/ZRA will work with all computer systems, operating systems, and third-party software applications hardware or software.

The information in this manual has been carefully checked and is believed to be accurate as of the time of release. However, Gamry Instruments, Inc. assumes no responsibility for errors that might appear.

Copyrights

Interface 5000™ Potentiostat/Galvanostat/ZRA Operator's Manual copyright © 2015–2023, Gamry Instruments, Inc., all rights reserved.

Gamry Framework copyright © 1989–2023, Gamry Instruments, Inc., all rights reserved.

Interface 1010™, Interface 5000™, Interface Power Hub™, EIS Box™ 5000, Reference 620™, Reference 3000™, Reference 3000AE™, Reference 30K™, LPI1010™, eQCM 15M™, IMX8™, Gamry Framework™, Faraday Shield™, and Gamry™ are trademarks of Gamry Instruments, Inc.

Windows® and Excel® are registered trademarks of Microsoft Corporation.

Swagelok is a registered trademark of Swagelok Company.

No part of this document may be copied or reproduced in any form without the prior written consent of Gamry Instruments, Inc.

Table of Contents

If You Have Problems	3
Limited Warranty.....	3
Disclaimers	4
Copyrights	4
Table of Contents.....	5
Chapter 1: Safety Considerations	9
Inspection.....	9
Product Safety.....	9
AC Mains Connection to the Power Brick.....	9
Grounding in the Interface 5000	10
Operation with Earth-grounded Cells and Auxiliary Apparatus	11
Temperature and Ventilation.....	11
Defects and Abnormal Stresses.....	12
Environmental Limits.....	12
Cleaning.....	12
Service.....	13
RF Warning.....	13
Electrical Transient Sensitivity	13
CE Compliance	14
RoHS Compliance.....	14
Chapter 2: Introduction	15
About this Manual.....	15
About the Interface 5000	15
Software and Applications.....	16
Multichannel Potentiostat Systems.....	16
Front-Panel Customization	17
Notational Conventions.....	17
Chapter 3: Installation.....	19
Initial Visual Inspection	19
Physical Location	19
Computer Requirements.....	20
Quick Start Guide for System Installation.....	20
Software Installation	20
Reboot Your Computer after Software Installation.....	20
Power Cord and Power Connection	21
Power-up Test.....	21
USB Cables.....	22
Multiple Potentiostat Systems	23
Cell Cable Installation.....	23
Front-panel USB LED	24
Running the Framework.....	24
Framework Device Status Bar	24
Types of Interface 5000 instruments	25
Authorization Codes and Label.....	25
Firmware Update.....	26
The Interface 5000 Customization Label.....	26
Introduction to the Interface 5000 Customization Label.....	26
Label Sheet Provided with Each Interface 5000.....	27

Table of Contents

How to Change the Label on an Interface Family Potentiostat	27
Chapter 4: Calibration	31
Introduction	31
DC Calibration	31
Cable Calibration	32
Procedure to calibrate the cable	33
Chapter 5: Cell Connections	37
Cell Cable Overview	37
Ancillary Apparatus	37
Fuses in the Cell Cable	37
Normal Cell Connections	38
Three-Electrode Battery Connections.....	39
ZRA Mode Cell Connections	40
Membrane Cell Connections	41
Fuses in the Cell Cable	41
Testing For Open Fuses	43
Chapter 6: Panel Indicators and Connectors.....	45
Front Panel	45
Power Button	45
The PWR LED	45
Cell Connectors.....	46
Monitor Connector	47
The USB LED	47
Cell On LED.....	48
Overload LED	48
Customization Label Area.....	49
Rear Panel	50
Power In Jack.....	50
Chassis Ground	50
USB Port.....	51
User I/O Connector.....	51
Sync Port	52
Chapter 7: Instrument Circuitry.....	53
Interface 5000 Schematic/Block Diagrams	53
Appendix A: Interface 5000 Specifications	59
Control Amplifier	59
Differential Electrometer.....	59
Voltage Measurement.....	59
Current to Voltage Converter.....	60
Current Measurement	60
Potentiostatic Mode	60
Galvanostatic Mode	60
Temperature Measurement	61
Environmental.....	61
General.....	61
Appendix B: Interface 5000 Cell Connectors.....	65
Appendix C: I/O Connectors.....	67
User I/O Connector.....	67
Sync Port	68
Monitor Connector	69
I Monitor Signal.....	69

Table of Contents

E Monitor Signal 70
External Signal In 70
AUX IN 71
Temperature Monitor Signal 71

Appendix D: Power LED Blink codes and Error Messages 73
 Blink Codes 73
 Normal Start-up 73
 Failure in an electronics module 73
 Severe problem 73
 Error Messages and Limitations 73
 Error Message This instrument is not authorized for Freq= 74

Appendix E: Certifications 75
 Declaration of Conformity: No. DOC-2018-CE-IFC5000 75
 Low Voltage Certificate of Conformance 76
 RFI Certificate of Conformance 77
 Declaration of Conformity: No. DOC-2021-UKCA-IFC5000 78

Appendix F: Heat in Interface 5000 Multichannel Systems 79
 Introduction to Device Power-dissipation 79
 Potentiostat/Galvanostat Power Model 79
 Discharging a Battery 80
 Single Interface 5000 81
 Vertical Stacks 81
 Interface Power Hub Systems 81

Appendix G: Optional Interface 5000 Monitor Board 83
 Introduction 83
 Connectors 83
 EXT SIG IN 83
 AUX IN 83
 E Monitor 84
 I Monitor 84
 RTD 85
 Input (unlabeled) 85

Appendix H: Index 87

Chapter 1: Safety Considerations

Your Interface 5000 Potentiostat/Galvanostat/ZRA has been supplied in a safe condition. This chapter of the Interface 5000 Operator's Manual contains information and warnings that you must follow to ensure continued safe operation of the Interface 5000.

Inspection

When you receive your Interface 5000 Potentiostat/Galvanostat/ZRA, inspect it for evidence of shipping damage. If you observe any damage, please notify Gamry Instruments Inc. and the shipping carrier immediately. Save the shipping container for possible inspection by the carrier.



Warning: An Interface 5000 damaged in shipment can be a safety hazard. Do not operate damaged apparatus until a qualified service technician has verified its safety. Tag a damaged Interface 5000 to indicate that it could be a safety hazard.

Product Safety

The Interface 5000 has been designed, tested, and certified to meet the requirements of EN 61010, *Safety requirements for electrical equipment for measurement, control, and laboratory use*. As defined in this standard, it is a Category II apparatus, with any "hazardous live voltages" protected by "reinforced insulation".

Most of the Interface 5000 circuitry operates at voltages low enough to be considered safe. The Interface 5000 contains a limited amount of internal circuitry that is at "hazardous live" voltage as defined in EN 61010 (the standard mentioned above). "Reinforced insulation" (again defined in EN 61010) is used to reduce the risk of electrical shock caused by this hazardous live voltage.

The majority of the Interface 5000's circuitry does not contain voltages higher than 15 V DC. Generally, input and output voltages in the Interface 5000 are limited to ± 9 V. This voltage level is considered safe.

The "AC Adapter" supplied with the Interface 5000 is certified under EN 60950. The AC Adapter converts the AC mains voltage to 48 V DC, which is used to power the Interface 5000.

If your Interface 5000 is not installed in an Interface Power Hub (IPH), use the AC adapter (power brick) supplied with your Interface 5000 to supply DC power to the instrument. If your Interface 5000 is installed in an IPH, the IPH provides its power.



Caution: Use only Gamry-approved DC power sources with your Interface 5000. Other power sources may alter the performance and/or safety characteristics of the Interface 5000.

If you power up the Interface 5000 with an Interface 1000 power supply, the unit may work at low output currents. Operation at full power, however, is likely to cause abnormal operation; the problems may be subtle. Use **only** the Interface 5000 power supply with the Interface 5000.

AC Mains Connection to the Power Brick

The Interface 5000 does not connect directly to an AC Mains supply. Instead, the mains are connected to a desktop AC adapter (power brick), which outputs 48 V DC, which in turn powers the Interface 5000.



The Interface 5000's AC Adapter is rated for operation from 100 to 240 V AC, 47 to 63 Hz. It should therefore be useful throughout the world.

The Interface 5000 is normally provided with an AC line cord suitable for your location. This AC line cord connects the AC mains to the AC power adapter. If your Interface 5000 has been provided without an AC line cord, or a cord that is not compatible with your local AC mains socket, obtain a line cord certified for use in your country. Contact your local Gamry Representative or email to techsupport@gamry.com if you are uncertain what AC line cord to use.

Grounding in the Interface 5000

The circuitry and the metal case of the Interface 5000 are **not** connected to an earth ground. If they were connected to earth ground, it would compromise the Interface 5000's ability to make measurements in electrochemical cells that contain earth-grounded metal. A few examples of such cells include fuel cells, flow batteries, and certain complex battery-packs.

Most electrochemical cells are isolated from earth ground, so isolation of the Interface 5000 from earth is not required. In these cases, connection of the Interface 5000 chassis to an earth ground may lower the noise seen in an electrochemical test. A Chassis Ground banana jack on the rear panel of the Interface 5000 easily implements this connection. Simply run a wire from this binding post to a suitable source of earth ground. A black 1.2-meter banana-to-banana lead is provided with the Interface 5000 to facilitate this connection.



Sources of earth ground include

- Most metal water pipes,
- The chassis of **most** electronic apparatus (which are generally earth-grounded), and
- The protective ground terminal of an AC mains power plug.

We recommend that you discuss grounding with an electrical or electronics professional prior to making this earth-ground connection.

This connection of the Interface 5000 to an earth ground is not a "Protective Earth Ground" as defined in EN 61010. The Interface 5000 is safe in the absence of this connection.



Warning: Do not connect the chassis ground binding post to any voltage other than earth ground. An improper connection can create a safety hazard, which could result in personal injury or death.

This binding post is not intended for any use other than connecting the Interface 5000 to an earth ground to improve shielding against noise. Connecting this binding post to a hazardous voltage can create a significant safety hazard.

The Interface 5000 contains surge suppressors that limit the voltage difference between the Interface 5000's chassis ground and earth ground to about 28 V. These surge suppressors are not part of the safety mechanisms in the Interface 5000. Instead, they are present to limit the possibility of improper instrument operation or instrument damage due to electrostatic discharge (static electricity) and other surge events such as lightning.



Caution: The surge suppressors can be irreparably damaged by non-transient voltages that exceed their threshold voltage of ± 28 V. In the worst case this can cause catastrophic failure of the system. Do not connect an Interface 5000 to a cell in a battery or fuel cell stack when the cell voltage is far from earth ground.

Operation with Earth-grounded Cells and Auxiliary Apparatus

As described above, the Interface 5000 circuitry is isolated from earth ground, allowing it to make measurements on cells that include an earth ground. This ground isolation is often called floating operation. Cells with earth ground include many fuel cells, flow batteries, and certain complex battery-packs.

Connection of the Interface 5000 to auxiliary apparatus will often earth-ground the Interface 5000, destroying its ability to float and make measurements on earth-grounded cells. Connection of the **Monitor Connector** to an oscilloscope is an example where the instrument is earthed.

The **User I/O** connector must be connected with care. Connection of the **User I/O** connector to earth-grounded apparatus can easily earth-ground the Interface 5000. The metal shell on the Interface 5000 **User I/O** Connector is connected to the instrument's chassis which is a floating ground. In a system that needs isolation from earth ground, the shield of your I/O cable must not connect the D-connector's metal shell to earth ground. Reference all user I/O signals to pin 6 of the D-connector, which is an earth ground on the Interface 5000.



Caution: Floating operation of the Interface 5000 can be compromised by improper cables to your I/O Connector. We do not recommend use of standard 15-pin shielded cables with this connector. Custom cables with the shield connected to pin 6 of the D-connector are preferred.

Temperature and Ventilation

Your Interface 5000 Potentiostat/Galvanostat/ZRA was designed for indoor use at ambient temperatures between 0°C and 45°C.

The Interface 5000 uses forced-air cooling to keep the Interface 5000 components within their operating temperature range. Most of the air needed to cool the Interface 5000 enters the chassis through holes in its bottom plate. Some air also enters the chassis from small slots on the right side of the chassis (as viewed from the front of the instrument).

The fan within the Interface 5000 has two operating speeds with different audible noise levels. The Interface 5000 normally operates with the slower, quieter fan setting. The fan switches to a higher speed when the Interface 5000's internal heat sink gets hotter than 50°C.

The cooling air flows through a heat sink mounted inside the chassis. The air exits through a large array of slots on the left side of the instrument.



Caution: Do not block the airflow into or out of the Interface 5000 chassis. The circuitry is thermally protected so over-temperature will cause the instrument to enter a shut-down state. If shut-down occurs during data-acquisition, experimental data could be lost. Running the Interface 5000 without adequate cooling could also shorten the time to failure of some of the circuitry.

Be careful when operating the Interface 5000 in an enclosed space (such as an enclosed relay rack or NEMA enclosure). The temperature within the enclosure must not exceed 45°C. You may need to provide ventilation holes or even forced air-cooling for the enclosed space if excessive temperature rise occurs.

Defects and Abnormal Stresses

Treat your Interface 5000 as potentially hazardous if any of the following is true of the unit:

- It shows visible damage,
- It does not operate properly,
- It has been stored for a long period of time under unfavorable conditions,
- It has been dropped or subjected to severe transport stress,
- It has been subjected to environmental stress (corrosive atmosphere, fire, etc.).

Do not use your Interface 5000 or any other apparatus if you think it could be hazardous. Have it checked by qualified service personnel.

Environmental Limits

Note that there are environmental limit conditions on the storage, shipping and operation of this equipment. The Interface 5000 has **not** been designed for outdoor use.

Storage	Ambient temperature	-40°C to 75°C
	Relative humidity	Maximum 90% non-condensing
Shipping	Same as storage plus	
	Acceleration	Maximum 30 G
Operation	Ambient temperature	0°C to 45°C
	Relative humidity	Maximum 90% non-condensing



Warning: The Interface 5000 is not designed for operation in conditions where liquid water may enter the chassis, or water vapor may condense within the chassis. Operation of an Interface 5000 that has water within the chassis can create a safety hazard, which could result in personal injury or death.

Cleaning

Disconnect the Interface 5000 from all power sources prior to cleaning.

Use a cloth **lightly** dampened with either clean water or water containing a mild detergent, to clean the outside of the Interface 5000 enclosure. Alternatively, you may use isopropyl alcohol. Do not use a wet rag or allow fluid to enter the Interface 5000 enclosure. Do not immerse the Interface 5000 in any type of cleaning fluid (including water). Do not use any abrasive cleaners.

Service

Your Interface 5000 Potentiostat/Galvanostat/ZRA has no user-serviceable parts inside. Refer all service to a qualified service technician.



Warning: Never operate the Interface 5000 with any cover or panel on the chassis open. Dangerous voltages may be present at several points within the Interface 5000 chassis, including PC board traces. Always remove the power connection before opening the Interface 5000 case.

RF Warning

The Interface 5000 has been tested for both radiated and conducted RF interference and for immunity to RF fields and has been found to be in compliance with FCC Part 18 and EN 61326:1998—*Electrical equipment for measurement, control, and laboratory use—EMC Requirements*.

However, your Interface 5000 Potentiostat/Galvanostat/ZRA still does generate some radio-frequency energy. The radiated levels are low enough that the Interface 5000 should not create an interference problem in most industrial laboratory environments.

Your Interface 5000 Potentiostat/Galvanostat/ZRA may also respond to environmental radio-frequency energy. We recommend you avoid using mobile phones and other radio-frequency equipment in the same room as an Interface 5000. The Interface 5000 circuitry has been tested for operation in high-intensity RF fields and has demonstrated little response to those fields. However, there is no guarantee that the electrochemical cell and its connections will not respond to RF fields. This response most often appears as DC shifts in a cell's response caused by rectification of the RF signal.

A Faraday cage surrounding your cell may be used to minimize the effect of environmental RF fields. If your cell is isolated from earth ground, Gamry recommends connecting your Interface 5000 to earth ground, and then connecting the Faraday cage to the Interface 5000's floating ground (the black lead on the cell cable).

Electrical Transient Sensitivity

Your Interface 5000 Potentiostat/Galvanostat/ZRA was designed to offer reasonable immunity from electrical transients, including transients on the incoming AC mains supply and electrostatic discharge. It has been tested for compliance with EN 61326:1998—*Electrical equipment for measurement, control, and laboratory use—EMC Requirements* describing acceptable limits for electrical transient susceptibility in laboratory test equipment. It should continue to operate when subject to the standard ESD and power-line events defined in EN 61326.

In severe cases involving transients beyond the limits tested in EN 61326, the Interface 5000 could still malfunction as a result of electrical transients. If you are having problems in this regard, the following steps may help:

If the problem is static electricity (sparks are apparent when you touch the Interface 5000 or its cables):

- Try placing your Interface 5000 on a static-control work surface. Static-control work surfaces are now generally available from computer-supply houses and electronics-tool suppliers. An antistatic floor mat may also help, particularly if a carpet is involved in generating the static electricity.

Safety Considerations

- Air-ionizers or even simple air-humidifiers can reduce the voltage available in static discharges.

If the problem is AC power-line transients (often from large electrical motors near the Interface 5000):

- Try plugging your Interface 5000 into a different AC power branch circuit.
- Plug your Interface into a power-line surge-suppressor. Inexpensive surge-suppressors are now generally available because of their use with computer equipment.

Contact Gamry Instruments, Inc. if these measures do not solve the problem.

CE Compliance

The European Community has instituted standards limiting radio-frequency interference emitted by electronic devices, setting limits for susceptibility of apparatus to RF energy and transient events, and mandating safety requirements. Gamry Instruments, Inc. has designed and tested the Interface 5000 to comply with these standards.

The relevant CE regulations include EN 61010 and EN 61326.

RoHS Compliance

The Interface 5000 is built using lead-free components and lead-free solder. It is in compliance with the European RoHS initiative.

Chapter 2: Introduction

About this Manual

This manual covers the installation, safety, and use of the Gamry Instruments Interface 5000 Potentiostat/Galvanostat/ZRA.

This manual describes use of an Interface 5000 with Revision 7 (and later revisions) of the Gamry Framework software. It is equally useful when setting up a newly-purchased potentiostat or modifying the setup of an older potentiostat for use with new software.

Chapter 1 was an in-depth discussion of safety issues. This chapter describes this manual and gives a brief overview of the Interface 5000 features. Chapter 3 contains Interface 5000 installation instructions. Chapter 5 describes cell cable-connections, and Chapter 6 describes the Interface 5000's front and rear panels. Chapter 7 is a description of the electronic circuitry in the Interface 5000.

You will find technical material such as specifications and connector pin-outs in the Appendices. Appendix F discusses heat-generation in multiple-potentiostat systems based on the Interface 5000 and makes recommendations for heat-management.

This manual discusses software installation and software operation in some detail. The installation is written assuming installation using Revision 7 of Gamry's Framework software. Installation is also described in Gamry's Quick-Start Installation Guide for USB Potentiostats.

Software support for the Interface 5000 is described in the Gamry Help system.

All Gamry Instruments applications running under the Gamry Framework control the Interface 5000 via a PSTAT object. See the Framework's Help for information concerning PSTAT objects and their functions.

About the Interface 5000

The Interface 5000 is a value-oriented, research-grade electrochemical instrument packaged in a small, easy-to-handle case. It works particularly well in systems with multiple instruments connected to one computer. It offers measurement capabilities similar or superior to those of instruments that are more than ten times its size and weight and more than three times its price.

The Interface 5000 excels at laboratory testing of small- to medium-sized single-cell energy-storage and power-conversion devices. Such devices include batteries, electrical double-layer capacitors, fuel cells, and photovoltaic cells. The Interface 5000 can apply and measure currents from 5 A to $\sim 0.05 \mu\text{A}$.

The Interface 5000 can operate as a potentiostat, a galvanostat, or a ZRA (zero-resistance ammeter).

Features of the Interface 5000 include:

- Six-decade current auto-ranging,
- Electrical isolation from earth ground,
- Current-interrupt iR compensation, and
- Both analog and digital filtering.

The Interface 5000 has a special feature to improve its ability to discharge batteries. See Appendix F for details. The Interface 5000 compliance voltage is normally ± 6.5 V. The Framework software, when discharging a battery, lowers one side of the instrument's compliance to 2.3 V. This greatly reduces power-dissipation and heat generation in the instrument, allowing 5 A current flow in a compact package.

A sine-wave generator on the Interface 5000 allows the instrument to make *accurate* impedance measurements at frequencies up to 1 MHz. EIS performance is good for low-impedance systems (such as low-ESR electrical double-layer capacitors).

Data can be acquired at frequencies up to 100 000 points per second.

A unique DSP (Digital Signal Processing) data-acquisition mode allows the Interface 5000 to reject noise, from the instrument itself, from the electrochemical cell, and from the lab environment. In many cases where other instruments require a cell in a Faraday shield to make quiet measurements, the Interface 5000 can be used with the cell exposed on a bench top.

The Interface 5000, like all Gamry potentiostats, requires a computer for its use. The Interface 5000 connects to this computer through a USB connection. The USB connection has become truly universal, with USB ports found on all modern computers. Gamry Windows®-based software currently supports up to 16 Gamry Potentiostats connected to one computer. A system can include a mixture of Gamry Reference and Interface-family instruments.

The Interface 5000 is isolated from earth ground. You therefore can use it to make measurements on cells that contain an earth-grounded metal. A few of the many examples of such systems are fuel cells, flow batteries, and certain complex battery-packs.

Software and Applications

The Interface 5000 supports **all** Gamry electrochemical applications software, including the Gamry Electrochemical Energy software. The Electrochemical Energy software was not supported on several older, low-cost instruments.

The Interface 5000 is particularly useful in laboratories where high-test throughput is required. Multiple Interface 5000s can be used to configure flexible multichannel systems, where the number of potentiostats in each system can vary as needed. For example, a dozen Interface 5000s in a lab can be used as one eight-potentiostat multichannel system and four stand-alone systems in one week, then used as two six-potentiostat multichannel systems the next week.

Typical applications for the Interface 5000 include:

- Research in electrochemical storage and conversion, and
- Battery and electrochemical capacitor evaluation.

Multichannel Potentiostat Systems

The Interface 5000 can form several different types of multiple-potentiostat systems. You can mix Interface 5000s and Interface 1000s in all systems.

In one type of system, multiple Interface 5000 units are simply stacked on top of each other. The Interface 5000 chassis was designed for easy and secure stacking. The rubber feet on the bottom of one instrument mate with indentations in the top of the instrument below.

In this type of system, each Interface 5000 is powered by an individual AC Adapter, which, in turn, can be powered by a multiple output AC power strip. The multiple USB connections for the system can be obtained from an inexpensive commercial USB hub. We do not recommend bus-powered hubs in these systems.

In a more formal, less-cluttered system, you can add multiple Interface 5000 units to a special Gamry-supplied rack called the Interface Power Hub. This smart rack arranges units side-by-side and takes care of power and USB connections. Individual units can still be easily added and removed as required.

In some multiple potentiostat systems, users want synchronized operation of several potentiostats. This is often desirable when multiple units are connected to one electrochemical cell. Examples of this include ring-disk systems, series-connected laminar-flow generation-detection systems, localized EIS, and electrochemical microscopy.

A special synchronization port (Sync port) on the rear of each Interface 5000 allows one Master instrument to control the clocks and data-acquisition timing of multiple Serf instruments. The Master can even generate sine waves used for EIS experiments and the Serfs can acquire very accurate EIS data derived from the Master's excitation waveform. Additional information concerning synchronization cables can be found in Appendix C.

Heat can be an issue in a multichannel potentiostat system. This subject is discussed in detail in Appendix F of this manual.

Front-Panel Customization

The Interface 5000 supports a custom labeling scheme for identifying potentiostats in a multiple-potentiostat system. A clear window in the plastic overlay on the Interface 5000's front panel lets you create your own identification of each potentiostat in a system.

Interface 5000s are shipped with an identifier in this label location. For individual instruments, this label is the serial number. In larger multichannel systems, this might be Pstat 1, Pstat 2, Pstat3, etc. See Chapter 3 for more details.

Notational Conventions

In order to make this manual more readable we have adopted some notational conventions. These are used throughout this manual and all other Gamry Instruments manuals:

- Numbered lists. A numbered list is reserved for step-by-step procedures, with the steps always performed sequentially.
- Bulleted list. The items in a bulleted list, such as this one, are grouped together because they represent similar items. The order of items in the list is not critical.
- File names and folders. Inside paragraphs, references to computer files and Windows folders will be capitalized and placed within quotes, for example: "C:\MYGAMRYDATA\CV.DTA" and "GAMRY5.INI".

The term Interface 5000 is generally written in place of the more correct but awkward term Interface 5000 Potentiostat/Galvanostat/ZRA.

Chapter 3: Installation

This chapter of the Gamry Instruments Inc. Interface 5000 Operator's Manual covers normal installation of the Interface 5000. We assume the Interface 5000 is installed as part of a Gamry Framework-based electrochemical measurement system containing a Microsoft Windows®-compatible computer.

Figure 3-1
Front View of an Interface 5000

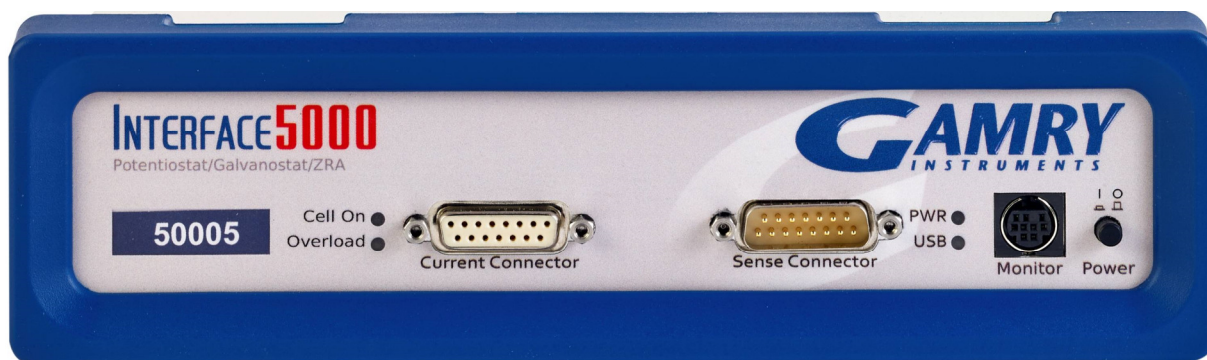

Initial Visual Inspection

After you remove your Interface 5000 from its shipping carton, check it for any signs of shipping damage. If you observe any damage, please notify Gamry Instruments, Inc. and the shipping carrier immediately. Save the shipping container for possible inspection by the carrier.



Warning: The “reinforced insulation” that keeps the operator from accessing the “hazardous live” voltages in the Interface 5000 can be rendered ineffective if the Interface 5000 is damaged in shipment. Do not operate damaged apparatus until a qualified service technician has verified its safety. Tag a damaged Interface 5000 to indicate that it could be a safety hazard.

If the Interface 5000 is taken from a cold location (for example outdoors in winter conditions) to a warm, humid location, water vapor may condense on the cold surfaces inside the Interface 5000, possibly creating a hazardous condition. Before connecting power to a “cold” Interface 5000, allow at least one hour for the Interface 5000 to warm at room temperature.

Physical Location

Normally users place their Interface 5000 on a flat workbench surface. Keep easy access to the rear of the instrument because some cable connections are made from the rear. The Interface 5000 is generally operated in a flat position (see Figure 3-1). Operation in other orientations is possible as long as you ensure that air movement through the chassis is not restricted.



Caution: Do not block the airflow into or out of the Interface 5000 chassis. The Interface 5000 will enter a power-down state if it becomes overheated. If this occurs during data-acquisition, you may lose experimental data.

If you place your Interface 5000 within an enclosed space, make sure that the internal temperature within that space does not exceed 45°C, the maximum ambient temperature for the Interface 5000. Be particularly careful if a computer or other heat-dissipating equipment is mounted in the same enclosure as the Interface 5000.

The Interface 5000 is not designed for outdoor use.

Computer Requirements

Before you connect an Interface 5000 to a computer, you must make sure that your computer meets these requirements:

- A computer based on one of the x86 family of Intel™ microprocessors or a 100%-compatible processor from another vendor.
- Microsoft Windows® 10 or newer is required with Gamry Framework™ software version 7.9.1 and above. Only the 64-bit version of these operating systems is supported.
- A USB port that supports Full Speed (12 Mbits/second) or High Speed (480 Mbits/second) USB transfers. It must be compatible with Revision 1.1 or Revision 2.0 of the USB specification.

Quick Start Guide for System Installation

Your shipment should have included a document entitled **Quick-Start Installation Guide - USB Potentiostat**. It contains the latest instructions for installing Gamry hardware and software onto a computer system. If this document is missing, you can find it on www.gamry.com. The Quick-start Guide found at www.gamry.com contains the latest information concerning system installation, so the information provided below is always subject to change.

Software Installation

The Interface 5000 is compatible with the Windows® Plug & Play configuration system. Like most Plug & Play hardware, it is best if you install the software for the Interface 5000 **before** you install the potentiostat hardware.

The latest Gamry software is not provided on a DVD anymore but is now available for download as *.exe or *.iso file on Gamry Instruments' Client Portal after creating an account and registering your instrument:

<https://www.gamry.com/client-portal/my-account/>

An internet download of Gamry Instruments' software will download a self-extracting file. Running this file will extract the software and begin the installation.

Reboot Your Computer after Software Installation

Reboot your computer when the Gamry Setup program is done. The Setup program normally offers you the opportunity to do so. USB device drivers are usually loaded when Windows® boots up. Following Setup, you may not be able to use your Interface 5000 until the drivers are loaded.



Device driver installation may not occur until a while after the Windows Desktop appears. On a slow computer, or a busy computer with lots of active applications, the delay before driver installation can be a minute or more.

Power Cord and Power Connection

The Interface 5000 does not plug directly into the AC mains supply. Instead, the mains are connected to an external power supply, which supplies a regulated 48 V DC output. This regulated DC is then connected to the DC power input jack on the rear of the Interface 5000.

The external power supply provided with the Interface 5000 is rated for operation from 100 to 240 V AC, at frequencies from 47 to 63 Hz. It should therefore be useable worldwide.

The Interface 5000 external supply is normally supplied with a line cord suitable for use in the United States. In other countries, you may have to replace the line cord with one suitable for your type of mains (electrical outlet). You must always use a line cord with a CEE 22 Standard V (IEC 320 C13) female connector on the end of the cable leading to the unit. This is the same connector used on the US standard line cord supplied with your Interface 5000.

The DC output cord from the external power supply plugs into the **Power In** jack on the rear panel of the Interface 5000 (see Figure 3-2).



The output cable from the external power supply ends in a 3-pin miniature power DIN male connector. This DIN connector cannot be plugged into either of the other DIN connectors on the Interface 5000. Improper connection is therefore unlikely.

Figure 3-2
Rear Panel of the Interface 5000

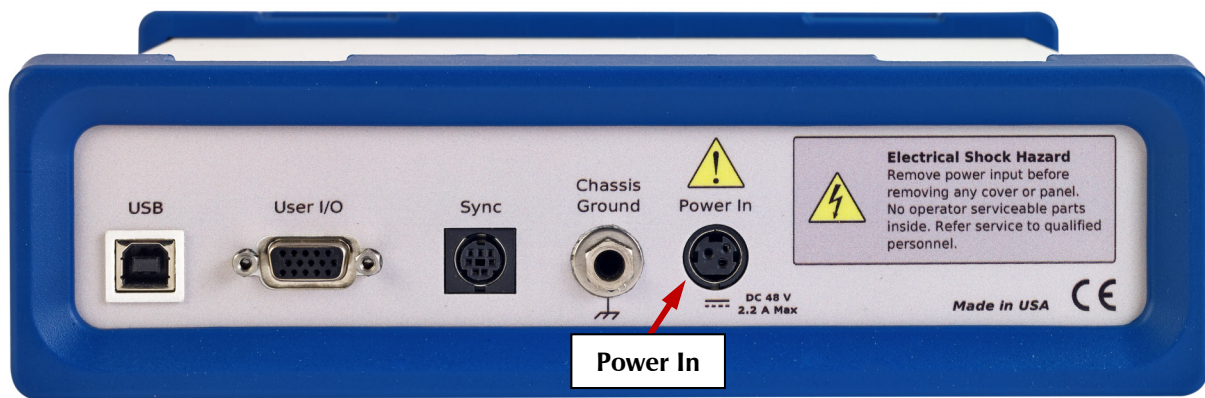

Power-up Test

Before you make any other connections to your Interface 5000, check that the Interface 5000 is at least nominally functional.

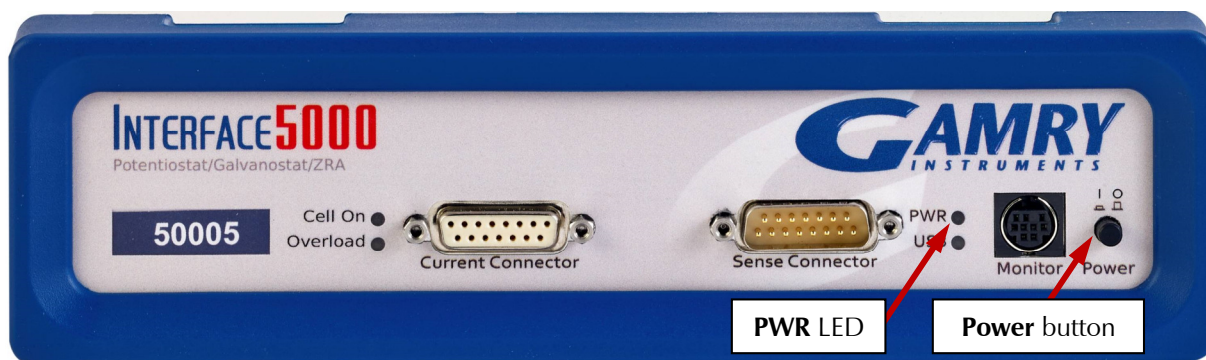

After connecting DC power to the Interface 5000, push in the **Power** button on the front panel of the Interface 5000).

Watch the **PWR** LED as the Interface 5000 powers up. It flashes slowly four or five times (depending on the amount of software loading), then glows a steady blue. This process could take as long as 15 seconds. The Interface 5000 fan runs at low speed after the **PWR** light stops flashing. If you do not see four or five blinks and then a steady blue color, see Appendix D for a table of blink codes.

The status of the other LED indicators is not important at this time.



Caution: If the **PWR** LED goes on, then turns off and stays off, the Interface 5000 is not working properly! If this power-up test fails, contact Gamry Instruments or your local Gamry Instruments representative as soon as possible.

If the **PWR** LED continues to flash after 30 seconds, the instrument could be malfunctioning or the instrument could be over-heated. Make sure the Framework Instrument Manager is not causing the flashing (see below). Check that the air-flow through the chassis is not restricted. If airflow looks okay and the **PWR** LED continues to flash, contact Gamry Instruments (techsupport@gamry.com) or your local Gamry Instruments representative as soon as possible.

USB Cables

The Interface 5000 connects to the computer using a filtered High Speed USB A/B cable. A suitable cable was shipped with your Interface 5000. The replacement cable is Gamry Part Number 985-00131.

An A/B USB cable has different connectors on each end. The end with a wider, rectangular-shaped connector plugs into a USB port on your computer (or a similar port on a USB hub). The end with a nearly-square connector plugs into the **USB** port on the Interface 5000 (see below).

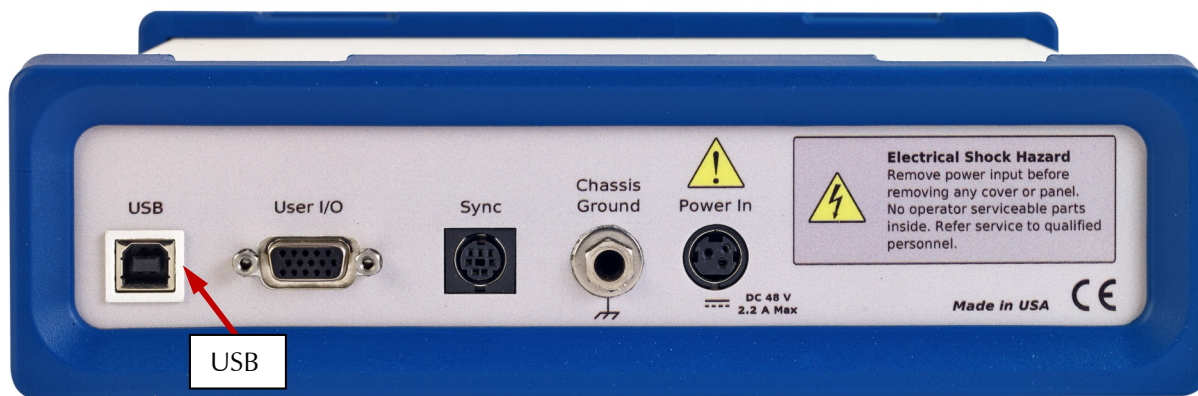

The **USB** connection can be “hot-plugged”. This means both the computer and the Interface 5000 can be powered up before the USB cable is plugged in. Unlike many other instrument-to-system connections, you need not power down the system before plugging in the USB.

You can also safely remove the USB cable without powering down the Interface 5000 and your computer. Be aware, however, that this may have undesirable consequences if the system is currently taking data or performing an electrochemical experiment.

Multiple Potentiostat Systems

Gamry’s current Framework software (Revision 7) allows a computer to operate up to 16 Gamry Instruments potentiostats simultaneously. The 16 potentiostats can include Interface 5000s and Gamry Reference-family instruments.

A system with multiple Interface 5000s just needs them all plugged into the computer via a High Speed USB hub.



We do not recommend using bus-powered hubs to expand your USB network: an externally powered USB hub is required. Suitable hubs are available at most computer retailers.

Gamry’s Interface Power Hub is an especially convenient tool for organizing a system containing up to eight Interface family instruments. It includes a 10-port USB hub and 48 V power-distribution in a rack designed to hold the instruments. Unlike most instruments with multiple potentiostats in one box, you can easily remove the Interface instruments in an Interface Power Hub for temporary use elsewhere in your lab.

Contact our main office or your local Gamry Instruments representative if you need assistance configuring a system containing an Interface 5000 and different Gamry potentiostats.

Heat can be a problem in a multiple-potentiostat system. This subject is discussed in detail in Appendix F of this manual.

Cell Cable Installation

The Cell Cables connect to two 15-pin D-type connectors located on the front of the Interface 5000 (see Figure 3-1). There are two cables: one that carries the cell current, called the Current Carrying Cable which mates with the **Current Connector**, and one that senses the cell voltage, called the Sense Cable, which mates with the **Sense Connector**.

The D-connector ends of the cables are connected to the appropriate ports on the front of the Interface 5000. Always use the knurled screws on this cable to hold the cables in place.

A wide variety of lengths for cell cables are available for the Interface 5000. The Interface 5000 can automatically detect which Gamry Instruments cables are connected and the Gamry Framework software can then adjust the system performance for the characteristics of those cables.



The current-carrying cable contains fuses that protect the instrument against excessive cell current. See Chapter 4 for more information concerning these fuses.

Front-panel USB LED

The front-panel **USB** LED provides a simple test of two aspects of normal Interface 5000 USB operation. It has four normal states:

Unlit	The USB cable is disconnected, or the USB connection is disabled by the host computer.
Continuous green	A valid cable connection has been made and the Interface 5000 USB processor is receiving power from the USB cable.
Flashing yellow	Valid USB messages are being transferred between the computer and the Interface 5000.
Continuous red	A software download is in progress, or a USB communications error.

The flashing state only occurs when Gamry Instruments application software is running.

Running the Framework

Many newer electrochemical applications do not run as an application within Gamry's Framework software. This is true of all applications that use Gamry's Toolkit for instrument control. Gamry's Framework software is the main application software for performing routine analysis associated for electrochemical measurements. There are other software programs such as Resonator that are stand-alone programs. Programs that you develop using our toolkits will fall into the stand-alone software category.

The Framework Instrument Manager is useful in organizing the potentiostats in the system. The Framework also has a Calibration program that is used to calibrate instruments connected to the system.

Framework Device Status Bar

By default, the Gamry Framework shows a Device Status Bar under its main menu (see Figure 3-3). If you do not see the Device Status Bar when you run the Gamry Framework, it has been disabled in the Framework **Options** menu.

Potentiostat Devices (instruments) that are connected to the computer appear on this bar. The round indicator associated with each device shows its status:

Green	The device is available to run experiments
Red	The device is currently running an experiment
White	The device is connected to the system but is not usable. This is generally the result of a mismatch between the Framework software and the device's firmware. You can use the Gamry Instrument Manager to fix the mismatch.

The screen capture below shows a Framework screen with three USB instruments connected.

Figure 3-3
Framework with Three Potentiostats and One Running Test

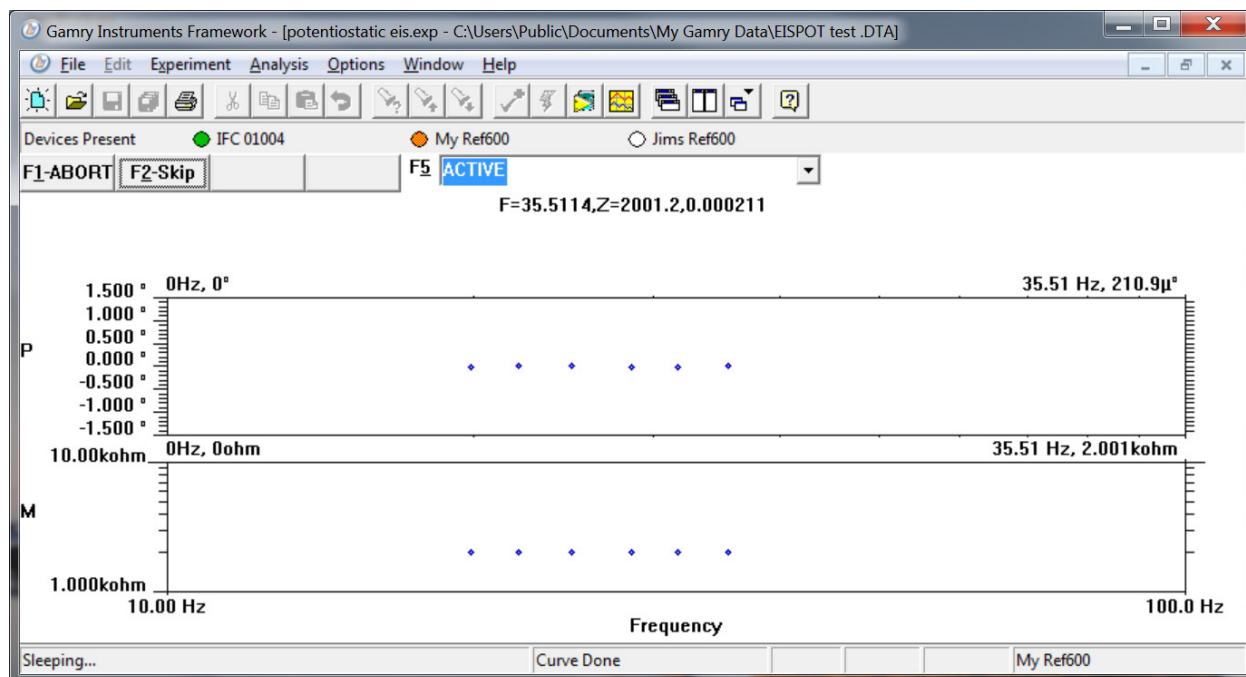

The Interface 1000 (IFC 01004) in this system is shown with a green indicator because it is installed and ready to run. The Reference 600 labeled My Ref600 has a red indicator because it is recording the EIS spectrum shown on the screen. The Reference 600 labeled Jims Ref600 has a white indicator, showing it is plugged in but cannot be used. This is an indication of a version mismatch between firmware and instrument.

Types of Interface 5000 instruments

The Interface 5000 comes in two models, the Interface 5000P and the Interface 5000E. You can purchase an upgrade from a 5000P to a 5000E. To use the upgraded Interface 5000E, enter a new authorization code using Instrument Manager.

You can use Gamry's Instrument Manager Application to make changes to the configuration of your Interface 5000 system. Find the application through the Options menu in the Gamry Framework.

The Instrument Manager is used to:

- Rename potentiostats
- Delete potentiostats that are not currently connected to the computer
- Select the order in which potentiostats appear in menus
- Upgrade the potentiostat model from Interface 5000P to Interface 5000E
- Update firmware within potentiostats

Authorization Codes and Label

If you upgrade your Interface 5000 potentiostat or you need to make a correction to your authorization codes, use the Framework Instrument Manager.

If you change the USB port used to connect the Interface 5000 to your computer, the Windows Device manager interprets an Interface 5000 on a new USB port as a new Interface 5000.

Firmware Update

Your Interface 5000 was shipped with the latest version of all its firmware. From time to time, Gamry makes changes to the instrument's firmware code and a firmware update is required to make use of the new or improved code.

There are three separate firmware images that can be updated in the field on your Interface 5000. The first is the Instrument Firmware. This is the program that handles most of the functions of the Interface 5000. The second is the Communications Firmware. This program handles the USB communications between your Interface 5000 and the host computer. The third is the PLD firmware, which you should only change if a Gamry Instruments representative instructs you to.

Initiate the Firmware Update process using the Framework **Options, Instrument Manager...** command.

Appropriate update files can be obtained from the Gamry Instruments website at www.gamry.com. If you encounter a problem updating the firmware in your Interface 5000, please contact Gamry Instruments for assistance.



Caution: Interrupting a firmware update can cause a catastrophic failure of your system. **Do not turn off the Interface 5000, do not unplug the USB cable, and do not stop the operation of the host computer when the USB LED is a continuous red color.**

Do not interrupt a firmware update that is in progress. An incomplete update can render an Interface 5000 inoperable until it is returned to Gamry for reprogramming.

Should the firmware update be interrupted, contact Gamry before starting the return process.

The Interface 5000 Customization Label

Introduction to the Interface 5000 Customization Label

Modern electrochemical testing often involves replicate tests designed to measure or minimize the effect of irreproducibility in the measurements. Battery tests are a good example, where multiple tests of a particular battery composition and/or construction are generally required. Multiple potentiostat systems are often used to speed up the testing process. If the multiple potentiostats can be randomly located in the lab, potentiostat identification can be a problem. You may need to know "Is the potentiostat to the left of my host computer the second or third potentiostat in the system?"

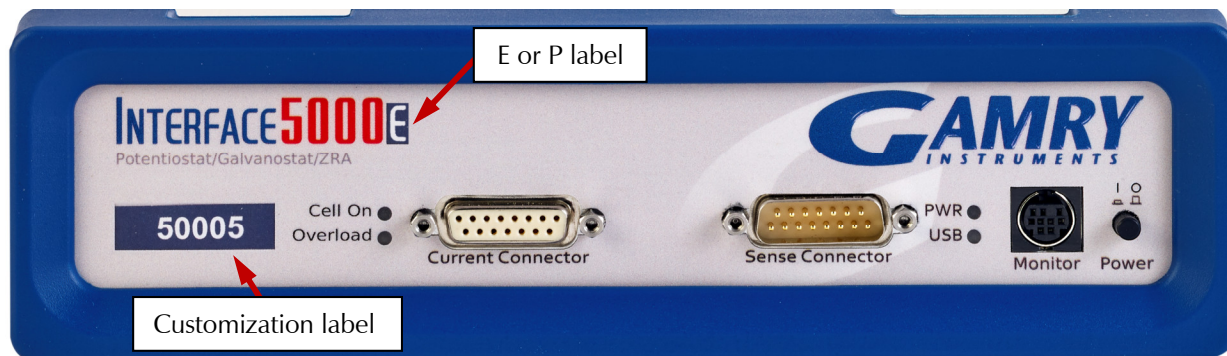

The Interface 5000 includes a customization label that makes each unit visually unique. This allows you to know exactly which potentiostat will be used for each test. You can place labels easily in the instrument's

Customization Label area. In a system containing eight potentiostats, the potentiostats might be labeled **Pstat 1, Pstat 2, Pstat 3, ... Pstat 8**.

Insert simple paper labels in an area behind the clear plastic outer layer of the front panel. The paper is behind the plastic, so it is not affected by the lab environment. Best of all, you can edit or print the labels so personal labels, like **Bob's Stat**, are also possible.

There are two versions of the Interface 5000: the Interface 5000P and Interface 5000E. If you upgrade from an Interface 5000P to an Interface 5000E, you may also remove the P label from the top, and replace it with an E.

Label Sheet Provided with Each Interface 5000

Every Interface 5000 is shipped with a preprinted label sheet containing:

- Instructions on how to change the label
- The first eight letters of the Greek alphabet (alpha through theta)
- The eight planets in the solar system (Mercury through Neptune)
- Several blank white labels
- Pstat 1 through Pstat 16 on a blue background
- Pstat 1 through Pstat 16 on a red background

You can cut any of these labels from the sheet and insert it as the Interface 5000 Customization Label. The white labels are provided to allow you to hand-write a label.

How to Change the Label on an Interface Family Potentiostat

These instructions apply to all current members of the Gamry Instruments Interface family. Don't be confused because some of the pictures were taken using an Interface 1000.

- 1) If you are making a custom-printed label, edit the Excel® file and print a label sheet as described above. If you are using the Gamry-supplied label sheet, identify the location on the sheet where the new label is found.
- 2) If you are writing by hand on a blank label, do it now.
- 3) Use scissors to cut out the new label. Cut white labels on the black lines.
- 4) Power down the Interface 5000 that is receiving the new label.
- 5) Remove the instrument's rubber front bezel (the rubber frame around the front panel). No tools are required, see Figure 3-4.

Figure 3-4
Removing the Front Bezel

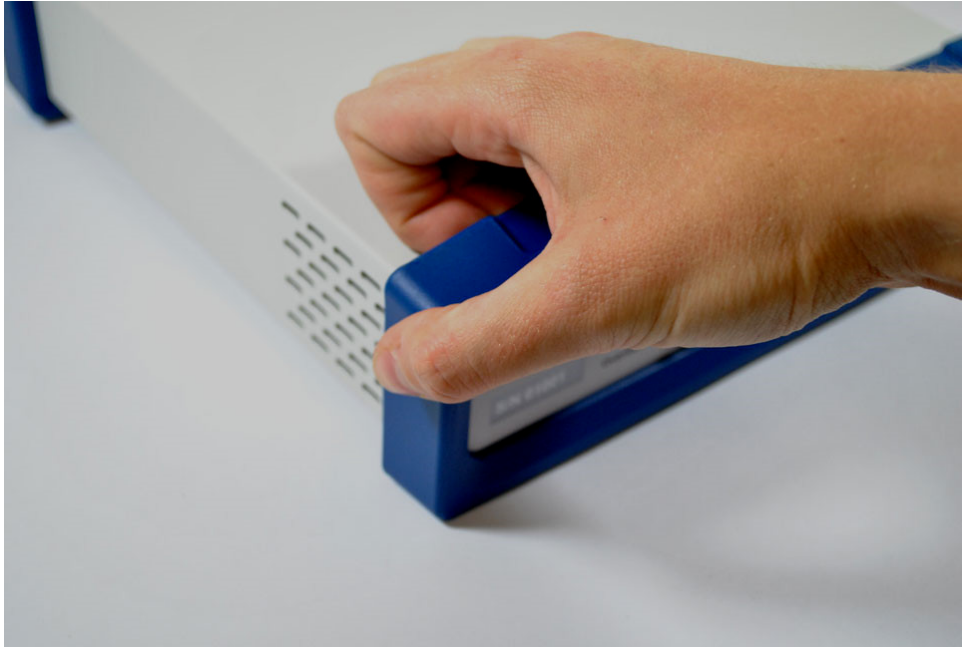

- 6) Grip the bezel as shown in the Figure and pull the bezel away from the front panel. Some force is required. Don't worry about ripping the bezel; it is quite rugged. There is a 5 mm ear on either side of the instrument that keeps the bezel in place.
- 7) Your Interface 5000 family instrument should now look like Figure 3-6 (the front bezel is removed). Notice the blue tab on the left side on the instrument. This is part of the old label; it is blue on the instrument in the photo.
- 8) Pull gently on the paper tab on the left side of the front panel to remove the existing label. You need to pull out about 5 cm of label.
- 9) Insert the new label in the same spot as the old label. The text should face the front of the instrument. A small tab of paper will extend beyond the instrument's front panel.
- 10) Examine the new label's position in the Interface 5000 Front Panel. Adjust the label if needed.
- 11) Replace the rubber bezel. Make sure that the foot side of the bezel is toward the bottom of the instrument.
- 12) Rename the Interface 5000 in the Gamry Framework software to match the new label. Use the Framework **Options, Instrument...** dialog box. In the resulting dialog box, select the device you want to rename and then select the **Device Settings...** button.

Installation

Figure 3-5
Instrument with Bezel Removed - Label Tab is Visible



Chapter 4: Calibration

Introduction

There are two different types of calibration for the Interface 5000 potentiostat:

- Instrument DC calibration
- Cable calibration

Calibration can be initiated through Framework™ software, or directly through Gamry Instrument Manager (GIM). Gamry recommends calibrating the instrument at least once per year, or when the quality of your data is in question. To initiate calibration, take the following steps:

Click the **Calibrate in Framework** button, located in the Calibration area of GIM. This launches the appropriate calibration routine for the instrument selected in GIM. Follow the instructions given in Framework. See the relevant Calibration Quick Start Guide for additional details.

If there are any failures during calibration, click the **Email Results to Gamry Support** button in GIM. One of our support engineers will review the results and provide appropriate advice.

You run the Instrument Manager by selecting **Options/Instrument Manager...** on the Framework Menu.

Calibrate each potentiostat installed in your system. A calibration utility is provided with the Gamry Framework.

The calibration for the Interface 5000 is divided into two sections: Instrument DC Calibration and cable calibration. Gain access to these calibration procedures via the **Utility** selection on the Framework's **Experiment** drop-down menu.

DC Calibration

Calibrate each potentiostat installed in your system. A calibration utility is provided with the Gamry Framework. Get access to the calibration procedure via the **Utility** selection on the Framework's **Experiment** drop-down menu.

This procedure uses an external resistive dummy cell called the Interface 5000 Calibration Cell.



Caution: The standard Interface 5000 calibration calls for an external resistive dummy cell. Your Interface 5000 was shipped with an Interface 5000 Calibration Cell, which includes a 200 Ω , 0.05% accurate resistor. After calibration, please place this dummy cell in a safe place where you can find it if your unit requires recalibration.

If you do need to recalibrate and you cannot find your calibration cell, you can perform DC Calibration using a different 200 Ω resistor. Its power-rating is unimportant. Some performance checks in the calibration process may fail if the resistor's inaccuracy exceeds 0.2% (4 Ω).

Figure 4-1
200 Ω Calibration Cell

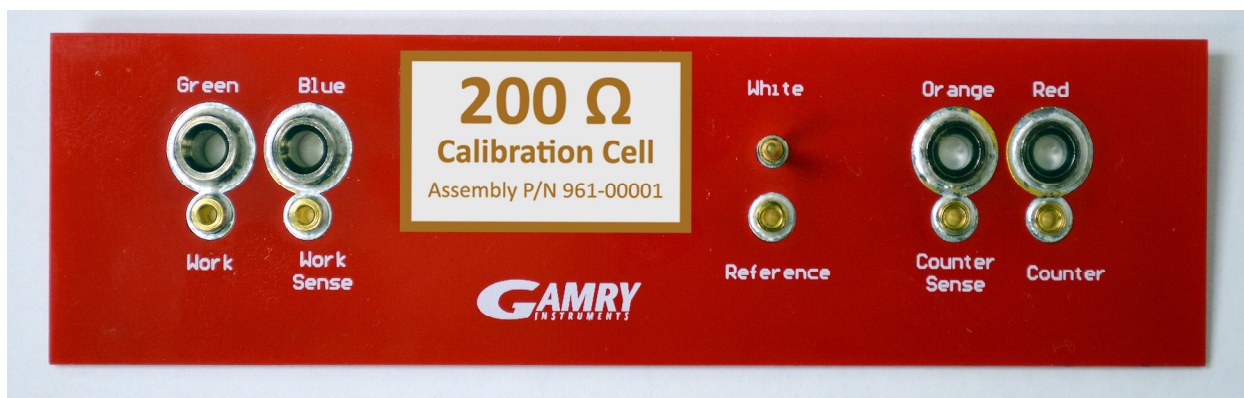

Potentiostat calibration is only required infrequently. Recalibrate your Interface 5000 under the following circumstances:

- It is at least one year since your last calibration.
- Your potentiostat has been serviced.
- You notice breaks or discontinuities in the data curves recorded with your system.
- The system is being run in an environment that is very different from the previous operating environment. For example, if the Interface 5000 was calibrated at 15°C and you are now operating it at 30°C, you should recalibrate.

Figure 4-2
Interface 5000 Calibration Cell with Leads Attached for Calibration

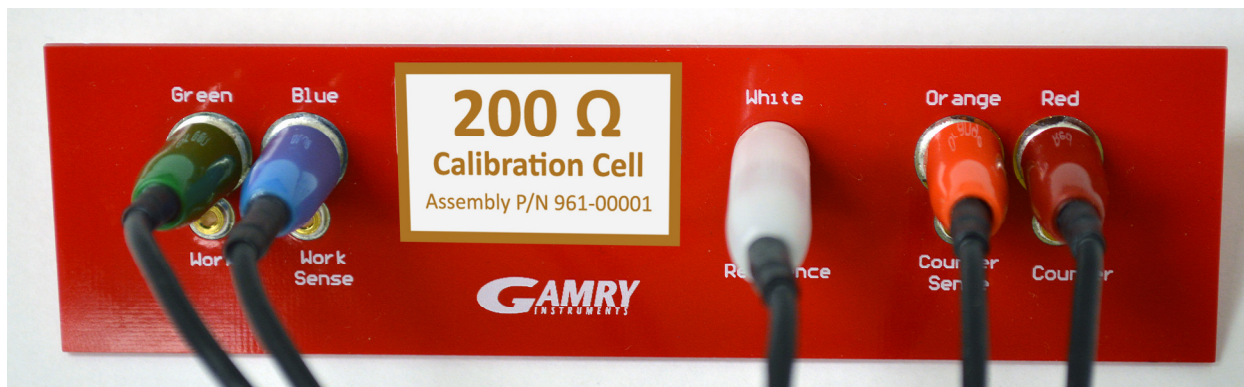

Cable Calibration

This procedure uses an external resistive Calibration Cell, the same one as for DC Calibration:

Cable calibration is only required infrequently, if you feel that the cable capacitance is a problem for your experiments, especially if you see excessive phase glitches on high-impedance samples.

Procedure to calibrate the cable

- 1) Connect the **Chassis Ground** on the back of your potentiostat to a known, good earth ground.



- 2) Connect the cell cable to the correct color-coded receptacles on the 200 Ω Calibration Cell.

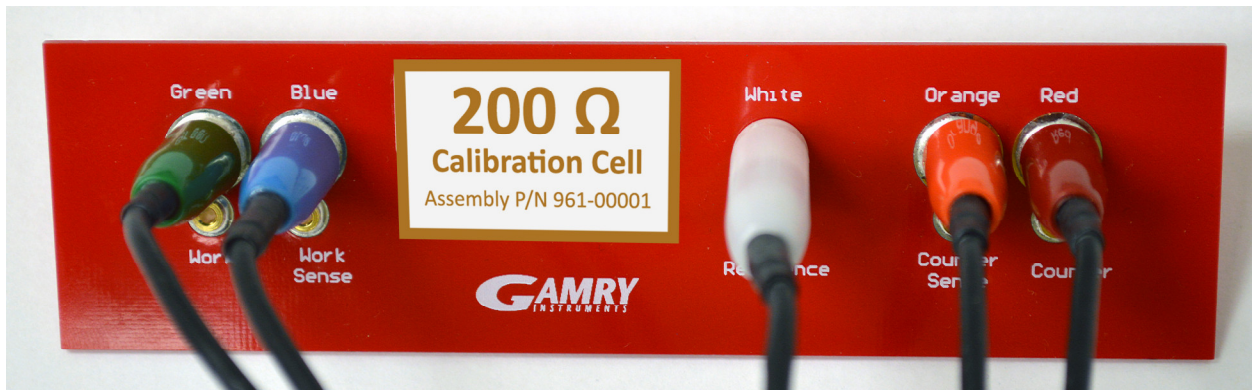

- 3) Place the Calibration Cell inside the Calibration Shield, close the lid, and connect the black floating-ground lead of your cell cable to the Shield's grounding post:

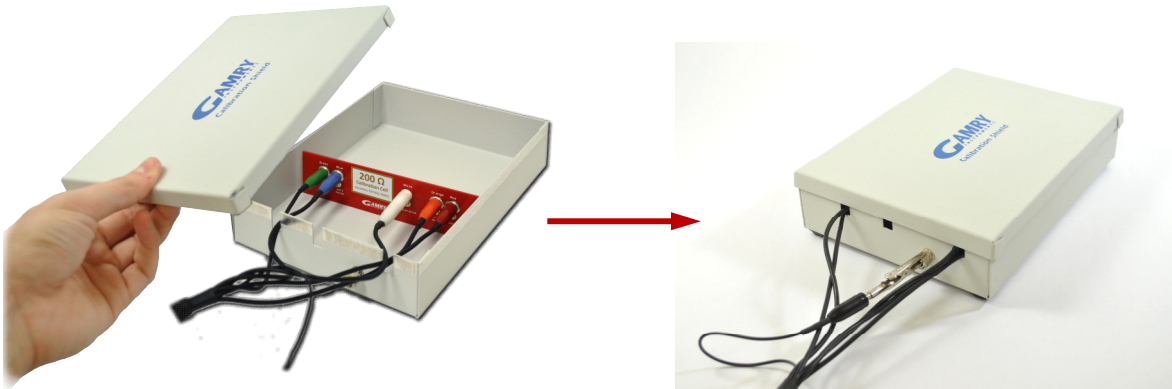

Calibration

- 4) Open Gamry Framework™ software. Select **Experiment > Named Script...**

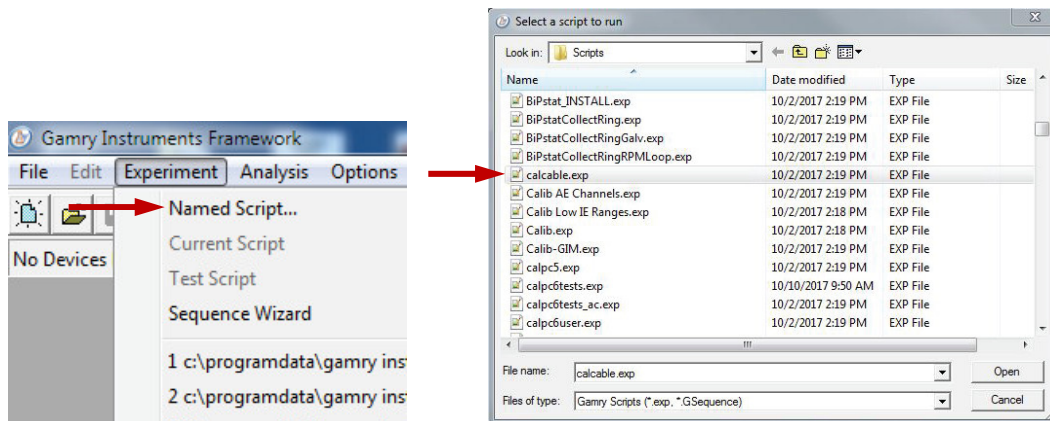

The **Select a script to run** window appears. From the list of scripts, choose `calcable.exp`, then click the **Open** button.

- 5) The **Cable Capacitance Calibration** window appears.

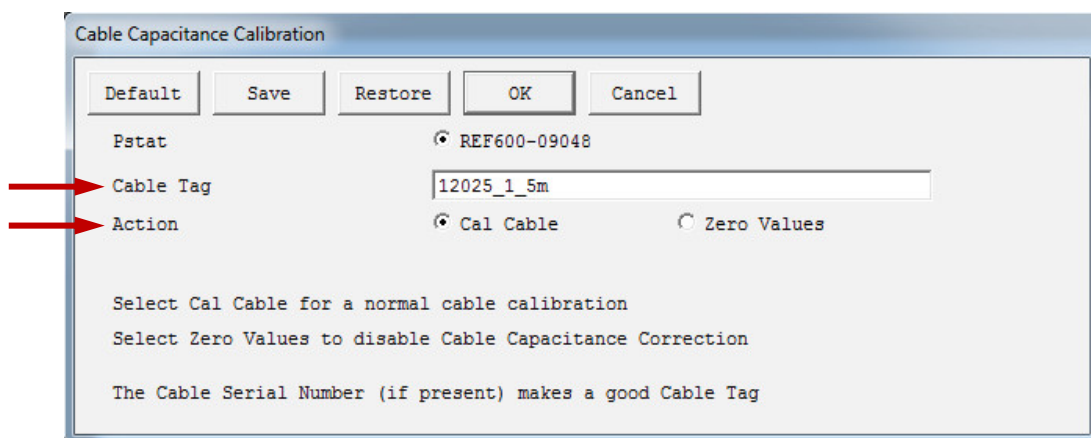

In the **Cable Tag** field, enter a unique name for the cable you are calibrating.

Choose the desired **Action** radio button:

- To calibrate the cable, choose **Cal Cable**.
- To reset the vales to zero (if, say, the calibration doesn't work), choose **Zero Values**.

Click the **OK** button.

- 6) The **Performance Tips** window appears.

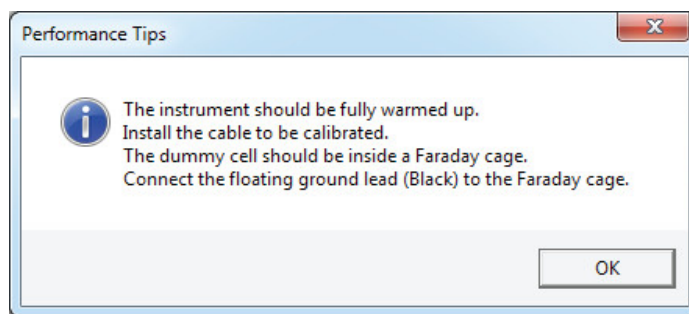

Make sure that all of the tips are true, then click the **OK** button.

Calibration

- 7) The **Cell Required** window appears.

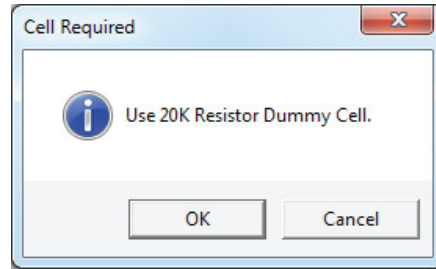

Make sure that the correct Calibration Cell is attached, then click the **OK** button.

The calibration runs.

- 8) The **Done** window appears.

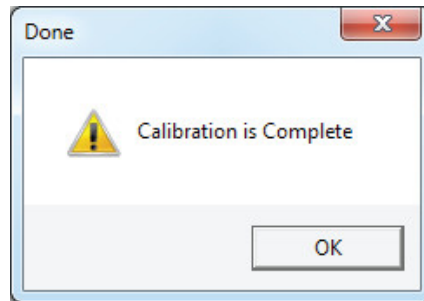

Click the **OK** button to acknowledge completion.

Chapter 5: Cell Connections

Cell Cable Overview

The Cell Connectors are two 15-pin D-connectors on the front of the Interface 5000.

Figure 5-1
Front Panel of the Interface 5000

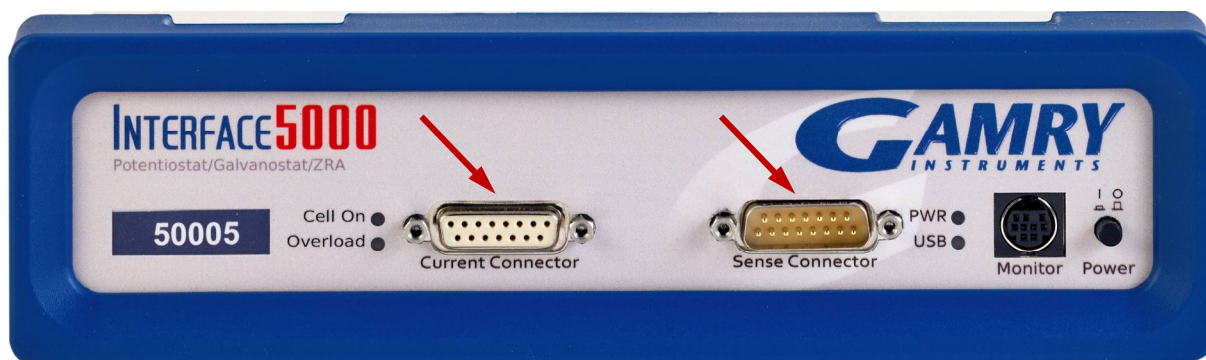

The left (female) connector is labeled **Current Connector**. It carries the cell current between the Counter electrode wire and the Working electrode wire.

The right (male) connector is labeled **Sense Connector**. It contains only high-impedance inputs used to sense potentials in the cell.

Gamry's Interface 5000 standard cell cables always come in pairs. Each cable has a D-connector on one end, and a number of leads to connect to electrodes in an electrochemical cell. The D-connector end of the cable is connected to the appropriate D-Connector on the front of the Interface 5000. The male and female cables cannot be interchanged.

Every Interface 5000 is shipped with a pair of standard shielded cell cables. The Gamry part number for a set of these two cables is 985-00157. They are both 60 cm complex cables, with D-connectors on one end, and color-coded banana plugs and pin sockets on the other end.

In some cases, your system may also include special-purpose cell cables. The special-purpose cell cables include instructions describing their use.

Always screw both cell cables into place because cables can fall off the unit if not properly attached. This can be disastrous if detachment occurs during an experiment.

Ancillary Apparatus

Do not use the Interface 5000 with ancillary apparatus connected directly to any of the cell leads. Examples of ancillary apparatus include DVMs, oscilloscopes, chart-recorders, and data-loggers. Ammeters and voltmeters, regardless of their specifications, almost always create problems when connected to the Interface 5000 cell leads. Instead, connect ancillary measurement devices to the **Monitor** connector on the front panel of the Interface 5000.

Fuses in the Cell Cable

The Interface 5000 can be damaged if currents much larger than 6 A flow into or out of the Counter electrode or Working electrode leads. Improper connection to a battery, fuel cell, or supercapacitor can cause this type of damaging current to flow. All Interface 5000 Counter/Working cell cables contain fuses in the cable that protect the instrument if it is misconnected. A later section of this manual discusses the fuses and their replacement.

Normal Cell Connections

This section assumes that you are using standard, shielded cell cables. This information does not depend on the length of such cables.

The cell end of the standard cell cables terminates in a number of banana plugs and pin jacks. Each termination comes with a removable alligator clip. Table 5-1 identifies the terminals of the cables.

Table 5-1
Cell Cable Terminations: Potentiostat and Galvanostat Modes

Color	Type	Name	Normal Connection
Blue	Banana plug	Working Sense	Connect to working electrode
Green	Banana plug	Working Electrode	Connect to working electrode
White	Pin jack	Reference	Connect to reference electrode
Red	Banana plug	Counter Electrode	Connect to counter electrode
Orange	Banana plug	Counter Sense	Used in ZRA mode or Save Both ½ Cell Modes; connect to counter electrode
Black	Pin jack	Floating Ground	Leave open or connect to a Faraday shield

Connect both the blue and green cell leads to the working electrode. The working electrode is the electrode being tested. The blue pin jack connection senses the voltage of the working electrode. The green working electrode connection carries the cell current. The working electrode may be as much as 520 mV above the circuitry ground (**Floating Ground**).

Connect the white pin jack to the cell's reference electrode, such as an SCE or Ag/AgCl reference electrode. The measured cell potential is the potential difference between the blue and white cell connectors.

You may need to connect the Interface 5000 to a two-terminal device such as a packaged battery. In this case, connect both the white cell and red cell leads to one side of the device, and the blue and green cell leads to the other side. Try to connect the white and blue leads as close to the device as possible.

Connect the red banana plug to the counter or auxiliary electrode. In a three-terminal cell, the counter electrode is usually a large inert metal or graphite electrode. The counter-electrode terminal is the output of the Interface 5000's power amplifier.

The orange cell lead is used to sense the counter-electrode potential (see following section). Automatic switching to ZRA mode is possible if this lead is connected to the counter electrode. If you are not using ZRA or Save Both ½ Cell modes, leave this lead open or connect it to the floating ground.

The black pin jack is connected to the Interface 5000 to **Floating Ground**. This is the circuitry ground for the analog circuits in the Interface 5000. In most cases, leave this terminal disconnected at the cell end, but take care that its metal contact does not touch any of the other cell connections.

If your cell is a typical glass laboratory cell, all of the electrodes are isolated from earth ground. In this case, you may be able to reduce noise in your data by connecting the Interface 5000's Floating Ground to an earth ground.



Warning: Make sure that your earth-ground connection is made to a legitimate source of earth ground. Consult a qualified electrician if you are uncertain how to obtain an earth ground. Connecting the Interface 5000 to an incorrect and unsafe voltage can create a safety hazard (see Chapter 1 for details).



Caution: If any electrode in your cell is at earth ground, **never** connect the Interface 5000 chassis to earth ground. Autoclaves, stress apparatus, and field measurements may involve earth-grounded electrodes. A binding post on the rear panel of the Interface 5000 is provided for this purpose. A water pipe can be a suitable earth ground.

If you are measuring very small currents, you may find that a metal enclosure completely surrounding your cell (a “Faraday shield”) significantly lowers measured current noise. You should normally connect this Faraday shield to both earth ground and floating ground. The floating ground on the black cell lead is a convenient source of ground.

If any electrode in your cell is connected to earth ground, **only** connect your Faraday shield to the black cell lead (**Floating Ground**).

You can remove the alligator clip on any cell connection to gain access to the underlying banana plug or pin jack. Gamry Instruments also can provide additional standard or special cell cables.

Three-Electrode Battery Connections

Many battery tests are done in using a three-electrode cell. In some cases, the tests are traditional half-cell tests in which the electrochemical behavior of only a battery anode or cathode are of interest. In these cases, the behavior of the counter electrode is unimportant, and the Normal-Cell connections described above are used with the electrode of interest connected to the Interface 5000’s Working electrode terminal. In the Electrochemical Energy software, these tests are run in half-cell mode. Note that Gamry’s three-electrode Lithium Battery Cell is a convenient tool for this type of testing.

In other three-electrode cell cases, the cell under test is a conventional battery with an embedded reference electrode. The tester is usually interested in the electrochemical behavior of both the anode and cathode. Examples of cells used in this way include specialized Swagelok®-like cells and cells with a reference electrode inserted in a coin cell or a spirally wound cell (such as an 18650). In Gamry’s Electrochemical Energy software, you run these tests in Stack mode.

Save Both Half Cells is a feature that allows you to monitor both half-cell voltages when an embedded reference electrode is used. Connect the working and working sense to one electrode, the reference lead to the reference electrode, and the counter and counter sense to the second electrode. If you do not select this feature, the potentiostat/galvanostat monitors the potential between the working sense and reference leads.

When you select **Save Both Half-Cells** in Gamry’s PWR800 software, the software calculates the negative electrode half-cell potential by subtracting the positive half-cell potential from the full-cell potential.

The cell cable connections used in **Save Both Half Cells** mode are shown in Table 5-2. The orange Counter Sense lead **must** be connected.

Table 5-2
Cell Cable Connections for Three-Electrode Battery Testing

Color	Type	Name	Normal Connection
Blue	Banana Plug	Working Sense	Connect to positive battery terminal
Green	Banana Plug	Working Electrode	Connect to positive battery terminal
White	Pin Jack	Reference	Connect to the reference electrode
Red	Banana Plug	Counter Electrode	Connect to negative battery terminal
Orange	Banana Plug	Counter Sense	Connect to negative battery terminal
Black	Pin Jack	Floating Ground	Leave open or connect to a Faraday shield

The voltage of the full cell is measured between the counter sense and the working sense leads.

The white pin jack on the cell cable is normally connected to a reference electrode. The potential between this lead and the Working Sense lead is reported as the positive half-cell potential.

ZRA Mode Cell Connections

The Interface 5000 can function as a precision Zero Resistance Ammeter (ZRA). In this mode it maintains two metal samples at the same potential and measures the current flow between the samples. It can also measure the potential of the samples versus a reference electrode. The cell cable connections for ZRA mode are shown in Table 5-3. The connections are very similar to those for the potentiostat and galvanostat modes.

In ZRA mode a second working electrode is substituted for the counter electrode, and the Orange Counter Sense lead *must* be connected.

Table 5-3
Cell Cable Connections for ZRA Mode

Color	Type	Name	Normal Connection
Blue	Banana Plug	Working Sense	Connect to metal sample #1
Green	Banana Plug	Working Electrode	Connect to metal sample #1
White	Pin Jack	Reference	Connect to a reference electrode
Red	Banana Plug	Counter Electrode	Connect to metal sample #2
Orange	Banana Plug	Counter Sense	Connect to metal sample #2
Black	Pin Jack	Floating Ground	Leave open or connect to a Faraday shield

The counter sense and the working sense lead are each connected to different metal samples. In ZRA mode, the Interface 5000 is normally programmed to maintain zero volts between these leads. It therefore maintains the two metal samples at the same voltage.

The white pin jack on the cell cable is normally connected to a reference electrode. The potential between this lead and the working sense lead is reported as the cell potential.

If the instrument is connected in stack mode and the reference input is not used, connect the reference input to the floating ground wire.

If you do not have a reference electrode in your cell, we recommend that you connect the white reference lead to the working electrode. In theory, the measured potential will be exactly zero when this is done. In practice, A/D noise and offset will create a small potential signal with a value very close to zero.

Membrane Cell Connections

The Interface 5000 can be used with membrane cells. In this type of cell, a membrane separates two electrolyte solutions. Two reference electrodes are used: one in each electrolyte. Each electrolyte also contains a counter electrode. The Interface 5000 controls the potential across the membrane. Table 5-4 shows the cell connections used with a membrane type cell.

Table 5-4
Cell Cable Connections for a Membrane Cell

Color	Type	Name	Normal Connection
Blue	Banana Plug	Working Sense	Connect to reference electrode #1
Green	Banana Plug	Working Electrode	Connect to counter electrode #1
White	Pin Jack	Reference	Connect to reference electrode #2
Red	Banana Plug	Counter Electrode	Connect to counter electrode #2
Orange	Banana Plug	Counter Sense	Leave open (only needed in ZRA mode)
Black	Pin Jack	Floating Ground	Leave open or connect to a Faraday shield



Reference electrode #1 and counter electrode #1 must be on one side of the membrane, and reference electrode #2 and counter electrode #2 must be on the other side.

Fuses in the Cell Cable

All standard Interface 5000 Counter/Working cell cables include fuses in the current-carrying leads. These fuses protect the instrument from the extremely large currents that can flow through an improperly connected electrochemical-energy generation or storage device (including batteries, fuel cells, and capacitors). For convenience, the term “battery” is used here to refer to all single-cell or stacked electrochemical devices that can distribute energy.

Grounding errors on a battery can be particularly dangerous, for they can result in the battery being shorted through the instrument.



Warning: The fuses in the Interface 5000 Counter/Working cell cable do not protect against a safety hazard. They are needed to prevent damage to the instrument if it is improperly connected.

Both the counter electrode lead and the working electrode lead have fuses, rated to carry 6.3 A.



Always turn off the Interface 5000 and disconnect both ends of the Counter/Working cable before checking or replacing the fuses in the cable.

Access to the fuses requires removal of two screws on opposite sides of the hood covering the D-connector end of the Counter/Working cable. A drawing of the D-connector end of a cable with the hood opened is given in Figure 5-2. The small rectangular fuses snap into fuse-holders labeled **Work** and **Cntr**. To remove the fuse, either grip it with small pliers and gently lift the fuse out of the fuse-holder, or pry the fuse out of the fuse-holder using a small screwdriver or knife blade.

After a fuse has been removed, check it using an ohmmeter, such as that found on modern digital voltmeters. Do not trust a visual inspection of the fuse. A blown (open) fuse always should have a resistance of greater than 100 Ω . The resistance of a good fuse is very small.



 Don't forget the jackscrews when you reassemble the hood.

Figure 5-2
Drawing of Fuse-holder in the D-Connector Hood

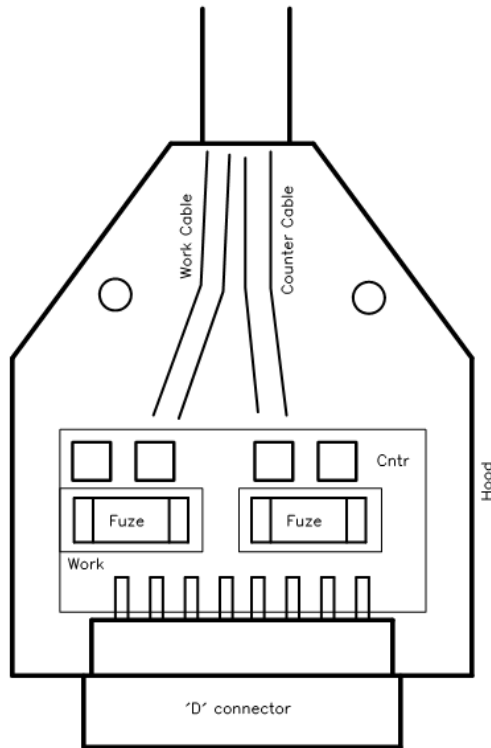

Four replacement fuses should accompany every Counter/Working cell cable shipped by Gamry Instruments. The Gamry Part Number for the small rectangular fuses is 630-00030. If you need to find replacement fuses locally, we currently only recommend Very Fast Acting, 6.3 A, Nano Fuses from the Littelfuse corporation (Littelfuse part number 045106.3MRL). Fuses with similar ratings from other manufacturers have not been tested, so we cannot recommend their use.

 **Caution:** Always replace the fuses in a Interface 5000 cable with the recommended fuse. Use of an improper fuse, especially a fuse with a higher current rating, can cause instrument failure if a battery cell is improperly connected. Use of a non-approved fuse voids Gamry's factory warranty.

Testing For Open Fuses

A Gamry Framework test checks for blown fuses without having you remove the fuses. A simple Potentiostatic test is run on the Calibration Cell on the Interface 5000 Calibration Cell. Run the test using the SET A VOLTAGE . EXP script in the Framework's **Utilities** package. Utility Package scripts do not require an Authorization Code, so every Framework installation can run this test.

Connect the cell leads to the Interface 5000 Calibration Cell. You do not need to place the Dummy Cell within a Faraday cage. Select the command Experiment, Utilities, Set a Voltage on the Framework's menu bar. You see a **Set a Voltage** dialog box similar to this:

Figure 5-3
Setup Dialog Box for the "Set a Voltage" Script

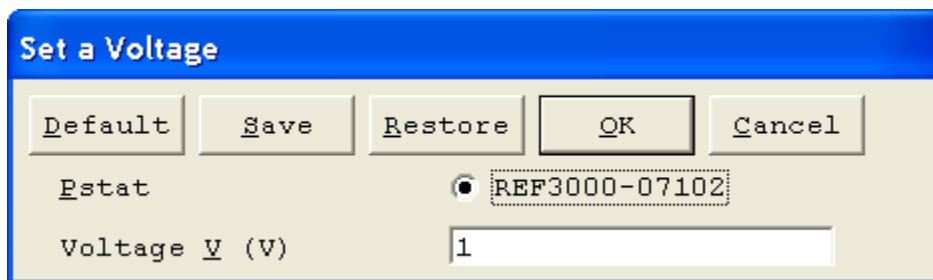

In the **Voltage** field, enter a **Voltage** of 1 V as shown above, then click the **OK** button. The Framework opens a runner window, and a graph of current versus time should appear:

Figure 5-4
Typical Runner Window with Good Fuses

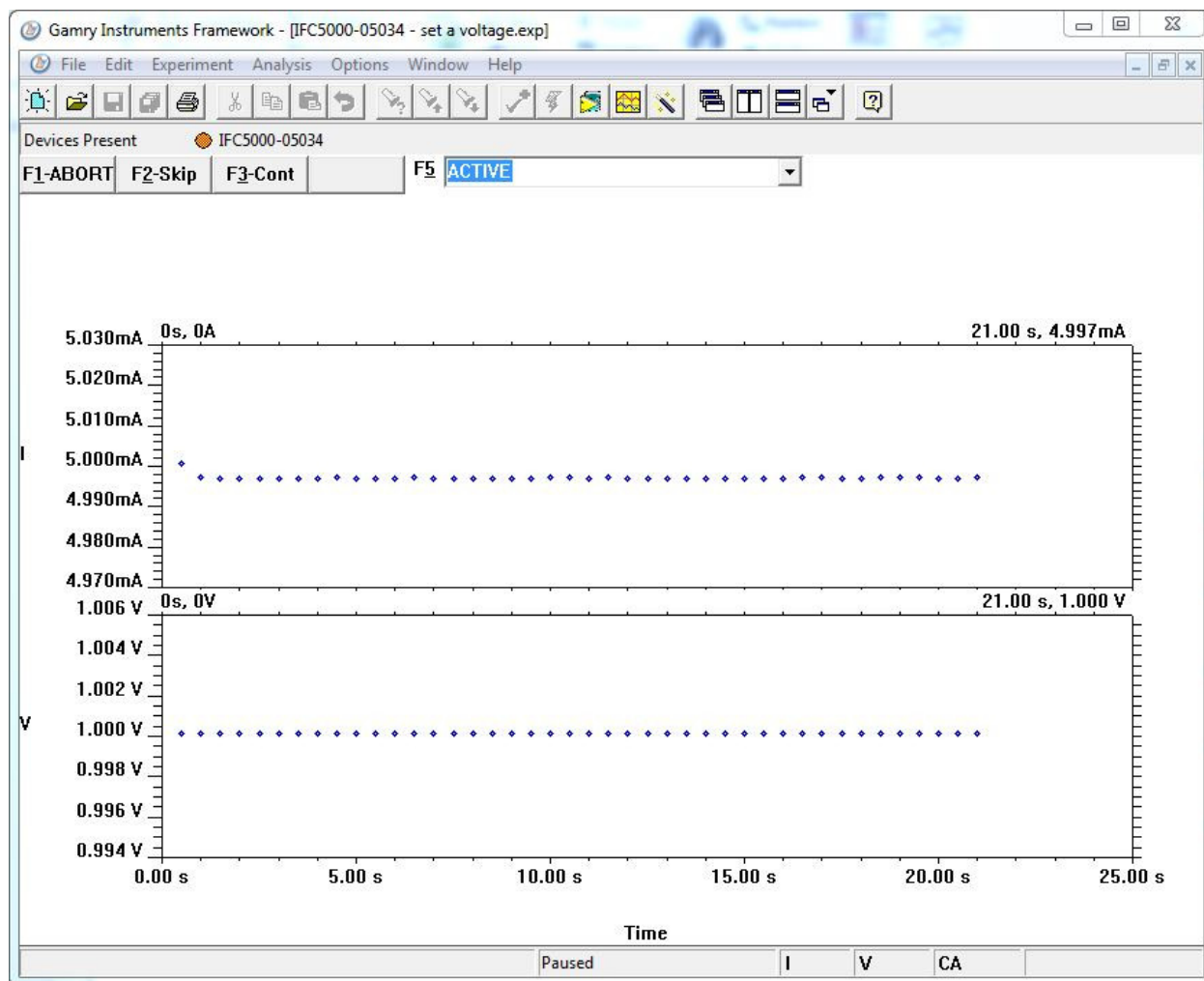

We expect you to see one of two very different results:

- If the instrument is working properly and the fuses in the cable are good, the measured current is ~ 5 mA as seen above. No overloads are seen.
- If the one or both fuses are open, all the current readings are near zero, and a red CA Overload indication may be seen at the bottom of the runner window.

If this test indicates an open fuse, use the procedures described above to check **both** fuses. This test cannot tell which fuse is blown. Both fuses can blow simultaneously.

If the fuse test indicates an open fuse, and the fuses both check out a good with an ohmmeter, some other problem has occurred in the cables or the instrument. Contact Technical Support at Gamry Instruments as soon as possible.

Chapter 6: Panel Indicators and Connectors

This chapter fully describes all the front and rear panel input and output devices on the Interface 5000. USB commands control all Interface 5000 functions, so this information is only needed for troubleshooting and special functions.



The Interface 5000 uses three DIN connectors for connections to external devices. The three DIN connectors all have different numbers of pins and physical sizes, so the cables used in them cannot be interchanged or improperly connected.

Front Panel

Power Button

The **Power** button is on the far right side of the Interface 5000 Front Panel. It is a push-push switch: push once to turn the instrument on and push again to turn the instrument off. The switch's button latches: the button is closer to the front panel when the instrument is on than when it is off.

Normally the **PWR** LED illuminates when the Interface 5000 is powered on; see the **PWR** LED description below.

Normally, the DC power is connected before the **Power** button is turned ON. However, no damage occurs if this switch is already in the ON position when the cable is connected to **Power In**, or when the AC power input is connected to the external power supply.



Caution: Avoid touching the **Power** switch button during normal instrument operation. Data are lost if the instrument is accidentally powered off during an experiment.

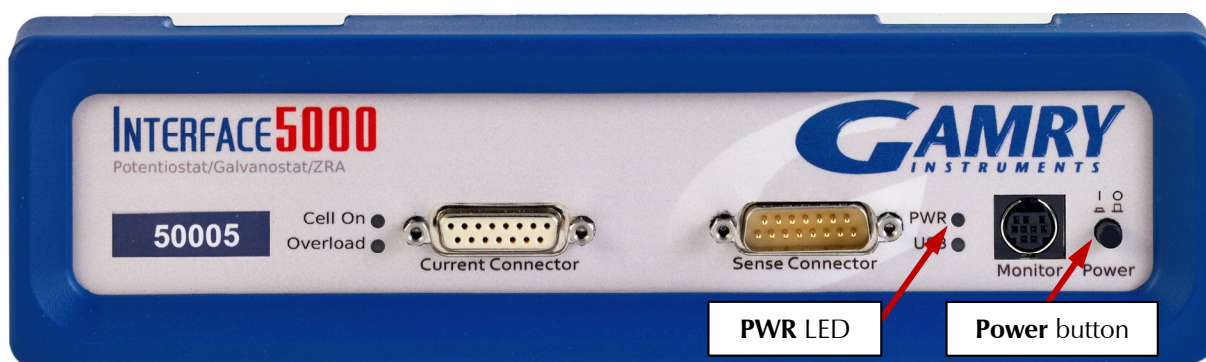

The PWR LED

The **PWR** LED is on the lower right of the Interface 5000 front panel. It normally glows a continuous blue when the Interface 5000 is turned on and has passed some simple power-on tests.

When the Interface 5000 is first turned on, the **PWR** LED will glow steadily for a second or two, blink three times, and then enter its normal continuous blue output.

When the **PWR** LED is off, these are possible causes:

- The **Power** button is off.
- There is no DC +48 V supply connected to the rear panel **Power In** connector.
- The external DC power supply has no input power or is malfunctioning.
- One part of the Power PC's power-up self-test has failed.

An Interface 5000's **PWR** LED blinks when that instrument is selected in the Framework's Instrument Manager. This allows easy identification of a specific instrument in a Multichannel system without looking at the instrument Serial Label on the bottom of the instrument chassis.

Finally, the **PWR** LED continuously blinks if the instrument is subject to an over-temperature condition. In this case, the instrument is not usable until it has been powered down, allowed to cool, and restarted.



Caution: The **PWR** LED indicates power status, power-up tests have passed, to identify instruments, and to indicate latch-up caused by an over-temperature event. Never rely on the **PWR** LED as a true power-status indicator. Always unplug the **Power In** connection if you suspect your Interface 5000 is malfunctioning.

Cell Connectors

The Interface 5000 has two cell cable connectors, each with a 15-pin D-type connector.

The left (female) connector is labeled **Current Connector**. It carries the cell current between the Counter electrode wire and the Working electrode wires.

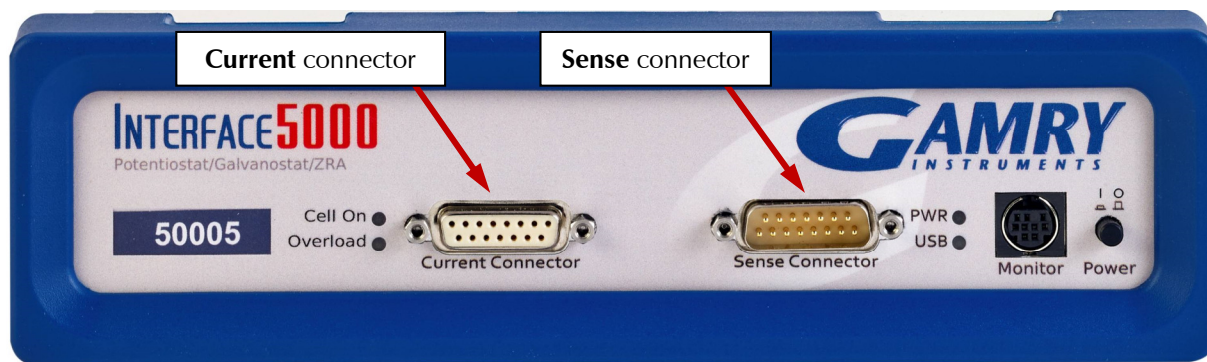

The right (male) connector is labeled **Sense Connector**. It contains only high-impedance inputs used to sense potentials in the cell.

In addition to the pins used for cell connections, each Interface 5000 Cell Connector also uses four pins to read a cell cable ID. Gamry software can compensate for the cell-cable characteristics to attain optimal system performance, especially in EIS (Electrochemical Impedance Spectroscopy). The cable IDs for the Interface 5000 are different from the IDs used by the Gamry Reference 3000. The cables look the same except for labeling, but they are **not** interchangeable. Gamry's software does not allow use of a Reference 3000 cable on an Interface 5000.

The cell connections are discussed in Chapter 5. A pin-out description of the cell cable connector is found in Appendix B.

Monitor Connector

The **Monitor** Connector is a 9-pin DIN-type connector. It contains two analog output signals; one analog input signal is used for connection of the Interface 5000 to external devices, a temperature input, and an analog input for measurement of analog input signals. It is not needed for any standard Gamry Framework electrochemical tests.

Additional information on this connector, its uses, and its signals is in Appendix C.

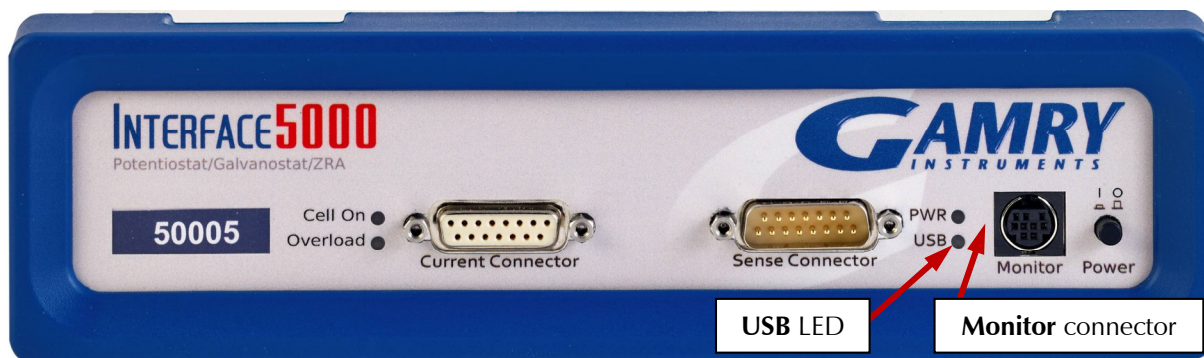

The USB LED

The **USB LED** is located just below the **PWR** LED. It is a tri-color LED, able to glow green, orange, or red.

The **USB LED** is unlit when:

- The Interface 5000 is not powered.
- The Interface 5000 does not have a USB cable plugged into its rear-panel **USB** port.
- The computer end of the USB cable is not plugged into a USB port on a computer or hub.
- The USB cable is not supplying USB power to the Interface 5000.
- The computer has disabled the USB port going to the Interface 5000.

The **USB LED** glows a continuous green if a valid USB connection is made and the Interface 5000's communication processor receives power along the USB cable.

The **USB LED** flashes orange whenever the Interface 5000 receives or transmits valid USB messages to or from the host computer. It does not flash if there is USB traffic addressed to other devices on the USB bus, including messages aimed at a different Interface 5000.

The **USB LED** indicates a continuous red in one special condition: when a firmware update occurs. Interrupting a firmware update can cause a catastrophic failure of your system. **Do not turn off the Interface 5000, do not unplug the USB cable, and do not stop the operation of the host computer when the USB LED is a continuous red color.**



Caution: Do not interrupt a firmware update while it is in progress. An incomplete update can render an Interface 5000 inoperable until it is returned to Gamry for reprogramming.

Cell On LED

The **Cell On** LED is to the left of the Front Panel Cell connector.

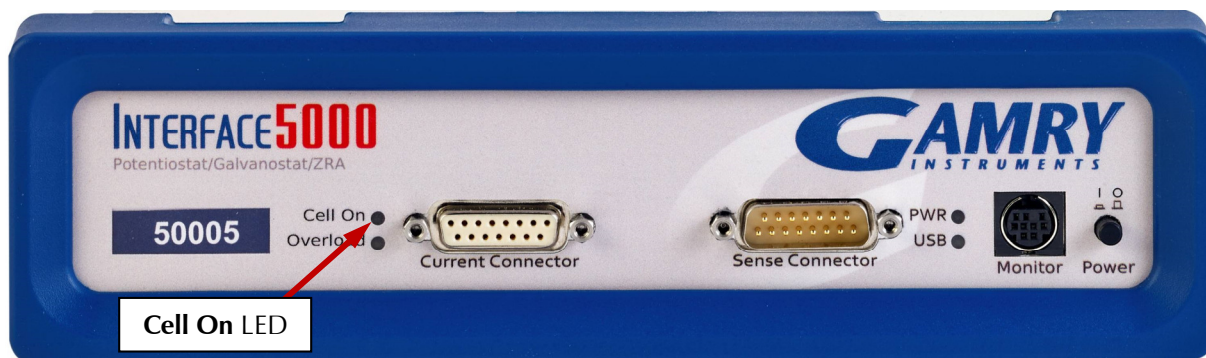

The **Cell On** LED glows yellow whenever the Interface 5000 is actively applying voltage or current to the electrochemical cell attached to the Cell Cable. Avoid touching the cell cable leads whenever the **Cell On** LED is lit, because the quality of the data being collected in your experiment may be compromised.



The **Cell On** LED does not indicate a dangerous condition when it is lighted. The voltages generated by the Interface 5000 are generally considered safe. Still, avoid touching the cell leads when the cell is on.

If you need to make changes to your cell leads, do so between experiments, when the **Cell On** LED is off and the potentiostat is inactive.

In a typical experimental sequence, the **Cell On** LED is off between experiments and during any open-circuit potential measurements. It glows yellow whenever the cell is polarized.

Overload LED

The **Overload** LED is just below the **Cell On** LED.

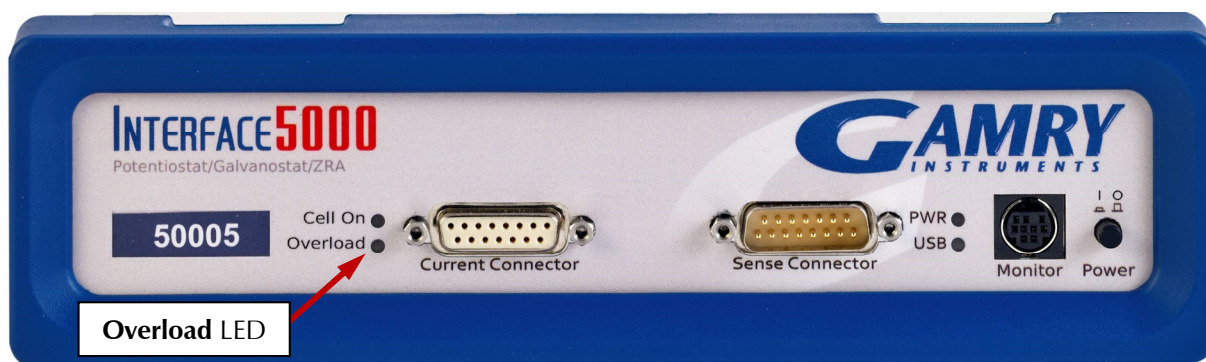

The **Overload** LED is normally unlit. When it glows red, some circuit in the Interface 5000 has exceeded its normal operating limit. Conditions that generate Overloads include:

- The absolute value of the differential electrometer output voltage (the difference in voltage between the Working and Reference leads) exceeds ± 6.125 V. This condition is known as an *E Overload*.
- The control amplifier has lost control of the cell. The absolute value of the cell current may be trying to exceed ± 5 A, or the absolute value of the counter electrode voltage may be trying to exceed ± 8 V. Either condition is a *Control Overload*.

- The absolute value of the cell current has exceeded full scale on the current range presently in use. This condition is an *I Overload*.

Transient (temporary) overloads **during** an experiment in which the cell voltage or current is being stepped or swept are often normal. In most cases, they **do not** indicate a system or instrument malfunction.

Consider the case of an infinitely-fast voltage step into a perfect capacitor. In theory, charging a perfect capacitor requires an infinite current. The current spike seen at each step in a stepped voltage waveform can easily illuminate the Overload LED. The current spike normally decays to near zero before the actual current and voltage readings are taken.

Overload indications when the cell is being connected or disconnected are common and usually do not indicate a problem. Overloads can also be seen when one of the cell leads is disconnected from the other cell leads, even though the cell is off. Again, this does not indicate a problem.

A steadily glowing **Overload LED during** an experiment most likely indicates a problem is occurring. Possible causes include:

- One of the cell leads is disconnected (this is the most common cause),
- A gas bubble in the cell is blocking one of the electrodes,
- The potentiostat could be oscillating.



A glowing red **Overload LED** does not necessarily indicate a system malfunction. The **Overload LED** can illuminate when one or more cell leads are disconnected, without indicating a problem with the system. The **Overload LED** can often illuminate momentarily during a swept or stepped experiment. The only **Overload LED** indication that definitely points towards a problem is a continuously glowing **Overload LED** during an experiment.

Customization Label Area

The left side of the Interface 5000 front panel has a transparent area in its plastic overlay. A paper label behind this area allows a custom appearance. This is especially important when the instrument is in a multiple-potentiostat system.

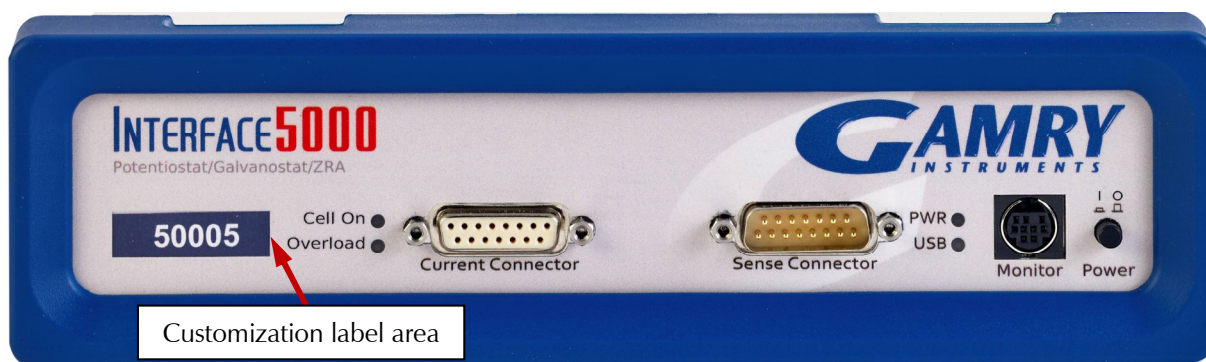

By default, the label in this area shows the instrument's serial number written in white text on a blue background. You can choose a different label. A sheet of alternate labels is provided with each instrument and a user-editable Excel file can be found on the Gamry website.

Full instructions describing the process of changing a label are near the end of the Installation chapter (Chapter 3).

Rear Panel

Power In Jack

The **Power In** jack is a 4-pin power DIN connector. The Interface 5000 derives all its power from +48 V DC input through the **Power In** jack. The input current is less than 1.8 A.

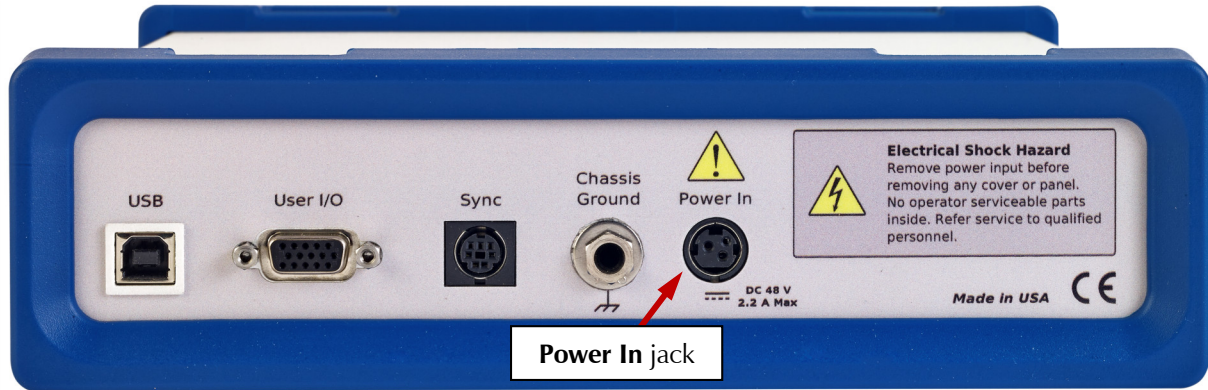

Always use the external power supply supplied with your Interface 5000 or power from an Interface Power Hub to supply DC power to the instrument.

The external power supply is rated for operation from 100 to 240 V AC, at frequencies from 47 to 63 Hz. It should therefore be useable worldwide.

Caution: Power input voltages less than 40 V or greater than 52 V can damage the Interface 5000's power supply.

Chassis Ground

The rear panel Chassis Ground banana jack is intended for one use only. When the Interface 5000 is used with cells isolated from earth ground, connecting the chassis ground to earth ground may lower the noise measured in the system. Note that the chassis of the Interface 5000 is connected to floating ground. Safety information concerning this is in Chapter 1.

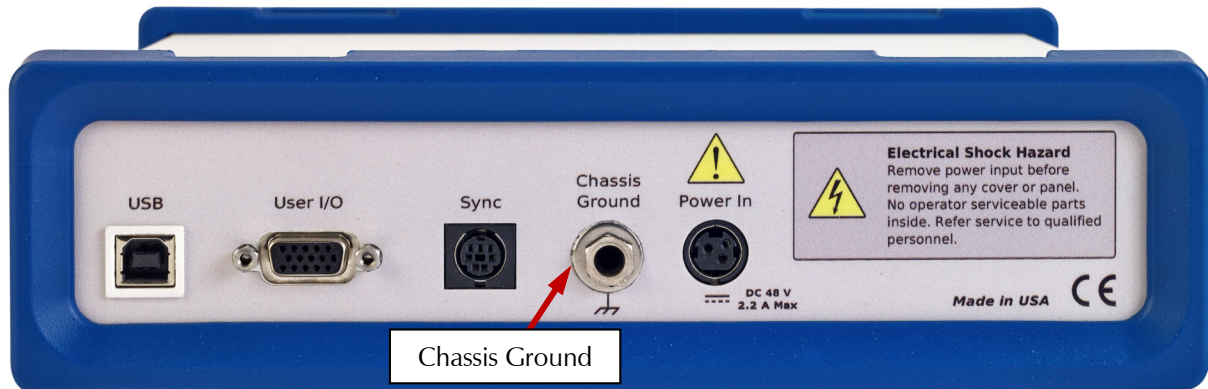

A banana plug is the only way you can connect to the Chassis Ground jack. Use a wire to connect the banana plug to earth ground.

A black banana-plug-to-banana-plug lead is provided with your Interface 5000. You may find it useful when making this earth-ground connection.

USB Port

The USB port on the rear panel of the Interface 5000 is a Type B connector as defined in Revision 1.1 and 2.0 of the USB Specification. Use a standard, shielded, Type A/B cable to connect this port to a computer's USB port or a USB hub (preferably an externally powered hub). The two ends of a Type A/B cable are different. The more-rectangular end plugs into the computer and the more-square end plugs into the Interface 5000.

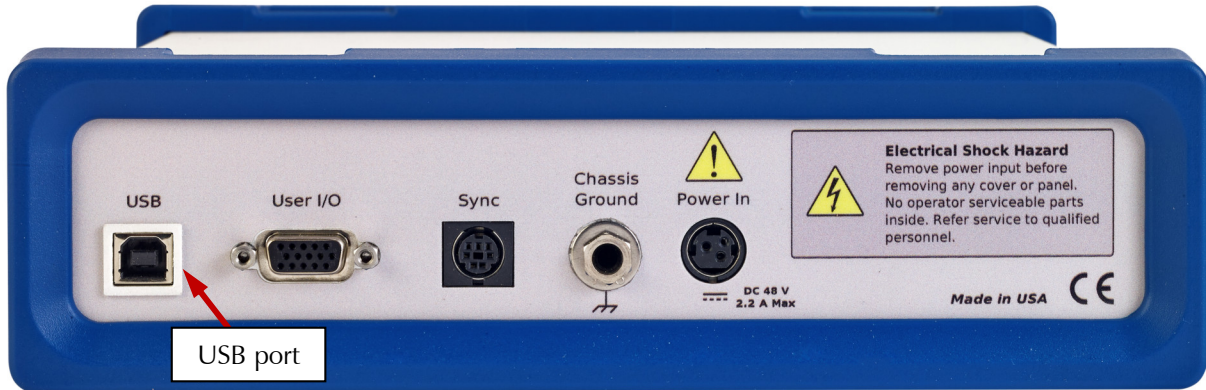

A suitable USB cable was included with your Interface 5000. If this cable is lost, you can replace it with a cable from your local computer retailer.

The Interface 5000 is a High Speed USB 2.0 peripheral, capable of data-transfer at 480 Mbits/second. If it is plugged into a computer port incapable of High Speed operation it will downgrade to USB 1.1 full-speed operation (12 Mbits/second), causing slower data-transfer. The Interface 5000 USB port is compatible with Revision 1.1 and 2.0 of the USB specification. It supports the Windows Plug-n-Play mechanism, including dynamic connect/reconnect.

The front panel USB LED should be green whenever a valid computer to Interface 5000 connection is made and both the computer and Interface 5000 are fully powered.

User I/O Connector

The **User I/O** connector contains digital signals used to connect external devices to the Interface 5000. All of its signals are referenced to earth ground, so their connection does not compromise the Interface 5000 ground isolation.

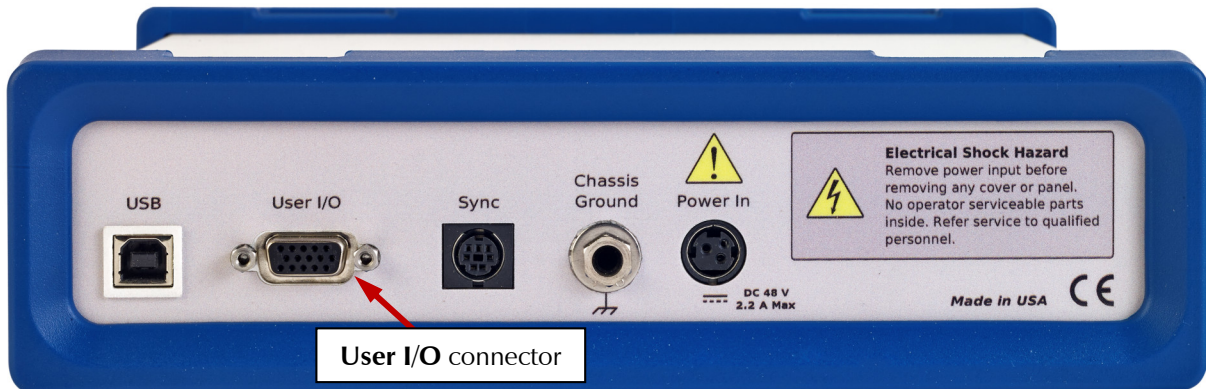

A full description of this connector is in Appendix C of this manual. This appendix includes details such as connector pin-out, output and input voltage levels, and full signal descriptions.

The following list is a short description of the signals in the **User I/O** Connector and their uses:

- Four digital outputs can be used to turn on external devices under control of an Explain experimental control script.
- Some of Gamry applications assign three of the digital outputs to control stirring, flow of de-aeration gas, and formation of mercury drops on a mercury-drop electrode.
- Four digital inputs that can be read in an Explain experimental control script.
- An analog output voltage. The output is generated by a 12-bit digital-to-analog converter with an output span from 0 to 4.096 V.
- This connector includes a 5 V power supply that can provide up to 50 mA of current for external circuitry.



Caution: Floating operation of Interface 5000 can be compromised by improper connections to the **User I/O** Connector. We do not recommend use of standard 15-pin shielded cables with this connector. Custom cables with the shield connected to pin 6 of the D-connector are preferred.

Sync Port

The Sync Port is used when several Interface 5000 instruments need to be operated with a common clock and simultaneous data-acquisition. It is an 8-pin mini-DIN connector.

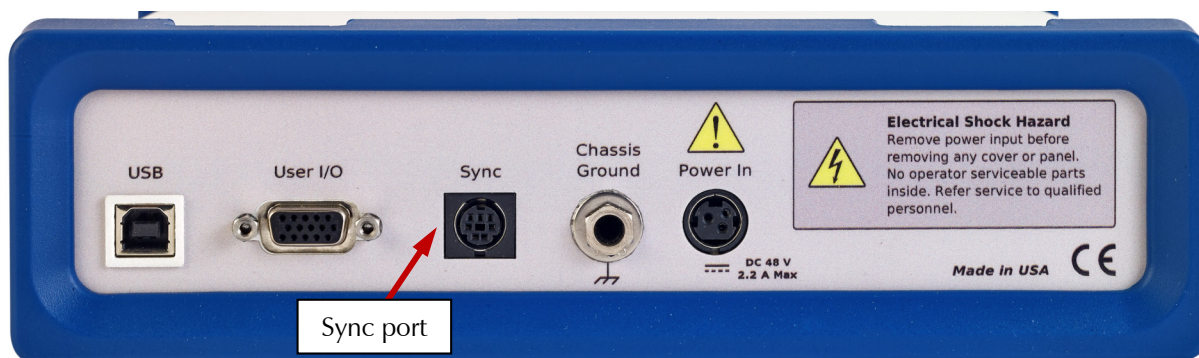

Simultaneous operation is only required when several instruments are connected to a single electrochemical cell. Examples include rotating ring-disk voltammetry, series flow cells, localized EIS systems, and electrochemical microscopy. In these examples, data-acquisition starts and stops on all the system's potentiostats simultaneously, and any excitation signals are closely coupled to data-acquisition.

Simultaneous operation is generally not required when instruments are connected to different electrochemical cells. A good example is parallel testing of batteries. You might want to start a number of tests simultaneously, but the tests need not remain synchronous, and they can end independently.

A full description of the Sync Port is in Appendix C of this manual.

Chapter 7: Instrument Circuitry

Interface 5000 Schematic/Block Diagrams

If you are not familiar with electronic schematics or potentiostats, you probably want to skip this chapter. This information is for expert use only and is not required for routine use of the Interface 5000.

The following figures are partly schematic diagrams and partly block diagrams. They are intended to show the basic principles of the Interface 5000 without the confusion of the full circuitry details. The complexity of the Interface 5000 can be quite daunting: the Interface 5000 circuit boards contain more than 2000 components connected by almost 5000 circuit nets.

The schematic/block diagram figures show:

- The Interface 5000 in its potentiostatic control mode.
- The circuits for signal generation.
- The circuits for signal conditioning and A/D conversion.
- The processors in the Interface 5000.
- DC-DC power conversion.



Warning: If your instrument malfunctions, Gamry Instruments does not recommend user repair. The information provided here is not sufficient for troubleshooting problems in an Interface 5000. Contact Gamry Instruments at techsupport@gamry.com or your local Gamry representative if you have problems.

Figure 7-2
Interface 5000 Signal Generation Circuitry

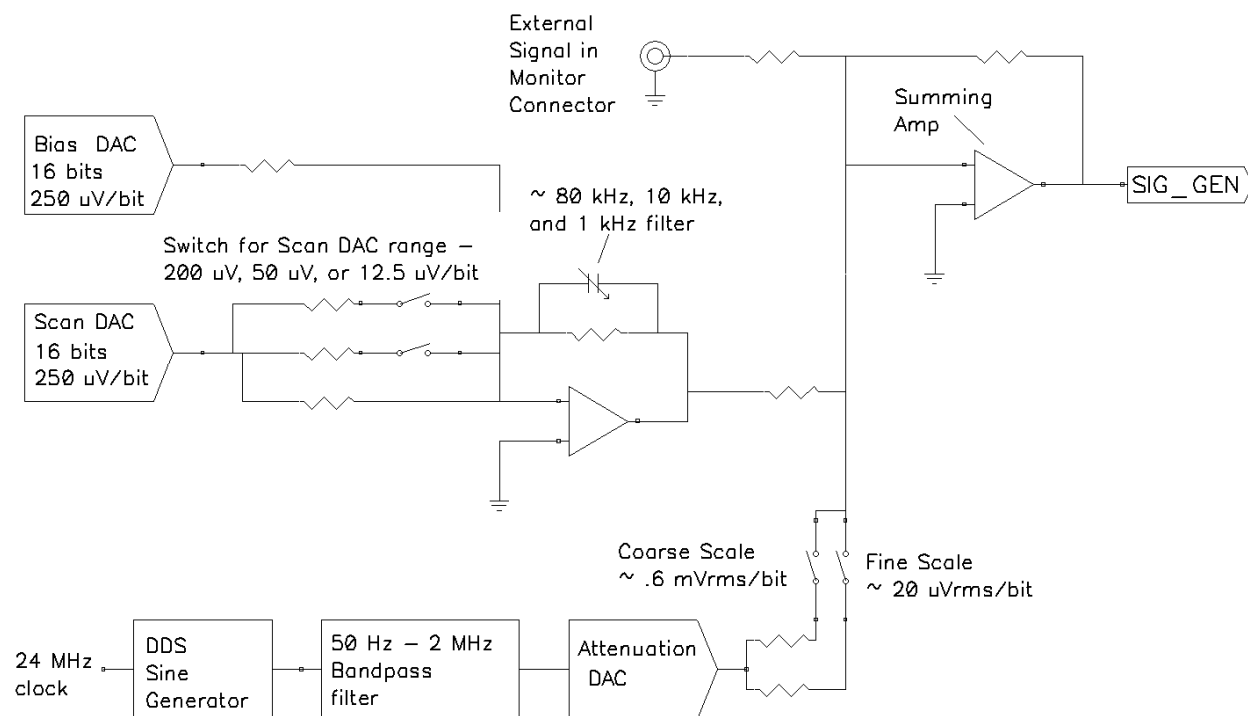

Notes for Figure 7-2:

- All the resistors summing voltages into the Summing Amplifier input do not have values shown because their values depend on scaling factors too complex for this simplified diagram.
- Calibration components are not shown.
- High-frequency sine-wave generation is done using a DDS (direct digital synthesis) IC. The DDS's output is filtered with both a high-pass and low-pass filter. The low-pass filter removes the steps in the DDS output. The high-pass filter provides AC-coupling to prevent drift in the DDS's offset entering the applied signal. In practice, Gamry EIS software uses the DDS to apply sine waves with frequencies from 100 Hz to 1 MHz. It uses the Scan DAC to generate sine signals at frequencies below 100 Hz.
 A two-stage attenuator scales the DDS. On the coarse scale, the maximum output signal is $2.33 V_{rms}$ ($3.3 V_{peak}$) and the resolution is approximately $0.6 mV_{rms}/bit$. On the fine scale, the maximum is approximately $77 mV_{rms}$ and the resolution is approximately $20 \mu V_{rms}$. AC-signal attenuation is handled automatically by Gamry software.
- The Scan DAC and Bias DAC signals are filtered before they are applied to the cell. The filter bandwidths are as shown.

Figure 7-3
One A/D Signal Chain in the Interface 5000

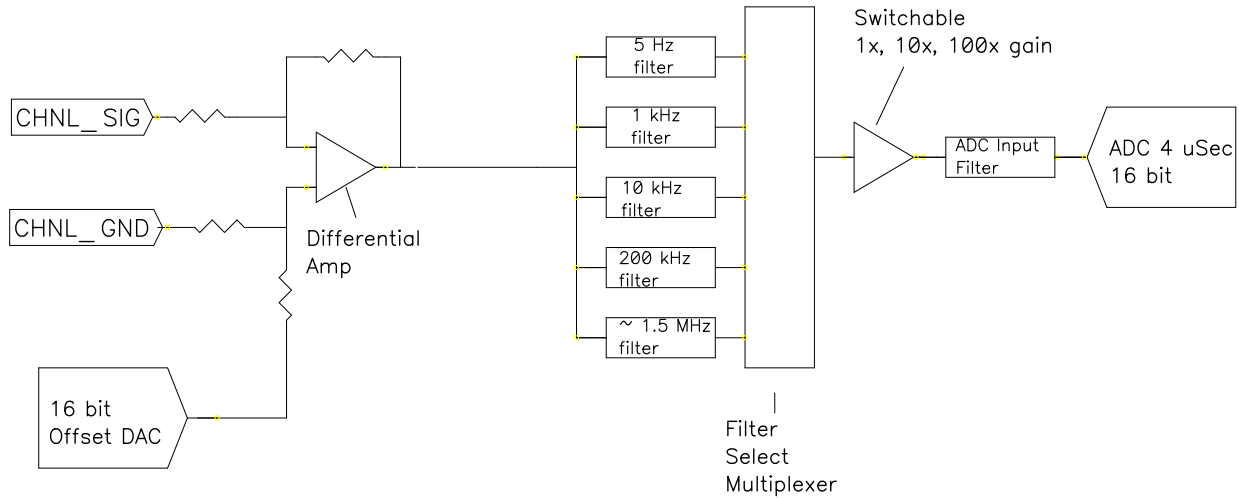

Notes for Figure 7-3:

- This diagram shows one of three identical ADC channels. One channel is dedicated to measurement of the potentiostat's current signal, another is used to measure the voltage signal, and the third is switched between several functions.
- All three A/D converters are triggered simultaneously to start a conversion. This trigger and the pulse updating the Scan DAC voltage are under the control of a hardware state-machine. This insures that all waveform and data-acquisition timing is tightly controlled and reproducible point-to-point.
 By default, the data-acquisition is synchronized with the system's 300 kHz and 600 kHz power-supply-switching frequencies, reducing noise caused by the power supply. Data-acquisition times that are a multiple of 1.666 μ s maintain this synchronization.
- All analog signals are received differentially as shown here.
- The 5 Hz, 1 kHz, 10 kHz, 200 kHz and 1.4 MHz filters are 2-pole Butterworth filters.

Figure 7-4
Microprocessors in the Interface 5000

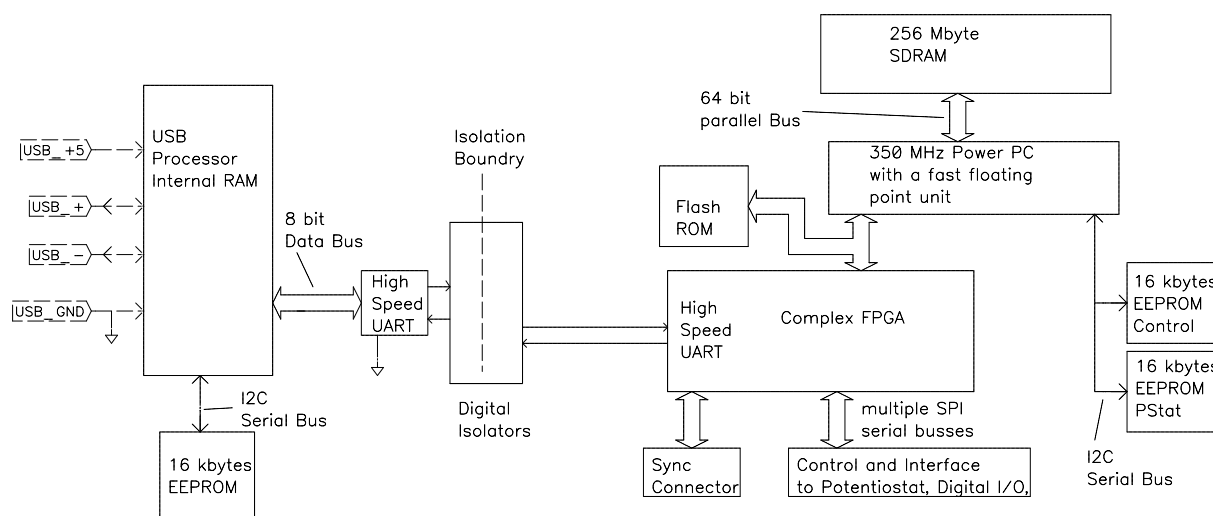

Notes for Figure 7-4:

- Note the lack of a ground connection between the USB bus and the Interface 5000 circuitry.
- The USB Processor firmware is loaded into its RAM upon power-up.
- The Power PC firmware is also transferred from ROM into RAM on power-up. Time-critical sections of the Power PC code are kept in the processor's fast-cache memory.
- The term UART refers to a Universal Asynchronous Receiver Transmitter. It converts parallel data to a serial bit-stream. The UARTs send data at 6 Mbits/second.
- The Interface 5000 has local non-volatile data storage to save calibration data and board-revision information. Interface 5000 calibration data is stored in the instrument, not in a data file. When an Interface 5000 is moved from one computer to another, its calibration remains valid.
- The FPGA code can be updated in the field over the USB connection.
- The Instrument manager can be used for field update of all three programmable parts: Communications, Instrument, and PLD firmware updates. Obtain binary code for the updates from the Gamry website. If you need assistance with field updates, contact Gamry technical support at techsupport@gamry.com, or contact your local Gamry representative.

Figure 7-5
Power Conversion

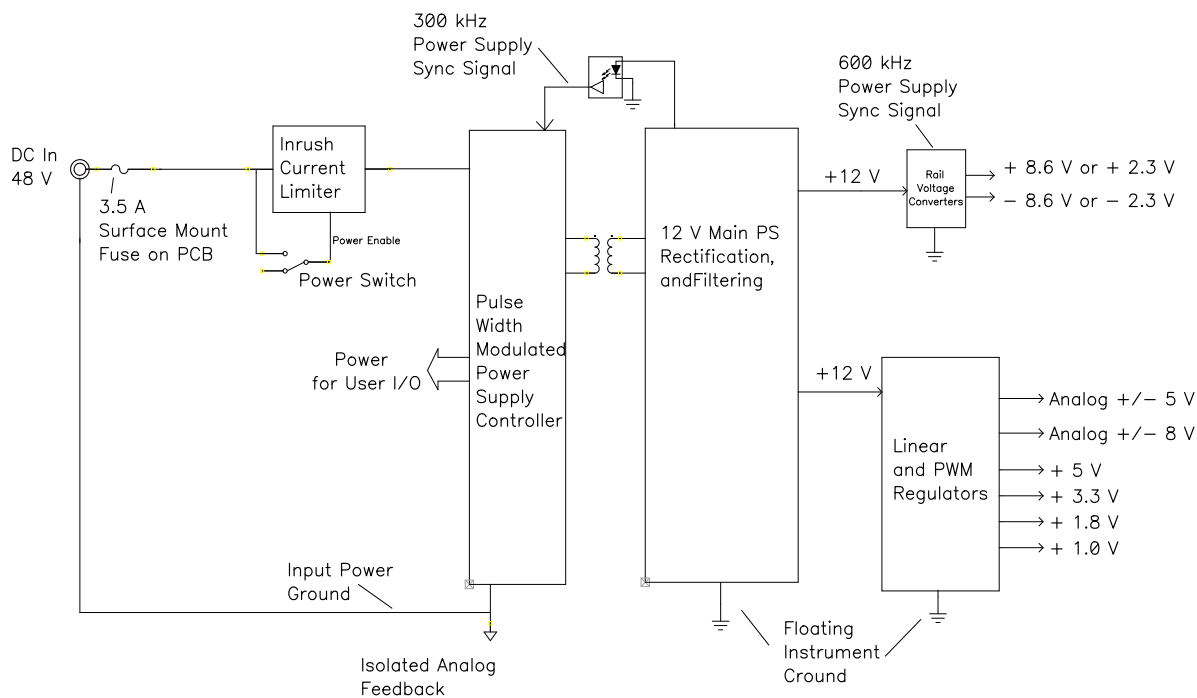

Notes for Figure 7-5:

- Note the ground isolation between the input power and the Interface 5000 circuitry. The Interface 5000 chassis is connected to the Floating Instrument Ground.
 - Transformers and digital isolators are the only components connected between the grounds.
- Both 600 kHz and 300 kHz power-supply sync signals are derived from the same clock used to control data-acquisition. Data points taken at an integer multiple of $1.666 \mu\text{s}/\text{point}$ are synchronized with the power supply, minimizing the effect of power-supply noise on the data.
- The DC-DC converter powers both the floating circuitry and some earth-side circuitry, including the USB processor and User I/O.
- Additional circuitry protects the Interface 5000 against ESD and electrical surges.
- Like most complex electronic apparatus, the Interface 5000 uses a variety of power-supply voltages.
- The incoming DC voltage must be between 46 and 50 V. With inputs below 46 V, the PWM may be unable to regulate the supply. Above 50 V, the PWM may not start-up.



Caution: Do not use a DC power source other than the AC adapter model provided with your Interface 5000 or a Gamry-supplied alternative. Other power sources may void the performance and/or safety characteristics of the Interface 5000.

Power input voltages less than 40 V or greater than 52 V can damage the Interface 5000's power supply.

Appendix A: Interface 5000 Specifications

All specifications are at an ambient temperature of 22°C, with the Interface 5000 powered using the external power supply shipped with the unit, a standard shielded 60 cm cell cable, and the cell enclosed in a Faraday shield. All specifications obtain after software calibration.

A numbered note qualifies many of the specifications. Many of these notes describe the method used to measure a specification. The notes are found at the end of this appendix.

All specifications are subject to change without notice.

Control Amplifier

Compliance Voltage	Min	±6.5	V	Note 1
Output Current	Min	±5	A	Note 2
Unity Gain Bandwidth	Typ	1050, 250, 43, 4.4, 0.5	kHz	Note 3
Slew Rate	Typ	10, 4.4, 0.7, 0.07, 0.007	V/μs	Note 4

Differential Electrometer

Max Input Voltage	Max	±6.0	V	Note 4
Input Current	Max	25	pA	Note 6
Input Resistance	Typ		TΩ	Note 7
Differential (between inputs)		10		
Common Mode (input to ground)		1		
Input Capacitance	Typ		pF	Note 7
Differential (between inputs)		8		
Common Mode (input to ground)		12		
Bandwidth (–3 dB)	Min	12	MHz	Note 8
CMRR	Min		dB	Note 9
DC to 10 kHz		98		
10 kHz to 100 kHz		88		

Voltage Measurement

A/D Full Scale Ranges	Typ	±6.5536	V	Notes 5, 10
Resolution (before gains)	Typ	200	μV/bit	
Zero Offset Error	Max	0.5	mV	Note 11
Gain Error	Max	0.2	%	Note 11
Offset Range	Typ	±6.5536	V	Note 12
Post-offset Gain	Typ	1×, 10×, 100×		

Current to Voltage Converter

Maximum Full-scale Range		± 5	A	Note 13
Minimum Full-scale Range		± 50 ± 500 (after 100 \times gain)	μA nA	Note 13
Voltage across Rm	Typ	± 100	mV at full scale	Note 14
Output Voltage (at Monitor and ADC in)	Typ	± 3.0	V full scale	
Input Offset Current	Max	25	pA	Note 15
Range Zero Offset	Max	0.05	% of range	Note 15
Gain Tolerance, 5 A to 50 μA ranges	Max	0.2	% of reading	Note 15
Zero drift	Typ	0.02	% FS/ $^{\circ}\text{C}$	Note 16
Bandwidth (-3 dB)	Typ	5	MHz	Note 17

Current Measurement

Resolution	Typ	0.00333...	% FS/bit	
Offset Range	Typ	± 100	% of range	
Post-offset Gain	Typ	1 \times , 10 \times , 100 \times		
Accuracy	Typ	Dominated by current-to-voltage error (see above)		

Potentiostatic Mode

Applied Voltage Range	Min	± 6.0	V	
Accuracy DC zero offset Gain	Max	1 0.2	mV % setting	Note 18
DC Bias	Typ	± 6.5536	V	
Scan DAC ranges	Typ	± 6.5536 , ± 1.6384 , ± 0.4096	V	
Drift	Max	< 20	$\mu\text{V}/^{\circ}\text{C}$	Note 19
Noise and Ripple 1 Hz to 1 kHz 1 Hz to 200 kHz	Typ	10 20	μV rms	Note 20

Galvanostatic Mode

Maximum Full Scale Current		± 5	A	
----------------------------	--	---------	---	--

Interface 5000 Specifications

Minimum Full Scale Current		±50	μA	
Accuracy		Dominated by current-to-voltage converter accuracy shown above		
Sig Gen Voltage for Full Scale Current		±3.0 V		

Temperature Measurement

Measurement range		-50 to 600	°C	
Accuracy of measurement	Typ	RTD error ± 0.3	°C	Note 24
RTD resistance at 0°C	Typ	1000	Ω	
RTD's temperature coefficient of resistance, 0 to 100°C range	Typ	0.00385	Ω/°C	Note 25
Temperature-reading display		°C rounded to one decimal point	°C	
RTD connection		Customer-provided		Note 26
RTD calibration		Customer-provided, if required		

Environmental

Operating Temperature Range		0 to +45	°C	
Relative Humidity	Max	90 (non-condensing)	%	
Storage and Shipping Temperature		-25 to +75	°C	
Maximum Shipping Acceleration		30	g	

General

DC Power Input Voltage	Range	46 to 50	V	
Power	Max	85	W	
Leakage Current (floating, earthed working electrode)	Typ	±10	nA	Note 27
Dimensions		24 × 27 × 6	cm	Note 22
Weight	Max	2.5	kg	Note 22
Dimensions of External Power Adapter	Max	14.7 × 6.7 × 3.4	cm	Note 23
Weight of External Power Adapter	Max	450	g	Note 23

NOTES:

- 1) Measured in galvanostatic mode with a high-power 2.4 Ω load resistor connected from the counter to the working electrode leads. The compliance voltage is measured using an external voltmeter across the 2.4 Ω load. Under these conditions, the output current is approximately 2.72 A.
- 2) Measured with a high-power 1 Ω load resistor connected between the counter and working electrode leads, in potentiostatic mode.
- 3) Unity gain bandwidth and slew rate are correlated. Each has five settings, with the highest slew rate occurring at the highest bandwidth, down to the lowest slew rate occurring at lowest bandwidth. Both are measured with 2 kΩ between counter and reference, and 20 Ω between the reference and the working and working sense leads.

Interface 5000 Specifications

Measured with a Frequency Response Analyzer connected to the Ext Sig In pins of the **Monitor** connector.

- 4) Measured with an external function generator connected to the Ext Sig In pins of the **Monitor** connector. Cell resistor 90 Ω connected between the counter and working electrode leads, in potentiostatic mode.
- 5) The A/D and signal-processing chain in the Interface 5000 allows measurement of voltage signals as large as ± 6.5536 V. The voltage on the Work Sense lead can be as high as ± 0.51 V when measuring 5A using a 60 cm cell cable. This implies a maximum voltage input on the differential electrometer of ± 6.04 V.
- 6) This specification is tested using a 2 G Ω resistor switched into the input and measuring the voltage difference with and without the input resistance.
- 7) The differential impedance is measured between the Reference and Work Sense inputs. This is the impedance you measure when you record the EIS spectrum of an infinite impedance (open lead) cell. There is also a common-mode resistance and capacitance associated with the differential electrometer inputs. These values tell you how much the electrometer response is modified by a resistance in series with the source.
- 8) The bandwidth is for a sine-wave source with a 50 Ω output impedance driving either input. The bandwidth is well in excess of this specification, which is limited by the measurement equipment used in routine testing of the Interface 5000.
- 9) CMRR is common-mode rejection ratio. It specifies the ability of the differential electrometer to reject signals connected to both inputs. The CMRR is measured driving both inputs with a sine-wave source with a 50 Ω output impedance and measuring the error as a function of frequency. Resistance in either input will cause a loss of CMRR.
- 10) Voltage measurement is performed with a nominal ± 6 V signal input to the ADC signal chain. The actual full scale is 6.5536 V.
- 11) The total error in a voltage measurement is:

$$\text{Error} = \text{Zero Offset Error} + \text{Gain Error} \times \text{Voltage}$$

For a 1 V signal the theoretical error can be as high as 2.5 mV. This error is typically less than 0.2 mV.

- 12) Offsets are summed into the signal. Offset inaccuracy is approximately $\pm 0.05\%$ of the setting plus ± 0.5 mV.
- 13) There are six hardware current ranges, separated in sensitivity by decades. The ranges are 50 μA , 500 μA , 5 mA, 50 mA, 500 mA and 5 A full scale. The $\times 10$ and $\times 100$ gains add two virtual ranges of 5 μA and 500 nA full scale.
- 14) The voltage across the current measurement resistor, R_m , is as shown. On ranges below 5 mA, the working electrode voltage is similar to the voltage across R_m . At 5 A and 1 MHz, the working electrode voltage can be as high as 0.51 V, because the cable has both resistive and inductive impedance.
- 15) The total error in a current measurement is:
$$\text{Error} = \text{Input Current Offset} + \text{Range Zero Offset} \times \text{FS Current} + \text{Gain Tolerance} \times \text{Measured Current}$$
The first term can generally be ignored on the Interface 5000. The units for the error are amperes.
- 16) Drift can be approximated by simple drift in the Range Zero Error. In reality all three terms in the equation above can have drift.
- 17) The Current to Voltage converter bandwidth is a function of the current range, the cell cable, and the I/E Stability setting. Longer cell cables add capacitance and slow the current measurement. The specified I/E Converter BW is measured at 5 mA I/E Range.

Interface 5000 Specifications

- 18) The total error in a voltage setting is:

$$\text{Error} = \text{DC Zero Offset} + \text{Gain} \times \text{Voltage Setting}$$

For a 1 V signal the theoretical error can be as high as 2.5 mV. In practice the error is generally less than 1 mV.

- 19) This specification is guaranteed by design. It is not tested.
- 20) This specification is measured by applying zero voltage across a 1 Ω resistor and measuring current noise on the 500 μA scale. 1 μV of voltage noise creates a current of 1 μA . The filters in the ADC Chain for the I Signal are used to limit the bandwidths as shown in the specifications. Signal averaging via Gamry DSP mode further reduces the measured noise.
- 21) See Appendix D.
- 22) Excluding external power adapter and any cables supplied with unit.
- 23) Excluding removable line cord.
- 24) A platinum RTD sensor according to DIN/IEC751 European Standard is used to measure the temperature of a sample.
- 25) Measured between 0 and 100°C.
- 26) Two-pin connection through front panel **Monitor** connector or through BNC connector at **Monitor** board. **Monitor** board is an optional accessory.
- 27) Isolation quality has both DC and AC factors, predominantly at the power-supply frequency of 300 kHz. Only the DC leakage current is shown here. Measured under the following conditions: cell is a 10 k Ω resistor, PSTAT mode, CA speed is normal, I/E stability is slow, I/E range is 50 μA , I-channel filter is 5 Hz, and I-channel gain is 100.

Appendix B: Interface 5000 Cell Connectors

Chapter 5 describes the connections between a cell cable and an electrochemical cell. This appendix describes the other end of the cell cable.

Multiple pins assigned to the same signal are connected together on the Interface 5000's Potentiostat board. If you must connect this using a special cell cable, you need a wire connected to **any one** of the D-connector pins.

Table B-1
Current Connector

Pin(s)	Signal Name	Use
1,9	Working	Connected to the working electrode (see Chapter 5).
2, 10	Working Shield	The shield for the working electrode. Connected to Floating Ground on D-end of the cable. Left open at the cell end of the cell cable.
3	No connect	
4, 6,11,13	Ground	The potentiostat's floating ground. Can be used to shield the cell if very low currents need to be measured. Also used as a shield for the counter electrode cable.
5,12	Counter	Connected to the counter electrode
7	CBL_ID1	One of four cable ID bits. Used to identify the type of cell cable attached to the unit. Pull to a logic High through a resistor. Ground to set the bit low.
8	CBL_ID2	One of four cable ID bits. Used to identify the type of cell cable attached to the unit. Pull to a logic High through a resistor. Ground to set the bit low.
14	CBL_ID0	One of four cable ID bits. Used to identify the type of cell cable attached to the unit. Pull to a logic High through a resistor. Ground to set the bit low.
15	CBL_ID3	One of four cable ID bits. Used to identify the type of cell cable attached to the unit. Pull to a logic High through a resistor. Ground to set the bit low.

Table B-2
Sense Connector

Pin(s)	Signal Name	Use
1	CBL_ID2	One of four cable ID bits. Used to identify the type of cell cable attached to the unit. Pull to a logic High through a resistor. Ground to set the bit low.
2	CBL_ID1	One of four cable ID bits. Used to identify the type of cell cable attached to the unit. Pull to a logic High through a resistor. Ground to set the bit low.
3	Ground	The potentiostat's floating ground. Can be used to shield the cell if very low currents need to be measured. Also used as a shield for the counter electrode cable.
4	Counter-sense Shield	The shield for the counter-sense electrode input. Driven to the same potential as Pin 11. Left open at the cell end of the cell cable.
5,6,12,14	Reference Shield	The shield for the reference electrode input. Driven to the same potential as Pin 13. Left open at the cell end of the cell cable.
7,15	Work Sense Shield	The shield for the work sense electrode input. Driven to the same potential as Pin 8. Left open at the end of the cell cable.
8	Work Sense	Connected to the working electrode in most cases (see Chapter 5). This lead has a 261 Ω resistor in the cell end of the cable. Custom cell cables are likely to require a similar resistor.
9	CBL_ID3	One of four cable ID bits. Used to identify the type of cell cable attached to the unit. Pull to a logic High through a resistor. Ground to set the bit low.
10	CBL_ID0	One of four cable ID bits. Used to identify the type of cell cable attached to the unit. Pull to a logic High through a resistor. Ground to set the bit low.
11	Counter Sense	Connected to the counter electrode in ZRA-mode and stack-mode experiments (see Chapter 5). This lead has a 261 Ω resistor in the cell end of the cable. Custom cell cables are likely to require a similar resistor.
13	Reference Electrode	Connected to the reference electrode in most cases (see Chapter 4). This lead has a 261 Ω resistor in the cell end of the cable. Custom cell cables are likely to require a similar resistor.

Appendix C: I/O Connectors

The Interface 5000 includes several I/O connectors other than the Cell Connector described in Appendix B. The details of these connectors are described here.

User I/O Connector

This connector contains a number of signals, used to interface the Interface 5000 to external apparatus. It is the miniature 15-pin female D-shaped connector on the rear panel of the Interface 5000.

Be careful: the ground pin (pin 6) on this connector is earth ground and the D-connector shell is the Interface 5000 Floating Ground. Improper **User I/O** connections can damage an Interface 5000 that is connected to a high-energy cell containing earth-grounded terminals.



Caution: Floating operation of the Interface 5000 can be compromised by improper cabling to the User I/O Connector. We do not recommend use of standard 15-pin shielded cables with this connector. Custom cables with the shield connected to pin 6 of the D-connector are preferred.

The pin out of this connector is shown in Table C-1.

Table C-1
User I/O Connector

Pin	Name	Use
1	Analog Output High	The auxiliary output signal (DAC output). The output range is 0 to +4.096 V.
2	Analog Output Low	The auxiliary output ground connection (ground)
6	Ground	Digital ground
7	Digital Out 0	A CMOS-compatible digital output, connecting device input current must be below 10 μ A
8	Digital Out 1	A CMOS-compatible digital output, connecting device input current must be below 10 μ A
9	Digital Out 2	A CMOS-compatible digital output, connecting device input current must be below 10 μ A
10	Digital Out 3	A CMOS-compatible digital output, connecting device input current must be below 10 μ A
11	Digital In 0	A CMOS-compatible digital input: 2.2 k Ω input impedance
12	Digital In 1	A CMOS-compatible digital input: 2.2 k Ω input impedance
13	Digital In 2	A CMOS-compatible digital input: 2.2 k Ω input impedance
14	Digital In 3	A CMOS-compatible digital input: 2.2 k Ω input impedance
15	+5 V	Power, 50 mA maximum current

Sync Port

The **Sync** Port is used to interconnect Interface 5000s that must be operated synchronously, with a single clock and with simultaneous data-acquisition. The **Sync** connector is a 7-pin mini-DIN connector on the rear panel of the Interface 5000.

Gamry's synchronization system uses the terms *Master* and *Serf* as defined below.

Master: The Master potentiostat provides the clock signal used for all potentiostats and provides data-acquisition pulses used to control the timing of A/D conversion. All synchronous multiple-potentiostat systems have only one Master.

Serf: A Serf potentiostat gets its timing information from a Master potentiostat. A multiple-potentiostat system can have up to seven Serf potentiostats all controlled by one Master.

A special cable is used to connect the instruments that will be synchronized. The cable has a Master connector on one end and a variable number of Serf connectors.

Gamry sells three standard Master-Serf cables:

- 985-00132 One Master and one Serf
- 985-00133 One Master and up to three Serfs
- 985-00134 One Master and up to seven Serfs

All of these cables have the Master end of the cable identified by a large M on the DIN connector. A cable may be used with some instruments missing, so the eight-instrument Master-Serf cable may be used for one Serf, two Serfs, three Serfs,..., seven Serfs.



We recommend that you always plug the Master and last Serf ends of the cable into a potentiostat. You may leave the DIN connectors in the middle of the cable disconnected.

The Master-Serf connection scheme sends a 24 MHz complex clock signal from the Master to the Serfs using a daisy-chained low-voltage differential signal (LVDS). Data-acquisition pulses are embedded in the clock signal. DC pins in the DIN connector are used to detect all cable connections, and, most importantly, detect the Master end of the cable.



Use only Gamry-supplied cables for all Master-Serf synchronized systems. The cable uses a differential pair that requires controlled impedance, making user-construction of a cable very difficult.

Monitor Connector

The **Monitor** Connector is located on the Interface 5000 Front Panel. It is a 9-pin round mini-DIN connector. One possible mating connector is from CUI Inc., part number MD-90. The pin-out signals of the **Monitor** Connector are provided in Table C-2.

Table C-2
Monitor Connector

Pin	Name	Use
1	Signal Ground	A high-quality floating ground. Signals are relative to this ground
2	Signal Ground	Another high-quality floating ground. Signals are relative to this ground
3	RTD Positive	The Positive RTD Input. 1 mA flows between this pin and Pin 4.
4	RTD Negative	The Negative RTD input. Connected to the Interface 5000's floating ground.
5	E_sig	E Monitor Signal, ± 6.5536 V full scale
6	EXT_SIG	External Signal In, ± 6.5536 V full scale
7	I_Sig	I_Monitor Signal, ± 3.2678 V full scale
8	Aux ADC In -	The minus input of the differential Aux ADC Input
9	Aux ADC In +	The positive input of the differential Aux ADC Input

I Monitor Signal

The I Monitor signal represents the output of the Interface 5000 current measurement circuit. It can be treated as a two-wire differential signal with the negative side connected to the Interface 5000 Signal Ground. With the exception of the filtering described below, it is the raw signal with no offset or gain applied. IE Stability capacitors slow the response.



Caution: The ground side of the I Monitor signal is connected to the Interface 5000 Floating Ground. Connection signal to an earth-ground-referenced apparatus can compromise the Interface 5000's ability to float, and invalidate data collected on earth-grounded cells.

Scaling on this signal is ± 3 V for \pm the nominal full-scale current on the selected current range. Cathodic currents cause a positive output voltage. If the software is auto-ranging the current-range selection, this signal is discontinuous at each range change.

The I Monitor signal is filtered using an RLC circuit. It has a bandwidth of approximately 350 kHz when connected to a high-impedance input.

E Monitor Signal

The E Monitor signal is derived from the output of the Interface 5000's differential electrometer circuit. It can be treated as a two-wire differential signal with the negative side connected to the Interface 5000 Signal Ground. With the exception of the filtering described below, it is the raw voltage signal, with no offset or gain applied. With the exception of the filtering described below, it is buffered representation of the voltage difference between the white and blue cell cable leads.



Caution: The negative side of the E Monitor signal is connected to the Interface 5000 Floating Ground. Connection of signal to an earth-ground-referenced apparatus can compromise the Interface 5000's ability to float, and invalidate data collected on earth-grounded cells.

The E Monitor signal is filtered using an RLC circuit. It has a bandwidth of approximately 1.1 MHz when connected to a high-impedance input.

External Signal In

External Signal In allows you to add a voltage to the Interface 5000's Signal Generator. It is a two-wire differential signal with the negative side connected to the Interface 5000 floating ground. This signal is summed with the other signal-generator sources, including the Bias DAC, the Scan DAC, and the DDS output.



Caution: The negative side of the External Signal In signal is connected to the Interface 5000 Floating Ground. Connection of signal to an earth-ground-referenced apparatus can compromise the Interface 5000's ability to float, and invalidate data collected on earth-grounded cells.

The signal generator output is directly connected to the potentiostat's input. When the cell is turned on in potentiostat mode, the feedback is such that a negative signal-generator output creates a positive differential electrometer signal, which corresponds to a negative working electrode versus reference electrode voltage.

The polarity of the External Signal In signal is inverted at the signal generator's output. As described above, a negative input signal on this input will create a positive change in the working electrode versus reference electrode voltage. The input impedance of this signal is 2 k Ω .

AUX IN

The **AUX IN** BNC connector allows you to measure a voltage from outside the Interface 5000 using the Interface 5000's internal A/D. The scaling is ± 3 V in equals $\pm 30\,000$ A/D counts. This is a resolution of $100\ \mu\text{V}$ per bit. The results are reported in volts.

The Aux input is differential (see Appendix C). The allowed input voltage range is ± 5 V with a differential input impedance of $500\ \text{k}\Omega$. The input bandwidth is $25\ \text{kHz}$.



Caution: Voltages outside the **AUX IN** range of ± 5 V could damage the Interface 5000 circuitry.

Temperature Monitor Signal

The Interface 5000 offers temperature testing in the range of -50 to 600°C . A $1000\ \Omega$ (at 0°C) platinum RTD (resistance temperature detector) according to European standard (DIN/IEC 60751 or simply IEC751) is used for the temperature measurement. The RTD sensor contains a resistor that changes resistance as its temperature changes. The RTD is excited with a precision $1\ \text{mA}$ current source. The A/D normally reads $1.000\ \text{V}$ when the RTD is at 0°C , and its resistance change is $3.85\ \Omega/^\circ\text{C}$ for the temperature range 0 to 100°C . Platinum RTD elements are available in two types of constructions: thin-film and wire-wound. Platinum RTDs offer several advantages:

- A wide temperature range (-50 to 500°C for thin-film, and -200 to 850°C for wire-wound)
- Good accuracy (better than thermocouples)
- Good interchangeability
- Not affected by corrosion or oxidation, and
- Long-term stability



Gamry will not calibrate an RTD you use. If you require higher accuracy for the temperature reading, you must perform an RTD calibration. Any manufacturer of the RTDs can perform such service. As an alternative, you may buy a more accurate RTD sensor, such as Class A, AA or 1/10DIN (temperature range permitted).

The RTD resistance is read using a two-terminal connection. The RTD is wired between Pins 3 and 4 of the Monitor Connector. A current source applies $1\ \text{mA}$ between these pins. A $\Sigma\Delta$ A/D converter continuously reads the voltage-difference between the pins.

Appendix D: Power LED Blink codes and Error Messages

Blink Codes

In the rare event that some electronics module fails, we include the start-up blink codes that the blue **PWR** LED flashes. Upon start-up, view the **PWR** LED. If it blinks more than five times, or flashes one of the blink-codes below, please call Gamry Instruments for service.

Normal Start-up

The **PWR** LED flashes four or five times.

Failure in an electronics module

The **PWR** LED flashes codes depending upon the failed module:

Problem	Power LED blink code
Post SDRAM unidentified problem	Twice, then once
Post SDRAM size error	Twice, then twice
Post ROM checksum error	Twice, then three times
Post Serial init. RX buffer	Three times, then four times
Post Serial init. TX buffer	Three times, then five times
Post Serial init. UART	Three times, then six times
Post Communications module missing	Three times, then eight times
Post Control missing	Four times, then once
Post potentiostat missing	Four times, then twice

If there are multiple problems, the communications board takes code priority over the memory module.

Severe problem

The red LED, which normally switches off after a rapid boot-up, remains illuminated.



If you receive one of the above codes, please call Gamry Instruments Service Department for assistance.

Error Messages and Limitations

The Interface 5000 has a subtype, Interface 5000P, which may generate error messages under certain run-time conditions.

Error Message This instrument is not authorized for Freq=

The Interface 5000P is able to perform EIS at frequencies 20 kHz or lower. Higher frequencies generate this error message. Decrease the upper frequency to continue.

Appendix E: Certifications



Declaration of Conformity: No. DOC-2018-CE-IFC5000

According to ISO/IEC Guide 22 and CEN/CENELEC EN 45014

Manufacturer's Name and Location:

Gamry Instruments
 734 Louis Drive
 Warminster, PA 18974
 USA

This declaration is for the Gamry Instruments product model: Interface 5000 Potentiostat/Galvanostat/ZRA
 The declaration is based upon compliance with the following directives:

- EMC Directive 2014/30/EU
- Low Voltage Safety Directive 2014/35/EU

The declaration is based upon product compliance with the following standards as defined in report number R0692-001 from Ergonomics, Inc. for safety analysis and report number R-2150P from Retlif Testing Laboratories, Inc. for EMC test and analysis.

EMC Standards	Title	Class/ Criteria
EN 61326-1:2013 Table 1	EMC – Electrostatic discharge, Immunity	B
EN 61326-1:2013 Clause 7.2	EMC – Emissions	A

Low Voltage Directive Safety Standards	Title
EN 61010-1:2010	Safety requirements for electrical equipment for measurement, control and laboratory use, Part 1: General requirements.

Signature

April 30, 2018

Date

Dr. Gregory A. Martinchek, PhD
 Title: President

Formal signed declaration is on file at Gamry, Inc.

Low Voltage Certificate of Conformance



PO Box 964 / Southampton, PA 18966
Phone: 800-862-0102 / 215-357-5124
Fax: 215-364-7582
e-mail: info@ergonomicsusa.com
website: www.ergonomicsusa.com

Certificate of Conformance

European Community Low Voltage Directive 2006/95/EC

Certificate Issued to:
Gamry Instruments
734 Louis Drive
Warminster, PA 18974
USA

Manufacturing Location:
Gamry Instruments
734 Louis Drive
Warminster, PA 18974
USA

This certificate is only issued for the products described and listed in Ergonomics, Inc. Report Number R0692-001

Product tested:
The product tested was model Interface 5000, serial number 5008. Consult the report for full range of products included in this certificate.

Issued by:
Ergonomics, Inc.
324 Second Street Pike
Southampton, PA 18966
USA

A handwritten signature in black ink that reads "David L. George".

David L. George, PE, Director

Applicable Standard:

EN 61010-1:2010 - Safety requirements for electrical equipment for measurement, control and laboratory use - Part 1: General Requirements.

Date of Issue: August 4, 2014

Certificate Number: 1475

RFI Certificate of Conformance

**CERTIFICATE OF CONFORMANCE
EUROPEAN COMMUNITY
COUNCIL DIRECTIVE 2004/108/EC**

Date of Issue: July, 2014
Issued By: Retlif Testing Laboratories
 3131 Detwiler Road
 Harleysville, PA 19438
Issued To: Gamry Instruments, Inc.
 734 Louis Drive
 Warminster, PA 18974
Reference: Retlif Report Number R-2150P

Retlif Testing Laboratories hereby acknowledges that compliance testing in accordance with the below listed standards was performed on a representative sample of the equipment listed below. Retlif Testing Laboratories further acknowledges that the test sample listed below was found to be in compliance with these standards. This certificate is hereby issued to the above named grantee and is valid only for the equipment identified below.

Manufacturer: Gamry Instruments, Inc.
 734 Louis Drive
 Warminster, PA 18974
Equipment Tested: Potentiostat / Galvanostat / ZRA
Model Number: Interface 5000
Serial Number: 50003
Brand Name: Gamry Instruments
Product Type: Measurement, Control Equipment and Laboratory Use

- Note(s):**
- 1) See attached report R-2150P for details and/or conditions pertaining to this certificate.
 - 2) Conforms to the emissions requirements of EN 61326-1:2013; Clause 7.2:

CISPR 11 Edition 5.0: 2009, A1: 2010	Conducted Emissions, Group 1, Class A
CISPR 11 Edition 5.0: 2009, A1: 2010	Radiated Emissions, Group 1, Class A
IEC 61000-3-2: 2005, A1: 2008, A2: 2009	Harmonics
IEC 61000-3-3: 2008	Flicker
 - 3) Conforms to the immunity requirements of EN 61326-1:2013; Table 1:

IEC 61000-4-2: 2008	Electrostatic Discharge
IEC 61000-4-3: 2006, A1: 2007, A2: 2010	Radiated Immunity
IEC 61000-4-4: 2004, A1: 2010	EFT/Burst, Power Ports and I/O Ports
IEC 61000-4-5: 2005	Surge Immunity, Power Ports
IEC 61000-4-6: 2008	Conducted Immunity, Power Ports and I/O Ports
IEC 61000-4-8: 2009	Power Frequency Magnetic Fields
IEC 61000-4-11: 2004	Voltage Dips and Interrupts



Declaration of Conformity: No. DOC-2021-UKCA-IFC5000

According to ISO/IEC 17050-1:2004 and CEN/CENELEC EN 45014

Manufacturer's Name and Location:

Gamry Instruments
734 Louis Drive
Warminster, PA 18974
USA

This declaration is for the Gamry Instruments product model: Interface 5000 Potentiostat/Galvanostat/ZRA
The declaration is based upon compliance with the following directives:

- Electromagnetic Compatibility Regulations 2016
- Electrical Equipment (Safety) Regulations 2016

EMC Regulations	Title	Class/ Criteria
EN 61326-1:2013	EMC – Electrostatic discharge, Immunity	B
EN 61326-1:2013	EMC – Radiated Emissions	A

Electrical Equipment (Safety) Regulations	Title
EN 61010-1:2010	Safety requirements for electrical equipment for measurement, control and laboratory use, Part 1: General requirements.

Signature

August 17, 2021

Date

Dr. Gregory A. Martinchek, PhD
Title: President

Formal signed declaration is on file at Gamry, Inc.

Appendix F: Heat in Interface 5000 Multichannel Systems

Introduction to Device Power-dissipation

All electronic devices require power to operate. In most cases, this power generates heat within the device. The simplest model for device power assumes the device can be modeled as a simple resistor across the power supply inputs. This simple, but often useful, model ignores the details of internal power supplies within the device, active circuitry, and power in I/O circuitry.

The power dissipated in a resistor is given by:

$$P = V \cdot I = I^2 R = \frac{V^2}{R}$$

P is power in watts, V is voltage in volts, I is current in amperes, and R is the resistance in ohms.

In this simple model, a device powered from +48 V with a power supply current of 0.1 A dissipates the same power as a 480 Ω resistor, that is, 4.8 W.

Normally the power-supply voltage is assumed to be constant, so a device's power depends on the current requirements which vary with the device's operating conditions.

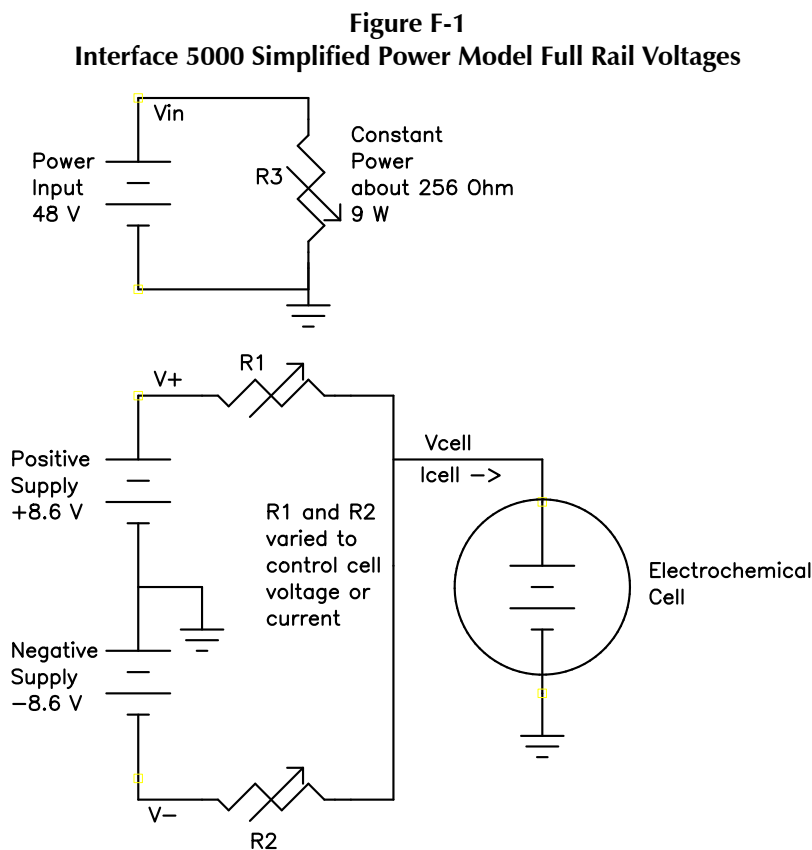

Potentiostat/Galvanostat Power Model

A potentiostat requires a somewhat more sophisticated power-dissipation model. A simple potentiostat power model is shown above. The electrochemical cell has a voltage V_{cell} that plays a role in the instrument's power dissipation.

The variable resistors take different values depending on the potentiostat/galvanostat's operating conditions. The upper portion of the model describes a fairly constant power draw in the Interface 5000 circuitry. This power comes from the normal operation of the instrument: running its microprocessor, powering its operational amplifiers and D/A and A/D converters, etc. There is some variability in this power depending on signal-levels in the analog circuitry, probably from 8.5 to 9.5 W, but we may assume 9 W.

The lower portion of the figure shows the power effects that come from the Interface 5000 power amplifier polarizing the electrochemical cell. This model assumes no power reduction as described below. V_+ and V_- are 8.5 V power supplies generated within the Interface 5000. R1 and R2 model the power MOSFET transistors that control current-flow through the cell.

When the cell current and cell voltage are both small, R1 and R2 have approximately equal values: about 42.5 Ω . This creates a steady-state current of about 200 mA through R1 and R2, resulting in "quiescent" power dissipation of a little less than 3.5 W.

The values of R1 and R2 change when current flows into or out of the cell. When +5 A flows into a zero-voltage cell, R1 is around 1.7 Ω and R2 becomes very large. In this condition, power-amplifier dissipation is 42.5 W and the total device power is about 51.5 W.

The Interface 5000's total power dissipation with the cell polarized is approximated by:

$$P = \frac{V_{in}}{R_3} + \frac{(V_+ - V_{cell})^2}{R_1} + \frac{(V_{cell} - V_-)^2}{R_2}$$

With large cell currents, the current from one leg of the circuit dominates power-amplifier dissipation, and total device power becomes:

$$P = \frac{V_{in}}{R_3} + (V_+ - V_{cell}) I_{cell}$$

or

$$P = \frac{V_{in}}{R_3} + (V_{cell} - V_-) I_{cell}$$

Note that V_{cell} can be either positive or negative.

The Interface 5000 contains a special power-reduction mode that limits power dissipation and temperature rise during discharge of energy-storage devices. The power-supply voltage on the MOSFET discharging the cell is lowered to approximately 2.3 V. In the discussion that follows, power and temperature are calculated both with the full power-supply voltage and the reduced voltage. Power dissipation within the Interface 5000 raises the temperature within the unit and on the exterior of the unit. In rare cases, the temperature increase can create an over-temperature event, upon which the unit shuts off the cell current and enters a protective latch-up state. You can only recover from this state by turning off the power on the Interface 5000, waiting for the device to cool, and turning the power back on.

Discharging a Battery

The highest power application for a potentiostat is discharging a battery or other energy-storage devices (such as an electrical double-layer capacitor or a fuel cell). In the calculations that follow, 9 W of load-independent power dissipation is assumed.

Let's look at the power in an extreme high-current battery discharge:

- With a single battery with a voltage of 6.5 V, the maximum power dissipation in the instrument assuming a -8.6 V power supply is $15.1 \text{ V} \times 5 \text{ A} + 9 \text{ W} = 84.5 \text{ W}$.
- With the same battery and reduced power-supply voltage of -2.3 V, the instrument's power dissipation is $8.8 \text{ V} \times 5 \text{ A} + 9 \text{ W} = 53 \text{ W}$.

Note that the maximum power drawn from the instrument's power **input** jack is largely independent of the cell voltage. The maximum output power is power-supply voltage times the maximum cell current. The higher power levels mentioned above occur because the battery is sourcing power. The output power plus the quiescent power of 9 W divided by the power-supply efficiency of about 75% gives us a maximum input power of 73 W.

Single Interface 5000

Gamry tested a single Interface 5000 operating at its most extreme working condition: discharge of a 6.5 V cell at 5 A current. The unit was run in its normal horizontal position, with 5 A cell current, and a 6.5 V cell voltage. The air-flow through the unit was unimpeded.

In this test, the unit could be operated with reduced power-supply rails indefinitely, with no over-temperature events seen, even with a 45°C ambient temperature. The highest temperature measured on the outside of the Interface 5000 chassis was 16°C above ambient.

Gamry has also tested a single Interface 5000 operating at its most absolute extreme condition. In this test, we discharged a 6.5 V cell at 5 A current using the normal power supply, 8.6 V. The total power dissipation under the test conditions was 84.5 W. The unit was run in its normal horizontal position with the air flow unimpeded. The ambient temperature was 25°C. An over-temperature event occurred in approximately 30 min. It caused the cell relay to open and stop the test.

If the same test was run at 45°C ambient temperature, the over-temperature event would have occurred sooner, most probably in less than 8 min.

Vertical Stacks

Gamry also tested a system with four Interface 5000s stacked one atop another (a vertical stack of horizontal units). In this configuration, the Interface 5000s run hotter, because power dissipation in one unit can radiate heat to adjacent units and also preheat the air used to cool other units. The units higher in the stack run hotter because their cooling air is preheated by the units below them. The cooling air entering the unit on the bottom of the stack is unheated, so this unit runs significantly cooler than all the others.

All four units ran in galvanostatic 5 A charge mode with a 0 Ω cell. No over-temperature events occurred during a three-hour test. The highest temperature measured on the outside chassis of the second from the bottom of the vertical Interface 5000 stack was 26°C above ambient.

Interface Power Hub Systems

The Interface Power Hub uses forced-air cooling to lower temperatures in stacked Interface 5000s. The units are turned 90° to run in an array of vertical instruments.

Gamry tested a system with eight Interface 5000s mounted in an Interface Power Hub. All units were operated at the following test condition: All eight units ran in galvanostatic 5 A charge mode with a 0 Ω cell and normal power-supply voltage of 8.6 V. The total power dissipation per unit was 52 W.

In this test, the system could be operated indefinitely with no over-temperature events seen, even with a 45°C ambient temperature. The top of the Interface Power Hub chassis got warm, but stayed at less than 20°C above ambient.

Appendix G: Optional Interface 5000 Monitor Board

Introduction

In order to monitor various different signals, you will need the Interface 5000 Monitor Board. This is an optional accessory that allows you to observe several different input signals, including an auxiliary input, among others.

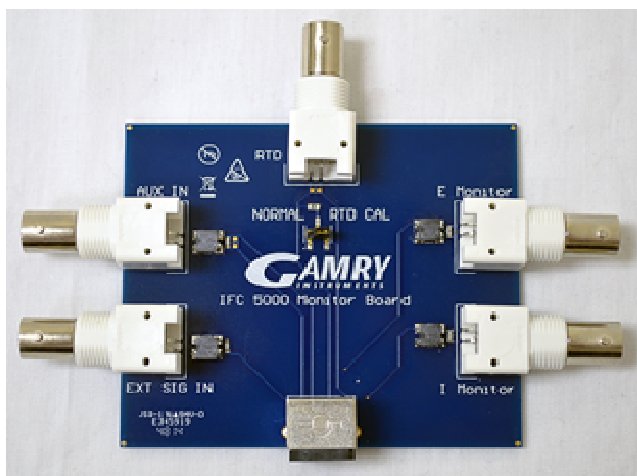

Connectors

There are six connectors on the Interface 5000 Monitor Board.

EXT SIG IN

The **EXT SIG IN** BNC connector allows you to add a voltage to the Interface 5000's signal generator. This signal is summed with the other signal-generator sources, including the IR DAC, the Scan DAC, and the DDS output.

The outer shell of the BNC is connected to the Interface 5000's floating ground.



Caution: The shell of the **EXT SIG IN** BNC is connected to the Interface 5000's Floating Ground. Connection of this BNC to a piece of earth-ground-referenced equipment can compromise the Interface 5000's ability to float, and invalidate data collected on earth-grounded cells.

The signal generator output is usually directly connected to the potentiostat's input. When the cell is turned on in potentiostat mode, the feedback is such that a negative signal-generator output creates a positive differential electrometer signal, which corresponds to a negative working electrode versus reference electrode voltage.

The polarity of the **EXT SIG IN** signal is inverted at the signal generator's output. As described above, a negative input signal on this BNC creates a positive change in the working electrode versus reference electrode voltage. The input impedance of this signal is 3 k Ω in parallel with 15 pF.

AUX IN

The **AUX IN** BNC connector allows you to measure a voltage from outside the Interface 5000 using the Interface 5000's internal A/D. The scaling is ± 3 V in equals $\pm 30\,000$ A/D counts. This is a resolution of 100 μ V per bit. The results are reported in volts.

The Aux input is differential (see Appendix C). The allowed input voltage range is ± 5 V with a differential input impedance of 500 k Ω . The input bandwidth is 25 kHz.



Caution: Voltages outside the **AUX IN** range of ± 5 V could damage the Interface 5000 circuitry.

Consult Appendix C for additional information concerning this connector.

E Monitor

The **E Monitor** BNC connector is the output of the Interface 5000's differential electrometer circuit. With the exception of the filtering described below, it is a buffered representation of the voltage difference between the white and blue cell cable leads. It has a high bandwidth.



Caution: The shell of the **E Monitor** BNC is connected to the Interface 5000's Floating Ground. Connection of this BNC to a piece of earth-ground-referenced equipment can compromise the Interface 5000's ability to float, and invalidate data collected on earth-grounded cells.

The outer shell of the BNC connector is connected to the Interface 5000's floating ground.

The **E Monitor** BNC connector is lightly filtered using an RLC circuit. It has a bandwidth of approximately 3 MHz when connected to a high-impedance input. This bandwidth is further reduced if a coaxial cable is connected to the BNC. Its output impedance is approximately 200 Ω in parallel with 220 pF.

I Monitor

The **I Monitor** BNC connector represents the output of the Interface 5000's current measurement circuit. With the exception of the filtering described below, it is the raw signal. It has high bandwidth on the less-sensitive current ranges. The effective bandwidth of the current signal falls as you reach the nA and pA current ranges. IE Stability capacitors further slow the response.



Caution: The shell of the **I Monitor** BNC is connected to the Interface 5000's Floating Ground. Connection of this BNC to a piece of earth-ground-referenced equipment can compromise the Interface 5000's ability to float, and invalidate data collected on earth-grounded cells.

The outer shell of this BNC connector is connected to the Interface 5000's floating ground.

Scaling on this signal is ± 3 V for \pm the nominal full-scale current on the selected current range. Cathodic currents cause a positive output voltage. If the software is auto-ranging the current-range selection, this signal is discontinuous at each range change.

The **I Monitor** BNC connector is lightly filtered using an RLC circuit. It has a bandwidth of approximately 3 MHz when connected to a high-impedance input. This bandwidth is further reduced if a coaxial cable is connected to the BNC. Its output impedance is approximately 200 Ω in parallel with 220 pF.

RTD

The **RTD** jack is used to connect an RTD to the Interface 5000. The Interface 5000 continually samples the **RTD** input during experiments when you select a stop-at test using a temperature variable.

Input (unlabeled)

The unlabeled input jack connects to the Interface 5000.

Appendix H: Index

- AC adapter, 9
- AC Adapter, 9, 16
- AC line cord, 10
- ADC channels, 56
- air-cooling, 11
- alligator clip, 39
- Aux In BNC, 71, 83
- auxiliary electrode, 38
- black banana, 38
- blink codes, 22, 73
- Blink Codes, 79
- blue cell lead, 38
- Cable calibration, 31
- Calibrate in Framework** button, 31
- calibration, 31, 32, 57, 61
- calibration data, 57
- CE Compliance, 14
- cell cable
 - replacements and specials, 39
 - ZRA connections, 40
- cell cables, 37
- cell connectors, 37
- Cell LED, 48
- Cell On LED, 48
- Chassis Ground, 10, 50
- cleaning, 12, 13
- computer, 16
- computer requirements, 20
- contract engineering, 3
- Control Overload, 48
- conventions
 - notational, 17
- Counter, 65
- counter electrode, 38
- Counter electrode, 37, 46
- Current Carrying Cable, 24
- Current Connector**, 37, 46
- Customization Label, 26, 27
- Customization Label Area, 49
- data storage, 57
- DC and AC calibration, 31
- DC Calibration, 31
- DC voltage, 58
- DDS, 55
- Declaration of Conformity, 75, 78
- Device Status Bar, 24
- double insulation, 9
- E Monitor BNC, 84
- E Overload, 48
- earth ground, 10
- electrical transients, 13
- enclosed space, 12
- environmental limits, 12
- environmental stress, 12
- Experiment** drop-down menu, 31
- External Signal, 70
- fan speed, 11
- Faraday shield, 39
- filters, 56
- firmware download, 47
- firmware update, 26
- floating ground, 38
- Floating Ground, 50
- floating ground binding post, 10
- Framework software, 15, 23, 24, 25, 28
- fuses, 37, 41, 42, 43, 44
- Gamry Framework, 15
- green cell lead, 38
- ground, 65, 66
- Help system, 15
- high speed USB, 51
- horizontal stack, 81
- I Monitor BNC, 84
- I Overload, 49
- inspection, 9
- installation, 19
- Instrument Manager, 25
- Interface 5000E, 27
- Interface 5000P, 27
- Interface Power Hub, 16, 81
- manual overview, 15
- Master, 68
- membrane cell connections, 41
- Monitor connector, 37, 62
- Monitor Connector**, 11, 47, 69, 71
- multichannel, 16, 17
- Multichannel, 16, 46
- multiple-potentiostat systems, 15, 16, 68
- operation, 12
- Options** menu, 24, 25
- orange lead, 38
- Overload LED, 48, 49
- over-temperature event, 80
- overview, 15
- personalization label, 27
- power brick, 9
- Power Connection, 21
- Power Cord, 21
- power dissipation, 79
- Power Dissipation, 79
- Power In**, 50
- Power In jack, 50
- Power LED, 73
- power line transient, 14

Power PC, 57
Power switch, 22, 45
power-up test, 22
PWR LED, 22, 45, 46, 47
radio frequency, 13
red cell lead, 38
reference electrode, 38
Reference Electrode, 66
RF interference, 13
RoHS Compliance, 14
safety, 9
schematic, 53
Sense Cable, 24
Sense Connector, 37, 46, 66
Serf, 68
service, 13
service contract, 3
shielding against noise, 10
software calibration, 59
software installation, 20, 21
specifications, 59
state-machine, 56
static electricity, 13
storage, 12
support, 3
Sync port, 16
Sync Port, 52, 68
Synch Port, 68
telephone assistance, 3
temperature, 11
USB cable, 23
USB LED, 24, 47, 51
USB port, 51
USB Processor, 57
User I/O connector, 11, 51
Visual Inspection, 19
Warranty, 3
white cell lead, 38
Windows, 4
Work Shield, 65
Working, 65
working electrode, 38
Working electrode, 37, 39, 46
ZRA
 cell connections, 40