



Advanced Test Equipment Corp.

www.atecorp.com 800-404-ATEC (2832)

HIPOTRONICS 

Product Catalog

2021

Printed: 02/24/2021

Table Of Contents

Portable Equipment

Oil Testers - 60kV Series	3
Oil Tester - 90kV Series	5
Cable Fault Locators - Portable Primary - X-Wave	7
Cable Fault Locators - Portable Primary - CF30 Series	9
Cable Fault Locators - Vehicle Mounted - CF70 Series	11
High Voltage Couplers - HVC4000 Series	13
Cable Fault Location Accessories - Cable Racks	15
Phase Tracing Systems - PTC Series	17
Open/Short Locators - WB20 Series	19
DC Hipots - Digital Interface - 800PL Series	21
DC Hipots - HIPODirect Mobile App	23
DC Hipots - Analog Interface - 800PL Series	24
DC Hipots - Modular with Analog Interface - 8000PL Series	26
DC Hipots - Modular with Analog Interface - 8175PL Series	29
AC Hipots - HVT-DI Series	32
AC Hipots - HIPODirect Mobile App	34
AC Hipots - HVT-DI Control Upgrade	35
Vacuum Bottle Tester - 7BT60 Series	37
AC/DC Hipots - HD100 Series	39
AC/DC Hipot with Megaohmmeter - H306 Series	41
Megaohmmeter - HM3A Series	43
Megaohmmeters - HVM Series	45
AC/DC Kilovoltmeters - KVM Wireless Series	47
AC/DC Kilovoltmeters - KVM Series	49

Standard AC Dielectric Test Sets

Breakdown Test Sets - D149-DI Series	51
Breakdown Test Sets - D149 Controls Comparison Chart	53
AC Dielectric Test Sets - 700-DI Series	54
AC Dielectric Test Sets - 700-DI 3-Phase Series	58
Partial Discharge Test Sets	60

OEM & Custom High Voltage Products

DC Transformers - Power Packs	62
Isolation Transformers	64
Motor Test Sets - MTS Series	66
Peschel Variable Transformers - PVT Series	68
DC Power Supplies - 800 Series	76
High Current DC Power Supplies - 801 Series	78

OC60-DI

Digital Liquid Dielectric Tester – 60kV

The OC60-DI Liquid Dielectric Tester accurately and reliably tests the dielectric strength of insulating liquids used in a wide variety of electrical apparatus. The rugged, lightweight, and portable design ensures years of safe and trouble-free operation both in the field and in the laboratory.

This model is designed to meet testing specifications from all parts of the world with test cells available for ASTM D877, ASTM D1816 and IEC 156 testing standards. The OC60-DI gives the user the ability to use pre-programmed standards in basic mode or create their own tests using custom mode. An internal digital kilovoltmeter automatically records the breakdown voltage for each test sample. Each test can be saved into the unit's internal memory and transferred to a USB drive. Embedded printer available, consult factory.

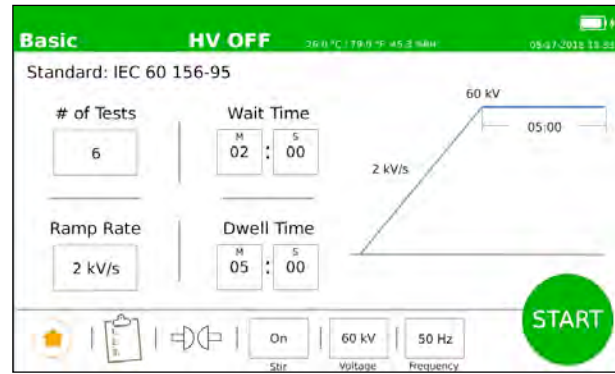

FEATURES

- Lightweight and portable** design; **Rugged and reliable** construction
- Automatic Breakdown Detection** within 4 μ s of Breakdown Point
- Preprogrammed Test Standards**
- Breakdown Voltage** \pm 2% of full scale
- Test cells available for **ASTM D877, ASTM D1816** and **IEC 156** testing
- Record and Transfer test results and data analysis via **USB2.0**
- 7" color, touch screen display** with adjustable brightness
- Safe operation with slide screen magnetic interlock**
- Adjustable test parameters** such as target voltage, ramp rate, dwell and wait time

BENEFITS

- Multi-purpose** compact design for field and factory
- Sturdy and Reliable** for a long trouble-free life
- User Friendly** Touchscreen Interface
- Battery Operated** for testing in the field
- Ease to share results** via USB transfer or embedded printer (optional)

APPLICATIONS



Testing of insulating liquids in:

- Transformers and Bushings
- Switchgear
- Capacitors
- Hydraulics

TECHNICAL SPECIFICATIONS

Model Number		OC60-DI
System Output		0 – 60kV AC
Voltage Breakdown Accuracy		±2% of full scale
Dimensions (W x H x D)	Net	16 x 13 x 15in (41 x 33 x 38cm)
	Shipping	24 x 19 x 21in (61 x 48 x 53cm)
Weight	Net	60lbs (25kg)
	Shipping	65lbs (28kg)
Input Voltage & Frequency		90-264VAC; 50 or 60Hz
Internal Battery		NiMH, 12VDC, 8,400mAh
Included Accessories		Input Cord, Calibration Certificate, Operations Manual
Languages		English, French, German, Mandarin, Spanish, Portuguese
Preloaded Standards		ASTM D1816, JIS C 2101-99, ASTM D1816, SEV EN 60156, ASTM D1816, UNE EN 60156, ASTM D877, NF EN 60156, ASTM D877, SABS EN 60156, BS EN 60156, VDE 0370 Part 5, CEI EN 60156, AS 1767.2.1, IRAM 2341, GOST 6581-75, BS148, IS 6792
ECCN: 3A992.A		HTS : 9027.80.4560

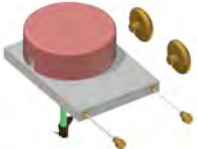
OPTIONAL EQUIPMENT & ACCESSORIES

Part Number	Description	Shipping Dimensions (W x H x D)	Weight	
			Net	Shipping
OC-TC	Translucent test cell for OC60-DI. No electrodes included.	6 x 6 x 6in (15 x 15 x 15cm)	3lbs (1.4kg)	8lbs (3.6kg)
TC-1816-KIT 	Electrode Test Kit for ASTM D1816 . Includes motor-driven circulating system and two VDE electrodes. Electrodes are installed into the OC-TC test cell. 0.08 and 0.04 inch gap gauges are supplied.	6 x 6 x 6in (15 x 15 x 15cm)	2lbs (1kg)	7lbs (3kg)
TC-156-KIT 	Electrode Test Kit for IEC 156 . Includes two VDE electrodes. Electrodes are installed into the OC-TC test cell. 0.1 inch gap gauge is supplied.	6 x 6 x 6in (15 x 15 x 15cm)	1.5lbs (0.7kg)	6.5lbs (2.8kg)
TC-877-KIT 	Electrode Test Kit for ASTM D877 . Includes two flat disc electrodes. Electrodes are installed into the OC-TC test cell. 0.1 inch gap gauge is supplied.	6 x 6 x 6in (15 x 15 x 15cm)	1lbs (0.5kg)	6lbs (2.7kg)
OCCM-E	Calibration Cell: Digital Calibration and ramp rate meter. Digital display (0.5 inch), molded epoxy case, and 2% accuracy at full scale.	6 x 6 x 6in (15 x 15 x 15cm)	4lbs (2kg)	8lbs (4kg)
EXT-WARN-1	One-year extended warranty			

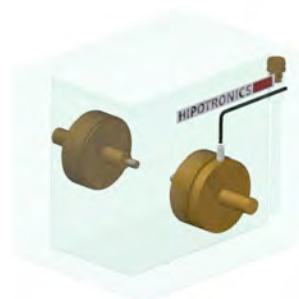

Test Cell: OC-TC

OC90D

Liquid Dielectric Test Sets with Manual Control - 90 kV



■ The OC90D Liquid Dielectric Test Set accurately and reliably tests dielectric strength of insulating liquids used in a wide variety of electrical apparatus. The rugged, lightweight and portable design ensures years of safe and trouble-free operation both in the field and in the laboratory.

This series is designed to meet testing specifications from all parts of the world with test cells available for ASTM D877, and ASTM D1816 testing standards. Each unit also includes three pre-programmed rates of voltage rise and automatic termination of high voltage upon sample breakdown. A digital memory kilovoltmeter automatically records the breakdown voltage for each test sample. A 60kV AC model, OC60-DI, is available with digital interface controls.

90kV Test Set



FEATURES

- ☑ **Environmental friendly FR3™** transformer oil
- ☑ **Lightweight and portable** design
- ☑ **Rugged and reliable** construction
- ☑ **Automatic high voltage shutdown** at breakdown point
- ☑ **Digital** memory kilovoltmeter
- ☑ **Meter accuracy** ± 2% of full scale
- ☑ **Safety interlocked** high voltage section
- ☑ Test cells available for **ASTM D877, ASTM D1816** and testing

BENEFITS

- Multi-purpose** compact design for field and factory.
- Sturdy and Reliable** for a long trouble free life
- Easy** to use integrated controller.

APPLICATIONS

Testing of insulating liquids in:

- Transformers
- Bushings
- Switchgear
- Capacitors
- Hydraulics



TECHNICAL SPECIFICATIONS

Model Number		OC90D-*
System Output		0 - 90kV
Meter Accuracy		±2% of full scale
Dimensions (W x H x D)	Net	30 x 12 x 17 in (76 x 30 x 43 cm)
	Shipping	30 x 20 x 20 in (76 x 51 x 51 cm)
Weight	Net	122lbs (55kg)
	Shipping	190lbs (86kg)
Input Voltage & Frequency		* In the model number, designate 'A' for 120V/60Hz input or 'B' for 230V/50 Hz input
Harmonized Tariff Code		9030.33.0040
ECCN		3A992.A
Included Accessories		Input Chord (7.5ft/2.3m), Calibration Certificate, Operations Manual

SYSTEM CONTROLS

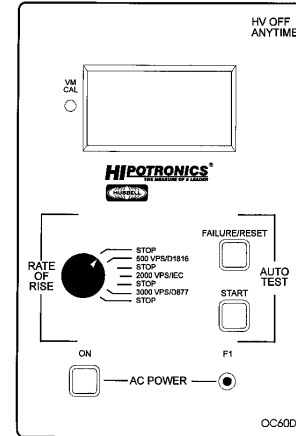

OPTIONAL EQUIPMENT & ACCESSORIES

Part Number	Description	Dimensions (W x H x D)	Weight	
			Net	Shipping
TCCE90	Test Cell: Contains VDE mushroom electrodes and motor driven circulating system (ASTM D1816). disc electrodes with 0.1 inch gap gauge are supplied (ASTM D877).	13 x 6 x 6 in (33 x 15 x 15 cm)	11 lbs (5 kg)	20 lbs (9 kg)
OCCM-E	Calibration Cell: Digital Calibration and ramp rate meter. Digital display (0.5 inch), molded epoxy case, and 2% accuracy at full scale.	6 x 6 x 6 in (15 x 15 x 15 cm)	4 lbs (2 kg)	8 lbs (4 kg)
SPK1-OC90D	Spare Parts Kit for OC90D			
EXT-WARN-1	One year extended warranty			

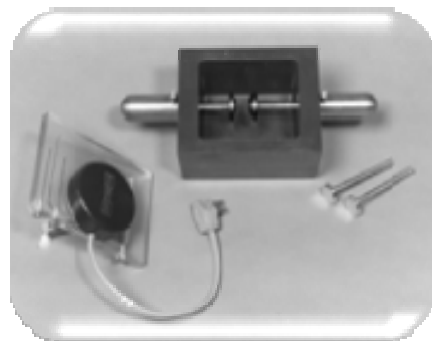

Test Cell: TCCE90
ASTM D877
ASTM D1816
(pictured left)

X-Wave

Primary Cable Fault Locator

■ The **HIPOTRONICS X-WAVE** is the most safe, powerful, and advanced cable fault-locating tool on the market for sectionalizing Underground Residential Distribution (URD) loop feed installations.

This self-contained, battery operated and weather-proof fault locator is equipped with a microprocessor-based control system, as well as large push buttons for user-friendly operation. The emergency stop button, isolated return, and unique mechanical design ensure user safety.

The X-WAVE is specifically designed to shorten restoration time and increase productivity for a wide range of customers.



FEATURES

- ☑ **Automatic identification** of cable length and fault distance
- ☑ **Quick fault location**
- ☑ **Accessible internal memory** for cable trace storage
- ☑ **Large LCD display**
- ☑ **Intuitive step-by-step instructions**
- ☑ **Multi-Language** options
- ☑ **Large, easy-to-use** buttons
- ☑ **Adjustable output** from 500V - 10kV DC

BENEFITS

- Isolated return and secure grounding** ensure safe operation.
- Multi-purpose device** with the ability to pre-locate, locate and diagnose cable faults.
- Easy to use controls** guide user through test procedure.
- USB port** to download waveforms and evaluate test results.
- Reduce outage time** by quickly locating cable faults and restoring power.
- Reduce cable damage** with TDR pre-location technology.

APPLICATIONS

These devices are generally used by:

- Electrical Utilities
- Test Companies
- Petrochemical
- Mining Facilities
- Facility Maintenance



TECHNICAL SPECIFICATIONS

Model Number		X-WAVE
System Output		500V - 10kV, 12.5mA (max)
Pulse	Amplitude	160V, 50Ω
	Width	50 - 400nsec
Maximum Energy		350J
Repetition Rate		6 sec @ max voltage
Sampling Rate		80MHz
Accuracy		± 1% of total cable length
Cable Range		50ft - 10,000ft (15m - 3km)
Operational Modes		Arc Reflection (High Voltage TDR)
		Direct TDR (Low Voltage TDR)
		DC Hipot
		Capacitive Discharge/Impulse (Thump)
Display		Trans-Reflective, mono-chrome LCD monitor, 6.5 in (16.5cm)
Battery	Duration	Minimum 1hr continuous use @ max voltage
	Type	24V DC, Rechargeable
Temperature	Operating	10°F - 122°F (-12°C - 50°C)
	Storage	-40°F - 140°F (-40°C - 60°C)
Dimensions (W x H x D)		16.5 x 17.5 x 9 in (41.9 x 44.5 x 22.9 cm)
Weight	Net	42lbs (19kg)
	Shipping	50lbs (22.5kg)
Included Accessories		High Voltage Output & Ground Cables, 15ft (3m) Battery Charging Cable, 100/240V, 6ft (1.8m) User's Manual Calibration Certificate

SYSTEM CONTROLS



NOW AVAILABLE:

Click Here For [Product Demo Video!](#)

See our [YouTube Channel](#)

ADDITIONAL EQUIPMENT & ACCESSORIES

Part Number	Description
X-WAVE-BATTERY	Extra Auxiliary Battery Pack
X-WAVE-POWER	Auxiliary AC Power Adapter (Allows users to run the equipment while charging simultaneously.)
EXT-WARN-1	One year extended warranty

CF30-8

Primary Cable Fault Locator



■ **HIPOTRONICS CF Series** test systems for fault locating of primary cables consist of a dc proof tester, a burner and a capacitive discharge fault locator (thumper). These self-contained, portable units are rugged, reliable and compact making them ideal for field use. The CF30-8 has a continuously adjustable impulse rate from three to thirty seconds. Test ratings are a 30 kV dc proof test voltage, a 50 mA burn current and a 0-15 kV dc capacitive discharge (thumper) voltage.

The units can be used with a high voltage coupler (4100 Series) and a time domain reflectometer (TDR) to quickly provide a specific distance to the fault in feet or meters. This combination of equipment can greatly reduce the amount of high voltage (number of thumps) the cable resulting in reduced damage or degradation to the cable under test.

HIPOTRONICS has years of experience in cable fault locating the toughest faults. Our line of cable fault locating equipment is designed and manufactured based upon our field expertise. Whether you use the fault locator alone or with other accessories you've got a powerful tool to help restore power to your customers quicker.



FEATURES

- ☑ **Self-Contained Unit** Features Proof Tester, Burner and Thumper in One
- ☑ Burn Currents to **50 mA**
- ☑ **Internal discharge solenoid**
- ☑ Impulse Energies of up to **900 J**
- ☑ **Automatic and Manual** Thumper Mod
- ☑ **External interlock** provisions
- ☑ Operable from **Line Voltage or Generator**
- ☑ **Single HV Output Cable**
- ☑ **Mode Indicator Lights**

BENEFITS

- **Accurate Fault Identification and Location**
- **One Unit for all URD Cable Maintenance Testing**
- **User Safety** - visual verification of grounding status via face panel window
- **Repeatable Impulse level**
- **Variable Impulse Rate from 3 to 30 Seconds**

APPLICATIONS

- Electric Utilities
- Test Companies
- Petrochemical Facilities
- Facility Maintenance

TECHNICAL SPECIFICATIONS

Model Number		CF30-8*	CF30-8-PT*
DC Proof Test		30 kV	
Burner		50 mA	
Capacitance		8uF @ 15kV	
Controlled Energy		900 J @ 15 kV	
Duty Cycle		Continuous, 7 pulses per minute	
Metering Accuracy	Proof Test Voltage	±2%	
	Proof Test Current	±2%	
Terminations	Input Line	10 ft (3.1m) cable	
	Return to High Voltage	50 ft (15.2 m) shielded cable - vise grip	15ft (4.5m) of shielded cable, MC type connector for use with our HVC Coupler & 8100 Cable Rack
	Ground	10 ft (3.1m) No. 2 cables with vice grip	
Input Voltage & Frequency		* In the model number, designate 'A' for 120V/60Hz input or 'B' for 230V/50Hz input	
Dimensions (W x H x D)		16 x 30 x 16 inches (40.6cm x 76.2cm x 40.6cm)	
Shipping Dimensions		30 x 28 x 38 inches (76 x 71 x 96.5 cm)	
Weight	Net	185lbs	
	Shipping	250lbs	
Included Accessories		Qty. 1 CF30-8 with terminations as described above Qty. 1 Interlock Plug (PN800661) Qty. 1 Operations Manual Qty. 1 Calibration Certificate	

ADDITIONAL EQUIPMENT & ACCESSORIES

Part Number	Description
SPK1-CF30-8	Spare Parts Kit
TDR1150/1170	Time Domain Reflectometer
HVC4100 Series	High Voltage Coupler to protect TDR from high voltage & energy of cable fault locator.
8100	High Voltage Cable Rack with 125 ft of 70 kV cable and 125 ft of safety ground cable.
EXT-WARN-1	One year extended warranty



TDR 1170
(pictured right)

CF70 -12 / -24

Primary Cable Fault Locator



■ **HIPOTRONICS CF Series** test systems for fault locating of primary cables consist of a dc proof tester, a burner and a capacitive discharge fault locator (thumper). These self-contained, portable units are rugged, reliable and compact making them ideal for field use. The CF70-12 or -24 has a continuously adjustable impulse rate from three to thirty seconds. Test ratings are a 0-70 kV dc proof test voltage, a 100 mA burn current and a 0-25kV dc capacitive discharge (thumper) voltage.

The units can be used with a high voltage coupler (HVC-4100 Series) and a time domain reflectometer (TDR-1150 or TDR-1170) to quickly provide a specific distance to the fault in feet or meters. This combination of equipment can greatly reduce the amount of high voltage (number of thumps) applied to the cable, resulting in reduced damage or degradation to the cable under test.

HIPOTRONICS has years of experience in cable fault locating the toughest faults. Our line of cable fault locating equipment is designed and manufactured based upon our field expertise. Whether you use the fault locator alone or with other accessories you've got a powerful tool to help restore power to your customers quickly.



FEATURES

- ☑ **Self-Contained Unit** Features Proof Tester, Burner and Thumper in One
- ☑ **Burn Currents** to 100 mA
- ☑ **Impulse Energies** of up to 7000 Joules
- ☑ **Automatic and Manual** Thumper Mode
- ☑ **Operable** from Line Voltage or Generator
- ☑ **Single HV Output** for All Modes
- ☑ **Zero Start** Interlock
- ☑ **External** Interlock
- ☑ **Mode Indicator** Lights
- ☑ **Electrically Operated** Shorting Solenoids with Mechanical Ground Assurance

BENEFITS

- Positive Fault** Identification and Location
- Isolated Return** for Increased Operator Safety
- One Unit** for all URD Cable Maintenance Testing
- User Safety** – visual verification of grounding status via face panel window
- Repeatable Impulse** level
- Variable Impulse Rate** from 3 to 30 Seconds

APPLICATIONS

- Electrical Utilities
- Test Companies
- Petrochemical Facilities
- Facility Maintenance

TECHNICAL SPECIFICATIONS

General

Input Voltage & Frequency:	* In the model number, designate 'A' for 120V/60Hz input or 'B' for 230V/50Hz input		
Output:	Proof Tester, 0-70 kV dc	Burner, 100 mA	
Capacitor Discharge:	CF70-12, 0-25kV @ 12 μ F	Energy @ 25kV	3750 joules
	CF70-24, 0-25kV @ 24 μ F	Energy @ 25kV	7000 joules
Metering:	Proof Test Voltage	0-70 kV dc \pm 2%	Standard Polarity
	Proof Test Leakage Current	0-1/10/100 mA \pm 2%	Negative Output.
	Burner Current	0-100 mA	
Duty Cycle:	Continuous		
Terminations:	Input Line	50 ft. (15.2 m)	Cable
	Return and High Voltage	100 ft. (30.4 m)	Double Shielded Cable
	Ground	Ground 25 ft. (7.6 m)	No. 2 Welding Cable
Weight and Dimensions shipping	16"W x 36"H x 50"D (41 x 91 x 127cm) 675 lb (307 kg) Net		894 lb (352 kg)

SCOPE OF SUPPLY

- Qty.1 CF70-12 or -24 with terminations as described above
- Qty.1 Safety interlock plug
- Qty.1 Operations Manual
- Qty.1 Calibration Certificate

ORDERING INFORMATION

System

Cable Fault Locator	CF70-12-A or B CF70-24-A or B
Cable Fault Locator with only 15 feet of return and HV cable and MC type connector for use with HVC series coupler and 8100 cable rack.	CF70-12-PT-A or B CF70-24-PT-A or B

CONTROL PANEL



Accessories

Spare parts kit for CF70	SPK1-CF70-12 SPK1-CF70-24
Time Domain Reflectometer	TDR1150 TDR1170
HV Coupler for use with the TDR	HVC4170
Cable Reels	8100

HVC4000 Series

High Voltage TDR Couplers

■ **The 4000 Series** of high voltage couplers allow modern cable fault locators (thumpers) to be used in conjunction with advanced TDR's. The HVC series is uniquely suitable for use with cable fault locators with voltage ratings up to 70kV. When connected to a cable fault locator and a TDR, the coupler enables the operator to reduce his "thumping" and reduce the chances of potential damage by extended duration "thumping". The HVC series allow for the use of the latest methods of fault location and also allow the operator to use a TDR mode that is most suitable for the cable that has failed. The HVC series also allows for quick connection of a low voltage TDR.



FEATURES

- ☑ **Compact** High Voltage Coupler
- ☑ **Compatible** with Virtually all Cable Fault Locators
- ☑ **Interlock Safety** on Mode Selector Switch
- ☑ **Front Mounted** Mode Selector Switch
- ☑ **Female MC** High Voltage Input Connector
- ☑ **Male MC** High Voltage Output Connector
- ☑ **Available** for Use with Thumpers up to 70kV

BENEFITS

- Female MC Connector** – for easy connection of thumpers
- HV Output Cable** – rated for voltages of 70kV DC
- Couple Advanced TDR's** – to Standard Thumpers
- Compact** – User Friendly Design
- Low Voltage** – TDR Compatible

TECHNICAL SPECIFICATIONS

General	HVC 4100 -*	HVC 4170CR-*
Cabinet Configuration	Rack Mounted (cabinet)	Rack Mounted (cabinet)
TDR Mounting Configuration	Internal	Internal
Input Voltage & Frequency	*In the model number designate 'A' for 120V AC/60Hz or 'B' for 230V/50Hz	
High Voltage Range	0-50kV DC	0-70kV DC
Arc Reflection Voltage Range	0-40kV DC	0-40kV DC
Surge Voltage Range	0-50kV DC	0-50kV DC
Maximum Burn Current	100 Amps	100 Amps
Maximum Impulse Energy	3000 Joules	8000 Joules
Temperature Range	-4°F to 122°F (-20°C to 50°C)	-4°F to 122°F (-20°C to 50°C)
Dimensions	31"H x 26"W x 31"D (79cm x 66cm x 31cm)	54"H x 26"W x 31"D (79cm x 66cm x 31cm)
Weights	100lbs (45kg)	250lbs (114kg)

ACCESSORIES

TDR 1170, Time Domain Reflectometer
 TDR 1150, Time Domain Reflectometer
 CET 2000-* Controlled Energy 2000J Thumper
 CF30-8-*, 0-15kV, 900J Hipot/Thumper
 CF70-12-*, 0-25kV, 3750J Hipot/Thumper
 CF70-24-*, 0-25kV, 7000J Hipot/Thumper

ORDERING INFORMATION

System	
0-50kV coupler	HVC 4100-A or -B
0-70kV coupler	HVC 4170CR-A or -B

8100/8100W

Cable Rack

■ The Model 8100 High Voltage Cable Rack provides a user with 125 feet of High Voltage Cable and 125 feet of Ground Cable. Used in conjunction with most cable fault locators (Thumpers) and HVC Couplers, the 8100 provide a convenient and flexible device to safely and quickly make connections to cables under test. The High Voltage cable is terminated with an MC connector to allow for either a locking plier connection or another accessory such as those listed on the back of this sheet. The ground cable is terminated with a standard grounding clamp which can be used with a shotgun stick. A pigtail is available to retrofit most thumpers to this cable rack system or our HVC series of couplers. Please consult your representative for further details.



FEATURES

- ☑ **125 Feet** of High Voltage Cable
- ☑ **125 Feet** of Ground Cable
- ☑ **High Voltage** Cable Reel
- ☑ **Ground** Cable Reel
- ☑ **Female MC** High Voltage Connector
- ☑ **Mounting Rack** for Cable Reels
- ☑ **Two Wheel** Hand Truck for 8100W

BENEFITS

Female MC Connector – for easy connection of HV couplers and thumpers

HV Output Cable – rated for voltages of 70kV DC

Ground Cable – flexible welding cable with safety grounding lugs every 10 feet

TECHNICAL SPECIFICATIONS

General

High Voltage Cable	125 feet (38m)	Rated for 70kV DC
Ground Cable	125 feet (38m)	4 gage 600V welding cable

Weights and Dimensions

17"W x 17"D x 35"H (43 x 43 x 89cm) Unit weight, 82lbs (37kg), Shipping weight, 175lbs (80kg)

ACCESSORIES

- Catalog number 8530, Elbow Adapter
- Catalog number 8526, Bushing Adapter
- Catalog number 8527, Bushing Adapter
- Catalog number 8540, Locking plier

ORDERING INFORMATION

System

Cable Rack	8100
Cable Rack with Wheels	8100W
Pig Tail Output Cable	8100PT

ADAPTERS

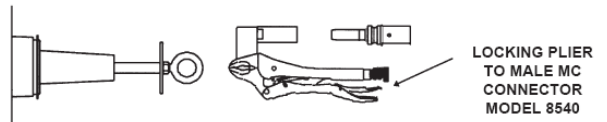
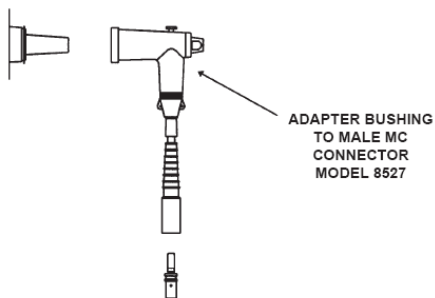
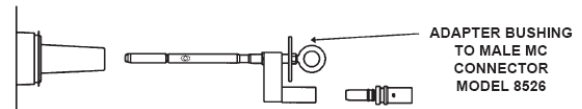
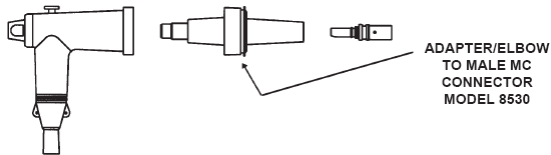

PTC Series

Cable ID & Phase Tracing System

■ The PTC Series Phase Tracing System is ideal for identifying individual phases of three-phase direct buried or conduit installed cable. The PTC Series is designed to positively identify cable phases at a point where many cables come together. Such as cable used in power circuits, feeders and distribution networks. This device will also identify each individual phase in three-phase power cable.

This Phase Tracing System has three major components: a pulse transmitter, pulse detector and pick up coil. It's recommended that the cable is disconnected from any load impedance and the three-phase conductors are tied together and grounded at the far end. However, this device will operate in a satisfactory manner while connected to low impedance loads.



FEATURES

Transmitter

- ☑ **Continuously adjustable** output current
- ☑ **Low operating voltage**
- ☑ **Output current meter**
- ☑ **Input circuit breaker switch** with ON pilot light

Detector

- ☑ **High gain** transistor amplifier circuit
- ☑ **Sensitive pickup coil**
- ☑ **Rotary switch with OFF** and five sensitivity levels
- ☑ **50 division meter** to indicate relative strength of signal

BENEFITS

Effective phase identification on shielded, unshielded and lead-jacketed cable.

Complete, compact and portable system for simple and quick use in the field.

Minimal setup time and simple control panel.

APPLICATIONS

- Electrical Utilities
- Test Companies
- Petrochemical Facilities
- Facility Maintenance

TECHNICAL SPECIFICATIONS

Model Number		PTC2-*	
System Output		0-30V @ 30A	
Pulse	Shape	Square Wave (Fig. 2)	
	Width	830 msec	
Repetition Rate	Continuous	1, 2 or 3 pulses per 5 sec in A, B & C Phases (Fig. 1)	
	Intermittent	A-Phase	12 pulses per 1 min & 2 pulses per 5 sec (Fig. 2)
		B-Phase	24 pulses per 1 min & 2 pulses per 5 sec (Fig. 2)
C-Phase	Reciprocal of A and B in return leg (Fig. 2)		
Dimensions (W x H x D)	Transmitter	12 x 7.5 x 12.25 in (30.5 x 19.1 x 31.1 cm)	
	Detector	6.75 x 6 x 3.5 in (17.1 x 15.2 x 8.9 cm)	
	Pick-Up Coil	2.5 x 2.75 x 2.5 in (6.4 x 7 x 6.4 cm)	
Weight	Transmitter	Net	41 lbs (18.6 kg)
		Shipping	52 lbs (23.6 kg)
	Detector	Net	4 lbs (1.82 kg)
		Shipping	8 lbs (3.6 kg)
	Pick-Up Coil	Net	1.75 lbs (.8 kg)
		Shipping	4 lbs (1.8 kg)
Input Voltage & Frequency		* In the model number, designate 'A' for 120V/60Hz input or 'B' for 220V/50Hz input	

SYSTEM DIAGRAM

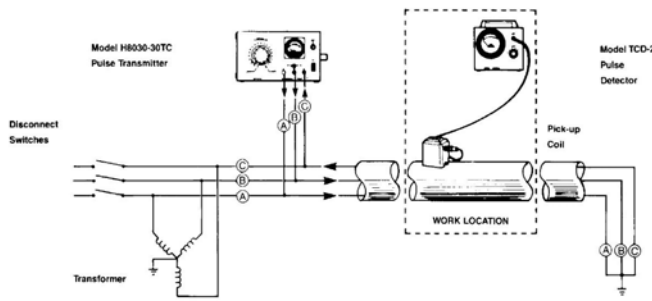

Fig.1: Test Set-Up

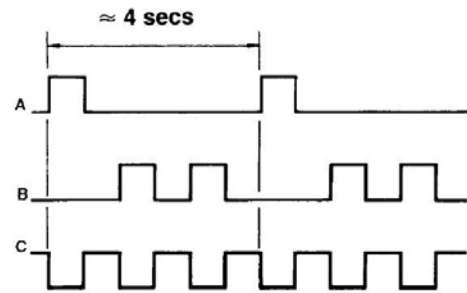

Fig.2: Repetition Rate per Phase

OPTIONAL EQUIPMENT & ACCESSORIES

Part Number	Description	Input Voltage & Frequency
8030TC-*	Extra Transmitter (30V, 3A) & Test Lead	* In the model number, designate 'A' for 120V/60Hz input or 'B' for 220V/50Hz input
8012TC-*	Extra Transmitter (12V, 30A) & Test Lead	
TCD2A	Extra Detector	N/A
8030-LS	Extra Test Leads	
EXT-WARN-1	One year extended warranty	

WB20 Series

Open & Short Locator

■ The WB20 Series are highly accurate instruments designed to detect opens and shorts in various types of cable. This instrument can detect opens in individual conductors and shorts between neighboring conductors of various type cable.

To locate opens, the WB20 will determine the position of a break in one wire (out of a pair) using a 0 to 1 kV AC power supply. This unit can also locate shorts as well as act as a high voltage bridge. The unit locates the position of a short between a pair of wires using a 0-20 kV DC power supply. The short can be due to a copper cross, high resistance or an infinite resistance high voltage arc.

This unit has built-in safety features which requires operator to be at the control panel holding the High Voltage ON button to provide a high voltage output for either open or short locating. The WB20 also features a zero start interlock that ensures the voltage controls are turned to zero before the high voltage transformer is energized.

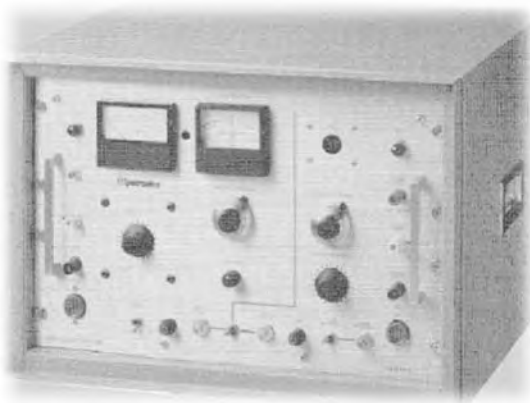

FEATURES

- ☑ **High Voltage Hold** ensures user safety
- ☑ **Ground meters** guard against shock
- ☑ **Phase Reversal Switch**
- ☑ **Zero Start Interlock**
- ☑ **Gravity Operated Solenoid** - Discharges the test object when the power is turned off. This provides added safety for the operator and theWB20CB.

BENEFITS

Three tests in one unit – Tests for discontinuities (OPENS) in either conductor in a pair of conductors and locates the position of existing SHORTS between the two conductors. Also capable of performing a DC proof test.

Variable HV output – Allows the location of low and high resistance shorts not possible with low voltage Time Domain Reflectometers (TDR s).

Rack Mountable – Easy installation into a 19” rack

NIST traceable – significant cost savings on outside calibrations

APPLICATIONS

- ➔ Telephone cable
- ➔ Power cable
- ➔ Any cables with shielded grounds

TECHNICAL SPECIFICATIONS

Model Number		WB20CB-*
System Output (V)	AC Voltage (OPENS)	0-1kV @ 20mA
	DC Voltage (SHORTS)	0-20kV @15mA
DC Polarity		Negative Output, Positive Ground
Metering: Type, Accuracy		4.5" analog meters, $\pm 2\%$ full scale accuracy
Kilovoltmeter (SHORTS)	Voltage	0-20kV
	Range	Single
	Accuracy	$\pm 2\%$ of full scale
Null Indicator (SHORTS)	Voltage	0 \pm 25mV DC
	Type	Zero Center
Balance Control (SHORTS)		0.25% Potentiometer, 10 turn
Dimensions (W x D x H)		22 x 30 x 15 in (55 x 50 x 37cm)
Weight	Net	90lbs (41kg)
	Shipping	105lbs (48kg)
Input Voltage & Frequency		* In the model number, designate 'A' for 120V/60Hz input or 'B' for 220V/50Hz input

SYSTEM CONTROLS



OPTIONAL EQUIPMENT & ACCESSORIES

Part Number	Description
SPK1-WB20CB	Spare Parts Kit for WB20
EXT-WARN-1	One-year extended warranty

800PL-HD SERIES

Digital DC Hipot Testers – 80kV & 40kV



The 800PL-HD Series Hipot is a modern solution for testing the insulation strength of electrical apparatus. Outfitted with a state-of-the-art digital interface, and extensive safety features, this robust unit ensures simplistic operation, accurate results, and operator safety under all circumstances. The 800PL-HD's heavy-duty design is the perfect solution for tests that require long duty cycle.

The 800PL-HD Series features the most accurate kilovoltmeter readings regardless of load current. Voltage measurements are taken directly at the output of the high voltage transformer, while current is measured at the return leg to ensure the highest accuracy.



FEATURES

- Tests up to 40kV or 80kV** at load current of 10mA
- Portable, rugged design** for field use with wheels
- Multiple measurements** including output voltage, leakage current, insulation resistance (IR), and polarization index (PI)
- Adjustable test parameters** such as target voltage, maximum leakage current, ramp rate, and dwell time
- Record and view test results** in the internal memory
- 7" color touchscreen display** with adjustable brightness
- Internal discharge solenoid**

BENEFITS

- Simple to Use** with minimal amount of setup time and intuitive control panel allows for simple testing
- Sturdy and portable** design
- User-friendly** touchscreen interface
- Easy to share results** via USB transfer
- Safe operation** with interlock and emergency stop

APPLICATIONS

Brief Description

- | | |
|---|---|
| <input checked="" type="checkbox"/> Motors | <input checked="" type="checkbox"/> Electrical Switchgears |
| <input checked="" type="checkbox"/> Generators | <input checked="" type="checkbox"/> Vacuum Interrupters |
| <input checked="" type="checkbox"/> Bucket Trucks | <input checked="" type="checkbox"/> Aerial Lift Equipment |
| <input checked="" type="checkbox"/> Transformers | <input checked="" type="checkbox"/> Insulated Electric Apparatus & Components |
| <input checked="" type="checkbox"/> Power Cables | |

TECHNICAL SPECIFICATIONS

Model #		840PL-HD	880PL-HD
System Output	Voltage	0.4 – 40kV	0.4 – 80kV
	Current	10mA	
	Polarity	Negative Output, Positive Ground	
Voltage & Current Measurement Accuracy		± 1.5% of Reading ± 0.2% F.S.	
Voltage Resolution		100V	
Current Resolution		0.1µA	
Insulation Resistance Measurement Range		10kΩ – 40GΩ	
IR Accuracy		±1% of scale	
IR Resolution		10kΩ	
Input		90-264VAC, 45-65Hz, 900VA	
Duty Cycle		1 hour ON / 1 hour OFF	
Dimensions (W x D x H)	Net	20in x 14in x 20in (50cm x 35cm x 51 cm)	
	Shipping	24in x 19in x 23in (61cm x 48cm x 58cm)	
Weight	Net	78lbs (36kg)	
	Shipping	91lbs (42kg)	
Safety Features		Emergency Stop Visual Warning Indicators External Interlock Audible Warning Indicator	Interlock Hand-switch (optional) External Warning Lamp (optional) Interlock Foot Pedal (optional)
Display		7" TFT , 800 x 480, Color Touch Screen	
Interfaces		USB 2.0 for Memory Stick	
Output Data Format		CSV	
Calibration Interval		1 year recommended	
Languages		English, Spanish, Portuguese, French, German, Mandarin	
ECCN: 3A992.A		HTS: 9030.39.0100	

	Electronic Components		High Voltage Components	
	Temperature	Humidity (r.h. non-condensing)	Temperature	Humidity (r.h. non-condensing)
Operation	-10°C ... +50°C	5 ... 95%	-10°C ... +50°C	5 ... 90%
Storage	-20°C ... +70°C	5 ... 95%	-20°C ... +55°C	5 ... 90%

SCOPE OF SUPPLY

25ft HV output cable with clamp
 25ft HV return cable with clamp
 25ft HV ground with clamp
 6ft input power cord
 Manual and calibration certificate

STANDARD OPTIONS

HHDA13-280 – 120kV rated grounding stick
HH-HS-DI – Hand operated interlock switch
HH-FS-DI – Foot operated interlock switch
HH-WARN-DI – Safety Strobe light with magnetic base
EXT-WARN-1 – One-year extended warranty

HIPODirect

Mobile App for HVT-DI series and 800PL-HD series

HIPODirect is HIPOTRONICS software app solution to wirelessly connect a mobile device to WiFi-direct capable products. Once connected the software can show product details, as well as view and download test reports. Once downloaded, the test reports can be easily shared in CSV format via e-mail or by uploading them to any cloud service. HIPODirect is also capable of downloading and installing the latest firmware available on any Hipotronics products connected via the software app.

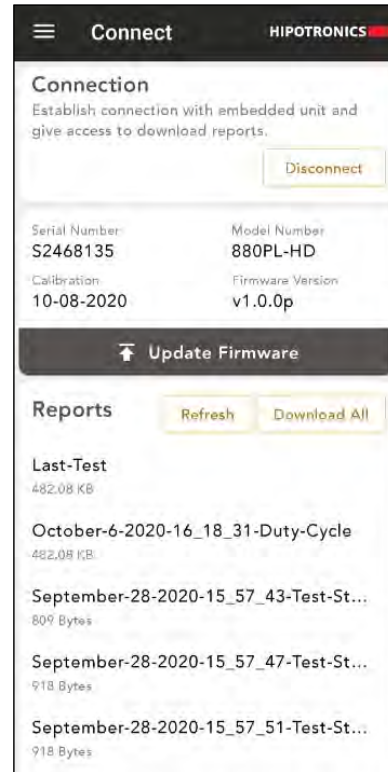
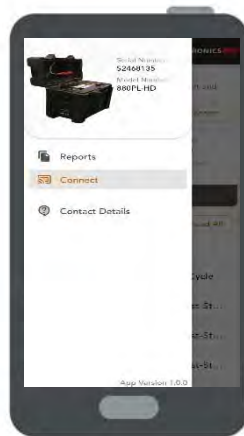

FEATURES

- Friendly and intuitive** user interface
- Share test reports in CSV format** via e-mail or by uploading them to an online cloud
- View test report details** right on the app! Max voltage, max current, elapsed time, voltage and current graphs
- Update Hipotronics equipment** to the latest firmware available
- 800PL-HD series and HVT-DI series compatible.** Soon to include additional product lines.
- Compatible with Android OS (iOS coming soon!).** Available to download from Google Play Store.



800 Series

DC Hipot Testers - 120kV & 170kV



■ The **800 Series** DC Hipot Testers is an economical solution to DC field testing of cables, terminations, motors, generators and other electrical apparatus. All models are self-contained in a one or two-piece, rugged and durable enclosure. Each is complete from input line cord to high voltage output cable. This product range includes models in 120kV and 170kV DC.

The 800 Series features accurate kilovoltmeter readings regardless of load current. Voltage measurements are taken directly at the output of the high voltage transformer, while current is measured at the return leg to ensure the highest accuracy. Safe discharging of both the test object and internal transformer occur whenever high voltage is switched off. Output power is created through a full-wave, voltage doubling, silicon rectifier circuit.



*One-Piece Design for 15kV & 80kV models
Controller for 120kV & 170kV models*

FEATURES

- ☑ **Environmental friendly FR3™** transformer oil
- ☑ **Rugged and portable** construction
- ☑ **Shielded** output cable
- ☑ **Full-wave** voltage doubling rectifier
- ☑ **Zero start interlock** and **guard circuit**
- ☑ **Internal discharge solenoid**
- ☑ **Meter accuracy** ± 2% full scale
- ☑ **5-10 mA** current rating
- ☑ **External interlock** provisions
- ☑ **Three range** voltage meter
- ☑ **Four range** current meter
- ☑ **No internal leakage** at full load
- ☑ **Instantaneous** overload relay
- ☑ **Surge-limiting resistors** in High Voltage output

BENEFITS

Ideal for field testing applications.

Automatic grounding of power supply and test object when high voltage is turned OFF.

Minimal setup time and simple control panel.

Accurate current measurement and guard circuit designed to eliminate stray leakage currents.

APPLICATIONS

- Cable
- Transformers
- Electrical Switchgear
- Motors
- Generators
- Other Electrical Apparatus



TECHNICAL SPECIFICATIONS

Model Number		8120-5PL-*	8170-5PL-*	
System Output (V)		0 - 120kV DC	0 - 170kV DC	
System Output (A)		5mA	5mA	
Polarity		Negative Output, Positive Ground		
Metering Accuracy		±2% of full scale		
Ripple		Less than 2.5%		
Dimensions (W x H x D)	Controller	16.5 x 9 x 18 in (42 x 23 x 46 cm)		
	High Voltage Section	12 x 10 x 19 in (30 x 25 x 48 cm)	12 x 10 x 30 in (30 x 25 x 75 cm)	
Weight	Controller	Net	25 lbs (11 kg)	
		Shipping	35 lbs (16 kg)	
	High Voltage Section	Net	102 lbs (46 kg)	145 lbs (66 kg)
		Shipping	122 lbs (55 kg)	165 lbs (75 kg)
Input Voltage & Frequency		* In the model number, designate 'A' for 120V/60Hz input or 'B' for 230V/50Hz input		
Included Accessories		Input Cord, 6 ft (1.8 m)		
		Return Cable, 25 ft (7.6 m)		
		Interlock Plug		

SYSTEM CONTROLS



High Voltage Section
(pictured right)



OPTIONAL EQUIPMENT & ACCESSORIES

Part Number	Description
HHDA13-280	Grounding Stick, 120kV Max Voltage
SPK1-8120-5PL	Spare Parts Kit for 8120-5PL
SPK1-8170-5PL	Spare Parts Kit for 8170-5PL
EXT-WARN-1	One year extended warranty



HHDA13-280 Grounding Stick
(pictured above)

8000 PL Series

60 kV Module Portable DC Hipot Testers

■ **The 8000PL Series** DC Hipot Testers offer a 60 to 300 kV range in a convenient cascade design. These systems are air insulated, with each module individually capable of producing 60 kV at 16 mA. The standard power rating is 2 kW. Low leakage measurement, even with fluctuating line voltage, is possible with the 1% line regulator. The design also offers reversible polarity.

This modular (expandable) construction favors the use of these portable testers in situations formerly requiring large mobile units. For example, when field-testing, each technician can be equipped with one controller and as many modules as routine tests require. Then, for any non-routine higher voltage tests, additional modules may be assembled at the test site. For example, a 240 kV test requires one controller and four modules. Each unit consists of a control case and one or several 60 kV modules up to the required voltage. For expansion above three modules, a HV expansion kit is required. This kit contains an anti-corona toroid rated for up to 300 kV, plus base extension legs and guy straps for support. The lightweight fiberglass control case includes all operating controls and meters, plus storage area for the base grounding probe, output resistor, and interconnecting cables.



FEATURES

- ☑ **Expandable** from 60 kV to 300 kV
- ☑ **Rugged, portable and modular** construction
- ☑ **High current** output for testing large loads
- ☑ **Reversible polarity**
- ☑ **Ripple <0.2% per mA**
- ☑ Analog kilovolt and current meters
- ☑ **Zero start interlock** and external interlock provisions for safety during operation
- ☑ **Anti-corona** toroid
- ☑ **Compact control** unit allows remote positioning ideal for field use
- ☑ **Momentary current reversal switch**
- ☑ **Optional high voltage shorting solenoid**

BENEFITS

Ideal for field testing – lightweight, compact, and rugged make it suitable for field testing

Quick and Easy - a modular system limits the setup time and user-friendly controls make it simple to use

Modular Construction - bring only the number of modules necessary for the required voltage

Easily Transportable - Air-insulated modules make it light weight and simple to transport in a van or pickup truck

Accurate Leakage Current Measurements -while guard circuit eliminates stray leakage currents

APPLICATIONS

DC Hipot testing of:

- **Cable**
- **Electrical switchgear**
- **Motors**
- **Generators**
- **Other electrical apparatus**

CONTROL PANEL

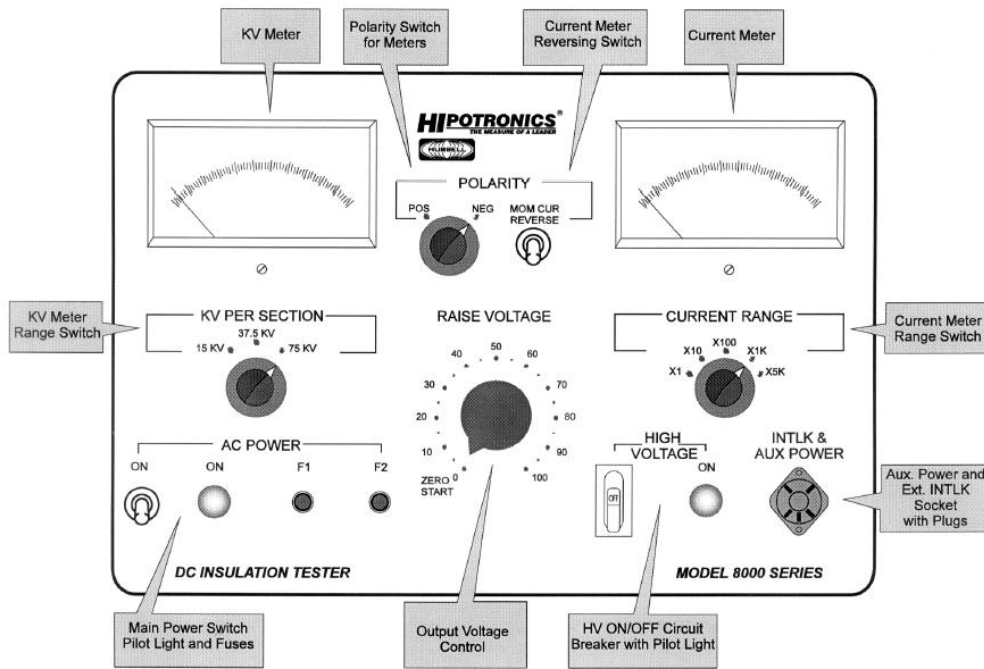

MODULE ASSEMBLY

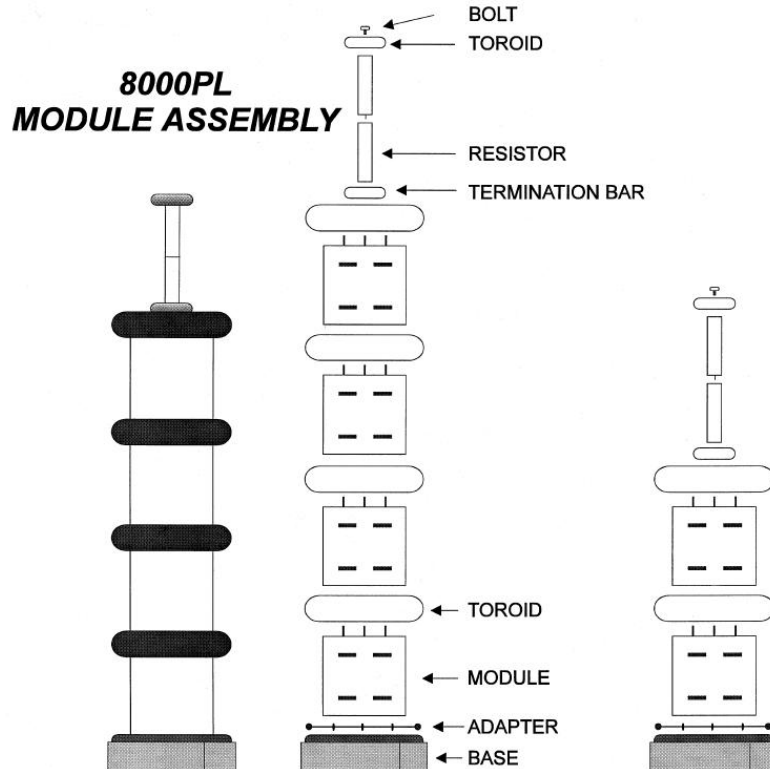

TECHNICAL SPECIFICATIONS

General

Model Number	8060PL	8120PL	8180PL	8240PL	8300PL
Input Voltage & Frequency	* In the model number, designate 'A' for 120V/60Hz input or 'B' for 230V/50Hz input				
Number of Modules	1	2	3	4	5
Output Voltage (kV DC)	60	120	180	240	300
Output Current (mA)	16	8	5.5	4.1	3.3
Duty Cycle	Continuous				
Output Polarity	Reversible				
Output Ripple	< 0.2% per mA				
Metering	± 2% Full Scale Accuracy				

Weights and Dimensions (W x H x D, net weight, ship weight)

Controller	22" x 22" x 12" (560 x 560 x 310 mm)	69 lbs (31 kg)	79 lbs (36 kg)
Module	9¼" x 16¼" x 10½" (240 x 410 x 270 mm)	58 lbs (26 kg)	68 lbs (31 kg)

SCOPE OF SUPPLY

- Qty. X 8KPL-MOD 60 kV Module (quantity depends upon model number)
 - Qty. 1 8KPL-CONT Controller
 - Qty. 1 DA13-280 Ground stick, 120 kV max
 - Qty. 1 8KPL-EXT-HV HV expansion Kit#
 - Qty. 1 Epoxy Resistor Qty. 1 Input Line Cord, 10 ft (3 m)
 - Qty. 2 Ground Cable, 15 feet (4.6 m)
 - Qty. 1 Interconnection Cable, 30 feet (9.1 m)
 - Qty. 1 Calibration Certificate
 - Qty. 1 User's Manual
- # Supplied ONLY with 8180PL, 8240PL and 8300PL

ORDERING INFORMATION

System

60 kV, 16 mA DC Hipot	8060PL-*
120 kV, 8 mA DC Hipot	8120PL-*
180 kV, 5.5 mA DC Hipot	8180PL-*
240 kV, 4.1 mA DC Hipot	8240PL-*
300 kV, 3.1 mA DC Hipot	8300PL-*

Accessories

DC Hipot Controller, 8000PL Series	8KPL-CONT
60 kV Module Kit	8KPL-MOD
High Voltage Expansion Kit	8KPL-EXT-HV
Ground stick, 120 kV max.	DA13-280
Shorting Switch, 175 kV - 1 MV	8175-SS
Line Regulator, 1%, 2 kW	8KPL-LR2

8175 PL Series

175 kV Modular Portable DC Hipot Testers

■ The 8175PL Series DC Hipot Testers The 8175PL Series dc hipot testers offer a 175 kV to 875 kV range in a convenient cascade design. These systems are SF6 insulated with each module individually capable of producing 175 kV at 17 mA. The standard power rating is 3 kW. Low leakage measurement, even with fluctuating line voltage, is possible with the standard 1% line regulation. The design also offers reversible polarity.

This modular (expandable) construction favors the use of these portable testers in situations formerly requiring large mobile units. For example, when field testing, each technician can be equipped with one controller and as many modules as routine tests require. Then, for any non-routine higher voltage tests, additional modules may be assembled at the test site. A reusable shipping container is provided for each module for storage and transportation.



FEATURES

- ☑ **Expandable** from 175 kV to 875 kV
- ☑ **Rugged, light weight, portable** modular construction
- ☑ **High current** output for testing large loads
- ☑ **Reversible polarity**
- ☑ **Ripple <0.2% per mA**
- ☑ Analog kilovolt and current meters
- ☑ **Zero start interlock** and external interlock provisions for safety during operation
- ☑ **Anti-corona** toroid
- ☑ **Compact control** unit allows remote positioning ideal for field use
- ☑ **Momentary current reversal switch**
- ☑ **Optional high voltage shorting solenoid**
- ☑ **Reusable shipping containers** for modular storage

BENEFITS

- Quick and Easy** - a modular system limits the setup time and user-friendly controls make it simple to use
- Modular Construction** - bring only the number of modules necessary for the required voltage
- Easily Transportable** - SF6 insulated modules make it light weight and simple to transport in a van or pickup truck
- Accurate Leakage Current Measurements** -while guard circuit eliminates stray leakage currents

APPLICATIONS

- DC Hipot testing of:
- **Cable**
 - **Electrical switchgear**
 - **Motors & Generators**
 - **Other electrical apparatus**

CONTROL PANEL

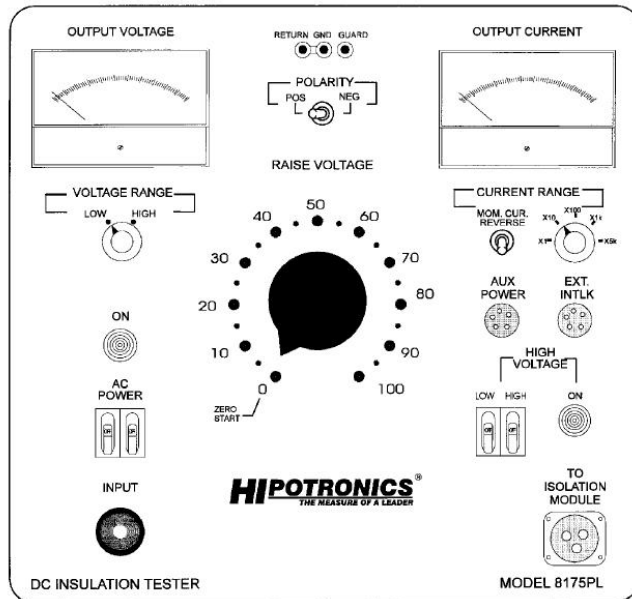

MODULE ASSEMBLY

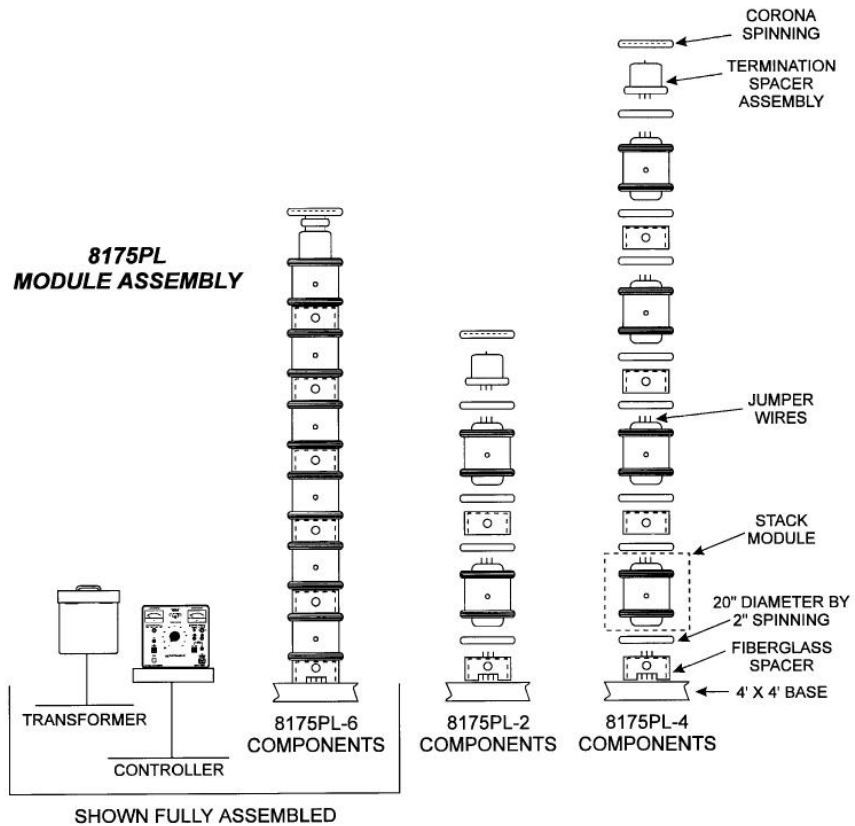

TECHNICAL SPECIFICATIONS

General

Model Number	8175PL-1	8175PL-2	8175PL-3	8175PL-4	8175PL-5
Input Voltage / Frequency	230V, 50/60Hz				
Number of Modules	1	2	3	4	5
Output Voltage (kV DC)	175	350	525	700	875
Output Current (mA)	17	8.5	5.7	4.3	3.4
Duty Cycle	15 minutes on / 1 hour off				
Output Polarity	Reversible				
Output Ripple	< 0.2% per mA				
Voltmeter	0-100 kV dc and 0-200 kV dc				
Ammeter	0-5 / 50 / 500 μ A 5 / 25 mA				
Accuracy	\pm 2% Full Scale Accuracy				

Weights and Dimensions (W x H x D, net weight, ship weight)

Controller	20" x 11" x 15" (508 x 279 x 381 mm)	125 lbs (56.8 kg)	135 lbs (61.4 kg)
HV Section	18" x 26" x 18" (457 x 660 x 457 mm)	180 lbs (81.8 kg)	320 lbs (14.5 kg)
Isolation Transformer	20" x 15" x 20" (508 x 381 x 508 mm)	125 lbs (56.8 kg)	135 lbs (61.4 kg)

SCOPE OF SUPPLY

Qty. X	8175-MOD 175 kV Module (quantity depends upon model number)
Qty. 1	8175-CONT Controller and Isolation Transformer
Qty. 1	R5160A Resistor, 285 kohm, 7 kJ
Qty. 1	8175-RES DC Hipot Resistor Support Kit#
Qty. 1	8175-EXT-HV HV expansion Kit#
Qty. 1	Input Line Cord, 10 feet (3 m)
Qty. 1	Extension Cord, 40 feet (12.2 m)
Qty. 1	Interconnection Cable, 10 feet (3 m)
Qty. 1	Calibration Certificate
Qty. 1	User's Manual # Supplied ONLY with 8175PL-4 and 8175PL-5

ORDERING INFORMATION

System

175 kV, 15 mA DC Hipot	8175PL-1
350 kV, 8.5 mA DC Hipot	8175PL-2
525 kV, 5.7 mA DC Hipot	8175PL-3
700 kV, 4.3 mA DC Hipot	8175PL-4
875 kV, 3.4 mA DC Hipot	8175PL-5

Accessories

Controller kit with controls and isolation transformer	8175-CONT
175 kV Module Kit with module, spinning, insulator separator, resistor section and module interconnect leads	8175-MOD
High Voltage Expansion Kit	8175-EXT-HV
Resistor Support Kit	8175-RES
Resistor 285 k ohm, 7 kJ	HHR5160A
Shorting Switch, 175 kV - 1 MV	8175-SS
Lifting Tongs	8175-LFT

HVT-DI SERIES

Digital AC Hipot Testers – 30kV, 60kV, 100kV, & 120kV



The HVT-DI Series AC Hipot Testers are the most modern digital solution to AC field-testing of bucket trucks, aerial platforms, vacuum interrupters, breakers, switchgear, and other electrical apparatus. Each model includes a portable digital controls section and bonnet and is complete with an input line cord, interconnecting cable and ground leads.

The 120kV model is specifically designed for ANSI/SIA A92.2 specification procedures for testing insulating booms on work platforms and bucket trucks. Whereas, the 30kV and 60kV models are designed to perform quick and accurate AC dielectric tests. In addition, the 100kV model is designed for higher output current, up to 100mA at the 50kV tap. The HVT Digital series assures accurate voltage and current measurements using a high voltage divider and double current meter in the return leg of the high voltage transformer. A guard circuit prevents stray or surface leakage from being measured by the current meter. To ensure safe operation the unit is equipped with a fast-acting fuse, an external interlock, and E-Stop.

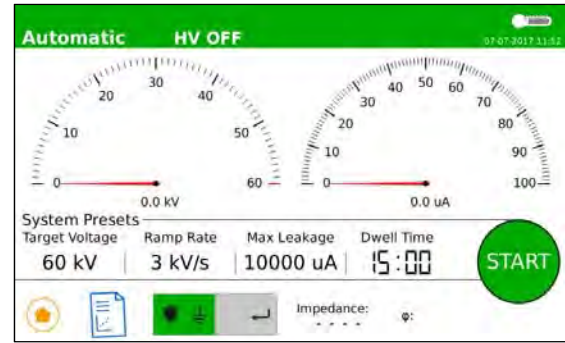

FEATURES

- Lightweight, rugged design** for field use with wheels
- Environmentally friendly** FR3™ transformer oil
- Multiple measurements** including output voltage, leakage current, impedance, and phase angle
- Adjustable test parameters** such as target voltage, maximum leakage current, ramp rate, and dwell time
- Record and view test results** in the internal memory
- 7" color touchscreen display** with adjustable brightness
- Most accurate current measurement** and guard circuit designed to eliminate stray leakage currents
- Meets ANSI/SIA A92.2** test specifications

BENEFITS

- Simple to Use** with minimal amount of setup time and intuitive control panel allows for simple testing
- Sturdy and portable** design
- User-friendly** touchscreen interface
- Easy to share results** via USB transfer
- Safe operation** with interlock and emergency stop

APPLICATIONS

Brief Description

- Aerial Platform
- Bucket Trucks
- Hydraulic hoses
- Hot Sticks, Gloves, and Ropes
- Switchgears, Vacuum bottles, and Vacuum Interrupters



TECHNICAL SPECIFICATIONS

Model #		30HVT-DI	60HVT-DI	120HVT-DI	100HVT-DI
System Output	Voltage	0.4 – 30kV	0.4 – 60kV	1 – 120kV	1 – 100kV
	Frequency	50/60Hz			
	Current	10mA			50mA (100kV tap) 100mA (50kV tap)
Current Ranges (auto)		0 - 100µA / 0.1 – 10mA			0 - 1000µA, 0.1 – 100mA
Voltage & Current Measurement Accuracy		± 1.5% of Reading ± 0.2% F.S.			
Voltage Resolution		100V			
Current Resolution		0.1µA			
Voltage Divider Location		Internal or External			External
Partial Discharge		n/a			≤10pC at <30kV
Phase Angle		± 10°			
Input		90 – 265VAC, 50/60Hz			
Duty Cycle		5min ON / 5min OFF, repeated maximum of 6 times, then OFF for 2hrs			
Dimensions (W x D x H)	Controller	20in x 14in x20in (50cm x 35cm x 51 cm)			
	Bonnet	12in x 11in x 12in (31cm x 28cm x 31cm)	14in x 12in x 14in (36cm x 31cm x 36cm)	17in x 14in x 32in (43cm x 36cm x 81cm)	
Weight	Controller	35lbs (16kg)			
	Bonnet	30lbs (14kg)	80lbs (37kg)	135lbs (62kg)	
Safety Features		Emergency Stop Visual Warning Indicators External Interlock Audible Warning Indicator		Hand Operated Interlock Switch (optional) External Warning Lamp (optional) Foot Operated Interlock Switch (optional)	
Display		7" TFT , 800 x 480, Color Touch Screen			
Interfaces		USB 2.0 for Memory Stick			
Output Data Format		CSV			
Calibration Interval		1 year recommended			
Languages		English, Spanish, Portuguese, French, German, Mandarin			
ECCN: 3A992.A			HTS: 9030.39.0100		

Notes: The partial discharge level is inherent to the equipment itself without considering possible external radiated interference from the customer's dedicated mains power supply or ground noise.

	Electronic Components		High Voltage Components	
	Temperature	Humidity (r.h. non-condensing)	Temperature	Humidity (r.h. non-condensing)
Operation	-10°C ... +50°C	5 ... 95%	-10°C ... +50°C	5 ... 95%
Storage	-20°C ... +70°C	5 ... 95%	-20°C ... +70°C	5 ... 95%

SCOPE OF SUPPLY

Controller and HV transformer
 25ft HV interconnect cable with clamp
 25ft HV return cable (BNC)
 15ft HV ground cable
 6ft input power cord
 Interlock plug
 Voltmeter probe (100kV and 120kV models)
 USB drive with digital copy of manual
 Calibration certificate

STANDARD OPTIONS

HHDA13-280 – 120kV rated grounding stick
HH-VMP60 – 60kV rated voltmeter probe for HVT-DI series
HH-VMP120 – 120kV rated voltmeter probe for HVT-DI series
HH-HS-DI – Hand operated interlock switch
HH-FS-DI – Foot operated interlock switch
HH-WARN-DI – Safety Strobe light with magnetic base
HH-CART-DI – Hand cart to move HVT-DI controller and bonnet
EXT-WARN-1 – One-year extended warranty

HIPODirect

Mobile App for HVT-DI series and 800PL-HD series

HIPODirect is HIPOTRONICS software app solution to wirelessly connect a mobile device to WiFi-direct capable products. Once connected the software can show product details, as well as view and download test reports. Once downloaded, the test reports can be easily shared in CSV format via e-mail or by uploading them to any cloud service. HIPODirect is also capable of downloading and installing the latest firmware available on any Hipotronics products connected via the software app.

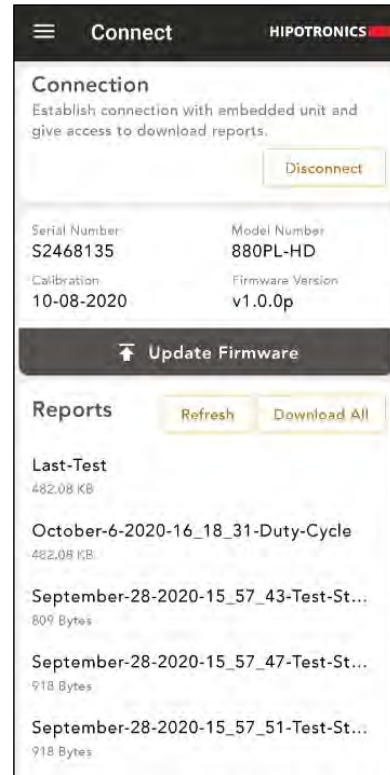
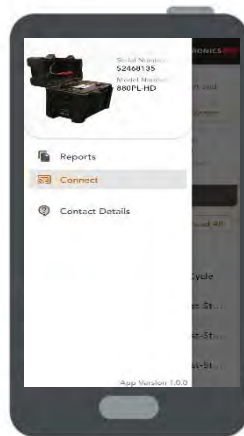

FEATURES

- Friendly and intuitive** user interface
- Share test reports in CSV format** via e-mail or by uploading them to an online cloud
- View test report details** right on the app! Max voltage, max current, elapsed time, voltage and current graphs
- Update Hipotronics equipment** to the latest firmware available
- 800PL-HD series and HVT-DI series compatible.** Soon to include additional product lines.
- Compatible with Android OS (iOS coming soon!).** Available to download from Google Play Store.



HVT-DI-UPG

Digital AC Hipot Testers Control Upgrades – 30kV, 60kV, 100kV, & 120kV

The HVT-DI Series AC Hipot Testers are the most modern digital solution to AC field-testing of bucket trucks, aerial platforms, vacuum interrupters, breakers, switchgear, and other electrical apparatus. With HIPOTRONICS latest DI controller, customers can now upgrade their older Analog AC hipots with a better solution for high voltage AC testing.

The following Hipotronics models can be upgraded:

120HVT-A, 100HVT-B, 60HVT-A, 60HVT-B, 30HVT-A, 30HVT-B. Upgrades to other supplier's comparable AC hipots are possible, please consult factory.

Hipotronics upgrades include:

- Portable digital controls in rugged field case.
- Voltmeter probe that is calibrated to the new controls.
- HIPODirect compatible for wireless data transfer and firmware downloads.

The HVT Digital series upgrades assures accurate voltage and current measurements. A guard circuit prevents stray or surface leakage from being measured by the current meter. To ensure safe operation the unit is equipped with a fast-acting fuse, an external interlock, and E-Stop.

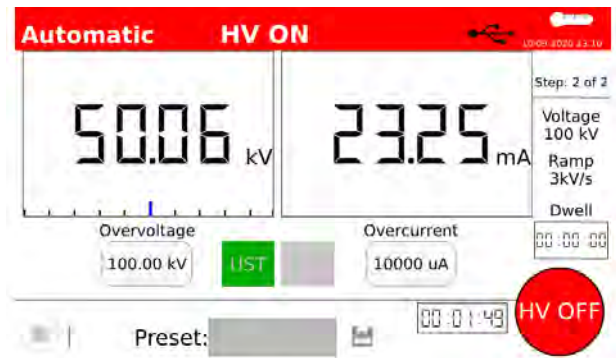

FEATURES

- Lightweight, rugged design** for field use with wheels
- Multiple measurements** including output voltage, leakage current, impedance, and phase angle
- Adjustable test parameters** such as target voltage, maximum leakage current, ramp rate, and dwell time
- Record and view test results** in the internal memory
- 7" color touchscreen display** with adjustable brightness
- Most accurate current measurement** and guard circuit designed to eliminate stray leakage currents
- Meets ANSI/SIA A92.2** test specifications
- HIPODirect compatible** for wireless data transfer and firmware updates

BENEFITS

- Simple to Use** with minimal amount of setup time and intuitive control panel allows for simple testing
- Sturdy and portable design**
- User-friendly touchscreen interface**
- Easy to share results** via WiFi using HIPODirect app or USB transfer.
- Safe operation** with interlock and emergency stop

APPLICATIONS

Brief Description

- Aerial Platform
- Bucket Trucks
- Hydraulic hoses
- Hot Sticks, Gloves, and Ropes
- Switchgears, Vacuum bottles, and Vacuum Interrupters

TECHNICAL SPECIFICATIONS

Model #	30HVT-DI-UPG	60HVT-DI-UPG	120HVT-DI-UPG	100HVT-DI-UPG
Current Ranges (auto)	0 - 100 μ A / 0.1 – 10mA			0 - 1000 μ A, 0.1 – 100mA
Voltage & Current Measurement Accuracy	\pm 1.5% of Reading \pm 0.2% F.S.			
Voltage Resolution	100V			
Current Resolution	0.1 μ A			
Voltage Divider Location	External (Calibrated together with new controller)			
Input	90 – 265VAC, 50/60Hz			
Duty Cycle	5min ON / 5min OFF, repeated maximum of 6 times, then OFF for 2hrs			
Dimensions (W x D x H)	Controller	20in x 14in x 20in (50cm x 35cm x 51 cm)		
Weight	Controller	35lbs (16kg)		
Safety Features	Emergency Stop Visual Warning Indicators External Interlock Audible Warning Indicator	Hand Operated Interlock Switch (optional) External Warning Lamp (optional) Foot Operated Interlock Switch (optional)		
Display	7" TFT , 800 x 480, Color Touch Screen			
Interfaces	USB 2.0 for Memory Stick or HIPODirect app			
Output Data Format	CSV			
Calibration Interval	1 year recommended			
Languages	English, Spanish, Portuguese, French, German, Mandarin			
ECCN: 3A992.A				HTS: 9030.39.0100

	Electronic Components		High Voltage Components	
	Temperature	Humidity (r.h. non-condensing)	Temperature	Humidity (r.h. non-condensing)
Operation	-10°C ... +50°C	5 ... 95%	-10°C ... +50°C	5 ... 95%
Storage	-20°C ... +70°C	5 ... 95%	-20°C ... +70°C	5 ... 95%

SCOPE OF SUPPLY

New Portable Digital Controller
 6ft input power cord
 Interlock plug
 Voltmeter probe
 USB drive with digital copy of manual
 Calibration certificate
 BNC Shorting plug
 2ft Cable Adapter

STANDARD OPTIONS

HHDA13-280 – 120kV rated grounding stick
HH-HS-DI – Hand operated interlock switch
HH-FS-DI – Foot operated interlock switch
HH-WARN-DI – Safety Strobe light with magnetic base
HH-CART-DI* – Hand cart to move HVT-DI controller and bonnet
EXT-WARN-1 – One-year extended warranty

* Note: New HVT-DI controller will not fit in older HVT carts.

7BT60 Series

Vacuum Interrupter Test Set

■ The 7BT60 is a portable 60 kV AC (center tapped) test system designed to test the integrity of vacuum interrupters in switchgear. The output (current limited to 10 mA) is programmed to raise voltage at a preset rate to the desired test level. Once the unit reaches the preset voltage a dwell timer will hold the voltage at that level for the preset time duration. After the dwell time has elapsed, the unit will return to zero. Any failure during the test will be indicated on a “failure” lamp located on the front panel, and the breakdown voltage will be indicated on the Memory kV meter.



FEATURES

- ☑ **Automatic Testing**
- ☑ **Dwell Timer**
- ☑ **Memory Kilovoltmeter**
- ☑ **Pre-programmable Output Kilovoltmeter**
- ☑ **Failure Indicator Lamp**
- ☑ **500 or 3000 V/sec Rise Time**
- ☑ **Removable High Voltage Section for operator safety**
- ☑ **Rugged Field Case**
- ☑ **Field Proven Reliability**

BENEFITS

Go, No-Go Test with a PASS/FAIL indicator lamp.

Minimum setup time for quick testing.

Self-contained, single piece unit suitable for field use.

One Step Testing - the user sets the desired test parameters and the sequence is automatically run

APPLICATIONS

- Electric Utilities
- Test Companies
- Petrochemical Utilities
- Facility Maintenance



TECHNICAL SPECIFICATIONS

Model Number		7BT60-*
System Output (V)		0-60 kV (center tapped)
System Output (A)		20 mA
Rise Time		500 V/s or 3000 V/s
Metering Accuracy		0 ... 60kV / pre-settable, memory meter
Dimensions (W x H x D)		12 x 34 x 12 in (30.4 x 86.4 x 30.4 cm)
Weight	Net	96 lbs (45 kg)
	Shipping	125 lbs (57 kg)
Input Voltage & Frequency		* In the model number, designate 'A' for 120 V/ 60Hz input or 'B' for 230 V/50Hz input
Included Accessories		QTY 1: Interconnect Cable between controller and base, 25ft (7.6m)
		QTY 2: Test Leads, 10ft (3m)
		QTY1: Power Cord, 6ft (1.8m)
		User's Manual
		Calibration Certificate

SYSTEM CONTROL



OPTIONAL EQUIPMENT AND ACCESORIES

Part Number	Description
SPK1-7BT60	Spare Parts Kit for 7BT60
EXT-WARN-1	One year extended warranty

HD100 Series

AC/DC Benchtop Hipot Testers



■ The **HD100 Series of AC/DC Hipots** are accurate, durable instruments designed for production testing on all types of electrical units, systems and components. This product is simple to operate and designed for use with minimal training.

The AC/DC output configuration eliminates the need to purchase separate AC and DC Hipots, while the output connected voltmeter ensures accurate voltage measurements regardless of output loading. This series is capable of testing to most industry specifications such as UL, CSA, VDE, IEC, and MIL for dielectric withstand testing.



FEATURES

- ☑ **Continuously adjustable test voltage**
- ☑ **Shielded output** cable
- ☑ **Adjustable overload** from 10 to 110% of rated current output
- ☑ **Audible / visual alarms** provide a clear indication of overload situation
- ☑ **Zero start interlock** ensures voltage is at zero before high voltage can be energized
- ☑ **Shorting solenoid** grounds output cable and object under test

BENEFITS

Dual functionality eliminates the need to purchase separate AC and DC Hipots.

Automatic grounding of power supply and test object when high voltage is turned OFF.

Meets industry specifications for most UL, CSA, VDE, IEC, MIL dielectric withstand tests.

Easily mountable into a 19-inch rack.

APPLICATIONS

- Capacitors
- Transformers
- Wire and Cable
- Coils and Chokes
- Connectors
- Medical Devices
- Appliances

TECHNICAL SPECIFICATIONS

Model Number		HD103-*	HD106-*	HD115-*	HD125-*	HD140-*
System Output (V)	AC Voltage	0-2.5kV	0-5kV	0-12.5kV	0-10kV	0-15.5kV
	DC Voltage	0-3kV	0-6kV	0-15kV	0-25kV	0-40kV
Polarity		Negative Output, Positive Ground				
Metering: Type, Accuracy		4.5" analog meters, ±2% full scale accuracy				
Voltage Meter		0-0.6/1.2/3kV	0-1.2/3/6kV	0-3.75/7.5/15kV	0-5/10/25kV	0-8/16/40kV
Current Meter		0-50/500/5000µA DC, 0-5mA AC				
Dimensions (W x D x H)		21 x 20 x 11 in (53 x 51 x 28cm)				
Weight	Net	46lbs (21kg)	51lbs (23kg)	75lbs (34kg)	82lbs (37kg)	
	Shipping	59lbs (27kg)	64lbs (29kg)	85lbs (39kg)	92lbs (47kg)	
Input Voltage & Frequency		* In the model number, designate 'A' for 120V/60Hz input or 'B' for 230V/50Hz input				

SYSTEM CONTROLS

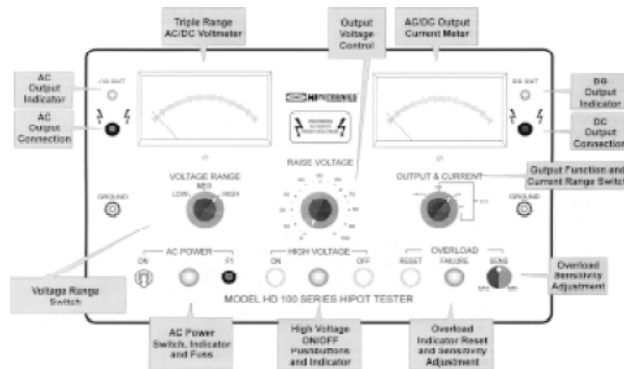

OPTIONAL EQUIPMENT & ACCESSORIES

Part Number	Description
HHDA13-280	Grounding Stick, 120kV Max Voltage
HTP-F	Fixed Test Probe, 25kV Max Voltage
TC-25	Test Cage, 25kV Max Voltage
SPK1-HD100	Spare Parts Kit for HD103, HD106, HD115 & HD125
SPK1-HD140	Spare Parts Kit for HD140
HTL-S	Extra Test Lead for HD103, HD106, HD115 & HD125
HTL-140	Extra Test Lead for HD140
EXT-WARN-1	One year extended warranty



HHDA13-280 Grounding Stick (pictured above)

H306 Series

AC/DC Benchtop Hipot Testers & Megohmmeter

■ The H306 Series of AC/DC Hipots and Megohmmeters is an accurate benchtop instrument designed to perform insulation tests on all types of electrical system components, assemblies and apparatus. This product was developed AC and DC dielectric tests and insulation resistance measurements with direct megohmmeter readings at 500V DC output.

The AC/DC output configuration eliminates the need to purchase separate AC and DC Hipots, while the output connected voltmeter ensures accurate voltage measurements regardless of output loading. This series is capable of testing to most industry specifications such as UL, CSA, VDE, IEC, and MIL for dielectric withstand testing.



FEATURES

- ☑ **Continuously adjustable test voltage**
- ☑ **Shielded output cable**
- ☑ **Adjustable Overload** from 10 to 110% of rated current output
- ☑ **Audible/Visual alarms** provide a clear indication of overload situation
- ☑ **Zero start interlock** ensures voltage is at zero before high voltage can be energized
- ☑ **Shorting solenoid** grounds output cable and object under test
- ☑ **Guard Circuit** bypasses unwanted stray leakage currents
- ☑ **Adjustable electronic meter** for accuracy

BENEFITS

Triple testing capabilities eliminate the need to purchasing separate an AC Hipot, DC Hipot and Megohmmeter.

Automatic grounding of power supply and test object when high voltage is turned OFF.

Meets industry specifications for most UL, CSA, VDE, IEC, MIL dielectric withstand tests.

Easily mountable into a 19 inch rack.

APPLICATIONS

- Capacitors
- Transformers
- Wire and Cable
- Coils and Chokes
- Connectors
- Medical Devices
- Appliances

TECHNICAL SPECIFICATIONS

Model Number		H306B-*			
System Output (V)	AC Voltage	0-5kV			
	DC Voltage	0-6kV			
Polarity		Negative Output, Positive Ground			
Metering: Type, Accuracy		4.5" analog meters, $\pm 2\%$ full scale accuracy			
Voltage Meter		0-1.2/6 kV			
Current Meter		0-50/500/5000 μ A DC, 0-5mA AC			
Overload Current		Adjustable from 0.5mA-5.5mA			
MΩ Range @ 500V DC		X0.1 Multiplier 0.1-10M Ω	X1 Multiplier 1-100M Ω	X10 Multiplier 10-1000M Ω	X100 Multiplier 100-10,000M Ω
Dimensions (W x D x H)		21 x 20 x 11 in (53 x 51 x 28cm)			
Weight	Net	49lbs (22kg)			
	Shipping	59lbs (27kg)			
Input Voltage & Frequency		* In the model number, designate 'A' for 120V/60Hz input or 'B' for 230V/50Hz input			

SYSTEM CONTROLS

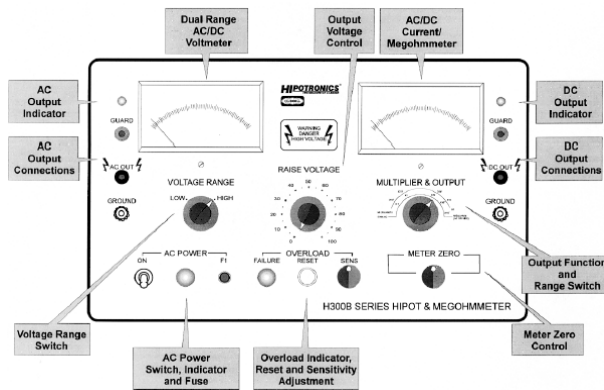

OPTIONAL EQUIPMENT & ACCESSORIES

Part Number	Description
HHDA13-280	Grounding Stick, 120kV Max Voltage
HTP-F	Fixed Test Probe, 25kV Max Voltage
TC-25	Test Cage, 25kV Max Voltage
SPK1-H306B	Spare Parts Kit for H306
HTL-S	Extra Test Lead for H306
EXT-WARN-1	One year extended warranty



HHDA13-280 Grounding Stick (pictured above)

HM3A

Megohmmeter

■ The HM3A is a highly accurate megohmmeter designed to perform insulation resistance tests on all types of electric components, systems and apparatus. They are designed for general purpose laboratory use and feature test voltages to 1kV and readings to 20,000,000 megohms.

Applications include insulation resistance and dielectric absorption testing of apparatus and insulation samples to IEEE, ANSI, ASTM, UL, MIL and other recognized standards. A regulated power supply and a guard circuit for ungrounded samples enhance accurate measurements. Surge suppression protection for all meters and sensitive circuits, short circuit protection and meter recalibration provision guarantee reliable and accurate performance. Test leads are included with each instrument



Model HM3A
Megohmmeter

FEATURES

- ☑ **Short Circuit Protection** – Handles continuous shorting on the output with out damage to internal components.
- ☑ **Self Calibration Feature** – Verify calibration at any time
- ☑ **Guard Circuit** – Allows user to bypass the unwanted portion of the leakage current.
- ☑ **Output Discharge Resistor** – Discharges the stored energy on the test object hen the power is turned off.

BENEFITS

Steady output Voltage - Ferroresonant line transformer and solid state electronic load regulation circuitry provide steady output voltage under varying line and load conditions and eliminate meter fluctuations.

Broad Measuring Range – 0.1 to 20,000,000M accommodates a wide range of applications.

NIST traceable – significant cost savings on outside calibrations

FEATURES

The HM3A Megohmmeters are ideal for testing:

- Wire and cable
- Coils and inductors
- Connectors
- Switches and relays
- Motors and generators
- Transformers

TECHNICAL SPECIFICATIONS

Input Voltage	Model number with suffix - A 120V / 60Hz Model number with suffix - B 220V / 50Hz
Output Voltage	50, 100, 500, 1000 V
Polarity	Negative output, Positive ground
Note	The ohmic value of the test sample is the product of the scale reading and the decimal multiplier (selector switch).
Range	0.1 - 20,000,000 M
Scale Range	(50, 500 V) 1-100M (500, 100 V) 2-200M
Resistive Multiplier Switch	(50, 500 V) $10^{-1}, 10^0, 10^1, 10^2, 10^3, 10^4$ (500, 100 V) $10^0, 10^1, 10^2, 10^3, 10^4, 10^5$
Accuracy	3/22" of Scale <1,000,000 M 1/8" of Scale >1,000,000 M
Terminations	High Voltage Lead: 5 ft(1.5m) shielded cable (RG58U) with an alligator clip Return Lead: 5 ft(1.5m) insulated test lead with alligator clip
Dimensions	12"W x 9"D x 9"H (31 x 23 x 23 cm)
Weight	Net 15 lb (72kg) Ship 27 lb (82kg)

ORDERING INFORMATION

System

* Designate input voltage. 'A' for 120Vin or 'B' for 220Vin. **HM3A-***

Options

-SPARE PARTS KITS – Catalog nos. SPK1-HM3A

HVM

High Voltage Megohmmeters

■ **The HVM Series** Megohmmeters are designed for portable use in the field or factory. The rugged construction of these instruments is ideally suited to applications in industrial or substation environments where measurements to 300,000 megohms at voltages up to 15 kV are required.

Applications include insulation resistance, polarization index and dielectric absorption testing of apparatus and insulation samples to IEEE, ANSI, UL, MIL, and other standards. A regulated power supply and guard circuit suppression enhance accurate measurements. Surge suppression, short circuit protection and meter recalibration provision guarantee reliable and accurate performance. Test leads are included with each instrument.



FEATURES

- ☑ **Continuously adjustable test voltage** from zero to rated voltage
- ☑ **Shielded output cable**
- ☑ **Guard circuit** for accurate readings
- ☑ **Megohm readings** to 300,000 megohms
- ☑ **Line regulator** to minimize effect of line variations
- ☑ **Shorting switch** grounds output cable
- ☑ **Press to test** (lockable) pushbutton switch
- ☑ **Single scale** voltmeter
- ☑ **Four range** multiplier switch
- ☑ **Four range** current meter
- ☑ **Surge-limiting resistors** in HV output

BENEFITS

Ideal for field testing – compact, lightweight and rugged makes it suitable for field orientated applications

Operator Safety – the power supply and test object are automatically grounded when high voltage is turned off and there is no exposed high voltage

Simple to Use - a minimal amount of setup time and a simple control panel allows simple testing every time

Accurate Resistance Measurement - while guard circuit eliminates stray leakage currents

APPLICATIONS

- **Cable**
- **Transformers**
- **Electrical Switchgear**
- **Motors**
- **Generators**
- **Other Electrical Apparatus**

TECHNICAL SPECIFICATIONS

General	HVM5	HVM10	HVM15	
Input Voltage		120 V, 60 Hz 230 V, 50 Hz	for -A version for -B version	
Output Voltage	0 - 5 kV	0 - 10 kV	0 - 15 kV	
Polarity	Negative output, positive ground			
Metering	Megohmmeter reading equals the product of the scale reading, decimal multiplier, and voltage multiplier (indexed on the voltmeter)			
Range in M	0.1 - 100,000	0.1 - 200,000	0.1 - 300,000	
Scale Range in M	1 - 100	1 - 100	1 - 100	
Voltmeter Multipliers	1 - 10	1 - 20	1 - 30	
Multipliers Switch in M	X.1 - X1 - X10 - X100	X.1 - X1 - X10 - X100	X.1 - X1 - X10 - X100	
Accuracy	3/32 inch of Scale 1/8 inch of Scale	< 10,000 M > 10,000 M	< 20,000 M > 20,000 M	< 30,000 M > 30,000 M
Voltmeter	0 - 5 kV	0 - 10 kV	0 - 15 kV	
Dimensions (W x H x D)	8.5" x 15" x 10.5" (216mm x 381mm x 267mm)	8.5" x 15" x 10.5" (216mm x 381mm x 267mm)	8.5" x 15" x 10.5" (216mm x 381mm x 267mm)	
Weights	Net 22lbs. Ship 30lbs. (9 kg. 12 kg.)	Net 34lbs. Ship 40lbs. (14 kg. 16 kg.)	Net 38lbs. Ship 45lbs. (15 kg. 18 kg.)	

SCOPE OF SUPPLY

- Qty. 1 HVM Megohmmeter
- Qty. 1 Input Line Cord, grounded type 6 feet (1.8 m)
- Qty. 1 Return Cable, 15 feet (3.3 m)
- Qty. 1 High Voltage Output cable, shielded with alligator clip and rubber insulated boot, 15 feet (3.3 m)
- Qty. 1 Calibration Certificate
- Qty. 1 User's Manual

ORDERING INFORMATION

0-5kV DC output

HVM5-A or HVM5-B

0-10kV DC output

HVM10-A or HVM10-B

0-15kV DC output

HVM15-A or HVM15-B

ACCESSORIES

Spare Parts Kits

- SPK1-HVM5
- SPK1-HVM10
- SPK1-HVM15

Test leads - 15ft. (4.6m)

HVM-CSI

KVM-W SERIES

AC/DC Kilovoltmeters – Wireless – 100kV, 200kV, & 300kV

The KVM-W Series AC/DC Wireless Kilovoltmeters are designed to provide exceptional safety through its wireless communication. It is a highly accurate, portable and modern voltage measurement and calibration system. Each model in this series contains a high voltage assembly, measurement device, durable carrying case, and mobile App.

The carrying case and internal battery make the system completely portable for field testing, while the precision divider assembly and readout device make it suitable for laboratory use. The KVM-W Series products perform multiple measurements including DC, AC Peak, AC RMS, AC Absolute Average, Frequency and Crest Factor measurements. Units are available in 100kV, 200kV, and 300kV for a wide variety of applications.

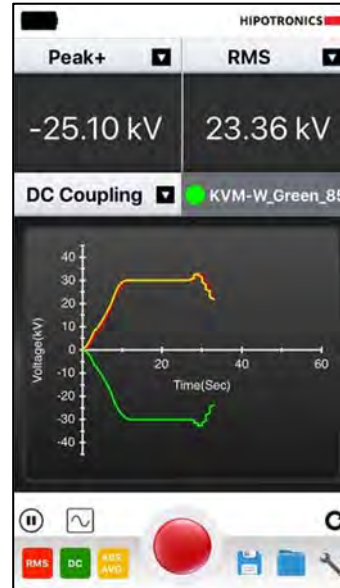

FEATURES

- Perform multiple measurements
- AC and DC Coupling
- Battery or line power operation
- True Divider

BENEFITS

- Safety due to Wireless Communication** via mobile application
- Waveform Display**
- Save Data as .CSV**
- Rugged and Reinforced carrying case**

APPLICATIONS

Testing & Calibrating of:

- AC/DC Hipot Testers
- High Voltage Power Supplies
- Semiconductor Implantation System

TECHNICAL SPECIFICATIONS

Model #	KVM100-W		KVM200-W		KVM300-W	
Measuring Range	0-100kV		0-200kV		0-300kV	
Display	Wireless App (iOS, Android, PC)					
Battery	Type	3 NiMH Size SC				
	Operation	10hrs of operation				
Accuracy	DC	± 1.0% of reading (from 1-100% of scale)				
	AC (RMS)	± 1.0% of reading (from 1-100% of scale)				
	AC (Peak)	± 1.0% of reading (from 1-100% of scale)				
Voltage Rating	DC	100kV	200kV	300kV		
	AC (RMS)	100kV	200kV	300kV		
	AC (Peak)	142kV	283kV	425kV		
Charging Voltage	5V DC USB-C					
Capacitance of HV Capacitor	200pF					
Divider Dimensions (W x H x D)	8" x 15" x 8" (20cm x 38cm x 20cm)		9" x 37" x 9" (23cm x 94cm x 23cm)		45" x 81" x 41" (115cm x 206cm x 105cm)	
Weight	38 lbs (17 kg)		48 lbs (22 kg)		350 lbs (159 kg)	
Languages	English					
ECCN: 3A992.A			HTS US: 9030.33.3800			

Notes: Optional ISO17025 accredited calibration available upon request for DC, RMS, and pk/sqrt(2) measurements.

	Electronic Components		High Voltage Components	
	Temperature	Humidity (r.h. non-condensing)	Temperature	Humidity (r.h. non-condensing)
Operation	+5°C ... +40°C	5 ... 95%	-10°C ... +45°C	5 ... 90%
Storage	-20°C ... +70°C	5 ... 95%	-10°C ... +55°C	5 ... 90%

SCOPE OF SUPPLY

High voltage divider
 Wireless measurement unit
 Charging cable
 Mobile application (iOS, Android, PC)
 Carrying case (KVM100-W & KVM200-W only)
 Manual & Test report

STANDARD OPTIONS

HHDA13-290 – Grounding Stick, 120kV Max Voltage
KVM100W-DO – Additional 100kV divider
KVM200W-DO – Additional 200kV divider
KVM300W-DO – Additional 300kV divider
EXT-WARN-1 – One-year extended warranty
-ACC – ISO17025 accredited calibration for DC, RMS, and pk/sqrt(2) measurements

CUSTOMER SUPPLIED

Mobile device, tablet, or PC

KVM Series

AC/DC Kilovoltmeters - 100kV, 200kV, & 300kV

■ The KVM Series AC/DC Kilovoltmeters are highly accurate and portable voltage measurement and calibration systems. Each model in this series contains a high voltage divider assembly, control and measurement device, durable carrying case, and interconnection cable. The carrying case and battery operation mode make the system completely portable for field testing, while the precision divider assembly and readout device make it suitable for laboratory use. The KVM Series products perform multiple functions including DC, Ripple, AC Peak and AC Absolute Average measurements. Units are available in 100kV, 200kV, and 300kV for a wide variety of applications.



FEATURES

- ☑ **Perform multiple measurements**
- ☑ **Low temperature and voltage coefficients**
- ☑ **Digital readout**
- ☑ **AC and DC coupling**
- ☑ **Battery** or line power operation
- ☑ **Light weight** and **portable** divider
- ☑ **Rugged** and reinforced carrying case
- ☑ **True divider**

BENEFITS

Suitable for field, factory or lab use.

Simple to use with oscilloscopes and other measuring devices.

Fast and accurate measurements under varying ambient conditions.

NIST traceable for significant cost savings on outside calibrations.

APPLICATIONS

Testing & Calibrating of:

- AC/DC Hipot testers
- High Voltage DC power supplies
- Semiconductor implantation systems

TECHNICAL SPECIFICATIONS

Model Number		KVM100-*	KVM200-*	KVM300-*
Voltage	High Range	0-100 kV	0-199 kV	0-300 kV
	Low Range	0-10.0 kV	0-19.9 kV	0-30 kV
Display		Digital, 3 1/2 Digits, 1/2" LED, Auto Polarity		
Input Impedance		1 MΩ		
Battery	Type	4, NiCd Cells, Size D		
	Operation	8hrs of operation, 16hrs for recharge		
Accuracy	DC	< 0.5% of full scale (from 10-100% of scale)		
	AC (RMS)	< 1.0% of full scale (from 10-100% of scale)		
	AC (Peak)	< 2.0% of full scale (from 10-100% of scale)		
Nominal Voltage Ratio (V _{OUT} /V _{IN})		1000:1	2000:1	3000:1
Voltage Rating	DC	100 kV	200 kV	300 kV
	AC (RMS)	100 kV	200 kV	300 kV
	AC (Peak)	142 kV	283 kV	425 kV
Capacitance of HV Capacitor		200pF		
Input Voltage & Frequency		* In the model number, designate 'A' for 120V/60Hz input or 'B' for 230V/50Hz input		
Dimensions (W x H x D)		11in x11in x25in (28cm x28cm x62cm)	11in x11in x45in (28cm x28cm 116cm)	24in x84in x6in (30cm x213.6cm x15cm)
Weight		35 lbs (15.9 kg)	45 lbs (20.4 kg)	270 lbs (122.7 kg)

OPTIONAL EQUIPMENT & ACCESSORIES

Part Number	Description	Input Voltage
HHDA13-280	Grounding Stick, 120kV Max Voltage	N/A
KVM100-DO-*	Extra Divider Section	* In the model number, designate 'A' for 120V input or 'B' for 230V input
KVM200-DO-*	Extra Divider Section	
KVM300-DO-*	Extra Divider Section	
SPK1-(Model Number)	Spare Parts Kit for KVM Series	N/A
EXT-WARN-1	One year extended warranty	N/A



HHDA13-280
Grounding Stick
(pictured above)

D149-DI

AC Dielectric Breakdown Tester

The D149-DI Series of AC Dielectric Breakdown Testers represents a new level of sophistication, flexibility and accuracy in breakdown voltage testing. Each unit is equipped with a new standard embedded firmware controller that is internally programmed to perform the ASTM D149 short-time test, step-by-step test and slow rate-of-rise test. This unit can also be easily programmed to perform variations of these test sequences. The voltmeter circuit continually samples each waveform to determine the breakdown voltage with the highest accuracy. The operator can control all test parameters as required. When testing is complete, all breakdown information for that series of test samples are automatically recorded. Standard units are available in 30kV, 50kV, 75kV and 100kV AC for a wide variety of applications. Contact the factory for DC or partial discharge testing requirements, and to inquire about modernization of existing systems.



100V unit (pictured above)

Example of oil bath & test cell (pictured below)

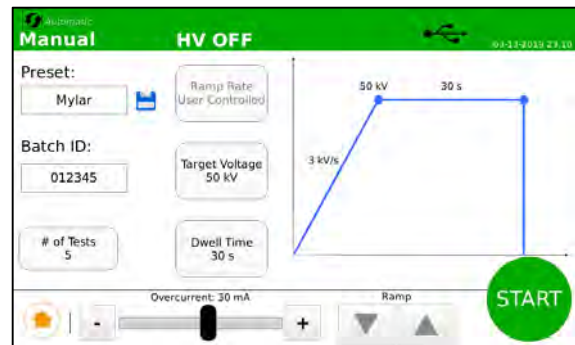

FEATURES

- 7" touchscreen controller**
- Breakdown voltage detection **within 10µs**
- USB 2.0** for data download
- Internally programmed** to perform all D149 type tests
- Adjustable test parameters** (voltage, ramp rate, max leakage current, etc.)
- Built in safety cage** with interlock door
- Adjustable overcurrent sensitivity**
- Optional **test fixtures** and **oil baths**
- User Friendly** and intuitive controls

BENEFITS

- SIL3 compatible**
- Complete** test solution.
- All metering** performed by fast sensing circuitry.
- Tests performed** with automated sequences.
- Software** designed to calculate all test result data and save in csv format for report.
- Rackmount controller**

APPLICATIONS

- Polymeric molding and embedding compounds
- Ceramics, Porcelain, and Mica
- Sleeving, Tubes, Sheets, and Rods
- Varnishes, Coatings, and Insulating fluids.
- Filling Compounds
- Adhesives

TECHNICAL SPECIFICATIONS

Model #		730-2D149-DI	750-2D149-DI	775-5D149-DI	7100-5D149-DI
System Output	Voltage	0.15kV – 30kV	0.25kV – 50kV	0.375kV – 75kV	0.5kV – 100kV
	Current	66mA	40mA	66mA	50mA
Voltage Measurement Accuracy	±1.5% of reading, ±0.2% of full scale				
Dimensions (net)*	25" x 27" x 68" H			69" x 39" x 75" H	
Weight (net)	325lbs/147.42kg			1850lbs/839.15kg	
Input Frequency	50/60Hz				
Input Voltage	90 – 264VAC			200 – 264VAC	
Duty Cycle	Continuous Breakdown Testing / 2kVA 15 min on 45 min off 8 times per day			Continuous Breakdown Testing / 5kVA 1 hr on 1 hr off 8 times per day	
ECCN: 3A992.A			HTS US: 9030.39.0100		

* Magnetic lamp adds 10" to height of the system once installed

SYSTEM CONTROLS

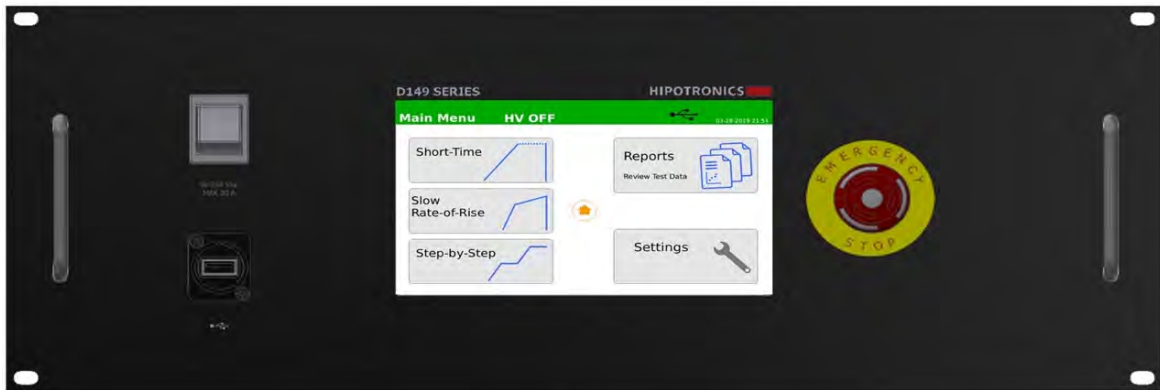

OPTIONAL EQUIPMENT & ACCESSORIES

Part Number	Description			Max Test Voltage
TF-.25-#	Electrode, 0.25 inch diameter/6.35mm			# In the part number, designate '50' for 30kV or 50kV max voltage or '75' for 75kV or 100kV max voltage.
TF-.50-#	Electrode, 0.5 inch diameter/12.7mm			
TF-1-#	Electrode, 1 inch diameter/25.4mm			
TF-2-#	Electrode, 2 inch diameter/50.8mm			
TF-4.5-#	Electrode, 4.5 inch diameter/114.3mm			
TF-4.25-#-A	Flat plates, 4.25 inch/107.95mm length, 0.5inch/12.7mm thick, 0.25 inch/6.35mm wide, square edges, 0.125 inch/3.175mm rounded ends			
TF-3-#	Opposing Cylinders (0.12 inch rounded edges)	Upper Cylinder	Diameter: 1 in/25.4mm Thickness: 1 in/25.4mm	
		Lower Cylinder	Diameter: 3 in/76.2mm Thickness: .6in/15.2mm	
OB-#	Lucite Oil bath			
TL-D149-50	High Voltage & Ground Test Leads. Used to connect terminations to alternative fixtures.			N/A
HHD13-280	Resistive ground stick, 120 kV max.			

D149's New Digital Interface Embedded Controls

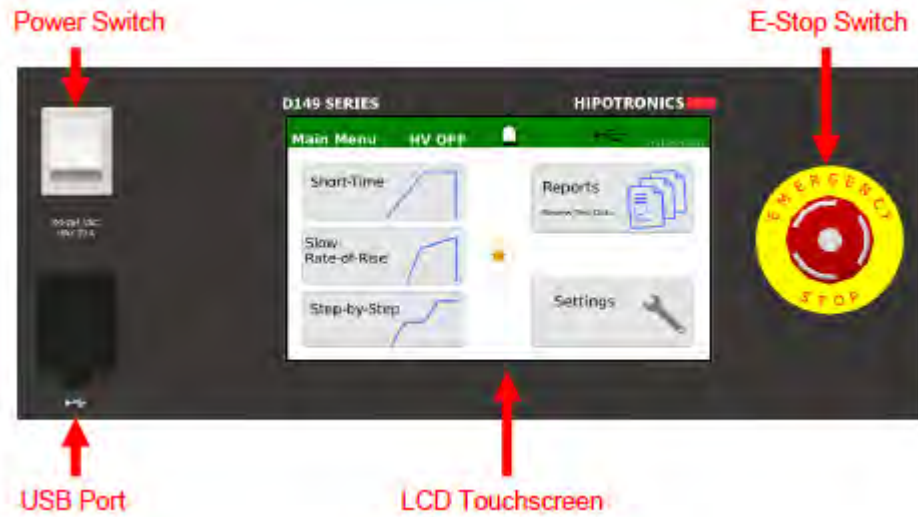

HIPOTRONICS has manufactured D149 Breakdown Test Sets for over 30 years. We are now releasing an improved D149 Series after extensive feedback from our customers. Each D149 Breakdown Test Set will now be equipped with a new embedded firmware controller preprogrammed with the ASTM and IEC 60243-1 short-term test, step-by-step test and slow rate-of-rise test. Polymeric molding, embedding compounds, ceramics, porcelain, and sleeving are just a few of the applications the D149-DI can test.

Additionally, past D149 systems can be modernized to the new controls!

	Analog Control System	PLC System	DI Control System
Voltage Accuracy	± 2% of rdg	± 5% of rdg	± 1.5% of rdg ± 0.2% of FS
Accuracy Range	10-100% of system output	10-100% of system output	0.5-100% of system output
Step Resolution	2% of full scale	1% of full scale	0.5% of full scale
Type of Controls	Analog	Digital	Digital
Screen Size	N/A	6"	7"
Touchscreen	✗	✓	✓
Pre-programmed Sequences	✗	✓	✓
SIL3 Compatible	✗	✗	✓
Export Data via USB in CSV Format	✗	✗	✓

Contact our sales department to request a quote today!



700-DI Series AC Dielectric Test Sets

High Voltage AC Test Systems – 2-100kVA

The HIPOTRONICS standard line of AC Dielectric Test Systems are designed to perform high voltage AC tests on electrical apparatus in accordance with IEC60, IEEE 4 and IEC 270 and other national test standards. A variety of mechanical configurations are available to suit different installation conditions. Some models can be supplied in mobile versions when it is difficult to move the test object to the test area.

AC Dielectric Test Sets are available in a wide range of voltage and power ratings with exceptional reliability, durability and functionality. No matter what your requirement, HIPOTRONICS has an affordably priced, highly reliable test solution to meet your needs.



FEATURES

- Microprocessor controller** provides better regulation accuracy and measuring accuracy
- Continuously adjustable test output voltage**
- SIL3 Compatible**
- Designed** to operate from 0.5% to 100% of the maximum rated output voltage
- Easily accessible** meter recalibration
- Adjustable Overload** from 10% to 110% of rated current output
- Backup Breaker** overload safety situation
- Output Connected** voltmeter and ammeter
- Zero start interlock** ensures that the voltage control is at a minimum before HV can be energized
- Rated current** available from zero to rated voltage

BENEFITS

- Simple to Use** with minimal amount of setup time and intuitive control panel allows for simple testing
- Surge-compensated** HV transformer windings for withstanding flashovers at full voltage
- Output Connected Meters** ensures for fast and accurate readings
- Surge and Transient Protection** on all meters, transformers, etc.
- Partial Discharge Testing** allows for low PD levels available at full output voltage (PD level needs to be specified when ordering and may require additional components)

APPLICATIONS

- Transformers
- Bushings
- Connectors
- Capacitors
- Switchgear
- Arrestors
- Instrument Transformers
- Sample Cable Lengths
- Rotating Machines
- Insulating Materials
- Transmission Line Hardware
- HV Components



**Pictures are for reference only and may not reflect final design*

TECHNICAL SPECIFICATIONS

Voltage Output Range	0.5-100% of F.S.
Voltage & Current Measurement Accuracy	± 1.5% of Reading ± 0.2% F.S
Measurement Resolution	0.01kV, 0.01mA
Ramp Rate Accuracy	+/- 5%
Step Resolution	0.5% of Full Scale
PD Baseline	≤20pC up to full voltage for oil insulated transformers

Notes: The PD level is inherent to the equipment itself without considering possible external radiated interference from the customer's dedicated mains power supply or ground noise.

	2kVA Power Rating				
Parameter	705-2	710-2	715-2	730-2	750-2
Input Voltage	90-264VAC, 50/60Hz				
Max Output Voltage	5kV	10kV	15kV	30kV	50kV
Max Output Current	400mA	200mA	133mA	66mA	40mA
Output Connection					
All-in-One Cabinet	Shielded Cable Output			n/a	
Separate Components	Bushing			Epoxy Output Bushing	
Duty Cycle					
All-in-One Cabinet	15min ON / 45min OFF, 6x/day			n/a	
Separate Components	1hr ON / 1hr OFF, 6x/day or Continuous @ 90% rated voltage, and 75% rated current				
Controller Dimensions (W x H x D)					
All-in-One Cabinet	22" x 21" x 26" (546 x 510 x 660mm)			n/a	
Separate Components	16.60" x 7.75" x 20.5" (422 x 197 x 520.7mm)				
Controller Weight (Net)					
All-in-One Cabinet	130lbs (59kg)			n/a	
Separate Components	35lbs (16kg)				
HV Source Dimensions (W x H x D)					
All-in-One Cabinet	In Control / Regulator Section			n/a	
Separate Components	20.50" x 29.25" x 25.0" (521 x 743 x 635mm)			20.50" x 25.00" x 31.00" (521 x 743 x 787mm)	
HV Weight (Net)					
All-in-One Cabinet	In Control / Regulator Section			n/a	
Separate Components	400lbs (181kg)		425lbs (193kg)		450lbs (204kg)

	5kVA Power Rating					
Parameter	705-5	715-5	730-5	775-5	7100-5	
Input Voltage	200-264VAC, 50/60Hz					
Max Output Voltage	5kV	15kV	30kV	75kV	100kV	
Max Output Current	1000mA	333mA	166mA	66mA	50mA	
Output Connection						
All-in-One Cabinet	Shielded Cable Output			n/a		
Separate Components	Epoxy Output Bushing					
Duty Cycle						
All-in-One Cabinet	15min ON / 45min OFF, 6x/day			n/a		
Separate Components	1hr ON / 1hr OFF, 6x/day or Continuous @ 90% rated voltage, and 75% rated current					
Controller Dimensions (W x H x D)						
All-in-One Cabinet	21.5" x 25.5" x 26.0" (546 x 510 x 660mm)			n/a		
Separate Components	16.60" x 7.75" x 20.5" (422 x 197 x 520.7mm)					
Controller Weight (Net)						
All-in-One Cabinet	165lbs (75kg)			n/a		
Separate Components	35lbs (16kg)					
HV Source Dimensions (W x H x D)						
All-in-One Cabinet	In Control / Regulator Section			n/a		
Separate Components	20.50" x 25" x 29.25" (521 x 635 x 743mm)			25" x 34" x 38" (635 x 864 x 965mm)	25" x 37" x 46.5" (635 x 940 x 1181mm)	
HV Weight (Net)						
All-in-One Cabinet	In Control / Regulator Section			n/a		
Separate Components	425lbs (193kg)	450lbs (205kg)	500lbs (227kg)	660lbs (299kg)	860lbs (390kg)	

	10kVA Power Rating				
Parameter	705-10	715-10	730-10	775-10	7100-10
Input Voltage	230V, 50/60Hz. Other Inputs Available. Consult Factory.				
Max Output Voltage	5kV	15kV	30kV	75kV	100kV
Max Output Current	2000mA	666mA	333mA	133mA	100mA
Output Connection	Shielded Cable Output		Epoxy Output Bushing		
Duty Cycle	1hr ON / 1hr OFF, 6x/day or Continuous @ 90% rated voltage, and 75% rated current				
Controller Dimensions (W x H x D)	22.75" x 47" x 26.25" (578 x 1194 x 667mm)				
Controller Weight (Net)	600lbs (272kg)		400lbs (181kg)		
HV Source Dimensions (W x H x D)	In Control / Regulator Section		20.50" x 25" x 29.25" (521 x 635 x 743mm)	25" x 37" x 40" (635 x 940 x 1016mm)	25" x 37" x 47" (635 x 940 x 1193mm)
HV Weight (Net)	In Control / Regulator Section		500lbs (227kg)	860lbs (390kg)	900lbs (408kg)

	20kVA Power Rating				
Parameter	705-20	715-20	730-20	775-20	7100-20
Input Voltage	480V, single phase, 60Hz; 380V, single phase, 50Hz. Other Inputs Available. Consult Factory.				
Max Output Voltage	5kV	15kV	30kV	75kV	100kV
Max Output Current	4000mA	1333mA	666mA	266mA	200mA
Output Connection	Shielded Cable Output		Epoxy Output Bushing		
Duty Cycle	1hr ON / 1hr OFF, 6x/day or Continuous @ 90% rated voltage, and 75% rated current				
Controller Dimensions (W x H x D)	25" x 54" x 30" (635 x 1372 x 762mm)				
Controller Weight (Net)	700lbs (318kg)		300lbs (136kg)		
HV Source Dimensions (W x H x D)	In Control / Regulator Section		25" x 38" x 37" 635 x 965 x 940mm)	25" x 37" x 40" (635 x 940 x 1016mm)	25" x 37" x 47" (635 x 940 x 1194mm)
HV Weight (Net)	In Control / Regulator Section		900lbs (409kg)	950lbs (432kg)	1300lbs (591kg)

	40kVA Power Rating				
Parameter	705-40	715-40	720-40	750-40	7100-40
Input Voltage	480V, single phase, 60Hz; 380V, single phase, 50Hz. Other Inputs Available. Consult Factory.				
Max Output Voltage	5kV	15kV	20kV	50kV	100kV
Max Output Current	8000mA	2666mA	2000mA	800mA	400mA
Output Connection	Shielded Cable Output		Epoxy Output Bushing		
Duty Cycle	1hr ON / 1hr OFF, 6x/day or Continuous @ 90% rated voltage, and 75% rated current				
Controller Dimensions (W x H x D)	30" x 75" x 48" (762 x 1905 x 1219mm)		30.25" x 60" x 31" (768 x 1524 x 787mm)		
Controller Weight (Net)	1400lbs (635kg)		450lbs (204kg)		
HV Source Dimensions (W x H x D)	In Control / Regulator Section		25" x 37" x 38" (635 x 940 x 965mm)		30.5" x 40" x 55.5" (775 x 1016 x 1410mm)
HV Weight (Net)	In Control / Regulator Section		925lbs (420kg)	Net 1450lbs (658kg)	1800lbs (816kg)

	60kVA Power Rating			
Parameter	705-60	720-60	760-60	7100-60
Input Voltage	480V, single phase, 60Hz; 380V, single phase, 50Hz. Other Inputs Available. Consult Factory.			
Max Output Voltage	5kV	20kV	60kV	100kV
Max Output Current	12000mA	3000mA	1000mA	600mA
Output Connection	Shielded Cable Output	Epoxy Output Bushing		
Duty Cycle	1hr ON / 1hr OFF, 6x/day or Continuous @ 90% rated voltage, and 75% rated current			
Controller Dimensions (W x H x D)	30" x 75" x 48" (762 x 1905 x 1219mm)		30.25" x 75" x 31" (768 x 1905 x 787mm)	
Controller Weight (Net)	1800lbs (816kg)		800lbs (363kg)	
HV Source Dimensions (W x H x D)	In Control / Regulator Section	30.5" x 38" x 41" (775 x 965 x 1041mm)	30.5" x 40" x 46" (775 x 1016 x 1168mm)	36.5" x 48" x 55.5" (927 x 1219 x 1410mm)
HV Weight (Net)	In Control / Regulator Section	1400lbs (635 kg)	1925lbs (873 kg)	2600lbs (11795 kg)

	100kVA Power Rating			
Parameter	720-100	750-100	775-100	7100-100
Input Voltage	480V, single phase, 60Hz; 380V, single phase, 50Hz. Other Inputs Available. Consult Factory.			
Max Output Voltage	20kV AC	50kV AC	75kV AC	100kV AC
Max Output Current	5000mA	2000mA	1333mA	1000mA
Output Connection	Epoxy Output Bushing			
Duty Cycle	1hr ON / 1hr OFF, 6x/day or Continuous @ 90% rated voltage, and 75% rated current			
Controller Dimensions (W x H x D)	30" x 73.5" x 48" (762 x 1867 x 1219mm)			
Controller Weight (Net)	1400lbs (636 kg)			
HV Source Dimensions (W x H x D)	30" x 39" x 40" (762 x 991 x 1016mm)	30" x 40" x 40" (762 x 1016 x 1016mm)	30" x 50" x 57.5" 762 x 1270x 1461mm	34" x 45" x 58" 864 x 1143 x 1473mm
HV Weight (Net)	2600lbs (1182 kg)	2800lbs (1273 kg)	2900lbs (1315 kg)	3100lbs (1409 kg)

Note: Dimensions and weights are approximate and are subject to change.

* Other output ratings available; consult factory with your requirements.

	Electronic Devices		High Voltage Equipment	
	Temperature	Humidity (r.h. non-condensing)	Temperature	Humidity (r.h. non-condensing)
Operation	+5°C ... +40°C	5...95%	-10°C ...+45°C	5...90%
Storage	-20°C ... +70°C	5...95%	-10°C ...+55°C	5...90%

ECCN	3A992.A
HTS US	9030.39.0100

SCOPE OF SUPPLY

Embedded controller
Regulator
HV transformer
HV warning lamp
Manual, test report, and calibration certificate

CUSTOMER SUPPLIED

Input & output regulator power cables
High voltage output connection to test object
Grounding materials

STANDARD OPTIONS

HHDA13-280 – 120kV rated grounding stick
CF – ≤2pC PD specification
DI-REM-SFTW – Remote control Software with external E-stop button
DI-FO – Fiber optic connection to computer (customer supplied)
GND Braid – Grounding material
HH-700-HS – Hand operated interlock switch
HH-700-FS – Foot operated interlock switch
Casters – Set of casters for regulator & HV tank (if applicable)

700-DI 3-Phase AC Dielectric Test Sets

High Voltage AC Test Systems – 2-100kVA – 3 Phase Output

The HIPOTRONICS line of 3 Phase AC Dielectric Test Systems are designed to perform high voltage AC tests on electrical apparatus in accordance with IEC60, IEEE 4 and IEC 270 and other national test standards. A variety of mechanical configurations are available to suit different installation conditions. Some models can be supplied in mobile versions when it is difficult to move the test object to the test area.

AC Dielectric Test Sets are available in a wide range of voltage and power ratings with exceptional reliability, durability and functionality. No matter what your requirement, HIPOTRONICS has an affordably priced, highly reliable test solution to meet your needs.

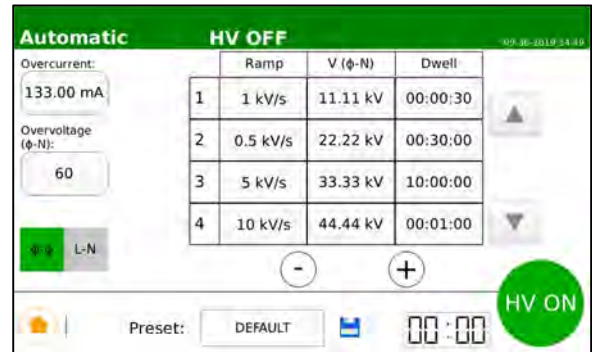

FEATURES

- Microprocessor controller** provides better regulation accuracy and measuring accuracy
- Continuously adjustable test output voltage**
- Selectable 3-Phase or Single-Phase** output
- SIL3** Compatible
- Designed** to operate from 0.5% to 100% of the maximum rated output voltage
- Adjustable Overload** from 10% to 110% of rated current output
- Backup Breaker** overload safety situation
- Output Connected** voltmeter and ammeter
- Zero start interlock** ensures the voltage control is at a minimum before HV can be energized
- Rated current** throughout voltage range

BENEFITS

- Simple to Use** with minimal amount of setup time and intuitive control panel allows for simple testing
- Surge and Transient Protection** on all meters, transformers, etc.
- Partial Discharge Option** allows for low PD levels at full output voltage

APPLICATIONS

- Transformers
- Switchgear
- Rotating Machines
- Sample Cable Lengths
- Rotating Machines

TECHNICAL SPECIFICATIONS

Model #		730-30	775-30	7100-30
System Output	Voltage (Line to Ground)	30kV	75kV	100kV
	Current	333mA	133mA	100mA
Voltage Measurement Accuracy		±1.5% of reading ± 0.2% of full scale		
Ramp Rate Accuracy		+/- 5%		
Measurement Resolution		0.01kV, 0.01mA		
Step Resolution		0.5% of Full Scale		
PD Baseline		≤20pC up to full voltage for oil insulated transformers		
Regulator Dimensions (W x H x D)		30.5" x 58.6" x 31.1" (774.7mm x 1488.4mm x 789.9mm)		
Regulator Weight		513 lbs (639.6kg)	513 lbs (639.6kg)	513 lbs (639.6kg)
HV Transformer Dimensions (W x H x D)		20" x 33" x 25" (510mm x 840mm x 635mm)	25" x 46.2" x 36.8" (635mm x 1175mm x 935mm)	25" x 36.7" x 46" (635mm x 935mm x 1170mm)
HV Transformer Weight (each) Qty 3 total		500lbs (147.9kg)	860lbs (390kg)	900lbs (408kg)
Input Voltage		480V, single phase, 60Hz; 380V, single phase, 50Hz.*		
Duty Cycle		1hr ON / 1hr OFF, 6x/day or Continuous @ 90% rated voltage, and 75% rated current		
ECCN: 3A992.A		HTS US: 9030.39.0100		

Notes: Other output voltage and power rating combinations available; consult factory. The PD level is inherent to the equipment itself without considering possible external radiated interference from the customer's dedicated mains power supply or ground noise. Dimensions & weights are approximate and subject to change.

* Other inputs available. Consult Factory.

	Electronic Components		High Voltage Components	
	Temperature	Humidity (r.h. non-condensing)	Temperature	Humidity (r.h. non-condensing)
Operation	+5°C ... +40°C	5 ... 95%	-10°C ... +45°C	5 ... 90%
Storage	-20°C ... +70°C	5 ... 95%	-10°C ... +55°C	5 ... 90%

SCOPE OF SUPPLY

Embedded controller
 Regulator
 HV transformers (qty 3)
 HV warning lamp
 Manual, test report, and calibration certificate

CUSTOMER SUPPLIED

Input & Output Regulator Power Cables
 Grounding Materials
 High Voltage Output Connection to Test Object

STANDARD OPTIONS

HHDA13-280 – 120kV Rated Grounding Stick
CF - ≤2pC Partial Discharge Specification
DI-REM-SFTW – Remote Control Software with External E-Stop Button
DI-FO – Fiber Optic Connection to computer (customer supplied)
GND Braid – Grounding Material
HH-700-HS – Hand Operated Interlock Switch
HH-700-FS – Foot Operated Interlock Switch
Casters - Set of Casters for Regulator & HV Tanks

AC/DC PDTS

AC / DC Partial Discharge Test Systems

HIPOTRONICS offers a full line of AC and DC systems to suit a wide range of partial discharge test applications. Our systems feature low PD AC and DC power supplies and the AC/DC partial discharge test systems are complete with a high voltage transformer, embedded controls, metering, electronic overload circuitry, status indicator lights, low voltage filtering, zero-start interlock, Digital Partial Discharge Detector, Measuring Capacitor with Measuring Impedance and Calibrator. The systems are designed for testing a wide variety of components including transformers, capacitors, connectors, generators, motors, sample lengths of wire and cable etc. according to industry and national consensus standards.

Our Integrated Systems with Test Chambers are a complete single piece solution to PD testing of HV components and insulation materials. They are simple to install and easy to use.

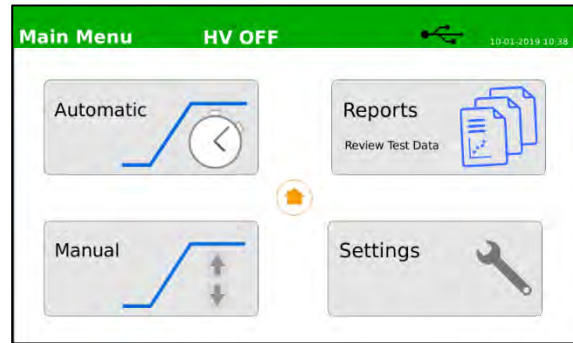

FEATURES

- Microprocessor controller** provides better regulation and measuring accuracy
- Continuously adjustable test output voltage**
- SIL3** compatible
- Designed** to operate from 0.5% to 100% of the maximum rated output voltage
- Wide range** of voltage and current ratings available
- Adjustable Overload** from 10% to 110% of rated current output
- Backup Breaker** overload safety situation
- Zero start interlock** ensures that the voltage control is at a minimum before HV can be energized
- Easy data acquisition** and test report generation

BENEFITS

- Fully integrated solution** ensures simple installation and intuitive control panel allows for simple testing
- Reliable** and proven AC/DC power supplies
- Output Connected Meters** ensures fast and accurate readings

APPLICATIONS

- | | |
|--|--|
| <input checked="" type="checkbox"/> Capacitors | <input checked="" type="checkbox"/> Moulded Products |
| <input checked="" type="checkbox"/> Bushings | <input checked="" type="checkbox"/> Insulation Material |
| <input checked="" type="checkbox"/> Generators | <input checked="" type="checkbox"/> Cable and Wire Samples |
| <input checked="" type="checkbox"/> Connectors | <input checked="" type="checkbox"/> Switches and Arrestors |
| <input checked="" type="checkbox"/> Transformers | <input checked="" type="checkbox"/> Insulated Bus Bars |

TECHNICAL SPECIFICATIONS

Voltage Output Range	0.5-100% of F.S.
Voltage & Current Measurement Accuracy	± 1.5% of Reading ± 0.2% F.S
Measurement Resolution	0.01kV, 0.01mA
Ramp Rate Accuracy	+/- 5%
Step Resolution	0.5% of Full Scale
AC PD Baseline	≤2pC up to full voltage
ECCN: 3A992.A	HTS US: 9030.39.0100

Notes: The partial discharge level is inherent to the equipment itself without considering possible external radiated interference from the customer's dedicated mains power supply or ground noise.

	Electronic Components		High Voltage Components	
	Temperature	Humidity (r.h. non-condensing)	Temperature	Humidity (r.h. non-condensing)
Operation	+5°C ... +40°C	5 ... 95%	-10°C ... +45°C	5 ... 90%
Storage	-20°C ... +70°C	5 ... 95%	-10°C ... +55°C	5 ... 90%

TYPICAL MODELS AND RATINGS

Model	Voltage	Current	Cabinet Size (in) Single bay / Two Bay
705-5[^][^]-DI	5kV AC	1000mA	48"W x 36"D x 84"H / 70"W x 36"D x 84"H
710-5[^][^]-DI	10kV AC	500mA	48"W x 36"D x 84"H / 70"W x 36"D x 84"H
715-5[^][^]-DI	15kV AC	333mA	48"W x 36"D x 84"H / 70"W x 36"D x 84"H
730-5[^][^]-DI	30kV AC	167mA	48"W x 36"D x 84"H / 70"W x 37"D x 84"H
750-5[^][^]-DI	50kV AC	100mA	48"W x 36"D x 84"H / 70"W x 37"D x 84"H
775-5[^][^]-DI	75kV AC	67mA	48"W x 36"D x 84"H / 70"W x 37"D x 84"H
730-10D[^][^]-B	30kV AC	333mA	70"W x 36"D x 84"H
750-10D[^][^]-B	50kV AC	200mA	70"W x 36"D x 84"H
775-10D[^][^]-B	75kV AC	133mA	70"W x 36"D x 84"H
710/875-	10kV AC / 75kV DC	4000mA AC / 13mA DC	70"W x 49"D x 80"H
730/830-	30kV AC / 30kV DC	167mA AC / 5mA DC	70"W x 36"D x 76"H
720/850-	20kV AC / 50kV DC	1000mA AC / 5mA DC	70"W x 36"D x 76"H
730/850-	30 kV AC / 50kV DC	333mA AC / 5mA DC	70"W x 36"D x 76"H
730/875-	30kV AC / 75kV DC	67mA AC / 13mA DC	70"W x 45"D x 93"H

* 5 = 50Hz, 6 = 60Hz

** 1 = single bay test chamber; 2 = 2 bay test chamber; x = no test chamber, separate components

[^] = Type of Partial Discharge Detector. Consult Factory.

Note: Other voltage and power rating combinations are available. Consult Factory.

SCOPE OF SUPPLY

HV Power Source including regulator or amplifier, low voltage filter, and HV tank

Embedded Controls with touch screen

Measuring Capacitor, including measuring impedance

PD Detector and Calibrator

Test Chamber (if applicable)

HV Warning lamp

Manual, test report, and calibration certificate

STANDARD OPTIONS

DSIT-# – Double Shielded Isolation Transformer.

= kVA of transformer

DI-REM-SFTW – Remote control software with external E-stop button

DI-FO-& - Fiber optic connection from cabinet to laptop (not supplied)

& = length of fiber optic cable

HH-700-HS – Hand operated interlock switch

HH-700-FS – Foot operated interlock switch

Casters-B – Set of casters for system

CUSTOMER SUPPLIED

Input Power Cable

DC Power Packs

High Voltage DC Power Supplies

■ **HIPOTRONICS'** DC Power Packs are complete high voltage sections designed for OEM use or any application requiring high voltage at low current levels. Controls, metering and circuit protection such as circuit breakers or fuses are not included. A built-in meter multiplier resistor is supplied in the units rated 30kV and higher where an external voltage divider might cause problems. All power packs are hermetically sealed in oil or epoxy filled meta cans and all feature solid-state rectifiers.

These units are designed to supply 2 to 10mA at high voltage on a continuous basis. They are suitable for use in X-ray systems, laser systems, low power precipitators and as general-purpose high voltage DC sources. All units have surge limiting resistors in the output. However, for applications requiring frequent "slap-on", small series impedance should be used in the input. Consult our sales department for these and other special applications.

2.5kV to 60kV Power Packs

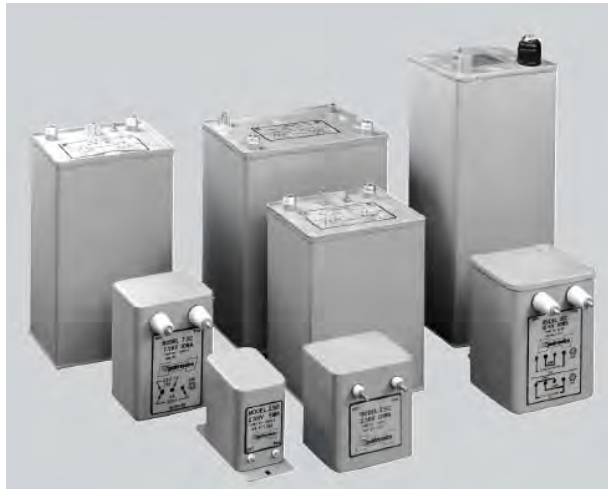

FEATURES

- ☑ **Compact Size**
- ☑ **Metal Can Construction**
- ☑ **Surge Limited Resistors** in output
- ☑ **Continuous Duty Rated** at maximum rating
- ☑ **115 or 220 V 50/60Hz** selectable input
- ☑ **Bleed Resistors Built** into output
- ☑ **Epoxy or Oil Insulated** in a hermetically sealed unit
- ☑ **Reversible Polarity**

BENEFITS

- Compact** – saves valuable space in product package
- Rugged Design** – suited for use in harsh environments
- Built in Bleeder Resistors** –doesn't hold charge when power is turned off
- Hermetically Sealed** – Moisture can't enter high voltage tank

APPLICATIONS

- **X-ray Systems**
- **Laser Systems**
- **Precipitators**
- **Medical Equipment**
- **General Purpose HV Source**

TECHNICAL SPECIFICATIONS

General	PP205-5	PP205-10	PP5-5	PP705-10	PP10-5	PP10-10	PP15-10
Input Voltage	120V, 60Hz/220V, 50Hz						
Input Current	115V .5A 220V .25A	115V 1A 220V .5A	115V 1A 220V .5A	115V .75A 220V .4A	115V 1.5A 220V 1A	115V 2A 220V 1A	115V 2A 220V 1A
Output Voltage	2.5kV		5kV	7.5kV	10kV		15kV
Output Current	5mA	10mA	5mA	10mA	5mA	10mA	
Regulation	Less than 15%						
Ripple	0.5% per mA of output current						
Insulation	Epoxy					Oil	
Internal Shorting	Bleed Resistors						
Polarity	Reversible						
Dimensions	Referenced Below						
Weights	3.25 lb. 1.5 kg	6 lb. 2.7 kg	6 lb. 2.7 kg	8 lb. 3.6 kg	7 lb. 3.2 kg	11.8 lb. 5.4 kg	11.8 lb. 5.4 kg

General	PP20-5	PP30-5	PP30-10	PP50-5	PP60-2	PP100-5*	PP100-10
Input Voltage	120V, 60Hz/220V, 50Hz						
Input Current	115V 2A 220V 2A	115V 2A 220V 1A	115V 3A 220V 1.5A	115V 3A 220V 1.6A	115V 2A 220V 1A	*115V 6A Only	115V 12A 220V 6A
Output Voltage	20kV	30kV	30kV	50kV	60kV	100kV	100kV
Output Current	5mA		10mA	5mA	2mA	5mA	10mA
Regulation	Less than 15%						
Ripple	0.5% per mA of output current						
Insulation	Oil						
Internal Shorting	Bleed Resistors						
Polarity	Reversible						
Dimensions	Referenced Below						
Weights	11.8 lb. 5.4 kg	15 lb. 6.8 kg	17.8 lb. 8.1 kg	30 lb. 13.6 kg	30 lb. 13.6 kg	80 lb. 36 kg	150 lb. 68 kg

DIMENSIONS

PP205-5	3.5625in.H x 2.75in.W x 5.5in.D (90mmH x 70mmW x 140mmD)
PP205-10	4.375in.H x 4.8125in.W x 4.25in.D (111mmH x 122mmW x 109mmD)
PP5-5	4.375in.H x 4.8125in.W x 4.25in.D (111mmH x 122mmW x 109mmD)
PP705-10	5.9375in.H x 5.375in.W x 4.75in.D (135mmH x 137mmW x 121mmD)
PP10-5	5.9375in.H x 5.375in.W x 4.75in.D (135mmH x 137mmW x 121mmD)
PP10-10	6.1666in.H x 6.125in.W x 5.6875in.D (150mmH x 158mmW x 143mmD)
PP15-10	6.1666in.H x 6.125in.W x 5.6875in.D (150mmH x 158mmW x 143mmD)
PP20-5	6.1666in.H x 6.125in.W x 5.6875in.D (150mmH x 158mmW x 143mmD)
PP30-5	9.5in.H x 5in.W x 6in.D (243mmH x 127mmW x 153mmD)
PP30-10	11.5in.H x 5in.W x 6in.D (293mmH x 127mmW x 153mmD)
PP50-5	11.5in.H x 6in.W x 6in.D (295mmH x 153mmW x 153mmD)
PP60-2	11.5in.H x 6in.W x 6in.D (295mmH x 153mmW x 153mmD)
PP100-5	16in.H x 11.5W x 9in.D (406mmH x 292mmW x 229mmD)
PP100-10	20.5in.H x 15in.W x 10in.D (512mmH x 381mmW x 254mmD)

ISOLATION TRANSFORMER

High Voltage DC Isolation Transformers

■ **High Voltage DC Isolation Transformers** are used to provide AC power to circuits that are operated at a DC voltage for either polarity above ground potential. All units are conservatively designed for continuous operation with high reliability. Low internal losses eliminate the need for external cooling in ambient temperatures up to 40 degrees Celsius. Electrostatic shields (one or more) are provided to reduce voltage stresses and low voltage coupled noise. Each transformer is constructed of high quality dielectric materials and processed to assure long life.



FEATURES

- ☑ Epoxy encapsulated.
- ☑ Three single phase units can be arranged for three phase operation.
- ☑ Conservative design with high quality dielectric materials.
- ☑ Custom available single or three phase units available for OEM applications.

BENEFITS

Epoxy insulated units meet UL94V-0 flame retardance specifications.

Low capacitance reduces stored energy at high voltage.

Epoxy eliminates need for oil insulation.

Compact size reduces weight compared to comparable oil insulated units.

Double shielding reduces ground coupling noise.

Low internal losses eliminates the need for external cooling.

APPLICATIONS

Testing of insulating liquids in:

- Ion implant systems.
- Industrial lasers.
- Modular systems.
- Deposition systems.
- Electron beam lithography systems.
- Electron beam welding systems.
- Medical lasers.
- High voltage power supplies.
- All types of accelerators.

TECHNICAL SPECIFICATIONS

The following must be specified when choosing an isolation transformer:

- Isolation Voltage – DC reference voltage with respect to ground at which the equipment will operate.
- Rated kVA – Maximum continuous kVA rating of transformer (after adjustment for harmonics is taken into account).
- Input Voltage – Voltage near ground potential.
- Output Voltage – Voltage above ground reference by the value of DC isolation voltage.

Catalog Number	DC Isolation Voltage kV*	Power Ratings kVA	Input Voltage V	Output Voltage V	Frequency Hz	Dimensions L x W x H inches	Weight Lbs.
IT25-05E-A-A	25	0.5	115	115	60	7 x 4 ³ / ₄ x 6 ¹ / ₂	18
IT50-1E-A-A	50	1.0	115	115	50/60	10 ⁷ / ₈ x 7 ⁷ / ₈ x 14	65
IT50-1E-B-B	50	1.0	220	220	50/60	10 ⁷ / ₈ x 7 ⁷ / ₈ x 14	65
IT50-1E-AB-A	50	1.0	110 or 220	115	50/60	10 ⁷ / ₈ x 7 ⁷ / ₈ x 17 ¹ / ₂	65
IT100-1E-A-A	100	1.0	115	115	50/60	10 ⁷ / ₈ x 7 ⁷ / ₈ x 17 ¹ / ₂	65
IT100-1E-B-B	100	1.0	220	220	50/60	10 ⁷ / ₈ x 7 ⁷ / ₈ x 17 ¹ / ₂	65
IT100-1E-AB-A	100	1.0	110 or 220	115	50/60	16 x 11 ¹ / ₂ x 17 ¹ / ₂	65
IT50-5E-A-A	50	5.0	120	120	50/60	16 x 11 ¹ / ₂ x 17 ¹ / ₂	200
IT50-5E-B-B	50	5.0	220	220	50/60	16 x 11 ¹ / ₂ x 20	200
IT100-5E-BC-AJ	100	5.0	120 or 240	208 or 220	50/60	16 x 11 ¹ / ₂ x 20	200
IT100-5E-B-B	100	5.0	220	220	50/60	16 x 11 ¹ / ₂ x 20	200
IT100-5E-AC-AB	100	5.0	115 or 208	115 or 220	50/60	16 x 11 ¹ / ₂ x 20	200

* Negative rating. Consult factory for positive rating.

ADDITIONAL BENEFITS

- Simplified installation and mounting due to small size and low weight.
- Less stored energy.
- Flame retardant materials meet NFPA, SEMICON, and other regulation.
- Extended tracking and puncture path.
- More durable/longer life due to high dielectric strength of cast epoxy.
- No exposed windings to attract dust/dirt and cause flashovers.
- Shield constructions helps eliminate stress on high voltage windings caused by system transients.

Motor Test Systems

Low & High Power AC/DC Motor Test Systems

HIPOTRONICS has been the leading manufacturer of complete AC and DC motor test systems since 1962. Our experience over the past 50+ years has enabled us to develop the most reliable and efficient test systems on the market. All of our manufacturing is done in-house to provide the highest level of quality. Our standardized design, patented Peschel Variable Transformer (PVT), and rugged motorized tap switches provide years of operation with minimal maintenance.

Our test sets include a 10 inch (25cm) color touch screen controller with intuitive menu functions. A standard digital tachometer and wattmeter allow for conveniently displayed measurements on the control interface, as well as temperature and power factor metering. Fast and easy test reports can be generated using data acquisition software on any computer.



We are a proud member of The Electrical Apparatus Service Association (EASA). EASA provides members with a means of keeping up to date on materials, equipment, and state-of-the-art technology.



FEATURES

- ☑ **Measurement Devices** included with all models:
 - Digital Tachometer
 - Digital Wattmeter
 - Temperature Meter (Type – E)
 - Power Factor Meter
 - Data Acquisition Software
- ☑ **Emergency OFF switch** and warning lamp for increased safety
- ☑ **Control power circuit breaker**
- ☑ **Motorized tap selector switch** decreases start up time
- ☑ **Primary overload protection**
- ☑ **Digital voltage and current meters** for accurate measurements
- ☑ **Interlocked HV taps** increase user safety
- ☑ **Lifting provisions (crane and forklift)**
- ☑ **External Interlock provisions**

BENEFITS

- ☑ Variable transformer offers the most **stable output** available.
- ☑ **Continuous variable voltage** from near zero to full voltage.
- ☑ **Complete metering** to verify conditions of motor under test.
- ☑ **Decreased startup cost** with minimal mains wiring required.
- ☑ Motorized tap switch uses the **latest technology** to ensure reliable and accurate testing.
- ☑ **Touch screen PLC controls** require minimal user training.
- ☑ Patented PVT design allows for **smaller footprint** and **fewer moving parts**.
- ☑ Integrated **safety and overload protection**.

TECHNICAL SPECIFICATIONS

Model	MTC-150	MTC-300	MTC-500	MTC-750	MTC-1000V	MTC-1500V	MTC-2000V
System KVA	150	300	500	750	1000	1500	2000
Input Voltage (V)	480V, 3p	480V, 3p	480V, 3p	480V, 3p	480V, 3p	480V, 3p	4160V, 3p
Input Current (A)	200	400	600	1000	1250	1850	280
AC No-Load test Capabilities (HP)*	750	1500	2500	3750	5000	7500	10000
AC Full-Load Test Capabilities (HP)*	150	300	500	750	1000	1500	2000
Duty Cycle AC Supply	Continuous, 110% 1 Hour on / 1 Hour off, 250% for 1 minute						
Output Tap							
0 to 240V	360A	N/A	N/A	N/A	N/A	N/A	N/A
0 to 480V	180A	360 A	600 A	900 A	1000A	1000A	N/A
0 to 600V	144A	289 A	480 A	720 A	960A	1000A	1200A
0 to 1200V	72A	144 A	240 A	360 A	480A	720A	960A
0 to 2400V	36A	72 A	120 A	180A	240A	360A	480A
0 to 3300V	N/A	52 A	87 A	130 A	175A	262A	350A
0 to 4160V	N/A	42 A	70 A	104 A	139A	208A	278A
0 to 7200V	N/A	Optional	Optional	Optional	Optional	120A	160A
0 to 11,000V	N/A	N/A	Optional	Optional	Optional	Optional	Optional
0 to 13,800V	N/A	N/A	Optional	Optional	Optional	Optional	Optional
DC Armature Supply							
Voltage (V DC)	0...650	0...650	0...650	0...750	0...750	0...750	0...750
Current (A)	200	425	625	900	900	1200	1500
DC Field Supply	300V, 10A	0 ... 700V DC 90A, 5% Ripple RMS					
Field Supply #2 (optional)	0 ... 12V DC 500A, 48% Ripple RMS						

1. The model prefix **MTC** applies to systems with both **AC & DC** testing capabilities.
2. For Motor Test Systems with **AC** capabilities only, the DC specifications in the gray shaded area above are eliminated and model prefix changes to **MTA**.
3. Larger and smaller units may be available upon request.
4. Other input voltages may be available upon request.
5. No-Load and Load calculations are approximate and may vary with each specific customer and application.

OPTIONAL EQUIPMENT & ACCESSORIES

- RTD Temperature Measurement Input
- Boom Arm Output
- Impedance supply
- Vibration Analyzer
- Additional Voltage Taps
- Optional Series Field Supply
- Input Volt and Current Meters



Be sure to download the new *Motor Test Series Product Guide* from our website.

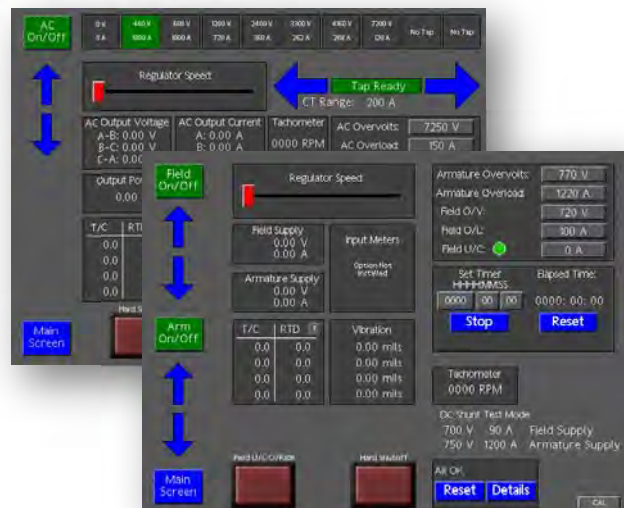

PVT Series

Peschel Variable Transformer

■ The Peschel® Variable Transformer was designed specifically for high power applications. The PVT Series is a simple, economical and high power solution for variable voltage requirements. This product has been put to the test in wide range of applications. It's been proven to be the best method to achieve a high power variable voltage output, while maintaining a clean sinusoidal wave shape.

The PVT Series design has reduced the mass of coils and high cost impact on the power test systems normally associated with variable transformers. It has also eliminated the shorted turn problem and carbon brushes that are common to all variable transformers.

This product can supply up to 120A from a single coil and 240A from two coils on a single core assembly. It is highly efficient in a smaller, lighter package and can be used in applications previously impossible with other variable transformers. With its proven reliability, ease of service and reasonable price there are a wide range of options.



FEATURES

- ☑ **Continuously adjustable output**
- ☑ **Compact, linearly wound design**
- ☑ **Up to 200% voltage step up at full rated current***
- ☑ **Up to 120A from a single coil**
- ☑ **No shorted coil turns**
- ☑ **Negligible phase imbalance**
- ☑ **Dry type convection cooled**
- ☑ **Rugged electrical and mechanical design**

BENEFITS

- Ease of use**
- Compact - takes up less space**
- Negligible output distortion**
- Long life - Low maintenance**
- Runs cooler**
- Less costly throughout**

APPLICATIONS

Primary voltage control of:

- High Voltage Power Supplies
- High Current Power Supplies Testing:
- Appliances
- Motors
- Transformers
- Power Supplies
- UPS units
- Inverters
- Production Line
- Heat Runs

THE PVT DESIGN

- Copper coils are wound on a rectangular coil form, providing separate tracks of odd and even coil turns.
- Coil face is cast in epoxy, then sanded to expose the copper turns. The copper turns are then nickel plated.
- Coil is assembled over the laminated steel core in a vertical configuration, providing a chimney like effect that is highly efficient for convection cooling.
- Sliding copper contacts traverse the odd and even turns. Our patented design eliminates the shorted coil turn problem and allows power handling at levels that are unattainable with toroid designs.
- The contact assembly is motor driven and can be controlled by simple push-button switches or automatic controllers.

TECHNICAL SPECIFICATIONS

Efficiency	98 – 99%
Duty	Continuous to 50°C ambient
Cooling	Dry-type convection cooled
Humidity	95% non-condensing
Short Circuit Overload	12 times rated current for 200 mSec
Impedance (Typical)	1-3% - varies with brush position
Frequency	47 ... 63 Hz
Output Imbalance	Less than 1%
Output Distortion	Negligible

SINGLE PHASE INPUT: 240V

240V models can also operate from 208V and 220V, output voltage is reduced proportionally.

VARIABLE OUTPUT: 0 - 300V

		Model Number						
		Current (A)	DIAG.	% Resolution	Dimension s (W x D x H)	Weight (lbs.)	Cabinet Code	
30A24-30S5	21							
30A24-30S7	30	50	1	0.69	15 x 19 x 32	250	CB	
30A24-30S10	36	70	1	0.69	15 x 19 x 32	275	CB	
30A24-30S12	42	100	1	0.69	15 x 20 x 37	325	CB	
30A24-30S14	57	120	1	0.69	17 x 20 x 37	355	CB	
30A24-30S19	72	140	2	0.69	19 x 20 x 32	320	CC1	
30A24-30S24	108	190	2	0.69	19 x 21 x 37	380	CC1	
30A24-30S36	132	240	2	0.69	19 x 21 x 37	420	CC1	
30A24-30S44	108	360	2+	0.69	19 x 21 x 63	675	CC1	
30A24-30S44	132	440	2+	0.69	19 x 21 x 63	750	CC1	

+ Double Coil PVT

VARIABLE OUTPUT: 0 - 480V

Model Number	kVA	Current (A)	DIAG.	% Resolution	Dimensions (W x D x H)	Weight (lbs.)	Cabinet Code
30A24-48S5	24	50	1	0.44	15 x 20 x 40	335	CB
30A24-48S7	34	70	1	0.44	15 x 20 x 40	360	CB
30A24-48S10	48	100	1	0.67	15 x 21 x 37	460	CB
30A24-48S12	57	120	1	0.67	15 x 21 x 37	500	CB
30A24-48S14	67	140	2	0.44	19 x 20 x 40	425	CC1
30A24-48S20	96	300	2	0.67	19 x 22 x 37	525	CC1
30A24-48S24	115	240	2	0.67	21 x 23 x 37	625	CC1
30A24-48S36	173	360	2+	0.67	19 x 23 x 64	975	CC1
30A24-48S44	211	440	2+	0.67	21 x 24 x 64	1125	CC1

SINGLE PHASE INPUT: 480V

480 models can also operate from 380V, 400V, 415V and 440V, output voltage is reduced proportionally.

VARIABLE OUTPUT: 0 - 480V

Model Number	kVA	Current (A)	DIAG.	% Resolution	Dimensions (W x D x H)	Weight (lbs.)	Cabinet Code
30A48-48S6	29	60	1	0.67	15 x 22 x 32	335	CC
30A48-48S9	43	90	1	0.67	15 x 21 x 37	400	CC
30A48-48S12	57	120	1	0.67	17 x 22 x 37	420	CC
30A48-48S14	67	140	2	0.67	19 x 20 x 40	425	CC1
30A48-48S18	86	180	2	0.67	19 x 21 x 37	470	CC1
30A48-48S24	115	240	2	0.67	21 x 22 x 37	480	CC1
30A48-48S36	173	360	2+	0.67	19 x 23 x 64	1000	CC1
30A48-48S44	211	440	2+	0.67	21 x 24 x 64	1150	CC1

+ Double Coil PVT

VARIABLE OUTPUT: 0 - 600V

Model Number	kVA	Current (A)	DIAG.	% Resolution	Dimensions (W x D x H)	Weight (lbs.)	Cabinet Code
30A48-60S5	30	50	1	0.70	17 x 21 x 32	375	CC
30A48-60S7	42	70	1	0.70	17 x 21 x 32	400	CC
30A48-60S10	60	100	1	0.70	17 x 22 x 36	435	CC
30A48-60S12	72	120	1	0.70	17 x 22 x 36	455	CC
30A48-60S14	84	140	2	0.70	19 x 21 x 34	485	CC1
30A48-60S19	114	190	2	0.54	21 x 22 x 42	540	CC1
30A48-60S24	144	240	2	0.70	21 x 22 x 38	600	CC1
30A48-60S36	216	360	2+	0.70	17 x 22 x 64	990	CC1
30A48-60S44	264	440	2+	0.70	17 x 22 x 64	1075	CC1

+ Double Coil PVT

VARIABLE OUTPUT: 0 - 960V							
Model Number	kVA	Current (A)	DIAG.	% Resolution	Dimensions (W x D x H)	Weight (lbs.)	Cabinet Code
30A48-96S5	48	50	1	0.44	17 x 21 x 40	500	CC
30A48-96S7	67	70	1	0.44	17 x 21 x 40	535	CC
30A48-96S10	96	100	1	0.44	17 x 24 x 47	625	CC1
30A48-96S12	115	120	1	0.44	21 x 22 x 47	670	CC1
30A48-96S14	134	140	2	0.44	21 x 22 x 42	700	CC1
30A48-96S19	182	190	2	0.44	21 x 24 x 49	825	CC1
30A48-96S24	230	240	2	0.44	21 x 24 x 48	905	CC1
30A48-96S38	365	380	2+	0.44	30 x 54 x 52	1825	*
30A48-96S48	461	480	2+	0.44	30 x 54 x 51	1945	*

+ Double Coil PVT

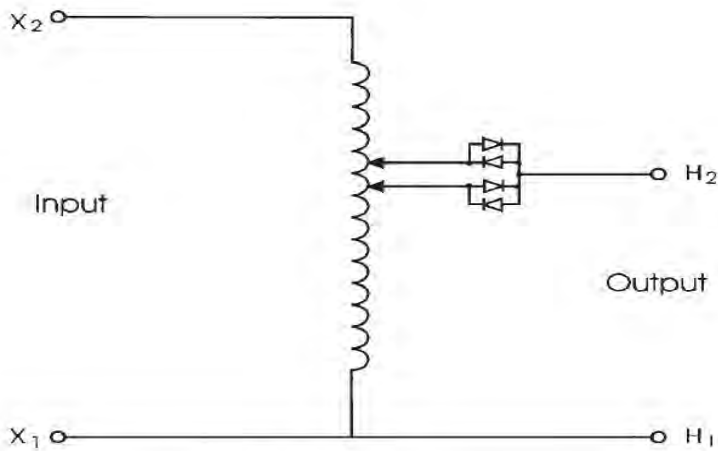
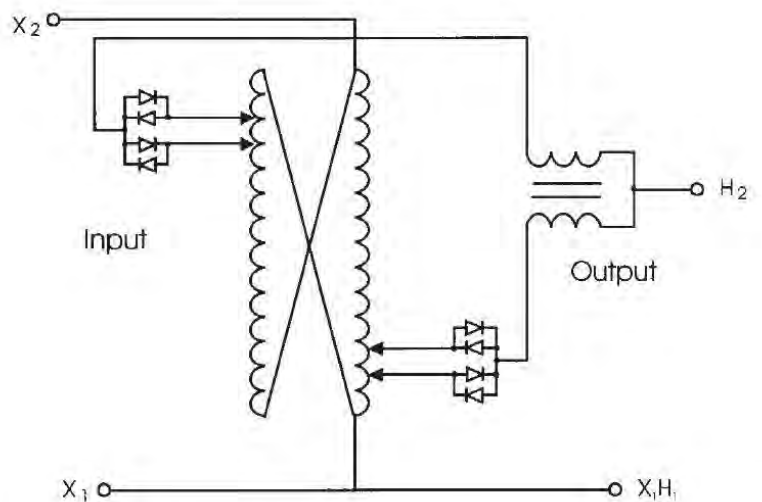

Fig.1: Single Phase, One-Coil System (pictured left)

Fig.2: Single Phase, Two-Coil System (pictured right)



THREE PHASE INPUT: 240V

240 models can also operate from 208V and 220V, output voltage is reduced proportionally.

VARIABLE OUTPUT: 0 - 300V

Model Number	kVA	Current (A)	DIAG.	% Resolution	Dimensions (W x D x H)	Weight (lbs.)	Cabinet Code
30A24-30Y5	26	50	3	0.58	20 x 19 x 34	300	CC1
30A24-30Y7	36	70	3	0.58	23 x 19 x 34	350	CC1
30A24-30Y10	52	100	3	0.72	23 x 19 x 36	425	CC1
30A24-30Y12	62	120	3	0.72	23 x 19 x 36	475	CC1
30A24-30Y15	78	150	3+	0.72	23 x 20 x 52	590	CC1
30A24-30Y19	99	190	3+	0.72	23 x 20 x 61	675	CC1
30A24-30Y24	125	240	3+	0.72	26 x 22 x 61	750	CD
30A24-30Y38	197	380	3++	0.72	26 x 54 x 64	1675	*
30A24-30Y48	249	480	3++	0.72	36 x 54 x 64	1835	*

+Double Coil PVT

++Two Double Coil PVTs

*Consult factory

480 models can also operate from 380V, 400V, 415V and 440V, output voltage is reduced proportionally.

VARIABLE OUTPUT: 0 - 480V

Model Number	kVA	Current (A)	DIAG.	% Resolution	Dimensions (W x D x H)	Weight (lbs.)	Cabinet Code
30A48-48S5	42	50	3	0.75	23 x 19 x 31	440	CC1
30A48-48S7	59	70	3	0.75	26 x 20 x 31	490	CC1
30A48-48S10	83	100	3	0.75	26 x 21 x 35	630	CC1
30A48-48S12	100	120	3	0.75	26 x 21 x 35	690	CC1
30A48-48S14	116	140	3+	0.75	26 x 21 x 50	830	CD
30A48-48S19	158	190	3+	0.75	26 x 21 x 59	1050	CD
30A48-48S24	200	240	3+	0.75	29 x 22 x 60	1150	CD
30A48-48S38	316	380	3++	0.75	26 x 54 x 62	2425	*
30A48-48S38	399	480	3++	0.75	26 x 54 x 63	3635	*

+Double Coil PVT

++Two Double Coil PVTs

*Consult factory

THREE PHASE INPUT: 480V

480V models can also operate from 380V, 400V, 415V and 440V, output voltage is reduced proportionally.

VARIABLE OUTPUT: 0 - 480V

Model Number	kVA	Current (A)	DIAG.	% Resolution	Dimensions (W x D x H)	Weight (lbs.)	Cabinet Code
30A48-48Y5	41	50	3	0.75	23 x 19 x 31	375	CC1
30A48-48Y7	58	70	3	0.75	23 x 19 x 31	400	CC1
30A48-48Y10	83	100	3	0.75	23 x 20 x 35	450	CC1
30A48-48Y12	100	120	3	0.75	26 x 20 x 35	500	CC1
30A48-48Y13	108	130	3+	0.75	23 x 20 x 35	725	CC1
30A48-48Y19	158	190	3+	0.75	23 x 20 x 58	800	CC1
30A48-48Y22	183	220	3+	0.75	26 x 21 x 58	900	CD
30A48-48Y26	216	260	3++	0.75	36 x 54 x 53	1775	*
30A48-48Y38	316	380	3++	0.75	36 x 54 x 61	1925	*
30A48-48Y44	366	440	3++	0.75	36 x 54 x 61	2125	*
30A48-48Y52	432	520	3+++	0.75	60 x 60 x 53	3600	*
30A48-48Y76	632	760	3+++	0.75	60 x 60 x 61	4000	*
30A48-48Y88	732	880	3+++	0.75	60 x 60 x 61	4400	*

+Double Coil PVT
 ++Two Double Coil PVTs
 +++Four Double Coil PVTs

*Consult factory

VARIABLE OUTPUT: 0 - 600V

Model Number	kVA	Current (A)	DIAG.	% Resolution	Dimensions (W x D x H)	Weight (lbs.)	Cabinet Code
30A48-60Y5	52	50	3	0.60	23 x 19 x 34	400	CC1
30A48-60Y7	73	70	3	0.60	23 x 19 x 34	450	CC1
30A48-60Y10	104	100	3	0.60	23 x 19 x 39	500	CC1
30A48-60Y12	125	120	3	0.75	26 x 21 x 35	600	CC1
30A48-60Y13	135	130	3+	0.60	23 x 20 x 57	825	CC1
30A48-60Y19	198	190	3+	0.75	23 x 20 x 59	950	CC1
30A48-60Y24	250	240	3+	0.75	26 x 21 x 59	1050	CD
30A48-60Y26	270	260	3++	0.60	36 x 54 x 60	1975	*
30A48-60Y38	395	380	3++	0.75	36 x 54 x 62	2225	*
30A48-60Y48	500	480	3++	0.75	36 x 54 x 62	2425	*
30A48-60Y52	540	520	3+++	0.75	60 x 60 x 60	4000	*
30A48-60Y76	790	760	3+++	0.75	60 x 60 x 62	4600	*
30A48-60Y96	1000	960	3+++	0.75	60 x 60 x 62	5000	*

+Double Coil PVT
 ++Two Double Coil PVTs
 +++Four Double Coil PVTs

*Consult factory

VARIABLE OUTPUT: 0 - 960V

Model Number	kVA	Current (A)	DIAG.	% Resolution	Dimensions (W x D x H)	Weight (lbs.)	Cabinet Code
30A48-96Y5	83	50	3	0.38	23 x 19 x 44	575	CC1
30A48-96Y7	116	70	3	0.38	23 x 20 x 44	650	CC1
30A48-96Y10	166	100	3	0.58	26 x 22 x 40	800	CD
30A48-96Y12	200	120	3	0.58	26 x 22 x 40	900	CD
30A48-96Y14	233	140	3+	0.58	26 x 22 x 58	1250	CD
30A48-96Y19	316	190	3+	0.58	26 x 22 x 69	1500	CD
30A48-96Y24	400	240	3+	0.58	26 x 23 x 69	1675	CD
30A48-96Y28	466	280	3++	0.58	36 x 54 x 61	2850	*
30A48-96Y38	632	380	3++	0.58	36 x 54 x 72	3350	*
30A48-96Y48	798	480	3++	0.58	36 x 54 x 72	3700	*
30A48-96Y56	931	560	3+++	0.58	60 x 60 x 61	5800	*
30A48-96Y76	1264	760	3+++	0.58	60 x 60 x 72	6825	*
30A48-96Y96	1596	960	3+++	0.58	60 x 60 x 72	7600	*

+Double Coil PVT
 ++Two Double Coil PVTs
 +++Four Double Coil PVTs

*Consult factory.

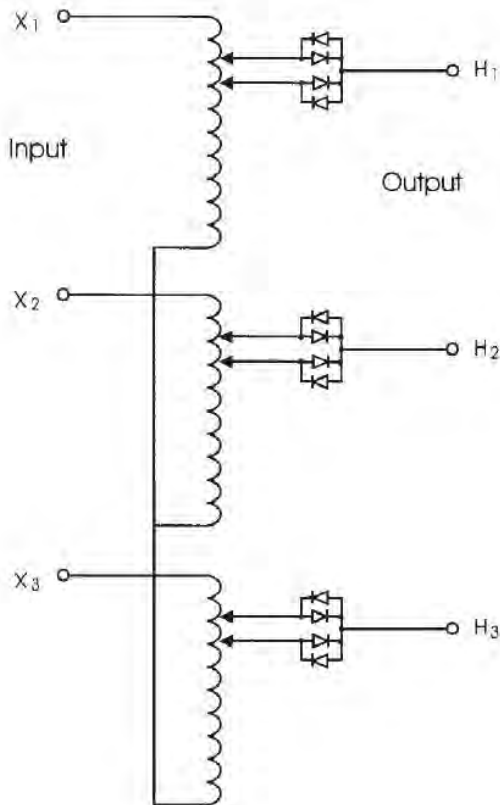

Fig.3: Three Phase WYE System

Input: 3-Phase WYE or Delta
Output: 3-Phase WYE, load can be connected WYE or Delta

(pictured left)

COIL FACE

PVT coils are cast in epoxy to provide a smooth coil face for brush travel. The coil face is sanded to expose two sets of coil turns.

OVERLOAD PROTECTION

THE PVT has a very low impedance characteristic. The internal impedance is low enough to pass over 20 times normal current. Unless specified and quoted, the PVT does not include overload protection. The user must provide adequate overload protection.

LONG LIFE - LOW MAINTENANCE

THE PVT has been designed to very high industry standards and will last many years. Proper preventive maintenance and inspection procedures should be performed to insure the maximum life. The "Users Manual", supplied with each PVT, outlines the procedures that should be followed.

RATINGS

PVTs are designed with sufficient safety margins. The coils are wound with Class H insulated wire to enable full current ratings with ambient temperatures up to 50° C. Diode heat sinks are designed to keep diode junction temperatures far below rating.

DIODES

The diode blocking circuit utilizes standard, stud mounted, silicon rectifiers. In this application, the diodes are selected for their forward voltage drop. There is no PIV stress placed on the diodes, thus eliminating the possibility of overvoltage failure.

OTHER PVT INFORMATION

In addition to the models outlined in this data sheet, HIPOTRONICS manufactures variable transformers with isolated primary and secondary designs that can supply output voltages up to 6900 volts. For information about the Higher Voltage PVTs request data from the factory.

DC POWER SUPPLIES

High Voltage DC Power Supplies

HIPOTRONICS high power ranges of supplies are either air or oil insulated. There are numerous protection features provided in these power supplies including input and backup breakers, user defined overload and overvoltage settings, fast overload sensor, zero-start interlock plus provision for external safety interlock, current-limiting resistor in output circuit, output shorting solenoid (and/or stiff resistive bleeders), and fuse or circuit breaker protection of controls.

Rated current is available from zero to maximum voltage. All power supplies feature solid-state rectifiers, meter calibration, surge/transient protection of meters, relays, and voltage regulators. Controls include optional meter polarity-reversing output button in addition to input power and overload circuits.

DC Power Supplies are available in a wide range of voltage (1kV to 200kV) and power ratings (1kW to 25kW) with exceptional reliability, durability, and functionality. For higher ratings, consult factory.

No matter your test requirements, HIPOTRONICS has highly reliable test solutions to meet your testing needs.

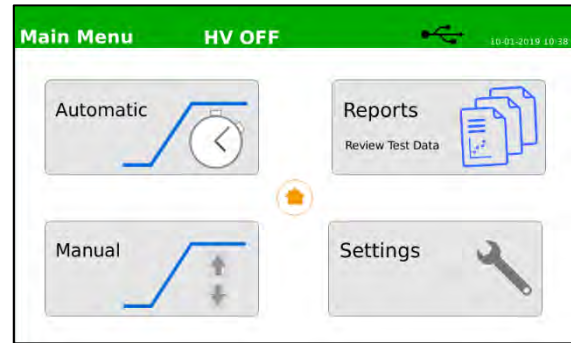

FEATURES

- Continuously adjustable test voltage** from 0.5% to 100% of rated voltage
- Microprocessor controller** provides better regulation accuracy and measuring accuracy
- Shielded output cable**
- Adjustable Overload** from 0% to 110% of rated current output
- Backup Breaker** overload safety situation
- Zero start interlock** ensures that the voltage control is at zero before HV can be energized
- Shorting solenoid** grounds output cable and object under test

BENEFITS

- Simple to Use** – minimal amount of setup time and simple control panel allows simple testing
- Operator Safety** – the power supply and test object are automatically grounded when high voltage is turned off
- Output Connected Meters** – allows for fast accurate readings
- Shielded Coaxial Output Cable** – allows for easy connection to test object

APPLICATIONS

- Accelerators
- X-Ray Systems
- DC Transmission Line Components
- High Voltage Power Sources

TECHNICAL SPECIFICATIONS

Output Voltage	Up to 200kV
Output Power	Up to 25kW
Output Polarity	Positive or Negative output in respect to ground*
Voltage Metering Accuracy	±1.5% of reading ± 0.2% of full scale
Regulation	Between 10% to 18% No Load to Full Load **
Ripple	Between 2% rms and 5% rms ***
Ramp Rate Accuracy	+/- 5%
Measurement Resolution	0.01kV, 0.01mA
Step Resolution	0.5% of Full Scale
Partial Discharge Rating	Available for certain models. Consult Factory
Input Frequency	50/60Hz
Input Voltage	115V – 480V, 1Φ or 3Φ ****
Duty Cycle	Continuous
Languages	English, French German, Mandarin, Spanish, Portuguese
ECCN: 3A992.A	HTS US: 9030.39.0100

Notes: Higher output rating combinations available. Consult Factory with your testing requirements.

* Reversible Polarity option available for certain models. Consult Factory.

** Value dependent on voltage and power rating.

*** Value dependent on voltage and power rating. 1% rms ripple option available in certain models.

**** Input voltage and configuration dependent on system's power rating. Consult Factory.

	Electronic Components		High Voltage Components	
	Temperature	Humidity (r.h. non-condensing)	Temperature	Humidity (r.h. non-condensing)
Operation	+5°C ... +40°C	5 ... 95%	-10°C ... +45°C	5 ... 90%
Storage	-20°C ... +70°C	5 ... 95%	-10°C ... +55°C	5 ... 90%

SCOPE OF SUPPLY

Embedded controller

All-in-one cabinet or separate regulator and HV transformer

HV warning lamp

Manual and Test Report

CUSTOMER SUPPLIED

Input/output regulator power cables (if applicable)

High voltage output connection to test object

Grounding materials

STANDARD OPTIONS

HHDA13-280 – 120kV rated grounding stick

DI-REM-SFTW – Remote control Software with external E-stop button

DI-FO – Fiber optic connection to computer (customer supplied)

GND Braid – Grounding material

HH-800-HS – Hand operated interlock switch

HH-800-FS – Foot operated interlock switch

Casters – Set of casters for regulator & HV tank (if applicable)

801 Series

High Current DC Power Supply

■ **The 801 series** high current DC power supplies ensure that your locomotives, trains, and rail cars run safely and efficiently under all load conditions. All models can be controlled with a remote user interface or with an integrated touch screen. The all in one light weight design allows for easy portability and integration into multiple applications.

The design of the 801 series allows for accurate and easy voltage regulation by reducing the ripple voltage to less than five percent. The integrated safety light and cabinet ensures operator safety. While the electrical design reduces the footprint and weight of the unit compared to similar SCR technologies. By using the 801 series ensures that your customers are riding on the most reliable and safe transit systems.

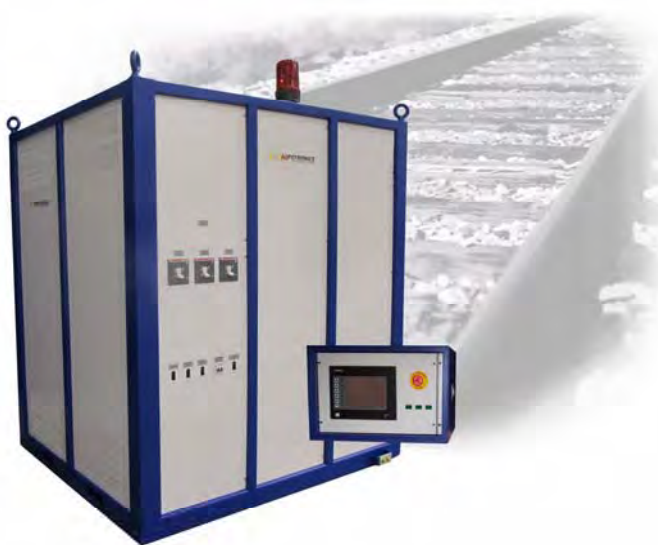

FEATURES

- ☑ **Touch screen** HMI interface
- ☑ **Custom** cycle Programs
- ☑ **Remote** operation
- ☑ **Less than 5%** Ripple Voltage
- ☑ **Automatic** voltage regulation
- ☑ **Reduced Weight / Size**
- ☑ **No EMI Mains Noise / Interference**

BENEFITS

- Low life-cycle cost** – rugged design minimizes system down time
- Operator Safety** of train during different voltage conditions
- Accurate measurements** – electrical design allows for minimal ripple voltage
- Ensures safe design** - of transit cars during different voltage conditions
- Easily integrated** into new or existing systems

INDUSTRY APPLICATIONS

Ideal for use for:

- **Integrators of transit lines**
- **Transit Authority**
- **Transit Manufacturer**
- **Transit Service Companies**
- **Testing of third rail over/under voltage**
- **Railcar chassis Testing**

TECHNICAL SPECIFICATIONS

1000V DC Systems

General	801-50A	801-100A	801-150A	801-200
Input Voltage	480V, 60Hz, 3Ø / 380V, 50Hz, 3Ø +/-5%			
Output Voltage	100V-1000V DC			
Output Current	50A	100A	150A	200A
Voltmeter	0-1000V DC			
Current Meter	0-50A	0-100A	0-150A	0-200A
Meter Accuracy	Digital, 1% of FS, range 10-100% of system output			
Ripple	5 % rms with balanced mains, 6 pulse rectification			
Regulation	less than 15% No Load – Full Load			
Humidity Range	< 95% Non Condensing			
Operating Temperature Range	10 to 40 Degrees Celsius			
Storage Temperature Range	-20 to 50 Degrees Celsius			
Voltage Control Rate of Rise (to-100% Output)	10% - 100% of 15, 30 or 60 Seconds			
Control Type	PLC with HMI in Main Cabinet			
Regulator Type	PVT Variable Transformer			
Regulator Insulation / Cooling	Class H / AN / Convection Cooling			
High Voltage Supply Insulation / Cooling	Class H / AN / Convection Cooling			
Dimensions	30"W x 42"D x 73"H	48"W x 36"D x 76"H	48"W x 48"D x 76"H	72"W x 48"D x 80"H
Weight	1000lbs	2400lbs	3000lbs	4400lbs

Notes:

- Dimensions & Weights are approximate
- Consult factory for remote PLC option is available
- For other input voltages please consult factory

Customer Supplied Cables per Local Electrical Codes

- Mains Input, System and Device Under Power, and Grounding Cables



TECHNICAL SPECIFICATIONS

1500V DC Systems

General	801.5-50A	801.5-100A	801.5-150A	801.5-200A
Input Voltage	480V, 60Hz, 3Ø / 380V, 50Hz, 3Ø +/-5%			
Output Voltage	150V-1500V DC		150V-1500V DC	
Output Current	50A	100A	150A	200A
Voltmeter	0-1500V DC			
Current Meter	0-50A	0-100A	0-150A	0-200A
Meter Accuracy	Digital, 1% of FS, range 10-100% of system output			
Ripple	5 % rms with balanced mains, 6 pulse rectification			
Regulation	less than 15% No Load – Full Load			
Humidity Range	< 95% Non Condensing			
Operating Temperature Range	10 to 40 Degrees Celsius			
Storage Temperature Range	-20 to 50 Degrees Celsius			
Voltage Control Rate of Rise (to-100% Output)	10% - 100% of 15, 30 or 60 Seconds			
Control Type	PLC with HMI in Main Cabinet			
Regulator Type	PVT Variable Transformer			
Regulator Insulation / Cooling	Class H / AN / Convection Cooling			
High Voltage Supply Insulation / Cooling	Class H / AN / Convection Cooling			
Dimensions	30"W x 42"D x 73"H	48"W x 36"D x 76"H	48"W x 48"D x 76"H	72"W x 48"D x 80"H
Weight	1200lbs	3000lbs	3500lbs	4800lbs

SCOPE OF SUPPLY

Qty. 1	HV Power Supply
Qty. 1	PLC Controller
Qty. 1	System Enclosure
Qty. 1	Calibration Certificate
Qty. 1	User's Manual

ORDERING INFORMATION

System	
801-XA-X	480V, 60Hz for -F version
801.5-XA-X	380V, 50Hz for -D Version

OPTIONS

AC Hipot - 700 Series
DC Power Supplies
Spare Parts Kits

Notes:

- Dimensions & Weights are approximate
- Consult factory for remote PLC option is available
- For other input voltages please consult factory
- Mains Input, System and Device Under Power, and Grounding Cables are to be Supplied by Customer

High Current DC Supply Catalog Number Logic

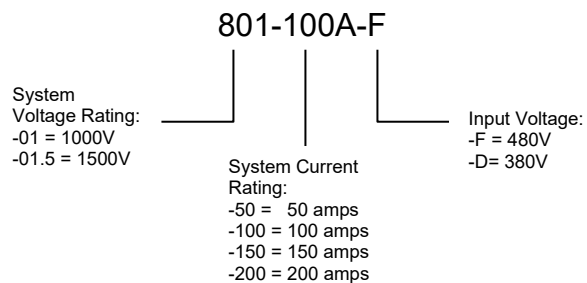

For product inquiries, quotes, or orders
contact us at

Telephone: +1-845-279-3644

E-mail: sales@hipotronics.com

For service or support questions
contact our service department at

Telephone: +1-845-279-3644

E-mail: service@hipotronics.com