



Advanced Test Equipment Rentals
www.atecorp.com 800-404-ATEC (2832)



<http://www.narda-sts.it>

User's Manual

EHP-50C

ELECTRIC AND MAGNETIC FIELD PROBE - ANALYZER

From 5 Hz up to 100 KHz

SERIAL NUMBER OF THE INSTRUMENT

You can find the Serial Number on the bottom cover of the instrument.

The Serial Number is in the form: 000XY00000.

The first three digits and the two letters are the Serial Number prefix, the last five digits are the Serial Number suffix. The prefix is the same for identical instruments, it changes only when a configuration change is made to the instrument.

The suffix is different for each instrument

Document EHP50CEN-01011-1.32 – Copyright © NARDA 2009

NOTE:

© Names and Logo are registered trademarks of Narda Safety Test Solutions GmbH and L3 Communications Holdings, Inc. – Trade names are trademarks of the owners.

If the instrument is used in any other way than as described in this Users Manual, it may become unsafe



Before using this product, the related documentation must be read with great care and fully understood to familiarize with all the safety prescriptions.

To ensure the correct use and the maximum safety level, the User shall know all the instructions and recommendations contained in this document.

This product is a **Safety Class III** instrument according to IEC classification and has been designed to meet the requirements of EN61010-1 (Safety Requirements for Electrical Equipment for Measurement, Control and Laboratory Use).



In accordance with the IEC classification, the battery charger of this product meets requirements **Safety Class II** and **Installation Category II** (having double insulation and able to carry out mono-phase power supply operations)..

It complies with the requirements of **Pollution Class II** (usually only non-conductive pollution). However, occasionally it may become temporarily conductive due to condense on it.

The information contained in this document is subject to change without notice.

KEY TO THE ELECTRIC AND SAFETY SYMBOLS:

You now own a high-quality instrument that will give you many years of reliable service. Nevertheless, even this product will eventually become obsolete. When that time comes, please remember that electronic equipment must be disposed of in accordance with local regulations. This product conforms to the WEEE Directive of the European Union (2002/96/EC) and belongs to Category 9 (Monitoring and Control Instruments). You can return the instrument to us free of charge for proper environment friendly disposal. You can obtain further information from your local Narda Sales Partner or by visiting our website at www.narda-sts.it.



Warning, danger of electric shock



Earth



Read carefully the Operating Manual and its instructions, pay attention to the safety symbols.



Unit Earth Connection



Earth Protection



Equipotential

KEY TO THE SYMBOLS USED IN THIS DOCUMENT:



DANGER

The **DANGER** sign draws attention to a potential risk to a person's safety. All the precautions must be fully understood and applied before proceeding.



WARNING

The **WARNING** sign draws attention to a potential risk of damage to the apparatus or loss of data. All the precautions must be fully understood and applied before proceeding.



CAUTION

The **CAUTION** sign draws attention against unsafe practices for the apparatus functionality.



NOTE:

The **NOTE** draw attention to important information.

Contents

| | |
|---|-------------------|
| Safety requirements and instructions..... | Page VI |
| EC Conformity Certificate..... | VII |
| | |
| 1 General information | Page |
| 1.1 Documentation..... | 1-1 |
| 1.2 Introduction | 1-1 |
| 1.3 Standard accessories..... | 1-2 |
| 1.4 Optional accessories | 1-2 |
| 1.5 Main specifications..... | 1-3 |
| 1.6 Isotropic E&H field analyzer EHP-50C typical uncertainty and Anisotropy..... | 1-4 |
| 1.6.1 Typical uncertainty of EHP-50C..... | 1-4 |
| 1.6.2 Explication Notes..... | 1-5 |
| 1.7 Anisotropy..... | 1-6 |
| 1.8 EHP-50C panel..... | 1-7 |
| | |
| 2 Software interface | Page |
| 2.1 Introduction..... | 2-1 |
| 2.2 Preliminary inspection..... | 2-1 |
| 2.3 Work Environment..... | 2-1 |
| 2.4 To return for repair..... | 2-1 |
| 2.5 Equipment cleaning..... | 2-1 |
| 2.6 Power supply and battery recharging..... | 2-2 |
| 2.7 EHP-50C connected to a PC..... | 2-3 |
| 2.8 EHP-50C stand alone mode..... | 2-3 |
| 2.9 EHP-50C with 8053 DISPLAY..... | 2-3 |
| 2.10 Battery management..... | 2-3 |
| 2.11 Avoiding measurement errors..... | 2-4 |
| | |
| 3 EHP-TS installation | Page |
| 3.1 Introduction..... | 3-1 |
| 3.2 Hardware requirements..... | 3-1 |
| 3.3 Installing EHP-TS Software..... | 3-2 |
| | |
| 4 USB-OC Installation | Page |
| 4.1 USB-OC Optical to USB Converter driver installation..... | 4-1 |
| 4.2 Hardware installation..... | 4-5 |
| 4.3 COM Port setting with 8053-OC..... | 4-6 |
| | |
| 5 EHP-TS software | Page |
| 5.1 EHP-TS Applications..... | 5-1 |
| 5.2 EHP-50C Applications..... | 5-2 |
| 5.3 Main menu..... | 5-2 |
| 5.3.1 Sweep section..... | 5-4 |
| 5.3.2 Data section..... | 5-5 |
| 5.3.3 Mode section..... | 5-6 |
| 5.3.4 Limit section..... | 5-7 |
| 5.3.5 Appearance section..... | 5-8 |
| | |
| 6 EHP-50C stand alone mode | Page |
| 6.1 Stand alone mode description..... | 6-1 |
| 6.2 EHP-50C Data Logger..... | 6-2 |
| 6.2.1 Run EHP-50C Logger..... | 6-2 |
| 6.2.2 Use EHP-50C Logger..... | 6-5 |
| 6.2.3 EHP-50C battery charging..... | 6-5 |

| | |
|---|-------------|
| 7 Update Firmware | Page |
| 7.1 Update firmware..... | 7-1 |
| 7.2 To run the update software..... | 7-1 |
| 7.3 To transfer data | 7-1 |
| | |
| 8 Uninstalling software | Page |
| 8.1 Uninstalling EHP-TS Software | 8-1 |
| | |
| 9 Uninstalling USB-OC | Page |
| 9.1 Uninstalling driver for USB-OC..... | 9-1 |
| | |
| 10 Accessories | Page |
| 10.1 Introduction..... | 10-1 |
| 10.1.1 Preliminary inspection..... | 10-1 |
| 10.1.2 Work environment..... | 10-1 |
| 10.1.3 Return for repair..... | 10-1 |
| 10.1.4 Cleaning..... | 10-1 |
| 10.1.5 Power supply and battery chargers..... | 10-2 |
| 10.2 USB-OC Optical USB Converter..... | 10-3 |
| 10.2.1 Introduction..... | 10-3 |
| 10.2.2 Installation..... | 10-3 |
| 10.3 8053-OC Optical RS232 Converter..... | 10-5 |
| 10.3.1 Introduction..... | 10-5 |
| 10.3.2 Installation..... | 10-5 |
| 10.4 8053-OC-PS Power Supply..... | 10-7 |
| 10.4.1 Introduction..... | 10-7 |
| 10.4.2 Installation..... | 10-7 |
| 10.5 8053-DISPLAY..... | 10-9 |
| 10.5.1 Introduction..... | 10-9 |
| 10.5.2 Standard accessories..... | 10-9 |
| 10.5.3 Optional accessories..... | 10-9 |
| 10.5.4 Main specification..... | 10-10 |
| 10.5.5 Field probe..... | 10-11 |
| 10.5.6 Front panel..... | 10-12 |
| 10.5.7 Side panel..... | 10-12 |
| 10.5.8 Battery charger..... | 10-13 |
| 10.5.9 To substitute the mains connector..... | 10-13 |
| 10.5.10 To check the internal batteries..... | 10-13 |
| 10.6 SB-04 Switching Control Box..... | 10-15 |
| 10.6.1 Introduction..... | 10-15 |
| 10.6.2 Standard accessories..... | 10-15 |
| 10.6.3 Main specification..... | 10-16 |
| 10.6.4 System configuration..... | 10-18 |
| 10.6.5 Power supply and battery recharging SB-04..... | 10-19 |
| 10.6.6 Installation..... | 10-20 |
| 10.6.7 Use of PMM SB-04..... | 10-20 |
| 10.7 TR-02A Tripod..... | 10-21 |
| 10.7.1 Introduction..... | 10-21 |
| 10.8 TT-01 Fiber glass Telescopic support..... | 10-23 |
| 10.8.1 Introduction..... | 10-23 |
| 10.9 Other accessories..... | 10-25 |

Figures

| Figure | | Page |
|--------|---|-------|
| 1-1 | Block Diagram of the EHP-50C | 1-2 |
| 1-2 | 3D mesh measurements of magnetic probe..... | 1-6 |
| 1-3 | EHP-50C panel | 1-7 |
| 3-1 | EHP-TS Installation..... | 3-2 |
| 4-1 | USB-OC converter..... | 4-1 |
| 4-2 | EHP-50C link with USB-OC..... | 4-5 |
| 4-3 | EHP-50C link with 8053-OC..... | 4-5 |
| 5-1 | EHP50 EHP-TS Main Window..... | 5-2 |
| 6-1 | Shorting loop..... | 6-1 |
| 7-1 | EHP-50C Upgrading Utility Main Window..... | 7-1 |
| 8-1 | Uninstalling EHP-TS..... | 8-1 |
| 9-1 | Uninstalling USB-OC..... | 9-2 |
| 10-1 | USB-OC Adapters..... | 10-3 |
| 10-2 | 8053-OC Panels..... | 10-5 |
| 10-3 | 8053-PC-PS Connectors..... | 10-7 |
| 10-4 | 8053 DISPLAY Front Panel..... | 10-12 |
| 10-5 | 8053 DISPLAY Side Panel..... | 10-12 |
| 10-6 | SB-04 Front Panel..... | 10-17 |
| 10-7 | SB-04 Rear Panel..... | 10-17 |
| 10-8 | TR-02A Tripod..... | 10-21 |
| 10-9 | TT-01 Fiber Glass Telescopic Support..... | 10-23 |

Tables

| Table | | Page |
|-------|--|-------|
| 1-1 | Technical Specifications of the EHP-50C..... | 1-3 |
| 2-1 | Autonomy of the battery..... | 2-3 |
| 10-1 | Technical Specifications of the USB-OC..... | 10-3 |
| 10-2 | Technical Specifications of the 8053-OC..... | 10-5 |
| 10-3 | Technical Specifications of the 8053-OC-PS..... | 10-7 |
| 10-4 | Technical Specifications of the 8053 DISPLAY... .. | 10-10 |
| 10-5 | Series of electric and magnetic field probe..... | 10-11 |
| 10-6 | Technical Specifications of the SB-04..... | 10-16 |
| 10-7 | Led colour..... | 10-19 |
| 10-8 | Technical Specifications of the TR-02A..... | 10-21 |
| 10-9 | Technical Specifications of the TT-01..... | 10-23 |



SAFETY RECOMMENDATIONS AND INSTRUCTIONS

This product has been designed, produced and tested in Italy, and it left the factory in conditions fully complying with the current safety standards. To maintain it in safe conditions and ensure correct use, these general instructions must be fully understood and applied before the product is used.

- When the device must be connected permanently, first provide effective grounding;
- If the device must be connected to other equipment or accessories, make sure they are all safely grounded;
- In case of devices permanently connected to the power supply, and lacking any fuses or other devices of mains protection, the power line must be equipped with adequate protection commensurate to the consumption of all the devices connected to it;
- In case of connection of the device to the power mains, make sure before connection that the voltage selected on the voltage switch and the fuses are adequate for the voltage of the actual mains;
- Devices in Safety Class I, equipped with connection to the power mains by means of cord and plug, can only be plugged into a socket equipped with a ground wire;
- Any interruption or loosening of the ground wire or of a connecting power cable, inside or outside the device, will cause a potential risk for the safety of the personnel;
- Ground connections must not be interrupted intentionally;
- To prevent the possible danger of electrocution, do not remove any covers, panels or guards installed on the device, and refer only to NARDA Service Centers if maintenance should be necessary;
- To maintain adequate protection from fire hazards, replace fuses only with others of the same type and rating;
- Follow the safety regulations and any additional instructions in this manual to prevent accidents and damages.

EC Conformity Certificate

(in accordance with the Directives: EMC 89/336/EEC and Low Voltage 73/23/EEC)

This is to certify that the product: EHP-50C Electric and Magnetic field Probe - Analyzer

Produced by: Narda Safety Test Solutions
Via Benessea 29/B
17035 Cisano sul Neva (SV) – ITALY

complies with the following European Standards:

Safety: CEI EN 61010-1 (2001)

EMC: EN 61326-1 (2007)

This product complies with the requirements of the Low Voltage Directive 73/23/EEC, amended by 93/68/EEC, and with the EMC Directive 89/336/EEC amended by 92/31/EEC, 93/68/EEC, 93/97/EEC.

Narda Safety Test Solutions

This page has been left blank intentionally

1 - General information

1.1 Documentation

The following documents are included in this Manual:

- A questionnaire to be sent to NARDA together with the apparatus should service be required.
- A checklist of the Accessories included in the shipment.

This Manual includes the description of the Accessories of the system for the measurement of electromagnetic fields.

1.2 Introduction



This section explains the installation and use of the EHP-50C Electric and Magnetic Field Analyzer. EHP-50C is a low frequency electric and magnetic isotropic field probe-analyzer, providing an advanced technology solution for field measurements from a few V/m (or nT) to thousands V/m (or mT), in the 5 Hz to 100 kHz range including X, Y and Z axes measurements with a powerful spectrum analyzer built in.

EHP-50C can be used connected with 8053-DISPLAY, SB04 and PC. EHP-50C has an additional mode of operation that allows it to be used in stand alone mode over 24 hours of continuous data collection.

EHP-50C include an E²PROM, that stores the calibration data, the frequency and level calibration tables, and an internal optical repeater that allows the connection to external devices.

The spectral analysis of the signals, obtained through a powerful DSP (Digital Signal Processor), is performed on seven different Span values and is displayed on the PC monitor or 8053-Display . By using a Marker it is possible to obtain the precise measurement of the frequencies and levels.

EHP-50C is managed internally with a microprocessor (CPU module) that controls all its main functions, from the charging of the batteries to the serial communication with the DSP unit. The Electric or Magnetic field is picked up by the three sensors on the X, Y and Z axes. A Digital/Analog conversion follows which transforms the signal into numeric information processed by a Digital Signal Processing unit.

EHP-50C is housed in a small cubic container. The bottom side panel includes an optical fibre connector, extension rod screw, battery charger connector, ON/OFF button and Status LED.

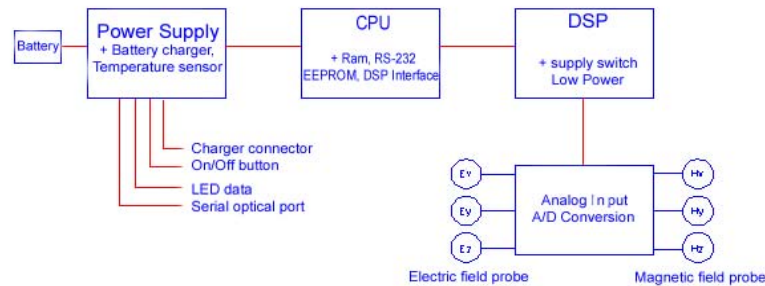

Fig. 1-1 Block diagram of the EHP-50C Analyzer

The magnetic sensor system is composed by three magnetic loops positioned orthogonal each other. The electric sensor system is composed by three orthogonal parallel capacitors and installed on opposite side of the magnetic loops.

1.3 Standard Accessories

- 8053-SC Soft carrying case, holds basic unit and accessories including 8053-Display;
- AC/DC battery charger;
- International AC plug adapter;
- FO-8053/10 Cable, fibre optic 10m
- FO-10USB Cable, fibre optic 10m;
- USB-OC Optical to USB converter;
- Optical bridge connector;
- Plastic rod support, 50cm;
- Mini tripod, bench top;
- EHP-TS software, CD-ROM;
- Operating manual EHP-50C;
- Certificate of calibration;
- Return for Repair Form

1.4 Optional Accessories

The following accessories may be ordered as options:

- 8053-Display display unit;
- SB-04 Switching Control Box;
- FO-20USB Cable, fiber optic 20m;
- FO-40USB Cable, fiber optic 40m;
- FO-8053/20 Cable, fiber optic 20m;
- FO-8053/40 Cable, fiber optic 40m;
- FO-8053/80 Cable, fiber optic 80m;
- 8053-OC Optical to RS232 converter;
- 8053-OC-PS Power Supply;
- TR-02A wooden tripod 1-2m with soft carrying bag;
- TT-01 telescopic mast (120-420 cm) with carrying bag;
- 8053-CC Rigid case;
- 8053-CA Car Adapter.

1.5 EHP-50C Main specifications

The following conditions apply to all specifications:

- The ambient temperature for use must be between -10°C and 50° C.

| Table 1-1 Technical specifications of the EHP-50C Electric and Magnetic Field Analyzer | | |
|---|---|--|
| | Electric field | Magnetic field |
| Frequency range | | 5 Hz – 100 kHz |
| Level range | 0.01 V/m – 100 kV/m | 1 nT – 10 mT |
| Overload | 200 kV/m @ 50 Hz | 20 mT @ 50 Hz |
| Dynamic Resolution | | > 140 dB |
| | 0.001 V/m on 8053 Display | 1 nT on 8053 display or internal data logger |
| | 0.1 V/m with 8053 Data logger | 10 nT with 8053 Data logger |
| Sensitivity | 0.01 V/m | 1 nT |
| Flatness (40 Hz – 10 kHz) | ± 0.5 dB | ± 0.5 dB |
| Anisotropy | (see § 1.7) | |
| Linearity @ 50 Hz | ± 0.2 dB (1 V/m – 100 kV/m) | ± 0.2 dB (200 nT – 10 mT) |
| Internal memory | 1440 data with 1 minute storing; 2880 data with 30 sec storing. The data can be transferred only to PC | |
| Internal data logger | 1 measurement every 30 or 60 seconds | |
| FFT | Real time FFT analysis | |
| SPAN | 100 Hz, 200 Hz, 500 Hz, 1 kHz, 2 kHz, 10 kHz, 100 kHz (500Hz to 100kHz in Stand Alone mode) | |
| Start frequency | 1.2 % of the SPAN | |
| Stop frequency | Equal to the SPAN | |
| E-field rejection | --- | > 20 dB |
| H-field rejection | > 20 dB | --- |
| Calibration | Internal into E ² PROM | |
| Temperature deviation (referred to 23°C) | +/- 0.05 dB between -10 and +23°C, at 40% of relative humidity + 0.01 dB/°C between +23 and +50°C, at 40% of relative humidity | |
| Humidity deviation (referred to 40%) | +/- 0.05 dB between 20% and 50%, at the temperature of +23°C + 0.05 dB/% between 50% and 80%, at the temperature of +23°C | |
| Size | 92 x 92 x 109 mm | |
| Weight | 525 g | |
| Tripod support | Threaded insert ¼" | |
| Internal battery | Rechargeable NiMH batteries (5 x 1.2 V) | |
| Operating time | >10 hours in normal mode >150 hours in low-power mode 24 hours with internal data logger | |
| Recharging time | < 4 hours | |
| External DC supply | DC, 10 - 15 V, I = about 200 mA | |
| Fiber optic connection | Up to 40 meters via fiber optic (USB-OC) Up to 80 meters via fiber optic (8053-OC) | |
| Firmware update | Update available through the USB or RS232 port | |
| Autocheck | Automatically when switched on | |
| Operational temperature | -10°C to +50°C | |
| Storage temperature | -20°C to +70°C | |

1.6 Isotropic E&H field analyzer EHP50C typical uncertainty and anisotropy

1.6.1 Typical uncertainty of EHP50C

The uncertainties stated in this document have been determined according to EA-4/2 [4].

They were estimated as expanded uncertainty obtained multiplying the standard by the coverage factor $k=2$, corresponding to a confidence level of about 95%.

The total uncertainty of the probe derived from typical contributions of linearity, anisotropy, frequency response, temperature, relative humidity and with/without contribution of uncertainty of calibration.

| Magnetic probe ⁽¹⁾ | Magnetic flux density range | Total expanded uncertainty (k=2) | |
|-------------------------------|-------------------------------|---|---|
| | | Without contribution of uncertainty of calibration U_{EHP50C} (%) | With contribution of uncertainty of calibration U_T (%) |
| Frequency at 50Hz | 0.1 μ T to < 0.3 μ T | 4.1 | 4.2 ⁽²⁾ |
| | 0.3 μ T to < 10.0 μ T | 3.3 | 3.5 ⁽²⁾ |
| | 10.0 μ T to < 100 μ T | 3.7 | 4.3 ⁽³⁾ |
| | 100 μ T to 500 μ T | 4.1 | 4.8 ⁽⁴⁾ |
| Frequency from 40 to 10kHz | 0.1 μ T to < 0.3 μ T | 6.5 | 6.7 ⁽⁵⁾ |
| | 0.3 μ T to > 10.0 μ T | 6.1 | 6.3 ⁽⁵⁾ |

(1) The temperature range is from -10°C to 23 °C and relative humidity is from 20% to 50%

(2) (5) The uncertainty of calibration used is 1,5%

(3) The uncertainty of calibration used is 2,0%

(4) The uncertainty of calibration used is 2,7%

| Electric probe ⁽⁶⁾ | Electric field range | Total expanded uncertainty (k=2) | |
|-------------------------------|----------------------|---|---|
| | | Without contribution of uncertainty of calibration U_{EHP50C} (%) | With contribution of uncertainty of calibration U_T (%) |
| Frequency at 50Hz | 10 V/m to 500 V/m | 7.8 | 8.2 ⁽⁷⁾ |
| | 10 V/m to < 100 kV/m | 8.4 | 8.8 ⁽⁸⁾ |
| Frequency from 40 to 10kHz | 10 V/m to < 500 V/m | 9.5 | 9.9 ⁽⁸⁾ |

(6) The temperature range is from -10°C to 23 °C and relative humidity is from 20% to 50%

(7) The uncertainty of calibration used is 2,0%

(8) The uncertainty of calibration used is 2,5%

1.6.2 Explication Notes

a) If we have the certificate with different values of the uncertainty of calibration, in order to calculate the total expanded uncertainty U_T , the uncertainty of calibration has to be taken into account::

$$U_T = \sqrt{(U_{EHP\ 50\ C})^2 + (U_{Cal})^2}$$

b) When the environmental temperature is higher than 23 °C the contribute due to the temperature must be added quadratically to the uncertainty.

Example: if the temperature is 38°C we get a variation of 15°C in comparison to 23°C, corresponding to a variation of 0.15 dB (0.01dB/°C) equivalent to 1,74% and therefore the standard uncertainty is 1% (=0,0174/ $\sqrt{3}$).

Assuming an expanded uncertainty $U_T = 4.2\%$,

$$U_{TOT} = \sqrt{\left(\frac{0.042}{2}\right)^2 + (0.01)^2} = 0.0465 \text{ is obtained.}$$

A similar calculation can be made in case the relative humidity overcomes 50%.

1.7 Anisotropy

1) The IEEE 1309-2005 [3] defined the anisotropy (A) as the maximum deviation from the geometric mean of the maximum response and minimum response when the probe is rotated around the ortho-axis (e.g. "virtual handle") as shown in the example in figure below.

$$A = 20 \cdot \log_{10} \left(\frac{S_{\max}}{\sqrt{S_{\max} \cdot S_{\min}}} \right) \text{ dB} \quad \text{equation (1)}$$

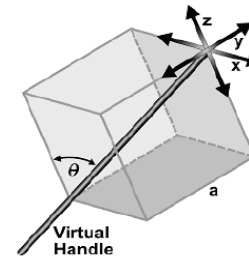

$$\theta = \sin^{-1} \left(\frac{\sqrt{2} a}{\sqrt{3} a} \right) = 54.7^\circ$$

where S is the measured amplitude in field strength units.

2) The IEC 61786 [2] "Measurement of low-frequency magnetic and electric fields with regards to exposure of human beings - special requirements for instruments and guidance for measurements" don't define the anisotropy and suggest, for three-axis probes, the calibration of each axis when each element is aligned with the incident field.

The calibration should also be checked for a specific orientation where approximately there is the same indication for each one of the three axis (XYZ measurement).

Following this suggestion some laboratories find the minimum and the maximum values of the X,Y,Z and XYZ measure and calculate the anisotropy using equation (1).

3) We calculated the anisotropy with equation (1) but with 3D mesh measurements to cover 4π steradian.

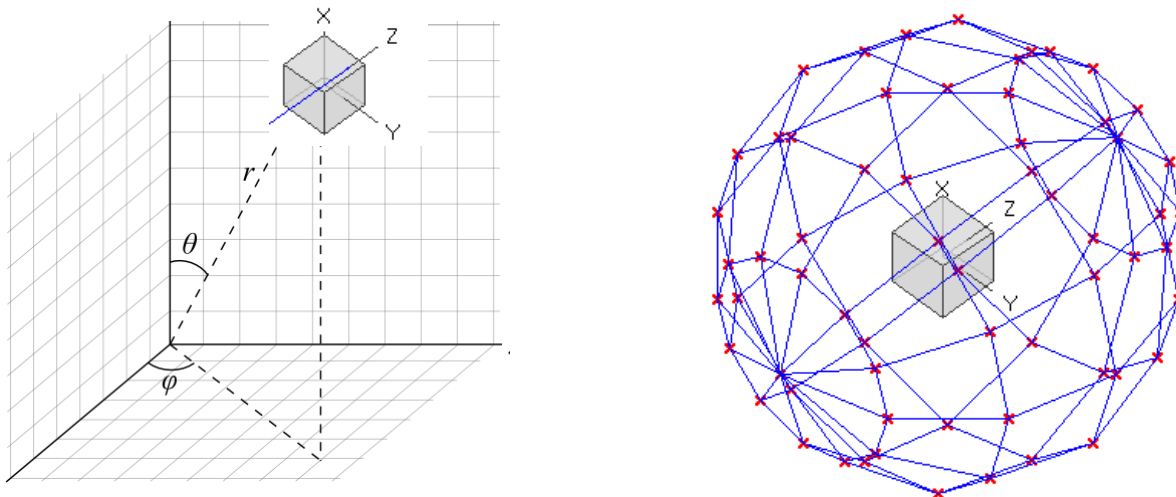

Fig. 1-2 3D mesh measurements of magnetic probe

Each x marker in the fig.1 indicates the coordinates surface of the spherical coordinates (r, θ, φ) .

The anisotropy is evaluated with 30 degree steps for θ and φ , and r shows the calibration factor at each position.

The typical value of anisotropy is 1,4% (0.12 dB) for magnetic probe and 6,5% (0,54 dB) for electric probe.

The anisotropy calculated in this way is worse respect to other cases above described and it is more representative of the reality.

1.8 EHP-50C Panel

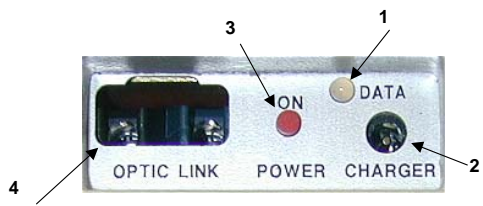

Fig. 1-3 Panel of EHP-50C

Key:

1. Led
2. Battery charger connector
3. ON/OFF button
4. Fiber optic connector

This page has been left blank intentionally

2 - Installation and use

2.1 Introduction

This section provides the information required for installing and using the EHP-50C Analyzer.

Information is included regarding initial inspection, power requirements, interconnections, work environment, assembly, cleaning, storage and shipment.

2.2 Preliminary inspection



WARNING

Inspect the packaging for any damage.

If the packaging or anti-shock material have been damaged, check that the contents are complete and that the meter has not suffered electric or mechanical damage.

Check that all the Accessories are there against the checklist found with the apparatus.

Inform the carrier and NARDA of any damage that has occurred.

2.3 Work environment

The work environment of the Accessories, must come within the following conditions:

- Temperature From -10°C to +50°C
- Humidity < 90% relative

The meter must be stored in a clean and dry environment, free from acid dusts and humidity.

The storage environment must come within the range of the following conditions:

- Temperature From -20°C to +70°C
- Humidity < 95% relative

2.4 To return for repair

When the meter needs to be returned to NARDA for repair, please complete the questionnaire appended to this User's Manual, filling in all the data that will be useful for the service you have requested.

For reducing the period of time required for the repairs, it is necessary to be as specific as possible in describing the problem. If the problem only occurs in certain circumstances, please describe in detail how it happens.

If possible it is better to reuse the original packaging; making sure that the apparatus is wrapped in thick paper or plastic.

Otherwise, use strong packaging by using a sufficient quantity of shock absorbent material around all sides of the meter to ensure that it is compact and does not move around inside the package.

In particular, take every precaution to protect the front panels.

Finish the package by sealing it up tightly.

Apply a FRAGILE label to the package to encourage greater care in its handling.

2.5 To clean the meter



WARNING

Use a dry, clean and non-abrasive cloth for cleaning the meter.

Do not use solvents, acids, turpentine, acetone or other similar products for cleaning the meter in order to avoid damaging it.

2.6 Power supply and battery recharging

EHP-50C has an internal rechargeable NiMH battery that can be recharged with the battery charger supplied with it. (the battery charger is the same as that of 8053 DISPLAY).

If the internal batteries are to have the greatest autonomy, we recommend that a full recharging cycle should be carried out before using the Analyzer.

ALWAYS connect the battery charger to the power supply BEFORE connecting it to the EHP-50C.

The battery charger has an internal protective circuit that will limit the output of current if there is any load when connecting to the mains. Always remove the shorting loop connector when recharging EHP-50C.

Battery charger:

output: DC, 10 - 15 V, ~ 500 mA



Connector:

 NOTE

 NOTE

In order to safeguard the features of the batteries, it is crucial to have a complete recharge before storing them for periods longer than 4 months. Therefore, it is warmly suggested recharging the batteries at least every 4 months even though the device has not been used.

 NOTE

The minimum voltage level for operation is about 5.3 V. The batteries must be recharged for lower voltages. Below such voltage the analyzer will turn OFF automatically.

The time required for recharging the batteries is about 4-5 hours. When the recharge is complete, this is indicated by the Led of the EHP-50C, with a rapidly blinking Green light.

 NOTE

To take measurements **ALWAYS** remove the battery charger from the EHP-50C Analyzer otherwise the system does not work.



The battery status is reported by the EHP-50 control program

When charging is in progress the operator is warned in the battery sub-window.

2.7 EHP-50C connected to a PC Using the EHP-TS software spectrum analysis can be displayed on a PC

2.8 EHP-50C stand alone Mode The EHP-50C offers a Stand-alone mode of operation and thanks to its internal memory is possible to perform a long term acquisition without connecting it to any external device.
 With EHP-50C is possible to collect data every 1 minute or every 30 seconds for 24 hours. Later on, it is possible to download all collected data to any PC by using the provided NARDA software

2.9 EHP-50C with 8053 DISPLAY EHP-50C is linked to 8053 DISPLAY via the fiber optic link.

 **NOTE**

See 8053 DISPLAY Manual for further details

2.10 Battery management EHP-50C has efficient battery management that allows measurements to be taken in **Logger** mode (when connected to 8053-Display accessory) with over one week's autonomy.

During the time the Data Logger - Low Power is being used, the Analyzer stays on for the minimum period necessary (Time ON) and correctly takes a measurement and transfers it to the internal non volatile memory of the 8053 DISPLAY, after which it goes into a state of low consumption until the next measuring point. The delay between measurements may be set between a minimum of 10 seconds and a maximum of 900 seconds (15 minutes).

The Table below illustrates the autonomy of the batteries with measurement settings every minute and every 5 minutes. The longer the delay between one measurement and the next, the longer the battery charge lasts.

The Table summaries the battery autonomy of the Analyzer depending on its mode of operation.

| TABLE 2-1 Autonomy of the battery | | | | | |
|-----------------------------------|-------------------------------------|----------------------------------|-----------------------------------|------------------|------------|
| | | LOW POWER MODE | | STAND ALONE MODE | |
| Span | Normal functioning Autonomy (hours) | Logger Mode 60s Autonomy (hours) | Logger Mode 300s Autonomy (hours) | 30s Sample | 60s Sample |
| 100 Hz | >11 | >24 | >72 | --- | --- |
| 200 Hz | >11 | >36 | >110 | --- | --- |
| 500 Hz | >10 | >48 | >130 | >24 | >24 |
| 1 kHz | >10 | >72 | >150 | >24 | >24 |
| 2 kHz | >9 | >65 | >150 | >24 | >24 |
| 10 kHz | >6 | >60 | >130 | >24 | >24 |
| 100 kHz | >9 | >72 | >150 | >24 | >24 |

2.11 Avoiding measurement errors

To avoid disturbing the measurements in progress, the user or other persons or mobile vehicles should stay at least 5 meters away from the Analyzers. We also recommend that the probe be set up a long way from metal objects or masses.



To perform correct measurements, the tripod TR-02A to hold EHP-50C is mandatory. Using an unsuitable support could influence the measurements that have been taken and, therefore, determine incorrect results. We recommend always using the isolated extension support supplied with EHP-50C for supporting the Analyzer.

We also recommend that the TR-02A optional tripod be used for positioning EHP-50C at the height set out in the reference standards for the measurement in progress and that this configuration is always maintained so that the measurements taken can be repeated.



The intensity of the measured field mainly depends on its voltage and the geometry of the system under examination as well as the distance between the conductors and the measurement points. In the vicinity of cables, the reading of the field value may be very high and vary with the location of the probe.

From the definition of the potential difference between two points:

$$V_{21} = - \int_{r_1}^{r_2} \vec{E} dr$$

It is evident that, keeping the potential difference constant as the distance between the two points under examination decreases, the intensity of the field necessarily increases.

For example: the intensity of the electric field between two armatures of a parallel-plate capacitor situated at a distance of 0.1 m and having a potential difference of 100 V is equal to:

$$E = \frac{100V}{0,1m} = 1KV/m$$

It should be noted that a voltage of 100 V, in these conditions, generates a field of 1000 V/m. It is, therefore, possible, in the vicinity of 220 V conductors, that there may be a field, which is much higher than 220 V/m.

3 – EHP-TS installation

3.1 Introduction

EHP-TS is a useful software tool developed for remote PC control, through fibre optic link, of EHP family Electromagnetic field analyzers.

By means of the recently introduced USB-OC optical to USB converter, EHP-50C and EHP-200 can be connected to a PC USB port.

Using the former optical/RS232 adapter, the selected COM port should be assigned to the application software (see cap.5 EHP-TS applications).

EHP-TS software requires that at least one of the mentioned analyzers is connected to PC in order to run.

The EHP-TS installation program doesn't install any driver for USB-OC converter but makes the driver file available for its installation.

3.2 Hardware requirements

Minimum requirements:

- 486 Processor or Pentium
- 16 Mb RAM
- At least 2 Mb of free space on hard disk
- 1 free USB or RS232 port
- Windows Operating system™ XP/Vista



WARNING

EHP-TS software does not work with EHP50A/B.

3.3 Installing EHP-TS Software

Before connecting the EM field analyzer to PC the EHP-TS software installation should be performed:
Insert the EHP-TS CD into the driver of your PC and run the file “EHP-TS Setup.exe”.



Follow set-up program instructions

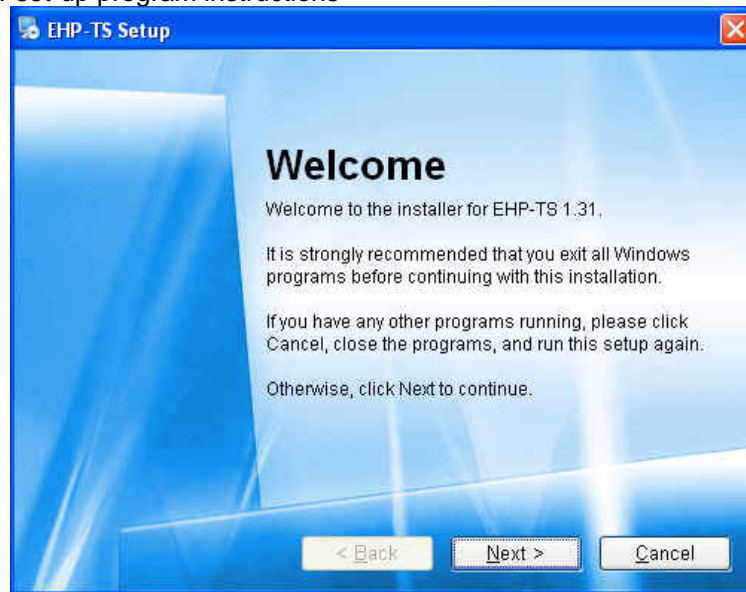
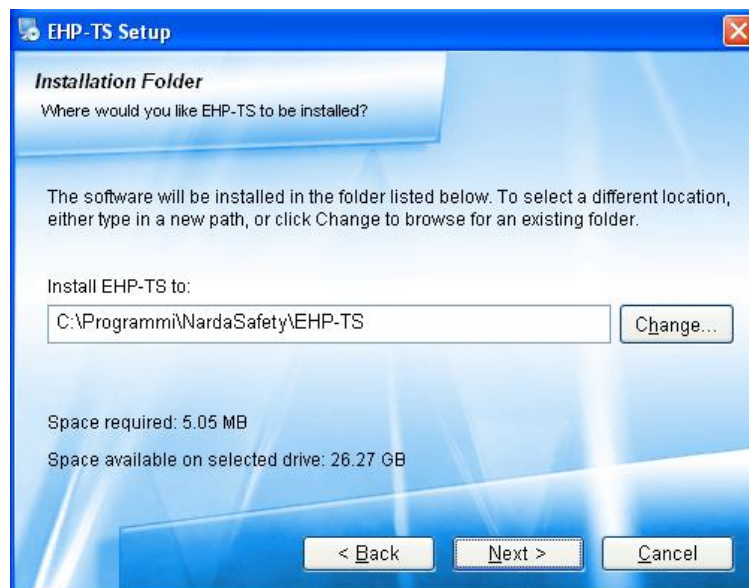
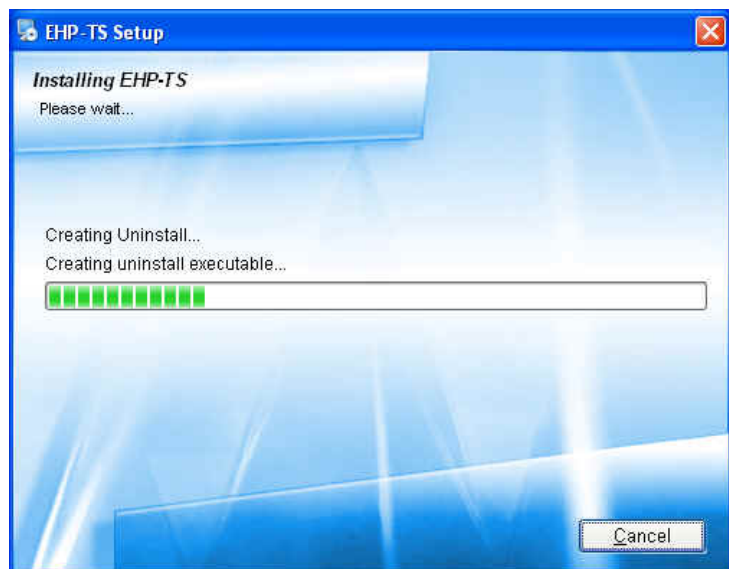
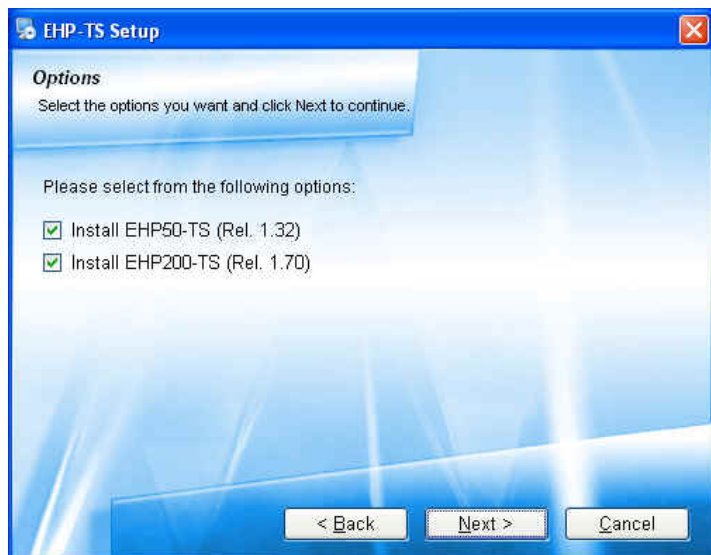
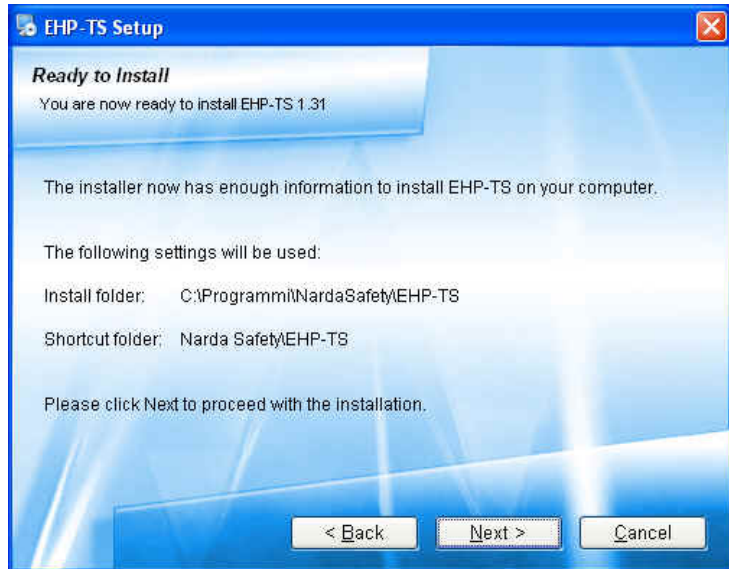
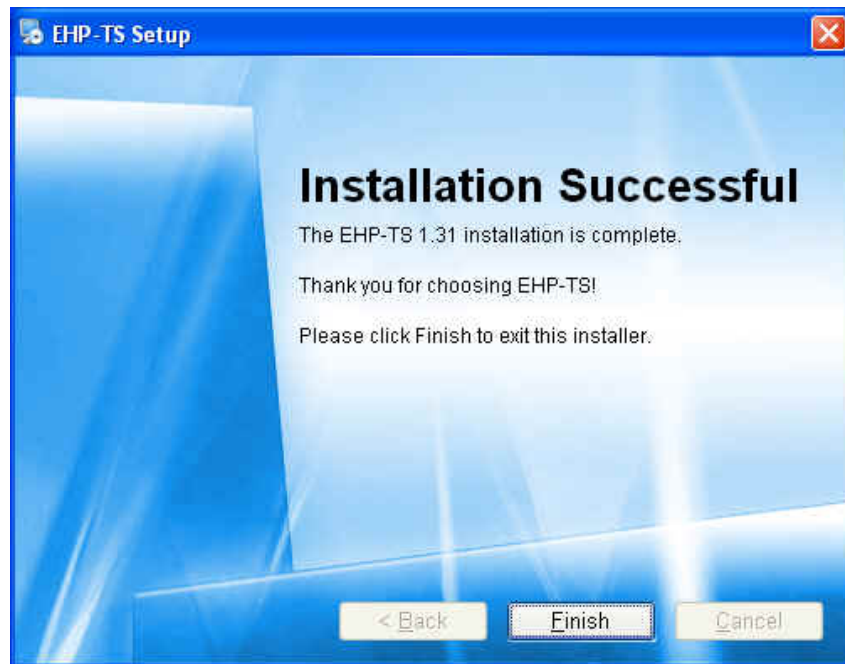

Fig.3-1 EHP-TS installation







When asked for, reboot your system to complete installation

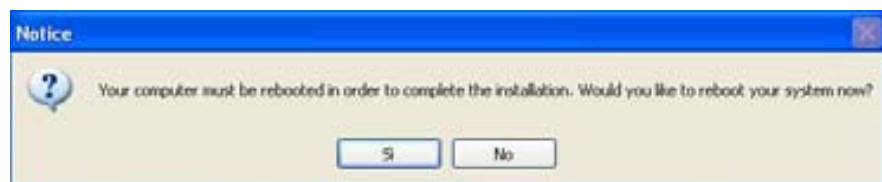

EHP-TS software is now installed in your PC, you can remove it, if needed, simply running the "Uninstall EHP-TS" application (see cap.8).

4 – USB-OC Installation

4.1 USB-OC optical to USB converter driver installation

USB-OC optical to USB converter requires a driver program to be installed in your system. EHP-TS software create a folder including all files requested for the driver installation. Before running EHP-TS, please connect the USB-OC converter to a USB port of your PC.

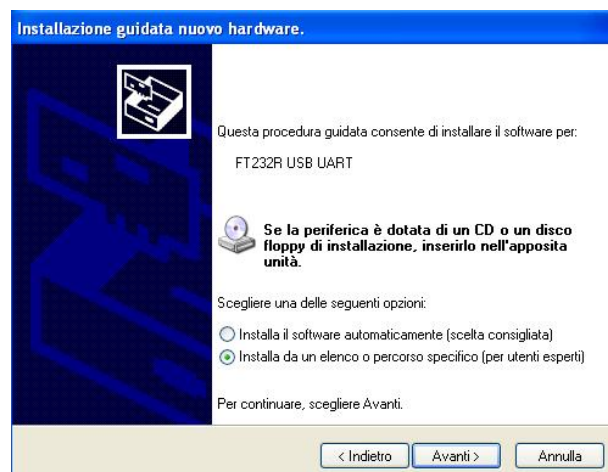

Fig.4-1 USB-OC Converter

In case the driver is not already installed, a message informing that new hardware has been found will be showed and a guided installation will start:



Do not allow connection to Windows Update but select “No, not now” and click “next”



Select “Install from a list or specific path” and click “next”

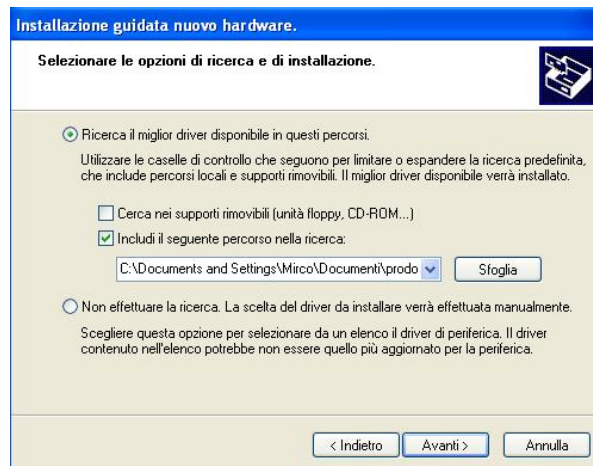

Select options as in the previous picture and click “browse” to select the directory containing the requested files:



You'll find the folder “USB-WIN-XP” which includes driver for Windows XP and Vista in the following path: C:\Programmi\Narda Safety\EHP-TS, select it and click “OK”

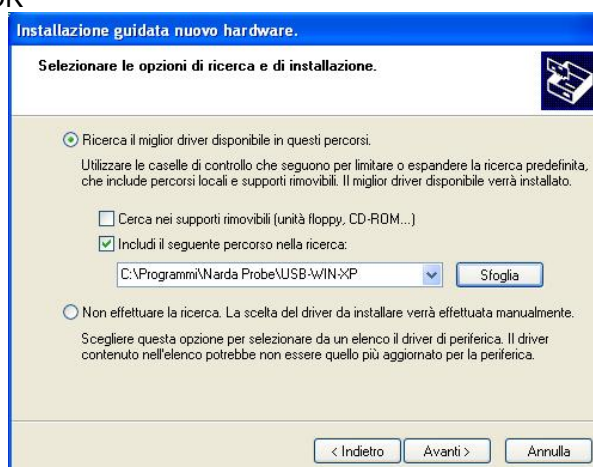

Click “next” to start installation.



Click "continue"



It may happen that a more recent version of a requested file is already present in your system.
In this case do not replace it but answer "No" to the confirmation request:

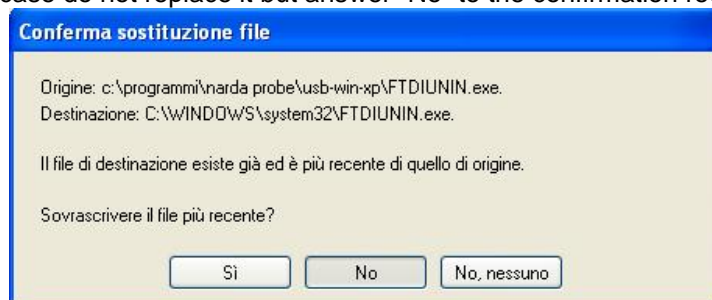



 NOTE

The entire procedure will be executed twice as two different drivers will be installed. Same steps as above should be followed and same path C:\Programs\NardaSafety\EHP-TS must be selected.



Click "Finish" to complete driver installation, the new hardware is now ready to be used.

USB-OC converter driver is now installed in your PC, you can remove it, if needed, following instructions in cap.9.

4.2 Hardware installation

Connect the USB-OC supplied with EHP-50C to a USB port of the PC, and the optic fiber cable to the EHP-50C. Instead if you connect the probe to the RS232 port, you must use the optional accessories 8053-OC.



Do not pull the optic fiber by holding onto the cable but use the connector so that the head does not get damaged.
Avoid dirt and other particles getting into the transducers of the optic fiber.

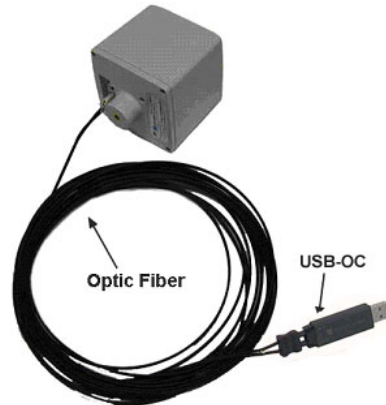

Fig. 4-2 EHP-50C link with USB-OC

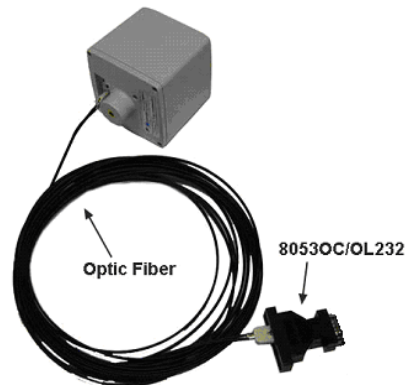
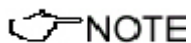

Fig. 4-3 EHP-50C link with 8053-OC



EHP-50C should be OFF.

4.3 COM Port setting with 8053-OC

In case USB/OC adapter is not available, the former optical/RS232 adapter can be used to connect EHP-50 to PC.

With 8053-OC the program automatically establishes the connection on the first RS232 port that is not in use at that time, in the following order: COM1, COM2, COM3, etc.

NOTE

The energy available on the DB9 connector of some PC model could be not sufficient to guarantee a good link with 80 meter fibre.

NOTE

The energy available on the DB9 connector of some PC model could be not sufficient to guarantee a link with 8053-OC. In this case, it is necessary to use 8053-OC-PS between the converter and PC. (for more information see Accessories).

Whenever a port is tied up by a device (e.g. modem) which is not active or turned off at that time, the program recognises it as free and will therefore attempt to connect EHP-50C to that port. In this case, it is necessary to “force” the next serial port by the following procedure:

- Click right the requested program icon and select “properties”.

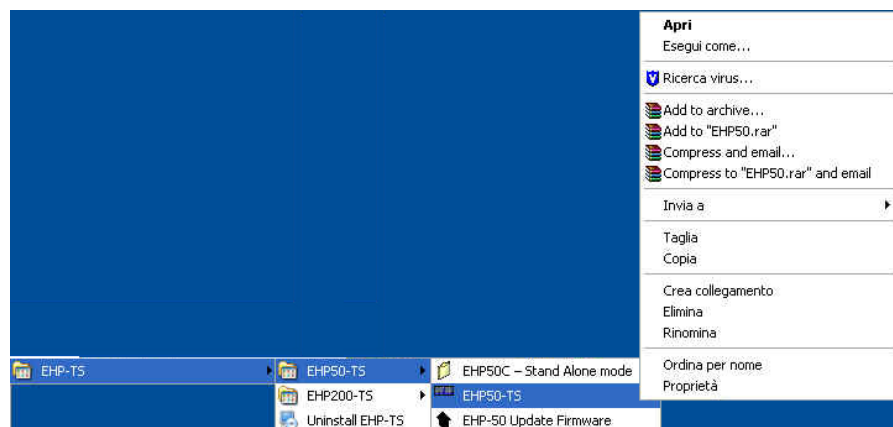
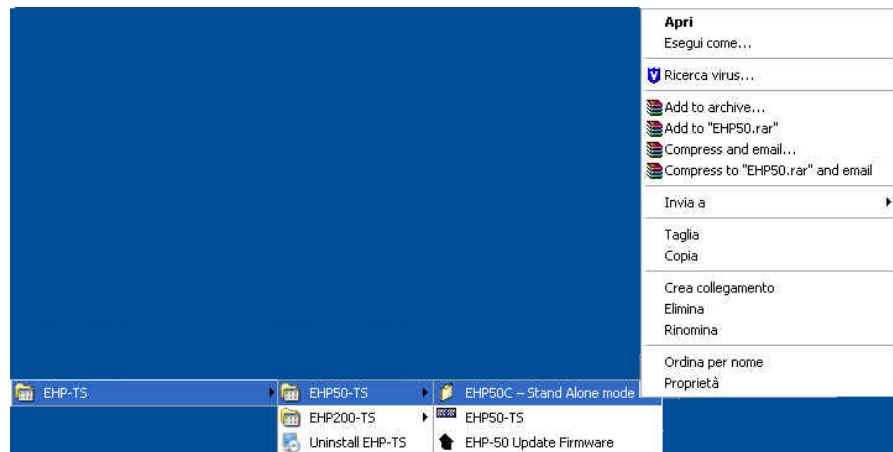

- Add the command COMM=N preceded by a space (in capital letters) at the end of the Destination field where N indicates the serial port to be used; for example, if the EHP-50C is connected to port 2, add the command COMM=2.

The assigned COM port nr. must be between 1 and 9.

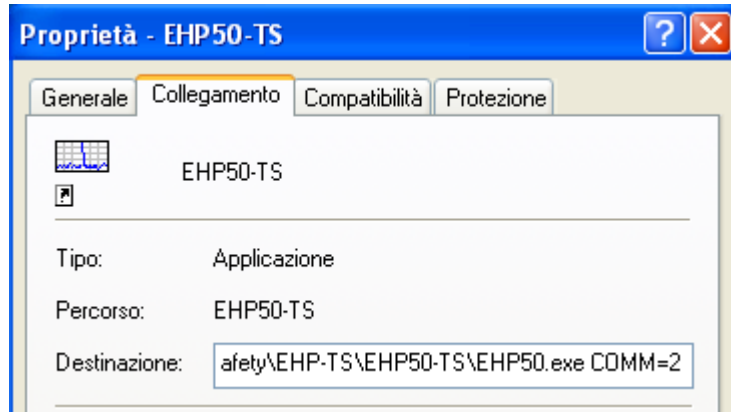

- In some operating system the Destination field is enclosed in double quotation marks (""); in this case, the command COMM=N, preceded by a space must be outside as in the example below;

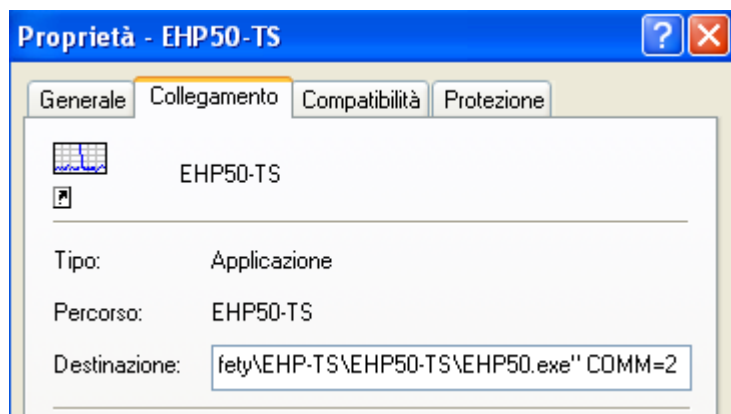

- Then confirm by selecting Apply
- After switching the analyzer ON, run the control software.

 NOTE

EHP-50C must be ON before running EHP-50 control software. EHP-50C may not be correctly recognized if switched ON when the control software is already running.

This page has been left blank intentionally

5 – EHP-TS software

5.1 EHP-TS applications

EHP-TS software includes different applications to be used with EHP family analyzers, shortcuts are showed, selecting “all programs” from the windows XP “start” button:

The EHP-50 section includes three different applications:



EHP50C – Stand Alone Mode: main task of this program is to set up EHP-50C for standalone mode. The analyzer will take and log E or H field measurements (according to the setting) for up to 24 hours, when switched on without any connection to external devices (see operating manual for details). Using EHP-50C-Stand Alone mode program is then possible to download measurement results and store them as a text file.

EHP50-TS: this program is used to perform live measurements when an EHP-50C analyzer is connected to PC

EHP-50 Update Firmware: this is a tool to update EHP-50C firmware

The EHP-200 section includes two applications:



EHP200-TS: this program is used to perform live measurements when an EHP-200 analyzer is connected to PC

EHP-200 Update Firmware: this is a tool to update EHP-200 firmware

Only EHP-50 is considered in this document.



WARNING

EHP-TS software does not work with EHP50A/B.

5.2 EHP50-TS Application

This chapter contains a brief description of controls and functions provided by EHP-50-TS application included in EHP-TS software. Connect EHP-50C to the USB port of your PC through optical fiber and USB-OC or 8053-OC converter.

5.3 Main menu

Switch the analyzer ON and run EHP50-TS application.



After initial information appears for few seconds the program main window will be showed:

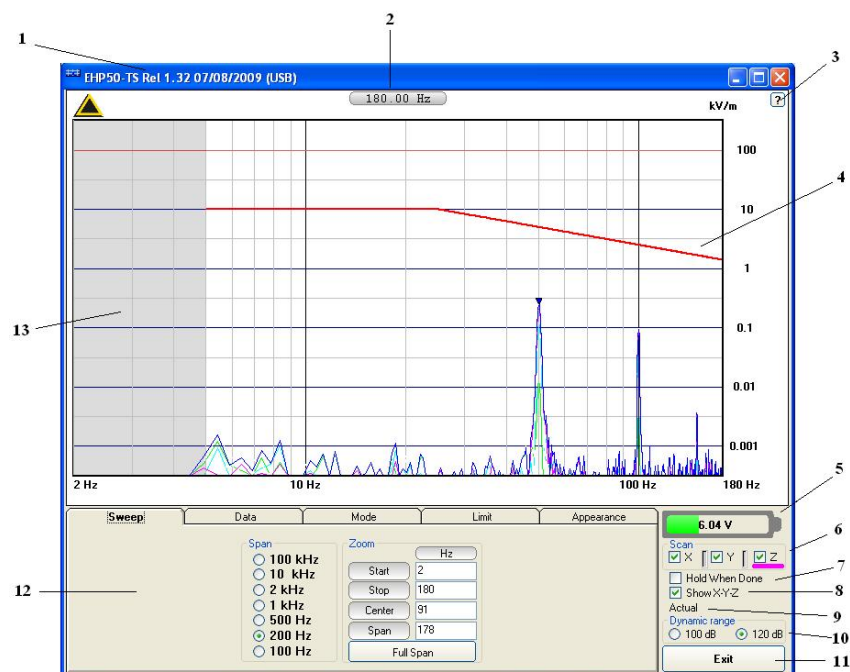

Fig.5-1 EHP50-TS Main Window

Description:

- 1 – EHP50-TS software release, communication port.
- 2 – Shows frequency while scanning
- 3 - Click “?” to display Firmware release of EHP-50C analyzer
- 4 – trace of selected Limit
- 5 – EHP-50C analyzer battery status
- 6 – **Scan** activation for each axis (default setting: all axis activated)
- 7 – **Hold When Done**: stops scan to allow data analysis as soon as all axis have been measured
- 8 - **Show X-Y-Z**: to display or not the traces of single axis.
- 9 – Acquisition mode selected (see **Mode** section)
- 10 – **Dynamic range** (chosen between 100 and 120dB)
- 11 – **Exit** button to terminate application
- 12 – Control panel
- 13 – Display for spectrum analysis

Commands are grouped in the control panel in 5 different sections:

Sweep: to select a specific frequency span and, within the selected span, to set zoom function

Data: to display measurement results and save data

Mode: to set different operating modes

Limit: to create and save limit traces, to activate a specific limit

Appearance: to change colour and button aspect

Each section can be activated with a mouse click.

5.3.1 Sweep section

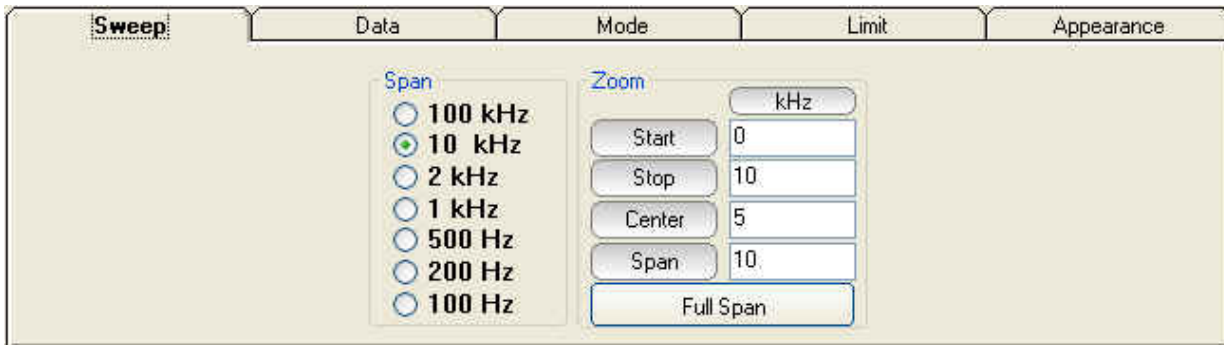

EHP-50C includes an FFT analyzer to show frequency spectrum of measured field. The sweep section includes the following:

Span: select one of the 7 available **span** keeping in mind that beside the EHP-50C minimum operating frequency of 5 Hz, the minimum **start** frequency of each Span is 1,2% of Span. For example, selecting 1kHz span the minimum start frequency should be 12Hz (automatically adjusted to the nearer step available of 12.5Hz). This to avoid that the 0Hz signal, common to every spectrum analyzer, is included in the measurement result.

Zoom: within the selected frequency **span**, you can operate a zoom function to define a specific frequency range over which perform your measurement. For this purpose **Start**, **Stop**, **Center** and **Span** can be set to easily define frequencies to be displayed. The **Full Span** button deactivate the Zoom function showing the whole Span selected.

 **NOTE**

Right click and drag on the graph window to define graphically the Zoom frequency range.

5.3.2 Data section

| Sweep | Data | Mode | Limit | Appearance | | | | | | | | | | | | | | | | | | | | |
|--------------|---|------------------|-------|------------|---|--------------|--------|-------|------|--------|--------|------|-----|-------|---------|--------|--|----------|--------|------------------|--|---|---|--|
| | <table border="1"> <tr> <td></td> <td>kV/m</td> <td>Hz</td> <td>%</td> </tr> <tr> <td>Highest Peak</td> <td>0.1645</td> <td>50.00</td> <td>84.3</td> </tr> <tr> <td>Marker</td> <td>0.0000</td> <td>2.00</td> <td>0.0</td> </tr> <tr> <td>Delta</td> <td>-0.1644</td> <td>-48.50</td> <td></td> </tr> <tr> <td>WideBand</td> <td>0.1791</td> <td>178.00 bandwidth</td> <td></td> </tr> </table> | | kV/m | Hz | % | Highest Peak | 0.1645 | 50.00 | 84.3 | Marker | 0.0000 | 2.00 | 0.0 | Delta | -0.1644 | -48.50 | | WideBand | 0.1791 | 178.00 bandwidth | | Marker <input checked="" type="radio"/> Total <input type="radio"/> X <input type="radio"/> Y <input type="radio"/> Z <input type="checkbox"/> Limit | <input type="button" value="Highest Peak"/> <input type="button" value="Next Peak"/> <input type="button" value="Previous Peak"/> | Save <input type="button" value="Save as bitmap"/> <input type="button" value="Copy to clipboard"/> <input type="button" value="Save as text"/> |
| | kV/m | Hz | % | | | | | | | | | | | | | | | | | | | | | |
| Highest Peak | 0.1645 | 50.00 | 84.3 | | | | | | | | | | | | | | | | | | | | | |
| Marker | 0.0000 | 2.00 | 0.0 | | | | | | | | | | | | | | | | | | | | | |
| Delta | -0.1644 | -48.50 | | | | | | | | | | | | | | | | | | | | | | |
| WideBand | 0.1791 | 178.00 bandwidth | | | | | | | | | | | | | | | | | | | | | | |

Measurement result: the following values are showed in a table form:

Highest Peak: Maximum value within the displayed spectrum.

Showned parameters:

Highest Peak field strength in the selected Unit (V/m in the above picture)

Highest Peak frequency (Hz)

% of contribution to the WideBand result

Marker: you can place a marker anywhere on the spectrum display with a mouse click

Showned parameters:

Field strength at Marker frequency in the selected Unit (V/m in the above picture)

Marker frequency (Hz)

% of contribution to the WideBand result

Delta: Difference in Field strength (expressed in dB) and frequency (Hz) between Highest Peak and Marker

WideBand: integration over the displayed frequency band

Showned parameters:

Field strength in the selected unit calculated over

Bandwidth (Hz)

Marker: in this area you can select on which trace to place the Marker: specific axis (X,Y,Z) or Total result. Three dedicated buttons allows Marker positioning over peaks.

If activated, Limit checkbox allows displaying of the Limit value corresponding to the Marker frequency.

Save: three buttons in this area to save spectrum as a picture file (.bmp), as a text file (.txt) or to copy the spectrum picture to the Windows Clipboard.

5.3.3 Mode section

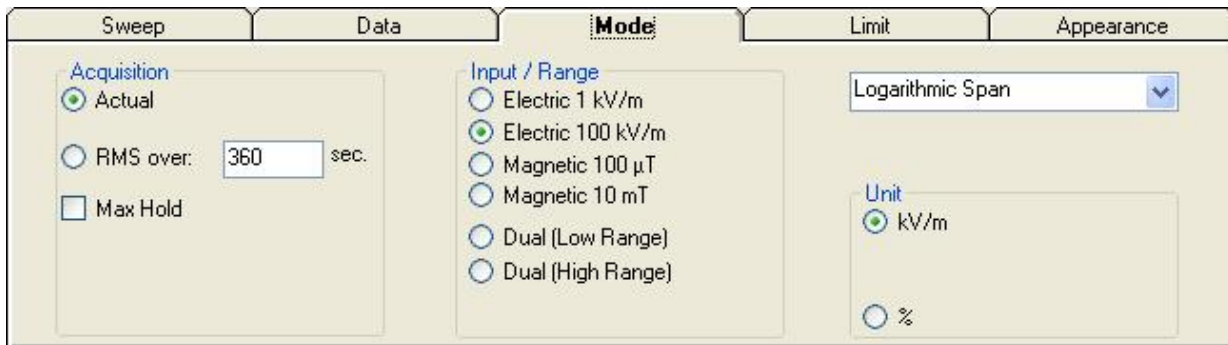

Acquisition: spectrum is displayed in different acquisition modes:

Actual: instantaneous values are showed

RMS over: square averaging calculated over the specified time period (sec) is showed

Max Hold: the maximum field strength value of each frequency step is retained and displayed since the Max Hold function has been activated.

Input/Range: to select electric, magnetic or dual mode field (contemporary displaying of both Electric and Magnetic fields) in two different ranges.

Linear Span or Logarithmic Span: this is used to chose between linear or logarithmic frequency scale.

Unit: to select unit according to the Input setting

NOTE

The unit “%” can be selected only if a Limit has been activated. Each spectrum line will then represent the field strength expressed as percent of the selected limit.

5.3.4 Limit section

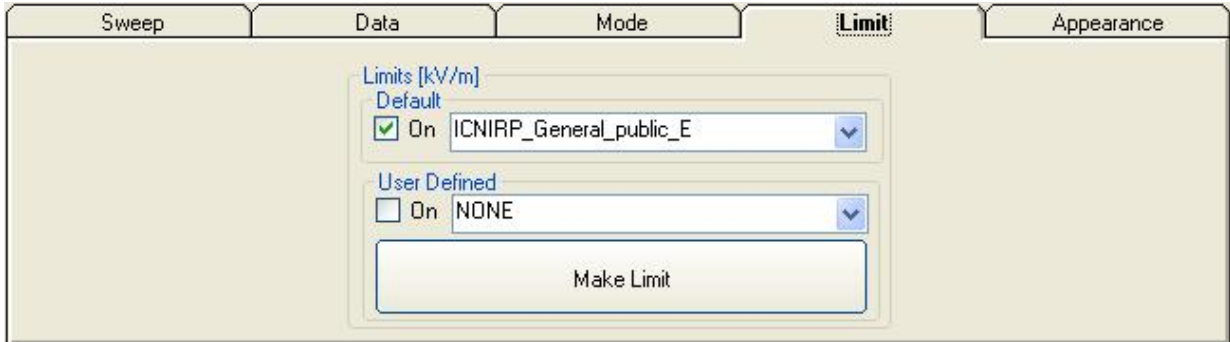

Default: The default limit section can be used to load a default standard limit saved into the memory at the factory.

User Defined: This limit section allows to select and activate a specific limit among limits created and saved by the user.

The **Make Limit** button opens a window to edit limits and create new ones:

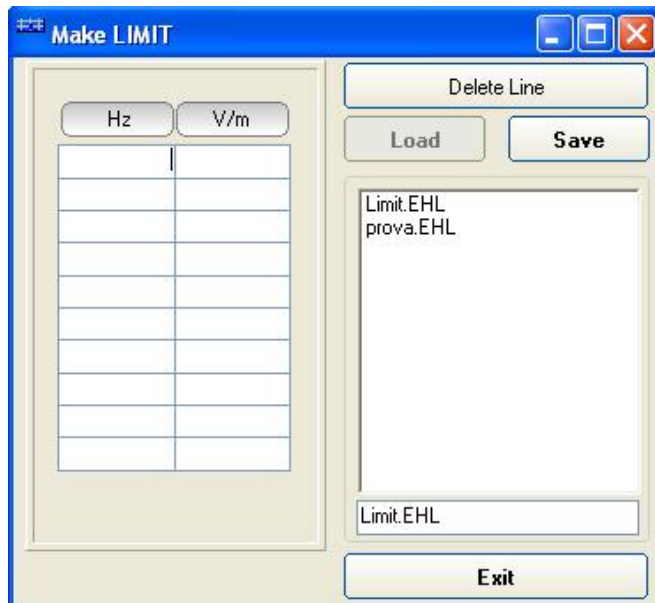

Type frequency and field strength for each point of the required limit and click save to save it under the program directory. The limit file will be created as a linear interpolation between specified points.

5.3.5 Appearance section

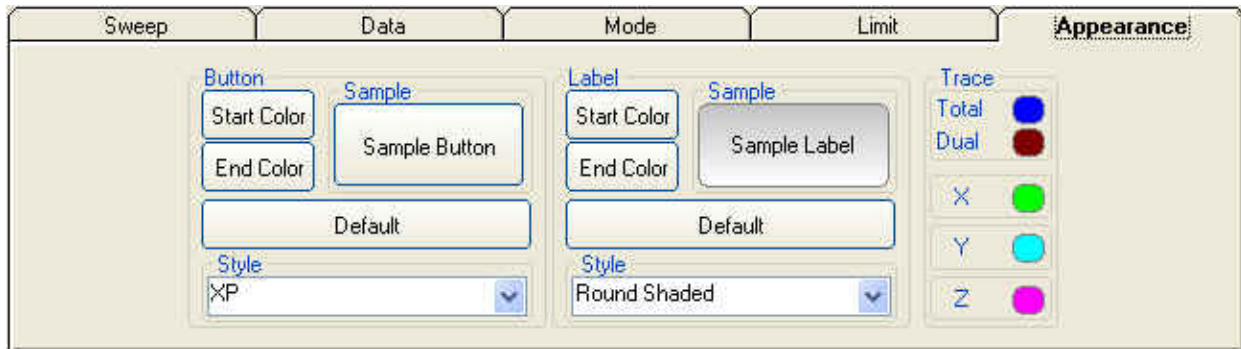

Button and label style can be selected from a **Style** list

Start and **End Color** button allow selection from a color palette

Sample Button and **Sample Label** show the appearance preview

Default button to set appearance to the default parameters

Trace to set trace colours by means of the colour palette

6 - EHP-50C Stand alone mode

6.1 Stand alone mode description

EHP-50C has been designed to be used also in stand-alone mode. This mode is useful because no external devices is connected to the analyzer during measurements. Once the measurement parameters have been programmed through a PC, the EHP-50C analyzer can start its acquisition by storing the data over 24 hours in a stand-alone mode. It is necessary to position it over the TR-02A tripod and to activate the start. After 24 hours it will stop automatically and later it would be possible to download all data to the PC by using the provided NARDA software. From PC it is possible to select to measure the electric or magnetic field, to select the full scale, the Highest or Wideband mode, the SPAN wished and the sampling rate of one minute or 30 seconds.

Some typical applications are:

- Magnetic fields near high, medium and low voltage transformers
- Measurements in proximity of power line towers
- Safety measurement at worker's site
- Measurements close to machines, air conditioning systems, home appliances etc.
- Development of new products

To start the stand-alone acquisition it is necessary to follow this procedure:

- Turn OFF the EHP-50C
- Remove the fiber optic connected to PC
- Insert the small optical bridge connector into the fiber receptacle of EHP-50C
- Position it on TR-02A tripod or use the small tripod supplied with EHP-50C
- Turn ON the EHP-50C and you will see the led flashing red and green for about one minute
- Go away from the analyzer in order to non influence the measurement
- Wait 24 hours for the completion of the one day measurement



Fig. 6-1 Shorting loop

The led of EHP-50C will flash every second to inform that it is ON with red light. After every minute (or 30 sec) the led will become green for the time requested by the analyzer to perform one measurement. The time that the led remain green will depend by the selected SPAN. Lower Span requires longer measurement time.

NOTE

The acquisition can be terminated earlier than 24 hours. Just turn off the EHP-50C and run EHP50C application to download the data to the PC.

6.2 EHP-50C Data Logger

Once the data has been collected by EHP-50C, you should connect it to the PC to download all measurement results.

6.2.1 Run EHP-50C-Stand Alone mode software

Run "EHP-50C Stan Alone mode" application

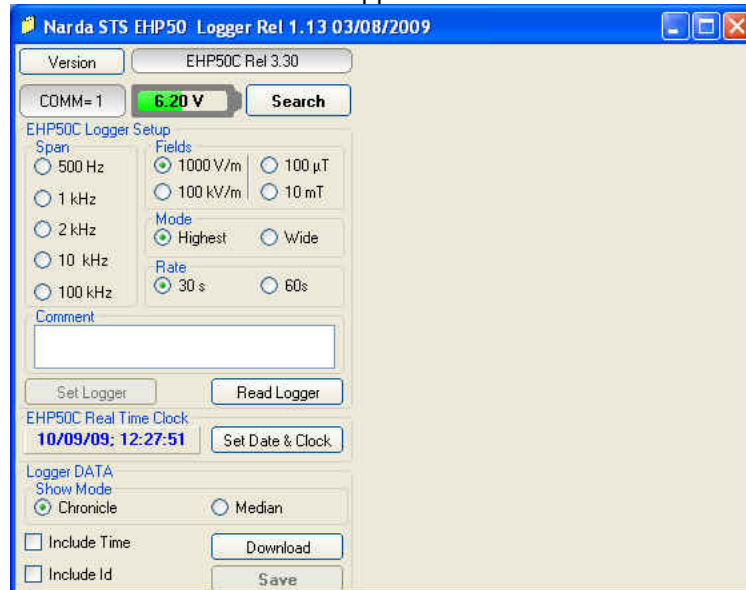

During the communication process for searching the analyzer EHP-50C, the following messages will appear in sequence for a few seconds:



To define measurement parameters for a new stand alone acquisition you may need to select:

- **(SPAN)** The Span
- **(FIELD)** The electric or magnetic field with the proper full scale
- **(MODE)** The Wide or Highest mode
- **(RATE)** The Storing Rate
- **(COMMENT)** To Insert the comments

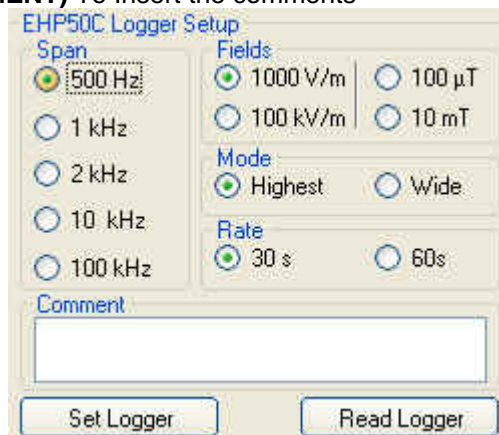

The **Read Logger** will not be available unless the communication between the PC and the analyzer has been established. Click this button to read the actual EHP-50C setup.

The **Set Logger** window will not be available unless you change some parameters. The **Set Logger** will be highlighted and available for the user to transfer all measurement parameters to the EHP-50C internal memory.



It is possible to set the date & clock inside the EHP-50C by transferring the actual date & time of your PC. Pushing the button **Set Date & Clock** you will get the following window:

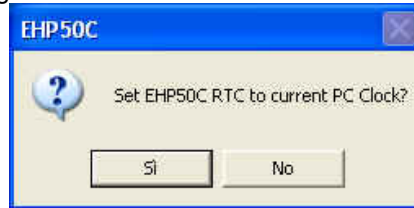

Answering YES, the date & time of your PC will be transferred inside the analyzer.

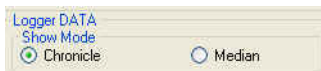

The measurement results can be shown in two modes:

Chronicle: the data are ordered by increasing time like in the following example:

Logger Started 11/07/08; 09:58:27 Rate: 30s.

| Time | V/m |
|----------|---------|
| 9.58.30 | 221.564 |
| 9.59.00 | 181.761 |
| 9.59.30 | 192.088 |
| 10.00.00 | 192.531 |
| 10.00.30 | 183.231 |
| 10.01.00 | 184.502 |
| 10.01.30 | 184.927 |
| 10.02.00 | 184.077 |
| 10.02.30 | 184.714 |
| 10.03.00 | 183.654 |
| 10.03.30 | 183.865 |
| 10.04.00 | 184.289 |
| 10.04.30 | 184.502 |
| 10.05.00 | 183.654 |
| 10.05.30 | 184.077 |
| 10.06.00 | 183.231 |
| 10.06.30 | 181.552 |
| 10.07.00 | 183.443 |

Median: the data are ordered from the lowest value to the highest like in the following example:

Logger Started 24/06/09; 15:56:02 Rate: 30s.

| Time | V/m |
|----------|-------|
| 03:58:00 | 1,756 |
| 17:10:30 | 5,702 |
| 17:11:30 | 5,708 |
| 17:12:00 | 5,721 |
| 17:25:30 | 5,721 |
| 17:38:00 | 5,721 |
| 17:41:00 | 5,721 |
| 17:46:30 | 5,721 |
| 18:00:00 | 5,721 |
| 17:13:30 | 5,728 |
| 17:26:30 | 5,728 |
| 17:38:30 | 5,728 |
| 17:16:00 | 5,735 |
| 17:18:30 | 5,735 |
| 17:26:00 | 5,735 |
| 17:27:30 | 5,735 |
| 17:30:30 | 5,735 |
| 17:34:00 | 5,735 |

| | |
|--|----------|
| <input checked="" type="checkbox"/> Include Time | Download |
| <input type="checkbox"/> Include Id | Save |

If the checkbox **Include Time** is activated, the absolute time will be shown together with the collected data

If the checkbox **Include Id** is activated, a number representing the position of the data inside the EHP-50C memory will be shown, like in the following example.

| Id | Time | μ T |
|----|-------|---------|
| 1 | 18.31 | 0.010 |
| 2 | 18.32 | 0.012 |
| 3 | 18.33 | 0.015 |
| 4 | 18.34 | 0.011 |
| 5 | 18.35 | 0.012 |
| 6 | 18.36 | 0.009 |
| 7 | 18.37 | 0.010 |
| 8 | 18.38 | 0.042 |
| 9 | 18.39 | 0.043 |
| 10 | 18.40 | 0.042 |
| 11 | 18.41 | 0.042 |
| 12 | 18.42 | 0.043 |
| 13 | 18.43 | 0.043 |
| 14 | 18.44 | 0.041 |
| 15 | 18.45 | 0.043 |
| 16 | 18.46 | 0.043 |
| 17 | 18.47 | 0.043 |

| |
|----------|
| Download |
|----------|

Push the button **Download** to transfer all data from the analyzer to the PC

Save

To save the data into your own PC directory, it is necessary to activate the button **Save**.

Data will be save in TXT format according to the following window:

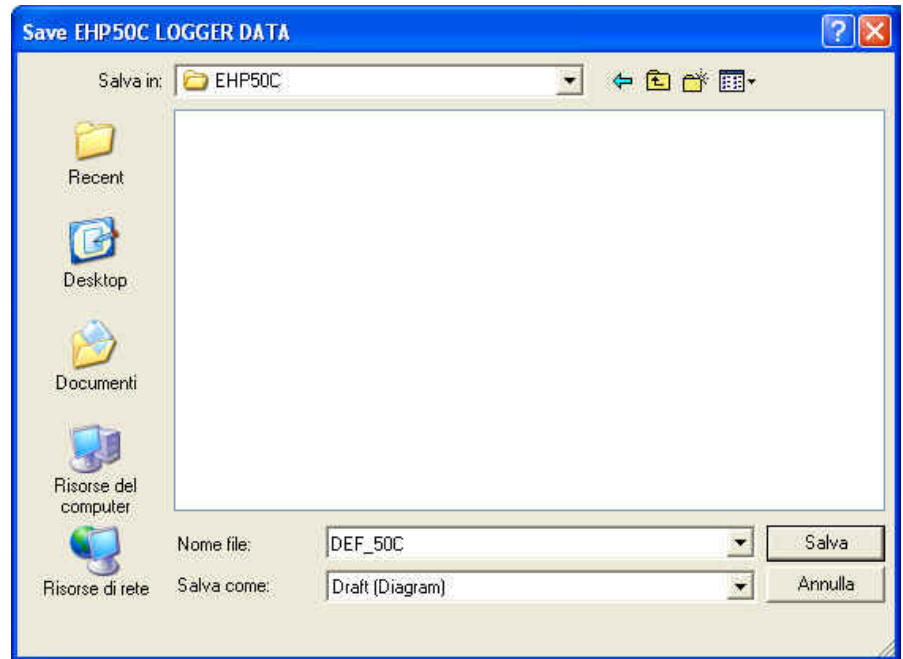

6.2.2 Use EHP-50C Logger

When the communication between the PC and the analyzer has been established, push the button **Download** to transfer all data from the analyzer to the PC.
To use such data you must save them into a file.

A typical display will be:

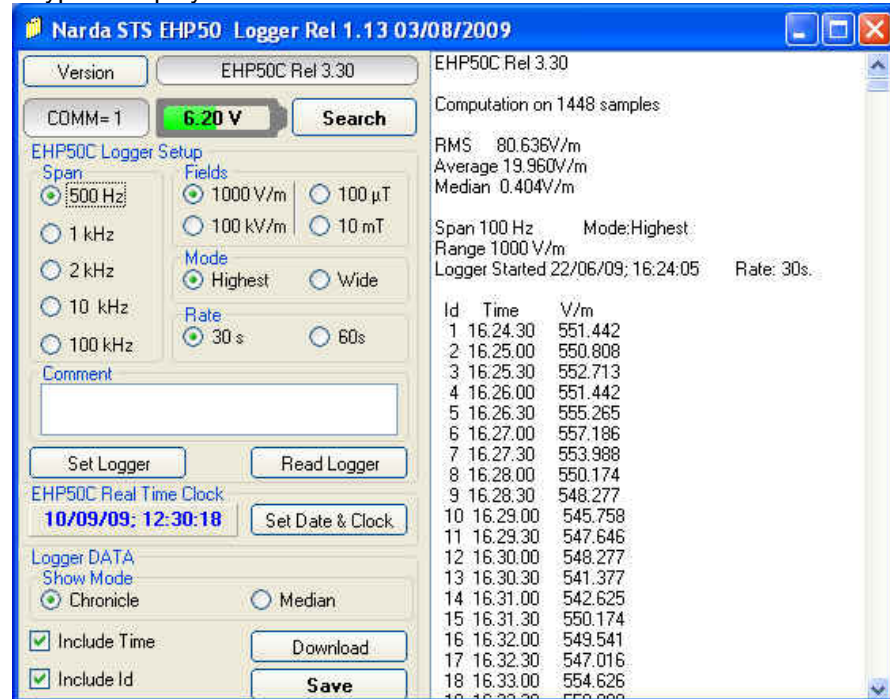

On the right side of the display, the software shows:

- Firmware release of EHP-50C
- The comment that you wrote inside the memory of EHP-50C typing few words in the **Comment** window
- Number of samples stored
- RMS, Average and Median values
- Span and Mode used during the acquisition
- Range
- Starting date and time
- All values collected

6.2.3 EHP-50C battery charging

While EHP-50C is connected to the PC and the battery charger is plugged to the analyzer, the software will display:



and the led is flashing quickly.

NOTE

During the charging process, always remove the bridge connector from the EHP-50C

7 – Update Firmware

7.1 Update firmware

The EHP-50C internal firmware can be updated easily by the user itself.

This section provides all the information required for firmware updating.

The Update Firmware Program is available after EHP-TS package installation.

7.2 To run the update software

Turn off the EHP-50C and connect it to a free USB or RS232 port of the PC.

Run **EHP-50 Update Firmware** to start the update program.

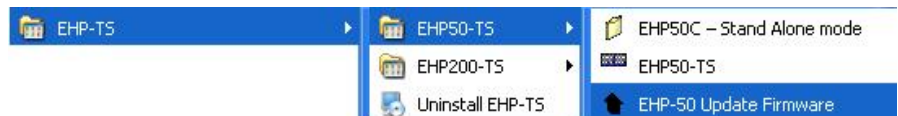

7.3 To transfer data

Main window displayed after the updating program **EHP-50C Update Firmware** has been run:



Fig.7-1 EHP-50C Upgrading Utility Main Window

Select USB or RS232 communication port.

Before selecting RS232 port, choose the COM port used.



NOTE

In case the software doesn't detect any EHP-50C in the USB port, the following message will be displayed.



As soon the connection is established, the program is ready to update EHP-50C firmware.

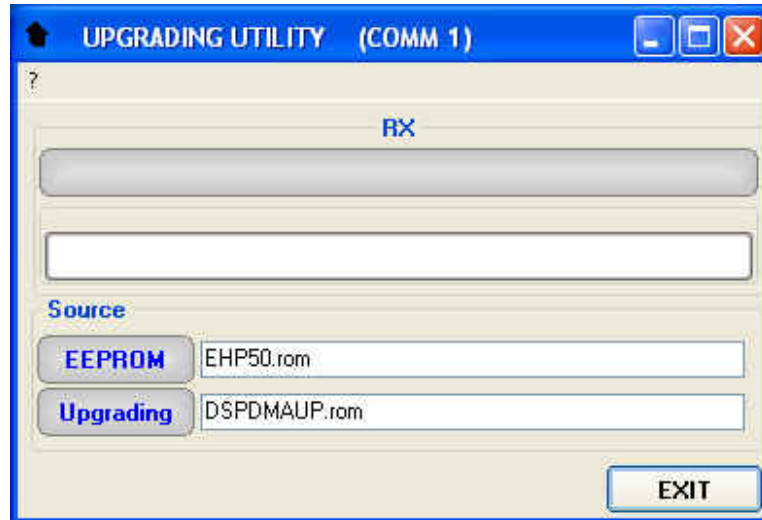

To start the process simply switch EHP-50C on and wait (few minutes) until the automatic transfer is completed.

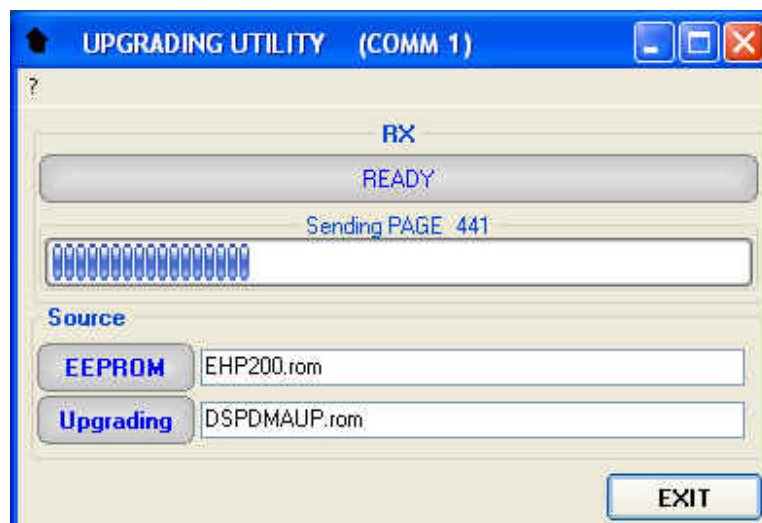
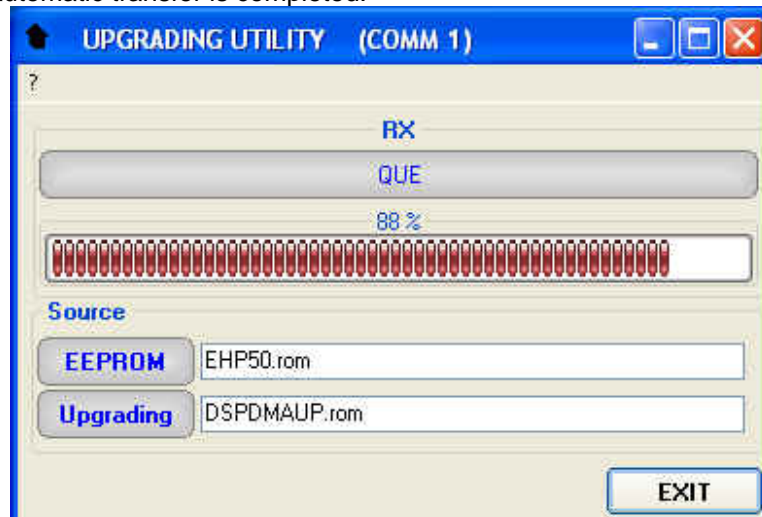

At the end, if the update has been successfully performed, the following window will appear:



Turn the EHP-50C **OFF** (it seems already OFF but it is not) and turn it **ON** again.

The EHP-50C is now updated with the new version of the internal firmware.

It is now possible to disconnect the cable connected to the PC, with the EHP-50C meter either switched on or off.

Subsequently, when the meter is switched on again, the new version of the firmware will be displayed in the 8053-Display, EHP50-TS or EHP-50C Stand Alone Mode application software.

 **NOTE**

To obtain firmware or programs updates for EHP-50C, please contact your NARDA agent or download it directly from the NARDA Web site: www.narda-sts.it

This page has been intentionally left blank

8 – Uninstalling Software

8.1 Uninstalling EHP-TS Software

It is possible to remove the EHP-TS software from the PC according to the following procedure:

Run the Uninstall EHP-TS utility.



Follow the uninstaller instructions.

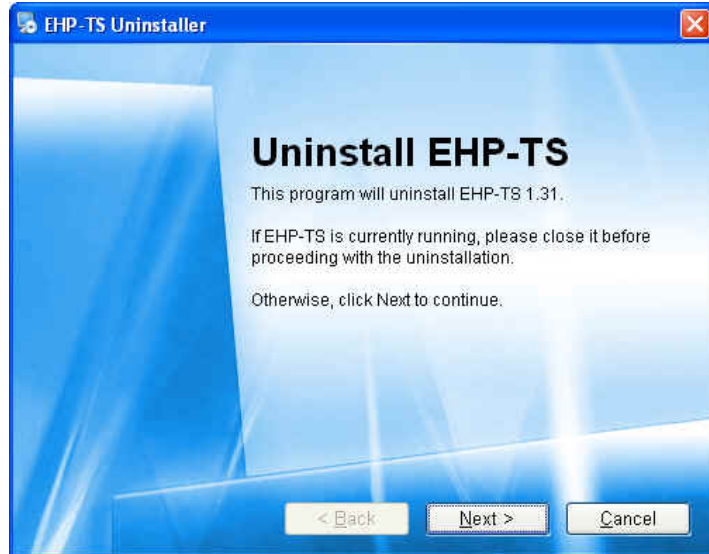
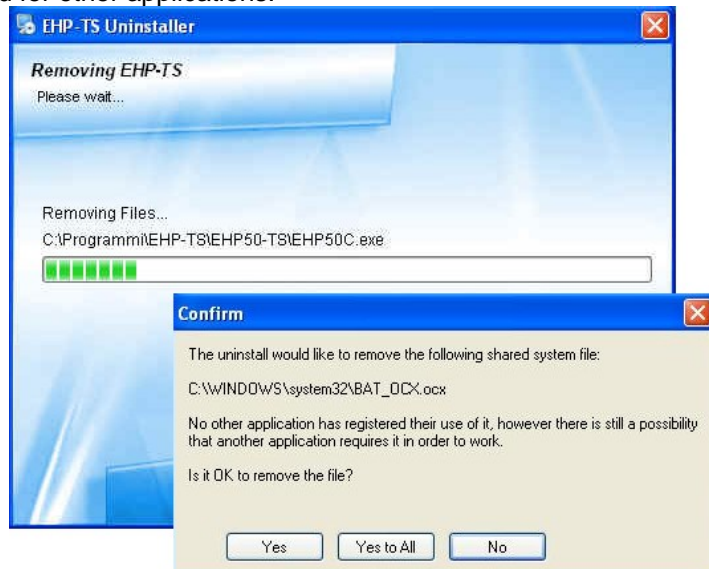

Fig.8-1 Uninstalling EHP-TS

Before removing any shared system file, the uninstaller will ask for a confirmation.

Answer “NO” in case you are not sure whether the showed system file is required for other applications.





EHP-TS software is now removed from the system, click “Finish” to close uninstaller utility

9 – Uninstalling USB-OC

9.1 Uninstalling driver for USB-OC It is possible to remove the USB-OC driver from the PC according to the following procedure:

Open the Windows Control Panel.



Double click "Application Installation".

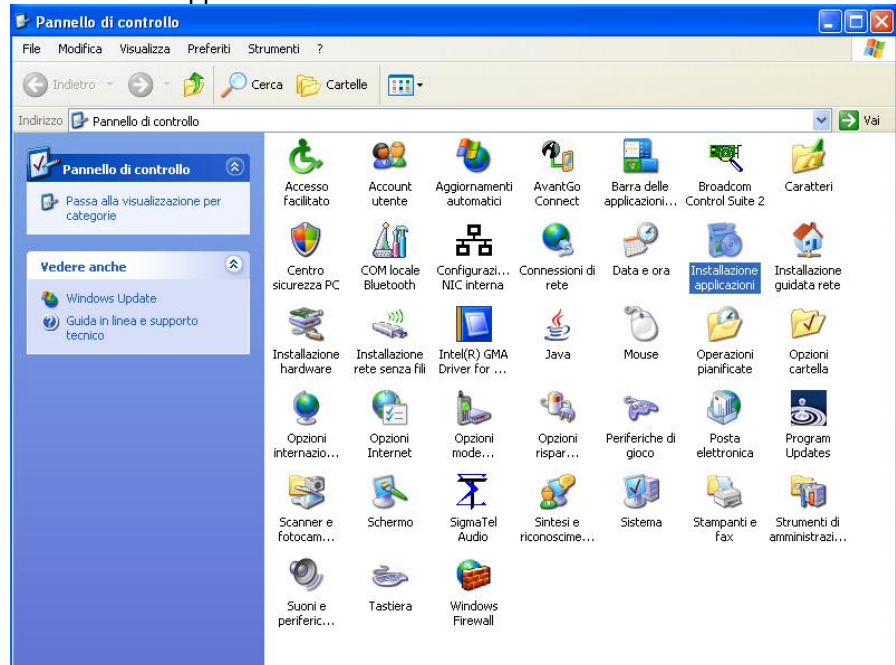

From the application list select “FTDI FTD2XX USB Drivers” and click “Change/Remove”.

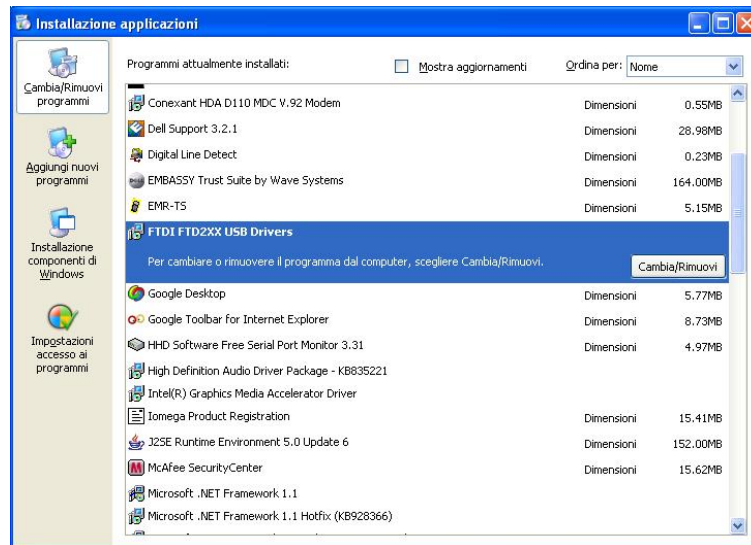
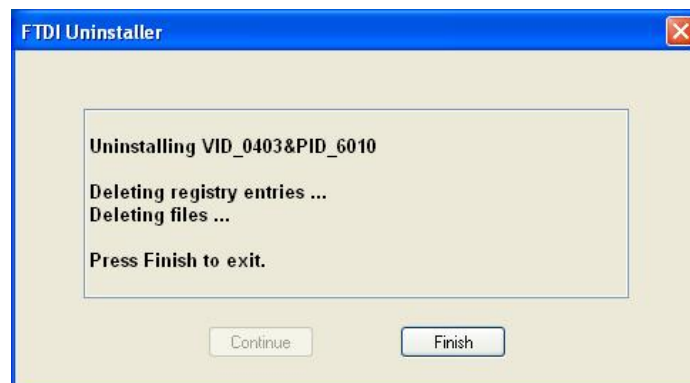

Fig.9-1 Uninstalling USB-OC

Unplug the USB-OC converter, if connected, and click “Continue”.



Click “finish” to exit the uninstaller, USB driver is now removed from your system.

10 - Accessories

10.1 Introduction

This section provides the information required for installing and using the accessories of the EHP-50C Analyzer.

Information is included regarding initial inspection, power requirements, interconnections, work environment, assembly, cleaning, storage and shipment.

The following general information is applicable to all accessories.

10.1.1 Preliminary inspection

Inspect the packaging for any damage.



WARNING

If the packaging or anti-shock material have been damaged, check that the contents are complete and that the meter has not suffered electric or mechanical damage.

Check that all the Accessories are there against the checklist found with the apparatus.

Inform the carrier and NARDA of any damage that has occurred.

10.1.2 Work environment

Unless otherwise specified, the work environment of the Accessories, must come within the following conditions:

- Temperature From -10°C to +50° C
- Humidity < 90% relative

The Accessories must be stored in a clean and dry environment, free from dust, acids and humidity.

The storage environment must come within the range of the following conditions:

- Temperature From -20°C to + 70° C
- Humidity < 95% relative

10.1.3 Return for repair

When the Accessories need to be returned to NARDA for repair, please complete the questionnaire appended to this User's Manual, filling in all the data that will be useful for the service you have requested.

For reducing the period of time required for the repairs, it is necessary to be as specific as possible in describing the problem. If the problem only occurs in certain circumstances, please describe in detail how it happens.

If possible it is better to reuse the original packaging; making sure that the apparatus is wrapped in thick paper or plastic.

Otherwise, use strong packaging by using a sufficient quantity of shock absorbent material around all sides of the meter to ensure that it is compact and does not move around inside the package.

In particular, take every precaution to protect the front panels.

Finish the package by sealing it up tightly.

Apply a FRAGILE label to the package to encourage greater care in its handling.

10.1.4 Cleaning

Use a dry, clean and non-abrasive cloth for cleaning the instruments.



WARNING

Do not use solvents, acids, turpentine, acetone or other similar products for cleaning the devices in order to avoid damaging them.

10.1.5 Power supply and battery chargers

All the accessories of EHP-50C have a power system, which is autonomous from the mains and is supplied by either internal rechargeable batteries or directly from other devices to which they are connected. The accessories use the same battery charger supplied with the meter. The AC/DC battery charger (650.000.036) can be used with a power frequency at either 50 Hz or 60 Hz with a supply voltage between 100 and 240 AC Volt. It can be supplied with different connectors to the supply mains in accordance with the various national standards. The connector to the mains supply is fitted to the battery charger, to substitute it just disconnect it and fit the new connector. To have the greatest autonomy, a full recharging cycle should be carried out before using the Accessories.

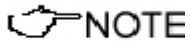

ALWAYS connect the battery charger to the power supply BEFORE connecting to the Charge input of the Accessories. The battery charger has an internal protective circuit that will break the output of current if there is a change in output when connecting to the mains.

Battery charger:
output: DC, 10 - 15 V, ~ 500 mA

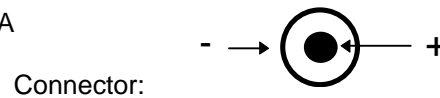

In order to safeguard the features of the batteries, it is crucial to have a complete recharge before storing them for periods longer than 4 months. Therefore, it is warmly suggested recharging the batteries at least every 4 months even though the device has not been used.

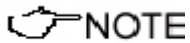

Updates of the software and firmware of the Accessories can be downloaded from the Web site <http://narda-sts.it> or requested directly from NARDA Sales Centres.

10.2

USB-OC Optical USB Converter

10.2.1 Introduction



USB-OC is an standard accessory of the EHP-50C Analyzer. It converts the signals of some of the system’s accessories, which are only connected via fiber optic, into USB-compatible signals. It, therefore, makes it possible to link the following Accessories up to the USB port of any Personal Computer for updating the firmware:

- EHP-50C Electric and Magnetic Field Analyzers
- EHP-200 Electric and Magnetic Field Analyzers
- 8053-GPS Global Positioning System

USB-OC is indispensable for updating the internal firmware of the above-mentioned accessories via a Personal Computer and the relative update software is available free-of-charge on NARDA’s Web site at: <http://narda-sts.it>

10.2.2 Installation

Insert USB-OC in the connector of a free USB port of the PC, connect the fiber optic coming from the probe or other Accessories treating the locating key with care.

Considering the very low consumption of the device, the power required by USB-OC is taken directly from the USB port of the PC. This means no maintenance is needed.

| Table 10-1 Technical specifications of the USB-OC Optical USB Converter | |
|---|-------------|
| Max. length of the fiber optic | 40 m |
| USB Connector | Type A Male |

 NOTE

The link between USB-OC and a HUB USB device or USB cable extension could not work properly. Connect the USB-OC to the PC directly.

Front view



Key:

Fiber optic connector

Rear view



Key:

USB Type A Male

Fig. 10-1 USB-OC adapters

Power supply

USB-OC is powered directly from the USB port of the PC.

This page has been intentionally left blank

10.3

8053-OC Optical RS232 Converter

10.3.1 Introduction



8053-OC is an optional accessory of the EHP-50C Analyzer.

It converts the signals of some of the system's accessories, which are only connected via fiber optic, into RS-232-compatible signals. It, therefore, makes it possible to link the following Accessories up to the serial port of any Personal Computer for updating the firmware:

- EHP-50C Electric and Magnetic Field Analyzers
- EHP-200 Electric and Magnetic Field Analyzers
- 8053-GPS Global Positioning System

8053-OC is indispensable for updating the internal firmware of the above-mentioned accessories via a Personal Computer and the relative update software is available free-of-charge on NARDA's Web site at: <http://narda-sts.it>

10.3.2 Installation

Insert 8053-OC in the connector of a free serial port of the PC, connect the fiber optic coming from the probe or other Accessories treating the locating key with care.

Considering the very low consumption of the device, the power required by 8053-OC is taken directly from the serial port of the PC. This means no maintenance is needed.

Table 10-2 Technical specifications of the 8053-OC Serial Optical Converter

| | |
|--------------------------------|-----------|
| Max. length of the fiber optic | 80 m |
| RS 232 Connector | 9 pin DB9 |

NOTE

The energy available on the DB9 connector of some PC model could be not sufficient to guarantee a good link with 80 meter fibre.

NOTE

The energy available on the DB9 connector of some PC model could be not sufficient to guarantee a link with 8053-OC. In this case, is necessary use 8053-OC-PS between the converter and PC.

Front panel

Key:

1 – Fiber optic connector



Rear panel

Key:

1 - RS232 female DB9 connector

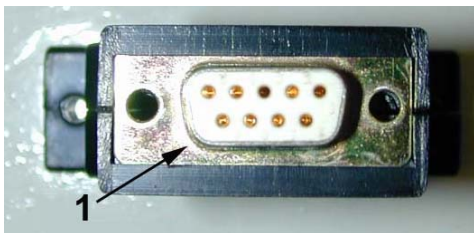

Fig. 10-2 8053-OC Panels

Power supply

8053-OC is powered directly from the serial port of the PC.

This page has been intentionally left blank

10.4

8053-OC-PS Power Supply

10.4.1 Introduction

8053-OC-PS is an optional accessory of the EHP-50C Analyzer.



8053-OC-PS is indispensable for some PC model don't have sufficient energy on the Serial Port to guarantee a link with 8053-OC.

10.4.2 Installation

Insert 8053-OC-PS in the connector of a free serial port of the PC or serial cable and connect the 8053-OC to 8053-OC-PS. To supply the 8053-OC-PS with 230Vac - 9Vdc Wall Adapter. Connect the fiber optic coming from the probe or other Accessories to 8053-OC.

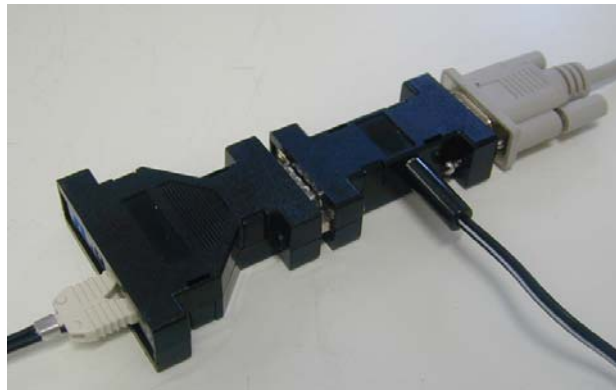

Table 10-3 Technical specifications of the 8053-OC-PS Power Supply

| | |
|--------------------------|-----------|
| RS 232 Connectors | 9 pin DB9 |
|--------------------------|-----------|



Front panel

RS232 male DB9 connector



Rear panel

RS232 female DB9 connector



Side panel

Supply male connector

Fig. 10-3 8053-OC-PS Connectors

Power supply

8053-OC-PS is powered through 230Vac - 9Vdc Wall Adapter.

This page has been intentionally left blank

10.5

8053-Display

10.5.1 Introduction

8053-Display is an Optional accessory of the EHP-50C Analyzer. 8053-Display is a versatile and expandable test system suitable for measuring electric and magnetic fields relating to electrosmog. The system consists of various electric and magnetic field probes and of a compact and portable meter equipped with a wide LCD display, 4 simple function keys (which allow different actions and settings, in accordance with the selected menu), internal rechargeable batteries and RS232 and fiber optic interfaces. The system also has a wide range of Accessories, which have been designed for all the needs of the tests.

10.5.2 Standard accessories

The standard accessories included with 8053 DISPLAY are:

- 8053-SC Soft carrying case, holds basic unit and accessories (650.000.035);
- 8053-Serial Cable, 1.5m (210.500.002);
- AC/DC battery charger (650.000.036)
- Downloading & firmware update Program Disk;
- 8053SW-02 Data acquisition software
- User's Manual;
- Calibration Certificate;
- Return for Repair Form.

10.5.3 Optional accessories

The following accessories may be ordered separately:

- FO-8053/10 Fiber Optic Cable (10m);
- FO-8053/20 Fiber Optic Cable (20m);
- FO-8053/40 Fiber Optic Cable (40m);
- FO-8053/80 Fiber Optic Cable (80m);
- FO-10USB Fiber Optic Cable (10m);
- FO-20USB Fiber Optic Cable (20m);
- FO-40USB Fiber Optic Cable (40m);
- TR-02A Tripod with Swivel;
- TT-01 Fiber Glass Telescopic Support;
- SB-04 Switching Control Box;
- 8053-CC Rigid Carrying Case;
- 8053-CA Car Adapter;
- 8053-OC Optical Converter;
- USB-OC Optical Converter;
- 8053-GPS GPS Unit;
- 8053-RT Remote Trigger;

10.5.4 Main specifications

Table 1-1 lists the specifications of 8053-Display. The specifications of all accessories are listed in the Chapter on Accessories. The following conditions apply to all specifications:

- Temperature for use must be between -10°C and +40°C.

TABLE 10-4 Technical Specifications of 8053 DISPLAY

| | |
|----------------------------------|---|
| Frequency range | Depending on the probe |
| Dynamic range | >140 dB (depending on the probe) |
| Operating range | |
| Resolution | Depending on the probe (See Table 1-2) |
| Sensitivity | |
| Units | V/m, kV/m, μ W/cm ² , mW/cm ² , W/m ² , A/m, nT, μ T, mT; |
| LCD Display | |
| Field measured | X, Y, Z in absolute values, percent and total. |
| Time | Internal clock in real time |
| Probe | Display of the model and date of calibration |
| Graphic bar | The analog bar displays: - real time value with respect to full scale; - field versus time (in linear or logarithmic form) with automatic time scaling; - alarm threshold. |
| Measuring function | |
| Internal memory | Up to 32.700 measurements (up to 8.100 standard memory, up to 21.600 extended memory) |
| Alarm | Variable threshold from 0 to 100% of full scale. Internal sound and blinking symbol on the display when the level is greater than the alarm threshold |
| Functions | Minimum, Maximum and Averaging |
| Averaging mode | Arithmetic, quadratic (RMS), manual, rolling and spatial |
| Averaging time | Definable 30 sec, 1, 2, 3, 6, 10, 15, 30 min or manual |
| Data acquisition (Logger) | Sampling mode (1, 10-900 sec/sample), data change, over the limit, average on 6 min, manual, spectrum (with EHP-50C) |
| General specifications | |
| Output | LCD display 72x72mm 128x128 pixel, RS232 (with cable or fiber optic) |
| Input | Fiber optic connector |
| Internal battery | Rechargeable at NiMH (5 x 1.2 V) |
| Operational time | 24 hours normal mode, 48 hours (in SAVE MODE function: display off) |
| Recharge time | < 4 hours (15 minutes charge for 1 hour of use) |
| External power supply | DC, 10 - 15 V, I = about 500 mA |
| Interfaces | RS232 (calibration and firmware update) |
| Software/Firmware | Upgrade available via Internet at the Web site: http://www.narda-sts.it |
| Autotest | Automatic during switch-on of all functions; |
| Calibration | Inside the built-in E ² PROM of the probe |
| Conformity | With Directives 89/336 and 73/23 and the amendments to them CEI 211-6 and 211-7 |
| Operating temperature | From -10 to +40°C |
| Storage temperature | From -20 to +70°C |
| Size (WxHxD) | 108 x 240 x 50 mm |
| Weight | 1.07 kg |
| Tripod support | Threaded insert ¼" |

10.5.5 Field probes

Beside EHP-50C, other probes are available for using with 8053-Display as EHP-200 and other models to be launched in the near future.

| TABLE 10-5 Series of Electric and Magnetic field probes | | | |
|---|----------------------|------------------|-------------------|
| Field Probes | | Frequency range | Level range |
| Electric and Magnetic Field Analyzer EHP200 | @10kHz RBW | 9 kHz ÷ 30 MHz | 0,1 ÷ 1000 V/m |
| | with preamplifier ON | | 0,02 ÷ 200 V/m |
| | @10kHz RBW | 9 kHz ÷ 3 MHz | 30 mA/m ÷ 300 A/m |
| | with preamplifier ON | | 6 mA/m ÷ 60 A/m |
| | @10kHz RBW | 300 kHz ÷ 30 MHz | 3 mA/m ÷ 30 A/m |
| | with preamplifier ON | | 0.6 mA/m ÷ 6 A/m |
| | @10kHz RBW | 9 kHz ÷ 30 MHz | -80 ÷ 0 dBm |
| | with preamplifier ON | | -94 ÷ -14 dBm |

10.5.6 Front panel

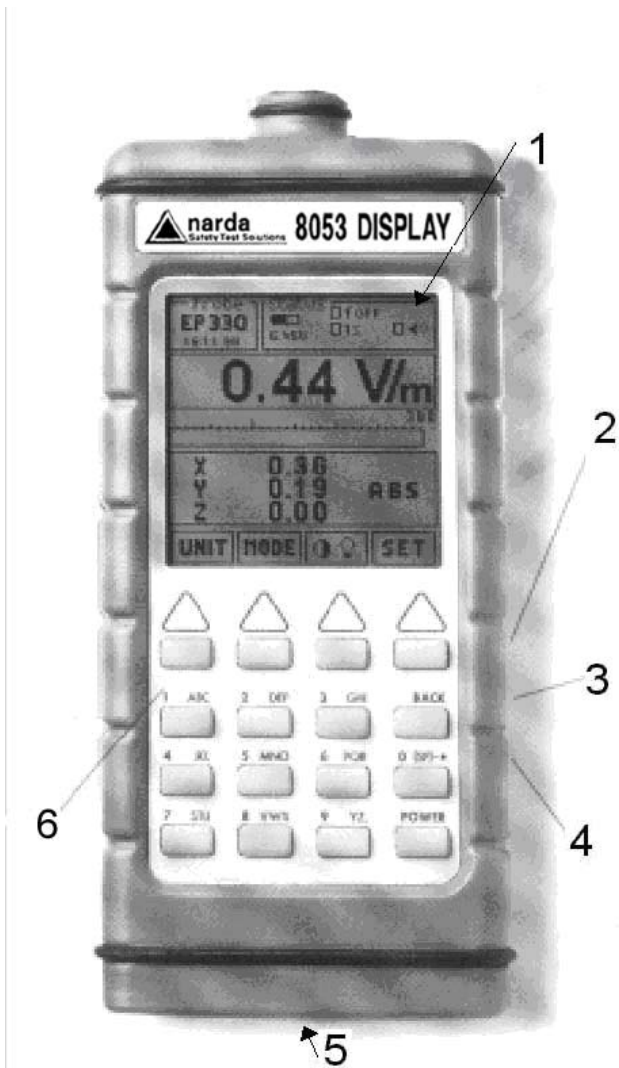

Key:

1. Display
2. Fiber optic Input/Output for additional probes, USB or RS232 interface via fiber optic link
3. RS232 interface
4. Battery charger input, from 10 to 15V DC, 500 mA
5. Securing screws to tripod
6. Alphanumeric keyboard

Fig. 10-4 Front panel

10.5.7 Side panel

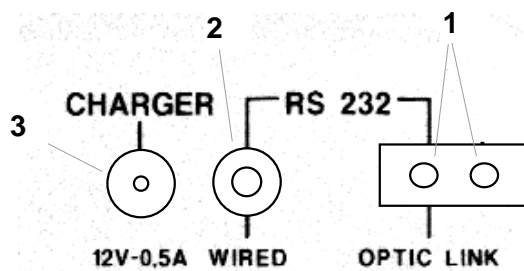

Key:

1. Connection EHP-50C or EHP200 fiber optic link
2. Wired RS232 interface for direct connection to the PC
3. Battery charger connector (12V, 0.5A)

Fig. 10-5 Side panel

10.5.8 Battery charger

The battery charger supplied with the meter can work at either 50 Hz or 60 Hz with a supply voltage range between 100 and 240 Volt. It is supplied with different connectors to the supply mains in accordance with the various national standards.

10.5.9 To substitute the mains connector

To substitute the mains connector, simply remove the one installed on the battery charger and replace it with the one that is in compliance with its use.

10.5.10 To check the internal batteries

If the internal batteries are to have the greatest autonomy, we recommend that a full recharging cycle be carried out before using the meter.

To do this, go through the following procedure:

- Connect the battery charger to the power socket
- Link the output connector of the battery charger to the input **CHARGER** on the side panel of the meter
- 8053-Display will switch on automatically, after making a sound produced by the internal buzzer, the display will be activated and the meter will start its auto-check and begin the procedure for recognising the probes.
- The main window will therefore be activated and the status of the charge (**CHG**) of the battery will be displayed in the **STATUS** box

Indications of the battery in the STATUS box:

The status of the charge of the battery is displayed in the top left-hand corner of the **STATUS** box. The symbol of a small battery will be filled up proportion to the status of the battery charge.

The battery charger will be automatically stopped when one of the following occurs and a small connector will be displayed relating to a letter indicating the end of the recharging cycle.

Display of the following letters means:

V – The voltage of the batteries has reached 1.45 V/element (7.25 total), and therefore the recharging cycle is complete.

H – The recharging cycles has lasted for more than 4 hours.

T – The temperature of the batteries, compared to the temperature stored after ten minutes recharging, has increased more than 10 °C, or the temperature of the battery has reached 65 °C.

When the recharging cycle is finished, the 8053-Display is ready for use.

NOTE

To avoid damage to the batteries, when the T symbol appears, the recharging cycle is stopped automatically.

To finish the recharging cycle wait for about ten minutes for the batteries to cool down then reconnect the battery charger.

Battery charger: DC, 10 - 15 V, ~ 500 mA



Connector:

NOTE

ALWAYS connect the battery charger to the mains power BEFORE connecting the DC output to 8053 DISPLAY. The battery charger has an internal protective circuit that will not let it work if there is a load connected to the battery charger before the connection to the mains is activated.

NOTE

In order to safeguard the features of the batteries, it is crucial to have a complete recharge before storing them for periods longer than 4 months. Therefore, it is warmly suggested recharging the batteries at least every 4 months even though the device has not been used.

This page has been intentionally left blank

10.6

SB-04 Switching Control Box

10.6.1 Introduction

SB-04 Switching Control Box is a versatile and expandable Accessory designed to operate with the EHP-50C for measuring electric and magnetic fields.

SB-04 allows the user to take field measurements with up to 16 probes connected at the same time, either placed in different measuring points and/or working on different frequencies and full scale ranges

Two internal microcontrollers check all operations interfacing the measured data with SW-02 Data Acquisition and Graphics Presentation Software, running on the user's PC.

A SB-04 enables the user to connect up to four devices via fiber optic to the PC by a single RS232 connection.

Up to four SB-04 can be interconnected for the purpose of acquiring and storing measurements coming from a maximum of 16 measuring devices.

NOTE

Every probe to be connected to SB-04 must be equipped with optional FO-8053/xx Fiber Optic Cable (xx required cable length).

10.6.2 Standard Accessories

The following are the standard Accessories supplied with the SB-04:

- RS232 serial cable with 9/25 pin adapter (2 m);
- SB-04 - SB-04 Expansion cable;
- 8053-BC Battery charger;
- 8053SW-02 Acquisition software, without hardware key;
- User's Manual;
- Certificate of Compliance;
- Return for Repair Form;
- Protective covers for the fiber optic ports;



10.6.3 Main specifications

The following Table lists the main specifications.

The following conditions apply to all specifications:

- The ambient temperature for use must be between -10°C and 40°C.

TABLE 10-6 Technical Specifications of SB-04

| | |
|-----------------------------------|---|
| Connections | Up to 4 devices via fiber optic. Connection with the RS232 serial port to a PC for remote operations and for updating the Firmware. Expandable up to 4 SB-04 through the integrated expansion port for a total of 16 connected devices. |
| General specifications | |
| Internal batteries | rechargeable NiMH batteries (5 x 1.2 V) |
| Autonomy | > 10 hours |
| Recharging time | < 12 hours |
| External DC supply | DC, 10 - 15 V, I = about 200 mA |
| Connections in fiber optic | up to 80 m. |
| Internal Firmware update | able to be loaded by the user through the serial port |
| Autocheck | automatically when switched on |
| Conformity | to Directives 89/336 and 72/23. |
| Operational temperature | from -10°C to +40°C |
| Storage temperature | from -20°C to +70°C |
| Size (H x W x D) | 25 x 148 x 220 mm |
| Weight | 900 g |

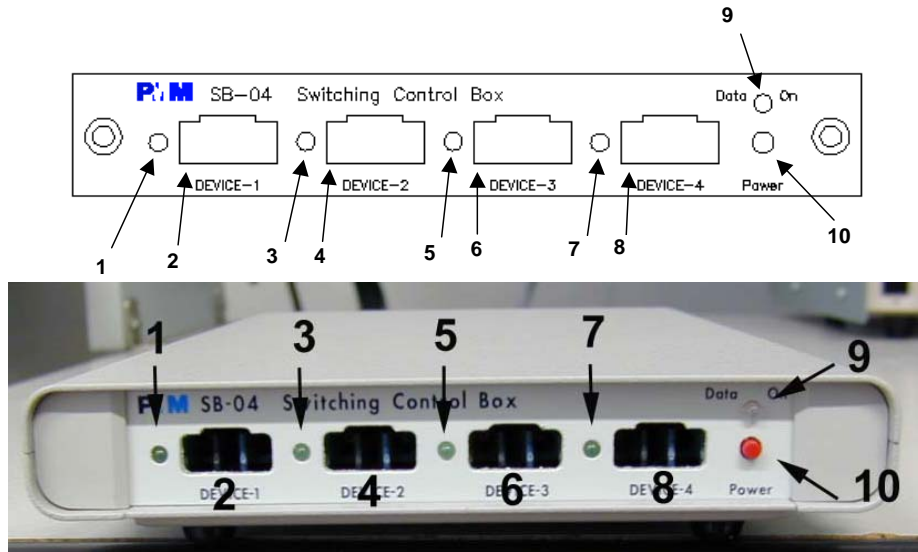

Fig. 10-6 Front panel

Key:

- | | |
|------------------------------------|------------------------------------|
| 1. Device-1 Led; | 6. Device-3 fiber optic connector; |
| 2. Device-1 fiber optic connector; | 7. Device-4 Led; |
| 3. Device-2 Led; | 8. Device-4 fiber optic connector; |
| 4. Device-2 fiber optic connector; | 9. Data On Led; |
| 5. Device-3 Led; | 10. On/Off button; |

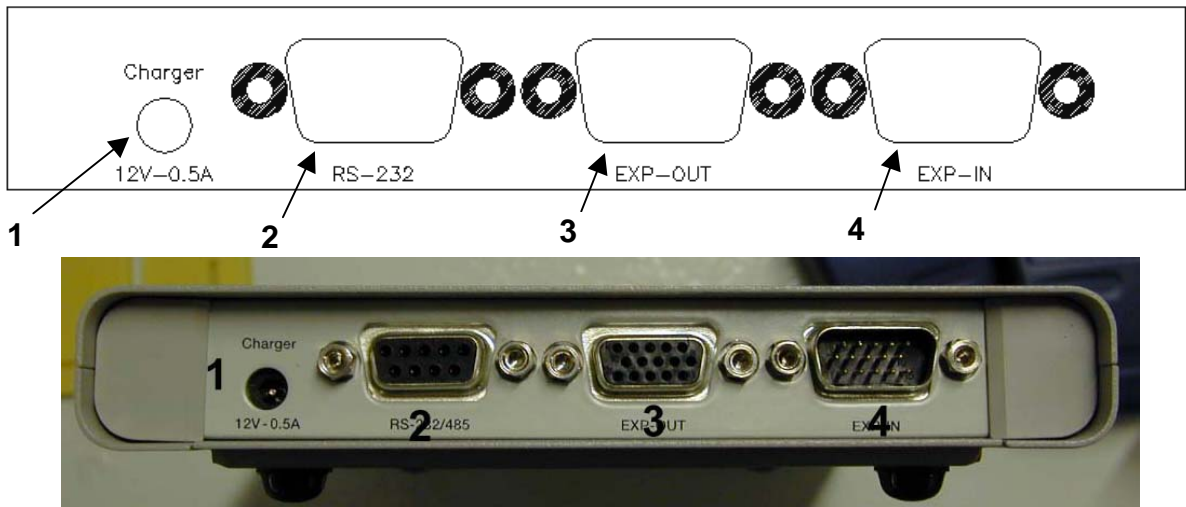

Fig. 10-7 Rear panel

Key:

- | | |
|---|-----------------------------|
| 1. Battery charger Connector (12V, 0,5A); | 3. Expansion out Connector; |
| 2. RS 232 Connector | 4. Expansion in Connector. |

10.6.4 System configuration

The SB-04 Switching Control Box can operate in conjunction with various sensors in a wide range of frequencies and levels. The EHP-50C meter can also be connected to it. Up to four EHP-50C can be connected to each SB-04.

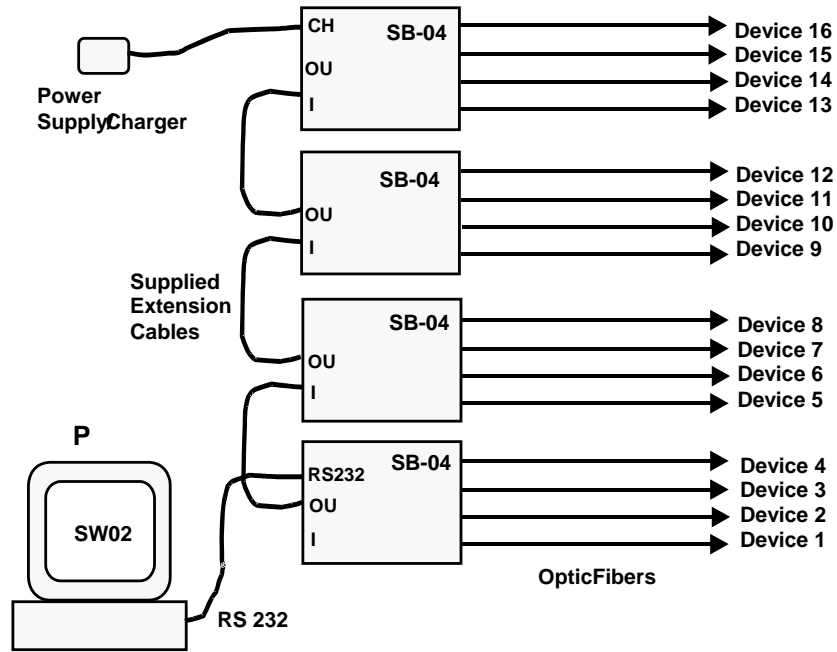
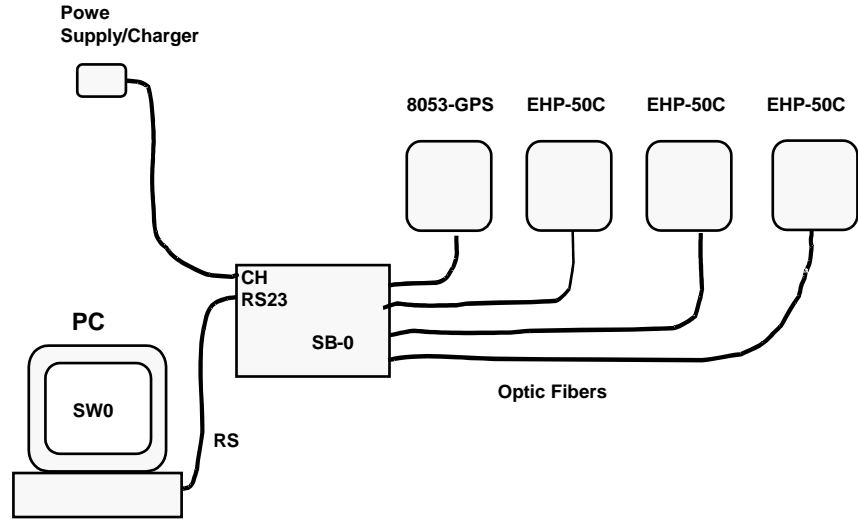

10.6.5 Power supply and battery recharging of SB-04

SB-04 has an internal rechargeable NiMH battery that can be recharged with the battery charger supplied with it (the battery charger is the same as that of 8053 DISPLAY).

If the internal batteries are to have the greatest autonomy, we recommend that a full recharging cycle should be carried out before using the apparatus.

NOTE

ALWAYS connect the battery charger to the power supply BEFORE connecting it to the SB-04.

The battery charger has a internal protective circuit that will break the output of current if there is a charge in output when connecting to the mains.

Battery charger:
output: DC, 10 - 15 V, ~ 500 mA



Connector:

NOTE

The SB-04, which may be used, without distinction, with both the battery charger connected or disconnected, will be respectively powered by the mains or internal batteries.

To switch SB-04 on or off, press the Red **POWER** button on the front panel of the apparatus.

NOTE

Pressing the POWER button down for more than 4 seconds forces the hardware of the apparatus to shut down. In this case, it is necessary to wait several seconds before switching it on again.

After being switched on, the two-colour LED labelled **ON DATA** will provide the following information about power supply:

| TABLE 10-7 Led colour | | | |
|-----------------------|--------------|--------|---|
| Power supply | LED blinking | Colour | Indication of the LED DATA ON |
| Batteries | Low speed | Green | The SB-04 is switched on and in normal use, the voltage of the battery exceeds 5.9 V. |
| Batteries | Low speed | Red | The voltage of the batteries is less than 5.9 V, the batteries need to be recharged. |
| Power supply | High speed | Green | The SB-04 is switched on and in normal use, the batteries are charged. |
| Power supply | High speed | Yellow | The SB-04 is switched on and in normal use, the batteries are being recharged. |

NOTE

When SB-04 is connected to the Battery Charger, it switches on automatically and the POWER button to switch it off is disabled as long as the Battery Charger is connected.

NOTE

When the SB-04 is battery powered and no data transfer with the control software is in progress, it automatically switches itself off after 350 seconds (5 minutes) in order to keep the battery charged.

10.6.6 Installation

To install the SB-04 connect the optional FO-8053/xx Fiber Optic Cable to the **DEVICE-X** input on the front panel being careful to place the spigot in the right direction, then connect the other side of the fiber optic to the **OPTIC-LINK** connector of the EHP-50C measuring device.

NOTE

Every DEVICE-X connection has a LED diode near to it. When the device is connected and switched on the LED blinks indicating that the connection has been made properly.

The following connections are to be found on the back panel:

- **Charger** of the Battery charger/Power supply connector – to recharge or supply power to SB-04;
- **RS 232/485** – to connect to a free serial port of a PC via the serial cable supplied;
- **EXP-OUT** – to connect to the **EXP-IN** connector of the next SB-04 (when required) with the extension cable supplied.

The battery charger can be connected or disconnected, depending on the type of power supply the user wishes to use.

NOTE

When more than one SB-04 is in use, up to 4 in all, each one can be charged or powered by a single power supply.

The battery charger can be connected, without distinction, to any SB-04.

The voltage of the power supply will be propagated to all the devices via the extension cable.

To switch SB-04 on or off press the Red **POWER** button on the front panel.

10.6.7 Use of PMM SB-04

On completion of the set-up of the desired measurement, start SW-02 Data Acquisition and Graphic Presentation Software on the control Personal Computer.

WARNING

To avoid damage to the connection ports of the fiber optics due to the accumulation of dust or dirt and to avoid disturbance to its operation through external luminous sources, always leave the protective covers on the ports that are not in use.

10.7

TR-02A Tripod

10.7.1 Introduction



TR02A is an Optional Accessory of the EHP-50C analyzer. It allows EHP-50C Analyzer to be easily supported during field measurements. Each of these instruments has a securing screw, usually placed on the bottom part of its container, that enables it to be easily and quickly put into place through the 8053-SN swivel supplied with the tripod.

The design and materials of the TR-02A tripod have been specially selected to prevent it from disturbing the sensors and, therefore, the measurements taken.

The height of the tripod can be adjusted by means of its extendable legs and it is furnished with special feet that are able adapt to all surfaces thereby improving stability. The height of its central support can also be adjusted.

It is supplied with a small protective carrybag to make it easy to carry.

Table 10-8 Technical specifications of the TR-02A Tripod

| | |
|--------------------------|--------------------------------|
| • Legs | 3 legs x 3 extendable sections |
| • Transport size: | 76 x 12 x 12 cm |
| • Minimum height: | 60 cm |
| • Maximum height: | 180 cm |
| • Weight | 2.8 kg |
| • Load capacity: | 10 kg |
| • Tripod support | Threaded insert ¼ “ |

Details of the mounting head of the central column of the support and its adjustments:

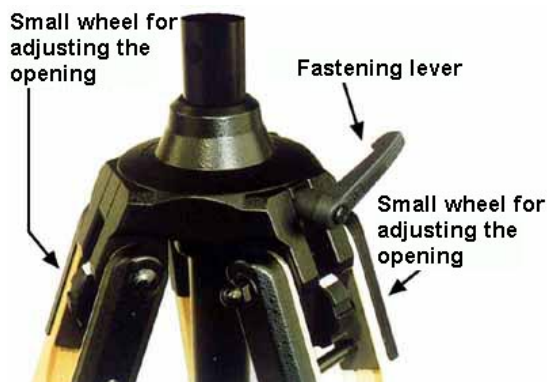

Fig. 10-8 TR-02A Tripod

The angle for opening each leg into three different positions can be adjusted by using special small adjustable wheels:

- fixed opening of 20°: White adjustment indicator is visible (as in the Figure);
- fixed opening of 45°: Red adjustment indicator is visible;
- variable opening: no indicator is visible.

The central support can be adjusted and blocked by means of a special fastening lever.

Details of the swivel for fastening to the **8053-SN**:

- full height: 8 cm
- weight: 160 g
- load capacity: 10 kg
- Threaded insert ¼ "

The adjustable swivel makes mounting and fastening the instrument easy as well as changing the angle in any directions via the locking knob.



10.8

TT-01 Fiber Glass Telescopic Support

10.8.1 Introduction

TT-01 is an Optional Accessory of the EHP-50C Analyzer. It allows EHP-50C Analyzer to be easily supported during field measurements.

This device, on the top part of its container, has a screw to fix the relative apparatus.

The design and materials of the TT-01 have been specially selected to prevent it from disturbing the sensors and, therefore, the measurements taken.

Table 10-9 Technical specifications of the TT-01 Fiber Glass Telescopic Support

| | |
|--------------------------|--------|
| • Diameter | 32 mm |
| • Minimum height: | 120 cm |
| • Maximum height: | 420 cm |
| • Weight | 500 g |

TT-01 Fiber Glass Telescopic Support with soft carrying case



The height of the TT-01 can be adjusted.

Fig. 10-9 TT-01 Fiber Glass Telescopic Support

This page has been intentionally left blank

Other Accessories

Other Accessories are available on request with the EHP50C, such as: car adapter, 12 V battery charger and Internal AC Plug Adapter.



This page has been intentionally left blank

Caro cliente

grazie per aver acquistato un prodotto NARDA! Sei in possesso di uno strumento che per molti anni ti garantirà un'alta qualità di servizio. NARDA riconosce l'importanza del Cliente come ragione di esistenza; ciascun commento e suggerimento, sottoposto all'attenzione della nostra organizzazione, è tenuto in grande considerazione. La nostra qualità è alla ricerca del miglioramento continuo. Se uno dei Suoi strumenti NARDA necessita di riparazione o calibrazione, può aiutarci a servirla più efficacemente compilando questa scheda e accludendola all'apparecchio.

Tuttavia, anche questo prodotto diventerà obsoleto. In questo caso, ti ricordiamo che lo smaltimento dell'apparecchiatura deve essere fatto in conformità con i regolamenti locali. Questo prodotto è conforme alle direttive WEEE dell'Unione Europea (2002/96/EC) ed appartiene alla categoria 9 (strumenti di controllo). Lo smaltimento, in un ambiente adeguato, può avvenire anche attraverso la restituzione del prodotto alla NARDA senza sostenere alcuna spesa. Può ottenere ulteriori informazioni contattando i venditori NARDA o visitando il nostro sito Web www.narda-sts.it.

Dear Customer

thank you for purchasing a NARDA product! You now own a high-quality instrument that will give you many years of reliable service. NARDA recognizes the importance of the Customer as reason of existence; in this view, any comment and suggestion you would like to submit to the attention of our service organization is kept in great consideration. Moreover, we are continuously improving our quality, but we know this is a never ending process. We would be glad if our present efforts are pleasing you. Should one of your pieces of NARDA equipment need servicing you can help us serve you more effectively filling out this card and enclosing it with the product.

Nevertheless, even this product will eventually become obsolete. When that time comes, please remember that electronic equipment must be disposed of in accordance with local regulations. This product conforms to the WEEE Directive of the European Union (2002/96/EC) and belongs to Category 9 (Monitoring and Control Instruments). You can return the instrument to us free of charge for proper environment friendly disposal. You can obtain further information from your local NARDA Sales Partner or by visiting our website at www.narda-sts.it.

Servizio richiesto: *Service needed:*

Solo taratura Riparazione Riparazione & Taratura Taratura SIT Altro:
 Calibration only Repair Repair & Calibration Certified Calibration Other:

Ditta:

Company:

Indirizzo:

Address:

Persona da contattare:

Technical contact person:

Telefono:

Phone n.

Modello:

Equipment model:

Numero di serie:

Serial n.

Accessori ritornati con l'apparecchiatura: **Nessuno** **Cavo(i)** **Cavo di alimentazione** **Altro:**
 Accessories returned with unit: *None* *Cable(s)* *Power cable* *Other:*

Sintomi o problemi osservati: *Observed symptoms / problems:*

Guasto: **Fisso** **Intermittente** **Sensibile a:** **Freddo** **Caldo** **Vibrazioni** **Altro**
 Failure: *Continuous* *Intermittent* *Sensitive to:* *Cold* *Heat* *Vibration* *Other*

Descrizione del guasto/condizioni di funzionamento:

Failure symptoms/special control settings description:

Se l'unità è parte di un sistema descriverne la configurazione:

If unit is part of system please list other interconnected equipment and system set up: