

PM6000

POWER ANALYZER

USER MANUAL



Voltech Instruments Inc.
11637 Kelly road, Suite 306
Fort Myers, FL33908
U.S.A.
Tel: 239 437 0494
Fax: 239 437 3841
sales@voltech.com

Voltech Instruments Ltd.
148 Harwell Business Centre
Didcot, Oxon, OX11 0RA
U.K.
Tel: +44 1235 834555
Fax: +44 1235 835016
sales@voltech.co.uk

Voltech Instruments is committed to a policy of continuous product development. Hence product specification and the information given in this manual are subject to change without notice.

No part of this publication may be reproduced, stored in a retrieval system, or transmitted in any form, or by means electronic, mechanical photocopying, recording or otherwise, without prior written permission of Voltech Instruments.

© 2005 - 2010 Voltech Instruments. All rights reserved.

Microsoft, Windows and the Windows logo are either registered trademarks or trademarks of Microsoft Corporation in the United States and/or other countries.

Voltech Part Number: 98-058

Manual Issue	PM6000 Firmware Revision
18	v1.21.07RC2



DANGER OF ELECTRIC SHOCK

Only qualified personnel should install this equipment, after reading and understanding this user manual. If in doubt, consult your supplier.



RISQUE D'ELECTROCUTION

L'installation de cet équipement ne doit être confiée qu'à un personnel qualifié ayant lu et compris le présent manuel d'utilisation. Dans le doute, s'adresser au fournisseur.



GEFAHR VON ELEKTRISCHEM SCHOCK

Nur entsprechend ausgebildetes Personal ist berechtigt, diese Ausrüstung nach dem Lesen und Verständnis dieses Anwendungshandbuches zu installieren. Falls Sie Zweifel haben sollten, wenden Sie sich bitte an Ihren Lieferanten.



RISCHIO DI SCARICHE ELETTRICHE

Solo personale qualificato può installare questo strumento, dopo la lettura e la comprensione di questo manuale. Se esistono dubbi consultate il vostro rivenditore.

IMPORTANT: Please consult the safety information section of this user manual before installation and use.

Contents

1. Introduction	1-1
1.1. Features & Abilities	1-1
1.2. Package Contents.....	1-3
1.3. Options	1-4
2. Quick Start	2-1
2.1. Getting Started.....	2-1
2.2. Navigating the Menu System	2-1
2.3. Measurement Display	2-3
2.4. Wiring and Groups	2-4
2.4.1 Voltage and Current Input Overview	2-7
2.4.2 To connect an external resistive shunt:.....	2-8
2.4.3 To connect a transducer with a voltage output.....	2-9
2.4.4 To connect a transducer with a current output only.....	2-9
2.4.5 Voltech Shunts	2-9
2.5. Summary	2-10
3. Menu System	3-1
3.1. Navigation.....	3-1
3.2. Menu Items	3-2
3.2.1 Wiring	3-3
3.2.2 Range.....	3-5
3.2.3 Coupling	3-6
3.2.4 Scaling	3-7
3.2.5 Filter	3-8
3.2.6 Frequency Source	3-8
3.2.7 Mode	3-10
3.2.8 Integrator	3-13
3.2.9 Datalog.....	3-15
3.2.10 Measurement	3-19

3.2.11 Format.....	3-27
3.2.12 Graph	3-32
3.2.13 Config.....	3-33
3.2.14 Interface	3-38
3.2.15 Printing	3-40
3.2.16 Data.....	3-41
3.2.17 Trigger.....	3-42
3.2.18 Self Test	3-44
3.2.19 Menu	3-44
3.2.20 Help.....	3-44
3.2.21 User.....	3-44
3.2.22 Menu 1, 2, 3	3-44
3.2.23 HOLD	3-45
3.2.24 RESET / CLEAR.....	3-45
3.2.25 INTEG RUN.....	3-45
3.2.26 DATA DUMP	3-45
3.2.27 PRINT	3-46
4. Remote Operation	4-1
4.1. Overview.....	4-1
4.2. Interfacing with GPIB systems	4-1
4.3. Interfacing with RS232 Systems	4-1
4.4. Interfacing With Ethernet Systems	4-1
4.5. Remote Command Syntax and Conventions.....	4-2
4.6. Status Reporting	4-3
4.6.1 Status Byte Register.....	4-3
4.6.2 Background and Display Status Register.....	4-4
4.6.3 Standard Event Status Register.....	4-4
4.7. IEEE488.2 Common Commands	4-5
4.7.1 *CLS Clear event status	4-5
4.7.2 *ESE Set standard event status enable register	4-5
4.7.3 *ESE? Read standard event status enable register.....	4-5
4.7.4 *ESR? Read event status register.....	4-5

4.7.5 *IDN?	Unit Identity	4-6
4.7.6 *OPC	Initialize Operation Complete Function.....	4-6
4.7.7 *OPC?	Flag when Operation Complete.....	4-6
4.7.8 *RST	Reset Device.....	4-6
4.7.9 *SRE	Set Service Request Enable Register	4-7
4.7.10 *SRE?	Read Service Request Enable Register.....	4-7
4.7.11 *STB?	Read Status Byte.....	4-7
4.7.12 *TRG	Trigger	4-7
4.7.13 *TST?	Report Self Test.....	4-8
4.7.14 *WAI	Wait for Operation.....	4-8
4.8.	Format Commands	4-9
4.8.1 :AVG	Set Averaging	4-9
4.8.2 :BAL	AM/Ballast Mode	4-10
4.8.3 :BRD?	Read Background Data	4-10
4.8.4 :BRF?	Read Background Data Selected Fields.....	4-12
4.8.5 :BSE	Set Background Data Status Enable Register	4-12
4.8.6 :BSE?	Read background Data Status Enable Register	4-13
4.8.7 :BSR?	Read background Data Status Register.....	4-13
4.8.8 :CFG	Configure	4-13
4.8.9 :CFG?	Read Configuration.....	4-13
4.8.10 :CPL	Set AC/DC Coupling	4-14
4.8.11 :DSE	Set Data Status Enable Register	4-14
4.8.12 :DSE?	Read Data Status Enable Register	4-14
4.8.13 :DSR?	Read Data Status Register	4-14
4.8.14 :DVC	Device Clear.....	4-14
4.8.15 :FNC?	Read Result.....	4-16
4.8.16 :FND?	Read Fundamental Result	4-17
4.8.17 :FRD?	Read Foreground Data	4-18
4.8.18 :FRF?	Read Foreground Data Selected Fields	4-20
4.8.19 :FSR	Set Frequency Source	4-20
4.8.20 :HRM	Set Single Harmonic	4-21
4.8.21 :HMX	Set Maximum Harmonic for Series.....	4-21

4.8.22 :INT	Set up Integrator	4-23
4.8.23 :MAX	Enable Max store	4-25
4.8.24 :MEA	Set Measurement Mode	4-25
4.8.25 :MIN	Enable Min store.....	4-26
4.8.26 :PWM	PWM Mode	4-26
4.8.27 :RAV	Reset Averaging	4-27
4.8.28 :RES	Reset Min/Max Store	4-27
4.8.29 :RNG	Set Ranging	4-28
4.8.30 :SCL	Set Scaling.....	4-28
4.8.31 :SEL	Select Function List.....	4-29
4.8.32 :WRG	Set Wiring Configuration.....	4-30
4.9.	Configuration Commands (:CFG command)	4-32
4.10.	:INP Commands.....	4-36
4.10.1	:INP:FILT:LPAS.....	4-36
4.11.	:INST Commands	4-37
4.11.1	:INST:CAT	4-37
4.11.2	:INST:CHAN?	4-38
4.11.3	:INST:NSEL.....	4-38
4.11.4	:INST:NSEL?	4-38
4.11.5	:INST:SEL	4-39
4.11.6	:INST:SEL?	4-39
4.11.7	:INST:STAT	4-39
4.11.8	:INST:STAT?	4-39
4.12.	:SENS Commands.....	4-40
4.12.1	:SENS:ZERO.....	4-40
4.12.2	:SENS:ZERO:AUTO.....	4-40
4.13.	:SYST Commands	4-41
4.13.1	:SYST:CTYPE	4-41
4.13.2	:SYST:TIME	4-41
4.13.3	:SYST:DATE	4-42
4.13.4	:SYST:ERROR.....	4-43
4.14.	Examples of Using Commands.....	4-45

4.14.1 Suggested Protocol	4-45
4.14.2 Retrieving a single result	4-45
4.14.3 Multiple Reads Using FRD?	4-46
4.14.4 Multiple Reads Using the BRD? Command	4-47
5. Remote Access	5-1
5.1. Connecting to the PM6000 using ethernet	5-1
5.1.1 Network Connection Method	5-1
5.1.2 Direct Connection Method	5-1
5.2. FTP	5-3
5.2.1 Anonymous or User login	5-3
5.2.2 Connecting to the PM6000 using Internet Explorer	5-4
5.2.3 Connecting to the PM6000 using an FTP program.	5-4
5.2.4 Finding your way around	5-5
6. Fitting Options	6-1
6.1. Voltech Shunts	6-1
6.1.1 Equipment Required	6-1
6.1.2 Installation Procedure	6-1
6.2. PCMCIA Cards	6-1
7. Software	7-1
7.1. IEC 61000-3-2/3 Current Harmonics and Flicker Software	7-1
7.2. PM6000 Visual Power Analysis Software (PM6VPAS)	7-1
8. Specification	8-3
8.1. Measuring Channel	8-3
8.1.1 Voltage connections	8-3
8.1.2 Current connections	8-3
8.1.3 Analogue Card power supply outputs	8-3
8.2. Mechanical and Environment	8-3
8.2.1 Dimensions (Approx)	8-3
8.2.2 Weight (Approx)	8-3
8.2.3 Line Input	8-3
8.2.4 Dielectric Strength	8-4

8.2.5 Storage Temperature	8-4
8.2.6 Operating Temperature	8-4
8.2.7 Humidity	8-4
8.3. External input.....	8-4
8.4. Peripheral Ports	8-5
8.4.1 Serial Port	8-5
8.4.2 Parallel Port.....	8-5
8.4.3 External Monitor	8-6
8.4.4 External Keyboard and Mouse	8-6
8.4.5 USB Slave Port	8-7
8.4.6 Ethernet Port	8-7
8.4.7 Floppy Disk.....	8-8
8.5. Measured Parameters.....	8-9
8.6. Measurement Accuracy	8-12
8.7. Regulatory Compliance.....	8-16
8.7.1 Safety	8-16
8.7.2 EMC	8-16
8.8. Shunts – 30A and 1A.....	8-17
8.8.1 Mechanical Characteristics.....	8-17
8.8.2 Environmental operating conditions.....	8-17
8.8.3 Measurement Accuracy (30A Shunt)	8-17
8.8.4 Measurement Accuracy (1A Shunt)	8-18
9. Warranty, Service and Updates.....	9-1
9.1. Warranty	9-1
9.2. Calibration and Service	9-2
9.3. Obtaining Service and Applications Support	9-2
9.4. Updating Firmware.....	9-2
10. Safety Information	10-1
10.1. Safety Features.....	10-1
10.2. Safety Instructions	10-1
11. Release History.....	11-1

1. INTRODUCTION

Thank you for choosing to use this Voltech product. If you experience any difficulty during installation or use of the Voltech PM6000, or are unsure of any of its features or abilities, please do not hesitate to contact either your local Voltech supplier or one of our Voltech main service centers.

1.1. FEATURES & ABILITIES

The Voltech PM6000 is a powerful and versatile precision power analyzer. The accuracy and bandwidth of the PM6000 allow definitive measurements of all power quantities to be made on all electrical and electronic products. In applications ranging from a power supply operating in standby mode, through high-frequency power converters, to large power transformers, the PM6000 provides stable, reliable, and accurate measurements every time.



Versatile Technology

The PM6000 couples a fast PCI bus architecture with powerful digital signal processing to provide 5 mega-samples per second (MSPS) - processed on all channels - simultaneously and continuously. This ensures that accurate real-time measurements can be made on products such as power supplies, motor drives and lighting ballasts. Up to 40 MSPS are available for burst and transient measurement modes.

There is room for up to 6 wattmeter channels to be installed into a PM6000 with a variety of shunts and current sensors, creating flexible test options.

Rugged Performance

Each measurement channel can measure up to 2000Vpk and can accept a range of Voltech plug-in current shunts and other current transducers. The PM6000 automatically recognizes Voltech shunts when the instrument is powered up and reads the shunt's own calibration data to ensure optimum accuracy. In this way, only the standard measurement channel is required for all applications.

An embedded PC running the Linux operating system is used to display, communicate and control all the available measurements.

Easy to use

The display soft keys and rotary control are used to select and group measurements, display multi-phase sum quantities, calculate efficiency and to display waveforms. The menu items may also be selected using the front panel short-cut keys or remotely on a PC.

In this way, the PM6000 can be set up to make complex measurements in seconds. Front panel settings may be stored for future use.

For on the spot assistance, a comprehensive help system is built in to the analyzer.

Evolving capability

A program of software enhancement is further developing the power of the PM6000. Regularly visit the Voltech website to keep up to date with developments

1.2. PACKAGE CONTENTS

The following items are supplied with your PM6000.

Please check that you have every item and report any missing items to your Voltech supplier as soon as possible.

- PM6000 Chassis (NOTE: No floppy disk is fitted on models sold after February 2008)
- Certificate of Conformance and Calibration Certificates
- CD including the manual and calibration data
- Mains power cable
- Current Connector plug for each measurement card
- Ethernet Crossover cable for direct PC to PM6000 connection
- Voltech product registration card

Returning your product registration card will ensure that you continue to receive the latest product and application information.

If you have ordered measuring channels and shunts together with a PM6000 chassis, they will be fitted ready for use.

1.3. OPTIONS

The following items may also be supplied with the PM6000. For logistical reasons, some items may be supplied in separate packages. All these items are also available post sale.

- PM6000 Measurement Channel (Fitted by a Voltech service center only)
High performance wattmeter channel. Voltage 2000Vpk, current 2.5Vpk for shunt or current transducer. ± 5 Vdc isolated supply (at current channel potential) and ± 12 Vdc supply (at chassis potential) for external current transducer
- 1A Shunt
1Arms, 5Apk precision measuring shunt with calibration stored in EPROM
- 30A shunt
30Arms, 250Apk precision measuring shunt with calibration stored in EPROM
- Lead set
2 pairs (yellow and black) 1.5m 2000V 32A leads with safety connectors and alligator clips
- Rack mounting kit
For 19", 3 ½ U high
- Internal hard drive
For storage of user data

2. QUICK START

2.1. GETTING STARTED

1. Check the power analyser is in good condition with the correct number of measurement channels and shunts fitted
2. Connect the power cable. Ensure the supply is Earth grounded.
3. Press the power switch at the rear to ON (I)
4. Press the front panel power switch

The instrument will start its power up sequence. This takes approximately one minute

Once completed the display should show columns for the measurement channels

5. The instrument is now ready for use

2.2. NAVIGATING THE MENU SYSTEM











The menu system provides complete access to all settings of the PM6000. The menu system may be accessed as follows:

1. By use of the 6 soft keys found to the right of the display
2. By using the short-cut keys on the front panel. These keys are grouped in a logical left to right sequence for setting up the instrument and provide fast access to the top-level menu items. Additional keys may be used to store your own short cuts to frequently used menu items, [MENU1], [MENU2] and [MENU3].

Press the [HELP] key at any time to activate the in-built context sensitive help system.

For optimum ease of use the actions that the soft keys will take is adjusted to suit the measurement display or menu point shown on the display. The key action is described by a simple graphic symbol that is shown in alongside each key

In most situations pressing the [Menu] key is the quick way to exit the menu system

	Down Menu	View the details of the selected menu item.
	Up Menu	Go back up the menu system.
	Accept	Accept the choice or save the setting.
	Cancel	Cancel setting, exit without saving.
	Up	Move up or through the menu or measurements.
	Down	Move down through the measurements.
	Rotate	Display the next group or trigger.
	Left	Display the measurement column to the left.
	Right	Display the measurement column to the right.
	Help	Switch the help display on or off.
DEL	Delete	Delete one character to the left of the cursor.
CLR	Clear	Clear the current alpha or numeric entry.
ESC	Escape	Escape from the menu without saving changes.
OK	Save	Save changes.

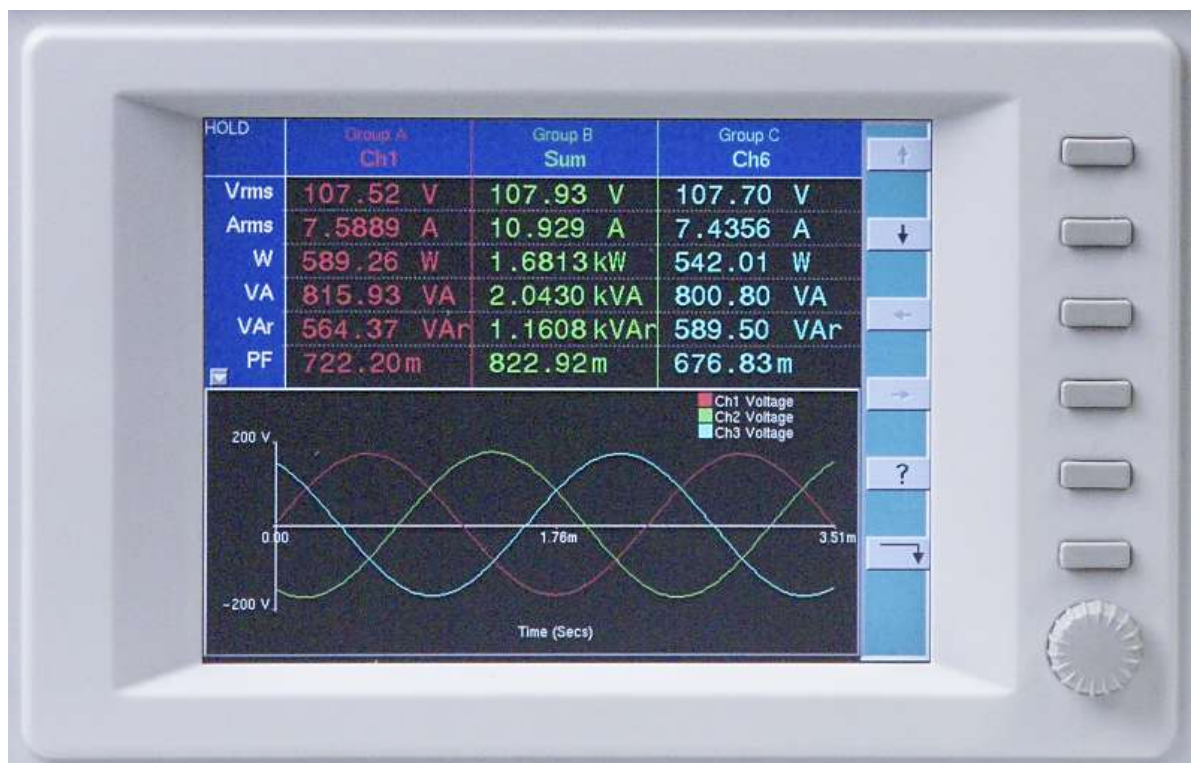

Rotary

The rotary knob is used to scroll up and down through measurements or menu items

2.3. MEASUREMENT DISPLAY

The display may be used to show numerical results, graphics, or both. (See the [GRAPH], [FORMAT] menu for details).

Numerical measurements are organized like a spreadsheet with the measurement channels (and groups of channels) in columns and the measured parameters (e.g. watts, volts, amps) in rows.

	Status	Group A CH1	Group B CH2	Group B CH3	Group B SUM
	Vrms				
	Arms				
	W				
	VA				
	VAr				

Channels →

Measurements ↓

To display further measurement columns, use the left and right keys ← →.

To display further measured parameters, use the up and down keys ↑ ↓.

When no further measurements are available, these keys are shown in gray.

To group channels together to display sum quantities see the [WIRING] menu description.

To hide numeric results columns, see the [FORMAT], [DISPLAY COLUMNS] menu

The Status area is used to show important status indicators such as an over-range (OVR) on a measurement input, or if [HOLD] has been pressed.

2.4. WIRING AND GROUPS

The analyzer uses the concept of groups of measurement channels for many of its functions. By default each channel is assigned to its own group, so Channel 1 is Group A, Channel 2 is Group B, and so on.

For multiphase measurements, a number of channels can be assigned to a group allowing precise frequency and phase analysis of the multiphase signals. The frequency of the first channel in the group is used as the fundamental frequency for all channels in the group, and all phase measurements are relative to the phase reference (Voltage by default) of the first channel in the group.

Channels are assigned to a group by selecting the required wiring configuration from the [WIRING] menu or by remote commands. The appropriate number of adjacent channels will be included in the group.

This should be done before connecting the test leads to avoid confusion when wiring up to the PM6000

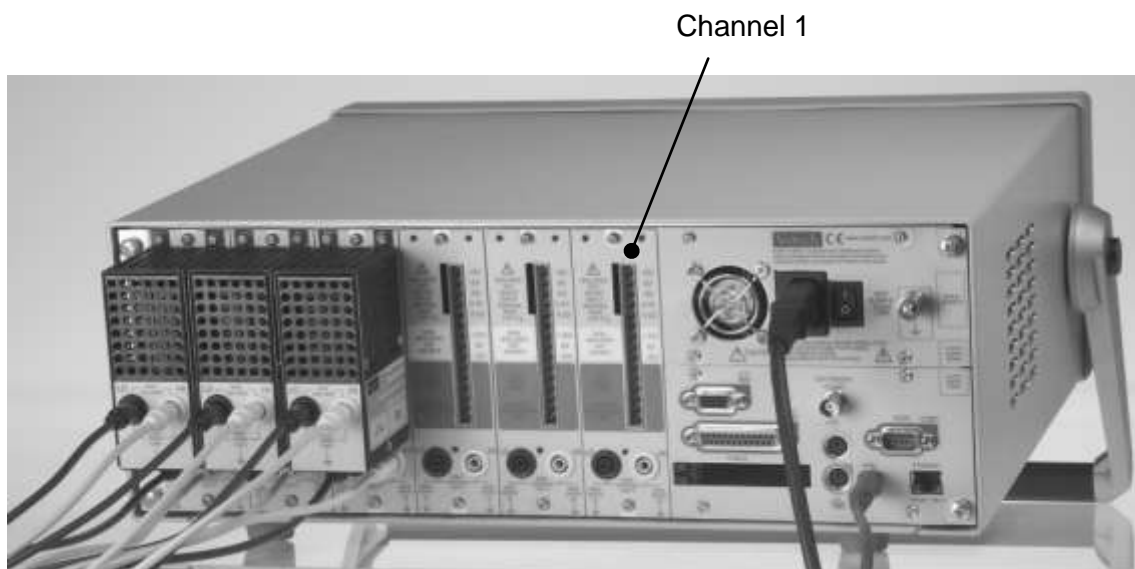

• Figure 1 Rear View of Instrument

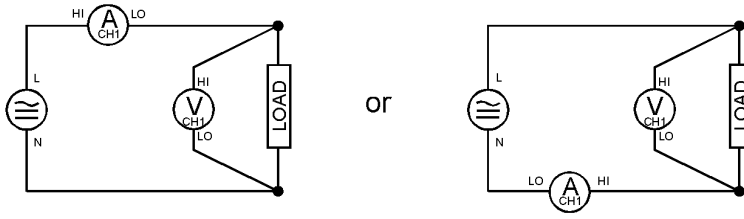

Single-phase, Two wire and DC measurements

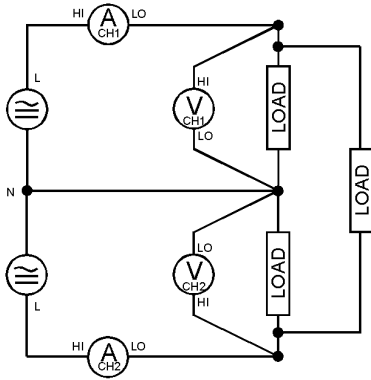

Single-phase, Three wire

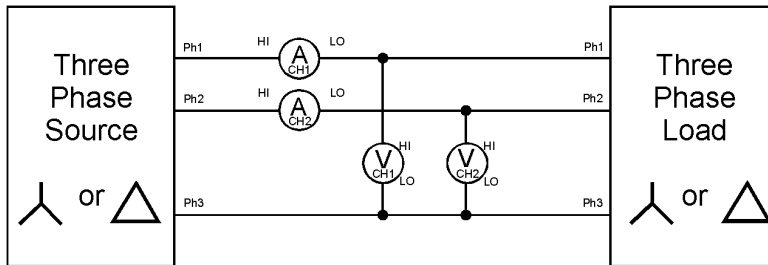

Three-phase, Three wire (2 wattmeter method)

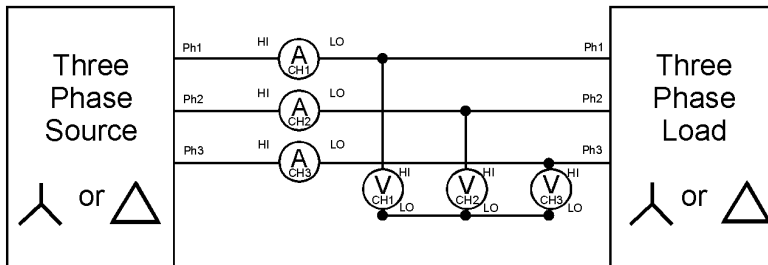

Three-phase, Three wire (3 wattmeter method - Set Analyzer to Three Phase, Four Wire mode)

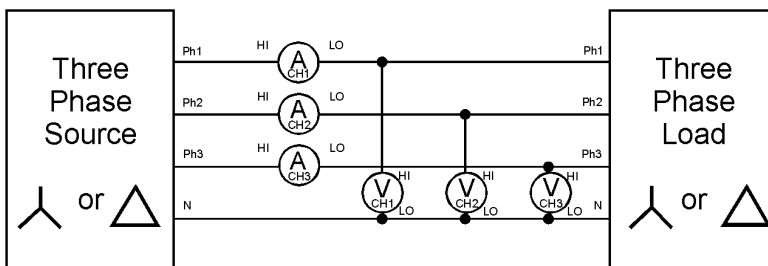

Three-phase, Four wire (3 wattmeter method)

• Figure 2 Common Wiring Configurations

1. In the [WIRING] menu, choose how you wish to group measurements together, if required

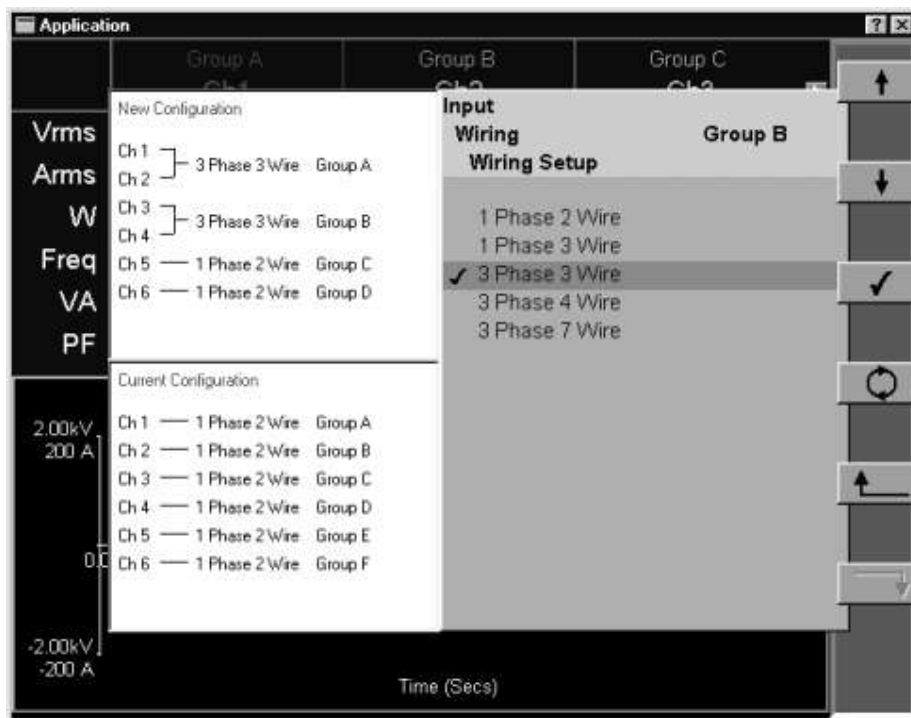

In this example, CH1 and CH2 have been grouped together to measure a 3-phase input, and CH3 and CH4 have been grouped together to simultaneously measure a 3-phase output

2. Choose and set up current and voltage transducers, as required and described below.
3. Then make the physical connections, taking care to observe health and safety regulations.

Each measurement channel has inputs for both voltage and current. The inputs are fully isolated from each other and from ground. The instrument chassis must be Earth grounded at all times

For a discussion of three-phase measurements, see Voltech application note 104-022 'Three-Phase Measurements'.

The three-phase 7-wire configuration may be used to measure total power on distribution systems with center-tapped three-phase transformers. The connection method is similar to the three-phase 4-wire 3-wattmeter method above, with all VLO terminals of the analyzer common and a VHI terminal taken to each of the 6 line wires

2.4.1 Voltage and Current Input Overview

Voltage

Voltages of up to 2000V peak may be connected directly to the black and yellow 4mm safety sockets at the bottom of the channel. A yellow and black lead set is provided with each voltage channel. When connecting the leads, ensure that the end closes to the ferrite bead is connected to the PM6000.

Current

The measurement channel accepts a voltage of up to 2.5Vpk that is proportional to the current being measured. This input allows a very wide range of external current transducers to be connected, from low mA current shunts to MA current transformers. For each type of transducer, the PM6000 may be scaled to read the correct current. See the [SCALING] menu.

Any combination of Voltech shunts or other transducers can be used simultaneously on different channels of the PM6000

The choice of current transducer will depend on:

- The current being measured, including peaks and transients.
- The accuracy required.
- The bandwidth required: Unless the waveforms are purely sinusoidal, a bandwidth in excess of the fundamental frequency will be required.
- Whether there is DC current present.
- Convenience of connection – E.g. using a clamp-on current transformer, with jaws that open, for quick connection in a fixed wiring loom.
- The effect of the transducer on the circuit.

2.4.2 To connect an external resistive shunt:

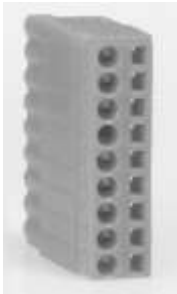

1. Use the plug supplied to make the connections to the measurements channel connections
2. Use good quality shielded twisted pair cable to minimize pick-up

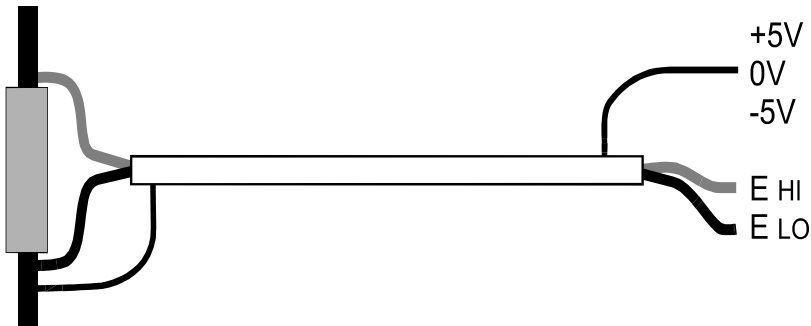

• Figure 3 External Resistive Shunt with Shielded Twisted Pair

3. For optimum rejection of common mode signals, the 0V guard terminal must be used. Connect this to the shield of the twisted pair cable, if available. If there is no shield, connect this directly to the ELO terminal

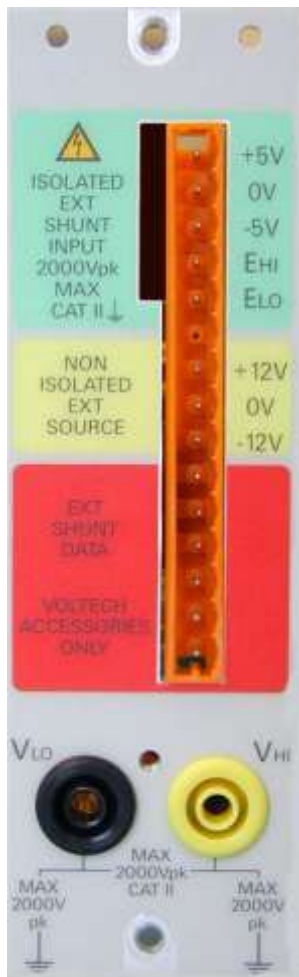

- 0V – Guard terminal
- ± 5V isolated supply at shunt potential
- Voltage input 2.5V pk max.
For current transducers with a voltage output
- ± 12V @ 100mA external transducer supply.
NON ISOLATED 0V at Chassis ground
- DO NOT USE Incorrect use will damage PM6000
- Connections for Voltech accessories only
- Voltage Input V_{HI} , V_{LO}

4. Enter the value in m Ω of the external shunt into the PM6000. See the [SCALING], [External Shunt mV/A] menu. E.G. For a 100m Ω shunt, enter the value 100

2.4.3 To connect a transducer with a voltage output

(E.g. Hall-effect current transformer)

1. Follow the manufacturer's instructions for the safe use and installation of the transducer.
2. Connect the voltage output to the EHI and ELO terminals of the PM6000 channel as above.
3. Connect the 0V guard terminal to 0V on the transducer if one is available. If not, connect the 0V guard to ELO along with the transducer. Use the 0V guard terminal as the 0V return for those transducers that require one.

2.4.4 To connect a transducer with a current output only

To use a conventional current transformer like the Voltech CL series, use a Voltech 1A shunt as described later, and use the [SCALING] [AMPS SCALING] function to enter the ratio of the current transformer. Low level blanking may need to be turned off (see section 3.2.11).

2.4.5 Voltech Shunts

For optimum performance, Voltech provides two resistive shunts which mount directly onto the measurement channels. These shunts include a precision resistive element designed with minimum inductance for maximum high frequency performance. The Voltech shunts:

- Connect directly to a measurement channel without any extra wiring.
- Have a very low effect on the circuit.
- Excellent high frequency performance.
- Automatically recognized by the PM6000 during power on and scaled appropriately.
- Calibration constants are stored within the shunt module and read automatically by the PM6000 for optimum traceable accuracy.
- 4mm safety connectors for direct connection to the circuit or current transducers with a current output (e.g. current transformers). . A yellow and black lead set

is provided with each shunt channel. When connecting the leads, ensure that the end closes to the ferrite bead is connected to the shunt.

- Two models, 30Arms and 1Arms.



Voltech 30A shunt-

No fuse

Voltech 1A shunt –

Fused with a 2.5A HRC Anti-surge 20x5mm fuse

Use a 1A shunt for current transformers with up to 2.5A secondary current











2.5. SUMMARY

Having an appropriate choice of voltage and current transducers and a careful wiring arrangement, the PM6000 can now be set up via its menu system to make a wide variety of power related measurements. For a description of each of the menu options, see the next section.

3. MENU SYSTEM

3.1. NAVIGATION

The PM6000's menu is a powerful yet easy-to-use system for control of the analyzer. See the 'Quick Start' section of this manual for an overview of how to access and use the menu system. The soft-key actions are repeated here for convenience.

	Down Menu	View the details of the selected menu item.
	Up Menu	Go back up the menu system.
	Accept	Accept the choice or save the setting.
	Cancel	Cancel setting, exit without saving.
	Up	Move up or through the menu or measurements.
	Down	Move down through the measurements.
	Rotate	Display the next group or trigger
	Left	Display the measurement column to the left.
	Right	Display the measurement column to the right.
	Help	Switch the help display on or off.
DEL	Delete	Delete one character to the left of the cursor.
CLR	Clear	Clear the current alpha or numeric entry.
ESC	Escape	Escape from the menu without saving changes.
OK	Save	Save changes.

For help at any time whilst using the product:

- Press the [?] soft key at the top level menu.
- Press the [HELP] key at any time

In most situations pressing the [Menu] key is the quick way to exit the menu system

3.2. MENU ITEMS

Pressing the [Menu] key on the front panel or the down menu soft key when measurements are displayed activates the menu.

To clear the display of any menu item, press the [Menu] key again or navigate up through the menu system using the menu up soft key.

The top-level menu items are the same as the groups of keys on the front panel. They are organized into groups of similar functions.

Input	Setup	Display	System	Menus
Wiring	Mode	Measurement	Config	Menu
Range	Integrator	Format	Interface	Help
Coupling	Datalog	Graph	Printing	User
Scaling			Data	Menu 1
Filter			Trigger	Menu 2
Frequency			Self Test	Menu 3
Source				

Other functions

HOLD

RESET / CLEAR

INTEG RUN

DATA DUMP

PRINT

This section describes these menu and submenu functions in order of the buttons in each group.

3.2.1 Wiring

This menu is used to configure the analyzer to reflect the way that the measurement channels are connected to the system under test. For example, three measurement channels may be connected to a three-phase system. Grouping the channels together in this menu simplifies the setup of sum calculations and other settings that can then be applied to the group as a whole.

Wiring Setup

Default: **All 1 Phase 2 Wire**

By configuring the wiring of the analyzer, adjacent measurement channels are grouped together.

To group channels together, start with the first group (Group A), select the wiring setup required (up / down arrow keys).

Move to the next group using the group rotate key and repeat as required.

The example below shows CH1 and CH2 grouped together for a three-phase, three-wire connection and CH3 and CH4 grouped for a similar connection.

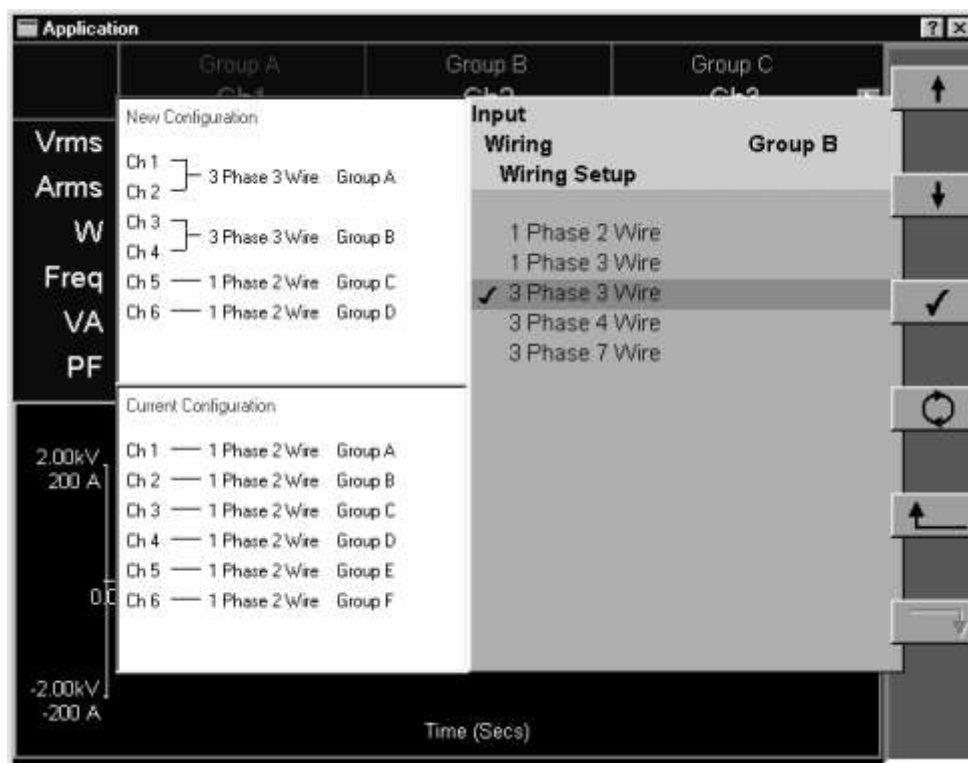

The new configuration is saved upon exiting this menu.

For further information, see our website for technical notes on wiring configurations - 'Three-Phase Measurements' or call your local supplier.

Group Name

Default: **Group A, Group B, etc**

Change the name of the group. The group name may be up to 19 characters long. Permitted characters are those available on the keyboard of the PM6000. The name will be displayed above the grouped channels on the instrument display.

Press OK to save; press ESC to exit without changing the group name.

3.2.2 Range

These settings are applied to groups of measurement channels. Use the group rotate key to set up the next group

The ranges are identified by the peak signal that can be measured. For example, if the volts range is 200V then signals with a peak of $\pm 200V$ can be measured.

Voltech Shunts will be scaled on instrument power up. For other shunts the relevant scaling should be applied using the External Shunt Scaling menu (see 3.2.4)

Range Number	Volts Peak Full Scale	Amps Peak Full Scale		
		No Shunt	Voltech 1A Shunt	Voltech 30A Shunt
1	5	5mV	10mA	500mA
2	10	10mV	20mA	1A
3	20	25mV	50mA	2.5A
4	50	50mV	100mA	5A
5	100	100mV	200mA	10A
6	200	250mV	500mA	25A
7	500	500mV	1A	50A
8	1000	1V	2A	100A
9	2000	2.5V	5A	250A

• Table 1 Volts and Amps Ranges

Volts Range

Amps Range

Default: **Auto**

To adjust the range, select as required from the available displayed ranges and then accept the choice.

Auto allows the instrument to continuously determine the best range to use

Auto Up Only may be used to ensure that the analyzer automatically ranges upwards, but never downwards. This setting may be used in pulsed applications to avoid measurement delays caused by the time taken to auto range upwards during the pulse.

Display Volts Range

The voltage range will be displayed as a measurement item when this is selected.

Display Amps Range

The current range will be displayed as a measurement item when this is selected.

3.2.3 Coupling

Default: **AC+DC**

In **AC+DC** mode, the PM6000 includes DC signals in its analysis.

Select '**AC**' to measure AC signals only. This is useful when attempting to measure the ac characteristics of a signal that are superimposed on a high level of dc. For example, to measure the ac ripple on a dc bus, select '**AC**' only.

In either coupling mode, the analyzer will accept peak voltage or current up to its normal rating. It is therefore safe and accurate to measure small amounts of ac ripple when connected to a 350V dc bus with '**AC**' coupling selected.

3.2.4 Scaling

Scaling is used to adjust the scaled output of transducers such as current transformers such that the true measured current is displayed on the PM6000

Maximum scale factor: 100 000

Minimum scale factor: 0.000 01

Amps Scaling

Default: 1

Enter the scale factor of the transducer being used. For example, the Voltech CL1000 produces 1 amp for every 1000 amps flowing in the opening of the CL. It is a 1000:1 current transformer. Enter the scale factor 1000 and the PM6000 will display the correct current.

Scale factor = Transducer Input Current / Transducer Output Current

Volts Scaling

Default: 1

Enter the scale factor of the transducer. E.g. a 100:1 voltage transformer is used to measure 15kV. The output of the transformer is 15000 / 100 = 150V. Enter the scale factor 100, and the PM6000 will display 15,000 V

External Shunt Scaling mV/A

Default: **12.5 or value for detected Voltech Shunt**

External shunt scaling is automatic when Voltech current shunts are used. Shunt types are detected during power up of the analyzer.

This scaling is applied to the current measurement channel voltage inputs. This is used for current transducers that have a voltage output. These include Hall-effect transducers as well as simple resistive shunts.

Enter the scaling of the chosen transducer. For example a clamp-on Hall-effect current transducer measures up to 100A. It has a voltage output of 10mV per amp. Enter '10' and the PM6000 will display the correct system current.

3.2.5 Filter

Default: **2MHz**

This is the filter applied to all measurements for the group. It defines the measurement bandwidth. Different filter settings may be applied to different groups.

The default setting of 2MHz is suitable for most general applications. The PM6000 always maintains a sample rate sufficient to avoid aliasing problems at any filter setting.

A range of filters is provided to allow the user to optimize the measurement performance. The nominal filter frequency corresponds to the -3dB frequency so allow sufficient bandwidth to include all harmonics of relevance to the measurements with some margin.

As a guideline select a filter of ten times the highest frequency of interest.

Selecting a lower frequency filter will help reduce noise on some measurements or may be useful to eliminate unwanted higher frequency components of low frequency signals.

For settings of 2MHz and below, the signal is analyzed continuously; ensuring no characteristic of the signal is missed.

The 10MHz filter puts the instrument into a 40MSPS burst mode, allowing analysis of signal components up to 10MHz. This mode is only suitable for signals with a fundamental frequency greater than 10 kHz.

Experiment with filter settings to find the most appropriate for each application

3.2.6 Frequency Source

Source

Default: **Volts**

Many measurements (including rms volts, amps and watts) are based on calculations that are dependant on the correct fundamental frequency being determined by the analyzer.

The PM6000 uses proprietary techniques to determine frequency that eliminate the problems created by noise when simple zero-crossing techniques are used.

It is therefore not normally necessary to adjust the settings from the default of voltage.

Volts is the default frequency source and is suitable for most applications.

Amps may be selected if the voltage waveform is heavily distorted, but the current is not. The waveforms at the output of a PWM motor drive are an example of this.

External sets the external input at the back of the PM6000 as the frequency source. Choose this option if the frequency cannot be detected from volts or amps but is available elsewhere. Apply a TTL compatible square wave to the external input at the required frequency.

Fixed Frequency Enter a frequency and this will be used as the fundamental frequency for measurements.

Phase Reference

Default: **Volts**

This is the zero reference for phase angle measurements in each group.

Volts Phase is calculated with respect to the voltage signal on the first channel in the group

Amps Phase is calculated with respect to the current signal on the first channel in the group

Low Frequency

Default: **OFF**

Tick this option if the fundamental frequency is expected to be below 5Hz.

Enter sub menu to specify the frequency

1 - 5Hz - The analyzer will update once per second and a half

< 1Hz - The analyzer will update once every 16 seconds, allowing measurements down to 0.1Hz.

3.2.7 Mode

Default: **Normal**

This menu contains the special application modes of the PM6000. When selected, the analyzer will be automatically set to use the optimum measurement techniques for the waveforms under test

Normal

This is the default operating mode of the analyzer and is ideal for making measurements in most applications. The frequency will be continuously detected (unless fixed) and the graph timebase will be set to show two cycles of the fundamental frequency of the first displayed channel

PWM Output

This mode should be used to analyze the output of electronic motor drives. The output waveform of a PWM drive is a complex mixture of high and low frequency components that can be difficult to accurately assess. In this mode, the data is sampled at high speed but aligned with and over an integral number of cycles of the low frequency motor frequency. The modulation (or motor) frequency is specifically detected every few seconds from the voltage signal.

When performing harmonic analysis of PWM motor signals there are several factors that affect the measurement update rate. The harmonic analysis time increases as the motor frequency decreases. Since the PM6000 will complete the analysis of all requested harmonics before measuring the motor frequency, increasing the maximum harmonic number will make the motor frequency detection less frequent. As such, if the motor frequency is fluctuating significantly or if close tracking of the motor frequency is required, then reduce the maximum harmonic number or turn harmonic results off.

The graph display will attempt to display the modulated waveform for both voltage and current at the motor frequency

See the Voltech Technical Note 86-165 for a more detailed discussion of the application

Minimum Fundamental Frequency

Default: **5Hz**

Set this to allow for the lowest expected fundamental frequency. The instrument will increase the analysis time so that the lowest frequency can be detected. The results update rate will be correspondingly affected.

0.1 Hz

1 Hz

5Hz

HF Ballast (AM)

This mode is ideal for making accurate measurements on AM (amplitude modulated) power signals or signals with fluctuating or unstable frequencies. These waveforms are found at the output of electronic lighting ballasts, ultrasonic supplies for cleaning, medical imaging and radio frequency cutting equipment.

The PM6000 sets the sample time to be an integral number of cycles of the modulation frequency to ensure accurate results.

This frequency can be determined in a number of ways allowing the user significant flexibility

To minimize the effect of modulation on the results, a Harmonic Scaling technique is used. This uses the harmonic analysis to compensate for the effect of the modulation on the harmonic parameters

For more information, see Voltech Application Note 101, part number 98-030

Freq source

Default: **50/60Hz**

This setup parameter allows the user to control how the instrument determines the modulation frequency. This is important for AM signals as the PM6000 will adjust the analysis period to an integer number of complete cycles to ensure accurate results

From Channel

The modulation frequency can be taken from the detected frequency of another channel. This channel must be in Normal mode. Available channels are shown in the selection menu. If the selected channel is unable to detect a valid frequency then the Ballast mode results will show invalid results

50/60Hz

When selected the analysis period is set to 300ms ensuring an integer number of cycles for both 50Hz and 60Hz modulation

Fixed Frequency

If known, the modulation frequency can be entered directly

Harmonic Scaling

Default: **ON**

This provides a correction for the variation of the signal harmonics due to the modulation frequency. This only affects harmonic and THD results

The accuracy of the harmonic results improves with increasing number of harmonics enabled.

It is recommended to set the maximum harmonic number to at least 20

IEC Harmonics

The testing of IEC harmonic to the EN 61000-3-2 standard requires Voltech's IEC Software for the PM6000. Please contact your local Voltech distributor (see www.voltech.com) for further information.

IEC Flicker

The testing of IEC flicker to the EN 61000-3-3 standard requires Voltech's IEC Software for the PM6000. Please contact your local Voltech distributor (see www.voltech.com) for further information.

3.2.8 Integrator

Default: **OFF**

The integrator is used to determine the characteristics of an electrical system over time. For example, a washing machine consumes different amounts of power at different times. The energy rating over an operating cycle can be determined using the integrator.

The PM6000 provides a highly flexible integration system that allows multiple integrations to be configured and run independently.

Enabling the integrator will display rows for the integration parameters and show results for each channel in the integrated group

Integration Parameter	Row Title
RMS Ampere hours	Ahr
RMS Watt hours	Whr
RMS VA hours	VAhr
RMS Reactive VA hours	VARh
Average RMS power	Wav
Average power factor	PFav

Integration time in hours:min:sec	Tint
-----------------------------------	------

• Table 2 Integration Parameters

The integration time is the accumulation of the measurement time and is the time over which the integration and average parameters are calculated

Integration is enabled on a group basis, but is calculated for each channel in the group. Where a group has SUM parameters enabled the integration results will be also be displayed for the summed results

The integration is controlled by either the trigger configuration of keys and system time or by remote commands

Integrate

Default: **OFF**

Select to enable the integrator for the group

Trigger

Default: **Trigger T2**

Each group must be assigned a trigger to determine the start, stop and reset events. Multiple groups can be assigned the same trigger to synchronize the start and stop events.

For the integrator function the trigger events have the following effect

START Start or resume the integration

STOP Stop the integration

RESET Clear the integration parameters to zero

See also the Trigger menu (3.2.17)

3.2.9 Datalog

The data logging functions allow the user to record a series of results to a file on the PM6000. Approximately 6Mbytes of non-volatile flash memory is available to the user, in addition to the floppy drive (if fitted) and the optional internal hard drive.

The data logging is configured in this menu and then started and stopped using the associated Trigger keys or the timed trigger functions

The output file is named and formatted to allow easy importing into common spreadsheet programs. A simple comma separated variable (CSV) format is used throughout

Some thought should be given to the amount of data to be logged, as a fully configured PM6000 is capable of producing vast number of results. Many spreadsheets have a limited number of columns or data file size limit. If generating large datafiles, ensure the spreadsheet application can handle the number of columns and amount of data generated by the datalog output file

In general, the simplest way to configure datalogging is as follows:-

- a. Enable the required results so that they can be viewed on the display
- b. Use Format->Display Columns to disable unused columns
- c. Enable DataLog->Normal datalogging using the tick softkey
- d. Go into the Normal submenus. Only the Log Interval time and File Location should need adjusting (although the output defaults to internal memory which is easily accessed by FTP)
- e. Press the Data Dump key to start and stop the data log

The following DataLog submenus allow the user to customize the data logging configuration

Normal

Default: **OFF**

Configures the data logging of numeric results based on the values displayed on the front panel

When first enabled, a tick will be displayed beside 'Normal' on the menu, and the data-logging configuration will be set to match the measurement configuration of the instrument

Once enabled, the measurement configuration of groups included in the datalog will be partially locked to avoid conflicts. Disable DataLog->Normal to make remove locked menus

It is highly recommended to set up the channels, groups and parameters for the measurements of interest and turn off the display of columns that are not required using the Format – Display Columns menu. This will simplify data-logging configuration

When configuring data logging, please consider the amount of data being generated. With a larger number of channels, parameters and a short interval time, very large files can be produced. In particular, ensure that unused channels and harmonic results are removed from the datalog configuration to keep files small

Whilst a data log is running, the data log configuration menus are locked and are shown grayed out. The menus can still be navigated to view the configuration

Channels/Groups/Sum

Default: **As Format-Display Columns menu**

Select which display columns will become output rows in the datalog file. A row will be added to the data log file every log point for each display column selected

Parameters

Default: **Based on Measurements setup for all channels**

Determines which parameters will form the columns of the datalog file. Headings for the columns will be based on the selections in this menu. Where channels are not configured to provide a measurement parameter result, a blank field will be inserted in the data log file to ensure data is aligned to the parameter header.

Enabling a parameter here will not enable the measurement on the channels. To do this use the Measure menu and configure the group measurements as required

Log Interval Time

Default: **0 (Continuous)**

Whilst the data logging is running, the Log Interval Time determines the time period between sets of results being written to the output file. If this value is zero or below the actual measurement update rate, then results will be written out as soon as available. The typical update rate is about a third of a second.

The interval time unit is hours. However, minutes can easily be added by entering “:” (colon) and then the number of minutes. For example, to log results every six minutes, the following are both valid

0:6

or

0.1

The minimum interval, other than 0, is 2 seconds or 0.000556 Hours and can be increased in 1 second intervals. 2 seconds can be entered as either 0.000556 Hours or 0:0.033.

Trigger

Default: **T1**

The data logging will only start when a START trigger event is received. This setting specifies which trigger is used to start and stop the data logging. Only the START and STOP events apply to data logging; the other

trigger events (such as Reset, etc) are ignored. See 3.2.17 for more on Triggers

File Location

Default: **Memory**

This menu determines the location of the output file. Select the media and directory (if any) to create the data log file in. A tick will appear beside the selected directory

The file will be named using a timestamp format to ensure uniqueness as follows

YYYYMMDDhhmmss.CSV

Where YYYY is the year

MM is the month

DD is the day of month

hh is hours

mm is minutes

ss is seconds

The Memory option is available on all PM6000 instruments and provides approximately 6Mbytes of non-volatile file storage. PM6000 instruments can also be fitted with an optional PC Compatible floppy disk drive with a formatted capacity of 1.44Mbytes. This can be the simplest means of transferring files to a PC. The optional internal hard disk drive provides large capacity storage.

Once the data log file is completed, it can be moved around using the [Data] menu, see 3.2.16 or by means of FTP transfer through a network connection, see section 5.1 in the Remote Access section

3.2.10 Measurement

Select the results to display in the selected group

Use the up / down arrow soft-keys to highlight the choice and enable or disable the measurement using the key.

Note that to remove a parameter row from the display, the parameter must be disabled in all groups

For most parameters simply enable the parameter in the list. However some parameters require further explanation or configuration and these are covered below

Sum

Default: **OFF**

Display sum quantities for the group of channels. This is only available for groups with multiple channels. An additional column is displayed to the right of the group showing the calculated multiphase sum results for relevant parameters

Harmonics

Default: **OFF**

Enables or disables the harmonic analysis parameters. The sub menus allow the harmonic components of volts, amps or watts to be configured

Watts Harmonics

Default: **ON** (overridden by top level harmonic enable)

The magnitude of the Watts harmonics selected are displayed in new rows for the selected group

Min

Default: **1**

The lowest harmonic to display

Max

Default: **7**

The highest harmonic to display

ODD and EVEN**ODD Only**

Default: **ODD and EVEN**

Determines which harmonics are calculated. Only one of these can be selected as shown by the tick

Volts Harmonics

The magnitude and phase of the Volts harmonics selected are displayed in new rows for the selected group. The second and higher harmonic magnitudes are usually displayed as a percentage of the first harmonic.

Phase angles are referenced to the group phase reference

The sub menu is as for **Watts Harmonics**

Amps Harmonics

As **Volts Harmonics**

Phase

Default: **0 to 360**

Choose the convention used to display the phase angle. Phase angles may be displayed as 0 to 360 degrees or -180 to 180 degrees

Volts Distortion

Enables or disables the Volts Distortions measurement by using the select key.

NOTE: Harmonics must be enabled. See section above for information on enabling harmonics. Also, harmonics must be displayed as absolute values, not percentages. This setting can be changed in the format menu (3.2.11). Also, when change a distortion measurement selected, you must first remove the tick next to the currently selected measurement, and then select the distortion measurement you want. You will then need to ensure that the voltage or current distortion is still selected in the measurement menu.

Default: **Volts Distortion Factor**

By default, no distortion measurement is displayed. If no measurement is selected in the sub menus, then it is not possible to select distortion factor at the top level.

Volts Distortion Factor

Default Reference: **RMS**

Formula:

$$Vdf = \frac{1}{V_{ref}} \sqrt{V_{rms}^2 - V_{h_{01}}^2} \times 100\%$$

The number of harmonics used in the calculations is taken from the Volts Harmonics menu settings.

The Distortion Factor calculation (previously called the Difference Formula) includes the effects of high frequency and noise. This equation only produces a valid number if the RMS is not less than the fundamental. If the fundamental is larger than the RMS the display shows '----'.

Volts THD

THD (Total Harmonic Distortion) is a measure of the distortion of a waveform.

Default Reference: **Fundamental**

Formula:

$$V_{thd} = \frac{1}{V_{ref}} \sqrt{\sum_{\min harm}^{\max harm} k_n^2 \times V_{h_n}^2} \times 100\%$$

The maximum number of harmonics used in the calculations is taken from the Volts Harmonics menu settings. The minimum is always 2.

The THD formula (previously called the Series Formula) will produce more accurate measurement of distortion for harmonic noise when the THD is less than 5%. When selecting the THD formula, it is important to set the MAX HARMONICS setting to an appropriately large number to get valid results. The higher the harmonic count the more accurate the calculation.

Volts TIF

TIF stands for telephone influence factor and is a THD measurement weighted at frequencies within the bandwidth of a normal telephone circuit. It is a measure of the how the voltage or current distortion in electrical power circuits might interfere with adjacent telephone circuits. TIF measurements are a requirement of standards such as ANSI C50.13 "Rotating Electrical Machinery - Cylindrical-Rotor Synchronous Generators" and are most often used on standby power generators and UPS.

The harmonics included in a TIF measurement should be from 1 to 73 odd and even.

Default Vref: **Vrms**

Formula:

$$V_{tif} = \frac{1}{V_{ref}} \sqrt{\sum_{\min harm}^{\max harm} k_n^2 \times V_{h_n}^2}$$

The number of harmonics used in the calculations is taken from the Volts Harmonics menu settings.

TIF Weighting Factors

Harm	k _n	Harm	k _n	Harm	k _n
1	0.5	21	6050	41	10340

3	30	23	6370	43	10600
5	225	24	6650	47	10210
6	400	25	6680	49	9820
7	650	27	6970	50	9670
9	1320	29	7320	53	8740
11	2260	30	7570	55	8090
12	2760	31	7820	59	6730
13	3360	33	8830	61	6130
15	4350	35	8830	65	4400
17	5100	36	9080	67	3700
18	5400	37	9330	71	2750
19	5630	39	9840	73	2190

The weighting factor for harmonics over 73 and for harmonics not included in the table shall be 0.

Amps Distortion

Enables or disables the Amps Distortions measurement by using the select key.

Default: **Amps Distortion Factor**

By default, no distortion measurement is displayed. If no measurement is selected of the sub menus, then it is not possible to select distortion factor at the top level.

Amps Distortion Factor

Default Reference: **RMS**

Formula:

$$Adf = \frac{1}{A_{ref}} \sqrt{Arms^2 - Ah_{01}^2} \times 100\%$$

The Distortion Factor formula (previously called the Difference Formula) includes the effects of high frequency and noise. This equation only produces a valid number if the RMS is not less than the fundamental. If the fundamental is larger than the RMS the display shows '----'

Amps THD

THD (Total Harmonic Distortion) is a measure of the distortion of a waveform.

Default Reference: **Fundamental**

Formula:

$$A_{thd} = \frac{1}{A_{ref}} \sqrt{\sum_{\min harm}^{\max harm} k_n^2 \times A_{h_n}^2} \times 100\%$$

The maximum number of harmonics used in the calculations is taken from the Amps Harmonics menu settings. The minimum is always 2.

The Total Harmonic Distortion formula (previously called the series formula) will produce more accurate results for harmonic noise when the THD is less than 5%. When selecting the THD formula, it is important to set the MAX HARMONICS setting to an appropriately large number to get valid results. The higher the harmonic count the more accurate the calculation.

Amps TIF

TIF stands for telephone influence factor and is a THD measurement weighted at frequencies within the bandwidth of a normal telephone circuit. It is a measure of the how the voltage or current distortion in electrical power circuits might interfere with adjacent telephone circuits. TIF measurements are a requirement of standards such as ANSI C50.13 "Rotating Electrical Machinery - Cylindrical-Rotor Synchronous Generators" and are most often used on standby power generators and UPS.

The harmonics included in a TIF measurement should be from 1 to 73 odd and even.

Default Aref: **Arms**

Formula:

$$A_{tif} = \frac{1}{A_{ref}} \sqrt{\sum_{\min harm}^{\max harm} k_n^2 \times A_{h_n}^2}$$

The number of harmonics used in the calculations is taken from the Amps Harmonics menu settings.

TIF Weighting Factors

Harm	k _n	Harm	k _n	Harm	k _n
1	0.5	21	6050	41	10340

3	30	23	6370	43	10600
5	225	24	6650	47	10210
6	400	25	6680	49	9820
7	650	27	6970	50	9670
9	1320	29	7320	53	8740
11	2260	30	7570	55	8090
12	2760	31	7820	59	6730
13	3360	33	8830	61	6130
15	4350	35	8830	65	4400
17	5100	36	9080	67	3700
18	5400	37	9330	71	2750
19	5630	39	9840	73	2190

The weighting factor for harmonics over 73 and for harmonics not included in the table shall be 0.

Volts Peak and Amps Peak

(Updated on version 1.12.05 of the firmware)

On previous products, the Volts peak and the Amps peak readings return the absolute maximum reading due the measurement period. This reading can be either positive or negative. In most applications, this is still the value required.

In applications where there is an AC signal superimposed on a DC level, it can be useful to know the positive or high peak and the negative or low peak. The positive peak is the most positive value recorded, while the negative peak is the most negative value recorded.

For example, if there is a 1VDC signal with a 4Vp-p AC waveform on top of it, then the positive peak would be +3V and the negative peak would be -1V. The absolute peak would be +3V. However, if the DC level was changed to +4V, then the positive peak would be +6V and the negative peak would be +2V.

For both voltage and current, the absolute, the positive and the negative peaks can be displayed.

MAX / MIN Hold

Select MAX Hold and / or MIN Hold as required. The maximum and / or minimum measurement is displayed in a new column adjacent to the relevant results column. Any averaging is applied to the channel results prior to comparing with the MIN/MAX Hold values, so the Averaging Depth should be considered when configuring a measurement. To detect fast or transient values set the averaging depth to 1.

The [RESET / CLEAR] key is pressed to reset the held measurements.

For harmonic results the MIN/MAX result is determined by the magnitude component of the complex harmonic result. The reported MIN/MAX angle is the angle of the complex harmonic result that set the MIN/MAX magnitude, and as such it will not necessarily be the MIN/MAX angle.

For example, to measure the inrush current (the current drawn at switch-on) of a power supply

- Select Apk, MIN HOLD and MAX HOLD from the measurement list
- Then, in the [RANGE] menu, select 'Auto Up Only'
- Set the averaging to 1. (See the [Format] > [Averaging] menu below).
- Now switch on the supply to the load and the peak inrush current will be displayed
- Repeat the measurement to capture the worst case current, since the peak current will vary with the point in the voltage cycle at which the supply is connected

See also

- Voltech PS1000 Inrush Switch data sheet. (This accessory greatly simplifies inrush testing).

3.2.11 Format

This menu is used to set the general display features

Zoom

Zoom may be 1, 2 or 3 columns. Zoom 1 displays one column only. The display fonts are scaled automatically. 1 = largest font.

Averaging

This menu configures how the instrument averages results. Results are returned from the measurement channels typically every 300ms unless in a low frequency mode. For an averaging depth of 16, it will take approximately 5 seconds to report a fully averaged result. Increasing the averaging depth will reduce noise on the result, at the cost of time.

Auto

Default: ON

Auto averaging means that the analyzer will automatically reset the averaging queue if a significant change of signal is detected. This produces the fastest response to changes for measurements of the steady state value

Fixed

Default: OFF

The fixed mode stops the averaging queue from being automatically reset. Use this to average a signal that will significantly change.

Depth

Default: 16

The averaging depth is the number of readings used to return the displayed result. It may be set to any value from 1 to 64.

Display Columns

This menu may be used to enable and disable the display of columns. This is most useful when for example, it is important to view sum columns side by side. This setting is also used to determine the printed columns (see Print section 3.2.27) and the columns used for data logging (see DataLog section 3.2.9)

Math

This menu provides access to the formula editor of the PM6000.

Any combination of parameters may be used and manipulated to provide a new measurement. An example of this the calculation of efficiency based on different watts measurements. The new math measurements are shown in a new 'math' column on the display.

Before starting to enter equations, ensure all relevant parameters are selected using the Measurements menu. If you use a parameter that is not selected, then an error message will appear, and you will be prompted as to whether you would like to enable the unselected parameters that you have used in the formula. Conversely, if you deselect a parameter in the Measurements Menu, then a warning will be displayed says that that the parameter you are deselecting is used in a math function. At this point you will be able to cancel the deselection. If you do not cancel the deselection, then the rows in which that parameter is used will display "----".

To enter and display a math measurement, choose a function (e.g. Math Fn1) and then press the Down Menu soft-key ().

To change the name of the Math function as it appears on the screen, select the Edit Name option. Up to 4 characters may be entered. Those characters may be numeric, operators, or measurements that are currently available on the display. Numeric characters are the numbers 0 to 9 plus the decimal point with up to 6 significant figures.

To enter a formula, select the Edit Function option. A dialog entry box will appear into which you enter a formula. The formula entered must be consistent with the following rules:

1. Valid character are A-Z, a-z, 0-9, (,), [,], +, -, *, /, ^, :, and _.
2. No more than 255 characters can be used.
3. The number format is [+/-]<decimal digits> [E[+/-]exponent]
4. The valid channel parameters are CH<1-6> followed by ":" and then one of the following parameters:

VRMS	Volts RMS	ARMS	Amps RMS
W	Watts	FREQ	Frequency
VA	Volt-Amps	VAR	Volt-Amps Reactive
VDC	Volts DC	ADC	Amps DC
VRMN	Rectified Mean Volts	ARMN	Rectified Mean Amps
PF	Power Factor	VPK	Volts Peak (absolute)
VPKP	Volts Peak (positive)	VPKN	Volts Peak (negative)
APK	Amps Peak (absolute)	APKP	Amps Peak (positive)
APKN	Amps Peak (negative)	VCF	Volts Crest Factor
ACF	Amps Crest Factor	Z	Impedance
WF	Fundamental Watts	VARF	Fundamental Volt-Amps Reactive
VF	Fundamental Volts	AF	Fundamental Amps
PFF	Fundamental Power Factor	R	Resistance
X	Reactance	VDF	Voltage Distortion Factor
VTHD	Voltage Total Harmonic Distortion	VTIF	Voltage Telephone Influence Factor
ADF	Current Distortion Factor	ATHD	Current Total Harmonic Distortion
ATIF	Current Telephone Influence Factor	VHM<1-99>	Voltage Harmonic Magnitude (1-99)
VHA<1-99>	Voltage Harmonic Angle (1-99)	AHM<1-99>	Current Harmonic Magnitude (1-99)
AHA<1-99>	Current Harmonic Angle (1-99)	WHM<1-99>	Watts Harmonic Magnitude (1-99)
VRNG	Voltage Range	ARNG	Current Range
AHR	Ampere Hours	WHR	Watt Hours

VAHR	VA Hours	VARH	VAr Hours
WAV	Watts Average	PFAV	PF average
TINT	Integration Time		

5. The valid group parameters are GRP<A-F> followed by ":SUM:" and then one of the following parameters:

VRMS	Volts RMS	ARMS	Amps RMS
W	Watts	VA	Volt-Amps
VAR	Volt-Amps Reactive	PF	Power Factor
AHR	Ampere Hours	WHR	Watt Hours
VAHR	VA Hours	VARH	VAr Hours
WAV	Watts Average	PFAV	PF average
TINT	Integration Time	WF	Fundamental Watts
VF	Fundamental Volts	AF	Fundamental Amps
VARF	Fundamental Volt-Amps Reactive	PFF	Fundamental Power Factor

6. Operators available from the front panel keyboard are:

+ - x / () []

X² {shown as ^2 and will square the preceding number}

10^x {shown as x10^ and will multiply the preceding number by 10 to the power of the following number}

X^y {shown as ^ and will take the preceding number to the power of the following number}

E^x {shown as *e^ and will multiply the preceding number by e to the power of the following number}

√ {shown as SQRT() and will take the square root of the number between the brackets}

7. Operators that may be typed:

SIN(), COS(), TAN() {which take an angle in degrees which is between the brackets and return its sine, cosine or tangent}

ASIN(), ACOS() {which take a number between -1 and 1 which is between the brackets and return an angle in degrees}

ATAN() {which takes a number that is between the brackets and return an angle in degrees}

LN(), **LOG()** {which returns the logarithm of the number between the brackets. LN is log to the base e, LOG is log to the base 10}

8.Constants that may be typed:

PI() (3.14159)

Some examples are:

1. CH1:VRMS (returns the channel 1 RMS volts)
2. CH1:VRMS * SQRT(3) (returns the channel 1 RMS volts * root 3)olts
3. CH1:VRMS * CH1:ARMS (returns the channel rms V * rms A)
4. GRPA:SUM:VRMS (returns the group A sum rms Voltage)

The formula will be checked for validity only when OK is selected. If there is an error, then an error message will be displayed. If there are no errors then a dialog box will be displayed showing the calculated value.

If the math result is invalid (e.g. infinity because of a divide by zero) the display will show 4 dashes.

Blanking

Default: **ON**

When blanking is enabled the analyzer displays '0' when the measurement is less than 5% of range. When disabled results will be displayed down to the displayed resolution, which may be measurement noise

Grid

Default: **ON**

Toggles the display of the grid for measurements

Harmonic Results as Percent

Default: **ON**

When enabled magnitude results for all harmonics other than the fundamental will be displayed as a percentage of the fundamental.

When disabled each harmonic magnitude will be displayed in the normal units of V, A or W

3.2.12 Graph

This menu is used to control the display of waveforms and other graphics.

View

Default: **Split**

The view of the graph may be split screen (half screen), full screen or removed from the display

Format

Waveform

Items

Default: **CH1:V and CH1:A**

Choose the items to display as a waveform.

The graph time base will be determined by the frequency of the first item displayed

Up to 6 may be shown at one time.

3.2.13 Config

Load

This menu provides the functionality that enables users to load a previously saved configuration. For information on how to save the configuration, please see Save below.

Ten quick access configurations are listed on this menu. Users can load the configuration from any of the ten positions if there is a configuration exists. When one of the items selected, the system settings will be restored to the configuration selected.

The File Location menu shows the configuration files that exist on the file systems (Memory, Floppy Drive (if fitted) and Hard Drive (optional)). After selecting one of the files, the configuration in that file will be loaded into system, all the system settings will be updated.

A tick will appear besides the current system configuration item or file and the directories where the file locates in, to indicate the location of the current system settings.

Save

The PM6000 provides two ways of storing user configurations; 10 user configurations and File Location. The Save menu provides the functionality that enables users to save how they have set up the PM6000. The ten quick access configurations are listed on this menu as well as the File Location option.

10 user configurations

Users can save their current system configuration in any of the ten positions. When one of the item is selected, a dialog window will pop up ask for a user-friendly name for the configuration. The last used configuration name displays in the edit box as a default text. All settings will be stored when a configuration is saved. These ten positions can be reused to save different configurations.

File Location

Alternatively, the File Location option allows the user to save the configuration into files on any of the three media (Memory, Floppy Drive (if fitted) and Hard Drive (optional)). Select the media and directory (if any) to save the configuration files in. Select 'Add a new file...' in any of the directories and a dialog window will pop up ask for a meaningful name for the configuration to be saved. After pressing the OK soft key, a file name will be produced automatically, which will be the configuration name with the '.p6c' extension and all the space character will be replaced with '_' character.

Once the configuration file is saved, it can be moved around using the [Data] menu (see section 3.2.16) or by means of FTP transfer through a network connection (see section 5.2).

Reset Default

Returns the PM6000 to default settings, with the exception of interface configuration

View Settings

Displays the settings for each group of the PM6000

View Hardware

Displays the type, serial numbers and calibration status of the PM6000's hardware. The firmware version of the PM6000 is also shown. It is important to provide the information displayed here when reporting application queries

Config Clock

Set the date and time for the PM6000's internal clock that is displayed in the bottom right corner of the screen.

When prompted to enter dates or times, the keypad will be put into character mode to allow entry of letters and numbers.

Note that to avoid confusion of date format, the month should be entered as the first three letters of the month. E.G. AUG for August

A colon ':' is used between time and date elements, and this is on the [PRINT] key beside the [SHIFT] key.

Date format: **dd:mmm:yy** (mmm are letters)

Time format: **hh:mm** (24h clock)

Config Zero

This menu may be used to cancel the effects of small amounts of DC offset in the measuring circuits

Auto Zero

Default: **ON**

The PM6000 will automatically measure internal zero offsets and cancel them. This process is repeated automatically every minute to ensure the best possible measuring performance. It will however cause a short pause in measurements whilst the zeroing process is performed. If this interruption causes a problem, select OFF for the duration of the measurement.

Config Beeper

The internal beeper of the PM6000 may be used to emphasize important key actions and warnings. If operator safety or damage to the analyzer is possible, the ON / OF setting of the beeper is ignore

On/Off

Default: **ON**

Switch the beeper on or off

Volume

Default: **3**

Adjust the beeper volume. 1= Min. 4 = Max.

System Upgrade

The 'System Upgrade' menu function restarts the PM6000 in a special maintenance mode needed to allow the upgrade application to install the new files.

See section 9.4 for further information on upgrading the firmware in a PM6000.

3.2.14 Interface

This menu is used to configure the control interfaces of the PM6000

Serial

RS232

The RS232 port is a standard PC type 9 way male D-type located on the rear of the instrument and may be used for remote control of the PM6000. A null modem cable should be used.

The RS232 port uses 8 bit, no parity, one stop bit and hardware flow control.

Baud Rate

Default: **9600**

The baud rate must be matched to the host controller baud rate. An instrument reset does NOT affect this setting. However, the firmware upgrade may return this to the default.

Options

Echo

Default: **ON**

This setting determines if the PM6000 should echo all received characters back to the host. This is the most useful setting for simple remote commands through a terminal emulator. For more complex remote programming, it is advisable to disable this. This can be done via the remote command CFG 275.

Ethernet

The PM6000 may be connected to a network for transferring data files and for maintenance activities such as firmware upgrade.

In order to transfer files with the PM6000, the network connection must be established using the settings described below. Once a valid IP address is obtained or set, an FTP (File Transfer Protocol) connection can be made to the PM6000, giving access to the

user data areas of the PM6000 file system. See Section 5.2 for more information on using FTP.

Set IP using DHCP

Default: **ON**

Dynamic Host Configuration Protocol (DHCP) is a standard TCP/IP protocol designed to reduce the complexity of administering address configurations by using a server computer to centrally manage Internet Protocol (IP) addresses and other related configuration details on a network

When the PM6000 is connected to a network with a DHCP server then the PM6000 can determine its network settings automatically. It does this during the power up sequence or when this menu item is selected. If no IP address is shown in the View Settings dialog then repeat the selection of Set IP using DHCP soft key to repeat the attempt to acquire network settings.

This is the recommended setting for simplest use of an Ethernet network

Fix IP Address

If unable to configure the network settings by DHCP, then these menus provide a way to enter an IP address, Subnet Mask and Default Gateway address. Contact your network administrator for the appropriate settings

View Settings

Displays the network settings. This provides confirmation of the current settings

Parallel

This is a standard Centronics interface dedicated to printing and has no user configuration.

PCMCIA

See section 6.2 (PCMCIA Cards) for more information on using this interface.

3.2.15 Printing

There are currently no user specified parameters for printing. See the [Print] key

3.2.16 Data

This menu provides access to the user file system on the PM6000

It displays the available storage media and allows the user to organize files including creating and moving between directories. It also allows moving files between media such as floppy drive (if fitted) and hard drive (grayed out if not fitted). A PC keyboard may be attached to allow simpler entry of file or folder names

The soft keys are used to navigate and manage the file systems. In addition to the standard soft keys, the following will be seen

More

Changes the soft keys to show other functions. Press again to cycle through options

Delete

Deletes the currently selected file or directory

Rename

Changes the name of the selected file or directory

Copy

Starts the process of copying the selected file or directory. After pressing the key, navigate to the destination directory and press **Paste**

Paste

Completes the copy process. The user is prompted for the new file or folder name. A prompt will be shown confirming to copy process is complete

New Dir

Creates a new directory/folder in the current directory

Configure

Format Floppy Disk

If the floppy drive is fitted and a disk is present, this provides the facility to format a floppy disk. This will destroy all contents of the disk. The format is PC compatible allowing easy transfer between PM6000 and PC

3.2.17 Trigger

Six trigger configurations (T1 to T6) are available which may be set up in separate ways such that different events trigger different actions. Trigger events may be front panel keys, time based or remote controlled

This menu is used to configure triggers. Use the 'cycle' soft key to select the trigger to configure. To associate a trigger with a particular function, select the trigger in the relevant function menu

The default trigger configurations will be suitable for most measurements. For example the Trigger T2 is primarily for use with the Integrator function and is defined as follows:-

Trigger T2

Start	–	[Integ Run]
Stop	–	[Integ Run]
Pause	–	[Hold] (Not used by the Integrator function)
Reset	–	[Reset / Clear]

Trigger T1 to T6

Each trigger action may be allocated to an event, such as a key press or time.

To set up the trigger T1 to T6, first select the action (e.g. start or stop) that you want the trigger to perform, and then allocate the event (e.g. key press) that will cause the trigger to act

Trigger actions are

Start

Stop

Pause

Reset

Timed

Keys that can be allocated are:

[Data Dump]

[Integ Run]

[Print]

[Enter]

[Reset / Clear]

[Hold]

Trigger T1 to T6 Timed

The triggers can be set up to start and stop at a particular date and time, and to trigger at a particular interval. When prompted to enter dates or times, the keypad will be put into character mode to allow entry of letters and numbers.

A start time and date as well as an end time and date need to be entered. Each value is entered separately. The end time and date must be after the start time and date for the trigger to run, but the PM6000 will let you enter an end date and time that are before the start date and time in order allow for one date being entered before another.

Note that to avoid confusion of date format, the month should be entered as the first three letters of the month. E.g. AUG for August.

A colon ':' is used between time and date elements, and this is on the [PRINT] key beside the [SHIFT] key. Interval time can be entered in several formats and will be converted to a decimal number of hours (Interval used only for DataLog functions)

Date format: dd:mmm:yy

Time format: hh:mm (24h clock)

Interval format: hh:mm:ss or decimal hours

The minimum interval is 2 seconds or 0.000556 Hours and can be increased in 1 second intervals. 2 seconds can be entered as either 0.000556 Hours or 0:0.033.

3.2.18 Self Test

It is not normally necessary for the user to perform any self-tests on the PM6000. However, you may be asked to perform some of them in response to an application or service enquiry. Several of the tests require specific external equipment and so tests should not be attempted unless instructed to do so. However none of the self-tests will damage or adversely affect the instrument.

Instructions for carrying out each test are displayed whenever that test is selected.

Should any of the tests fail, please ensure that the instructions displayed have been carried out carefully before contacting your supplier for advice.

3.2.19 Menu

If no menu displayed, then the [MENU] key displays the top-level menu providing an alternative access to all the menu items in this section.

The [MENU] key also acts as a way to remove the menus from the display

3.2.20 Help

This is the home page of the help system.

To switch the display of help ON or OFF, press the [HELP] key

3.2.21 User

This is for future development

3.2.22 Menu 1, 2, 3

The [Menu 1], [Menu 2] and [Menu 3] keys may be used to store and recall your own menu short cuts.

If there is a particular menu that you wish to return to frequently, navigate to that menu and then press and hold the Menu 1, 2, or 3 key for more than 1 second.

Next time that you press the Menu 1, 2, or 3 key for less than 1 second you will be taken directly to the stored menu short cut.

3.2.23 HOLD

This programmable key may be used to initiate a trigger. (See the trigger overview)

Press this key to freeze the display. This is useful when you wish to examine different measurements that were taken at exactly the same time. When the [HOLD] key is pressed 'HOLD' is displayed in the top right corner of the screen, all measurements are frozen and the screen can be scrolled to view all the measurements that were taken at the time the [HOLD] key was pressed.

Press the [HOLD] key again to update the display

3.2.24 RESET / CLEAR

This programmable key may be used to initiate a trigger. (See the trigger overview)

By default, [RESET / CLEAR] will clear stored MAX / MIN values and integrator measurements.

This key will always cause the measurement sample to be restarted. This can be useful when making low frequency (<10Hz) measurements with long sample times.

There can be a short delay of several seconds whilst the instrument functions are restarted

3.2.25 INTEG RUN

This programmable key may be used to initiate a trigger. (See the trigger overview)

By default, the [INTEG RUN] key is used to start and stop the integrator.

3.2.26 DATA DUMP

This programmable key may be used to initiate a trigger. This is typically assigned to the Data Log function, but may be used by any triggered process. (See the trigger overview)

3.2.27 PRINT

This programmable key may be used to initiate a trigger. (See the trigger overview)

By default, the [PRINT] key is used to start printing. When pressed, the LED will briefly flash as the data is formatted and sent to the printer driver for printing.

The PM6000 supports ASCII/ MSDOS compatible printers connected to the parallel port using a standard PC Parallel printer cable. The printout is formatted for 80-character page width, and so a printer with at least 80 character width will produce best results

Results for all currently enabled parameters and channels will be printed, along with instrument information, time and date.

Columns can be disabled or enabled for printing using the Display Columns menu (see Format section 3.2.11)

4. REMOTE OPERATION

4.1. OVERVIEW

Using the remote commands the PM6000 can be used to perform high speed, complex or repetitive measurements. Many of the PM3000 commands are supported although the increased flexibility of the 6-channel PM6000 design brings the new concept of multiple groups of channels.

Many of the functions apply to the currently selected group of channels. By default, each measurement card is grouped individually. Read the section on Wiring for further discussion on groups.

4.2. INTERFACING WITH GPIB SYSTEMS

The PM6000 remote commands are compatible with IEEE488.2. However a hardware GPIB interface is not provided. Commercially available GPIB to RS232 converters can be used to provide connection to GPIB control systems. One example is the National Instruments GPIB-232CV-A that has been reliably used with the PM6000 at 38400 baud. Refer to the National Instruments documentation for more details.

4.3. INTERFACING WITH RS232 SYSTEMS

The RS232 port is a standard PC type 9 way male D-type located on the rear of the instrument and may be used for remote control of the PM6000. A null modem cable should be used.

The RS232 port uses 8 bit, no parity, one stop bit and hardware flow control.

See section 8.4.1 for a detailed pin description of the RS232 connector.

See section 3.2.14 for details on the interface menus.

NOTE: To avoid any communications problems, a delay of 200mS should be included between each command sent to the PM6000.

4.4. INTERFACING WITH ETHERNET SYSTEMS

You can remote control your PM6000 through Ethernet port by using the Microsoft Telnet Client.

- On Windows XP, click Start > Run and type `telnet xxx.xxx.xxx.xxx` where

- xxx.xxx.xxx.xxx is the IP address of the PM6000. (see section 3.2.14 on how to obtain the Ethernet IP address).
- At the login: prompt type:
pm6coms
- You should see a response from the instrument, such as:

```
Welcome to Voltech PM6000 Power Analyzer  
PM6000>
```

- Enter commands for the PM6000 after the 'PM6000>' prompt.
- To finish the remote control by enter command:
exit

4.5. REMOTE COMMAND SYNTAX AND CONVENTIONS

The following conventions are used for command syntax

- Square brackets indicate optional parameters or keywords []
- Triangle brackets indicate values to be specified < >
- Vertical bar indicates the choice of parameters |

Commands and responses are sent as ASCII strings terminated with a line feed. The PM6000 is not case sensitive and white space characters are ignored except where required between command and parameter.

Multiple commands can be sent in a single string where a ';' character is used at the end of each command.

The PM6000 will respond to invalid commands by adding an error message to the error queue. It is recommended that the error queue is checked after issuing command sequences by using the SYST:ERROR queries to ensure successful configuration

PM6000 will always reply at least one char to the client socket.

During Ethernet connectivity all write commands have a return string sent. If the command that the client socket sent to the PM6000 was a asking command (e.g. :BRF?), then the return string is the results were asked. If the command is a configure command (e.g. :SEL:VLT) that no result was asked, PM6000 will send a " " (a space) as the reply. Thus in your program, writing a configure command must followed by a read (i.e. during programming a receive buffer flush is required after every write

command), otherwise all the " " chars will prefixed the next real result, that will cause error in the results process methods.

4.6. STATUS REPORTING

The PM3000 had four status bytes used to determine the overall status of the instrument. These have also been included in the PM6000, although the background status register and display data status register are effectively the same because in the PM6000 there are not separate averaging buffers for both remote commands and the display.

4.6.1 Status Byte Register

This register is read using the “*STB?” command. A value is returned representing a bit pattern. Each bit represents a condition

Bit	Condition	Description
0	DAS	Summary bit for data status
1	BAS	Summary bit for data status. This condition is exactly the same as DAS on the PM6000, but is preserved for backwards compatibility
2		
3		
4	MAV	Always 0 for RS232
5	ESB	Summary bit for data status
6	MSS	Master summary status, set if any of the other bytes in the register have been set and their corresponding bit in the service request enable register is also set
7		

4.6.2 Background and Display Status Register

In the PM3000 these were separate status registers. In the PM6000 the same register is used. Both the “:BSR?” and “:DSR?” commands read from this register.

Bit	Condition	Description
0	DVL	Set when data is available
1	NDV	Set when data is available
2	AVF	Set to when the averaging buffer is full to the specified depth
3	OVV	Set when a voltage over range has occurred
4	OVA	Set when a current over range has occurred
5		
6		
7		

4.6.3 Standard Event Status Register

This register is read using the “ESR?” command.

Bit	Condition	Description
0	OPC	Set after a *OPC command has been received, once all messages sent have been processed
1		
2	QRE	Un-terminated query error
3		
4	EXE	Execution error. A command parameter was invalid or out of range
5	CME	Command error. The command was not recognized
6		
7		

4.7. IEEE488.2 COMMON COMMANDS

4.7.1 *CLS Clear event status

Format: *CLS

Return None

format:

Description: Clears the standard event status register to 0

4.7.2 *ESE Set standard event status enable register

Format: *ESE <flags>

flags = value for enable register as a decimal 0 - 255

Default: 255

Description: Sets the bits that are enabled in the standard event status register. The status enable register uses the same bit definitions as the standard event status register

4.7.3 *ESE? Read standard event status enable register

Format: *ESE?

Return 0 - 255

format:

Description: Returns the value in the standard event status enable register

4.7.4 *ESR? Read event status register

Format: *ESR?

Return 0 - 255

format:

Description: Returns the value in the standard event status register, AND'ed with the value in the standard event status enable register. The event status register is cleared once it has been read

4.7.5 *IDN? Unit Identity

Format: *IDN?

Return VOLTECH, PM6000, *Serial Number, Firmware Version*

format:

Description: The serial number returned is the chassis unit serial number

4.7.6 *OPC Initialize Operation Complete Function

Format: *OPC

Return None

format:

Description: Enables OPC bit to be reported in the standard event status register

4.7.7 *OPC? Flag when Operation Complete

Format: *OPC?

Return 1

format:

Description: Returns once the OPC bit is set in the standard event status register, indicating that the PM6000 has finished processing commands

4.7.8 *RST Reset Device

Format: *RST

Return None

format:

Description: Resets the unit configuration to default values (performs the same action as Reset Defaults menu option on the front panel)

4.7.9 *SRE Set Service Request Enable Register

Format: *SRE <flags>
 flags = value for enable register as a
 decimal 0 - 255.

Return None

format:

Description: Sets the bits that are enabled in the status byte register.
 The service request enable register uses the same bit
 definitions as the status byte register with the exception of
 the MSS bit.

4.7.10 *SRE? Read Service Request Enable Register

Format: *SRE?

Return 0 - 255

format:

Description: Returns the value in the service request enable register.

4.7.11 *STB? Read Status Byte

Format: *STB?

Return 0 - 255

format:

Description: Returns the value in the status byte, masked by the service
 request enable register. Once read, the status byte is
 cleared to 0.

4.7.12 *TRG Trigger

Format: *TRG

Return None

format:

Description: Used to trigger a measurement when in single
 measurement mode.

4.7.13 *TST? Report Self Test

Format: *TST?

Return None

format:

Description: Always returns 0 for the PM6000.

4.7.14 *WAI Wait for Operation

Format: *WAI

Return None

format:

Description: Waits for the operation complete bit in the standard event status register to be set.

4.8. FORMAT COMMANDS

4.8.1 :AVG Set Averaging

Format: :AVG:FIX <depth>
 :AVG:AUT <depth>
 :FIX - set fixed averaging
 :AVG - set auto averaging
 depth - averaging buffer depth
 (integer between 1 - 64)

Return None

format:

Description: Sets up the averaging buffer for the measurements made by the PM6000. The sample period is approximately a third of a second so for an averaging buffer depth of 16, the buffer will fill in around five seconds. When in 'auto' mode, the buffer will be cleared if a significant change in value is detected. This has the effect of minimizing the drift between values. It will however affect the use of the Average Buffer Full status bit, as this will only be set when the buffer has valid values to its full depth. If this status bit is being polled, it is recommended to use fixed averaging mode.

The averaging buffer can be cleared using the RAV command

When the averaging buffer is full, bit 2 of the display status register becomes true

4.8.2 :BAL AM/Ballast Mode

Format: :BAL:ENB
:BAL:DIS

Description: Enable AM/Ballast mode for the currently selected group. When this mode is enabled, the filter is automatically set to 2MHz, and set for 50/60Hz modulation

Format: :BAL:50H
:BAL:60H

Description: Configure the mode for 50/60Hz modulation

Format: :BAL:FIX <freq>
Where <freq> is 5.0 to 10000 Hz

Description: Set to a fixed modulation frequency. The frequency is a decimal frequency

Format: :BAL:SRC <ch>
Where <ch> is 1 to 6

Description: Set to use the detected frequency from the specified channel. The specified channel must be in normal mode

Format: :BAL?

Return 5060Hz or FIX,<freq> or SRC,<ch>

format:

Description: Returns the Ballast frequency source of the currently selected group. Only responds if Ballast mode enabled

4.8.3 :BRD? Read Background Data

Format: :BRD?
:BRD:CH<ch>?
:BRD:GRP<group>?
:BRD:SUM?
:BRD:GRP<group>:SUM?

:BRD:ALL?

Where <ch> is a channel number 1 to 6

Where <group> is a group number 1 to 6

Return A number floating point values depending upon selection.
format: By default, a newline is sent after every 8 comma separated values. Continuous comma separated values can be specified by issuing a :CFG 276,1 command

Description: The BRD command actually reads from the same results buffer as the FRD command. It differs from FRD in that BRD returns all the enabled harmonic results, whereas FRD returns results only for the currently selected harmonic (see :HRM command)

If no secondary command is sent, results for all selected channels are returned.

:BRD:CH<ch>? Results for specific selected channel are returned.

:BRD:GRP<group>? Results for all the channels of the specific selected group are returned.

:BRD:ALL? Results for all channels are returned.

The results to be returned are selected using the :SEL command.

Once results are available, they are returned in floating point format with up to 8 values on each line. Results are returned in the following order. If the result has not been selected, it will just be skipped.

Watts, VA, VAr, Vrms, Arms, PF, Vpeak, Vpeak(positive), Vpeak(negative), Apeak, Apeak(positive), Apeak(negative), Vcf, Acf, Imp, Vdf, Adf, Freq, Vmean, Amean, Fund Watts, Fund VA, Fund VAr, Fund V, Fund A, Fund PF, R, X, Fund Vmean, Fund Amean, VDC, Voltage harmonics (magnitude & phase), ADC, Current harmonics (magnitude & phase), Watts harmonics (magnitude only), Sum results for selected group, Vthd, Athd, Vtif, Atif.

When returning harmonics, the DC value (harm 0) is first returned if AC+DC coupling is set. If odd and even

harmonics have been selected, all the harmonics up to the maximum will be sent. If only odd is selected, all the odd harmonics up to the maximum will be sent.

:BRD:SUM? The sum results returned are those for the group currently selected (see 4.11)

:BRD:GRP<group>:SUM return the sum results of the specific group.

The sum results only can be return when was enabled by the :SEL:SUM command and the group with more than one channels

4.8.4 :BRF? Read Background Data Selected Fields

Format: :BRF?
 :BRF:CH<ch>?
 :BRD:GRP<group>?
 :BRF:SUM?
 :BRD:GRP<group>:SUM?
 :BRF:ALL?

Where <ch> is a channel number 1 to 6

Where <group> is a group number 1 to 6

Return A number of parameter names depending upon selection.

format: Up to 8 values on each line.

Description: The BRF command returns the field names that would be returned by the BRD command. This can be used to confirm the selected parameters.

4.8.5 :BSE Set Background Data Status Enable Register

Format: :BSE <flags>
flags = value for enable register 0 - 255

Return None

format:

Description: Sets the bits that are enabled in the background and display status register. In the PM6000 there is only one set of results, but the background results commands are included for backwards compatibility. Command has

exactly the same functionality as :DSE

4.8.6 :BSE? **Read background Data Status Enable Register**

Format: :BSE?

Return 0 – 255

format:

Description: Returns the value in the data status enable register.
Command has exactly the same functionality as :DSE?

4.8.7 :BSR? **Read background Data Status Register**

Format: :BSR?

Return 0 – 255

format:

Description: Returns the value in the data status register, AND'ed with the value in the data status enable register. The data status register is cleared once it has been read. Command has exactly the same functionality as :DSR?

4.8.8 :CFG **Configure**

Format: :CFG <prog>, <data>

Return None

format:

Description: See the Configuration Commands section below for valid *prog* and *data* settings.

4.8.9 :CFG? **Read Configuration**

Format: :CFG? <prog>

Return Integer or floating point as appropriate.

format:

Description: Returns the configuration of the PM6000. See the

Configuration Commands section below for valid *prog* settings.

4.8.10 :CPL **Set AC/DC Coupling**

Format: :CPL:+DC
 :CPL:-DC
 :+DC - sets AC+DC coupling
 :-DC - sets AC only coupling

Return None

format:

Description: Sets the coupling for the group currently selected.

4.8.11 :DSE **Set Data Status Enable Register**

Format: :DSE <flags>

Default: 255

Description: As for :BSE above.

4.8.12 :DSE? **Read Data Status Enable Register**

Format: :DSE?

Return 0 – 255

format:

Description: As for :BSE? Above

4.8.13 :DSR? **Read Data Status Register**

Format: :DSR?

Return 0 – 255

format:

Description: As for :BSR? Above.

4.8.14 :DVC **Device Clear**

Format: :DVC

Return None

format:

Description: Performs a soft reboot.

4.8.15 :FNC?**Read Result**

Format: :FNC:CH<ch>:<func>[:MIN|MAX]?

ch - 1 to 6

:FNC:SUM:<func>[:MIN|MAX]?

Func can be one of

WAT - Watts

VAS - VA

VAR - VAr

VLT - Vrms

AMP - Arms

PWF - Power factor

FRQ - Frequency

VPK - Volts peak (absolute)

VPKP - Volts peak (positive)

VPKN - Volts peak (negative)

APK - Amps peak (absolute)

APKP - Amps peak (positive)

APKN - Amps peak (negative)

VCF - Volts crest factor

ACF - Amps crest factor

IMP - Impedance

WHR - Watt-Hrs (Integrator result)

VAH - VA Hours (Integrator result)

VRH - VAr Hours (Integrator result)

AHR - Amp Hours (Integrator result)

APF - Average power factor

(Integrator result)

TIM - Integrator time elapsed in hours

(Integrator result)

VDF - Volts distortion factor

VTHD - Volts Total Harmonic Distortion

VTIF - Volts Telephone Infl. Factor

ADF - Amps distortion factor

ATHD - Amps Total Harmonic Distortion

ATIF - Amps Telephone Infl. Factor

VDC - Volts DC
 ADC - Amps DC
 VMN - Voltage rectified mean
 AMN - Current rectified mean

Return Requested result (floating point)

format:

Description: Returns the requested result for the requested channel.

The SUM results returned are those for the group currently selected (see :INST:NSEL) and can only be read if SUM has been configured for the group (:SEL:SUM)

Min/max hold must be enabled prior to reading min/max results by using the :MIN and :MAX commands

4.8.16 :FND?

Read Fundamental Result

Format: :FND:CH<ch>:<func>[:MIN|MAX]?

ch - 1 to 6

:FND:SUM:<func>[:MIN|MAX]?

Func can be one of

WAT - Watts fundamental

VAS - VA fundamental

VAR - VAr fundamental

VLT - V fundamental

AMP - A fundamental

PWF - Fundamental Power factor

IMP - Fundamental Impedance

VHM - Voltage Harmonic

AHM - Current harmonic

WHM - Power harmonic

VHA - Voltage harm angle

AHA - Current harm angle

Return Requested result (floating point)

format:

Description: Returns the requested result for the requested channel.

The SUM results returned are those for the group currently selected (see :INST:NSEL) and can only be read if SUM

has been configured for the group (:SEL:SUM).

Min/max hold must be enabled prior to reading min/max results by using the :MIN and :MAX commands

Fundamental measurements must be enabled prior to requesting fundamental results. This can be done with :SEL:FUN or by specifying the number of harmonics to analyze with the HRM or HMX commands

4.8.17 :FRD?

Read Foreground Data

Format: :FRD?
 :FRD:CH<ch>?
 :FRD:GRP<group>?
 :FRD:SUM?
 :FRD:GRP<group>:SUM?
 :FRD:ALL?

Where <ch> is a channel number 1 to 6

Where <group> is a group number 1 to 6

Return format: A number of floating point values depending upon selection. Up to 8 values on each line.

Description: If no secondary command is sent, results for all selected channels are returned.

:FRD:CH<ch>? Results for specific selected channel are returned.

:FRD:GRP<group>? Results for all the channels of the specific selected group are returned.

:FRD:ALL? Results for all channels are returned.

The results to be returned are selected using the :SEL command.

Once results are available, they are returned in floating point format with up to 8 values on each line.

Results are returned in the following order. If the result has not been selected, it will just be skipped.

Watts, VA, VAr, Vrms, Arms, PF, Vpeak, Vpeak(positive), Vpeak(negative), Apeak, Apeak(positive), Apeak(negative),

Vcf, Acf, Imp, Vdf, Adf, Freq, Vmean, Amean, Fund Watts, Fund VA, Fund VAr, Fund V, Fund A, Fund PF, R, X, Fund Vmean, Fund Amean, VDC, Voltage harmonics (magnitude & phase), ADC, Current harmonics (magnitude & phase), Watts harmonics (magnitude only), Vthd, Athd, Vtif, Atif.

When returning harmonics, only the harmonic selected with :HRM command is returned. If the harmonic is H0 (DC), only the magnitude is returned. For other harmonics, both the magnitude and phase in degrees are returned.

:FRD:SUM? The sum results returned are those for the group currently selected (see 4.11)

:FRD:GRP<group>:SUM return the sum results of the specific group.

The sum results only can be return when was enabled by the :SEL:SUM command and the group with more than one channels

4.8.18 :FRF? **Read Foreground Data Selected Fields**

Format: :FRF?
 :FRF:CH<ch>?
 :FRF:GRP<group>?
 :FRF:SUM?
 :FRF:GRP<group>:SUM?
 :FRF:ALL?

Where <ch> is a channel number 1 to 6

Where <group> is a group number 1 to 6

Return A number of parameter names depending upon selection.
 format: Up to 8 values on each line.

Description: The FRF command returns the field names that would be returned by the FRD command. This can be used to confirm the selected parameters.

4.8.19 :FSR **Set Frequency Source**

Format: :FSR:VLT|AMP|EXT|SLW
 VLT - Set voltage frequency source
 AMP - Set current frequency source
 EXT - Set external frequency source
 SLW - Same as EXT on PM6000

Description: Sets the frequency source for the group currently selected

Format: :FSR:FIX <freq>
 <freq> frequency in Hertz

Description: Sets the fundamental frequency to the fixed value specified for the group currently selected

Format: :FSR?

Return Text string

format:

Description: Describes the frequency source configuration for the group currently selected

4.8.20 :HRM Set Single Harmonic

Format: :HRM <*harm*>
harm - integer harmonic number 1 - 99

Description: Sets the harmonic to be returned by the FNC, FND and FRD commands.

The harmonic number should be equal to or less than the number of harmonics calculated, which can be set by the :HMX command

Use CFG 18 to set the return format of harmonic results. Harmonic magnitudes may be returned in percentage of the fundamental or absolute value form.

Format: :HRM?

Return Number

format:

Description: Returned the currently selected value for HRM

4.8.21 :HMX Set Maximum Harmonic for Series

Format: :HMX:ODD <*harm*>
:HMX:ALL <*harm*>
:ODD - Only odd harmonics
:ALL - All harmonics
harm - integer maximum harmonic 1 - 99

Description: Sets the number of harmonics (for all of volts, amps and watts harmonics) to be calculated for the group currently selected. Also sets whether odd or all harmonics in the group are returned.

Format: :HMX:AHM:ODD <*harm*>
:HMX:AHM:ALL <*harm*>
:ODD - Only odd harmonics
:ALL - All harmonics
harm - integer maximum harmonic 1 - 99

Description: Sets the number of amps harmonics to be calculated for the group currently selected. Also sets whether odd or all harmonics in the group are returned.

Format: :HMX:VHM:ODD <*harm*>
 :HMX:VHM:ALL <*harm*>
 :ODD - Only odd harmonics
 :ALL - All harmonics
 harm - integer maximum harmonic 1 - 99

Description: Sets the number of volts harmonics to be calculated for the group currently selected. Also sets whether odd or all harmonics in the group are returned.

Format: :HMX:WHM:ODD <*harm*>
 :HMX:WHM:ALL <*harm*>
 :ODD - Only odd harmonics
 :ALL - All harmonics
 harm - integer maximum harmonic 1 - 99

Description: Sets the number of watts harmonics to be calculated for the group currently selected. Also sets whether odd or all harmonics in the group are returned.

Format: :HMX?

Return : ODD, Number *or*
 ALL, Number

Description: Returned the currently selected value for HMX
 (for all of the volts, amps, and watts hamonics)

Format: :HMX:AHM?

Return : AHM ODD, Number *or*
 AHM ALL, Number

Description: Returned the currently selected value for amps
 HMX

Format: :HMX:VHM?

Return : VHM ODD, Number *or*
VHM ALL, Number

Description: Returned the currently selected value for volts
HMX

Format: :HMX:WHM?

Return : WHM ODD, Number *or*
WHM ALL, Number

Description: Returned the currently selected value for watts
HMX

4.8.22 :INT Set up Integrator

Format: :INT:ENB
:INT:DIS

Return None

format:

Description: Enables or disables the integrator for the currently selected group (see :INST:NSEL)

If an integrator is enabled with a trigger that is already running, then the integrator on this group will start immediately

Format: :INT:TRG <trigger>

Where <trigger> is a number 1 to 6

Return None

format:

Description: Specifies the trigger associated with the integrator on the currently selected group (see :INST:NSEL)

This allows the user to configure a number of groups to use the same RUN/STOP/RESET events or to run independently

Format: :INT:TRG?

Return Number 1 to 6

format:

Description: Returns the trigger associated with the integrator on the currently selected group (see :INST:NSEL)

Format: :INT:RUN [<hours>]
hours - Run time in hours

Return None

format:

Description: Starts the integrator on the currently selected group and any other groups using the same trigger

:INT:RUN *hours* will start an integration over the specified number of hours. If *hours* is omitted :INT:RUN will start/resume the integration

Integration results can be read using the :FNC command

Format: :INT:STOP

Return None

format:

Description: Stops the integrator on the currently selected group and any other groups using the same trigger

Integration results can be read using the :FNC command

Format: :INT:RESET

Return None

format:

Description: Resets the integrator on the currently selected group and any other groups using the same trigger

The :INT:RESET commands clears the integration results and Tint, but the does not stop the integration. So results will be set to zero but integration will continue

Integration results can be read using the :FNC command

4.8.23 :MAX Enable Max store

Format: :MAX ON|1|OFF|0

Return None

format:

Description: The MAX store holds the maximum result for each parameter until the store is reset either by the ':RES' command or by the front panel [Reset/Clear] key.

Format: :MAX?

Return 0 or 1

format:

Description: Returns a zero if MAX store off, and 1 if MAX store enabled

4.8.24 :MEA Set Measurement Mode

Format: :MEA:CNT - Set continuous measurement mode
 :MEA:SNG - Set single measurement mode.

Return None

format:

Description: Sets the measurement mode in the PM6000. In continuous mode, results are continually updated. In single mode, measurements are stopped until a *TRG is received. Measurements are made until the averaging buffer has been filled. Once the averaging buffer has been filled measurements are stopped until the next *TRG is received.

4.8.25 :MIN Enable Min store

Format: :MIN ON|1|OFF|0

Return None

format:

Description: The MIN store holds the maximum result for each parameter until the store is reset either by the ‘:RES’ command or by the front panel [Reset/Clear] key.

Format: :MIN?

Return 0 or 1

format:

Description: Returns a zero if MIN store off, and 1 if MIN store enabled

4.8.26 :PWM PWM Mode

Format: :PWM:OUT <*lfmode*>

Where *lfmode* is 1, 2 or 3

Return None

format:

Description: Enable PWM Output mode for the currently selected group. The minimum expected modulation (or motor) frequency is determined by the *lfmode* parameter as follows

1	5Hz
2	1Hz
3	0.1Hz

The measurement update rate will be correspondingly slower with *lfmode* of 2 or 3

Format: :PWM:DIS

Return None

format:

Description: Exits PWM mode and returns to Normal mode

4.8.27 :RAV Reset Averaging

Format: :RAV

Return None

format:

Description: Reset averaging on all groups.

4.8.28 :RES Reset Min/Max Store

Format: :RES:CH<ch> MIN|MAX|ALL

:RES:SUM MIN|MAX|ALL

:RES:ALL MIN|MAX|ALL

CH<ch> - Reset stores for channel ch

SUM - Reset sum store for current group

ALL - Reset store for all groups

store - MAX Reset MAX store

- MIN Reset MIN store

- ALL Reset MIN and MAX stores

Return None

format:

Description: Reset the specified MIN/MAX stores.

Example: To reset all MIN and MAX results

:RES:ALL ALL

To reset the MAX store of channel 2

:RES:CH2 MAX

4.8.29 :RNG Set Ranging

Format: :RNG:VLT|AMP:FIX <range>
 :RNG:VLT|AMP:AUT
 :RNG:VLT|AMP:AUTUP
 VLT - Set voltage ranging
 AMP - Set current ranging
 FIX - Fixed ranging
 AUT - Auto ranging
 AUTUP - Auto up ranging
 range - integer range 1 - 9

Return None

format:

Description: Sets the ranging for the group currently selected. Range 1 is the lowest range (i.e. 5V for voltage range).

Format: :RNG:VLT|AMP?

Return One of 1, 2, 3, 4, 5, 6, 7, 8, 9, 10, AUT, AUTUP

format:

Description: Returns the range configuration for the group currently selected.

4.8.30 :SCL Set Scaling

Format: :SCL:VLT|AMP <scale>
 VLT - Set voltage scaling
 AMP - Set current scaling
 scale - floating point scale 0.00001 - 100000

Return None

format:

Description: Sets the scaling for the group currently selected.

4.8.31 :SEL Select Function List

Format: :SEL:CLR - Clear previous selection
:SEL:CH1 - Select Channel 1
:SEL:CH2 - Select channel 2
:SEL:CH3 - Select channel 3
:SEL:CH4 - Select channel 4
:SEL:CH5 - Select channel 5
:SEL:CH6 - Select channel 6
:SEL:SUM - Enable sum results
:SEL:FUN - Enable fundamental parameters
:SEL:WAT - Select Watts
:SEL:VAS - Select VA
:SEL:VAR - Select VAr
:SEL:VLT - Select Vrms
:SEL:AMP - Select Arms
:SEL:PWF - Select power factor
:SEL:VPK - Select volts peak (absolute)
:SEL:VPKP - Select volts peak (positive)
:SEL:VPKN - Select volts peak (negative)
:SEL:APK - Select current peak (absolute)
:SEL:APKP - Select current peak (positive)
:SEL:APKN - Select current peak (negative)
:SEL:VCF - Select volts crest factor
:SEL:ACF - Select current crest factor
:SEL:IMP - Select impedance
:SEL:WHR - Select Watt-Hrs
:SEL:VAH - Select VA Hours
:SEL:VRH - Select VAr Hours
:SEL:AHR - Select Amp Hours
:SEL:APF - Select average power factor
:SEL:CVR - Select correction Vars
:SEL:VHM - Select voltage harmonic
:SEL:AHM - Select current harmonic
:SEL:WHM - Select Watts harmonic
:SEL:VDF - Select Volts distortion factor
:SEL:VTHD - Select Volts Total Harmonic
Distortion

:SEL:VTIF - Select Volts Telephone Infl.
Factor

:SEL:ADF - Select Amps distortion factor

:SEL:ATHD - Select Amps Total Harmonic
Distortion

:SEL:ATIF - Select Amps Telephone Infl.
Factor

:SEL:FRQ - Select frequency

:SEL:TIM - Select integrator time

:SEL:VDC - Select volts DC

:SEL:ADC - Select current DC

:SEL:VHA - Select voltage harm angle

:SEL:AHA - Select current harm angle

:SEL:VMN - Select voltage rectified mean

:SEL:AMN - Select current rectified mean

Return None

format:

Description: Selects which results are to be returned for the BRD and FRD commands. The selected parameter field names can be read back using the FRF? and BRF? query commands

:SEL:FUN and :SEL:SUM setup the group for these measurements and other related parameters. Use :INST:NSEL to select the group to be configured.

Use :HMX to ensure required harmonics are configured prior to requesting results

4.8.32 :WRG Set Wiring Configuration

Format: :WRG:1P2 - Set 1 phase 2 wire

:WRG:1P3 - Set 1 phase 3 wire

:WRG:3P3 - Set 3 phase 3 wire

:WRG:3P4 - Set 3 phase 4 wire

:WRG:3P7 - Set 3 phase 7 wire

:WRG:ALL - Set 1 phase 2 wire in all groups

Return None

format:

Description: Sets up the wiring configuration for the group currently selected, with the exception of :ALL which sets 1 phase 2 wire in all groups.

4.9. CONFIGURATION COMMANDS (:CFG COMMAND)

The '`:CFG Prog, Value`' command takes as its parameter a numeric value. This indicates the setting that is to be set or read. The table below lists the valid commands. It also indicates the valid settings for each command

Prog Num	Function	Value	Notes
2	Target power factor	Floating point number	For group currently selected
11	Disable acquisition	0 = run 1 = hold	Enables/disables acquisition for remote only
12	Hold display	0 = run 1 = hold	
13	Wiring configuration	0 = 1 phase 2 wire 1 = 1 phase 3 wire 2 = 3 phase 3 wire 3 = 3 phase 4 wire 7 = all groups 1ph 2w	0 – 3 are for group currently selected.
16	THD Formula	0 = Distortion factor 1 = THD	For group currently selected
17	Harmonic reference	0 = fundamental 1 = RMS	For group currently selected
18	Harmonic display	0 = percentage (Default) 1 = actual value V/A	Affects all groups
19	THD formula	0 = H0 (dc) excluded 1 = H0 (dc) included	For group currently selected
21	Fixed frequency	0 = disable 1 = enable	For group currently selected
22	Fixed frequency val	Floating point freq	For group currently selected

26	Low level blanking	0 = disable 1 = enable	Affects all groups
30	Disable channel (ch1)	0 = disable 1 = enable	Disables group containing ch1
32	AC/DC coupling (ch1)	0 = AC coupled 1 = AC+DC coupled	Affects group containing ch1
33	HF Ballast(AM) (ch1)	0 = off 1 = 50Hz 2 = 60Hz	Affects group containing ch1.
34	Phase reference (ch1)	0 = voltage 1 = current	Affects group containing ch1
39	Freq Source (ch1)	0 = voltage 1 = current 2 = external 3 = slow external	Affects group containing ch1. Setting 3 is exactly the same as 2 on the PM6000.
40	Voltage range (ch1)	0 = 5V 1 = 10V 2 = 20V 3 = 50V 4 = 100V 5 = 200V 6 = 500V 7 = 1kV 8 = 2kV	Affects group containing ch1.
41	Current range (ch1)	0 = 5mV 1 = 10mV 2 = 25mV 3 = 50mV 4 = 100mV 5 = 250mV 6 = 500mV	Affects group containing ch1.

		7 = 1V 8 = 2.5V	
42	Voltage ranging (ch1)	0 = auto ranging 1 = manual	Affects group containing ch1.
43	Current ranging (ch1)	0 = auto ranging 1 = manual	Affects group containing ch1.
44	Voltage scaling (ch1)	Floating point scaling	Affects group containing ch1.
45	Current scaling (ch1)	Floating point scaling	Affects group containing ch1
49	PWM motor drive (ch1)	0 = disabled 1 = input 2 = output	Affects group containing ch1.
50–69	As 30–49 above for ch2		
70–89	As 30–49 above for ch3		
115	Integrator functions	0 = accumulated (default) 1 = averaged	Affects results returned by remote for all groups
119	PWM input window	Floating point num of seconds	Affects group currently selected
120	PWM output range	1 = 5Hz 2 = 0.1Hz 3 = 0.1Hz 4 = 5Hz	Affects group currently selected. On the PM6000, determines the minimum fundamental frequency.
127	Remote display	0 = disabled (Default) 1 = enabled	Determines if display is visible when in remote
135	Harmonic series	0 = odd and even 1 = odd only	Affects group currently selected
136	Maximum harmonic	Integer 0 - 99	Affects group currently selected

179	Integrator reset	0 = disabled 1 = enabled	Affects integrator for the group currently selected
184	Selected harmonic	Integer 0 - 99	Affects the harmonic returned for FND and FNC commands
190	Reversed PF sign	0 = disabled 1 = enabled	Just affects results sent by remote
191	SUM A = (A1+A2+A3)/3	0 = disabled 1 = enabled	Affects group currently selected
192	SUM V = (V1+V2+V3)/3	0 = disabled 1 = enabled	Affects group currently selected
251	Auto zero	0 = disabled 1 = enabled	Affects all groups
275	RS232 verbose Echo mode	0 = disabled 1 = enabled	
276	Single reply string	0 = disabled (Default) 1 = enabled	Also affects FRD response format. If 0 then 8 values per line, if 1 then continuous comma separated values
279	Data return format	0 = 4.5 digit ASCII 1 = 5 digit ASCII 2 = 7 digit ASCII	

4.10. :INP COMMANDS

4.10.1 :INP:FILT:LPAS

Format: :INP:FILT:LPAS 10000000
 :INP:FILT:LPAS 2000000
 :INP:FILT:LPAS 500000
 :INP:FILT:LPAS 200000
 :INP:FILT:LPAS 100000
 :INP:FILT:LPAS 50000
 :INP:FILT:LPAS 20000
 :INP:FILT:LPAS 10000
 :INP:FILT:LPAS 5000
 :INP:FILT:LPAS 2000

Return None

format:

Description: Sets the low pass filter to be used in the group currently selected. The frequency value corresponds to the 3dB point of the filter.

Format: :INP:FILT:LPAS?

Return Floating point 3dB point of the filter selected.

format:

Description: Returns the low pass filter setting for the group currently selected.

4.11. :INST COMMANDS

The PM6000 combines one or more physical channels into groups. These groups may then be configured causing all the channels within the group to be configured with the same values.

To retrieve a list of all the groups configured in a PM6000 the following SCPI command is used

```
:INST:CAT:FULL?
```

To select a group on which to perform an operation the following SCPI commands are used

```
:INST:SEL <group name>
```

or

```
:INST:NSEL <group number>
```

To retrieve which group is currently selected the following SCPI commands are used

```
:INST:SEL?
```

or

```
:INST:NSEL?
```

4.11.1 :INST:CAT

Format: :INST:CAT:FULL?

Return <group name_n> [, ...]

format: The format of the returned information is a comma separated list of between none and 6 group identifier names.

Description: Returns the group names for all the groups in the PM6000. The group names are returned in order, i.e. the first group name returned is that for group 1.

4.11.2 :INST:CHAN?

To identify which channels are configured in the currently selected group the standard SCPI :INST: command is extended

Format: :INST:CHAN?

Return <number of channels>[,<first channel
format: number> [,<second channel number> [,<third
channel number>]]]

Description: Returns the number of channels in the group, and then a list of the channels that are in the group.

e.g. The following may be returned

“2, 4, 5”

In the currently selected group there are 2 channels: ch4 and ch5.

4.11.3 :INST:NSEL

Format: :INST:NSEL <group number>
group number - integer between 1 and 6, depending on the number of groups available in the PM6000

Return None

format:

Description: Selects the group specified

4.11.4 :INST:NSEL?

Format: :INST:NSEL?

Return <group number>

format:

Description: Returns the number of the group selected (between 1 and 6 depending on wiring configuration)

4.11.5 :INST:SEL

Format: :INST:SEL <group name>

Return None

format:

Description: Selects the group with the name specified

4.11.6 :INST:SEL?

Format: :INST:SEL?

Return <group name>

format:

Description: Returns the name of the group currently selected.

4.11.7 :INST:STAT

Format: :INST:STAT ON|OFF

Return None

format:

Description: Enables current group. By default all are ON. When disabled, no measurements are updated

4.11.8 :INST:STAT?

Format: :INST:STAT?

Return ON|OFF

format:

Description: Returns enable status of current group

4.12. :SENS COMMANDS

4.12.1 :SENS:ZERO

Format: :SENS:ZERO IMM

Return None

format:

Description: Performs a one off offset zero immediately

4.12.2 :SENS:ZERO:AUTO

Format: :SENS:ZERO:AUTO ON|OFF

Return None

format:

Description: Enables automatic offset zero (Default ON)

4.13. :SYST COMMANDS

4.13.1 :SYST:CTYPE

To allow any analogue cards or shunt modules installed to be identified, the standard SCPI 1997 :SYST:CTYPE command group has been extended

Format: :SYST:CTYPe? <ch>, A
 Return VOLTECH, ANALOGUE CARD, <serial number>, <card
 format: revision>
 Description: Returns the serial number and hardware revision of the
 analogue card in the requested channel.

Format: :SYST:CTYPe? <ch>, S
 Return VOLTECH, SHUNT MODULE, <serial number>, <shunt
 format: revision>
 Description: Returns the serial number and hardware revision of the
 external shunt in the requested channel.

4.13.2 :SYST:TIME

Format: :SYST:TIME <hour>,<minute>,<second>
 Return None
 format:
 Description: Sets the system time where
 <hour> is 0 to 23
 <minute> is 0 to 59
 <second> is 0 to 59

Format: :SYST:TIME?
 Return Hour, minute, second
 format:
 Description: Returns the system time

4.13.3 :SYST:DATE

Format: :SYST:DATE <year>, <month>, <day>

Return None

format:

Description: Sets the system date where
<year> is four digit year
<month> is 1 to 12
<day> is 1 to 31

Format: :SYST:DATE?

Return Year, month, day

format:

Description: Returns the system date

4.13.4 :SYST:ERROR

When remote programming the instrument, it is important to ensure that commands are acting in the expected way. One important part of this is to regularly check to if errors have been raised by the instrument.

The error queue consists on a first-in, first-out buffer that can hold the most recent 20 error messages. When full, an additional message will be supplied indicating a queue overflow

Format: :SYST:ERRor[:NEXT]?

Return Error number, "error description"

format:

Description: Returns the first error message in the error list. Each message consists of an error number identifying the type of error, and a description that describes the error type and sometimes additional information about the specific error. Once the command has been read it will be removed from the error queue, bringing the next error to the top
If no error has occurred since the last error query, then 0, "No error" will be returned

Format: :SYSTem:ERRor:ALL?

Return Error number, "error description", error number, "error description",, error number, "error description"

Description: Returns the complete error message list, and so clears the queue
If no error has occurred since the last error query, then 0, "No error" will be returned

Format: :SYSTem:ERRor:CODE:NEXT?

Return Error number

format:

Description: Returns the next error number from the error list, and removed that error from the list

If no error has occurred since the last error query, then

0

will be returned

Format: :SYSTem:ERRor:CODE:ALL?

Return Error number, error number, ..., error number

format:

Description: Returns the complete error number list, and so clears the queue

If no error has occurred since the last error query, then

0

will be returned

Format: :SYSTem:ERRor:COUNT?

Return Number

format:

Description: Returns the number of errors in the error list

If no error has occurred since the last error query, then

0

will be returned

4.14. EXAMPLES OF USING COMMANDS

4.14.1 Suggested Protocol

- Set 10 seconds for read/write timeouts
- Enable CTS/RTS Flow control
- Add 200mS delay on all transmits,
- Poll the DSR? register for the averaging full bit and add no delays for reads.

4.14.2 Retrieving a single result

The following example uses the FNC (function read) and FND (fundamental read) commands to read the rms and fundamental voltage.

- :CFG 275,0 (turns off echo)
- :INST:NSEL 1 (sets channel 1 as group 1)
- :WRG:1P2 (sets group 1 as single phase)
- :INP:FILT:LPAS 2000000 (sets 2MHz filter)
- :AVG:FIX 4 (number can be 1 – 64) (sets averaging)
- :FSR:VLT (sets frequency source as voltage)
- :CPL:+DC (sets AC-DC coupling)
- :DSE 4 (And's the DSR? Register)
- :DSR? (Poll DSR? Until DSR? returns 4)
- :FNC:CH1:VLT? (get the rms Voltage result)
- Read (read receive buffer)
- :SEL:FUN (selects fundamental values)
- DSR? (Poll DSR? Until DSR? returns 4)
- :FND:CH1:VLT? (query fundamental Voltage result)
- Read (read receive buffer).

Working with multiple channels per group

A multiple channel unit can be set as all independent channels or set in groups of 2 or 3 channels. Many commands are generic to cover all groups. To set-up two groups of 3 channels :INST:NSEL 1, :INP:FILT:LPAS 2000000 and :WRG:3P4 sets the first 3 channels as group 1 in a 3P4 wire configuration. Next send :INST:NSEL 2, :INP:FILT:LPAS 500000 and :WRG:3P4 sets the last 3 channels as group 2. Now reading individual channels requires :INST:NSEL 2, :FNC:CH1:VLT? Reads channel 1 of group 2 (which is channel 4).

If all 6 channels were independent then :FNC:CH4:VLT? Would read channel 4.

4.14.3 Multiple Reads Using FRD?

The following example uses the FRD (foreground read) command to measure the Voltage, current, power factor, frequency, voltage distortion factor and the current distortion factor on a single channel.

- :CFG 275,0 (turns off echo)
- :CFG 276,1 (allows more than 8 results to a string)
- :INST:NSEL 1 (selects channel 1 as group 1)
- :WRG:1P2 (single phase wiring)
- :INP:FILT:LPAS 2000000 (sets 2MHz filter)
- :AVG:FIX 4 (number can be 1 – 64) (sets averaging)
- :FSR:VLT (sets frequency source as voltage)
- :CPL:+DC (sets AC-DC coupling)
- :HMX:ALL 21 (21 harmonics selected to allow VDF and ADF reads)
- :SEL:CLR;:SEL:CH1;:SEL:VLT;:SEL:AMP
- :SEL:PWF;:SEL:FRQ;:SEL:VDF;:SEL:ADF
- :DSE 4 (Ands the DSR? Register)
- :DSR? (send next query on DSR? = 4)
- *TRG (triggers the results)
- :FRD:CH1? (query selection results. Channel 1 only of group 1)
- Read (read receive buffer)

In the same way as with single results multiple channels can be grouped. :INST:NSEL 1, :INP:FILT:LPAS 2000000 and :WRG:3P4 sets the first 3 channels as a 3P4 wire configuration under group 1. Now add :SEL:CH2, :SEL:CH3 and change :FRD:CH1? To :FRD? and the results string will contain CH1, CH2 and CH3 in that order.

4.14.4 Multiple Reads Using the BRD? Command

The following example uses the BRD (background read) command to measure the 21 voltage and current harmonics on a single channel.

- :CFG 275,0 (turns off echo)
- :CFG 276,1 (allows more than 8 results to a string)
- :INST:NSEL 1 (selects channel 1 as group 1)
- :WRG:1P2 (single phase wiring)
- :INP:FILT:LPAS 2000000 (sets 2MHz filter)
- :AVG:FIX 4 (number can be 1 – 64) (sets averaging)
- :FSR:VLT (sets frequency source as voltage)
- :CPL:+DC (sets AC-DC coupling)
- :HMX:ALL 21 (21 harmonics selected)
- :SEL:CLR;;SEL:CH1;;SEL:VHM;;SEL:AHM
- :BSE 4 (Ands the DSR? Register)
- :DSR? (send next query on DSR? = 4)
- *TRG (triggers the results)
- :BRD:CH1? (query selection results channel 1 only of group 1)
- Read (read receive buffer)

BRD? Is usually used to read back a group of series harmonics however other results can also be accessed using BRD?. To set-up two groups i.e. group 1 = 3P4 wire configuration and group 2 = 3P4 wire configuration the following is required: - :INST:NSEL 1, :HMX:ALL 21 and :INST:NSEL 2, :HMX:ALL 21 sets up 21 harmonics on both groups. Adding :SEL:CH2 and :SEL:CH3 will bring back 21 voltage and current harmonics from both groups. The return order is group 1 ch1, ch2 and ch3 then group 2 ch1, ch2 and ch3, replace the :BRD:CH1? to :BRD? in order to read all results back.

The use of :INST:NSEL? And :INST:CHAN? Provides information on group and channel selections.

5. REMOTE ACCESS

5.1. CONNECTING TO THE PM6000 USING ETHERNET

There are two ways in which to connect to the PM6000 using the Ethernet port on the back of the PM6000. You can use a normal Ethernet network, or use a direct connection between a PC and the PM6000.

Ethernet is required for firmware upgrades (section 9.4) and for access results via FTP (section 5.2).

5.1.1 Network Connection Method

This would be the method that you would use if you were to attach your PM6000 to a local area network. The PM6000 supports networks with and without DHCP (Dynamic Host Configuration Protocol).

For this method, all you need to do is connect you PM6000 to your network or router using a normal, straight through, Ethernet cable. Follow the instructions in the Interface section (3.2.14) of this manual that will walk you through setting up the PM6000.

5.1.2 Direct Connection Method

Many people do not have access to either a network or a router, or are not allowed to plug unauthorized equipment in to the available network. In order to connect to you PM6000 in order upgrade the firmware or access files via FTP, you can connect your PM6000 directly to your PC using an Ethernet crossover cable.

Voltech's preferred method for making this connection is to use a USB to Ethernet adapter. This approach has the following advantages:

1. The PM6000 is connected directly to your PC via Ethernet, but is not on the corporate network and so does cause conflict with IT departments.
2. Your PC can still be directly connected to your local network giving you normal file and Internet access.
3. No hub or switch is required.

To set up a direct connection do the following

1. Use a 'crossover' network cable (Voltech Part Number 77-048) to connect the PC network card / USB to Ethernet adapter directly to the PM6000 network socket. This must be done first, and the PM6000 must be switched on before proceeding to the next step.
2. Open a DOS window on your PC. To do this click on 'Start' followed by 'Run...' and type 'cmd'. Click on 'Enter'.
3. At the DOS prompt type 'ipconfig /release' and wait for the DOS prompt to return. The IP address should be displayed as 0.0.0.0.
4. Type 'ipconfig /renew'. Again, wait for the DOS prompt to appear. This could take up to 1 minute. If your PC was previously connected to a DHCP network, you may get an error message stating that there was an error connecting to the DHCP server. This is OK.
5. To view the Ethernet connection settings type 'ipconfig'. Record the PC IP Address and then add 1 to the fourth number, unless the last number is 255 in which case subtract 1. This new number will be the IP address of the PM6000. An example for the PC IP address would be 169.254.110.255. This would mean that the PM6000 IP address would be 169.254.110.254.
6. Record the subnet mask (usually 255.255.0.0).
7. On the PM6000 Interface->Ethernet menu check Fix Settings
8. Then go down into the Fix Settings submenu and set IP Address to the PM6000 IP address (e.g. 169.254.110.254) and set the subnet mask to be the same as the PC subnet mask (e.g. 255.255.0.0).
9. Leave this menu.

Note: Certain firewall settings can cause the upgrade process to fail. To avoid this, please turn off your firewall before starting the upgrade process. Please remember to reactivate your firewall upon completion of the upgrade process.

For Windows XP users, the Windows firewall can be turned off by clicking on the Security Center icon on the Control Panel. From there, select Windows Firewall and then select Off.

You should now have an Ethernet link between your PC and the PM6000. This can be tested by typing 'ping' followed by the PM6000 IP address (e.g. 'ping 169.254.110.254') at a DOS prompt. You should get numerous replies.

If you used the Ethernet port on your that you normally use to connect to your network, it is best to connect your PC to you network, open a DOS prompt again, and type 'ipconfig /release' followed by 'ipconfig /renew'. At this point you should be back on your local area network.

5.2. FTP

FTP stands for File Transfer Protocol. A protocol is a language that enables computers to speak to one another. FTP is used to make files and folders publicly available for transfer over the Internet and between computers of all types.

Programs that use FTP to access files are called FTP Clients. There are many FTP Client programs, several of which are available as part of Windows, Linux and Mac Operating systems. Most internet browser programs provide FTP although more advanced and user friendly programs are readily available and can be downloaded from the internet

Please refer to the help section of the browser or FTP client program for specific information about how to login, copy, delete and create directories and files.

Note: Certain firewall settings can cause the upgrade process to fail. To avoid this, please turn off your firewall before starting the upgrade process. Please remember to reactivate your firewall upon completion of the upgrade process.

For Windows XP users, the Windows firewall can be turned off by clicking on the Security Center icon on the Control Panel. From there, select Windows Firewall and then select Off.

5.2.1 Anonymous or User login

The PM6000 allows both Anonymous and user logins. The differences are that in anonymous mode files can only be copied from the PM6000.

If a user login is provided, files and directories can be copied, deleted and created, allowing better management of the PM6000 storage media.

5.2.2 Connecting to the PM6000 using Internet Explorer

Make sure the Ethernet interface is configured and that an IP address is shown in **Interface-> Ethernet->View Settings**

Connect to the PM6000 using this IP address (e.g. 192.168.2.1).

In your internet browser address bar enter

`ftp://192.168.2.1/pub`

for an anonymous login

or

`ftp://pm6000:pm6000@192.168.2.1/pub`

to login using the pm6000 account

Other programs may ask for a username and password. Use the following, all in lower case letters

Username: **pm6000**

Password: **pm6000**

Firewall settings may affect the operation of the FTP connection, causing delays or even failure to connect. If you are encountering problems connecting to the PM6000, consult your network administrator.

5.2.3 Connecting to the PM6000 using an FTP program.

For quicker file transfer, it is recommended to use a File Transfer Protocol (FTP) program such as FileZilla which is freely available at <http://filezilla-project.org/>.

Make sure the Ethernet interface is configured and that an IP address is shown in **Interface-> Ethernet->View Settings**

Open your FTP program, in this case FileZilla. For the connection information, the host is the IP address of the PM6000, the user name and password is "pm6000", and the port is 21. Once you connect you will have a screen similar to below:

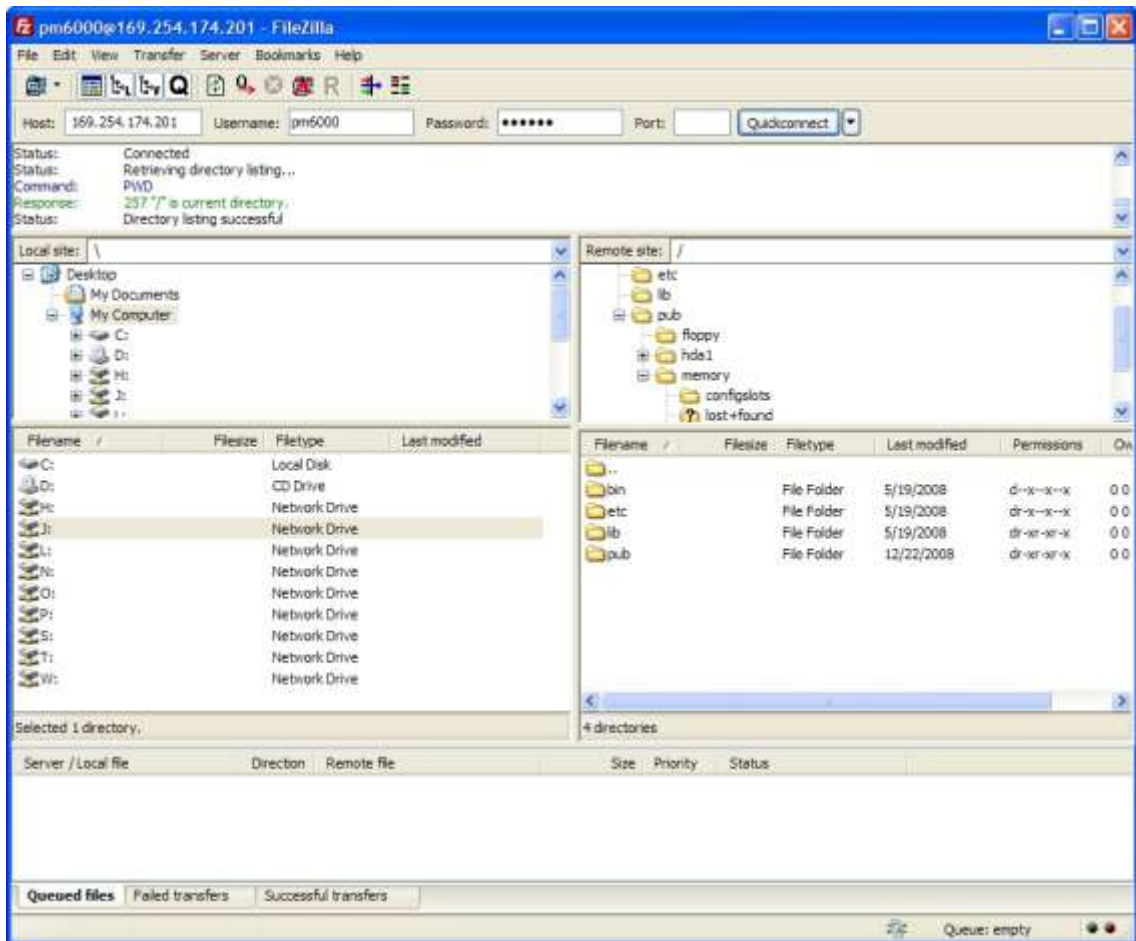

Your PC files will appear in the left windows while the PM6000 files and directories will appear in the right hand windows. In the PM6000 directory structure you must first go in to the pub directory. From there you will the directories for memory, the floppy drive and the hard drive, where applicable. Files can now be copied from the PM6000 to your PC. In the case of FileZilla, this can be done by dragging the desired file from the PM6000 window in to the desired directory on your PC as listed in the windows on the left.

5.2.4 Finding your way around

The PM6000 allows FTP to all available storage media on the instrument. As such, once connected, the files and directories of interest need to be found. The file system is organized as follows

/pub/floppy/ (if fitted) Contains files on the floppy disk in the instrument. If you choose to save results to floppy disk, then these files will be visible here.

/pub/hda1/usr/ (if fitted) Contains directories and files on the hard disk visible to the instrument. If you choose to save results to the optional hard drive, then these files will be visible here.

/pub/memory/usr/ Contains directories and files in the internal memory that are visible to the instrument. If you choose to save results to memory, then these files will be visible here.

NOTE: Some browsers will use cache to display the information. Use the refresh button on your browser to ensure that you have the correct information displayed.

In each of the floppy, hda1, and memory directories, other system directories may be visible, but do not contain information that can be copied by the operator. The information that you see in the directories listed about is also viewable by pressing the DATA button on the PM6000 and then selecting the appropriate source i.e. memory, floppy disk (if fitted) or hard drive (if fitted).

Below is a typical screen shot of the directories available on the PM6000.

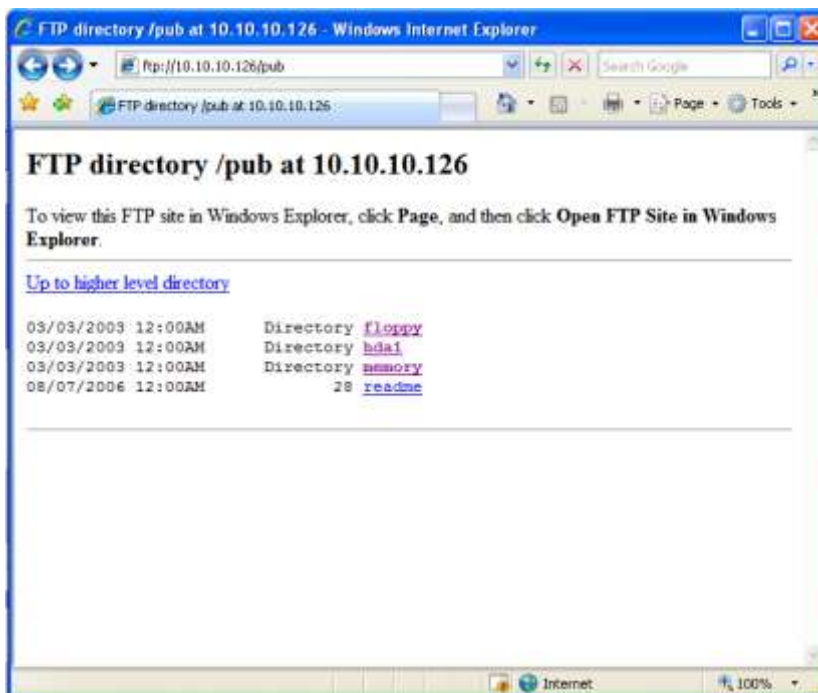

Only files and directories in or below these directories will be visible and accessible from the instrument.

WARNING: Various other files and directories may be visible by the FTP browser. Do not attempt to modify or delete these files as this may damage the instrument.

6. FITTING OPTIONS

6.1. VOLTECH SHUNTS

The Shunt Assemblies can be fitted into any channel, it is not necessary to fit the Shunts in order and any combination is possible.

6.1.1 Equipment Required

#1 Pozi-Drive Screwdriver

0.1 to 1.2Nm Adjustable Torque Driver

6.1.2 Installation Procedure

Switch off the PM6000 and disconnect all power and measuring leads before starting this procedure.

1. Place the Shunt into the desired channel ensuring that the connector is fully mated. Push the shunt firmly until it rests against the face of the Analogue PCB.
2. Fit the 3 off M3x8mm (VPN 68-197) pan head Pozi (with external lock washer) through the shunt and into the analogue rear panel. Tighten the screws to 0.8Nm.
3. Switch on the PM6000 and the new shunt will be automatically recognized by the PM6000. This can be confirmed in the [CONFIG] menu. If the shunt is not available, or any warnings are displayed during switch on, please contact you Voltech service center.

6.2. PCMCIA CARDS

The PM6000 is equipped with 2 PCMCIA slots that can accommodate a variety of standard card to enhance the functionality of the instrument.

At present, no PCMCIA cards are support.

7. SOFTWARE

There is a variety of software available for the PM600 as detailed below. Please contact your local Voltech distributor for further information on any of Voltech's software.

7.1. IEC 61000-3-2/3 CURRENT HARMONICS AND FLICKER SOFTWARE

Voltech offers complete solutions for full or pre-compliance testing to the current IEC/EN standards EN61000-3-2 (harmonics) and EN61000-3-3 (flicker). The powerful PM6000 easily meets the requirements of the latest version of EN61000-4-7 (harmonic measurement instrumentation) including the requirements for inter-harmonic grouping and a 200ms measuring window. The PM6000 also implements the requirements for a reference instrument by using a discrete Fourier transform as opposed to a fast Fourier transform (FFT), providing reliable, error-free harmonic measurements in all conditions.

The easy-to-use software package provides design and EMC engineers with a comprehensive suite of measurements and reports so that they can comply with the mandatory requirements for products destined for the markets of Europe and many other countries in the world. Voltech harmonics and flicker analyzers are used by most of the leading EMC test houses in the world for full compliance testing and by the major suppliers of electrical and electronic products in their own test laboratories.

7.2. PM6000 VISUAL POWER ANALYSIS SOFTWARE (PM6VPAS)

The PM6VPAS can also be used for general purpose, motor and ballast applications utilizing the software's ability to save and load configuration set-ups, while logging results to .csv files for later processing. Features include the saving and loading of single shot results, the utilization of the clipboard to save screen shots to file, view them in the main form or print them and the ability to display harmonic magnitude and phase bar charts. The PM6VPAS software will operate independently or in conjunction with a data acquisition unit (USB-6009 from National Instruments) or where a PM6000 is not required the USB-6009 can be operated to independently measure sensor data only.

The software also has the ability to make motor drive application measurements such as input power, output power, mechanical power and overall efficiency when used with the USB-6009.

NOTE: When using the USB-6009 box from National Instruments, it is essential to ensure that the voltages applied to the USB-6009 do not exceed the rated voltage, which is nominally +/- 20V. Exceeding the rated voltage could well result in permanent damage to the USB-6009.

8. SPECIFICATION

8.1. MEASURING CHANNEL

8.1.1 Voltage connections

- Measurements to 2000Vpk, DC to 10MHz, continuous
- 4000Vpk for 1 second
- Differential input impedance: 1Mohm in parallel with 26pF
- High and low input impedance to ground: 22pF

8.1.2 Current connections

- Measurements to 2.5Vpk, DC to 10MHz, continuous
- 50Vpk for 1 second
- Differential input impedance: 2Mohm in parallel with 12pF
- High and low input impedance to ground: 22pF

8.1.3 Analogue Card power supply outputs

Non-isolated 12V supply

- $\pm 12\text{V}$, 100mA max (protected), +5%, -7.6%.

Isolated 5V supply

- $\pm 5\text{V}$, 50mA max (protected), $\pm 5\%$.

8.2. MECHANICAL AND ENVIRONMENT

8.2.1 Dimensions (Approx)

- Height: 17cm
- Width: 42cm
- Depth: 36cm

8.2.2 Weight (Approx)

- 12Kg for 6-phase instrument with no shunts

8.2.3 Line Input

- 90VAC to 264VAC, 47-63Hz. 170VA

8.2.4 Dielectric Strength

- Mains supply inlet (Live + Neutral to earth): 2.9KV DC
- Voltage measurement inputs: 2KVpk
- Current measurement inputs: 2KVpk
- Isolated supplies: 2KVpk

8.2.5 Storage Temperature

- -20°C to +70°C

8.2.6 Operating Temperature

- 0°C to 40°C

8.2.7 Humidity

- 10 to 90% relative humidity non-condensing

8.3. EXTERNAL INPUT

Input Impedance:

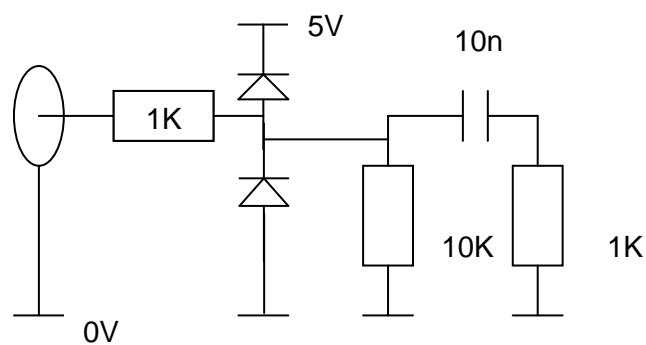

- Edge triggered system - Minimum dv/dt on each edge is $0.5V/\mu S$
- 5V TTL compatible
- Diode clamp protected to $\pm 20V$

8.4. PERIPHERAL PORTS

8.4.1 Serial Port

- 9 pin male D-type connector on rear of instrument
- RS232 Interface for connection to a PC for remote control with a null modem cable
- Available baud rates 9600 (Default), 19200, 38400, 57600, 115200
- 8 bit, No parity, 1 stop bit, hardware flow control

Pin	Signal name	Pin	Signal name
1	No connection	6	No connection
2	i/p RXD	7	o/p RTS
3	o/p TXD	8	i/p CTS
4	No connection	9	No connection
5	0V		

8.4.2 Parallel Port

- 25 pin female D-type connector on rear of instrument
- Standard parallel printer interface

Pin	Signal name	Pin	Signal name
1	o/p !STROBE	11	i/p BUSY
2	o/p D0	12	i/p PE
3	o/p D1	13	No connection
4	o/p D2	14	o/p !AUTOFD
5	o/p D3	15	i/p !ERROR
6	o/p D4	16	o/p !INIT
7	o/p D5	17	o/p !SLCTIN
8	o/p D6	18	0V
9	o/p D7	...	
10	i/p !ACKNLG	25	0V

8.4.3 External Monitor

- Output compatible with IBM® VGA
- Connector: HD-15 Socket on rear of instrument

Connector pin-out:

Pin	Signal name	Pin	Signal name
1	o/p Red Signal	9	
2	o/p Green Signal	10	
3	o/p Blue Signal	11	
4	No Connection	12	+5V
5	0V	13	o/p H Sync
6	0V	14	o/p V Sync
7	0V	15	+5V
8	0V		

8.4.4 External Keyboard and Mouse

- Compatible with IBM® PS/2
- Connector: 6-pin Mini-DIN socket on rear of instrument
- Mouse input is not currently used

8.4.5 USB Slave Port

- Full Speed (12Mbps) USB Device (Slave)
- Connector: USB type B receptacle
- USB Slave currently not supported

Pin	Signal Name
1	Power +5V
2	Bi D-
3	Bi D+
4	Power 0V

8.4.6 Ethernet Port

- IEEE 802.3 10Base-T and 100Base-Tx (Half or Full Duplex)
- Connector: RJ-45 with Link and Activity indicators

Pin	Signal Name
1	Tx+
2	Tx-
3	Rx+
4	Common
5	Common
6	Rx-
7	Common
8	Common

Status indicators:

Green Link/Activity indicator

Yellow Speed 100Mbps indicator

8.4.7 Floppy Disk

- Compatible with Windows/DOS format
- 3 1/2" HD format
- Not available on PM6000s sold after February 2008.

8.5. MEASURED PARAMETERS

Abbreviation	Description	Units	Formula
V_{RMS}	RMS Voltage	Volt (V)	$V_{RMS} = \sqrt{\frac{1}{T} \int_0^T v_i^2 dt}$
V_{RMN}	Rectified Mean Voltage	Volt (V)	$V_{MEAN} = \frac{1}{T} \int_0^T v dt$
A_{RMS}	RMS Current	Amp (A)	$A_{RMS} = \sqrt{\frac{1}{T} \int_0^T i_i^2 dt}$
A_{RMN}	Rectified Mean Current	Amp (A)	$A_{MEAN} = \frac{1}{T} \int_0^T i dt$
F	Frequency	Hertz (Hz)	
W	True Power	Watt (W)	$W = \frac{1}{T} \int_0^T v_i i_i dt$
PF	Power factor		$PF = \left[\frac{Watt}{V_{rms} \times A_{rms}} \right]$
VA	Apparent Power	Volt-Amps (VA)	$VA = V_{rms} \times A_{rms}$
VAr	Reactive Power	Volt-Amps (VA)	$VAr = \sqrt{VA^2 - W^2}$
V_{CF}	Voltage Crest Factor		$CF = \frac{Peak Value}{RMS Value}$
A_{CF}	Current Crest Factor		$CF = \frac{Peak Value}{RMS Value}$
V_{DF}	Voltage Distortion Factor	%	$df = \frac{\sqrt{RMS^2 - H1^2}}{REF} \times 100\%$
V_{THD}	Voltage Total Harmonic	%	$thd = \frac{\sqrt{H2^2 + H3^2 + H4^2 + H5^2 + \dots}}{REF}$

	Distortion		
V_{TIF}	Voltage Telephone Influence Factor		$V_{tif} = \frac{1}{V_{ref}} \sqrt{\sum_{\min harm}^{\max harm} k_n \times Vh_n^2}$
A_{DF}	Current Distortion Factor	%	$df = \frac{\sqrt{RMS^2 - H1^2}}{REF} \times 100\%$
A_{THD}	Current Total Harmonic Distortion	%	$thd = \frac{\sqrt{H2^2 + H3^2 + H4^2 + H5^2 + \dots}}{REF}$
A_{TIF}	Current Telephone Influence Factor		$A_{tif} = \frac{1}{V_{ref}} \sqrt{\sum_{\min harm}^{\max harm} k_n \times Ah_n^2}$
Z	Impedance	Ohm (θ)	$Z = \frac{V_{rms}}{I_{rms}}$
V_{DC}	DC Voltage	Volt (V)	$V_{DC} = \frac{1}{T} \int_0^T v dt$
A_{DC}	DC Current	Amp (A)	$A_{DC} = \frac{1}{T} \int_0^T i dt$
V_f	Fundamental Voltage	Volt (V)	$V_f = \sqrt{(V1.r^2 + V1.q^2)}$
A_f	Fundamental Current	Amp (A)	$A_f = \sqrt{(A1.r^2 + A1.q^2)}$
W_f	Fundamental Power	Watt (W)	$W_f = (V1.r \times A1.r) + (V1.q \times A1.q)$
VA_f	Fundamental Apparent Power	Volt-Amps (VA)	$VA_f = V_f \times A_f$
VA_r	Fundamental Reactive Power	Volt-Amps (VA)	$VA_r = (V1.q \times A1.r) + (V1.r \times A1.q)$

PF _f	Fundamental Power Factor		$PF_f = \cos \theta$ Where θ = phase angle
R	Resistance	Ohms (Ω)	$R = \frac{V_f}{A_f} \times \cos \theta$ (θ = phase angle)
X	Reactance	Ohms (Ω)	$X = \frac{V_f}{A_f} \times \sin \theta$ (θ = phase angle)
V _{h_n}	Voltage harmonic n	Volt (V)	$Mag = \sqrt{(V_{h_n}.r^2 + V_{h_n}.q^2)}$ $Phase = \tan^{-1} \left(\frac{V_{h_n}.q}{V_{h_n}.r} \right)$
A _{h_n}	Current harmonic n	Amp (A)	$Mag = \sqrt{(A_{h_n}.r^2 + A_{h_n}.q^2)}$ $Phase = \tan^{-1} \left(\frac{A_{h_n}.q}{A_{h_n}.r} \right)$
V _{PK}	Peak Voltage	Volt (V)	$V_{PK} = \max v \text{ or } \min v$ (Whichever magnitude is greater)
A _{PK}	Peak Current	Amp (A)	$A_{PK} = \max i \text{ or } \min i$ (Whichever magnitude is greater)

The polarity of Watts, VAR (fundamental) and PF (fundamental) are given in the table below. The displacement angle is the angle of the current fundamental with reference to the voltage fundamental.

	0°	90°	180°	270°- 360°
W	+	-	-	+
PF.f	-	-	+	+
VARs.f	+	+	-	-

There are also two ways to display the phase angle. The first is as the table above where the phase is displayed as 0 to 360°. The second is to display between $\pm 180^\circ$. In this case the phases in the table above would read 0, 90, 180, -0 to -180°

8.6. MEASUREMENT ACCURACY

The table below lists the formulae for calculating the accuracy specification for each measurement.

In the equations below

- It is assumed the waveform measured is a sine wave.
- F is the frequency measured in kHz
- V is the voltage measured in V
- I is the current measured in A
- FS_v is the full-scale value of the voltage range used for the measurement
- FS_i is the full-scale value of the current range used for the measurement (including shunt impedance)
- Z_{EXT} is the external shunt impedance (0.5Ω for 1A shunt, 10mΩ for 30A shunt)
- Θ is the phase angle in degrees (i.e. phase of the current with reference to the voltage).

All specifications are valid 23°C ±5°C

Temperature coefficient ±0.02% of reading / °C, 0 to 18°C, 28 to 40°C.

Meas	
V _{RMS}	$\text{Magnitude}(V) = 0.02\%rdg + 0.05\%mg + (Vcomp * rdg^2) + (Fcomp\% \times F)rdg + 20mV$ $\text{Phase}(\circ) = 0.005 + \left(0.0003 \times \frac{FSv}{V} \right) + \frac{0.05}{V} + 0.001 \times F$
V _{DC}	Fcomp% = 0.002% where F is less than or equal to 100kHz.
V _f	Fcomp% = 0.004% where F is greater than 100kHz.
V _{h_n}	Vcomp = 0.0002% where Vrdg >= 500V
	Vcomp = 0% where Vrdg < 500V
	Phase reported for V _f and V _{h_n} only. Phase error will be sum of phase error for measured signal and phase error of phase reference signal
	Specification valid from 500mV and higher
	Effects of common mode voltage better than:

	<p>Freq. CMRR</p> <p>60Hz -100dB</p> <p>100Hz -95dB</p> <p>1kHz -90dB</p> <p>10kHz -80dB</p> <p>100kHz-70dB</p> <p>1MHz -60dB</p> <p>5MHz -30dB</p> <p>10MHz -25dB</p>
<p>A_{RMS}</p> <p>A_{DC}</p> <p>A_f</p> <p>A_{h_n}</p>	$Magnitude(A) = 0.02\%rdg + 0.05\%rng + (Fcomp\% \times F)rdg + \frac{20\mu V}{Z_{EXT}}$ $Phase(^{\circ}) = 0.0025 + \left(0.0005 \times \frac{FSi}{I} \right) + \frac{0.00004}{I \times Z_{EXT}} + 0.0006 \times F$ <p>Fcomp% = 0.002% where F is less than or equal to 100kHz.</p> <p>Fcomp% = 0.004% where F is greater than 100kHz.</p> <p>Phase reported for A_f and A_{h_n} only. Phase error will be sum of phase error for measured signal and phase error of phase reference signal</p> <p>Specification valid from 500uV and higher (i.e. 1mA on 1A shunt, 50mA on 30A shunt)</p> <p>Effects of common mode voltage better than:</p> <p>Freq. CMRR</p> <p>60Hz -140dB</p> <p>100Hz -140B</p> <p>1kHz -138dB</p> <p>10kHz -135dB</p> <p>100kHz-120dB</p> <p>1MHz -95dB</p> <p>5MHz -60dB</p> <p>10MHz -50dB</p> <p>See Note 1.</p>
<p>V_{PK}</p>	$Error(V) = 0.08\%rdg + 0.05\%rng + (Fcomp\% \times F)rdg + 600mV$ <p>Fcomp% = 0.002% where F is less than or equal to 100kHz.</p> <p>Fcomp% = 0.004% where F is greater than 100kHz.</p> <p>See Note 2.</p>

<p>A_{PK}</p>	$Error(A) = 0.08\%rdg + 0.05\%rng + (Fcomp\% \times F)rdg + \frac{500\mu V}{Z_{EXT}}$ <p>Fcomp% = 0.002% where F is less than or equal to 100kHz. Fcomp% = 0.004% where F is greater than 100kHz. See Note 2.</p>
<p>F</p>	<p>$Error(Hz) = 0.02\%rdg$ (provided noise on signal < 12.5% range and peak of signal > 12.5% range)</p>
<p>W</p>	$Error(Watts) = \left[\frac{V_{RMS}error}{V_{RMS}} + \frac{A_{RMS}error}{A_{RMS}} + \left(\tan \theta \times \frac{Vh1_{ph}error + Ah1_{ph}error}{180} \right) \right] \times W$
<p>PF</p>	$Error = \left[\tan \theta \times \frac{Vh1_{ph}error + Ah1_{ph}error}{180} \times PF \right] \pm 0.001$
<p>VA</p>	$Error(VA) = \left[\frac{V_{RMS}error}{V_{RMS}} + \frac{A_{RMS}error}{A_{RMS}} \right] \times VA$
<p>Var</p>	$Error(VAr) = \left[\frac{V_{RMS}error}{V_{RMS}} + \frac{A_{RMS}error}{A_{RMS}} + \left(\frac{Vh1_{ph}error + Ah1_{ph}error}{\tan \theta} \times \frac{\pi}{180} \right) \right] \times VAr$
<p>V_{CF}</p>	$Error = \left[\frac{V_{PK}error}{V_{PK}} + \frac{V_{RMS}error}{V_{RMS}} \right] \times V_{CF}$ (Valid for a crest factor from of 1 to 20) See Note 2.
<p>A_{CF}</p>	$Error = \left[\frac{A_{PK}error}{A_{PK}} + \frac{A_{RMS}error}{A_{RMS}} \right] \times A_{CF}$ (Valid for a crest factor from of 1 to 20) See Note 2.
<p>V_{DF}</p>	$Error(V_{THD}) = \left[\frac{V_{RMS}error}{V_{RMS}} + \frac{Vh1_{Mag}error}{Vh1_{Mag}} \right] / V_{THD}$
<p>V_{THD}</p>	$Error(V_{THD}) = \left[\frac{Vh2_{Mag}error}{Vh2_{Mag}} + \frac{Vh3_{Mag}error}{Vh3_{Mag}} + \frac{Vh4_{Mag}error}{Vh4_{Mag}} + \dots etc \right] \times V_{THD}$
<p>V_{TIF}</p>	$Error(V_{THD}) = \left[\frac{Vh1_{Mag}error \times k_1}{Vh1_{Mag}} + \frac{Vh3_{Mag}error \times k_3}{Vh3_{Mag}} + \dots + \frac{Vh73_{Mag}error \times k_{73}}{Vh73_{Mag}} \right] \times V_{THD}$
<p>A_{DF}</p>	$Error(A_{THD}) = \left[\frac{A_{RMS}error}{A_{RMS}} + \frac{Ah1_{Mag}error}{Ah1_{Mag}} \right] / A_{THD}$
<p>A_{THD}</p>	$Error(A_{THD}) = \left[\frac{Ah2_{Mag}error}{Ah2_{Mag}} + \frac{Ah3_{Mag}error}{Ah3_{Mag}} + \frac{Ah4_{Mag}error}{Ah4_{Mag}} + \dots etc \right] \times A_{THD}$

A_{TIF}	$Error(A_{THD}) = \left[\frac{Ah1_{Mag} \text{ error} \times k_1}{Ah1_{Mag}} + \frac{Ah3_{Mag} \text{ error} \times k_3}{Ah3_{Mag}} + \dots + \frac{Ah73_{Mag} \text{ error} \times k_{73}}{Ah73_{Mag}} \right] \times A_{THD}$
Z	$Error(Ohms) = \left[\frac{V_{RMS} \text{ error}}{V_{RMS}} + \frac{A_{RMS} \text{ error}}{A_{RMS}} \right] \times Z$
Wf	$Error(Watts) = \left[\frac{Vh1_{Mag} \text{ error}}{Vh1_{Mag}} + \frac{Ah1_{Mag} \text{ error}}{Ah1_{Mag}} + \left(\tan \theta \times \sqrt{Vh1_{ph} \text{ error} + Ah1_{ph} \text{ error}} \times \frac{\pi}{180} \right) \right] \times Wf$
VAf	$Error(VAf) = \left[\frac{Vh1_{MAG} \text{ error}}{Vh1_{MAG}} + \frac{Ah1_{MAG} \text{ error}}{Ah1_{MAG}} \right] \times VAf$
$VArf$	$Error(VArf) = \left[\frac{Vh1_{MAG} \text{ error}}{Vh1_{MAG}} + \frac{Ah1_{MAG} \text{ error}}{Ah1_{MAG}} + \left(\frac{Vh1_{ph} \text{ error} + Ah1_{ph} \text{ error}}{\tan \theta} \times \frac{\pi}{180} \right) \right] \times VArf$
PFf	$Error = \tan \theta \times \sqrt{Vh1_{ph} \text{ error} + Ah1_{ph} \text{ error}} \times \frac{\pi}{180} \times PFf$
R	$Error(Ohms) = \left[\frac{Vh1_{Mag} \text{ error}}{Vh1_{Mag}} + \frac{Ah1_{Mag} \text{ error}}{Ah1_{Mag}} + \left(\tan \theta \times \sqrt{Vh1_{ph} \text{ error} + Ah1_{ph} \text{ error}} \times \frac{\pi}{180} \right) \right] \times R$
X	$Error(Ohms) = \left[\frac{Vh1_{MAG} \text{ error}}{Vh1_{MAG}} + \frac{Ah1_{MAG} \text{ error}}{Ah1_{MAG}} + \left(\frac{Vh1_{ph} \text{ error} + Ah1_{ph} \text{ error}}{\tan \theta} \times \frac{\pi}{180} \right) \right] \times X$

Notes

1. When comparing the current readings of a PM6000 without a shunt to the signals derived from an external source such as a calibration amplifier, it is essential to ensure that the calibration amplifier is loaded correctly as specified in its user manual. For example, on a Fluke 6100A, a 10 Ohm resistive load would work. Also, it is essential that the voltage input to the current channel is measured at the current terminals due to voltage drop due to the load. This is ideally done with a separate voltage measurement instrument.
2. V_{PK} , A_{PK} , V_{CF} and A_{CF} accuracy is greatly affected by noise. To obtain the specified accuracy it is required that the filter (see section 3.2.5) is set to the closest value greater than 100 times the fundamental frequency being measured in order to allow full harmonic measurements to the 100th harmonic. For example, if the signal being measured was 60Hz, then the filter should be set to 10kHz.

8.7. REGULATORY COMPLIANCE

8.7.1 Safety

EN61010:2001

8.7.2 EMC

Emissions and immunity

EN61326:1997, A1:1998

8.8. SHUNTS – 30A AND 1A

8.8.1 Mechanical Characteristics

Dimensions (Approx)

- Width: 40mm
- Height: 100mm
- Depth: 60mm

Weight (Approx)

- 250g

8.8.2 Environmental operating conditions

Dielectric Strength

- 2KVpk current inputs to case

Storage Temperature

- -20°C to +70°C

Operating Temperature

- 0°C to 40°C

Humidity

- 10 to 90% relative humidity non-condensing

8.8.3 Measurement Accuracy (30A Shunt)

Magnitude:

- $0.02\% \text{ rdg} + (0.005\% * f) \text{ rdg} + (0.00075\% * \text{rdg}^2) \text{ rdg} + 0.0001 \text{ Amps}$

Phase:

- $0.005 * f + 0.005^\circ$

where f is frequency in kHz, up to 1MHz

Shunt Resistance: 10mOhms

Temperature Coefficient: $< \pm 10\text{ppm/K}$ (20°C to 40°C)

Stability (at 125°C foil temperature): Deviation $< 0.1\%$ after 2000h

Maximum continuous rated current: 30A RMS, 250A peak

8.8.4 Measurement Accuracy (1A Shunt)

Magnitude:

- $0.02\% \text{ rdg} + (0.003\% * f) \text{ rdg} + 0.000003 \text{ Amps}$

Phase:

- $0.003 * f + 0.003^\circ$

where f is frequency in kHz, up to 10MHz

Shunt Resistance: 500mOhms

Temperature Coefficient: $< \pm 10\text{ppm/K}$ (20°C to 40°C)

Stability (at 125°C foil temperature): Deviation $<0.1\%$ after 2000h

Maximum continuous rated current: 2.5A, 5A peak

The 1A shunt module is fused at 2.5A to protect against accidental connection to 15A fused 240V mains supply.

Fuse type 2.5A HRC Anti-surge 20x5mm

Replace only with the same type and rating of fuse

9. WARRANTY, SERVICE AND UPDATES

9.1. WARRANTY

The Voltech PM6000 Power Analyzer, PM6000 Measuring Channels and PM6000 Shunts are warranted against defects in materials and workmanship for a period of twelve (12) months from the date of shipment.

In the event of failure of a customer unit during this period, Voltech will:

- At Voltech's discretion, repair or replace the faulty unit free-of-charge for a unit returned to an authorized service center. Shipment from the customer address will be the responsibility of the customer.

Voltech reserves the right to waive this benefit in any event where it is clear upon inspection that the cause of the failure is due to customer misuse.

Voltech will be the sole arbiter in this circumstance.

- Pay all return shipment charges from the Voltech service center to the customer.
- Repair/verify the customer unit before dispatch. A certificate of verification will be issued as a matter of course.

The PM6000 is a complex product and may not be completely free of errors. You are advised to verify your work. In no event will Voltech be liable for direct, indirect, special, incidental or consequential damages arising out of the use of or inability to use the PM6000 or its accessories, even if advised of the possibility of such damage. In particular, Voltech is not responsible for any lost profits or revenue, loss of use of software, loss of data, cost of substitute products, claims by third parties, or for other similar costs.

9.2. CALIBRATION AND SERVICE

To confirm the accuracy of your PM6000 and its component measuring channels and shunts, a verification check should be carried out every 12 months.

Verification is carried out using purpose-built equipment. The verification can be performed by an authorized Voltech service center.

For details of verification facilities and any other service requests, contact your supplier. Voltech strongly recommends that you discuss your service requirements with your supplier before service is needed.

9.3. OBTAINING SERVICE AND APPLICATIONS SUPPORT

Voltech personnel will be happy to help you with any query that you may have. Please e-mail your local supplier or your regional Voltech service center. E-mail address can be found at Voltech's web site (www.voltech.com).

To ensure we provide the fastest possible support, we may ask you for the serial number and firmware revisions of the PM6000, PM6000 Measuring channel or PM6000 shunt.

This information may be found in the [Config], [View Hardware] menu.

9.4. UPDATING FIRMWARE

Periodically, Voltech will make available new versions of the firmware for the PM6000. The firmware changes will include new features and fixes to any problems reported. New firmware will be made available on Voltech's web site, www.voltech.com.

The PM6000 firmware maybe upgraded over an Ethernet connection. To perform upgrade successfully, you will need:

- A PC running Windows 2000 or XP.
- A valid Ethernet network or a PC with an Ethernet port or a USB to Ethernet port adapter and an Ethernet crossover cable.

- A PC keyboard with a PS2 connector, connected to the PM6000 (required if existing firmware is version 1.06.01 or lower or if you are not using a DHCP Ethernet connection).
- The installation utility (available at www.voltech.com).
- The firmware (available at www.voltech.com).

WARNING: Care should be taken when upgrading the instrument firmware. Damage could occur if you do not follow the instructions carefully. Avoid disconnecting power or network connections during the update process.

Note: Certain firewall settings can cause the upgrade process to fail. To avoid this, please turn off your firewall before starting the upgrade process. Please remember to reactivate your firewall upon completion of the upgrade process.

For Windows XP users, the Windows firewall can be turned off by clicking on the Security Center icon on the Control Panel. From there, select Windows Firewall and then select Off.

Before starting, verify that a valid Ethernet connection is available between the PC being used for the upgrade and the PM6000 being upgraded. See section 5.1 for information on creating a valid Ethernet connection.

Next download the latest installation utility and firmware from the web. If you have an older version of the installation utility already installed, then remove it using Add/Remove program from the control panel screen before installing the newer version. Always use the latest version of the installation utility to upgrade your PM6000.

The download of the installation utility is a zip file. To install the installation utility, extract the contents of the zip file and then run setup.exe (located in the folder in to which you extracted the contents of the downloaded zip file).

A readme.txt file will be supplied with the Upgrade Utility. Please read this carefully before attempting the upgrade.

Now run the PM6000 upgrade utility by clicking on Start -> All Programs -> Voltech Software -> PM6000Upgrade. This utility will provide all the instruction you need to finish the upgrade of the firmware for the PM6000. If your PM600 has version 1.06.01 firmware or earlier and/or you do not have a DHCP Ethernet connection, then you will need a keyboard connected to the PM6000.

If the installation process fails, and you cannot restart the PM6000 normally, you should follow the upgrade instructions based on having version 1.06 firmware or lower. This will require the use of a keyboard.

WARNING: Care should be taken when upgrading the instrument firmware. Damage could occur if you do not follow the instructions carefully. Avoid disconnecting power or network connections during the update process.

10. SAFETY INFORMATION

10.1. SAFETY FEATURES

The PM6000 has been designed with safety features, such as shrouded safety connectors, that provide the operator with a high level of protection against the risk of electric shock. As with any dangerous equipment, however, it is important that an assessment of the overall risk to safety is made during installation. It is the user's responsibility to ensure compliance with any local regulations that may be applicable to the health and safety of operators

10.2. SAFETY INSTRUCTIONS



- The PM6000 and its accessories have been constructed in compliance with the requirements of EN61010-1, Pollution Degree 2, Installation Category II, FOR INDOOR USE ONLY. This ensures the safety of the analyzer and the user when normal precautions are followed
- **WARNING:** The analyzer **MUST** be earthed. The power source should be inserted in a socket with a protective ground contact
- The power source should be inserted before connections are made to measuring or control circuits
- Do not attempt to remove outer cover without first disconnecting auxiliary and test power supply
- This instrument must only be serviced by qualified personnel who understand the danger of shock hazards
- When the instrument is removed from its case hazardous voltages are present
- The electronic circuitry of this instrument is fully floating with respect to ground. If the instrument is opened and dangerous voltages (above 50V peak) applied to the input terminals then all the circuitry must be considered 'Live'
- The signal leads must be in good condition with no damage.
- Replace fuses only with the same type and rating as specified in this manual

11. RELEASE HISTORY

Firmware issue 1.08.02; Manual Issue 7

- IEC61000 Current Harmonics and Flicker added to the PM6000 to be used in conjunction with the IEC61000 Software for the PM6000.
- Help System enhanced.
- VTIF and ATIF distortion measurements added (3.2.10).
- PC to PM6000 Ethernet connection details added to the manual (5.1).

Firmware issue 1.09.02; Manual Issue 8

- Note added about needing a 200mS delay between each command sent to the PM6000 (section 4.3).
- Examples of commands needed to get results from the PM6000 added (4.14).

Firmware issue 1.10.03; Manual Issue 9

- Specification for peak voltage and current updated
- User configurations added
- Math editor enhanced

Firmware issue 1.13.05; Manual Issue 10

- Added positive and negative peak voltage and current to the measurements menu.
- Fixed bug with trigger menu
- Fixed bug with the HMX command
- Fixed bug with data logging with respect to groups and channels

Firmware issue 1.17.05; Manual Issue 11

- Changes made to work with IEC software changes.
- Information about lead set now being included added to manual.

Firmware issue 1.17.05; Manual Issue 12

- V_{RMS} , V_{DC} , V_f , V_{h_n} specification changed.
- A_{RMS} , A_{DC} , A_f , A_{h_n} specification changed.
- 30A shunt specification changed.

Firmware issue 1.19.06; Manual Issue 13

- Ethernet comms added
- Code change to support the removal of the floppy drive from the product.

Firmware issue 1.20.06RC4; Manual Issue 14

- Information on USB to Ethernet adapter added.
- Firmware changed to support PM6000 analog card serial numbers on IEC software results.
- Manual change to reflect the removal of the floppy disk from the PM6000.

Firmware issue 1.20.06RC4; Manual Issue 15

V_{RMS} , V_{DC} , V_f , V_{h_n} specification changed.

Firmware issue 1.20.06RC4; Manual Issue 16

Reference to PM6 VPAS software added.

Firmware issue 1.20.06RC4; Manual Issue 17

- Note added to the specification section detailing loading connections for current measurements when no shunt is fitted.
- Note added to the specification section detailing the setting of the filter for V_{PK} , A_{PK} , V_{CF} and A_{CF} measurements.
- Crest Factor range clarified in section 8.6

Firmware issue 1.21.07RC2; Manual Issue 18

- Auto range command for voltage and current was modified from "AUTO" to "AUT" to reflect the actual performance of the instrument.

- The location of the over range bits for voltage and current in the background status register (section 4.6.2) were incorrect. Bits 3 and 4 were reversed. The manual has been corrected.
- BRD?, FRD?, BRF? and FRF? enhanced to returned return results from multiple groups.

A

Amps Distortion Factor	3-23
Amps Harmonics	3-20
Amps Peak	3-25
Amps Scaling	3-7
Amps THD	3-23
Amps TIF	3-24
Anonymous or User login	5-3
Auto Up Only	3-6
Auto Zero	3-35
Averaging	3-27

B

Baud Rate	3-38
Blanking	3-31

C

Calibration and Service	9-2
Config	3-33
Config Beeper	3-35
Config Clock	3-34
Config Zero	3-35
Configuration Commands (:CFG command)	4-32
Connecting to the PM6000	5-4
Connecting to the PM6000 using ethernet 5- 1	
Coupling	3-6

D

Data	3-41
DATA DUMP	3-45
data log file	3-18
Datalog	3-15
Depth	3-27

Direct Connection Method	5-1
Display Amps Range	3-6
Display Columns	3-28
Display Volts Range	3-6

E

Echo	3-38
Ethernet	3-38
Interfacing	4-1
Port	8-7
External	3-9
External input	8-4
External Keyboard and Mouse	8-6
External Monitor	8-6
External Shunt Scaling mV/A	3-7

F

Features & Abilities	1-1
File Location	3-18
Filter	3-8
Finding your way around	5-5
firewall	5-3
FITTING OPTIONS	6-1
Fix IP Address	3-39
Fixed Frequency	3-9
Floppy Disk	8-8
Format	3-27
Format Commands	4-9
Format Floppy Disk	3-42
Freq source	3-12
Frequency Source	3-8
FTP	5-3

G

Getting Started	2-1
Graph	3-32

graph time base.....	3-32	Menu 1, 2, 3	3-44
Grid.....	3-31	Menu Items	3-2
Group Name	3-4	Menu System	3-1
H			
Harmonic Results as Percent	3-32	Minimum Fundamental Frequency ..	3-11
Harmonic Scaling	3-12	Mode	3-10
Harmonics	3-19	N	
Help	3-44	Navigating the Menu System.....	2-1
HF Ballast (AM).....	3-11	Network Connection Method.....	5-1
HOLD.....	3-45	Normal	3-10
I			
IEC 61000-3	7-1	O	
IEEE488.2 Common Commands	4-5	Obtaining Service and Applications	
INP Commands	4-36	Support.....	9-2
INST Commands.....	4-37	ODD and EVEN.....	3-20
INTEG RUN	3-45	Options.....	1-4
Integrator	3-13	P	
Interface.....	3-38	Parallel	3-39
Interfacing with GPIB systems.....	4-1	Parallel Port	8-5
Interfacing with RS232 Systems	4-1	PCMCIA	3-39
L			
Load Configuration	3-33	PCMCIA Cards.....	6-1
Log Interval Time.....	3-17	Peripheral Ports.....	8-5
Low Frequency.....	3-9	Phase	3-20
M			
Math	3-28	Phase Reference.....	3-9
MAX / MIN Hold.....	3-26	Power Analysis Software.....	7-1
Measured Parameters	8-9	PRINT.....	3-46
Measurement	3-19	Printing	3-40
Measurement Accuracy.....	8-12	PWM Output.....	3-10
Measurement Display.....	2-3	R	
Mechanical and Environment.....	8-3	Range	3-5
Menu.....	3-44	Regulatory Compliance	8-16
		Release History	11-1
		Remote Access.....	5-1
		Remote Command Syntax and Conventions	
		4-2

Remote Operation	4-1	Trigger T1 to T6	3-42
RESET / CLEAR	3-45	Trigger T1 to T6 Timed.....	3-43
Reset Default.....	3-34	Trigger T2	3-42
S		U	
Safety Features	10-1	Updating Firmware.....	9-2
Safety Information	10-1	USB Slave Port.....	8-7
Safety Instructions.....	10-1	USB-6009	7-1
Save Configuration.....	3-33	User.....	3-44
Scaling.....	3-7	V	
Self Test	3-44	View Hardware.....	3-34
SENS Commands.....	4-40	View Settings.....	3-34, 3-39
Serial Port.....	8-5	Voltech Shunts.....	2-9, 6-1
Set IP using DHCP	3-39	Volts Distortion Factor	3-21
Shunts – 30A and 1A	8-17	Volts Harmonics	3-20
Software	7-1	Volts Peak.....	3-25
Specification.....	8-3	Volts Scaling	3-7
Sum	3-19	Volts THD.....	3-21
SYST Commands.....	4-41	Volts TIF.....	3-22
System Upgrade	3-37	W	
T		Warranty	9-1
three-phase 7-wire configuration	2-6	Watts Harmonics	3-19
To connect a transducer with a current		Wiring and Groups	2-4
output only	2-9	Wiring Setup.....	3-3
To connect a transducer with a voltage		Z	
output	2-9	Zoom.....	3-27
To connect an external resistive shunt ...	2-8		
Trigger.....	3-14, 3-17, 3-42		