

# USER'S MANUAL

## Pulse Generator PG-1275E

Rev 2

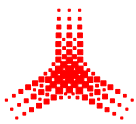



|            |  |           |
|------------|--|-----------|
| <b>1.</b>  | <b>INTRODUCTION .....</b>                                  | <b>3</b>  |
| <b>2.</b>  | <b>SAFETY PRECAUTIONS .....</b>                            | <b>3</b>  |
| <b>3.</b>  | <b>DESCRIPTION OF THE GENERATOR PG-1275E.....</b>          | <b>5</b>  |
| 3.1        | GENERATOR INSTALLATION .....                               | 5         |
| 3.2        | PICTURES OF THE EQUIPMENT .....                            | 5         |
| 3.3        | FRONT PANEL.....   | 6         |
| 3.3.1      | <i>NAVIGATION IN MENU :</i> .....                          | 7         |
| 3.3.2      | <i>MAIN MENU DISPLAY:</i> .....                            | 7         |
| 3.3.3      | <i>Injected SPIKES configuration menu:</i> .....           | 7         |
| 3.3.4      | <i>Injected surge configuration menu:</i> .....            | 7         |
| 3.3.5      | <i>ERRORS listing:</i> .....                               | 8         |
| 3.4        | REAR PANEL.....  | 9         |
| <b>4.</b>  | <b>HOW TO USE THE TEST EQUIPMENT .....</b>                 | <b>10</b> |
| 4.1        | INJECTED SPIKES PROCEDURE.....                             | 10        |
| 4.1.1      | <i>Calibration spikes</i> .....                            | 10        |
| 4.1.2      | <i>Testing spikes</i> .....                                | 10        |
| 4.2        | INJECTED SURGES PROCEDURE.....                             | 11        |
| 4.2.1      | <i>Calibration surges</i> .....                            | 11        |
| 4.2.2      | <i>Testing surges</i> .....                                | 11        |
| 4.3        | PULSE ENERGY LIMITATION .....                              | 12        |
| 4.3.1      | <i>Energy for the spikes test</i> .....                    | 12        |
| 4.3.2      | <i>Energy for the surges test</i> .....                    | 12        |
| 4.4        | REMARKS.....   | 13        |
| <b>5.</b>  | <b>SPIKES TEST SETUPS.....</b>                             | <b>14</b> |
| 5.1        | SPIKES CALIBRATION .....                                   | 14        |
| 5.2        | SPIKES TESTING .....                                       | 14        |
| <b>6.</b>  | <b>SURGES TEST SETUP .....</b>                             | <b>15</b> |
| 6.1        | SURGES CALIBRATION.....                                    | 15        |
| 6.2        | SURGES TESTING WITH INTERNAL DECOUPLING DIODE .....        | 16        |
| 6.3        | SURGES TESTING WITH EXTERNAL DIODE MODULE (OPTIONAL) ..... | 16        |
| <b>7.</b>  | <b>SPECIFICATIONS .....</b>                                | <b>17</b> |
| <b>8.</b>  | <b>GENERATED SIGNALS .....</b>                             | <b>18</b> |
| 8.1        | SPIKES.....  | 18        |
| 8.2        | SURGES.....  | 19        |
| <b>9.</b>  | <b>REMOTE CONTROL .....</b>                                | <b>20</b> |
| 9.1        | LIST OF COMMANDS .....                                     | 20        |
| 9.2        | SYNTAX TO SEND A COMMAND .....                             | 21        |
| 9.3        | QUERY FORM SYNTAX.....                                     | 21        |
| <b>10.</b> | <b>MAINTENANCE.....</b>                                    | <b>22</b> |
| <b>11.</b> | <b>SERVICING.....</b>                                      | <b>22</b> |



## USER'S MANUAL

### PULSE GENERATOR PG-1275E

## 1. Introduction

This document includes the technical specifications and the instructions for use of the pulse generator PG-1275E.

This equipment allows performing the following tests according to MIL-STD 1275E.

- Injected spikes
- Injected surges

Nominal operating voltage of electrical device under test (EUT) is 28 V.

Surge charging voltage is 200 V max.

Spike charging voltage is 2000 V max.

Nominal EUT current is limited to 16 A DC (400 A DC with optional external diode module).

## 2. Safety precautions

The following safety precautions should be observed before using this product and any associated accessories. Although some instruments and accessories would normally be used with non-hazardous voltages, there are situations where hazardous conditions may be however present. Exercise extreme caution when a shock hazard is present. Lethal voltages are present on connectors and inside the test equipment.

This product is intended for use by qualified personnel only. These should recognize high voltage and be familiar with the safety precautions required to avoid possible injury. Read the operating manual carefully before using the product.

Before operating the instrument, make sure the line cord is connected to a properly grounded power receptacle. Always connect the test equipment to a good earth. Inspect the connecting cables and test leads for possible wear, cracks or breaks before each use. For maximum safety, do not touch the product, the test cables or any other accessory while power is applied to the circuit under test. Always remove power from the entire test system before: connecting or disconnecting cables, working on the device or on the equipment under test. Never disconnect conductors carrying current.

Be careful while connecting / disconnecting batteries; these contain high level of energy and when connected in series, may provide dangerous voltages. Never short the batteries terminal even by accident (i.e. by leaving a tool falling on it).

Don't work alone. In the event of an emergency, another person's presence may be essential. Be aware of emergency procedures to follow in case of accident. Workers using a heart pacemaker or similar devices should not be present in the vicinity of the test equipment.

In case of emergency push the red knob "emergency".



# montena

The instrument and accessories must be used in accordance with their specifications and operating instructions otherwise the safety of the equipment may be impaired. Replace fuses with same type and rating for continued protection against fire hazard.

If a screw labelled  is present, connect it to safety earth using a short conductor having a section of minimum 4 mm<sup>2</sup>.

The  symbol on an instrument indicates that the user should refer to the operating instructions located in the manual.

The  symbol on an instrument shows that it can source or measure 1'000 volts or more, including the combined effect of normal and common mode voltages.

High electromagnetic disturbances are produced by the PG-1275E. Sensitive electronic equipment placed in the vicinity may be disturbed.

Do not operate the test equipment in an explosive environment or in wet conditions.

The access of personnel may be restricted in the test area containing the PG-1275E and the EUT. The access may be controlled by safety barriers or by using a separate room. The doors can be fitted out with safety switches. All safety switches can be connected in series and the resulting safety circuit can be connected to the interlock connector of the test equipment. If a door is opened, the interlock circuit is opened and the generator is put in a safe mode.

To maintain protection from electric shock and fire, spare parts in mains circuits, including the power transformer, test leads, and connectors, must be purchased from montena. Standard fuses, with applicable national safety approvals, may be used if the rating and type are the same. Other components that are not safety or high voltage related may be purchased from other suppliers as long as they are equivalent to the original component. Note that selected parts should be purchased only through montena to maintain accuracy and functionality of the product.

To clean the test equipment, use a damp cloth or mild, water based cleaner. Clean the exterior of the instrument only. Do not apply cleaner directly to the instrument or allow liquids to enter or spill on the instrument.

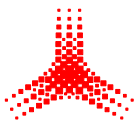

## 3. Description of the generator PG-1275E

### 3.1 Generator installation

Keep clearance on front and rear sides of the generator; this is mandatory to keep space for cooling fan airflow. At least 8 cm should be kept from generator sides to walls or other equipment.

### 3.2 Pictures of the equipment



Generator (included)



400 A decoupling diode module (optional)



Calibration resistor 0.5  $\Omega$  (included)



3x test cable  
2 m, I<sub>max</sub> 32 A  
3x test cables  
1 m, I<sub>max</sub> 32 A

Cable set (included)



Typical LISN (optional)



Typical differential voltage probe (optional)



## 3.3 Front panel



Figure 1 : Front panel of the PG-1275E

- PULSE:** Button to release the defined pulses. Pulse button is enabled only in READY state, High Voltage being ON. Pulse button is also used to pause the pulses. A short press continues the test; a long press resets the counter.
- HIGH VOLTAGE:** Button to switch the high voltage ON and OFF. Red light indicates the high voltage is active. Charging is enabled according to set value. High voltage OFF stops the test when running. High voltage automatically resets to OFF after 10 minutes of no activity on panel buttons.
- MENU / LOCAL:** Button to display the main menu or to return from remote to local mode.
- INTERLOCK:** Indicator of the interlock circuit state: light is ON if the circuit is open (safety circuit not OK).
- EMERGENCY:** Emergency knob: when pushing the knob, the PG-1275E switches off. Display is blank, high voltage is OFF. To reset, rotate the knob clockwise (see arrows on button).
- CONTROL:** Control knob. Rotate to select the item. Press the button to enter in the menu or to validate the selected value.

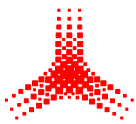

### 3.3.1 NAVIGATION IN MENU :

|              |   |
|--------------|---|
| CONTROL      | <b>Turn</b> to move the cursor ><br><b>Push</b> to select the desired function<br><b>Turn</b> to adjust the value of the selected function<br>☞ <b>Pushing down the button during rotating enables fine tuning.</b><br><b>Push</b> to return to the main view |
| MENU / LOCAL | <b>Push</b> to go to the "Choose Generator" menu<br><b>Push</b> to change to local mode when remote mode is activated   |

### 3.3.2 MAIN MENU DISPLAY:

|   |   |
|---|---|
| <b>Choose Generator</b><br>>SPIKES<br>SURGE | When selected, enters in the injected spikes menu<br>When selected, enters in the injected surge menu |
|---|---|

### 3.3.3 INJECTED SPIKES CONFIGURATION MENU:

|                    |   |
|--------------------|---|
| >Volt. : 500V 500V | Voltage setting from 0 to 2000V (left) and actual voltage (right)           |
| Period: 1.0 s      | Time between two pulses, from 1.0 to 9.9 seconds                            |
| Pulses: 0/50       | Number of pulses: setting 1 to 99 (right side) / Actual counter (left side) |
| SPIKES : Standby L | Actual generator modus and Local (L) or Remote (R) status                   |

### 3.3.4 INJECTED SURGE CONFIGURATION MENU:

|                    |  |
|--------------------|--|
| >Volt. : 200V 200V | Voltage setting from 0 to 200V (left) and actual voltage (right)           |
| Period: 5 s        | Time between two pulses, from 5 to 60 seconds                              |
| Pulses: 0/5        | Number of pulses: setting 1 to 5 (right side) / Actual counter (left side) |
| SURGE : Standby L  | Actual generator modus and Local (L) or Remote (R) status                  |

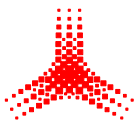

### 3.3.5 ERRORS listing:

| <i>Display</i> | <i>Error</i>  | <i>Action</i>   |
|----------------|---|---|
| <b>Error01</b> | Generator too hot   | Wait at least 10 minutes for cooling of the generator<br>This error resets automatically as soon as the temperature decreased to an acceptable value.   |
| <b>Error02</b> | External diode module too hot<br>(only if optional diode module is present) | Immediately switch OFF the <b>EUT power</b> and wait 10 minutes for the diode module to cool down. <b>DO NOT SWITCH OFF THE GENERATOR</b> as it provides the supply of the diode module fan.<br>To deactivate the buzzer, press any button.<br>This error resets automatically as soon as the temperature decreased to an acceptable value. |
| <b>Error03</b> | Charging of surge capacitors failed   | This error can occur if the surge capacitors cannot be charged as expected. It might be related to a too low mains voltage (230V) or to an internal problem. Try to reduce the set voltage and press the HIGH VOLTAGE button again to reset this error.   |



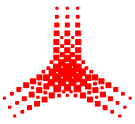

## 3.4 Rear panel

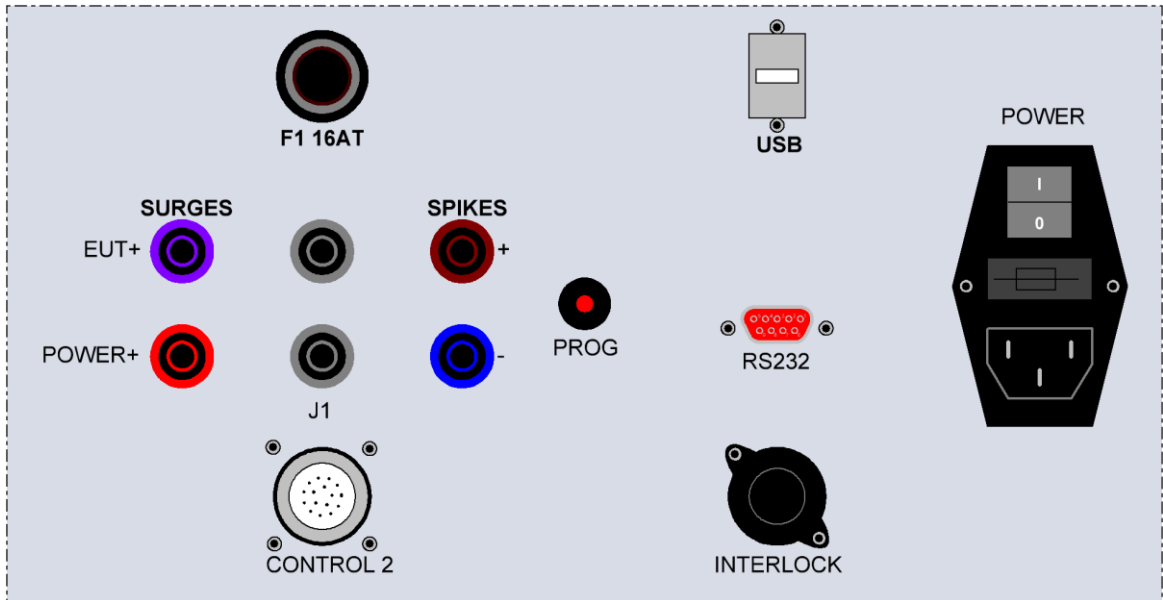
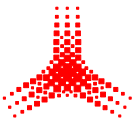

Figure 2: Rear panel of the PG-1275E

|                      |  |
|----------------------|--|
| <b>POWER:</b>        | Mains supply connector with fuse and switch  |
| <b>RS-232:</b>       | SUB-D9 female for RS232 remote operation.  |
| <b>USB:</b>          | USB serial port for remote operation.  |
| <b>INTERLOCK:</b>    | <b>Interlock input.</b><br>All safety switches must be connected in series between pins 1 and 2 to allow the PG-1275E to work. Switch between 1 and 2 closed = PG-1275E can be operated.   |
| <b>CONTROL 2</b>     | Control signals for the optional external diode module   |
| <b>SPIKES +</b>      | Positive output, connect to EUT+ for positive spike, respectively to EUT- for negative spike polarity  |
| <b>SPIKES -</b>      | Negative output, connect to EUT- for positive spike, respectively to EUT+ for negative spike polarity  |
| <b>SURGES EUT+</b>   | EUT side output for surges. Connect to the positive terminal of the EUT or to the EUT+ plug of the external diode module   |
| <b>SURGES POWER+</b> | Power supply output for surges. Connect to the positive terminal of the power supply or to the POWER+ plug of the external diode module<br><i>Corresponding fuse: F1, 16AT, (6.3x32mm)</i> |
| <b>J1</b>            | Jumper (grey colour) for the use of the internal decoupling diode<br>→ Remove when an external diode module is used.   |
| <b>PROG</b>          | Button for firmware update, for service only   |



## 4. How to use the test equipment

### 4.1 Injected spikes procedure

#### 4.1.1 Calibration spikes

- Prepare the setup according to §5.1  
As the cable length has a negative impact on the rise time, the connections between generator and probe must be kept short.
- Set the oscilloscope and the voltage probe with the desired parameters.
- Connect the mains supply cable of the PG-1275E.
- Make sure the emergency knob is released (pulled).
- Switch on the PG-1275E (rear side)
- Choose the "SPIKES" generator in the main menu
- Set the voltage of the generator to about 1000 V
- Press the HIGH VOLTAGE button
- Press the PULSE button
- Adjust the oscilloscope parameters if needed
- Gently increase the Set voltage in order to get the expected +250 V peak value on the measurement
- Check the amplitude, rise time and oscillation frequency and compare to the standard
- Write down the generator positive "Set" voltage for future testing

#### 4.1.2 Testing spikes

- Prepare the setup according to §5.2 or **Erreur ! Source du renvoi introuvable.**
- If present set the oscilloscope and the voltage probe with the desired parameters
- Connect the mains supply cable of the PG-1275E.
- Make sure the emergency knob is released (pulled).
- Switch on the PG-1275E (rear side)
- Switch on the EUT
- Choose the "SPIKES" generator in the main menu
- Set the voltage of the generator to about 1000 V
- Press the HIGH VOLTAGE button
- Press the PULSE button
- Adjust the oscilloscope parameters if needed
- Gently increase the Set voltage up to value noted during the calibration for positive polarity, but not above the maximum pulse energy (see §4.3).
- Apply the required number of pulses with the required repetition period.
- Verify the EUT operates as specified while subjected to the voltage spikes. Any deviation from normal operation shall be recognized as a failure of the EUT
- Repeat the former steps with negative polarity



## 4.2 Injected surges procedure

### 4.2.1 Calibration surges

- Prepare the setup according to §6.1 with the calibration resistor 0.5  $\Omega$
- Set the oscilloscope and the voltage probe with the desired parameters
- Connect the mains supply cable of the PG-1275E.
- Make sure the emergency knob is released (pulled).
- Switch on the PG-1275E (rear side)
- Choose the "SURGE" generator in the main menu
- Set the voltage of the generator to about +100 V
- Press the HIGH VOLTAGE button
- Press the PULSE button
- Adjust the oscilloscope parameters if needed
- Gently increase the Set voltage in order to get the expected +70 V peak value on the measurement
- Check the amplitude, rise time and duration and compare to the standard
- Write down the generator "Set" voltage for future testing

### 4.2.2 Testing surges

- Prepare the setup according to §6.2 or 6.3
- Disable the EUT power switch, if any.
- If present, connect the external optional diode module. Cooling fan must start to blow air. It is important to prevent the EUT to draw current from diode module before to have the cooling fan in operation. There is some risk of overheating the diode module!
- Make sure to use conductors with cross-sections according to the EUT maximum power.
- Set the oscilloscope and the voltage probe with the desired parameters
- Connect the mains supply cable of the PG-1275E.
- Make sure the emergency knob is released (pulled).
- Switch on the PG-1275E (rear side)
- Switch on the EUT
- Choose the "SURGE" generator in the main menu
- Set the voltage of the generator to about +100 V
- Press the HIGH VOLTAGE button
- Press the PULSE button
- Adjust the oscilloscope parameters if needed
- Gently increase the Set voltage up to value noted during the calibration, but not above the maximum pulse energy (see §4.3). Check also the measured voltage as it can be higher than during calibration with the 500 m $\Omega$  calibration load.
- Apply the required number of pulses with the required repetition period.
- Verify the EUT operates as specified while subjected to the voltage spikes. Any deviation from normal operation shall be recognized as a failure of the EUT

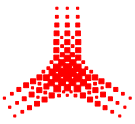

## 4.3 Pulse energy limitation

The MIL-STD-1275 version E defines a limitation of the energy applied to the EUT:

2 J for the spikes test  
60 J for the surges test

### 4.3.1 Energy for the spikes test

The maximum stored energy of the generator at 2000 V charging voltage is about 4 J. In the worst case, assuming the efficiency of the generator circuit is perfect, 50% of this energy, that is 2 J, could be delivered to the EUT.

As this value is not higher than the MIL-STD-1275 limitation of 2 J, there is no need to monitor the injected energy.

### 4.3.2 Energy for the surges test

The maximum stored energy of the generator at 200 V charging voltage is about 300 J. In the worst case, 50% of this energy. That is 150 J, could be delivered to the EUT.

As this value is higher than the MIL-STD-1275 limitation, the injected energy must be monitored.

This energy can be calculated by the oscilloscope, using the differential voltage probe and current probe signals. The oscilloscope must be capable of multiplying and integrating the two signals,

$$E(t) = \int u(t) \cdot i(t) \cdot dt$$

The charging voltage of the PG1275E generator is to be adjusted until the calibrated injection level is obtained, while not exceeding the maximum total energy content of a single surge of 60 Joules.



## 4.4 Remarks

- To interrupt a test, press the pulse button. The test will recover with a short press of the pulse button. A long press will reset the pulses counter.
- To cancel a test, press the "HIGH VOLTAGE" button off.
- In case of emergency, press the emergency button (note that the cooling fan is always blowing even in emergency to prevent overheating of PG-1275E components).
- At the end of the test session, press the button "HIGH VOLTAGE" to set the generator in standby mode. The red light is off. Note that the generator will automatically return to standby mode after 10 minutes without activity.
- To reset the emergency circuit, rotate the "EMERGENCY" button clockwise.
- To return in the local mode, press the "LOCAL" button.
- To control the generator with a computer, connect a RS232 or USB cable to the rear side. The connector and the cable must be correctly shielded.
- Maximum surge voltage is over 100 V; this voltage level may cause electrical shocks. Do not touch conductors during the surge setup.
- Do not shorten the batteries terminals; in general, follow batteries safety instructions.
- MIL 1275 tests may create EUT malfunctions that are dangerous for the operators. Always take all required safety precaution to prevent injuries.
- To change the spikes polarity, exchange both wires from the generator from the generator output

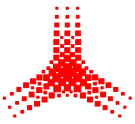

## 5. Spikes test setups

### 5.1 Spikes calibration

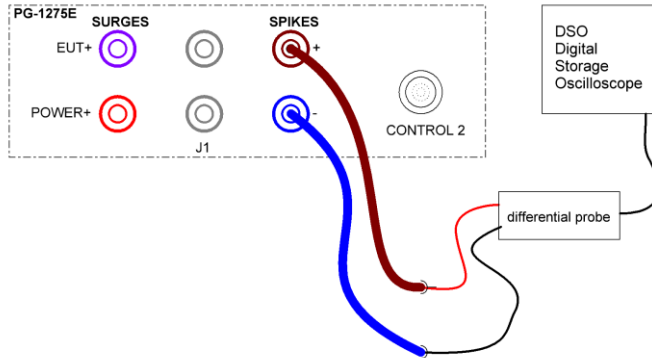

### 5.2 Spikes testing

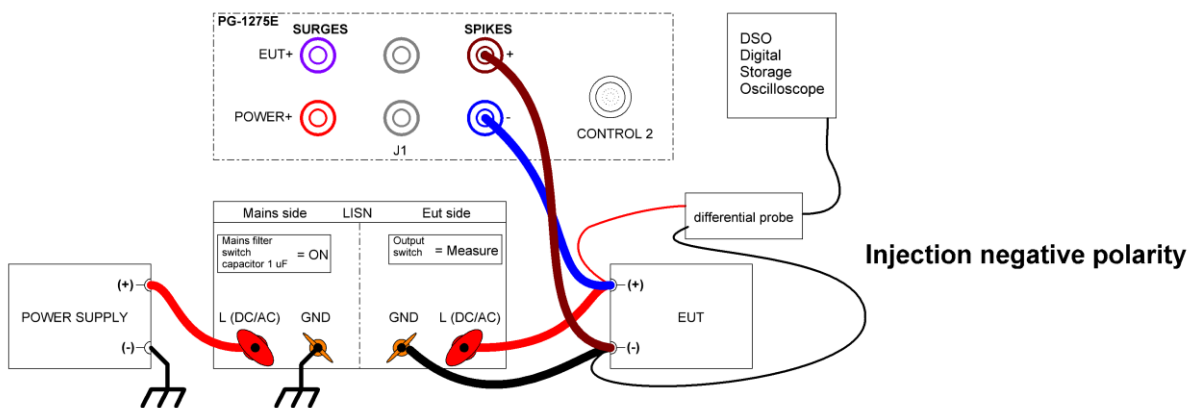
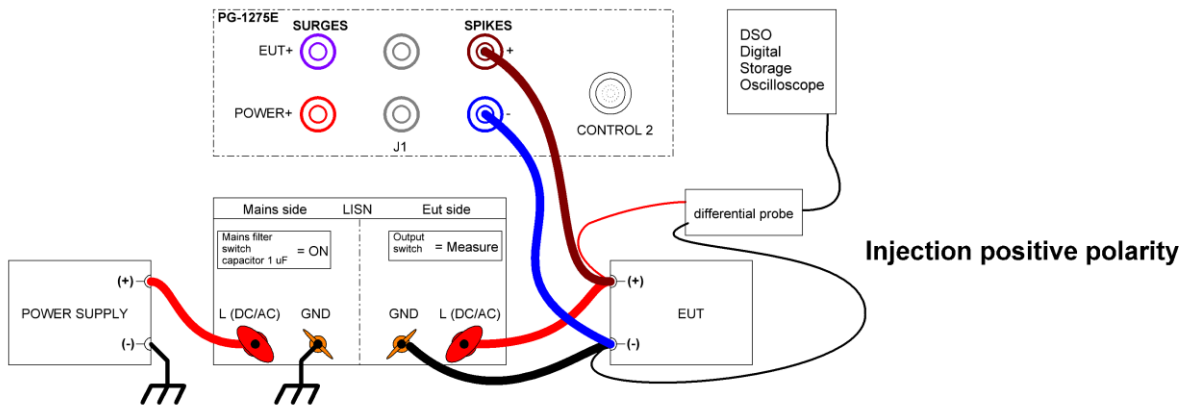

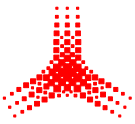

## 6. Surges test setup

### 6.1 Surges calibration

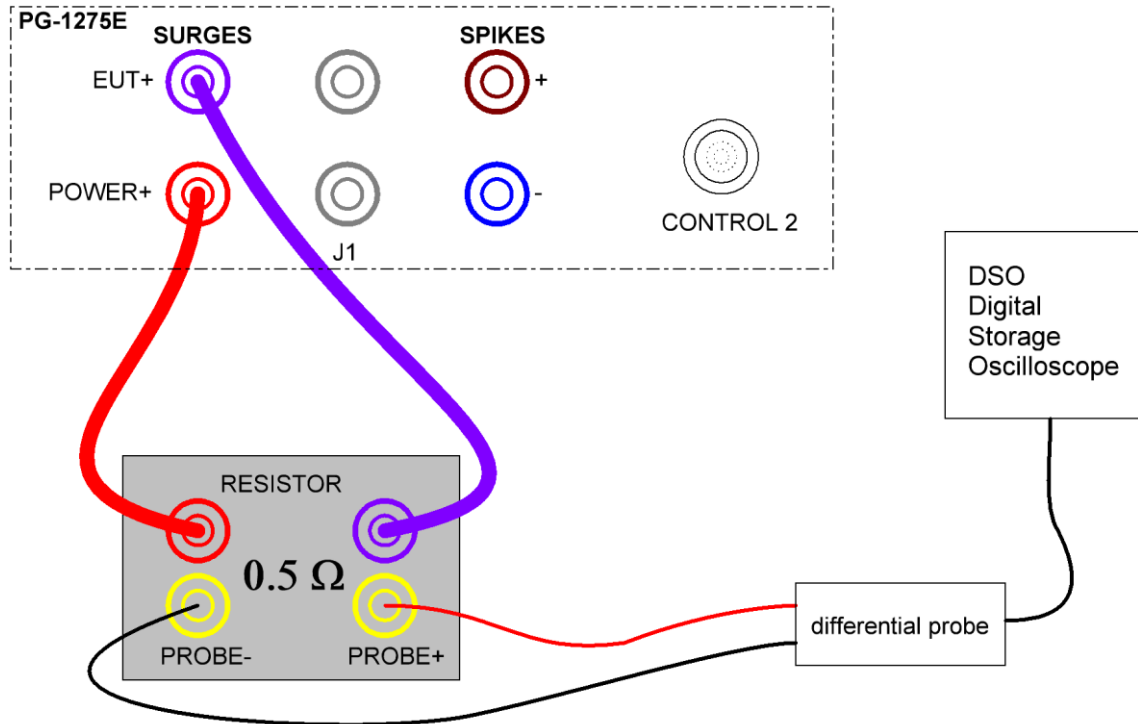



## 6.2 Surges testing with internal decoupling diode

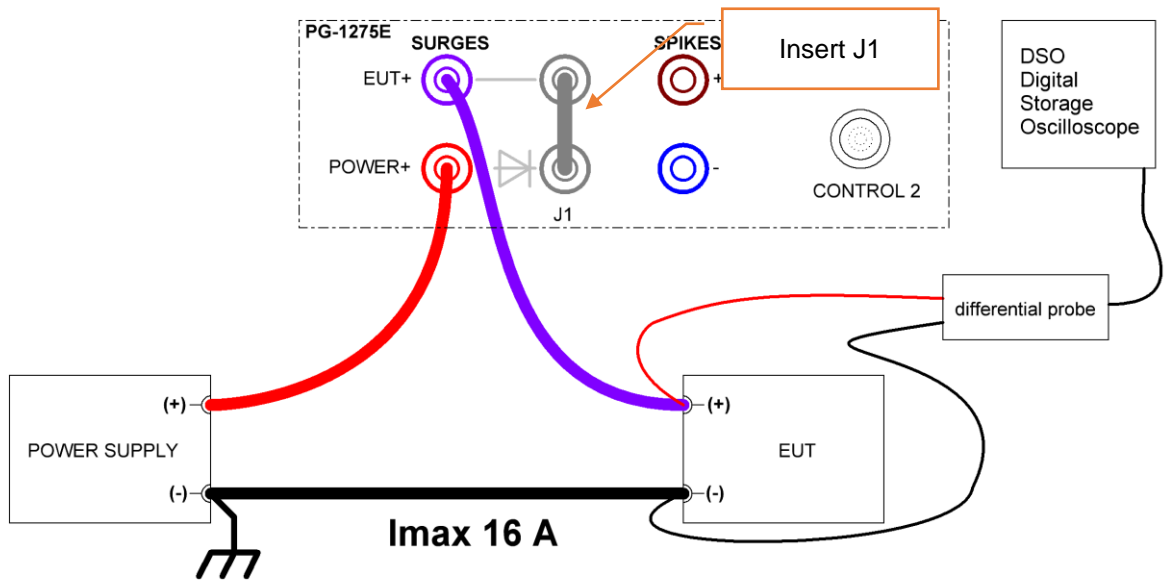

- Insert J1

## 6.3 Surges testing with external diode module (optional)

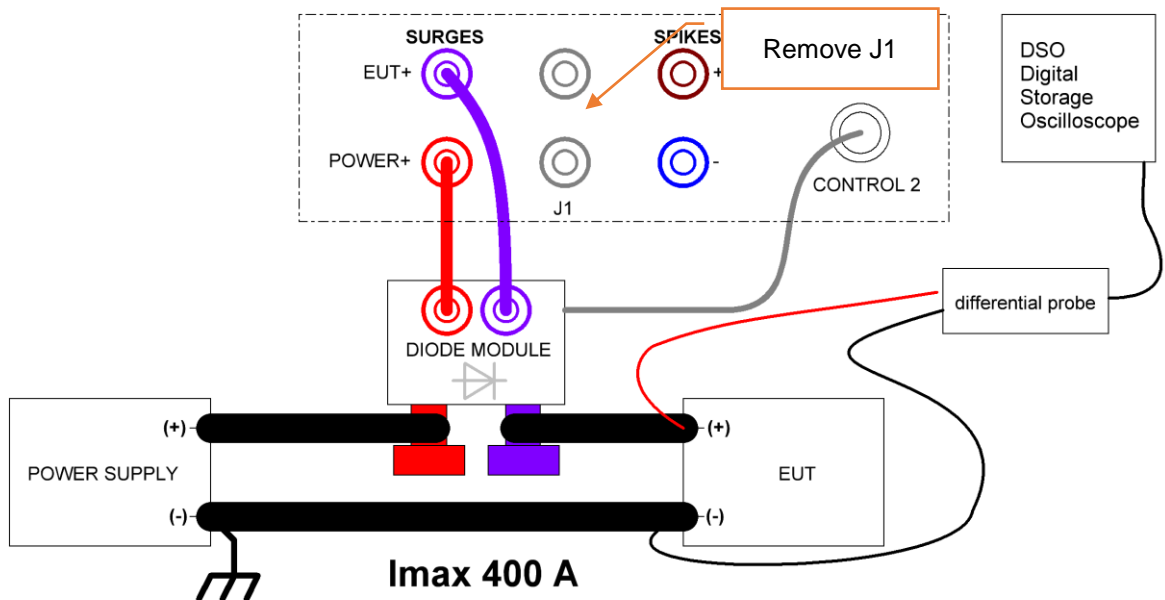

- Remove J1
- Connect CONTROL 2



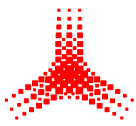

## 7. Specifications

|  |  |
|--|--|
| <b>Standard</b>  | MIL-STD-1275E  |
| <b>Type</b>  | Injected Spikes and surges   |
| <b>Generator name</b>  | PG-1275E   |
| <b>Vehicle generator and EUT operating voltage</b>               | 28 V typ, 23 V min, 33 V max.  |
| <b>Spikes charging voltage</b>                                   | 2000 V max.  |
| <b>Spikes maximum open circuit voltage</b>                       | 260 V  |
| <b>Spikes maximum energy</b>                                     | < 2 J  |
| <b>Spikes rise time</b>  | 35 ns typ, open circuit or 50 $\Omega$   |
| <b>Spikes frequency</b>  | 100 kHz typ. Open circuit  |
| <b>Spikes count</b>  | 1 to 99 spikes per burst   |
| <b>Spikes period</b>   | 1.0 s to 9.9 s   |
| <b>Spikes output connector</b>                                   | 2 x 4 mm safety socket   |
| <b>EUT operating current for spikes</b>                          | Depending on the optional LISN   |
| <b>Surges charging &amp; open circuit voltage</b>                | 200 V max.   |
| <b>Surges maximum energy</b>                                     | < 150 J  |
| <b>Surges output impedance</b>                                   | 500 m $\Omega$ (-25 m $\Omega$ / +0 m $\Omega$ )   |
| <b>Surges pulse duration at 10% of peak</b>                      | 50 – 55 ms   |
| <b>Surges count</b>  | 1 to 5 pulses per burst  |
| <b>Surges period</b>   | 5 s to 60 s  |
| <b>Surges output connectors</b>                                  | 2 x 4 mm safety socket   |
| <b>EUT operating current for surges</b>                          | 16 A max.<br>400 A with optional external diode module   |
| <b>Interface</b>   | RS 232 or USB  |
| <b>Mains operating voltage</b><br>Configured in factory, either: | <input type="checkbox"/> 100 V min. to 130 V max. 50 - 60 Hz, or<br><input type="checkbox"/> 210 V min. to 264 V max. 50 – 60 Hz |
| <b>Power rating</b>  | 100 W  |
| <b>Operating temperature</b>                                     | 10 to 40° C  |
| <b>Dimensions</b>  | 610 x 450 x 200 mm (L x W x H)   |
| <b>Weight</b>  | 22 kg  |

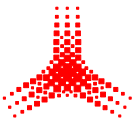

## 8. Generated signals

### 8.1 Spikes

Test conditions :

- EUT : no load (only the measurement probe)
- EUT supply voltage : 0 V

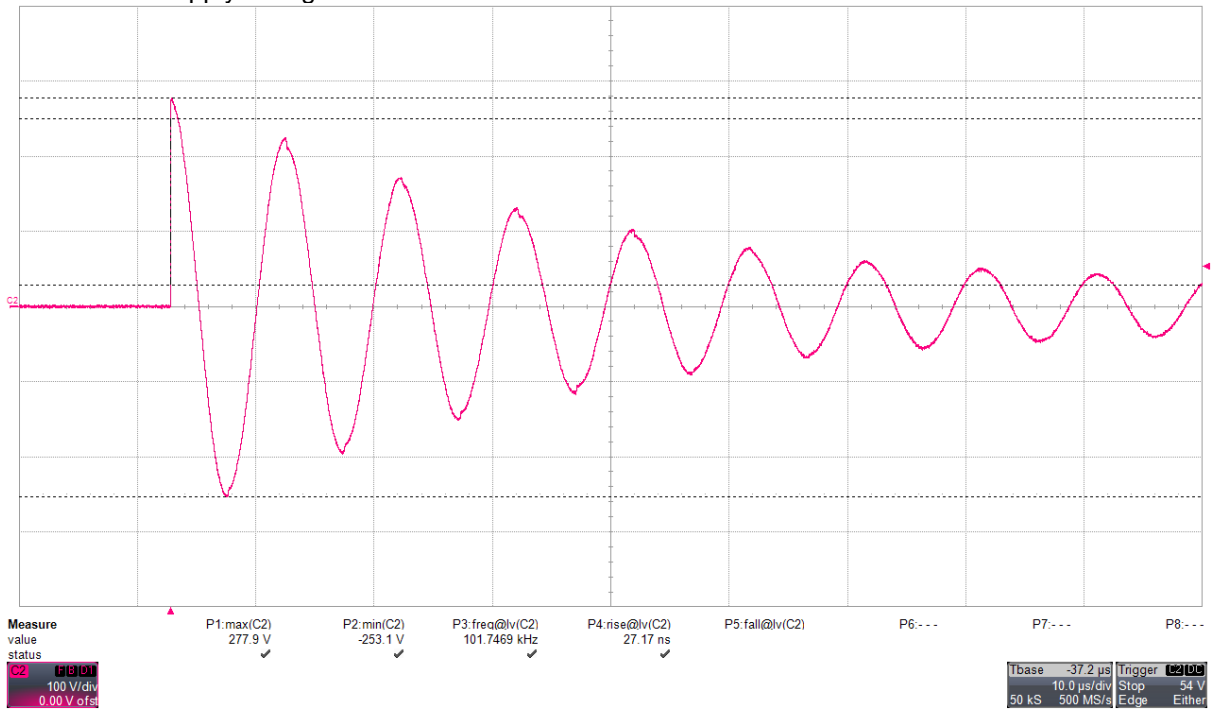

100 V/div 10  $\mu$ s/div

Typical spike pulse form, set voltage is 2000 V

At lower levels, due to contact bounce, the waveform might show some discontinuities. Following figure shows an example at 200 V set voltage:

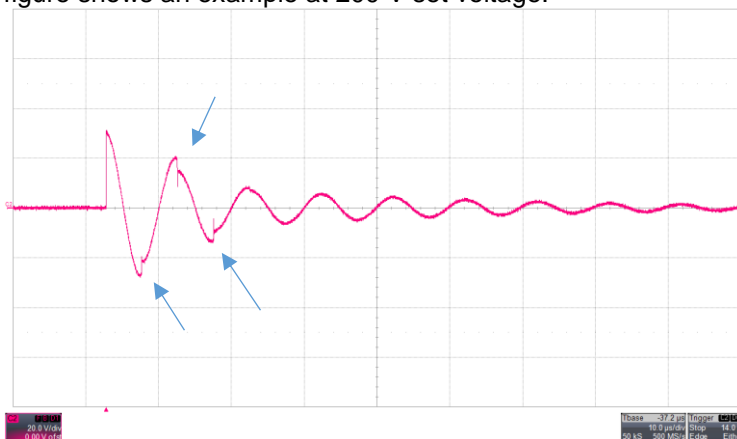



## 8.2 Surges

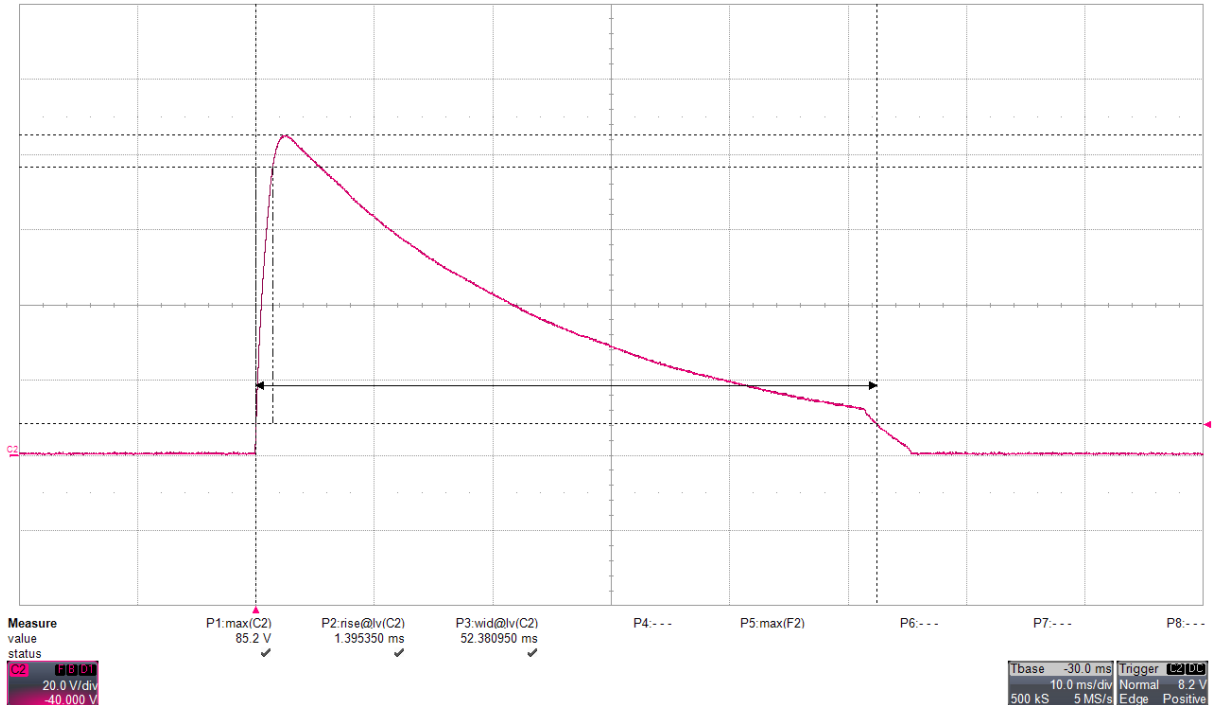

Typical surge pulse, 20 V/div 10 ms/div

Test conditions :

- EUT supply voltage = 0 V
- Charging voltage surge generator : 200 V
- Test load resistance : 0.5  $\Omega$

With other load impedances than 0.5  $\Omega$ , the shape and amplitude of the pulse will vary. Following figure shows an example at 100 V set voltage and a load of 1 k $\Omega$ :

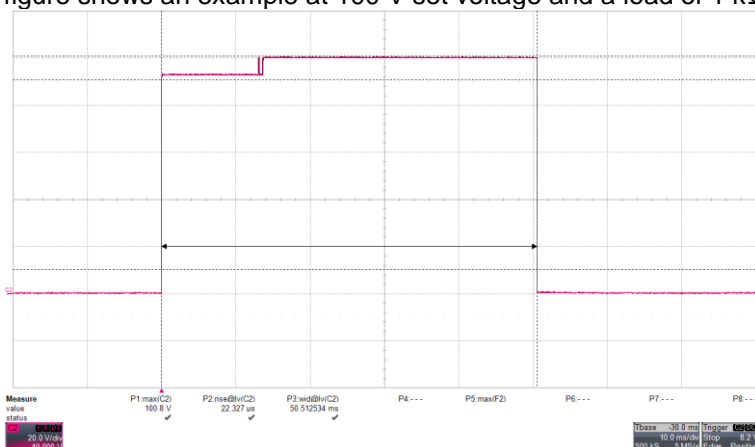

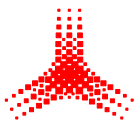

## 9. Remote control

The remote control can be carried out through the USB or RS 232 connector placed on the rear side of the generator. The RS 232 connector is a Sub-D 9 pins. The port settings are: baud rate 9600, 8 data bits, no parity, 1 stop bit, no flow control. The USB is A-type.

### 9.1 List of commands

The list of the control commands is given below.

| Header          | Name                  | W/R | Argument                      | Explanation   | Example           |
|-----------------|-----------------------|-----|-------------------------------|---|-------------------|
| :IDN?           | IDeNtity              | R   | none                          | Returns the identity (name) of the generator:<br>Example: PG-1275E  | :IDN?             |
| :MODE<br><ARG>  | Mode                  | W   | SURGE ON<br>SPIKES ON         | Puts the generator into SURGE or SPIKES mode.   | :MODE SURGE<br>ON |
| :REM            | REMOte                | W   | none                          | Puts the generator into remote mode. The buttons of the control panel deactivated.  | :REM              |
| :LOC            | LOCal                 | W   | none                          | Sets the generator into local mode. The buttons of the control panel are active.  | :LOC              |
| :RST            | ReSeT                 | W   | none                          | Sets the generator into the standard configuration  | :RST              |
| :STA?           | STAtE                 | R   | none                          | 1 = standby                    7 = sequence running<br>2 = ready                     8 = stopped<br>3 = wait                        9 = error | :STA?             |
| :VLT <ARG>      | VoLTage               | W   | integer<br>Range:<br>0 to 200 | Writes the amplitude of the charging voltage.<br>The digits argument corresponds to the voltage value in V.                                   | :VLT 150          |
|                 |                       |     | Real<br>Range:<br>0 to 2000   |   | :VLT - 250        |
| :VLT?           | VoLTage               | R   | none                          | Reads the amplitude of the charging voltage set value [V].  | :VLT?             |
| :PRR <ARG>      | Pulse Repetition Rate | W   | 5 to 60                       | Time in seconds between two pulses.   | :PRR 30           |
|                 |                       |     | 10 to 99                      |   |                   |
| :PRR?           | Pulse Repetition Rate | R   | none                          | Reads the actual time between two pulses in seconds.  | :PRR?             |
|                 |                       |     |                               | Reads the actual time between two pulses.<br>10 to 99 = 1.0s to 9.9s.   |                   |
| :TTIME<br><ARG> | Pulse Nbr             | W   | integer or real               | Sets the total test pulses from 1 to 5 pulses   | :TTIME 300        |
|                 |                       |     |                               | Sets the total test pulses from 1 to 99 pulses  |                   |
| :TTIME?         | Pulse Nbr             | R   | none                          | Returns the actual test pulses nbr.   | :TTIME?           |
| :CTIME?         | Actual Pulse Nbr      | R   | none                          | Returns the actual elapsed test pulses nbr.   | :CTIME?           |
| :HVO            | High Voltage On       | W   | none                          | Charging of the capacitors  | :HVO              |
| :TRG            | TRiG                  | W   | none                          | Releases a single pulse or starts/stops the pulse test sequence.  | :TRG              |
| :STP            | SToP                  | W   | none                          | Instant stop of the charging, slow discharge of the capacitors and cancellation of the pulse or of the pulse sequence.                        | :STP              |

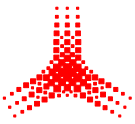

## 9.2 Syntax to send a command

The general syntax of a writing command is given as following:

**:<HEAD> < > <ARG> <LF>**

Example:

**:VLT 0560** sets the voltage to 560 V

In details:

|                     |   |
|---------------------|---|
| <b>:</b>            | indication of the beginning of the command  |
| <b>&lt;HEAD&gt;</b> | 3 ASCII letters sequence indicating the type of command (UPPER CASE)  |
| <b>&lt; &gt;</b>    | space   |
| <b>&lt;ARG&gt;</b>  | Integer argument with 1, 2, 3 or 4 digits depending on the command  |
| <b>&lt;LF&gt;</b>   | indication of the command end (Carriage Return and Line Feed)<br><CR> or <CR + LF> or <LF + CR> will also be recognised as termination characters |

## 9.3 Query form syntax

The syntax to ask for a parameter from the generator is using the question mark (?)

**:<HEAD>?<LF>**

Example:

**:VLT?**

The answer from the generator is given without header and are terminated with <LF>

Example:

**0824<LF>**

This returned value indicates that the actual set voltage is 824 V



**montena**

## 10. Maintenance

This equipment requires no special periodical adjustment or maintenance.

## 11. Servicing

Montena Technology SA  
Route de montena 89  
CH-1728 Rossens  
Switzerland  
Tel. : + 41 26 411 84 84 - Fax : + 41 26 411 17 79  
Email: [products@montena.com](mailto:products@montena.com)  
[www.montena.com](http://www.montena.com)

\_\_\_\_\_MIL1275\PG1275E\_V01\4\_Dossier\_construction\08\_Mode\_emploi\Users\_manual\_PG-1275E\_R02.docx