

Provided by:



**Brüel & Kjær Vibro**



## THE ALLROUNDERS

# VIBROPORT 80 & VIBROTEST 80

- Machine Diagnosis
- Field Balancing
- Condition Monitoring

## Machine evaluation, trouble-shooting and predictive maintenance



The **VIBROPORT 80** and **VIBROTEST 80** are the newest generation of Brüel & Kjær Vibro's portable measuring instruments. Since the early 1970s, Brüel & Kjær Vibro has been successfully developing solutions for condition-based maintenance and field balancing of rotating equipment in numerous industrial applications. This cumulative experience has resulted in the development of the **VIBROPORT 80** and **VIBROTEST 80** handhelds.

Designed with powerful diagnostics and analysis, balancing and condition monitoring capability, these all-purpose instruments are easy to use and flexible enough to tackle the most demanding applications:

- **VIBROPORT 80** – With its large screen, this instrument is ideal for capturing machinery vibration and undertaking detailed multi-channel diagnostics to determine the cause and nature of many developing faults. Two-plane polar plots can also be easily viewed in the screen.
- **VIBROTEST 80** – A more compact, lightweight version of the **VIBROPORT 80**, this instrument is ideal for fast and easy route-based data collection, monitoring the condition of the machines and balancing.

ATEX versions of both instruments are of course available.



*Machine Diagnosis  
Field Balancing  
Condition Monitoring*

## Powerful functionality for extensive application versatility

With its extended monitoring, balancing and analysis capability, both the **VIBROPORT 80** and **VIBROTEST 80** can be used on a wide range of machines in the petrochemical, power and process industries. Their extensive measurement and sensor input capability make them the perfect choice for early detection and diagnosis of incipient faults in, for example, bearings, shafts, gears, couplings, or casings. This includes everything from balance-of-plant to critical machines, and even those in ATEX intrinsic safety areas. The diagnostic functionality of these instruments rival that of many on-line condition monitoring systems!

The powerful application functionality of our two allrounder handhelds is demonstrated in the following pages with examples.

It is this application versatility plus the flexible modular setup and user-friendly operation that makes the **VIBROPORT 80** and **VIBROTEST 80** the ideal portable vibration instruments for helping deliver machine uptime to your plant.

### Machine condition monitoring

remains being universally accepted as an important part of any modern predictive maintenance program. If developing faults can be detected and diagnosed early, maintenance can be planned ahead of time. With the right monitoring strategy and instruments, this can significantly minimize the life cycle costs of the monitored machines and maximize production.

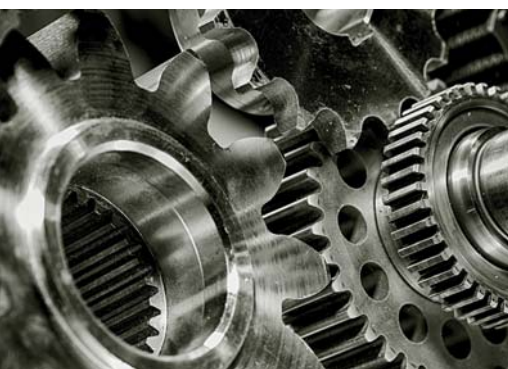



# Powerful vibration analysis and machine diagnosis



One of the important principles of condition monitoring is early detection and diagnosis of a developing machine fault so maintenance can be planned ahead of time.

In this example, a compressor train is being analyzed by the **VIBROPORT 80** or **VIBROTEST 80**. Real overall vibration measurements (not calculated overall values from spectra) such as the bandpass and a BCU measurement for bearing fault detection are measured during running conditions to get a glimpse of the general condition of the gearbox. If alarm limits are exceeded, a number of measurements can be taken from the three "toolbox" modules on the right for further analysis, such as the FFT. Under variable speed conditions, overall vibration vs. speed and order tracking bandpass measurements can also be derived by an innovative post-processing approach.

## ★ Highlights of the OVERALLS MODULE (Machine condition overall values)

- Parallel measurement of the overall condition of the machine and the rolling-element bearings
- Various methods offered for monitoring the rolling-element bearings
- Overall value measurements as a function of time and rotational speed (optional)

## In the field

Overall	Overall [A]	Overall [B]
Channel1	0.553 [g] p 0.731 [mm/s] rms 6.54 [µm] pp	1.01 [BCU]
Channel2	0.308 [g] p 0.241 [mm/s] rms 2.25 [µm] pp	0.606 [BCU]

26 Jun 2014 10:44:57:0V1

SETUP VIEW PREV NEXT START EXIT

Two-channel real overall measurements (bandpass/BCU)

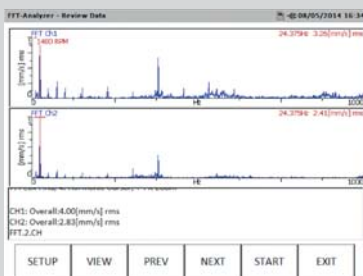

Two-channel FFT

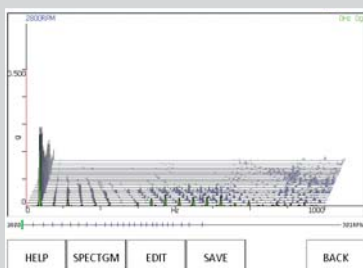

Tracking FFT waterfall plot

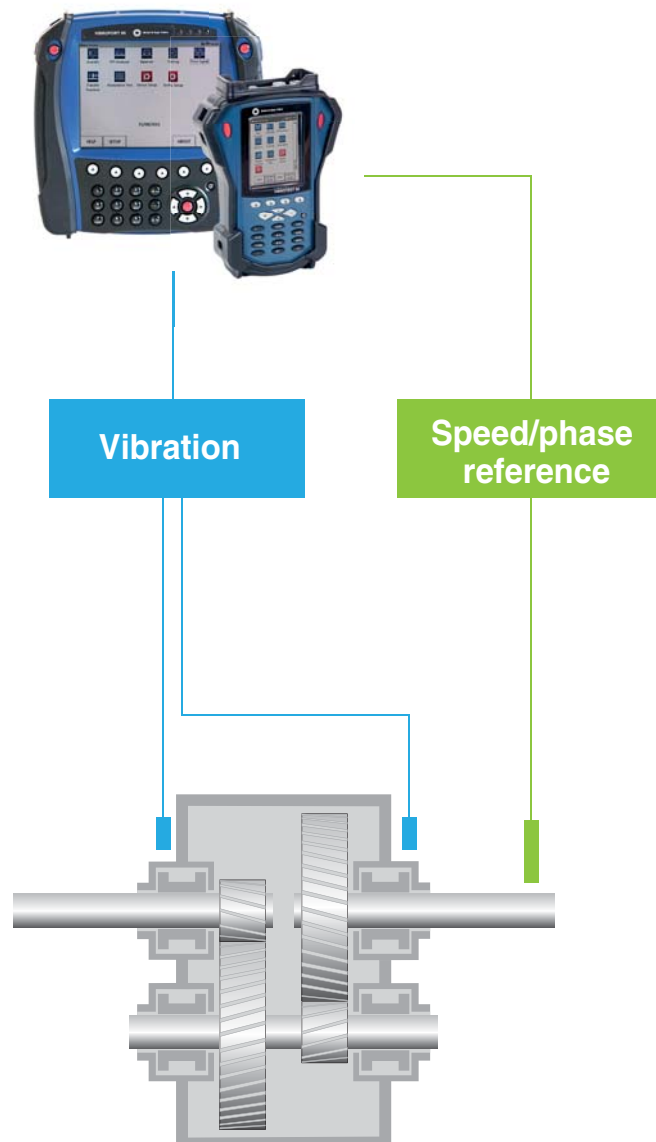

Operation: steady state and transient speed

# Detailed diagnostics and analysis for all operating conditions

Field diagnostics give a good understanding of the fault, but more detailed vibration analysis can be done on the host computer with the Report & Examiner software. Post-processing of the time signal, for example, enables you to more precisely analyze the detected fault, in order to determine its location and severity. This can include steady-state and transient analysis for FFT spectra and waterfall diagrams as shown below.

## ★ Highlights of the FFT-ANALYZER MODULE (Spectral analysis)

- FFT frequency range up to 80 kHz and up to 25,600 lines resolution
- Envelope spectrum (BCS and SED)
- Simultaneous display of time signal and spectrum
- Cross-channel phase (phase difference between two channels without using a tacho)
- Order analysis
- Cursor: single, peak, harmonic

## ★ Highlights of the TRACKING MODULE (Order analysis)

- Identifying machine resonances
- Innovative measurement approach: Recording the raw vibration signal, post-processing the raw signal: Bode, Nyquist, table view, FFT waterfall diagram, spectrogram



## Report & Examiner software on host computer

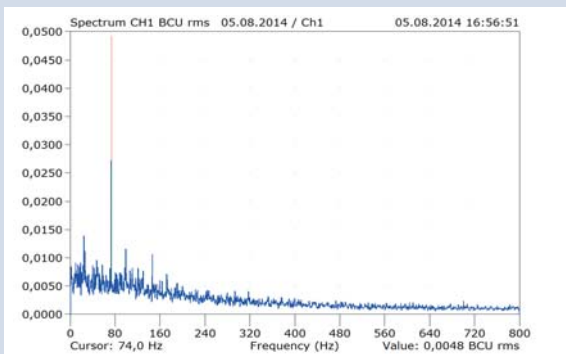

Envelope spectra plot

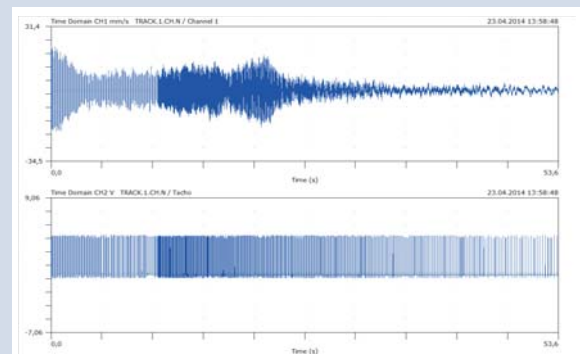

Coast down time signal plot

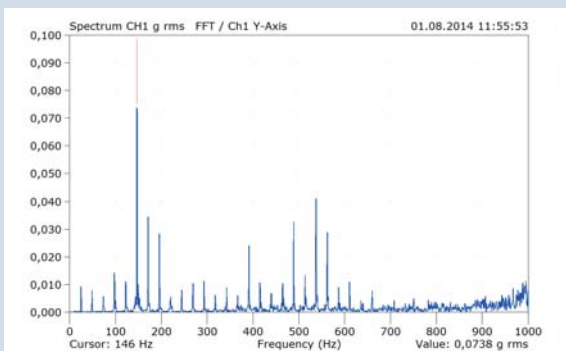

FFT plot

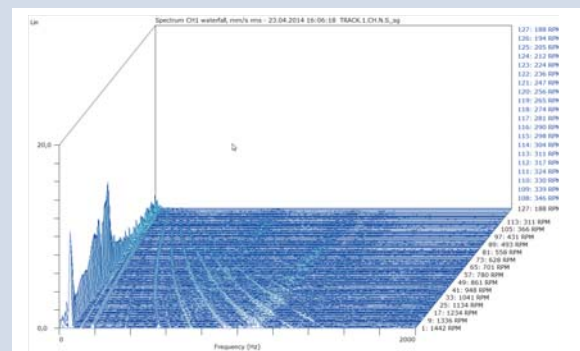

Tracking FFT waterfall plot



# Field balancing made easy

Field balancing is much more cost-saving than using a balancing machine, and in many ways more effective. In this example the **VIBROPORT 80** or **VIBROTEST 80** is performing a two-plane static and dynamic balancing on a motor, using the two-plane polar plot. The entire balancing process goes faster using the "Fire Key". After the field balancing you can upload all the data into the Report & Examiner software and issue a balancing report in Microsoft® Word.



The VIBROPORT 80 plot display is ideal for field balancing.

Vibration

Speed/phase reference

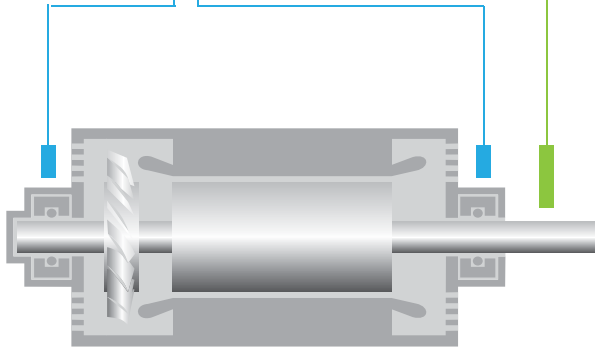

- ★ Highlights of the **BALANCING MODULE**
- One or two-plane field balancing (static/dynamic)
  - Ultrafast Two-plane balancing through innovative prognosis function
  - Large one or two-plane polar plot display
  - Two-plane balancing with one vibration sensor
  - Adjustable target value for residual vibration display (colour coding)
  - Free choice of adjustment method (polar, fixed location, fixed mass)

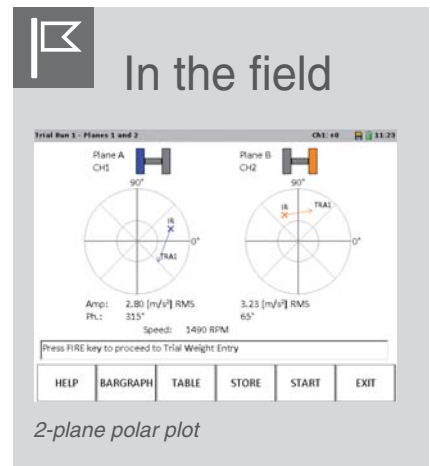

## Report & Examiner software on host computer



Two-plane polar plot

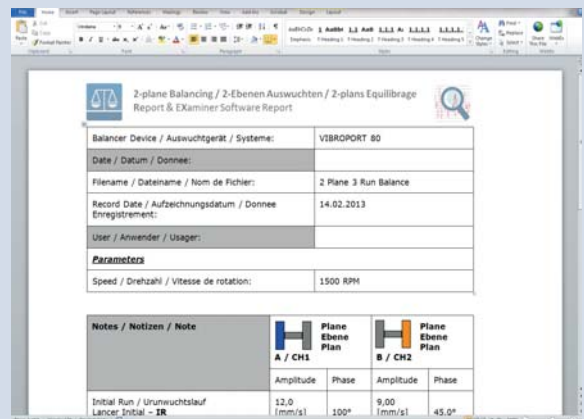

Balancing report, ready to be printed out in Microsoft® Word



# Effective tools for transfer function

Transfer function determines the structural resonances by impact excitation on machines that are not rotating or on immovable objects such as foundations or casings. The transfer function (i.e. FRF, the frequency response, the ratio of the input impulse load and the measured impulse response vibration) is determined with an impact hammer having a built-in load sensor. In this example the **VIBROPORT 80** or **VIBROTEST 80** is being used to find a spurious resonance that has been causing the bearings on this motor to fail prematurely. The transfer function can be analyzed in the Report & Examiner software.



★ **Highlights of the TRANSFER FUNCTION MODULE**

- All conventional evaluation methods available (load, acceleration, displacement)
- Coherence analysis (with colour coding of acceptable/inacceptable coherence level)

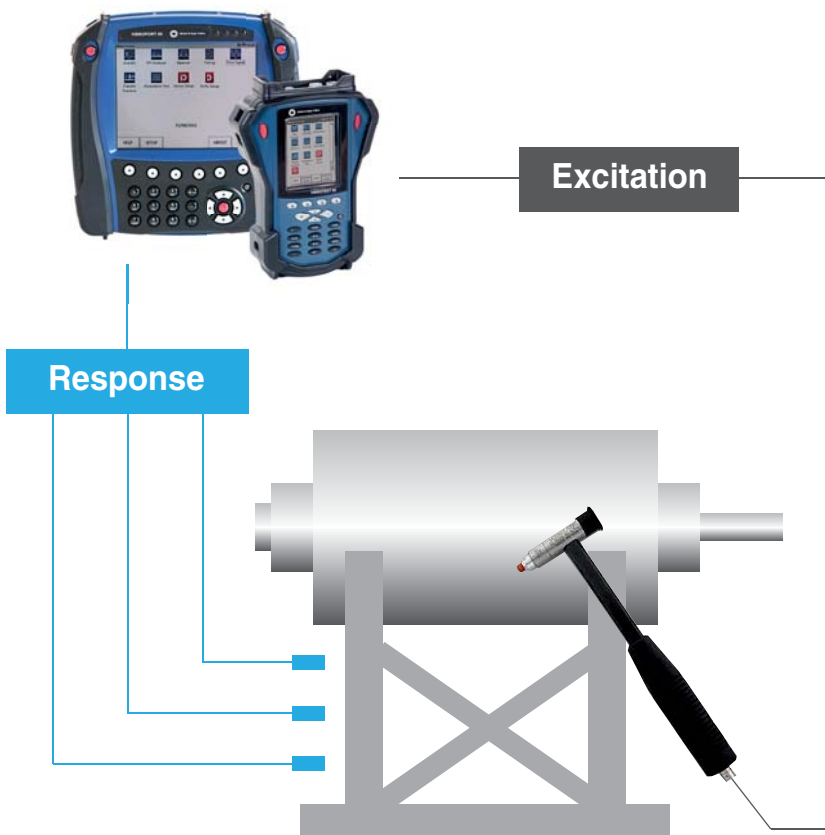

**In the field**

Excitation and impulse responses

## Report & Examiner software on host computer

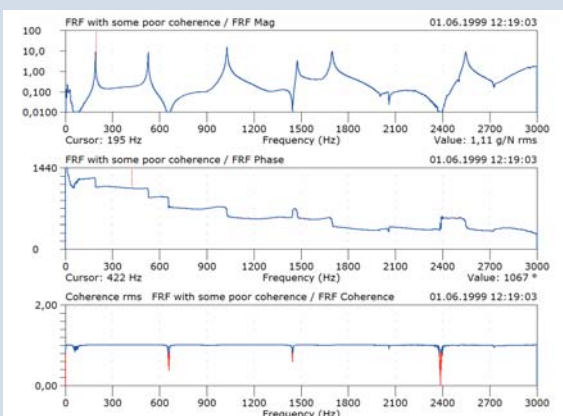

Transfer function and coherence



# Efficient machine management via route-based inspection

One of the important principles of condition monitoring is data acquisition and monitoring to alarm limits. With the uploaded route, you are prompted to go from machine to machine, and measurement point to measurement point to collect data in a systematic, efficient way. If there is an alarm situation, you are notified and you can easily extend the route with additional measurements if needed. In this example, the **VIBROPORT 80** or **VIBROTEST 80** is routinely monitoring a compressor.



## ★ Highlights of the DATA COLLECTOR MODULE

- Unlimited amount of measurement routes with up to 5000 measurement tasks
- Up to 12 measurements and measurement types per measurement point



*The VIBROTEST 80 is ideal for data collection because of its light weight and easy handling.*

Vibration

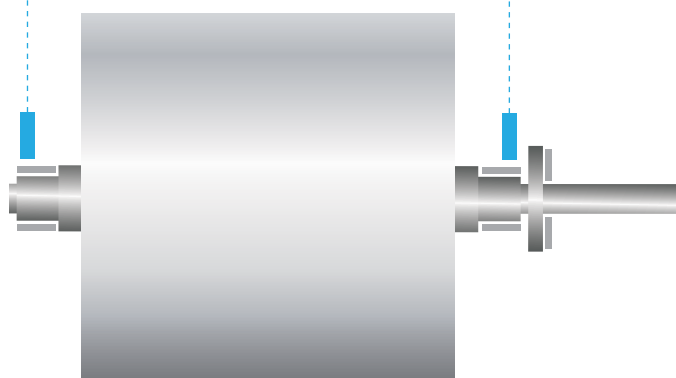

## In the field

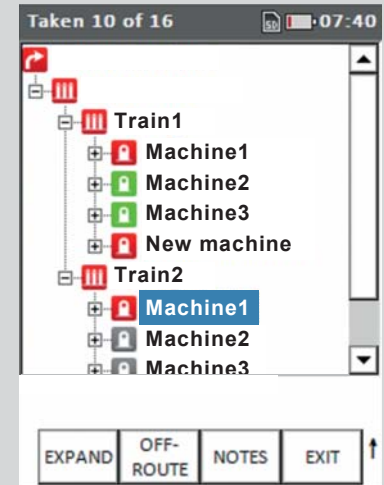

*Data collection route*



# Setting up routes and analyzing data

The Report & Route Manager host software enables you to quickly and efficiently set up a data collection route so it can be downloaded to the **VIBROPORT 80** or **VIBROTEST 80** instruments. The same software uploads data from the handheld via a USB connection to store it in the database and to do analysis on it.

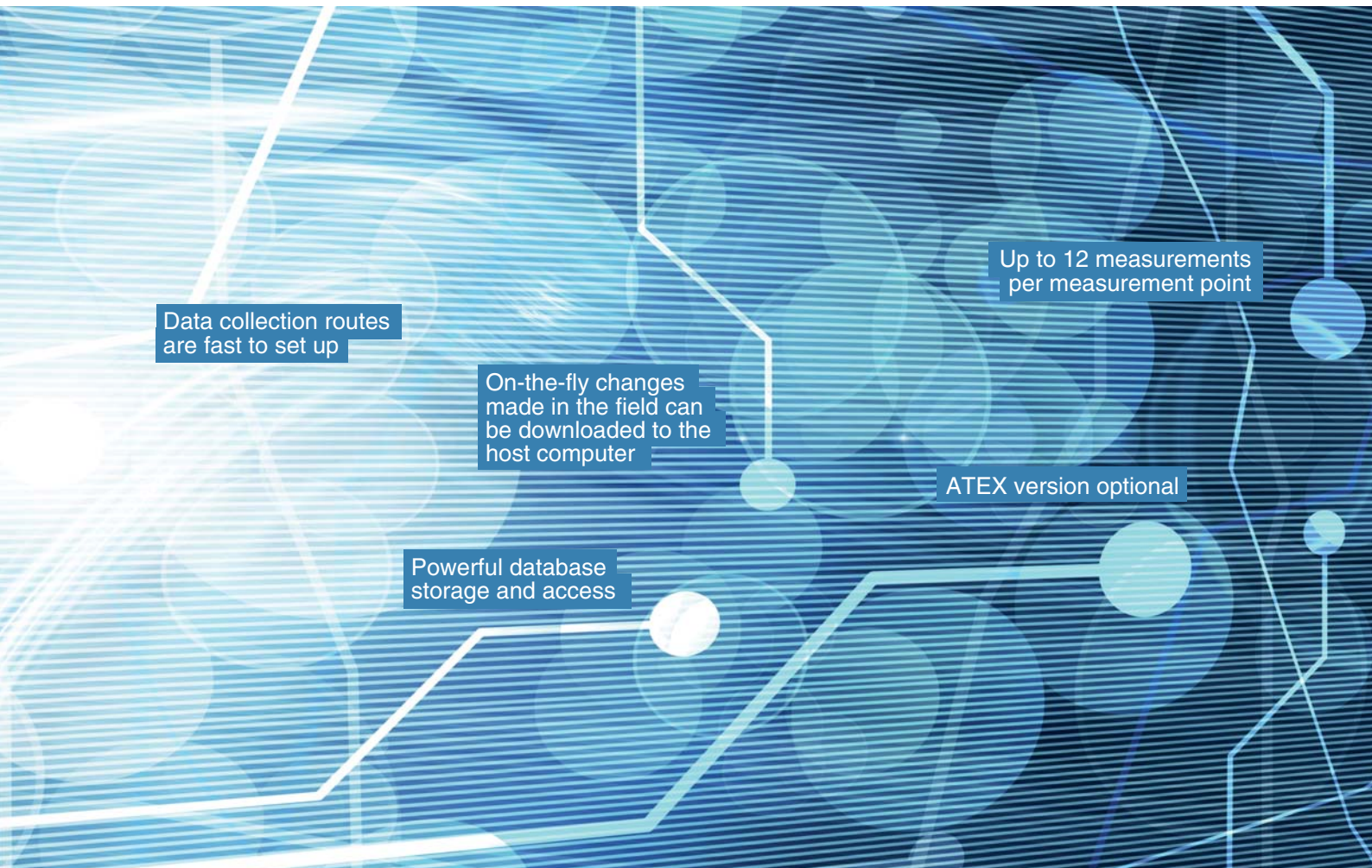

## Report & Route Manager software on host computer

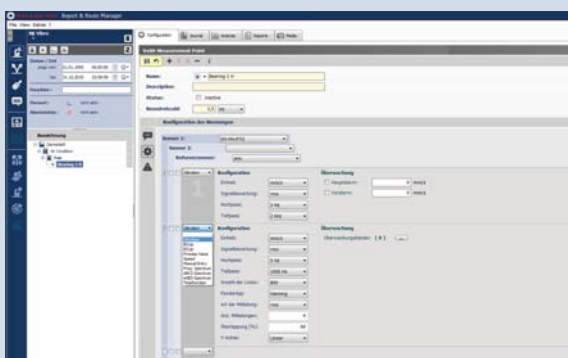

Creating a route...

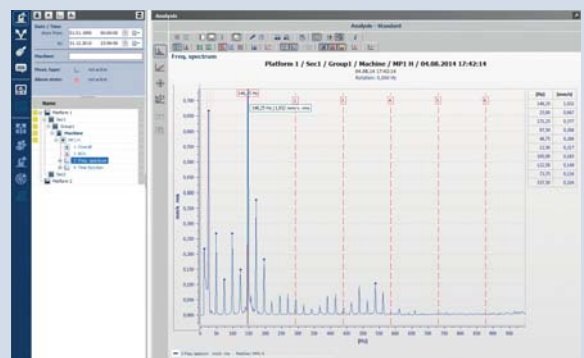

...doing analysis.



# Fast and easy way to test machines

Use one of the standard templates (e.g. ISO 10816) or a user-defined one to compare actual measurements to established limits for a given machine. In this example a **VIBROPORT 80** or **VIBROTEST 80** is being used to quality test motors from the factory assembly line. This non-route based data collector function easily guides you through the entire measurement process by showing a “mini route” (picture with measurement locations and directions) on the instrument and gives the results as a colour-coded pass/fail indication. It can also be used for testing serviced machines and commissioning. Further analysis such as a very simple trending or FFT spectra evaluation can be done in the Report & Examiner software.



### ★ Highlights of the ACCEPTANCE TESTING MODULE

- Up to 64 vibration monitoring bands can be simultaneously measured, i.e. used for overall values calculation
- Machine picture showing sensor positions
- Vibration spectra can be saved automatically
- Standard templates available, can be modified
- Easy-to-read traffic light results
- Easy, fast operation of buttons

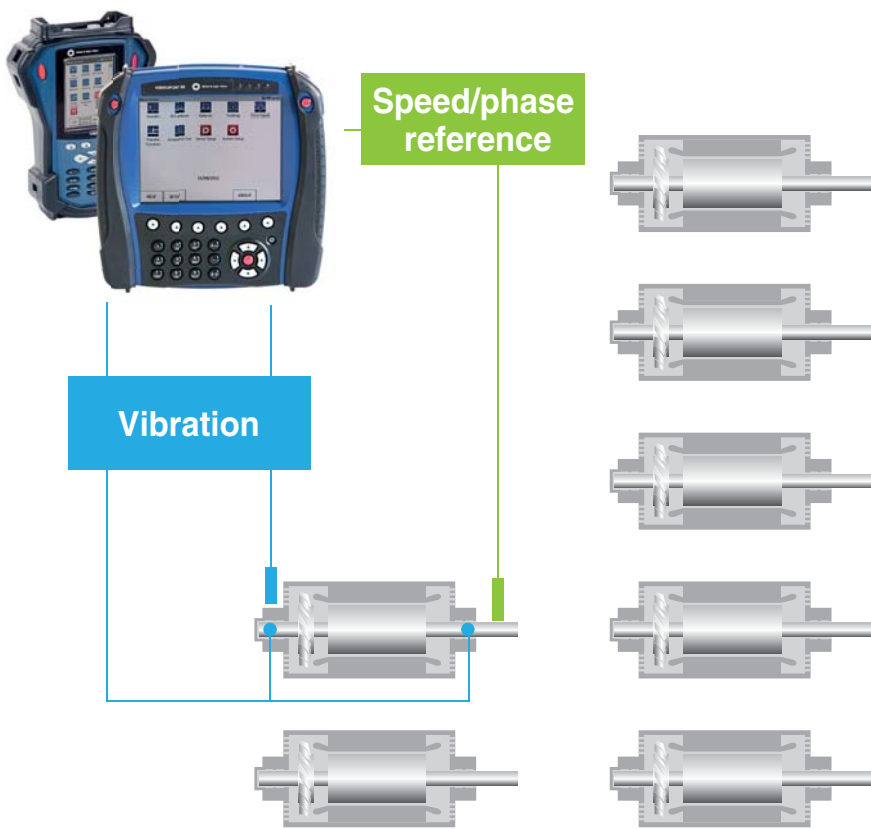

## Report & Examiner software on host computer

Acceptance Test			
Position	Direction	um rms	mm/s rms
1	Horizontal	C (49,00 µm)	D (5,15 mm/s)
	Vertical	A (3,14 µm)	A (0,663 mm/s)
	Axial	A (7,02 µm)	A (1,13 mm/s)
2	Horizontal	B (42,54 µm)	D (4,51 mm/s)
	Vertical	A (13,75 µm)	B (1,82 mm/s)
	Axial	A (5,17 µm)	A (1,000 mm/s)
3	Horizontal	A (6,38 µm)	A (1,32 mm/s)
	Vertical	A (8,90 µm)	A (1,38 mm/s)
	Axial	A (3,31 µm)	A (0,894 mm/s)
4	Horizontal	A (1,11 µm)	A (0,389 mm/s)
	Vertical	A (1,84 µm)	A (0,505 mm/s)
	Axial	A (2,03 µm)	A (0,763 mm/s)
5	Horizontal	C (49,69 µm)	D (5,21 mm/s)
	Vertical	A (14,16 µm)	B (1,58 mm/s)
	Axial	A (6,79 µm)	A (1,02 mm/s)
6	Horizontal	B (42,94 µm)	D (4,57 mm/s)

Easy-to-read acceptance results with colour coding of alarm limit violations

## Perfect choice of hardware and software components with full flexibility

The **VIBROPORT 80** and **VIBROTEST 80** portable handhelds combine application versatility with a modular product concept that is easy to use by specialists and beginners alike. The **VIBROTEST 80** is a more compact, lighter version of the **VIBROPORT 80** with a smaller screen but the same functionality. The host monitoring software packages, which can be installed on all current Windows® PCs, download and upload data to the instrument via a USB port. Reports are made in Microsoft® Word. There are two types of software:

- **Report & Examiner software** – Downloaded data can be diagnosed and time signals can be post-processed for more detailed analysis. An OEM (Original Equipment Manufacturer) database includes most bearing fault frequencies. Reports of balancing jobs can be easily created. Acceptance testing templates can be easily created and uploaded to the instrument.
- **Report & Route Manager software** – Data collection routes are defined and uploaded to the instrument. Measured data is downloaded and stored in the database, where it can be further analyzed.

### ★ Highlights of the INSTRUMENTS

- Up to 4 input channels for vibration + speed (triaxial measurements possible)
- Robust, compact and lightweight housing (IP65)
- Easy handling and big colour display
- CSA certified, ATEX/IECE version optional

## Cost-effective, ready-to-start package options

Both the **VIBROPORT 80** and **VIBROTEST 80** are available in several complete, ready-to-use packages that can cost-effectively meet your monitoring requirements. The package price always includes the software and the accessories! It doesn't matter what your application is or if you are a beginner or experienced user, there is a package for you. Moreover, you can upgrade your handheld at any time with different application modules, as your need grows.

Look at our website ([www.bkvibro.com](http://www.bkvibro.com)) for more information on our package offerings and the product specification documents available for download, or contact your local sales representative.



## Contact

### **Brüel & Kjær Vibro GmbH**

Leydheckerstrasse 10

64293 Darmstadt

Germany

Phone: +49 6151 428 0

Fax: +49 6151 428 1000

[info@bkvibro.com](mailto:info@bkvibro.com)

### **Brüel & Kjær Vibro A/S**

Skodsborgvej 307 B

2850 Nærum

Denmark

Phone: +45 77 41 25 00

Fax: +45 45 80 29 37

[www.bkvibro.com](http://www.bkvibro.com)