



Advanced Test Equipment Rentals
www.atecorp.com 800-404-ATEC (2832)

MODEL 8718

RF RADIATION SURVEY METER

OPERATION MANUAL

This Operation Manual is a duplication made as a reference and convenience to our customers who have misplaced the manual (printed in 1996) that came with their 8718 RF Radiation Survey Meter.

Only Narda's logo and contact information has been updated to enable you to contact us as needed.

WARRANTY

The Narda Microwave Corporation warrants each product of its manufacture to be free from any defect in material and workmanship for a period of one year after delivery to, and return by, the original purchaser. All warranty returns, however, must first be authorized by a factory office representative.

The limit of liability under this warranty shall be to repair or replace any product, or part thereof, which proves to be defective after inspection by Narda. This warranty shall not apply to any Narda product that has been disassembled, modified, physically or electrically damaged or any product that has been subjected to conditions exceeding the applicable specifications or ratings.

The Narda Microwave Corporation shall not be liable for any direct or consequential injury, loss or damage incurred through the use, or the inability to use, any Narda product.

The Narda Microwave Corporation reserves the right to make design changes to any Narda product without incurring any obligation to make the same changes to previously purchased units.

This warranty is the full extent of obligation and liability assumed by The Narda Microwave Corporation with respect to any and all Narda products. Narda neither makes, nor authorizes any person to make, any other guarantee or warranty concerning Narda products.

TABLE OF CONTENTS

Section	Page
LIST OF ILLUSTRATIONS	iii
LIST OF TABLES	iii
1 INTRODUCTION	1-1
1-1 General	1-1
1-2 Description	1-1
2 INSTALLATION INSTRUCTIONS	2-1
2-1 Introduction	2-1
2-2 Preparation for Use	2-1
2-3 Battery Charging	2-3
3 THEORY OF OPERATION	3-1
3-1 General	3-1
3-2 Overall Functional Description	3-1
3-3 Probe Descriptions	3-5
3-3.1 Broadband E-Field Probes (Models 8722B, CN8722, EC8722, 8741, E8741)	3-5
3-3.2 Low Frequency E-Field Probes (Models 8742, 8760, E8760, 8761, E8761, 8762, E8762, 8782 and E8782)	3-6
3-3.3 Low Frequency H-Field Probes (Models 8731, 8732, 8733, 8752 and 8754)	3-6
3-3.4 High Frequency Probes (Models 8721, E8721, 8723 and 8725)	3-7
3-4 Model 8718 Meter Circuits	3-7
3-5 PCB A1 Functional Description	3-7
4 OPERATING INSTRUCTIONS	4-1
4-1 Introduction	4-1
4-2 Controls and Indicators	4-1

TABLE OF CONTENTS - Continued

Section	Page
4-3 Operating Instructions	4-1
4-4 Measurement Methods and Survey Hints	4-1
4-5 Post Survey Reporting	4-8
4-6 Surveying Unintentional Emitters	4-9
5 COMPUTER OPERATIONS	5-1
5-1 Introduction	5-1
5-2 Interface Software	5-1
5-2.1 System Requirements	5-1
5-2.2 Installing the Interface Software	5-2
5-2.3 Starting and Exiting the 8718 User's Program	5-2
5-2.4 Establishing Communications Between the Meter and Computer	5-2
5-2.5 Adding or Changing Probe Calibration Data in the Meter's Memory	5-3
5-2.6 Downloading Logged Data From the Meter	5-6
5-2.7 Viewing Survey Data	5-6
5-2.8 Diagnostics	5-10
5-3 Communications Between the Model 8718 and a Computer	5-11
5-3.1 Checksum and Modulo Description	5-11
5-3.2 Computer to Model 8718 Message Format	5-11

LIST OF ILLUSTRATIONS

Number	Title	Page
1-1	Model 8718 Radio Frequency Radiation Test Set	1-2
2-1	Probe Orientation During Pre-Operational Testing	2-4
3-1	Model 8718, Functional Block Diagram	3-3
4-1	Model 8718 Controls and Indicators	4-4
5-1	Interface Software Probe Installation Window	5-4
5-2	Interface Software Logged Survey Data Window	5-8

LIST OF TABLES

Number	Title	Page
1-1	List of Equipment Supplied	1-3
1-2	Leading Particulars	1-4
1-3	Probe Technical Characteristics	1-6
1-4	Battery Charger and Line Cord Options	1-7
4-1	Controls and Indicators	4-2
4-2	Operating Instructions	4-13
5-1	Command Character Function	5-12

SECTION I

INTRODUCTION

1-1. GENERAL.

This preliminary manual contains information regarding the operation and maintenance of the Model 8718 Radio Frequency Radiation Survey Meter (see Figure 1-1). The 8718 is fully compatible with 8700 series Probes. Section I, Introduction, contains general information relating to the use of the manual, describes the purpose and use of the meter, and lists the tabulated data pertinent to the meter and the probes that may be used with it. Section II contains instructions for preparing the meter for use. A general Theory of operation of the meter is contained in Section III. Section IV contains instructions for evaluating radiation sources, safety precautions to be observed when taking measurements, and detailed information relating to the controls and indicators of the meter. Also included are procedures for startup, normal operation, operation under abnormal conditions and shut-down. Procedures for operating the meter with the supplied software are contained in Section V.

1-2. DESCRIPTION.

The meter is a portable, battery-operated instrument for detecting and measuring potentially hazardous electromagnetic radiation from 3 kHz to 40 GHz. A complete survey system consists of a meter and a probe interconnected by a cable or fiber optic link. (See Figure 1-2.) The cable may be an integral part of the probe or it may be separate. The meter may be hand-held or mounted to a tripod. A carrying case is provided to protect the meter when not in use and for transporting the meter. The case can also store up to five probes and a fiber optic link. A list of equipment supplied is contained in Table 1-1. The technical and physical characteristics of the meter are listed in Table 1-2. Table 1-3 contains a listing of the available probes and their technical characteristics. A list of the available battery chargers and line cords is contained in Table 1-4.

Model 8718

The probe assembly detects electromagnetic radiation and transmits a signal to the meter assembly. The meter assembly processes the signals from the probe assembly to provide a display of the radiation level on the built-in meter. The meter display is calibrated to show field levels in field strength, mean squared field strength, equivalent power density or in % of Std. with shaped (i.e. 8722, 8732) probes. The meter assembly includes built-in test capability for testing the condition of the battery charge as well as checking and adjusting the zero-setting and functioning of the probe assembly.

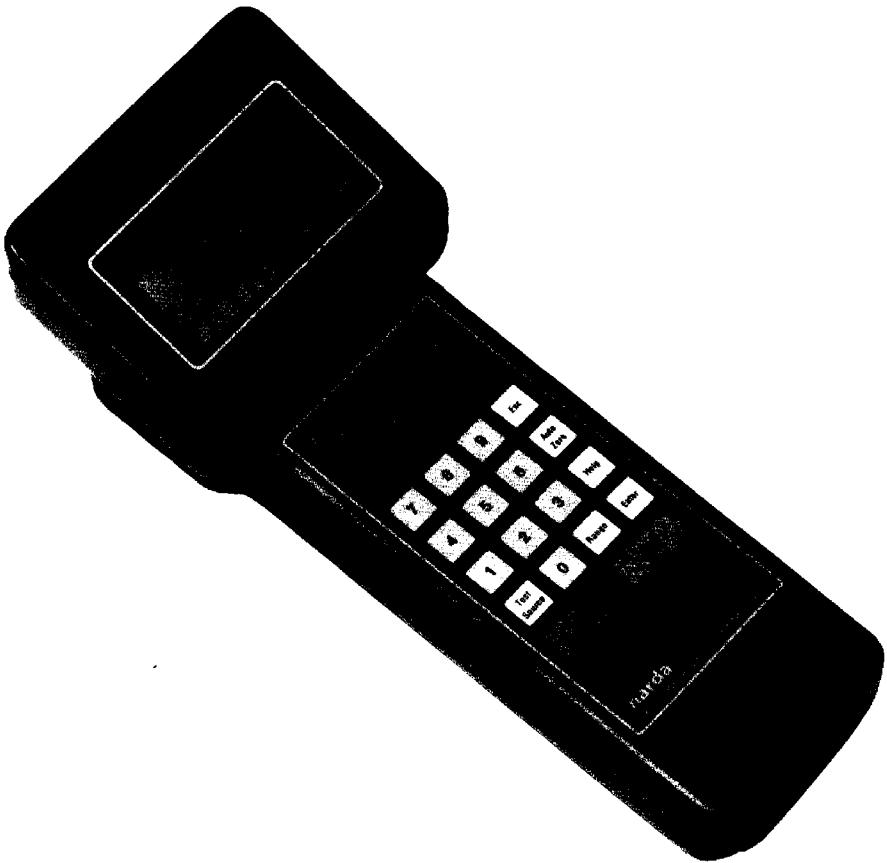

Figure 1-1. Model 8718 Radio Frequency Radiation Survey Meter

Table 1-1. List of Equipment Supplied

Nomenclature	Common name	Part no.	Function
Carrying case	Carrying case	32542704	Houses meter when not in use and provides shielding from stray RF radiation.
Meter, radio frequency radiation survey	Meter	8718-XX	Provides a display of electromagnetic radiation sensed by the probe.
Operation manual	Operation manual		Provides technical documentation for operating the meter.
Battery charger	Battery charger	84126000 (-10) 84126001 (-21 thru -29)	To provide operating power (one required). See table 1-4 for a listing of the available battery chargers.
Line cord (-21 thru -29 units only)	Line cord	Various	To provide AC power to the battery charger. See table 1-4 for a listing of the available line cords.
User software for 8718 (3.5" Disk)	Software		To provide remote operation, display of survey results and meter storage of probe calibration factors.

Table 1-2. Leading Particulars

Item	Technical characteristics
METER, Model 8718	
Dynamic range	30 dB
Scale	Three (3) 10 dB full scale ranges or one (1) 30 dB range
Display	Four (4) line by 20 character LCD with backlight
Instrument accuracy	±1%
Response time	User setable from 0.3 to 2.0 seconds
Zero control	
Type	Automatic zeroing in effect during built-in test and all measurements
Offset	0.1%/C° typical
Battery	
Battery type	NiCad Rechargeable pack, 7.2 Volt, 1.2 AH
Battery Life	40 hours use (2:1 use to charge ratio)
Battery test	Level displayed on LCD (Display Screen 14)
Self test	
Number of signals	2
Frequencies	10.5 GHz (radiated); 10 kHz (conducted)
Testability	Independent functional performance confirmation of each field sensitive element, and overall test of supporting electronics
Additional features	Datalogging of up to 3000 measurements Time averaging of field levels DC or fiber optic cable inputs Field levels displayed in multiple units Help screens











Table 1-2. Leading Particulars - Continued

Item	Characteristic
Recorder Output	+3VDC at full scale into minimum load resistance of 1000 ohms
Size	
Meter dimensions	11.24 x 4.54 x 3.64 inches 28.55 x 11.53 x 9.24 cm
Carrying case dimensions	21 x 14.25 x 8.25 inches 53.4 x 36.2 x 21.0 cm
Weight	
Meter	3.2 lbs (1.5 kg)
Carrying case	10 lbs
OVERALL SYSTEM SPECIFICATIONS	
Temperature	
Operating	-10°C to +50°C
Non-operating	-40°C to +75°C

Table 1-3. Probe Technical Characteristics

Probe Model	Type	Response Flat/Shaped	Frequency Range	Full Scale Measurement	Frequency Sensitivity	Isotropic Response	Calibration Frequencies
8721	Electric Field	Flat	300 MHz to 40 GHz	20 mW/cm ²	+1.25/-3.0dB(0.3 to 40GHz) ±1.25dB(1 to 40 GHz)	±1.0 dB	300, 700, 2450, 4000, 5000, 6000, 7000, 8200, 9300, 10000, 11000, 18000, 26500, 40000 MHz
E8721	Electric Field	Flat		300 V/m			300, 500, 1890, 2450, 5000, 6000, 7000, 8200, 9300, 10000, 11000, 18000, 26500, 40000 MHz
8722B	Electric Field	IEEE Shaped	300 kHz to 40 GHz	300% of Standard	±2 dB from Standard	±0.75 dB	0.3, 3, 10, 30, 100, 300, 750, 1000, 1750, 2450, 4000, 8200, 10000, 18000, 26500, 40000 MHz
CN8722	Electric Field	Canadian Shaped					0.3, 1, 10, 30, 100, 300, 750, 1000, 1750, 2450, 4000, 8200, 10000, 18000, 26500, 40000 MHz
EC8722	Electric Field	E.C. - P.A.D Shaped					0.3, 3, 10, 30, 100, 300, 750, 1000, 1750, 2450, 4000, 8200, 10000, 18000, 26500, 40000 MHz
8723	Electric Field	Flat	300 MHz to 40 GHz	100 mW/cm ²	+1.25/-3.0 dB(0.3 to 40 GHz) ±1.25 dB(1 to 40 GHz)	±1.0 dB	300, 700, 2450, 4000, 5000, 6000, 7000, 8200, 9300, 10000, 11000, 18000, 26500, 40000 MHz
8725	Electric Field	Flat	1 GHz to 40 GHz	1000 mW/cm ²	±1.25 dB		1000, 1700, 2450, 4000, 5000, 6000, 7000, 8200, 9300, 10000, 11000, 18000, 26500, 40000 MHz
8741	Electric Field	Flat	300 kHz to 40 GHz	20 mW/cm ²	+3.0/-1.5 dB (0.3 MHz to 40 GHz) ±1.5 dB (3 MHz to 40 GHz)	±1.5 dB	0.3, 3, 10, 30, 100, 300, 750, 1000, 1750, 2450, 4000, 8200, 10000, 18000, 26500, 40000 MHz
E8741	Electric Field	Flat	1 MHz to 40 GHz	300 V/m		±1.0 dB	1, 3, 10, 30, 80, 100, 300, 500, 750, 1000, 1890, 2450, 4000, 8200, 10000, 18000, 26500, 40000 MHz
8742	Electric Field	IEEE Shaped	300 kHz to 2.7 GHz	600% of Standard	±2 dB from Standard	±0.75 dB	0.3, 1, 3, 13.56, 27.12, 100, 300, 500, 750, 915, 1800, 2450, 2700 MHz
8760	Electric Field	Flat	300 kHz to 1 GHz	20 μW/cm ²	±1.0 dB (3 to 300 MHz) ±2 dB (300 kHz to 1 GHz)	±0.5 dB	0.3, 0.5, 1, 3, 13.56, 27.12, 40.68, 100, 200, 300, 750, 1000 MHz
E8760	Electric Field	Flat	1 MHz to 1 GHz	15 V/m			1, 3, 10, 30, 40, 60, 80, 100, 200, 300, 500, 750, 1000 MHz
8761	Electric Field	Flat	300 kHz to 1 GHz	20 mW/cm ²			0.3, 0.5, 1, 3, 13.56, 27.12, 40.68, 100, 200, 300, 750, 1000 MHz
E8761	Electric Field	Flat	1 MHz to 1 GHz	300 V/m			1, 3, 10, 30, 40, 60, 80, 100, 200, 300, 500, 750, 1000 MHz
8762	Electric Field	Flat	300 kHz to 1 GHz	200 mW/cm ²			0.3, 0.5, 1, 3, 13.56, 27.12, 40.68, 100, 200, 300, 750, 1000 MHz
E8762	Electric Field	Flat	1 MHz to 1 GHz	1000 V/m			1, 3, 10, 30, 40, 60, 80, 100, 200, 300, 500, 750, 1000 MHz
8781	Electric Field	Flat	2 GHz to 18 GHz	20 mW/cm ²	+1.25/-3.0 dB(0.3 to 40 GHz) ±1.25 dB(1 to 40 GHz)	±1.0 dB	2000, 2450, 4000, 5000, 6000, 7000, 8200, 9300, 10000, 11000, 18000 MHz
8782	Electric Field	Flat	3 kHz to 1 MHz	200 μW/cm ² 200 mW/cm ²	±1.0 dB	±0.5 dB	3, 10, 30, 100, 300, 540, 750, 1000 kHz
E8782	Electric Field	Flat		30 V/m 1000 V/m			100, 300, 540, 750, 1000 KHz
8731	Magnetic Field	Flat		10 MHz to 300 MHz			20 mW/cm ²
8732	Magnetic Field	IEEE Shaped	300 kHz to 200 MHz	300% of Standard	±2 dB from Standard	±0.75 dB	0.3, 1, 3, 10, 30, 100, 200 MHz
8733	Magnetic Field	Flat	10 MHz to 300 MHz	100 mW/cm ²	±0.5 dB (13 to 200 MHz) 2.0 dB max deviation (10 to 300 MHz)	±0.5 dB	10, 13.56, 27.12, 40.68, 50, 75, 100, 150, 200, 250, 300 MHz
8752	Magnetic Field	Flat	300 kHz to 10 MHz	200 mW/cm ²	±0.5 dB		0.3, 0.5, 1, 3, 10 MHz
8754	Magnetic Field	Flat		2000 mW/cm ²			

Table 1-4. Battery Charger and Line Cord Options

8718 OPTION NUMBER	VOLTAGE/ FREQUENCY	MAJOR USE COUNTRIES	OUTLINE
-10	115V 50-60Hz	U.S., Canada, Japan	
-21	230V 50-60Hz	Continental Europe	
-22	230V 50-60Hz	Australia	
-23	230V 50-60Hz	U.K. & Ireland	
-24	230V 50-60Hz	Denmark	
-25	230V 50-60Hz	India	
-26	230V 50-60Hz	Israel	
-27	230V 50-60Hz	Italy	
-28	230V 50-60Hz	South Korea, Saudi Arabia	
-29	230V 50-60Hz	Switzerland	

SECTION II

PREPARATION FOR USE AND INSTALLATION

2-1. INTRODUCTION.

This chapter contains procedures for unpacking the meter, inspecting the meter for shipping damage and for preparing the meter for use. Also included are pre-operational tests and adjustments.

2-2. PREPARATION FOR USE.

To prepare the meter for use, perform the procedures contained in the following subparagraphs:

- a. **Unpacking Procedures.** Do not unpack the meter within an area where RF radiation is suspected. The carrying case includes an RF shield to protect the probe from exposure to RF levels in excess of damage levels during transportation and storage.
- b. **Inspection.** To inspect the meter prior to use, perform the procedures contained in the following subparagraphs:
 - (1) Remove the meter and probe assembly from the carrying case.
 - (2) Visually inspect the carrying case, meter and probes for evidence of shipping damage.
 - (3) Report any damage in accordance with applicable regulations.
- c. **Pre-operational Tests.** Prior to performing a pre-operational check, review the procedures contained in Section 4, Operating Instructions. To perform a pre-operational test, refer to Figure 4-1 and perform the procedures contained in the following subparagraphs:
 - (1) Make certain the meter is set to OFF, by depressing the "OFF" key (19).
 - (2) Connect connector P1 of the probe to PROBE connector J1 (7) on the meter.
 - (3) Depress the "ON" key (20) to energize the Model 8718.

NOTE

Refer to Section IV, Operation for detailed information pertaining to screen displays.

Model 8718

- (4) After a period of a few seconds, when the 8718 cycles to screen 2, depress F4 (11) "MENU" and then depress 4 (1) to display the battery test screen. If the battery level is below 20% the meter should be charged in accordance with paragraph 2-3. If the battery test level is above 20% press ESC (13) twice and continue with this procedure.

NOTE

The following step should be performed in an area of zero RF field and/or place probe in carrying case and close but do not latch cover. Do not let head of probe contact foam. Alternately, you may use the Model 8713 (E-Field Attenuator) to shield E-Field probes.

- (5) Depress F1 (3) on the meter to begin measurement routine.
- (6) Select a probe number by choosing F1 through F4. F1 through F3 is for probes that are stored in the 8718's memory. F4 displays additional choices. After choosing a probe you will be asked to confirm your choice. Depress F1 to accept the choice.
- (7) If probe is in zero density area, you may press ENTER (17) to begin zeroing.
- (8) If zeroing of the probe was completed successfully screen 9 will be displayed.
- (9) Refer to Table 1-3 to verify the type of probe you are testing. Probes have test points and/or arrows on their sensor end to help locate the position of the elements. Models 8721, 8723 and 8725 do not have test points, they have arrows that help locate the position of the sensors inside the probe. All other models have test points that are located by the arrows on the bottom of the probe head. Models 8722B, CN8722, EC8722, 8741 and E8741 probes have 6 test points and all other probes have 3 test points.
- (10) For models 8721, 8723 and 8725, hold probe head close to the Test window (10) on Model 8718. On Model 8718 depress the "TEST SOURCE" key (21). For all other models carefully align one of the probe contacts with probe test point TP1 (15). On Model 8718 depress the "TEST SOURCE" key (21).

- (11) Observe top line of display screen (9) for movement upscale and the second line to display a level. Failure of meter to detect indicates a malfunction of the meter. On some model probes the test may require 2 to 5 seconds to reach maximum reading.
- (12) The test source will remain energized for a period of 20 seconds.
- (13) Repeat steps (10) through (12) for each of the additional contacts on the probe assembly.
- (14) Turn meter off by depressing OFF (19) or make survey in accordance with the procedures contained in Section IV, Operation.

2-3 BATTERY CHARGING.

To recharge the battery of the Model 8718, refer to Figure 4-1 and proceed as follows:

- a. Connect battery charger cable to battery charger connector (4) on Model 8718.
- b. Connect line cord to battery charger and then to ac power source.
- c. Allow battery to charge for up to 24 hours (depending on state of charge).
- d. Disconnect line cord from ac power source and disconnect battery charger for Model 8718.



Figure 2-1. Probe Orientation During Pre-Operational Testing.

SECTION III

THEORY OF OPERATION

3-1. GENERAL.

This section provides an overall functional description of the meter. Following the overall functional description of the meter, detailed functional descriptions of the probe and meter are provided.

3-2. OVERALL FUNCTIONAL DESCRIPTION.

The meter is a portable, battery-operated instrument that forms a complete RF Radiation Survey System when used with an interconnected probe. Optionally, the system may employ a fiber optic based cable system between the probe and meter assemblies. The survey system is designed to detect electromagnetic fields and to display the field level on the meter LCD (Liquid Crystal Display). The probe detects the electromagnetic radiation, and transmits a signal to the meter for display. The meter processes the signals from the probe for viewing on a built-in display. The meter displays the field levels in various units dependent on the field component detected and the characteristics of the probe used. The following subparagraphs contain a functional description of the meter and probes.

- a. **Probe Functional Description.** The probe senses the electromagnetic fields and develops a signal for transmission to the meter. The probe has an isotropic sensing pattern so that the radiation may be sensed from any direction, except through the handle. Detectors in the probe sense the electromagnetic radiation present and apply signals to preamplifiers U1 and/or U2 located within the probe. Preamplifiers U1 and U2 amplify the signals from the detectors and route them to the meter via connector P1.
- b. **Meter Model 8718 Functional Description.** (See Figure 3-1.) The meter receives the signals from the probe, processes the signals and provides a visual display of the levels detected. Signals received from the probe at PROBE connector J1, are routed to amplifier U2. Amplifier U2 amplifies the signal from the probe and generates a signal to drive the A/D converter U3. The output of the A/D converter is routed to microprocessor U5 which drives the LCD. The meter also contains built-in self

Model 8718

testing facilities for checking the condition of the batteries, the operation of the probe and for zero adjustment of the probe. The operation of the meter for these functions is described in the following subparagraphs:

NOTE

Refer to Section IV, Operation for additional information pertaining to the Model 8718 screen displays.

- (1) **Battery testing.** The meter provides a means of testing the condition of battery B1. When the meter is set to display BAT TEST (screen 14), the battery charge level is displayed on the LCD display. If a battery is weak the battery test will display an operating time of 2 hours or less, thereby informing the operator that the battery should be charged.
- (2) **Automatic Probe zero adjustment.** The meter provides a means for automatically zero adjusting the meter and probe. When in an operating mode and the probe is in a zero field, the operator may depress the AUTO ZERO key to begin the autozeroing routine. The 8718 features a unique digital method of setting the zero reference.
- (3) **Probe test.** The meter provides a means of testing whether the probe is operational using built in test signal sources. The test is only for satisfying the user that the meter is operational by generating upscale indications on the Model 8718 meter.
 - (a) **HIGH FREQUENCY** - 10.5 GHz (nominal) oscillator and aperture for illuminating the probe. Power output is capable of producing an upscale indication on the meter of approximately 0.75 mW/cm^2 .
 - (b) **LOW FREQUENCY** - An external test point provides a 10 kHz (nominal) signal at the unit and test points on the probe to excite each low frequency elements and produce an upscale indication on the meter. The amount of deflection will vary depending on the model number of probe being used.

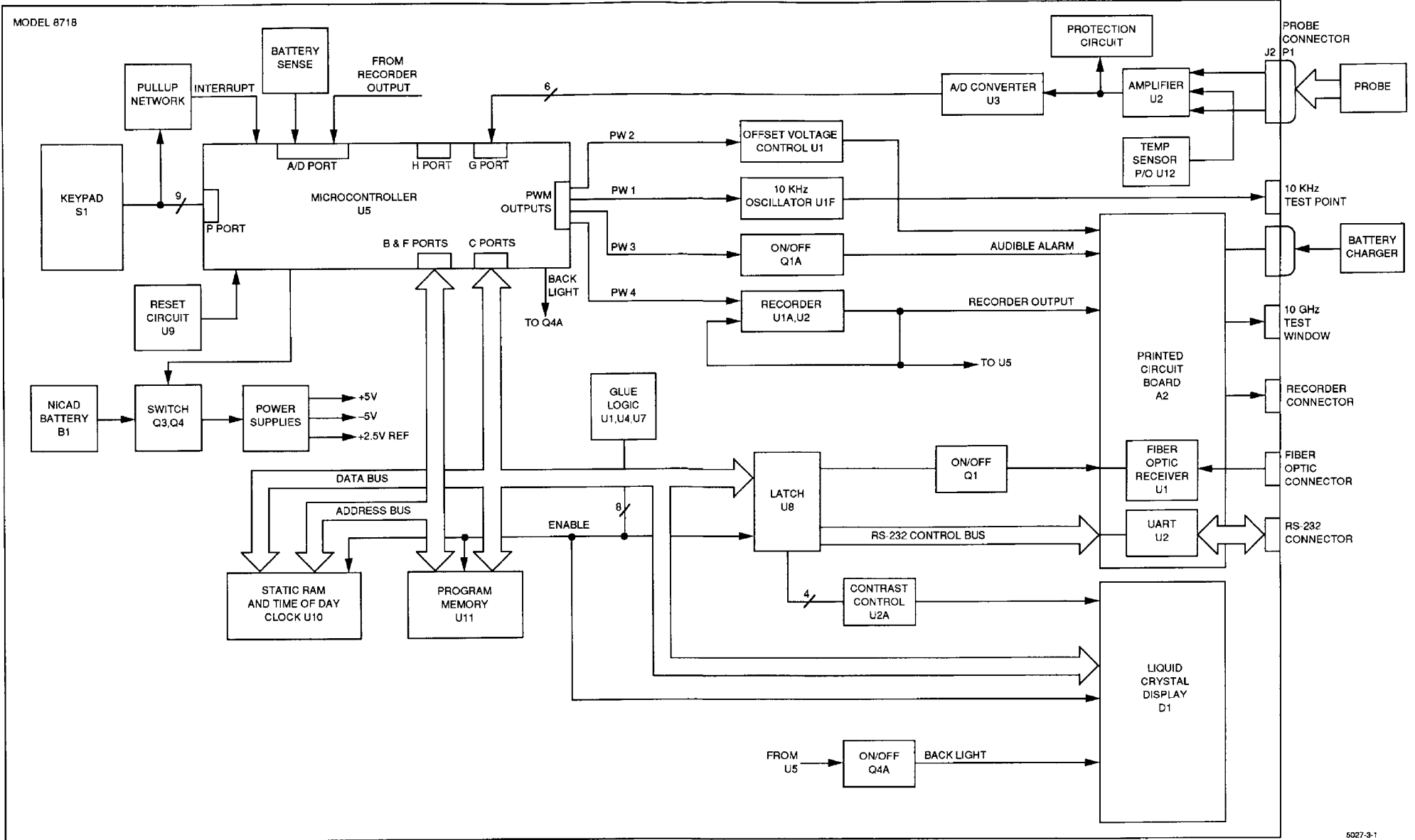

Figure 3-1. Model 8718, Functional Block Diagram

When the meter is fully operational (i.e., screen 9 is displayed) and the TEST SOURCE key is depressed, the tip of the probe test point is aligned with the test point of the meter or aligned with the high frequency test port. When the test source is operated, U5 (and part of U1) along with Q1A within the meter generate test signals that are sensed by the probe, causing the level displayed on the LCD to move upscale. If no change in reading is observed, either the probe or the meter may be defective. The test source automatically shuts off after twenty seconds.

3-3. PROBE DESCRIPTIONS.

Probes used with the Model 8718 consist of Electric and Magnetic field component measuring types. Model 8700 series probes have true square law characteristics providing an accurate summation of field levels present from multiple frequency sources. All probes are internally coated with a thin film, high resistive coating. This film is on the order of 0.5 megohm per square inch and provides a shield against electrostatic charges. All probes utilize a preamplifier at their base to amplify the detected signals from the sensors. Additionally, some may have a flat or shaped response. Dual probe amplifiers located in the handle are connected to the probe elements by inflexible monolithic resistive leads. This prevents cable modulation from affecting the signal derived from the elements. These amplifiers are commutating auto zero instrumentation amplifiers to provide automatic zeroing of the meter. Each instrumentation amplifier consists of three distinct sections: two analog, one digital. The two analog sections, a differential to single ended voltage converter and a commutating auto zero amplifier, have on-chip analog switches to steer the input and output signals. While one operational amplifier is processing the signal the second operational amplifier is in auto zero mode, charging a capacitor to a voltage equal to its DC error voltage. The amplifiers are connected and reconnected at a 5 kHz rate, so that all times one or the other of the on-chip amplifiers is processing the signal while the error voltages are being updated to compensate for variables such as low frequency noise voltage and input, offset voltage changes due to temperature, drift or supply voltage effects. The following descriptions cover in more detail the operation of available probes in greater detail.

3-3.1 Broadband E-Field Probes (Models 8722B, CN8722, EC8722, 8741, E8741). The 0.3 MHz to 40 GHz electromagnetic radiation shaped probes provide a frequency sensitivity characteristic that is the

Model 8718

inverse of the particular standard or guidance that they are shaped to, thus providing for readings in "% of Std". The broadband range is accomplished using both compensated diode and thermocouple detection. The Model 8741 (and E8741) uses the same detection type as the 8722 type probes, but is a flat response probe. In the lower frequency region below 1500 MHz, a dipole with diode detector and both distributed and discrete components is used. Three orthogonally mounted, conductive dipoles terminated in diode detectors form the low frequency detection characteristics. These diode detectors are operated in their square law region. This region is defined as that in which the DC diode current is proportional to the square of electric field tangential to the dipole. The elements which are used in the higher frequency region are thin-film thermocouples. They provide true square law output and function in two modes. Between 1.5 and 12 GHz, they are resistive dipoles. As a resistive dipole, each probe contains three mutually perpendicular elements. Above 12 GHz, it utilizes the phase delay of a traveling wave to produce additional output. In this mode, the dipole is aligned along the Poynting Vector with the cold junctions oriented tangential to the electric field. Each of the three mutually orthogonal elements contains four resistive dipoles with the cold junctions oriented at right angles. This provides for the independence of probe orientation relative to the polarization of the field.

The instantaneous charge distribution on adjacent cold junction elements produces a potential difference across the thin-film resistive thermocouples and a resultant dissipation of energy in these films. As the frequency increases, the phase difference between the potentials developed in adjacent junctions also increases the open circuit voltage.

3-3.2 Low Frequency E-Field Probes (Models 8742, 8760, E8760, 8761, E8761, 8762, E8762, 8782 and E8782). Three sensors are supported at one end of the probe along mutually orthogonal axes, each sensor consisting of a dipole-diode combination. The broad bandwidth is achieved through the capacitive divider effect of the dipole-diode combination. Some linearity correction is also provided for the upper portion of the high field strength scale. The dipoles are approximately 8 cm in length.

3-3.3 Low Frequency H-Field Probes (Models 8731, 8732, 8733, 8752 and 8754). These probes are responsive to the H-Field component. Each of the three mutually perpendicular coils in every probe has a diameter of 3.5 inches (8.9 cm), consists of multiple turns and is series resonated somewhat below the low

frequency end of the band. The RF current induced by the "H" field dissipates power in the thermocouple elements, heats the hot junctions and provides a DC output voltage proportional to the square of the induced current. Circuitry is added to minimize higher frequency out-of-band responses typical in many H-field probe designs.

3-3.4 High Frequency Probes (Models 8721, E8721, 8723 and 8725). Resistive thermocouples are distributed along the length of the dipole at spacings that will not permit resonance over the operating range of frequencies. The dipole may be viewed as a group of series connected small resistive dipoles or as a very low Q resonant circuit. Above 12 GHz as the element sensitivity decreases, another mode of operation becomes manifest. In this mode, the dipole is aligned along the Poynting Vector with the cold junctions oriented tangential to the electric field. Each of the three mutually orthogonal elements contains four resistive dipoles with the cold junctions oriented at right angles. This provides for the independence of probe orientation relative to the polarization of the field.

3-4. MODEL 8718 METER CIRCUITS.

The 8718 has five main assemblies. Printed circuit boards (PCB) A1 and A2, Keypad S1, LCD Display D1 and the Battery pack B1. This section will provide an overview of the printed circuit boards A1 and A2. Extensive use of surface mounted components are used on PCB A1. There are no adjustable components (i.e., potentiometers or variable resistors) used within the 8718. Calibration is performed using the RS-232 port, a voltage source and a computer.

3-5. PCB A1 FUNCTIONAL DESCRIPTION. The PCB A1 receives operating power from Battery B1 which is routed through Q3 and Q4 which form a momentary switch for the microcontroller U5. U5 provides a control signal to the +5V, -5V and +2.5V power supplies made up of U12, U13 and U14. The DC voltage output from the field sensing probe is coupled through the A2 PCB into an input amplifier made up of U2 and then input into the Analog to Digital converter U3. U3's digital output is applied to the microcontroller U5. The on board data bus is used to drive the LCD display. The data bus is interfaced with latch U8, static Random Access Memory (RAM) and Time-of-Day U10 and the program memory U11. The LCD module receives input from the data bus, along with a contrast control input from U8 through U2A, R2

Model 8718

and R21. The LCD backlight control is provided from P/O Q4 which is controlled by U5. The address bus circuit is made up of U5, U10, U11 and the glue logic circuit comprised of U4, U7 and parts of U1, U6 and U4. This circuit provides RS-232 interfacing through U8, which also controls A2U2, the RS-232 UART. The 10 GHz test source is controlled by U8 in conjunction with Q2 and Q3A. Microcontroller U5 also provides Pulse Width modulated (PWM) signals that are used by the 8718. The 10 kHz source control is provided by U5's PWM along with U1. The audible alarm circuit is driven by a PWM line and Q1. The Recorder Output is also controlled by a PWM line and U1 and U2.

SECTION IV

OPERATING INSTRUCTIONS

4-1. INTRODUCTION.

This section contains information pertinent to the proper operation of the Model 8718. To prevent possible operator injury and/or damage to the Model 8718, be sure to read this chapter thoroughly before operating the Model 8718.

4-2. CONTROLS AND INDICATORS.

For detailed descriptions of the Model 8718 operating controls and indicators, refer to Table 4-1. Using the index numbers shown in Table 4-1, refer to Figure 4-1 to locate and identify each control/indicator.

4-3. OPERATING INSTRUCTIONS.

For detailed operating instruction, refer to Table 4-2. Table 4-2 is divided in the three columns; display screen, description, and help screen. The display screen column shows the display screen that will be observed during the performance of the operating instructions contained in the description column. The help screen column shows the help screen that is associated with the display screen being displayed. The help screen associated with the display screen being displayed is displayed when the HELP key is depressed.

4-4. MEASUREMENT METHODS AND SURVEY HINTS

Before beginning the survey, allow time to warm up and checkout the equipment. When using thermocouple based probes it is advisable to allow the probe to stabilize to the ambient temperature. Allowing the probe to raise, or lower it's temperature to the ambient will help minimize "zero drift." If this cannot be accomplished in an area of flow field levels, it is recommended that a device equivalent to the Narda model 8713 Electric Field Attenuator be used to guard against probe overload.

NOTE

Thermocouple probes can be overloaded even when they are not in use!

Table 4-1. Controls and Indicators

Control/indicator nomenclature	Index number	Function
Keypad	1	Keypad keys 0 through 9 provide the means to enter numerical data, select probes, and select various display screens.
F2 Key	2	Provides the means to select and control various display screens.
F1 Key	3	Provides the means to select and control various display screens.
Battery charger connector	4	Provides the means to connect the battery charger to the Model 8718 to recharge the batteries.
Recorder output connector	5	Provides the means to connect a recorder to the Model 8718 to make a record of the signals detected by the probe.
Fiber optic connector	6	Provides the means to connect probes with fiber optic outputs to the Model 8718.
Probe connector	7	Provides the means to connect probes with electrical outputs to the Model 8718.
RS-232 connector	8	Provides the means to connect the Model 8718 to a computer for entering calibration data and reading stored data measurements from the Model 8718 using an RS-232 cable.
Display screen	9	Displays operating menus, screens, and measured data.
10.5 GHz test window	10	Provides 10.5 GHz electromagnetic radiation source for checking the operation of high frequency probes.
F4 Key	11	Provides the means to select and control various display screens.
F3 Key	12	Provides the means to select and control various display screens.
ESC (Escape) Key	13	When depressed, causes display screen to display menu or screen that was previously displayed.
AUTO ZERO Key	14	When the auto zero screen (screen 6, Table 4-2) is displayed and this key is depressed, the selected probe and Model 8718 are zeroed.
10 KHz test point	15	Provides 10 kHz electromagnetic radiation source for checking the operation of low frequency probes.

Table 4-1. Controls and Indicators - Continued

Control/indicator nomenclature	Index number	Function
HELP Key	16	When depressed, causes the HELP screen associated with a screen or menu to be displayed.
ENTER Key	17	When depressed, stores data previously entered at the keypad or data selected from a displayed screen or menu in the Model 8718 memory.
RANGE Key	18	When depressed, causes the display screen to display the range screen (screen 9c, Table 4-2).
OFF Key	19	When depressed, turns off the Model 8718.
ON Key	20	When depressed, turns on the Model 8718.
TEST SOURCE Key	21	When depressed, causes the 10.5 GHz test signal to be present at the 10.5 GHz Test Window and the 10 kHz test signal to be present at the 10 kHz test point for 20 seconds.

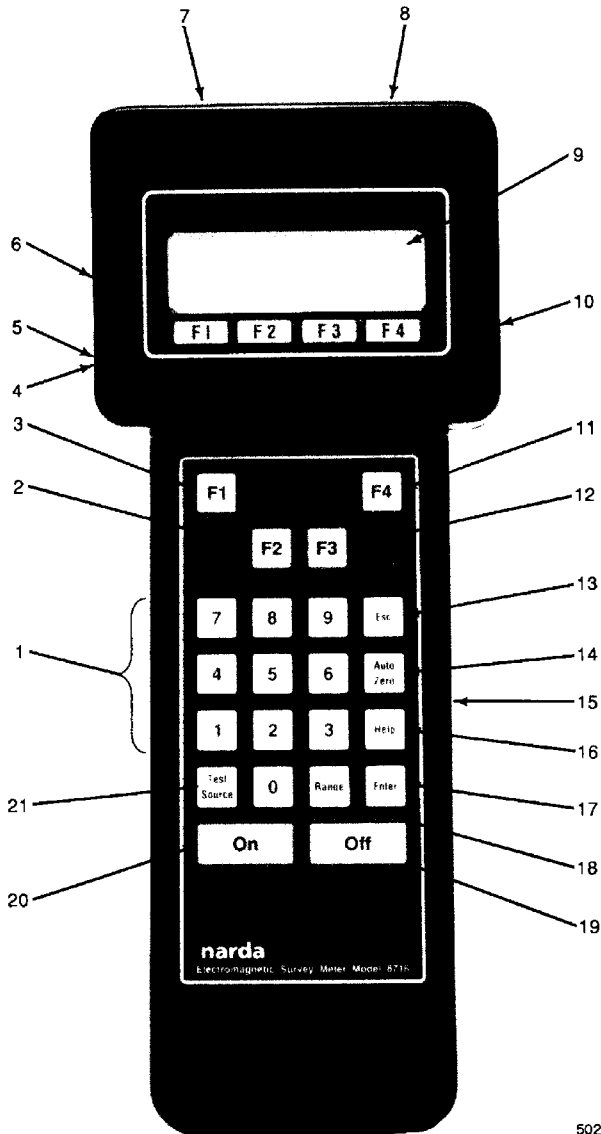

Figure 4-1. Model 8718 Controls and Indicators

Ensure the meter's batteries are charged enough to complete the survey and, use check sources to verify operation of the entire system.

Sites with multiple emitters are considerably more complex than single emitter sites. Mobile emitters can be moved about in a certain area further complicating site measurements and future survey validity. Additionally, time may be a major problem, both from the survey time required and coordination with people who will be required to operate the equipment. Such surveys require careful planning to insure minimal site disruption.

Begin the survey from a distance well beyond the calculated hazard distance. Always begin survey with the meter set on its highest (or AUTO) measurement range. While surveys are usually conducted to seek out the highest field levels, more meaningful results will be obtained if field readings are compared to calculated values at certain distances.

The probe should be held at the maximum distance from your body. If the direction to the emitter is not known, or if there are multiple emitters, the probe should be held at approximately a 45 degree angle. If there is a single emitter the probe should be pointed directly at the source to minimize isotropic errors. Accuracy can be further improved by taking the mean reading while rotating the probe about its main axis. Results should be conservatively rated. If the system error is 2 to 3 dB, then results should assume worst cases. In other words, multiply your readings by (in this case) 1.6 to 2.0. An antenna reflection can increase the field strength by a factor of 4 and you may wish to include this factor in your result.

Field levels are normally averaged over the whole body. The ANSI/IEEE C95.1 standard allows time averaging, but not whole body averaging, for exposures to the eyes and male testes' body areas. Again you may want to use a worst case example in your final data.

- a. **Microwave Frequency ($f > 300$ MHz) Surveys.** Rotating radars and other scanning sources present additional monitoring requirements. You may wish to use the Narda Model 8718's ability to allow time averaged results of scanning sources. Some surveyors will choose not to time average these sources if there are no provisions to disable the emissions should the motor, or scanning software fail. In this instance the scanning should be disabled when performing the measurements. Also consider

Model 8718

figure 4-2 "field strengths in front of an antenna," below. Being closer to the antenna may not result in higher readings due to the radiation pattern. Make sure you are in the beamwidth, for measurable levels.

- b. **Radio Frequency (f=30 to 300 MHz) Surveys.** When surveying this frequency range, readings may be effected by the distance between your body and the survey equipment. Specifically, your body becomes a large reflector increasingly affecting the probe as you move into the lower part of this frequency range. For the most accurate measurements in this frequency range, we recommend that you maintain a distance of a few feet between your body and the probe. A simple way to do this is to place the probe on a non-metallic stand near the emitter, keeping the separation between the probe and you. For most standards both E and H field readings will be made separately and compared with standard, or guidance, limits. Antennas are normally omni-directional in their radiation patterns, so

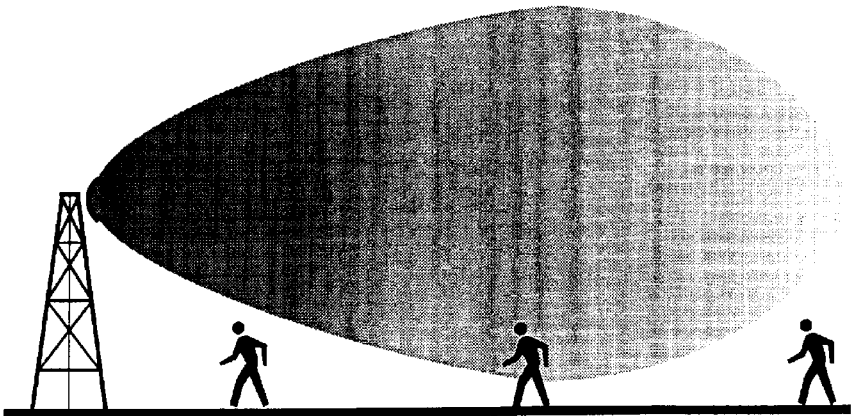

Figure 4-2. Field Strengths in Front of an Antenna.

measurements will be made around the entire area in question. Metallic structures may re-radiate and/or reflect the energy present thereby complicating the survey. In the United States the ANSI/IEEE standard includes limits for induced and contact currents, at frequencies below 100 MHz. Once you are within a distance of $\lambda/2\pi$ to the antenna, the reactive field components may be greater than 10% of the radiating components, leading to errors of greater than 1dB. Although the reactive components do not form part of the radiating field strength, they are real and can generate heating effects and/or induced currents.

- c. **Radio Frequency (3 kHz to 30 MHz) Surveys.** The problems with reflections off the body that begin to appear at 300 MHz (see paragraph 4.4b, above) become increasingly significant as move into even lower frequencies. Below 10 MHz the equipment is also affected. For accurate readings, you must do one of two things: (1) place the probe next to the meter, coiling up the probe's cable so that all components of the system are in the same strength field and put the entire assembly on a non-metallic stand, or (2) totally isolate the meter from the probe using a Narda Fiber Optic Link (Model 8745T or 8746) which allows you to remote the meter away from the probe while not conducting the emission through the cable to the meter. For best results, you will still need to minimize field perturbation caused by the surveyor by using a stand to support the probe. For low frequency antennas that employ guy wires, there will normally be a field radiated from them that should be measured. The level of the reading will be greatly effected by the measurement distance you use. The new ANSI/IEEE C95.1 standard recommends a minimum measurement distance of 20 cm. Most all other standards, or guidance's, list distances of 5 cm. Contact current hazards may be present when there are low (<100 MHz) frequency transmitters and conductive objects that may be touched by personnel. Ungrounded objects may store energy that will be discharged through a person's body when that object is touched. When in doubt, you should check metallic objects near the antenna. The Narda model 8870 Contact Current Meter provides the means to test contact currents, at frequencies below 30 MHz, for all major standards or guidances.

4-5. POST SURVEY REPORTING

Your post survey report is going to contain more than field readings. Valuable knowledge can be obtained from a complete listing of steps taken before, during and after the survey.

1. Emitter Information
2. Emitter Purpose
3. Site Map
4. Operational Procedures
5. Field Readings
6. Induced and/or Contact current Hazards (if emissions are <100 MHz)
7. Outline of Hazardous Areas
8. Existence of Ionizing Radiation
9. Control Procedures (Lockout-Tagout, Permit to Work, etc).
10. Existence of any other Hazards (Fuel Storage, Ordnance, etc).

After the survey steps may include:

1. Calculations performed before the survey (If readings do not match calculations, this should be explained)
2. Hazard Areas
3. Field readings at areas normally accessible by people
4. Hot Spots
5. Existence and adequacy of engineering controls and Warning Signs
6. Use of and Operating procedures to control Exposures
7. Attitudes of workers related to RF Radiation
8. Drawings, Sketches or Photographs of area
9. Conclusions and Recommendations

If your survey determined that there are areas that are potentially hazardous, you may want to also provide information such as:

1. Where warning signs are placed, or should be
2. Engineering Controls
3. Antenna restriction devices
4. Use of Terminations or dummy loads when testing
5. Use of barriers, interlocks and visual/audible alarms
6. Area or Personal monitors that continually monitor for excessive fields, should any of the above measures fail

4-6. SURVEYING UNINTENTIONAL EMITTERS

Leakage surveys vary considerably from surveys involving known emitters such as antennas. In most cases there are no field calculations that can be performed before the survey. Operation of your survey equipment is as discussed in paragraph 4-3 of this manual. This paragraph of the manual will concentrate on the most common types of leakage surveys. The three types of surveys are 1. Microwave Ovens, 2. Industrial Equipment and, 3. Transmissions Line leakage.

- a. **Microwave Ovens.** Microwave oven standards regulate the permissible leakage around the perimeter of the oven, not human exposure. This leads to a difference in the basic design of the survey equipment. The instruments required to measure this leakage are one-directional or anisotropic. This design helps ensure that only the oven is being tested, rather than having measurements potentially disturbed by other sources in the immediate area. The Narda Model 8217 is the recommended piece of test equipment (rather than the 8718 meter with 8700 series probes). The U.S. Code of Federal Regulation (CFR) 21 part 1030, specifies the maximum amount of leakage from the oven at distances of 5 cm - 1.0 mW/cm^2 before the oven is sold and $<5.0 \text{ mW/cm}^2$ throughout its operating life. Similar standards are used in other countries.

Model 8718

- (1) **Presurvey Inspections.** Microwave ovens have built-in safety features that should be checked before surveying for leakage. Visual inspections of the door hinges, door seals and latch mechanism should be performed. The latch mechanism can be checked by insuring the oven stops operation when the door is opened. Excessive food around the door gasket can increase leakage, so ovens need to be kept clean.
- (2) **Oven Surveys.** Microwave ovens are normally tested when operating on their highest power level, and with a load of water (approx. 275 ml.). The test equipment is scanned about any surface of the oven, paying close attention to the area of the door seal, holding the probe horizontally. Most surveying equipment will have a 5 cm spacer to allow you to hold the probe against a surface. Response time for Oven meters is usually around 1 second, but can be up to 3 seconds, so you will need to scan the surface at an appropriate speed. The Narda Model 8217 can perform additional testing, allowing you to test the output power of the oven by monitoring the temperature rise of the water load.

b. **Industrial Equipment.** Industrial equipment that is used for heating, drying and sealing is very common in the workplace. These systems can operate from a few Hertz, as in the case of induction heating at foundry's, or up to hundreds of Kilohertz for annealing applications. Sputtering and Plasma equipment usually operates at 13.56 MHz and heat scaling or vinyl welding devices usually at 27.12 MHz. Before beginning your survey, the emission frequency should be checked with a frequency counter, spectrum analyzer or manufacturer supplied data. Spectrum analysis is useful for also determining if the equipment in question is generating multiple emissions, or harmonics, when operating its highest power level. With industrial surveys it is important to consider both whole body averaging and time averaging. Most processes use high power for a short period, which allows for considerably lower averaged exposure levels. When surveying it is normally beneficial to use a "story pole" that will allow you to mark various survey heights and repeatable measure at the same point. High power handling is also worth mentioning here. The Models 8762 and 8733 (or 8752) are the most useful probes for surveying these devices because of their high power overload levels. When

surveying a device that operates at 27.12 MHz, you will most likely be in the near field. The wavelength at this frequency is approximately 11 meters, which means that, because of the proximity to the source, power may increase greatly with only a slight change of probe position. Australia, Canada, the United Kingdom and the United States have limitations on contact current. In the U.S. there are also limitations on induced body currents. Such limitations should be considered when planning to perform low frequency (<100 MHz) surveys. In a document published in 1989, the U.S. National Institute of Occupational Safety and Health (NIOSH) stated that measuring the induced body current may provide the most direct indication of absorbed energy. Compliance measurements at frequencies below 100 MHz now include both field and current measurements. If field measurements approach standard or guidance limits then you should measure currents. Contact current measurements are performed by the Narda Model 8870. These measurements may be recommended around lower frequency (<30 MHz) Industrial equipment. Low frequency Induction Heating equipment can generate significant contact currents. For measurements of induced currents the Narda Model 8850 Induced current meter coupled with the Model 8858 Human Equivalent Antenna provides unique capabilities. This special antenna allows you to "standardize" measurements and to perform measurements without a human subject. By using a standard antenna you may not have to check each piece of industrial equipment with each operator, thereby decreasing exposures. These two products also allow you to evaluate the effectiveness of wooden or other dielectric platforms that can decrease induced currents by factors of 10 or more.

- c. **Transmission Line leakage.** A common example of leakage measurements is testing waveguide flanges. Waveguide flanges and bends are likely points of leakage in high power systems. Gaskets in flanges may deteriorate after being cycled over temperature many times. Bends also tend to form stress cracks from temperature and mechanical stress. When testing waveguide systems, most people will probe as closely as possible to the suspected areas. Normally, defective flanges can be tightened, while bends will have to be removed from the system for repair or replacement. In many systems the waveguide may be positioned so close it may be difficult to test certain points. In the

Model 8718

past it was common to use a waveguide antenna to search for leaks. This approach is often difficult and time consuming, because of the amount of equipment available. A newer and safer method is to use the Narda Model 8781 Flexible Probe which has a very small detector housing. Its long length keeps your hands away from the high voltage that is normally present in high power amplifiers.

Table 4-2. Operating Instructions

Display screen	Description	HELP screen
<p style="text-align: center;">1</p> <div style="border: 1px solid black; padding: 5px; width: fit-content; margin: auto;"> NARDA 8718 SN 1000 9600 BAUD VER 1.0 </div>	<p>Depressing the ON pushbutton switch turns on the Model 8718 which displays this screen for approximately 2 seconds. The first line of this screen displays the Narda Model number. The second line displays the serial number of the Model 8718. The third line displays the operating BAUD rate and the software revision level.</p>	
<p style="text-align: center;">2</p> <div style="border: 1px solid black; padding: 5px; width: fit-content; margin: auto;"> CAL DATE 07/15/94 CAL DUE 07/14/95 CONNECT PROBE NOW F1=MEASURE F4=MENU </div>	<p>A. Approximately 2 seconds after the Model 8718 is turned on, the calibration screen is displayed. The first line of this screen displays the last date that the probe was last calibrated. The second line displays the date that probe is due for calibration. The third line informs the operator to connect the probe to the Model 8718.</p> <p>B. Depressing the F1 (MEASURE) key allows the operator to begin the measurement sequence and causes screen 3 to be displayed.</p> <p>C. Depressing F4 (MENU) key provides the means for the operator to review menu settings determined by main menu screens 10, 20, and 30.</p> <p>D. Depressing the HELP key displays the HELP screen. Depress the ESC to return to screen 2.</p>	<div style="border: 1px solid black; padding: 5px; width: fit-content; margin: auto;"> CAL DATE CAN ONLY BE CHANGED WITH COMPU- TER. CONSULT MANUAL SECTION V </div>

NOTE

Depressing the ESC key during operation of the Model 8718 causes the previously selected screen to be displayed.

Table 4-2. Operating Instructions – Continued

Display screen	Description	HELP screen
<p style="text-align: center;">3a</p> <div style="border: 1px solid black; padding: 5px; width: fit-content; margin: auto;"> <p>SELECT PROBE MODEL 8721 SN10000 OR SELECT FROM LIST XXXX YYYY ZZZZ PROBE</p> </div>	<p>A. The second line of this screen displays the model number and serial number of the last probe used when the Model 8718 was turned off. If you want to use the same probe, press ENTER key. If probe to be used is not displayed in line 2, proceed to step B.</p>	<div style="border: 1px solid black; padding: 5px; width: fit-content; margin: auto;"> <p>PROBES WITH CAL FAC- TORS IN MEM ARE DIS- PLAYED F1-F3. YOU MAY SELECT ANY FROM LIST</p> </div>
<p style="text-align: center;">3b</p> <div style="border: 1px solid black; padding: 5px; width: fit-content; margin: auto;"> <p>SELECT PROBE MODEL 8721 SN10000 OR SELECT FROM LIST XXXX YYYY ZZZZ MORE</p> </div>	<p>B. If the desired probe is not displayed in position XXXX, YYYY, or ZZZZ, proceed to step C. If the desired probe is displayed in position XXXX, YYYY, or ZZZZ; proceed as follows:</p> <ol style="list-style-type: none"> 1. If desired probe is displayed in position XXXX, depress F1 key. . 2. If desired probe is displayed in position YYYY, depress F2 key. . 3. If desired probe is displayed in position, ZZZZ, depress F3 key. . 4. After desired probe has been selected, line 2 of the screen displays the model number and serial number of the selected probe. Depress ENTER key. Observe that screen displays screen 5. <p>C. If the desired probe is not displayed in position XXXX, YYYY, or ZZZZ and "MORE" is displayed (Screen 3b), there are additional probes in memory. Depress F4 Key to access. If "PROBE" is displayed (Screen 3a) there are no additional probes in memory. Depress F4. Observe that screen displays Screen 4a.</p> <p>D. Depress the HELP key to display the HELP screen. Depress the ESC key to return to screen 3.</p>	

Table 4-2. Operating Instructions - Continued

Display screen	Description	HELP screen						
NOTE								
Screens 4a, 4b, and 4c will display all probes that are compatible with Model 8718. To store the correction factors for a specific model and serial number probe requires a computer and software supplied by Narda (refer to Section V).								
4a	<p>A. To select a probe listed on screen 4a, 4b, or 4c; proceed as follows:</p> <ol style="list-style-type: none"> 1. Use F1 key to page forward through screens 4a, 4b, and 4c. 2. Use F2 key to page backwards through screens 4c, 4b, and 4a. 3. Use F1 and/or F2, as required, to select screen that lists desired probe. 4. Depress number key that correspond to desired probe listed on selected screen. Observe that screen displays screen 5. 	<p>LIST OF PREDEFINED PROBES, # TO SELECT F1 TO PAGE FORWARD F2 TO PAGE BACK</p>						
<table style="width: 100%; border-collapse: collapse;"> <tr><td style="width: 50%;">1 8721</td><td style="width: 50%;">2 CN8722</td></tr> <tr><td>3 8722B</td><td>4 8723</td></tr> <tr><td>5 8725</td><td>6 8731</td></tr> <tr><td>7 8732</td><td>8 8733</td></tr> </table>			1 8721	2 CN8722	3 8722B	4 8723	5 8725	6 8731
1 8721	2 CN8722							
3 8722B	4 8723							
5 8725	6 8731							
7 8732	8 8733							
4b	<p>B. Depress the HELP key to display the HELP screen. Depress the ESC key to return to screen 4a, 4b, or 4c.</p>							
<table style="width: 100%; border-collapse: collapse;"> <tr><td style="width: 50%;">1 8741</td><td style="width: 50%;">2 E8741</td></tr> <tr><td>3 8752</td><td>4 8754</td></tr> <tr><td>5 8760</td><td>6 E8760</td></tr> <tr><td>7 8761</td><td>8 E8761</td></tr> </table>			1 8741	2 E8741	3 8752	4 8754	5 8760	6 E8760
1 8741	2 E8741							
3 8752	4 8754							
5 8760	6 E8760							
7 8761	8 E8761							
4c	<p>When a probe has been selected, screen 5 will appear.</p> <ol style="list-style-type: none"> Verify that line 1 of the screen displays the model number and serial number of the selected probe. Serial number will only be displayed if probe calibration factors are in memory. Observe that lines 2 and 3 of the screen display the characteristics of the selected probe. 	<p>VERIFY MODEL AND S/N ON PROBE HANDLE. THIS WILL HELP ENSURE PROPER READING</p>						
<table style="width: 100%; border-collapse: collapse;"> <tr><td style="width: 50%;">1 8762</td><td style="width: 50%;">2 E8721</td></tr> <tr><td>3 E8762</td><td>4 8782</td></tr> <tr><td>5 E8782</td><td>6 8781</td></tr> <tr><td>7 8742</td><td>8</td></tr> </table>			1 8762	2 E8721	3 E8762	4 8782	5 E8782	6 8781
1 8762	2 E8721							
3 E8762	4 8782							
5 E8782	6 8781							
7 8742	8							
5								
<p>XXXX SN-YYYY 300MHZ-40GHZ E-FLD 20 mW/cm2 FLAT YES NO HELP MENU</p>								

Table 4-2. Operating Instructions – Continued

Display screen	Description	HELP screen
	<p>C. Depress F3 (HELP), or HELP key to display the HELP menu. Depress ESC key to return to screen 5.</p> <p>D. If line 1 displays the model number and serial number of the selected probe, depress F1 (YES) or ENTER key. Observe that screen displays screen 6.</p> <p>E. If line 1 does not display the model number and serial number of the selected probe, depress F2 (NO) key. Observe that screen displays screen 3.</p>	

NOTE

When zeroing the system, you can use the transit case to provide a zero density environment. When using the transit case to zero the system, insure that the head of the probe does not touch the foam. Normally, the probe can be positioned in the area within the transit case that is normally occupied by the Model 8718. You can also use the Model 8713 E-Field Attenuator; or in the case of the Model 8721, 8723, or 8725 probes, aluminum foil can be wrapped around the head of the probe.

6

PLACE PROBE IN ZERO DENSITY FIELD. PRESS ENTER WHEN READY

To auto zero the Model 8718 and the selected probe, proceed as follows:

USE TRANSIT CASE TO PROVIDE ZERO DENSITY AREA. DO NOT LET HEAD OF PROBE TOUCH FOAM

A. Depress ENTER key. Observe that screen displays screen 7.

7

ZEROING...

B. This screen will be displayed while the Model 8718 and selected probe are being zeroed. When the Model 8718 and selected probe are successfully zeroed, the screen will display screen 9. If the Model 8718 and selected probe cannot be zeroed, the screen will display screen 8.

Table 4-2. Operating Instructions - Continued

Display screen	Description	HELP screen
8	<p>If the Model 8718 and selected probe can not be zeroed, proceed as follows:</p> <ol style="list-style-type: none"> Insure that selected probe is in a zero density environment. If another probe of the same type is available, repeat the zeroing procedure. Depress F1 (RETRY) key. Observe that screen displays screen 6. Depress F4 (MENU) key to return to the probe menu (screen 3). 	<p>IF UNABLE TO ZERO PROBE IT MAY BE DEFECTIVE. TRY ANOTHER PROBE OR SEE MANUAL</p>
<p>CAN NOT ZERO-CHECK PROBE CONNECTION AND ENSURE ZERO FIELD RETRY MENU</p>	<p>NOTE</p>	
	<p>If the Model 8718 has been turned off and then turned on, and the same probe is to be used that was used when the Model 8718 was turned off, screen 9 can be quickly reached from screen 2 by depressing the F1 key once and then depressing the ENTER key three times.</p>	
9	<p>Line 1 of this screen displays the analog bar graph display. Line 2 of this screen displays the last units used when a measurement was made unless the probe has been changed. Line 3 displays the maximum level measured or the percentage of the standard chosen and the frequency last used when a measurement was made. Line 4 provides the means to change operating parameters of the Model 8718. To change these operating parameters, proceed as follows:</p> <ol style="list-style-type: none"> Depress F1 key to log the value of the current reading with a time and date stamp. Depress F2 (MENU) key to access the main menu screen 10. Observe that screen displays screen 10. 	<p>SELECT F1 TO STORE READING. F2 DISPLAYS MENUS. F3 FOR %STD. F4 TO CHANGE FREQ.</p>
<p>0.00 mW/cm² .0000 MAX 10.00GHZ LOG MENU %STD FREQ</p>		

Table 4-2. Operating Instructions – Continued

Display screen	Description	HELP screen
----------------	-------------	-------------

- C. Use F3 key to toggle display between MAX and %STD. When MAX is displayed on line 3, the corresponding value displayed is the maximum value measured during the measurement. When %STD is displayed, the corresponding value is displayed as the percentage of the standard value selected (refer to screens 10, 20, and 26). Pressing F3 twice resets or simply selecting the %STD mode automatically resets the maximum hold value.
- D. The F4 (FREQ) key provides the means to change the frequency. To change the frequency, proceed as follows:

NOTE

Line 2 of screen 9a displays the correction factor of the selected probe if this correction factor is stored in the model 8718. To change this correction factor, refer to screens 9, 10, and 13.

9a

ENTER FREQ. 10.00GHZ COR. FACTOR 1.12 KHZ MHZ GHZ SAVE
--

1. Depress F4 (FREQ) key. Observe that screen displays screen 9a.
2. Using keypad key, enter desired frequency. The format of this frequency is four digits with no decimal point. Observe that screen displays correct numerical value of desired frequency.
3. To select kHz as units of frequency, depress F1 (KHZ) key. Observe that screen displays desired frequency in KHZ.
4. To select MHz as units of frequency, depress F2 (MHZ) key. Observe that screen displays desired frequency in MHZ.
5. To select GHz as units of frequency, depress F3 (GHZ) key. Observe that screen displays desired frequency in GHz.

Table 4-2. Operating Instructions - Continued

Display screen	Description	HELP screen
9b	<p>6. Depress F4 (SAVE) key. Observe that screen displays screen 9 with the desired frequency displayed. If the frequency selected is outside of the range of the selected probe, the screen will display screen 9b.</p> <p>7. Press any key. Observe that screen displays screen 9a. Repeat steps 2 through 6 to enter correct frequency.</p>	
<div style="border: 1px solid black; padding: 5px; text-align: center;"> <p>FREQUENCY ENTERED OUTSIDE OF PROBE MEASUREMENT RANGE PRESS ANY KEY</p> </div>	<p>NOTE</p> <p>When screen 9 is displayed, the RANGE and TEST SOURCE keys are enabled and can be used.</p>	
9c	<p>E. To select a range, proceed as follows:</p> <p>1. Depress RANGE key. Observe that screen displays screen 9c.</p> <p>2. If line 2 does not display desired range, depress F1 (HIGH) key to select high measurement level range, F2 (MID) key to select middle measurement level range, F3 (LOW) key to select low measurement level range, or F4 (AUTO) key to select auto range.</p>	
<div style="border: 1px solid black; padding: 5px; text-align: center;"> <p>SELECT A RANGE THE RANGE IS AUTO HIGH MID LOW AUTO</p> </div>	<p>TEST SOURCE OPERATION</p> <p>The TEST SOURCE key provides a 10.5 GHz test RF electromagnetic source at the 10.5 GHz Test Window and a 10 kHz RF electromagnetic source at the 10 kHz test point. These sources are provided to check the operation of the Model 8718 and selected probe.</p>	

Table 4-2. Operating Instructions – Continued

Display screen	Description	HELP screen
	F. Depress TEST SOURCE key. This causes the RF electromagnetic sources to be present at the 10.5 GHz Test Window and the 10 KHz test point for approximately 20 seconds.	
	G. Place probe close to the 10.5 GHz Test Window or 10 KHz test point (determined by frequency range of probe being used). Observe that screen 9 indicates an upscale indication.	

NOTE

The Model 8718 has three main menus (screens 10, 20, and 30 and their associated subordinate screens). These screens provide the means to customize measurements, store the customized parameters, and control the complete measurement process. Screen 10 is accessed from screen 9 when the F2 (MENU) key is depressed.

10

1=SETUPS	5=PROBE
2=DISPLAY AV	6=UNITS
3=COR FACT	7=AUDIO
4=BAT TEST	8=NEXT

To perform operation from menu screen 10, proceed as follows:

- A. Depress key 1 to select the setup screens. Observe that screen displays screen 11. Screen 11 provides the means to save up to nine setups which include probe model and serial number, units of measurement, frequency, calibration factors and time averaging.
- B. Depress key 2 to select the display averaging screen. Observe that screen displays screen 12. Screen 12 provides the means to change the display screens response rate.
- C. Depress key 3 to select the correction factor screen. Observe that screen displays screen 13. Screen 13 provides the means to change the correction factor.

Table 4-2. Operating Instructions – Continued

Display screen	Description	HELP screen
	E. Depress key 5 to select the probe screens. Observe that screen displays screen 15. Screen 15 provides the means to review the probes which have their correction factors stored in the Model 8718.	
	F. Depress key 6 to select the units screen. Observe that screen displays screen 16. Screen 16 provides the means to change the units of measurements displayed to those employed in a particular standard or guidance that measurements are being made to.	
	G. Depress key 7 to select the audio screen. Observe that screen displays screen 17. Screen 17 provides the means to adjust the point at which the audio alarm is activated.	
	H. Depress key 8 to select the second main menu. Observe that screen displays screen 20.	
	I. To return to screen 9 depress ESC key.	

11

```

SET#0 87XX SNXXXXX
XX.XXG D V/m 50%
1.00 J1 AVG OFF
LOG OFF 10/MIN 1.5HR

```

This screen displays the main parameters. Up to four setups can be stored in the Model 8718. Line 1 of this screen displays the setup number and the probe model and serial number. Line 2 displays the selected frequency, display average, units, and audio alarm setting. Line 3 displays the correction factor, probe input to be used (J1, probe connector, or FO, fiber optic connector), and whether averaging is on or off and if it is on which averaging mode is selected. Line 4 displays whether the log (store) mode is on or off, the measurement rate, and the duration of the logged data (how long data is to be logged). When screen 11 is first displayed from screen 10, the SET #0 screen is displayed. This screen displays the presently entered main parameters. To store these main parameters or select a previously stored set of main parameters, proceed as follows:

```

F1 NEXT    F2 BACK
F3=SAVE PRESENT SET
OF MODES & VALUES
F4=RECALL/ACTIVATE

```

Table 4-2. Operating Instructions – Continued

Display screen	Description	HELP screen
	<p>A. To store the existing main parameter displayed on the SET #0 screen, proceed as follows:</p> <ol style="list-style-type: none"> 1. Use F1 key to page forward through the setup screens. 2. Use F2 key to page backwards through the setup screens. 	
	<p>NOTE</p>	
	<p>If a setup screen is selected that contains previously stored main parameter data, the existing main parameter data displayed on the SET #0 screen will be stored over the selected setup screen.</p>	
	<ol style="list-style-type: none"> 3. Use the F1 and/or F2 keys to select the desired setup screen number. 4. Depress F3 key to store the existing main parameter data on the selected setup screen. 5. Depress ESC key to return to screen 10. 	
	<p>B. To select a previously stored set of main parameters, proceed as follows:</p> <ol style="list-style-type: none"> 1. Use the F1 and/or F2 keys to display the setup screen that contains the desired main parameters. 2. Depress the F4 key to recall and activate the stored setup. 3. Depress ESC key to return to screen 10. 	

Table 4-2. Operating Instructions - Continued

Display screen	Description	HELP screen
12	<p>This screen provides the means to change the rate at which the displayed measurement is updated. This feature is useful for stabilizing low level measurement. The 4:1 ratio, when selected, causes the Model 8718 to perform four measurements, calculate the average of these four measurement, and then display this calculated average when measurements are being made (screen 9). When the 10:1 ratio is selected; 10 measurements are made, averaged, and displayed. When the 16:1 ratio is selected, 16 measurement are made, averaged, and displayed. When the 24:1 ratio is selected; 24 measurements arc made, averaged, and displayed. To select the desired ratio, proceed as follows:</p>	<p>F1, F2 MAKES DISPLAY RESPOND FASTER F3, F4 MAKES DISPLAY RESPOND SLOWER</p>
<p>TO CHANGE DISPLAY AVERAGING RATIO USE F1-F4 KEYS 4:1 10:1 16:1 24:1</p>	<ol style="list-style-type: none"> A. Depress the F1 (4:1) key to select the 4:1 ratio. Observe that screen displays screen 10. B. Depress the F2 (10:1) key to select the 10:1 ratio. Observe that screen displays screen 10. C. Depress the F3 (16:1) key to select the 16:1 ratio. Observe that screen displays screen 10. D. Depress the F4 (24:1) key to select the 24:1 ratio. Observe that screen displays screen 10. 	

NOTE

This does not change the speed at which the 8718 samples. This feature only changes the rate at which the display is updated.

Table 4-2. Operating Instructions - Continued

Display screen	Description	HELP screen
<p style="text-align: center;">13</p> <div style="border: 1px solid black; padding: 5px;"> <p>YOU MAY ENTER ONE CORRECTION FACTOR CORR. FACTOR 1.00 THEN PRESS ENTER</p> </div>	<p>This screen provides the means for entering or changing a correction factor. This can be used to compensate for the measurements being made, or to use a correction factor that has been developed for a specific frequency rather than the correction factor provided with the specific probe. It provides the means to enter a correction factor for a calibrated probe that is not stored in the Model 8718. To enter a correction factor, proceed as follows:</p>	
	<p>NOTES</p>	
	<p>Correction factors of from 0.50 to 2.00 can be entered. Correction factors are entered as three digit numbers without the decimal point.</p>	
	<p>If you are surveying in an area that may have more than one emitter, it is recommended that a correction factor of 1.00 be used.</p>	
	<p>A. Sequentially depress the three number (0 through 9) keys that correspond to the correction factor to be entered.</p> <p>B. Depress ENTER key and then the ESC key. The correction factor (CF) will be shown on the third line of the display screen.</p>	
<p style="text-align: center;">14</p> <div style="border: 1px solid black; padding: 5px;"> <p>██████████ BATTERY LEVEL = 80% ESTIMATED TIME=36HRS BACKLIGHT OFF MENU</p> </div>	<p>Line 1 of this screen provides an analog bar graph which represents the level of the battery. Line 2 indicates the battery level as a percentage. Line 3 indicates the estimated operating time remaining in the battery for the selected mode of operation. If the battery level is less than 20% it should be recharged before continuing the survey. This screen also provides the means to turn the backlight on and off and adjust the contrast of the display screen. To turn the backlight on and off and adjust the contrast of the display screen, proceed as follows:</p>	<div style="border: 1px solid black; padding: 5px;"> <p>F3 TURNS BACKLIGHT ON/OFF. 0-9 ON KEY- BOARD ADJUSTS CONTRAST</p> </div>
	<p>A. Use the F3 key to toggle the backlight on and off as indicated on line 4 of the screen.</p>	

Table 4-2. Operating Instructions – Continued

Display screen	Description	HELP screen
	<p>B. Use the 1 through 9 keys to control the contrast of the display screen. Lower numbers will lighten the contrast while higher number will darken the contrast.</p> <p>C. Depress F4 (MENU) key to return to screen 10.</p>	
15	<p>These screens provide a listing of all probes which have calibration factors stored in the Model 8718 memory. To review this listing, proceed as follows:</p> <p>A. Use the F1 (MORE) key to page forward through the probe list.</p> <p>B. Use the F2 key to page backward through the probe list.</p> <p>C. Depress the ESC key to return to screen 10.</p>	
<div style="border: 1px solid black; padding: 5px;"> <p>8721 SN XXXXX 300 MHZ-40 GHZ E-FLD 20 mW/CM2 FLAT MORE</p> </div>		<div style="border: 1px solid black; padding: 5px;"> <p>ONLY THOSE PROBES STORED IN MEMORY ARE DISPLAYED. PRESS F1 AND F2 TO VIEW</p> </div>
16	<p>This screen provides the means to select the units that the measured value will be displayed in. When this screen is displayed, it will not show all possible units of measurement. Only the units of measurements that correspond to the probe being used will be displayed. For example, if a electric field probe is being used, the A/m [4] and (A/m)² [5] units will not be displayed.</p>	
		<div style="border: 1px solid black; padding: 5px;"> <p>CHOOSE ANY AVAILABLE UNITS TO DISPLAY READINGS FOR TEST TO YOUR STD</p> </div>
16a	<p>In addition, if a shaped probe (such as Model 8722B, CN8722, EC8722, 8742, or 8732) is being used the screen will display screen 16a. To select the units of measurement for other probes, refer to screen 16 and proceed as follows:</p> <p>A. Depress number (0 through 8) key that corresponds to desired units of measurement.</p>	
<div style="border: 1px solid black; padding: 5px;"> <p>SHAPED PROBES CAN ONLY DISPLAY IN % OF STD</p> </div>		

Table 4-2. Operating Instructions – Continued

Display screen	Description	HELP screen
17	<p>This screen provides the means to select an alarm mode that is a percentage of full scale, or select a variable alarm mode. The percentage of full scale alarm mode causes the audible alarm to be sounded continuously when the measured level exceeds the selected percentage of full scale. The variable alarm mode causes the audible alarm to be sounded at an increasing repetition rate as the measured level increases above the selected percentage of full scale. To set the audible alarm, proceed as follows:</p>	<p>ENTER TWO DIGITS FOR %FS OF ALARM SETTING F1/F2=NORMAL MODE F3/F4=PULSED MODE</p>
<p>AUDIO ALARM SETTINGS TYPE NUMBER THEN ENT 99% OF FS AUDIO-OFF ON OFF ON VAR OFF</p>	<p>NOTE</p> <p>The variable alarm mode is not available under software revision 1.0.</p> <p>A. Sequentially depress two number (0 through 9) keys that correspond to the desired percentage of full scale.</p> <p>B. Depress ENTER key. Observe that line 4 displays desired percentage OF FS.</p> <p>C. Depress F1 (ON) key to turn on percentage of full scale alarm mode. Observe that line 3 displays AUDIO=ON.</p> <p>D. Depress F2 (OFF) key to turn off percentage of full scale alarm mode. Observe that line 3 displays AUDIO=OFF.</p> <p>E. Depress F3 (ON) key to turn on variable alarm mode. Observe that line 3 displays AUDIO=ON.</p> <p>F. Depress F4 (OFF) key to turn off variable alarm mode. Observe that line 3 displays AUDIO=OFF.</p>	
20	<p>A. Depress 1 key to select the select input mode. Observe that screen displays screen 21. Screen 21 provides the means to select the input at the probe connector or the input at the fiber optic connector.</p>	
<p>1=CABLE/FO 5=RS232 2=TIME AVG 6=STDS 3=DATA LOG 7=BACK 4=TIME SET 8=NEXT</p>		

Table 4-2. Operating Instructions – Continued

Display screen	Description	HELP screen
	<p>B. Depress 2 key to select the time averaging screen. Observe that screen displays screen 22. Screen 22 provides the means to time average the measurements over fixed or variable times.</p>	
	<p>C. Depress 3 key to select the data logging screen. Observe that screen displays screen 23. Screen 23 provides the means to store measurements for display at a later time using computer.</p>	
	<p>D. Depress 4 key to select the time and date screen. Observe that screen displays screen 24. Screen 24 provides the means to set the date and time of the clock within the Model 8718.</p>	
	<p>E. Depress 5 key to select the RS-232 screen. Observe that screen displays screen 25. Screen 25 provides the means to select the BAUD rate and turn the RS-232 port (at RS-232 connector) on and off.</p>	
	<p>F. Depress 6 key to select the standards screen. Observe that screen displays screen 26.</p>	
	<p>G. Depress 7 key to return to screen 10.</p>	
	<p>H. Depress 8 key to select the third main menu. Observe that screen displays screen 30.</p>	
21	<p>This screen provides the means to select the electrical input at the probe connector or the optical input at the fiber optic connector as the source of the measurement. When using the 8745T Fiber Optic transmitter select the fiber optic input. When using a probe with an electrical output or the 8746 Fiber Optic Cable System, select the cable input. Use F1 and F2 keys, as required, to select the cable or fiber optic input.</p>	<p>PRESSING F1 AND F2 CHANGES INPUT USED</p>
<p>SELECT INPUT CABLE=ON FIBEROPTIC=OFF ON OFF</p>		

Table 4-2. Operating Instructions - Continued

Display screen	Description	HELP screen
<p style="text-align: center;">22</p> <p style="text-align: center;">TIME AVERAGING AVERAGING DISABLED F1=ENABLE ON</p>	<p>All Standards or Guidance specify a certain time period that measurements are to be averaged over. Some are constant at a one or a six minute rate. Others change their averaging time as determined by frequency or environment (controlled versus uncontrolled). To enable and select the desired time averaging, proceed as follows:</p>	<p style="text-align: center;">TO START AVERAGING PRESS F1.</p>
<p style="text-align: center;">22a</p> <p style="text-align: center;">AVERAGING ENABLED F1=DISABLE F2=FIXED F3=SPATIAL F4=INTL STANDARDS</p>	<p>A. Depress F1 (ON) key. Observe that screen displays screen 22a.</p> <p>B. This screen provides the means to select desired averaging mode of operation; fixed time, operator control, or time set by standard. To select the desired averaging mode of operation, proceed as follows:</p> <ol style="list-style-type: none"> 1. Depress F2 key to select the fixed time averaging mode of operation. Observe that screen displays screen 22b. 2. Depress F3 key to select operator controlled averaging mode of operation. Observe that screen displays screen 22e. 3. Depress F4 key to select the time set by standard averaging mode of operation. Observe that screen displays screen 22c. 4. Depress F1 key to disable time averaging mode. Observe that screen displays screen 22. 	<p style="text-align: center;">SELECT AVG. MODE F2=FIXED TIME F3=OPERATOR CONTROL F4=TIME SET BY STD.</p>
<p style="text-align: center;">22b</p> <p style="text-align: center;">FIXED TIME AVERAGING PRESENTLY = X.XX MIN F1=30 SEC. F2=1 MIN F3=6 MIN F4=30 MIN</p>	<p>Depress F1, F2, F3, or F4 to select desired fixed time averaging time period, 30 seconds, 1 minute, 6 minutes, or 30 minutes. Observe that screen displays screen 22c with the selected fixed time displayed in line 2.</p>	<p style="text-align: center;">SELECT TIME DURATION REQUIRED</p>

Table 4-2. Operating Instructions – Continued

Display screen	Description	HELP screen
22c	<p>This screen provides the means to select either a single averaged measurements for display or multiple (continuous) averaged measurements to be displayed at a selected rate.</p>	<p>SELECT A SINGLE TIME AVERAGED MEASUREMENT OR CONTINUOUS AVERAGING PERIODS</p>
22d	<p>This screen provides the means to select how often the measurement displayed on the screen will be updated during the fixed time averaging measurement period. Line 2 of this screen provides an indication of the duration of the measurement period. To select how often the displayed measurement is to be updated, proceed as follows:</p>	<p>SELECT HOW OFTEN YOU WISH LCD TO BE UPDATED WITH AVERAGED DATA</p>
22e	<p>This screen is the main measurement screen that is displayed during time averaged measurements. The second line units will flash during the averaging. The number displayed before the average is 0.00 unless you just finished an average. If you want to LOG the final average, depress F2 before pressing any other key while the averaging mode is in effect. While averaging is in process screen 22f is displayed</p>	<p>SELECT F1 TO START F2=STORE LAST LOG F3=MAIN MENU F4=CHANGE FREQ.</p>

FIXED TIME AVERAGING
6.0 MINUTES
F1=SINGLE AVERAGE
F2=MULT. AVERAGES

- A. Depress F1 key to select a single averaged measurement for display.
- B. Depress F2 key to select multiple (continuous) averaged measurements for display. Observe that screen displays screen 22d.

FIXED TIME AVERAGING
XXX MIN CONTINUOUS
DISPLAY UPDATE RATE
10S 30S 1 MIN 6 MIN

- A. Depress F1, F2, F3, or F4 key to select the desired measurement update repetition rate; 10S (seconds), 30S, 1 MIN, or 6 MIN, respectively. Observe that screen displays screen 10.
- B. Depress ESC key. Observe that screen displays screen 22e.

██████
25.00 mW/CM2 AVERAGE
34.60 MAX 14 GHZ
START LOG MENU FREQ

SELECT F1 TO START
F2=STORE LAST LOG
F3=MAIN MENU
F4=CHANGE FREQ.

Table 4-2. Operating Instructions – Continued

Display screen	Description	HELP screen
22f	<p>This screen is displayed during averaging. The bottom line will change depending upon the mode of operation. For spatial averages, the screen 22f will be observed.</p>	
 <pre> 0.00 mW/CM2 AVERAGE 0.000 MAX 10 GHZ STOP PAUSEPAUSE STOP </pre>	<ul style="list-style-type: none"> A. If a fixed time average has been selected, the bottom line will only display PAUSE. B. Since a fixed time has been chosen, averaging cannot be stopped until the averaging period has been completed. C. The top line bargraph is always active, even between averages. This will help to minimize the chances of unintended exposure. D. If multiple fixed time averages have been chosen, the display shown in 22g is displayed (i.e. if you are making multiple six minute averages after the first six minute period). 	
22g	<p>This screen is displayed only in multiple averaging mode after the first averaging period. The numbers and units on line two will be flashing.</p>	
 <pre> 22.3mW/CM2 AVERAGE 39.8mW/CM2 MAX 10GHZ LOG %STD STOP </pre>	<ul style="list-style-type: none"> A. Depress F1 to log the average displayed on line two. B. Depress F3 to alternate the third line display between the maximum level detected during the average and the level as a % of Std previously selected. Note that if you change the value displayed on line three between MAX and %STD, the maximum level will be reset. C. Depress F4 to end the averaging period and the display screen will return to screen 22e. D. To reset the 8718 to normal operation, depress F3 (MENU), 8 (NEXT), 2 (TIME AVG) and F1 (DISABLE), in sequence. 	

Table 4-2. Operating Instructions - Continued

Display screen	Description	HELP screen
23	<p>Set the desired logging mode by accessing Screen 23 from either Screen 9 (Normal measurement mode) or Screen 22e (average mode) depress Key F2 (MENU) Screen 10 is displayed. Depress Key 8 to get to the second menu screen (Screen 20). Depress Key 3 observe that Screen 23 is displayed. This screen provides the means to log (store in the Model 8718 memory) a single measurement with a time and date stamp, log a single measurement with a time and date stamp with a reference number, or continuously log all measurements. Line 4 of this screen indicates the mode that is currently selected.</p>	<p>F1=STORE SINGLE DATA F2=STORE DATA & REF# F3=STORE MULTIPLE MEASUREMENTS</p>
<p>F1=LOG TIME & DATE F2=LOG T&D W/REF# F3=CONT. LOGGING CURRENT MODE=F1</p>	<p>A. To set the logging mode proceed as follows:</p> <ol style="list-style-type: none"> 1. Depress F1 Key to select the single point log mode. 2. Depress F2 to select the single point with reference number mode. 3. Depress F3 to select the continuous logging mode. <p>B. To log a single measurement with a time and date stamp, proceed as follows (once this mode has been selected).</p> <ol style="list-style-type: none"> 1. Depress F1 (LOG) key when screen 9 (normal measurement mode) is displayed or F3 (LOG) key when screen 22e is displayed. The measurement (average mode) is recorded at this time. <p>C. To log a single measurement with a time and date stamp and a reference number, proceed as follows after this mode has been selected.</p> <ol style="list-style-type: none"> 1. Depress F1 (LOG) key when screen 9 (normal measurement mode) is displayed or F3 (LOG) key when screen 22e (average mode) is displayed. Observe that screen displays screen 23a. The measurement is recorded at this time. 	

Table 4-2. Operating Instructions - Continued

Display screen	Description	HELP screen
23a	<p>3. Use 0 through 9 keys to enter desired two digit reference number. Observe that the desired two digit reference number is displayed in line 4.</p> <p>4. Depress ENTER key to add a reference number to the time and date stamp for the value just logged. Observe that screen displays original screen (screen 9 or 22e).</p> <p>D. To continuously log all measurements displayed on screen 9 or 22e, proceed as follows:</p> <p>1. Select the continuous logging mode as described in A3 above. Observe that screen 23b is displayed.</p>	<p>ENTER 2 DIGIT REF# FROM KEYPAD & PRESS ENTER</p>
<p>SINGLE POINT DATALOG ENTER TWO DIGIT REF# FOR REF. XX THEN PRESS ENTER</p>	<p>NOTE</p>	
23b	<p>2. Depress number key (1 through 6) to select the desired logging rate. Observe that screen displays screen 23c.</p>	<p>SELECT LOGGING RATE DESIRED ON KEYPAD. TOTAL MEMORY=3K POINTS MAXIMUM</p>
<p>LOGGING RATE=XX/XXX 1) 10/SEC 4) 1/MIN 2) 1/SEC 5) 10/HR 3) 10/MIN 6) 2/HR</p>	<p>3. Observe that line 2 of this screen displays logging rate selected in the previous step.</p> <p>4. Using number keys (0-9), enter desired number of seconds, minutes, or hours that continuous logging of measurements is to occur.</p>	<p>SELECT DURATION OF LOG W/KEYPAD 0-9 F4 SHOWS TOTAL MEM. AVAILABLE</p>
23c		
<p>CONTINUOUS LOG RATE=XX/XXX DURATION=XX MIN SEC MIN HRS MEM</p>		

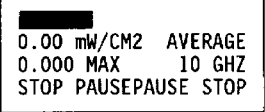
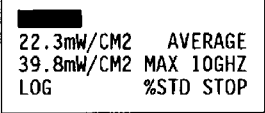
Table 4-2. Operating Instructions - Continued

Display screen	Description	HELP screen
23d	<p>5. Depress F1 (SEC), F2 (MIN), or F3 (HRS) key to select the desired units of time; seconds, minutes, or hours, respectively. Observe that line 3 of screen 23c display a duration of the desired time.</p> <p>6. Depress F4 (MEM) key to determine the number of points available in memory for continuous logging of measurements. Observe that screen displays screen 23d.</p>	
<div style="border: 1px solid black; padding: 5px; text-align: center;"> MEMORY AVAILABLE IS XXXX POINTS </div>	<p>7. This display indicates the number of points remaining in memory for continuous logging of measurements. An error, <u>define error</u>, will be generated if the logging rate times the duration is more than the number of points available in memory.</p>	<div style="border: 1px solid black; padding: 5px;"> ERROR IS GENERATED IF RATE x DURATION IS MORE THAN AVAIL- ABLE MEMORY. </div>
24	<p>To set the time and date clock within the Model 8718, proceed as follows:</p>	
<div style="border: 1px solid black; padding: 5px;"> TIME SET 24HR FORMAT TIME: 14:30 DATE: 30/12/94 TIME DATE SAVE </div>	<p>A. Depress F1 (TIME) key.</p> <p>B. Use the number keys (0 through 9) to enter the time using the 24 hour format.</p> <p>C. Use the number keys (0 through 9) to enter the date using the following format; DDMMYY where DD equals the day, MM equals the month, and YY equals the year.</p> <p>D. When line 2 displays the correct time and line 3 displays the correct date, depress F4 (SAVE) key to enter the time and date. Observe that screen displays the correct time and date.</p>	<div style="border: 1px solid black; padding: 5px; text-align: center;"> PRESS F1 OR F2 FIRST THEN ENTER 0-9 FROM KEYPAD. PRESS F4 TO SAVE CHANGES </div>
	<p>E. Depress ESC to return to screen 20.</p>	

Table 4-2. Operating Instructions – Continued

Display screen	Description	HELP screen												
25	<p>To change the Baud rate of data transfers at the RS-232 connector or to turn on the RS-232 port at the RS-232 connector, proceed as follows:</p> <p>A. Use the number keys (0 through 9) to enter the two digit number that correspond to the desired BAUD rate as listed below:</p> <table data-bbox="406 497 612 631"> <thead> <tr> <th><u>Number</u></th> <th><u>BAUD Rate</u></th> </tr> </thead> <tbody> <tr> <td>96</td> <td>9600</td> </tr> <tr> <td>72</td> <td>7200</td> </tr> <tr> <td>48</td> <td>4800</td> </tr> <tr> <td>24</td> <td>2400</td> </tr> <tr> <td>12</td> <td>1200</td> </tr> </tbody> </table> <p>B. Use the F1 key to toggle the RS-232 port on and off. When RS-232 port is on line 2 will display PORT=ON.</p>	<u>Number</u>	<u>BAUD Rate</u>	96	9600	72	7200	48	4800	24	2400	12	1200	<div style="border: 1px solid black; padding: 5px;"> <p>BAUD: 9600 PORT=ON TYPE NUMBER THEN ENT F1 TO DISABLE</p> </div>
<u>Number</u>	<u>BAUD Rate</u>													
96	9600													
72	7200													
48	4800													
24	2400													
12	1200													
26	<p>The Model 8718 stores information about various Standards and Guidance in use around the world. Standards are used by the Model 8718 to display the level of electromagnetic fields relative to the levels specified in these standards (screen 9), and to set measurement averaging times in accordance with these standards (screen 23). The ability to store international Standards and Guidance can be important. Since all of the Standards and Guidance are using variable limits and averaging times, this feature can be very useful when making measurements or time averaging measurements. To select the Standard or Guidance to be displayed, proceed as follows:</p> <p>A. Depress F1, F2, F3, or F4 key to select the Standard or Guidance to be displayed. Observe that screen displays screen 26a.</p>	<div style="border: 1px solid black; padding: 5px;"> <p>PRESENT STD=IEEE F1=IEEE F3=CANADA F2=NRPB F4=E.C.PAD</p> </div>	<div style="border: 1px solid black; padding: 5px;"> <p>ENTER # ON KEYPAD TO CHOOSE STD.</p> </div>											

Table 4-2. Operating Instructions – Continued

Display screen	Description	HELP screen
NOTE		
Screen 26a shown below is the IEEE C95.1-1991 screen. This screen is shown as a typical display of a Standard or Guidance.		
26a	<div style="border: 1px solid black; padding: 10px; width: fit-content; margin: auto;"> <p style="text-align: center;">IEEE C95.1-1991 LEVEL=CONTROLLED</p> <p>YES NO</p> </div>	<ul style="list-style-type: none"> A. Depress F1 key to accept displayed Standard or Guidance for use in other screens. B. Depress F4 key to return to screen 26. C. Depress ESC key to return to screen 20.
30	<div style="border: 1px solid black; padding: 10px; width: fit-content; margin: auto;"> <p>1=LOCKOUT 3=BACK 2=BLANKOUT</p> </div>	<ul style="list-style-type: none"> A. The LOCKOUT feature prevents the Model 8718 from responding to inadvertent depressing of keys. To lockout the keypad depress key 1. Observe that either screen 9 or screen 22E is displayed. B. Simultaneously depress ENTER and ESC keys to unlock the keypad. C. The BLANKOUT feature prevents the Model 8718 from responding to inadvertent depressing of keys and also blanks the display. This feature may be useful during long term data logging. To both lockout the keypad and blankout the display depress key 2. Observe that the screen is blank. D. Simultaneously depress ENTER and ESC keys to unlock the keypad and activate the display.

SECTION V

COMPUTER OPERATIONS

5-1. COMPUTER OPERATIONS

A computer can be used with the Model 8718 in one of three ways:

- The Narda **Interface Software** is used to enter probe calibration information into the memory of the Model 8718
- The Narda **Interface Software** is used to download, or extract, data collected with the Model 8718 that was used in one of the three data logging modes.
- A computer can be connected to the RS232 jack on the Model 8718 so that certain functions can be controlled remotely and measured data can be continuously transmitted to the computer in real time.

5-2. INTERFACE SOFTWARE

The Narda **Interface Software** for the Model 8718 is supplied on a single 3.5 inch diskette. It is designed to be permanently installed on the hard drive of a personal computer.

5-2.1 System Requirements

In order to install and operate the **Interface Software** successfully, your system must meet the following minimum requirements:

- An IBM or 100% compatible personal computer with 4 MB of RAM.
- 1 MB of hard drive space.
- Microsoft Windows[®] 3.1 or later.
- A printer supported by Microsoft Windows (required for printing reports).
- A mouse.

In addition, you will need a cable to connect between the computer and the 8718. The cable must be a RS232 serial cable with a DB9 male connector on one end and a DB9 female connector on the other end. Do *NOT* use a null modem cable since these are wired differently. Note that certain older model computers have a 25 pin connector for a serial port which will require either an adaptor or a different cable.

5-2.2 Installing the Interface Software

To set up the program,

1. Turn on the computer and start Microsoft Windows (type **WIN** at the DOS prompt if your computer doesn't start Windows automatically).
2. Select Run from the File menu of the Program Manager. The Run dialog box appears.
3. Insert the **Interface Software** disk in a floppy drive (drive A: or B:, as is appropriate).
4. In the Command Line field, type **A:\SETUP** (or **B:\SETUP** if you put the disk in drive B:) and click OK.
5. Follow the instructions that appear on your screen. The setup program places all of the program files in a directory on your hard drive called 8718. A new program group called RF Safety will be created.

5-2.3 Starting and Exiting the 8718 User's Program

To start the **8718 User's Program**,

1. Start your computer and Microsoft Windows. Open the **RF Safety** program group.
2. Double click on the **8718 User's Program** icon. The program screen appears.

When you are finished using the **8718 User's Program**, exit the program by selecting Exit from the File menu. You can also double click on the Control-menu box .

Do *NOT* use **Ctrl+Alt+Del** to exit the program. Also, make sure you exit the **8718 User's Program** before turning off your computer.

5-2.4 Establishing Communications Between the Meter and the Computer

You must establish communications between the meter and the computer in order to enter, change, or view probe calibration information or to download data from the meter. You can only view stored logged data using your computer.

1. Use a standard RS232 (serial) shielded cable to connect between the RS232 connector on the meter and the **COM 1** port of your computer.
2. Turn the Model 8718 on.
3. Once the meter has finished booting up, press **F4** on the meter to access its menu system.
4. Press **8** to get to the second menu screen.

5. Press **5** to access the RS232 port menu.
6. Use **F1** to enable, or turn on, the RS232 port.

NOTE

The port is turned off every time the meter is turned off to conserve power. The Baud rate will be the same as the last time it was used.

7. Insure that the Baud rate is set to 9600. If it is not, use the numeral keys to enter **96** followed by the **Enter** key.

5-2.5 Adding or Changing Probe Calibration Data in the Meter's Memory

To enter or change probe calibration data in the meter's internal memory,

1. Establish communications between the meter and your computer as described in paragraph 5-2.4 (**Establishing Communications...**).
2. Select **Manually or From Disk** from the **Install Probes** menu. A box will appear showing that the modem in your personal computer is trying to communicate with the Model 8718. It will be titled **Reading Stored Probes**.

NOTE

At this point the only option is to install the data manually. In the future, Narda may provide calibration data for probes on disk.

3. A new window titled **Model 8718 Probe Installation** will appear. See Figure 5-1.

The table in the top left hand corner lists the probes by model and serial number that have been "Installed" in your Model 8718. The term installed means that the meter not only knows the generic characteristics of a probe model - such as frequency range, type of probe (electric or magnetic field), measurement range, and standard calibration frequencies - but it also has stored the calibration date and the correction factors for a specific serial number probe. A small box just below the table lists the total number of installed probes. Narda installs probes that are shipped at the same time as the 8718.

You can have a maximum of six probes installed at any time. Since the serial number of the probe is identified as well as the model number, more than one probe of the same model number may be installed at the same time.

NOTE

Probe Models 8782 and E8782 should not be added to memory. These unique low frequency probes use a range switch on the probe to cover a total of 60 dB. Use the meter function keys to select "Probe". After selecting the probe model, enter the range that the probe is set to.

3. Enter the five digit serial number in the highlighted box in the center of the window.
4. Enter the calibration date by highlighting the box to the right of legend "Enter Cal Date". This date is shown on the handle of the probe.
5. Enter the correction factor for each calibration frequency of the probe by highlighting the default value of 1.0. Note that a correction factor greater than 2.0 or less than 0.5 will not be accepted and will automatically be changed to one of these values. Narda probes never have a correction factor outside of this range for any frequency within their rated frequency range. A default correction factor value of 1.0 (CF 1.0) is automatically entered in the table to minimize measurement error in case the user fails to enter a value.
6. Enter any special calibration frequencies on the extra lines provided and enter the appropriate calibration factors. Delete any standard calibration frequencies that were not used.
7. Click on the **Continue** button. A dialog box will appear asking you if you are sure you want to install the probe.
8. Click on **OK**. The program will automatically send the calibration information to the meter via the modem and cable. The program will then verify that the probe has been successfully installed in the meter by reading the meter's memory.
9. The model number and the serial number of the probe just installed will now appear in the table of Installed Probes.
10. To leave the **Probe Installation** window and return to the main menu click the **Exit** button.

Viewing Installed Probes

To view the information on a specific probe that has already been installed,

1. From the Model 8718 Probe Installation window, highlight the model and serial number of the probe that you want to view.
2. Click on the **View** button. The calibration information on that specific probe will appear.
3. To leave the **Probe Installation** window and return to the main menu click the **Exit** button.

Model 8718

Removing Installed Probes

To remove a specific probe from the meter's memory,

1. First view an installed probe as described above.
2. Click on the **Remove** button. A dialog box will appear asking you to confirm that you want to remove a probe from the meter's memory.
3. Click **OK**. The probe will automatically be removed from the meter's memory.

The model number and the serial number of the probe just removed will disappear from the table of Installed Probes.

4. To leave the **Probe Installation** window and return to the main menu click the **Exit** button.

WARNING

All existing "SETUPS" in the Model 8718 must be reentered after removing an installed probe. Failure to do so may result in the meter being set to the wrong probe model whenever a SETUP is recalled.

5-2.6 Downloading Logged Data from the Meter

To download data from the meter,

1. Establish communications between the meter and your computer as described in paragraph 5-2.4 (**Establishing Communications...**).

NOTE

The meter's memory is cleared every time the logged data is downloaded from the meter. The meter can store 3,024 data points.

2. Select **Download New Survey** from the **View Survey Data** menu. A box will appear showing that the modem in your personal computer is trying to communicate with the Model 8718. It will be titled **Down Loading File**.
3. A box will appear indicating that the data has been saved. Click **OK**.

5-2.7 Viewing Survey Data

Data files can have one of three forms identified by the suffix in the file name,

1. Files downloaded from the meter have numerical prefixes that are based on the date and time the first data point was taken and the suffix **.SVY**. The first two digits are the day of the month, the second two digits are the month, and the fifth digit is the year. The last two digits are the second that the first bit of data was taken.

NOTE

There is a remote possibility (1 in 60 chance) that multiple data logging records taken on the same day might occur at the same second. In this case the previous data will be overwritten. Future versions of the software will eliminate this problem.

2. Exported files that have been converted to standard spreadsheet files have the same prefix as the original file with the suffix **.SSH**. These files are automatically stored in the subdirectory labeled **SSDATA**.
3. Exported files that have been converted to standard ASCII text files have the same prefix as the original file with the suffix **.TXT**. These files are automatically stored in the subdirectory labeled **SSDATA**.

In addition to the normal data files, three sample files were loaded on your hard drive when you installed the Interface Software. These files are labeled **LOGFILE*.SVY**.

Selecting a File to View

To view stored surveys on your computer,

1. Select **Stored Surveys** from the **View Survey Data** menu. A dialog box will appear titled **Open Survey File**. Normal downloaded survey files stored on the computer's hard drive will be listed in the table on the left. Exported files are stored in a subdirectory labeled **SSDATA**. You can change drives, select which types of files are listed, or change directories from this box.
2. Select the data file you want to view from the list of files by either double clicking on it or highlighting it and choosing **OK**.
3. A dialog box will appear that asks you whether or not the version of the meter firmware (internal software) is Version 2.0 or higher. Click on **YES** or **NO** as is appropriate.
4. A new window labeled **Logged Survey Data** will appear. Figure 5-2 is an example of a logged data file window.

Logged Survey Data Window

The **Logged Survey Data Window** is comprised of two parts,

1. The header section at the top of the window defines the equipment that was used to make the survey,
 - a. The first line shows the meter serial number and calibration date.
 - b. The model number, serial number, and calibration date of the probe that was used are shown on the second line.
 - c. Line three identifies whether or not probe frequency correction was being used. It also shows the logging rate if the survey was made in the continuous logging mode.

Logged Survey Data

Print
Export

Model 8718 **S/N:** 1012 **Calibration Date:** 03\24\95 **Due:** 03\24\96
Probe Model: 8761 **S/N:** 45678 **Calibration Date:** 10\31\95 **Due:** 10\31\96
Frequency: Not Selected **Correction Factor:** 10.00 **Logging Rate:**
Averaging Mode: None **Averaging Time:**

REF#	Date	Time	Field Strength
0 1	10\31\95	10:37	4.34
0 2	10\31\95	10:37	2.04
0 3	10\31\95	10:37	7.04
0 4	10\31\95	10:37	9.97
0 5	10\31\95	10:37	12.86
0 6	10\31\95	10:37	7.04
0 7	10\31\95	10:37	4.34
0 8	10\31\95	10:37	7.05
0 9	10\31\95	10:37	9.97
1 0	10\31\95	10:37	12.86
1 1	10\31\95	10:38	15.92
1 2	10\31\95	10:38	19.02
1 3	10\31\95	10:38	15.92
1 4	10\31\95	10:38	12.86
1 5	10\31\95	10:38	9.97
1 6	10\31\95	10:38	7.05

File: 111035.SVY Units: mW/cm2 Record # of 78

MAP Data - Composite

Field Strength vs Data Point

Scroll Forward

Scroll Back

Increment By:

New Record

Old Record

Close

Figure 5-2. Interface Software Logged Survey Data Window

- d. The fourth line shows whether or not time or spacial averaging was being used during the survey.
2. The lower section of the window shows the measured data in both tabular and graphical form,
 - a. The line just above the bar graph shows the unit of measure that the survey was made in, the file name, the record number that is being displayed. Data taken in the continuous mode will have the legend **Logged Data** above the graph. Data taken one point at a time with user defined reference numbers will have the legend **Map Data** above the graph. This is because this mode is useful for keying data to either a site map or a diagram of a piece of equipment that was surveyed for leaks.

- b. The table on the left side of the screen displays up to sixteen (16) data points at one time. They are shown sequentially in the time they were taken with the field strength shown in the units defined above the graph. The reference number will be a continuous sequence of numbers if the data was taken in a continuous logging mode. Data taken with user entered two digit reference numbers will have those numbers displayed in the left hand column.
- c. The bar graph shows the same data listed in the table . The range of the vertical axis of the graph is automatically adjusted to accommodate the data. The number of data points will also vary depending on the data with a maximum of thirty (30) displayed at one time.
- d. The **Scroll Back** and **Scroll Forward** buttons are used when there are more than sixteen data points to view. Each time you click on one of these buttons you advance or go back by sixteen data points.
- e. The **New Record** and **Old Record** buttons allow you to go back and forth between different records that were taken on the same day.

NOTE

In the **Map Data** mode each data point is considered a separate record. This is because the user has the opportunity to change measurement parameters between data points which is reflected in the header of the Logged Survey Data window. For example, the user can change units of measure or turn the spacial averaging mode on.

- f. The up and down arrows to the right of **Increment By** are used to determine how many records you advance or go back every time you click on the **New Record** and **Old Record** buttons. The small window to the right of the arrows indicates the current setting.
- g. Click on the **Close** button to go back to the main menu of the User's Program.

Printing a Logged Data Record

To print a copy of the **Logged Survey Data** window that you are viewing,

1. Select **Print Screen** from the **Print** menu. A **Print** dialog box will appear.

Model 8718

2. Click **OK**. Each view that you want to print must be printed as a separate page.
3. To print very large records with many data points it is suggested that you export the data and use another program.

Exporting Data

To export a logged data file for use in a spreadsheet program,

1. Select **Make SS File** from the **Export** menu. A dialog box appears briefly indicating that a converted version of the original file has been placed in the **SSDATA** subdirectory.
2. Use the Windows File Manager or any other appropriate technique to move the converted file into any standard spreadsheet file such as Excel or Lotus 123.

To export a logged data file for use in a word processor or text editor program,

1. Select **Tab File** from the **Export** menu. A dialog box appears briefly indicating that a converted version of the original file has been placed in the **SSDATA** subdirectory.
2. Use the Windows File Manager or any other appropriate technique to move the converted file into any standard word processor program such as WordPerfect or Word.

5-2.8 Diagnostics

A diagnostics section is included with the Interface Software. If you experience a problem communicating between your computer and the Model 8718, call Narda. Narda will help you use the **Diagnostics** menu of the User's Program.

5-3. COMMUNICATIONS BETWEEN THE MODEL 8718 AND A COMPUTER.

The Model 8718 can be connected to a computer for real time transmission of data (meter firmware revisions 2.2 and higher only) via the meter's RS232 connector. A limited number of the meter's functions can also be controlled remotely via the RS232 bus.

5-3.1. Checksum and Modulo Description.

Modulo 256 is the remainder of any number X divided by 256. As an example, if the checksum is 1234, Modulo 256 of 1234 is 210. The two ASCII digits to be transmitted as the checksum would be D and 2 (the decimal-hex conversion of 210). An equivalent calculation is to convert the sum to Hex and transmit the two lowest digits. The Hex of 1234 is 4D2, therefore the digits to transmit are ASCII D and 2.

5-3.2. Computer to Model 8718 Message Format.

The first character in any message is the ">". This allows the Model 8718 to synchronize to the computer. Upon detection of the ">" character, the 8718 will:

1. Set itself to a listen mode, thereby eliminating the possibility of a bus contention problem.
2. Reset its character counter to allow storage of succeeding characters in an internal buffer.

The next character(s) is selected from the functions listed in Table 5-1.

Table 5-1. Command Character Function

Command Characters	Function
>A000CSCR	AUTO ZERO
>C000CSCR	READ CLOCK (TIME DATE)
>Dr00CSCR	Display averaging change r=1, 2, 3, 4 low to high display averaging
>E003XXXCSCR	SET CF (Correction Factor)
>F0r4XXXCSCR	SET FREQ X is DATA, r is kHz, MHz, GHz r=0=kHz, r=1=MHz, r=2=GHz
>H000CSCR	SEND HEADER (24 bytes of data)
>P000CSCR	DUMP PROBE DATA (432 bytes of data)
>L000CSCR	DUMP LOG DATA
>V000CSCR	READ displayed VALUE Last displayed value (6 bytes) + units (6 bytes)
>X000CSCR	READ MAX
>Y000CSCR	RESET MAX
>M000CSCR	Clear all survey data

Table 5-1. Command Character Function - Continued

Command Characters		Function
I. Communications Protocol		
A) Ground Rules		
	1) CS= two digit checksum (Hex)	
	2) CR= one digit carriage return (13 or \$0D)	
	3) x= data	
	4) r= range	
	5) >=ASCII ">" (\$3E)	
B) General send format:		
	1) > cmd letter 0 0 # of digits in data data CS CR	
	2) All characters are sent and received as capital letters, don't send lower case letters unless one is specifically requested.	
	3) Checksum (CS) is always sent or received as a hexadecimal value.	
	4) Data is always sent or received as a decimal value.	
II To Change or initiate the following:		
	<u>SEND</u>	<u>RESPONSE</u>
A)	Auto Zero >A000CSCR	ACR
	ASCII >A000D1CR	ACR
	Hex 3E 41 30 30 30 44 31 0D	41 0D
B)	Read Clock >C000CSCR	SMHXDNYCSCR
	ASCII >C000D3CR	
	Hex 3E 43 30 30 30 44 33 0D	
	(Where: S= seconds in BCD format	
	M= minutes in BCD format	
	H= hours in BCD format	
	X= N/A	
	D= day of month in BCD format	
	N= month in BCD format	
	Y= year (00-99) in BCD format	
	CS= two byte checksum	
	CR= carriage return)	
C)	Correction Factor >E003xxxCSCR	ACR
	Example: to set CF to 1.53, xxx=153	
	ASCII >E00315371CR	
	Hex 3E 45 30 30 33 31 35 33 37 31 0D	

Table 5-1. Command Character Function - Continued

Command Characters		Function	
D)	Frequency	<u>SEND</u> >F0r4xxxxCSCr r=0 for KHZ, 1 for MHZ or 2 for GHZ Example: to set frequency for 27.12 MHZ	<u>RESPONSE</u> ACR
	ASCII	>F0142712A7CR	
	Hex	3E 46 30 31 34 32 37 31 32 41 37 0D	
E)	Clear All Survey Data	>M000CSCr	ACR
	ASCII	>M000DDCr	
	Hex	3E 4D 30 30 30 44 44 0D	
F)	Read Field Strength	>V000CSCr	x...xCSCr
	ASCII	>V000E6Cr	
	Hex	3E 56 30 30 30 45 36 0D	
		(Response format 12 data bytes) last displayed value (6 characters) + units of last displayed value (6 characters) exactly as displayed except squared and cubed symbols.	
G)	Read Max	>X000CSCr	xxxxxxCSCr
	ASCII	>X000E8Cr	(6 data characters returned exactly as displayed)
	Hex	3E 58 30 30 30 45 38 0D	
H)	Reset Max	>Y000CSCr	ACR
	ASCII	>Y000E9Cr	
	Hex	3E 59 30 30 30 45 39 0D	
I)	Display Averaging	>Dr00CSCr r=1 for minimum to 4 for maximum display averaging Example: to set minimum display averaging (4:1)	ACR
	ASCII	>D100D5Cr	
	Hex	3E 44 31 30 30 44 35 0D	
J)	Read Calibrated Probe Data	>P000CSCr	x...xCSCr
	ASCII	>P000E0Cr	(432 data bytes returned)
	Hex	3E 50 30 30 30 45 30 0D	
K)	Read Log Data	>L000CSCr	x...xCSCr
	ASCII	>L000DCCr	(depends on size of log)
	Hex	3E 4C 30 30 30 44 43 0D	
l)	Read Header (setup data)	>H000CSCr	x...xCSCr
	ASCII	>H000D8Cr	(24 data bytes sent, use definition table to decode bits)
	Hex	3E 48 30 30 30 44 38 0D	

**Click Here for Updated
8700 Series Probes
Information**



USA: 435 Moreland Road
Hauppauge, NY 11788

Tel 1-631 231-1700 **Fax** 1-631 231-1711

E-Mail NardaSTS@L-3COM.com

www.narda-sts.com

GERMANY: Sandwiesenstrasse 7
D-72793 Pfullingen

Tel +49-7121-9732-777 **Fax** +49-7121-9732-790

E-Mail support@narda-sts.de

www.narda-sts.de