

## **1690-Series Logic Analyzers**

### **Quick Start/Installation**

Installation	2
Making a measurement	4
Snap to Edge Markers	6
Left-Click Menus	7
Tree Structure Labels	7
Offline Analysis	8
Marker Overview	8
Tool Tips	8
Trigger History	9
Probing	10
Proper Cooling	10
Self-Test	11
Software Installation and Upgrades	12
Specifications and Characteristics	13
Safety Notices	15

## Installation

You will need to install an Agilent E5851A IEEE 1394 card and the *Agilent Logic Analyzer* application software on your PC.

PC System Requirements:

- 1.0 GHz minimum, Intel Pentium® 3, AMD Athlon K7 or better.
- 512M RAM.
- Windows® 2000 Professional or Windows XP Professional installed.
- 100M minimum available hard disk space.



Windows XP will not prompt you if the IEEE 1394 card is not properly installed. Follow the instructions that came with the Agilent E5851A IEEE 1394 Connection Kit and your PC's documentation to:

- Install the IEEE 1394 card in any available slot in your PC.
- Load logic analyzer application software.
- Connect the logic analyzer to your PC.
- Install ferrite to ensure radio frequency interference compliance.

Refer to the online help in the logic analyzer for information on using the analyzer.

Snap the accessories pouch to the top of the 1690-series logic analyzer. Use it to store probe leads, accessories, or manuals. Use the tie-down straps under the flap to conveniently hold pod cables not in use or during transport.

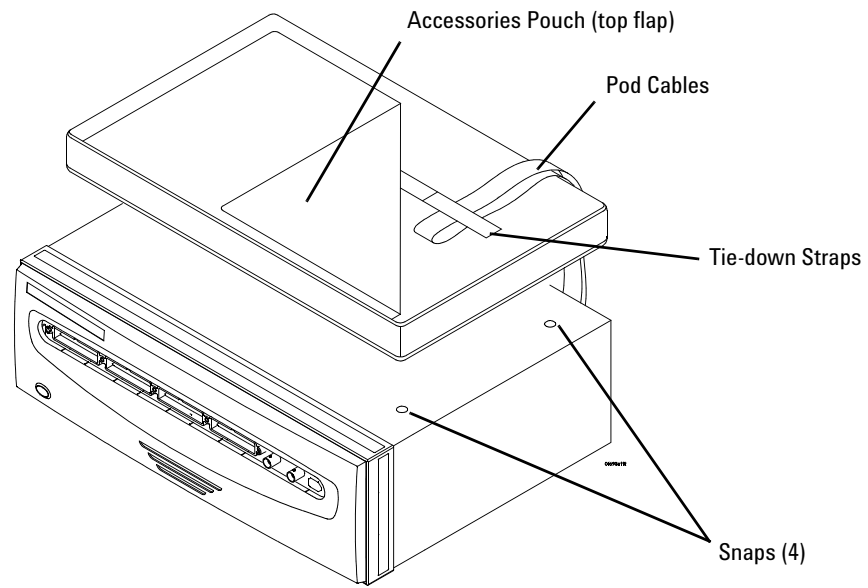

## Making a measurement

- 1 Start up the logic analyzer, connect to your target system, and select **Setup>Bus/Signal**.

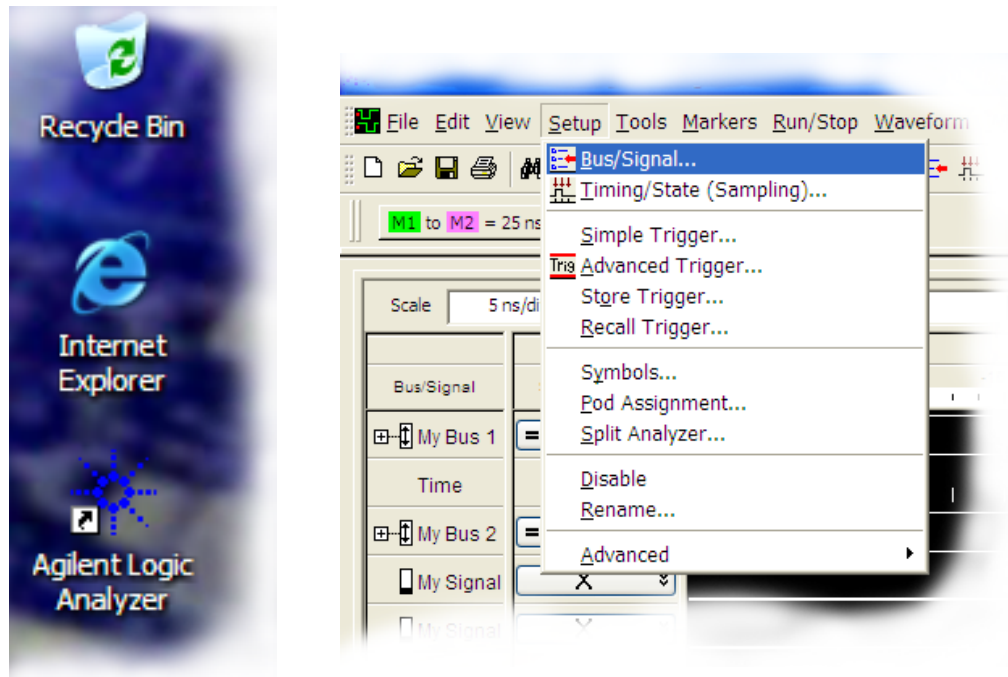

- 2 Assign buses and signals and click OK.

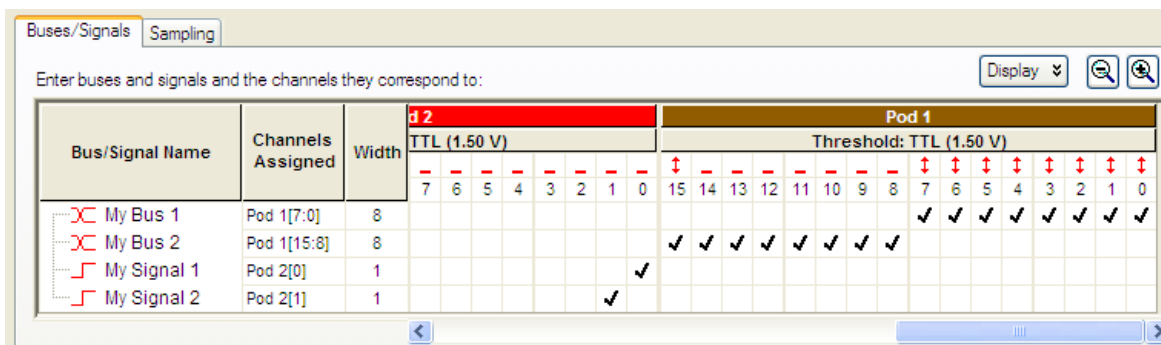

3 Enter a trigger value.

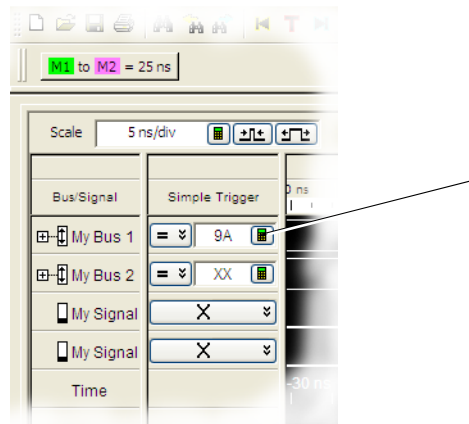

4 Acquire and view data.

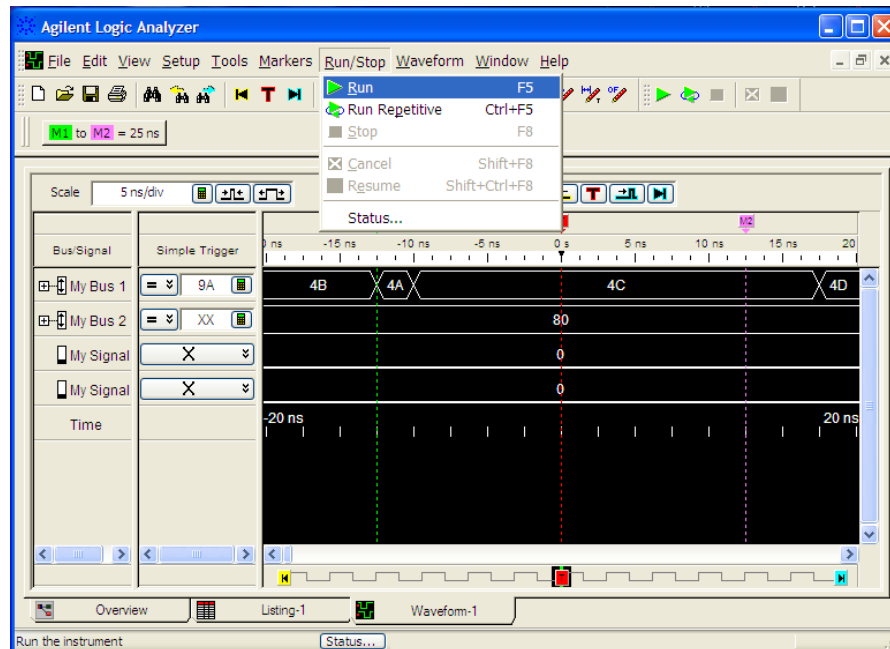

## Snap to Edge Markers

You can set the markers to jump to the nearest edge of a waveform. A yellow target will show which edge the marker will jump to.

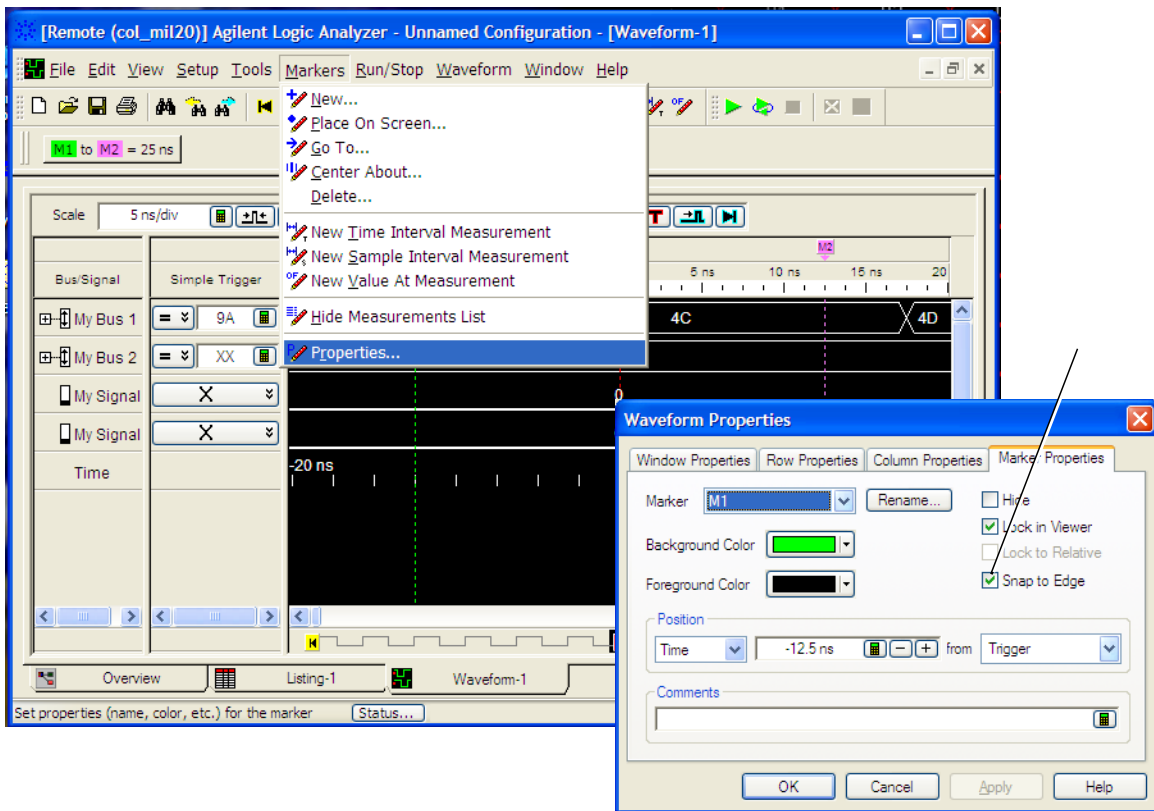

## Left-Click Menus

Drag a box around parts of the data. When you release the mouse button, a menu appears.

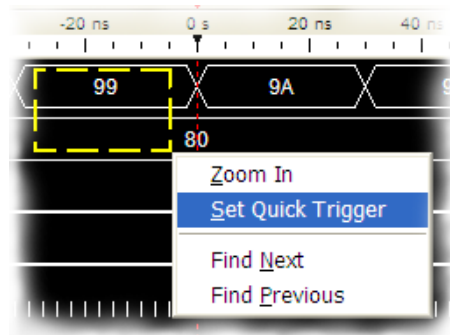

## Tree Structure Labels

Show individual signals in buses by clicking on the + to expand.

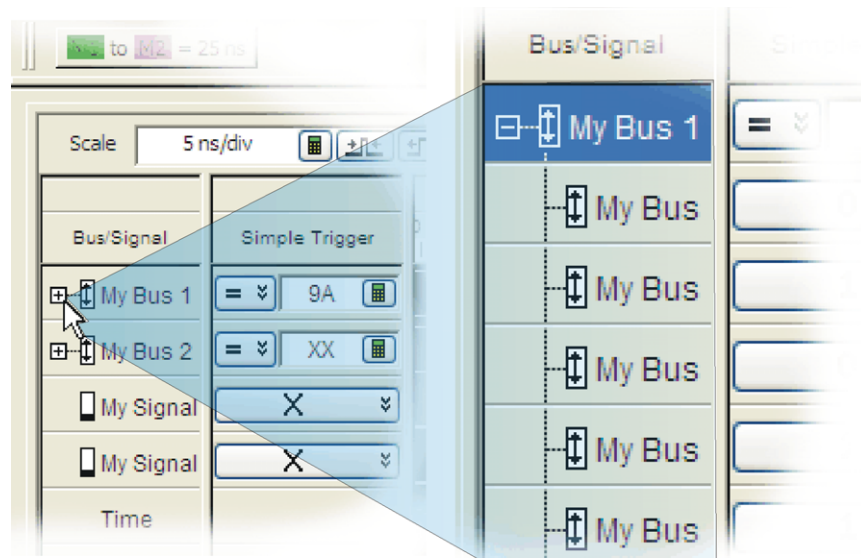

## Offline Analysis

Install the *Agilent Logic Analyzer* application on another Windows XP or Windows 2000 computer and you can analyze data without the 1690-series logic analyzer.

- 1 Follow the instructions in “[Software Installation and Upgrades](#)” on page 12 to load the 1690-series logic analyzer software on your PC.
- 2 Acquire a trace with the logic analyzer.
- 3 Save a configuration file with data.
- 4 Copy the file to the PC being used for offline analysis.
- 5 From the *Agilent Logic Analyzer* application software on your PC, open the configuration file.

## Marker Overview

The marker overview display shows marker locations within the data and the part of data currently being displayed.



## Tool Tips

Pause the cursor over a tool icon and a “Tool Tip Window” will appear.

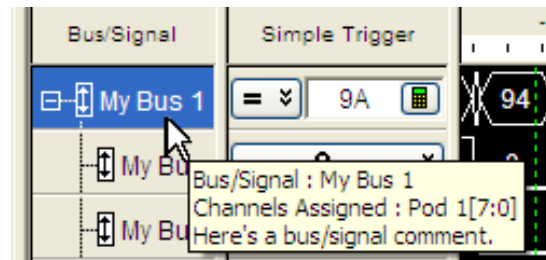
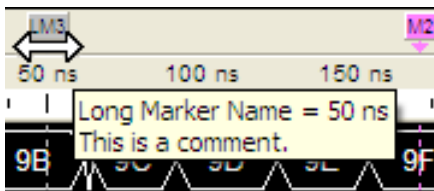



## Trigger History

Save and recall trigger settings.

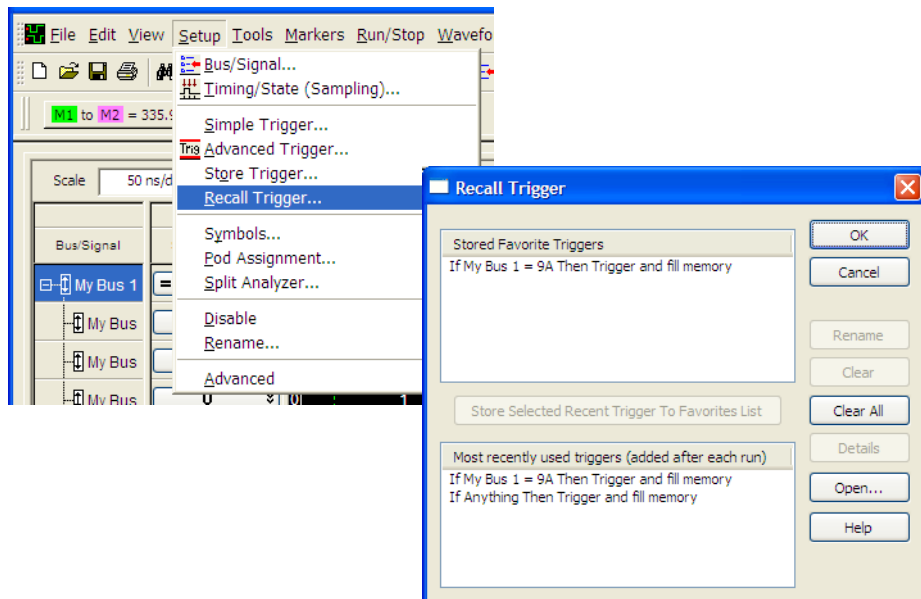
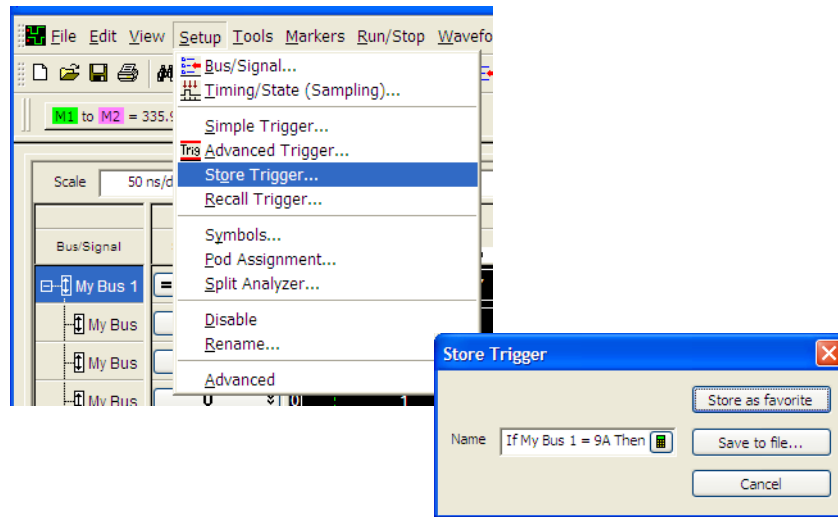

## Probing

Probing is the key to effective and efficient use of logic analyzers. Agilent Technologies offers a wide variety of probing accessories that support general-purpose and application-specific measurement needs. We provide reliable, electrically and mechanically unobtrusive probes that make it easy to connect your Agilent logic analyzer to your system under test. For more information on Agilent probes:

- See the quick reference card that came with your logic analysis system for an overview of probing solutions.
- Go to [www.agilent.com/find/logic\\_analyzer\\_probes](http://www.agilent.com/find/logic_analyzer_probes) for the most up-to-date information on probe compatibility with a given logic analyzer and purchasing information.
- Go to [www.agilent.com](http://www.agilent.com) and search for Probing Solutions for Logic Analyzers (publication 5968-4632E) for a catalog of detailed probing information.

To connect and set up a probe, follow the instructions in the User's Guide that came with the probe.

## Proper Cooling

Allow at least 5 cm (2 inches) of space between instruments for proper cooling.

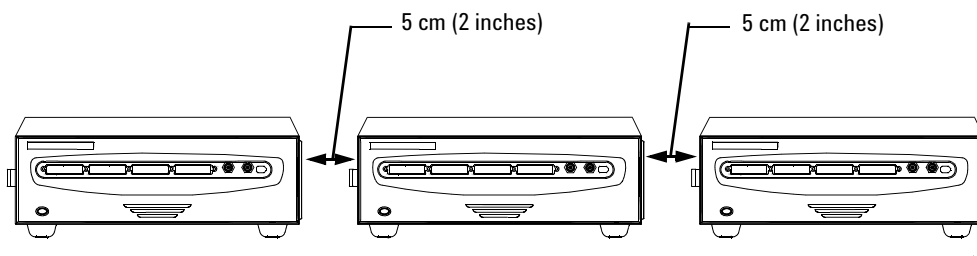

## Self-Test

To run self-tests go to **Help>Self Test** and then select the desired test.

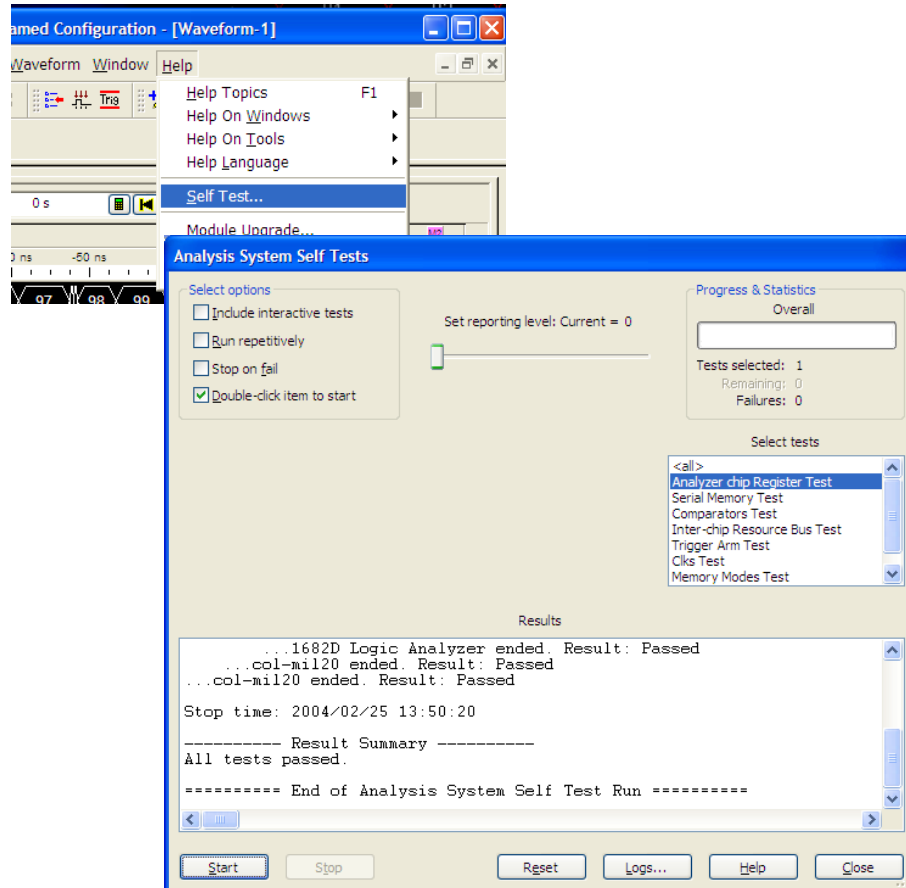

## Software Installation and Upgrades

To install the *Agilent Logic Analyzer* application, insert the application software CD into the PC's CD drive. Follow the steps in the Install Wizard.

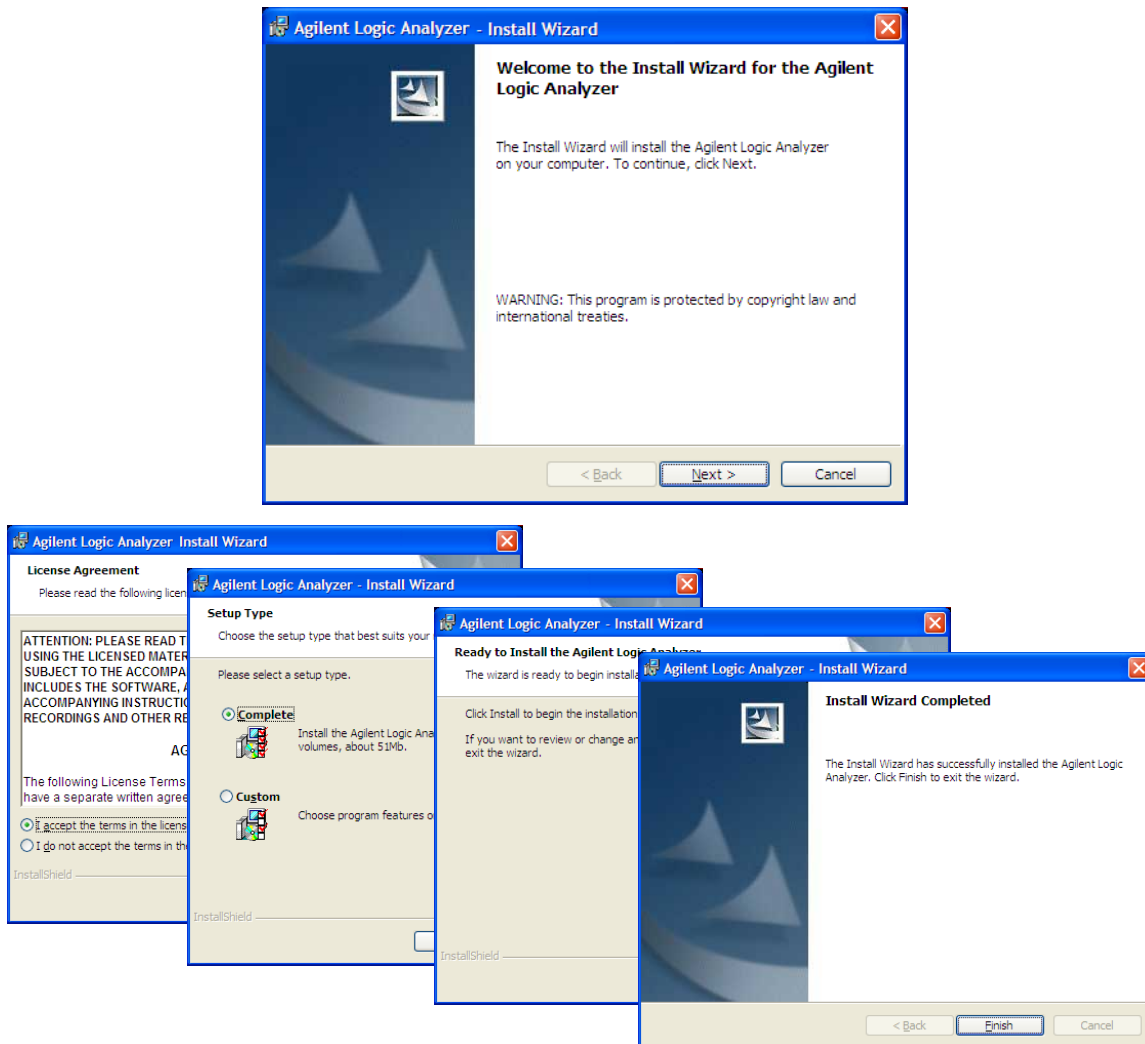

Installing the logic analyzer application on another Windows XP or Windows 2000 computer allows you to analyze data without the logic analyzer.

Logic analyzer product CDs can be ordered from this web-site:  
<http://software.cos.agilent.com/LogicAnalyzerSW>

To be notified when software upgrades are available for downloading from the web, please sign up for e-mail notifications at:  
<http://www.agilent.com/find/emailupdates>

## Specifications and Characteristics

The following electrical and operating characteristics are not specifications, but are typical operating characteristics for the Agilent 1690-series logic analyzers.

---

### Electrical Characteristics

<b>Power Requirements</b>	Frame: 115/230 Vac +/- 20%, 48-66Hz, 610W Max CAT II (Line voltage in appliance and to wall outlet) Pollution degree 2
<b>Ferrites</b>	In order to ensure compliance of the Agilent 1680-series logic analyzers to the CISPR 11 Class A radio frequency interference (RFI) limits, you must install the ferrite to absorb radio frequency energy. Adding or removing ferrites will not affect the normal operation of the analyzer.

---

### Environmental Characteristics (Operating)

<b>Temperature</b>	Instrument: 0° to + 50° C (+32° to +122° F) Disk Media: 10° to + 40° C (+50° to +104° F) Probes/cables: 0° to + 65° C (+32° to +149° F)
<b>Altitude</b>	3,000 m (10,000 ft)
<b>Humidity</b>	Relative humidity 8 to 80% at 40° C (104° F). Avoid sudden, extreme temperature changes which could cause condensation on the circuit board. For indoor use only.

More specifications and characteristics for your instrument and measurement modules are in the on-line help. To find them go to:

**1 Click Help>Help Topics.**

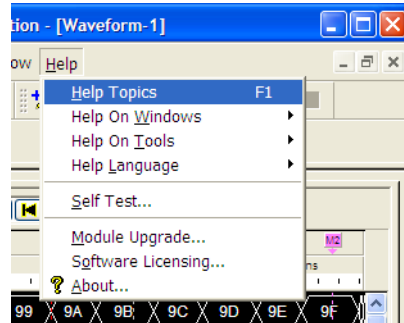

**2 Click Reference>Specifications and Characteristics.**

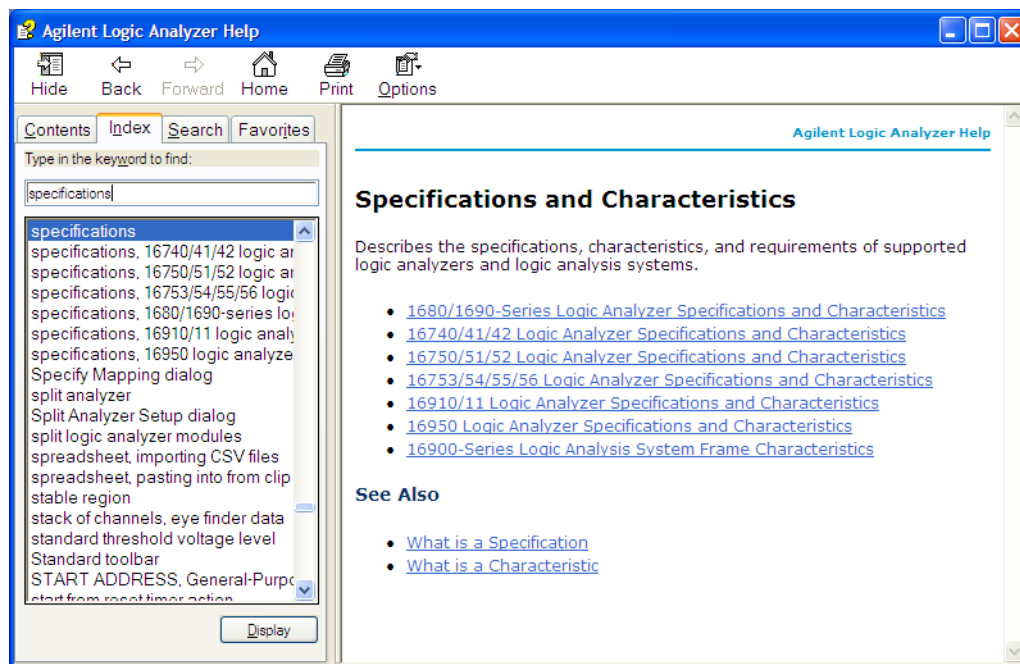

## Safety Notices

This apparatus has been designed and tested in accordance with IEC Publication 1010, Safety Requirements for Measuring Apparatus, and has been supplied in a safe condition. This is a Safety Class I instrument (provided with terminal for protective earthing). Before applying power, verify that the correct safety precautions are taken (see the following warnings). In addition, note the external markings on the instrument that are described under "Safety Symbols."

### Warnings

- Before turning on the instrument, you must connect the protective earth terminal of the instrument to the protective conductor of the (mains) power cord. The mains plug shall only be inserted in a socket outlet provided with a protective earth contact. You must not negate the protective action by using an extension cord (power cable) without a protective conductor (grounding). Grounding one conductor of a two-conductor outlet is not sufficient protection.
- Only fuses with the required rated current, voltage, and specified type (normal blow, time delay, etc.) should be used. Do not use repaired fuses or short-circuited fuse holders. To do so could cause a shock or fire hazard.
- If you energize this instrument by an auto transformer (for voltage reduction or mains isolation), the common terminal must be connected to the earth terminal of the power source.
- Whenever it is likely that the ground protection is impaired, you must make the instrument inoperative and secure it against any unintended operation.
- Service instructions are for trained service personnel. To avoid dangerous electric shock, do not perform any service unless qualified to do so. Do not attempt internal service or adjustment unless another person, capable of rendering first aid and resuscitation, is present.
- Do not install substitute parts or perform any unauthorized modification to the instrument.
- Capacitors inside the instrument may retain a charge even if the instrument is disconnected from its source of supply.

- Do not operate the instrument in the presence of flammable gasses or fumes. Operation of any electrical instrument in such an environment constitutes a definite safety hazard.
- Do not use the instrument in a manner not specified by the manufacturer.
- To optimize your comfort and productivity, it is important that you set up your work area correctly and use your equipment properly. Refer to [http://www.agilent.com/quality/Working\\_In\\_Comfort.pdf](http://www.agilent.com/quality/Working_In_Comfort.pdf) for set-up and use recommendations
- Position equipment so that it is not difficult to disconnect the power cord.

### To clean the instrument

If the instrument requires cleaning:

- 1 Remove power from the instrument.
- 2 Clean the external surfaces of the instrument with a soft cloth dampened with a mixture of mild detergent and water.
- 3 Make sure that the instrument is completely dry before reconnecting it to a power source.

### Safety Symbols



Instruction manual symbol: the product is marked with this symbol when it is necessary for you to refer to the instruction manual in order to protect against damage to the product.



Hazardous voltage symbol.



Earth terminal symbol: Used to indicate a circuit common connected to grounded chassis.

© Agilent Technologies, Inc. 2004  
Printed in Malaysia March 2004



Manual part number 01690-97005



**Agilent Technologies**