



Advanced Test Equipment Rentals
www.atecorp.com 800-404-ATEC (2832)



Power Platform[®] 4300
TASKCard[®] 808
User's Guide

P/N OM-4300-TASK808 Reprinted 7/98

Dranetz-BMI • 1000 New Durham Road • Edison, NJ 08818-4019
Telephone 1-800-372-6832 or 732-287-3680
Fax 732-248-1834 • www.dranetz-bmi.com

WARNING

Death, serious injury, or fire hazard could result from improper connection of this instrument. Read and understand this manual before connecting this instrument. Follow all installation and operating instructions while using this instrument.

Connection of this instrument must be performed in compliance with the National Electrical Code (ANSI/NFPA 70-1996) of USA and any additional safety requirements applicable to your installation.

Installation, operation, and maintenance of this instrument must be performed by qualified personnel only. The National Electrical Code defines a qualified person as "one familiar with the construction and operation of the equipment and the hazards involved."

ADVERTENCIA

Una conexión incorrecta de este instrumento puede producir la muerte, lesiones graves y riesgo de incendio. Lea y entienda este manual antes de conectar. Observe todas las instrucciones de instalación y operación durante el uso de este instrumento.

La conexión de este instrumento debe ser hecha de acuerdo con las normas del Código Eléctrico Nacional (ANSI/NFPA 70-1996) de EE. UU., además de cualquier otra norma de seguridad correspondiente a su establecimiento.

La instalación, operación y mantenimiento de este instrumento debe ser realizada por personal calificado solamente. El Código Eléctrico Nacional define a una persona calificada como "una que esté familiarizada con la construcción y operación del equipo y con los riesgos involucrados."

AVERTISSEMENT

Si l'instrument est mal connecté, la mort, des blessures graves, ou un danger d'incendie peuvent s'en suivre. Lisez attentivement ce manuel avant de connecter l'instrument. Lorsque vous utilisez l'instrument, suivez toutes les instructions d'installation et de service.

Cet instrument doit être connecté conformément au National Electrical Code (ANSI/NFPA 70-1996) des Etats-Unis et à toutes les exigences de sécurité applicables à votre installation.

Cet instrument doit être installé, utilisé et entretenu uniquement par un personnel qualifié. Selon le National Electrical Code, une personne est qualifiée si "elle connaît bien la construction et l'utilisation de l'équipement, ainsi que les dangers que cela implique."

WARNUNG

Der falsche Anschluss dieses Gerätes kann Tod, schwere Verletzungen oder Feuer verursachen. Bevor Sie dieses Instrument anschliessen, müssen Sie die Anleitung lesen und verstanden haben. Bei der Verwendung dieses Instruments müssen alle Installation- und Betriebsanweisungen beachtet werden.

Der Anschluss dieses Instruments muss in Übereinstimmung mit den nationalen Bestimmungen für Elektrizität (ANSI/NFPA 70-1996) der Vereinigten Staaten, sowie allen weiteren, in Ihrem Fall anwendbaren Sicherheitsbestimmungen, vorgenommen werden.

Installation, Betrieb und Wartung dieses Instruments dürfen nur von Fachpersonal durchgeführt werden. In dem nationalen Bestimmungen für Elektrizität wird ein Fachmann als eine Person bezeichnet, welche "mit der Bauweise und dem Betrieb des Gerätes sowie den dazugehörigen Gefahren vertraut ist."

Safety Summary

Definitions

WARNING statements inform the user that certain conditions or practices could result in loss of life or physical harm.

CAUTION statements identify conditions or practices that could harm the Power Platform, its data, other equipment, or property.

NOTE statements call attention to specific information.

Symbols

The following International Electrotechnical Commission (IEC) symbols are marked on the top and rear panel in the immediate vicinity of the referenced terminal or device:



Caution, refer to accompanying documents (this manual).



Direct current (DC) operation of the terminal or device.



Power Switch

Definiciones

Las ADVERTENCIAS informan al usuario de ciertas condiciones o prácticas que podrían producir lesiones mortales o daño físico.

Las PRECAUCIONES identifican condiciones o prácticas que podrían dañar la Power Platform, sus datos, otros equipos o propiedad.

Las NOTAS llaman la atención hacia la información específica.

PP4300/Task 808

Símbolos

Los siguientes símbolos de la Comisión Internacional Electrotécnica (IEC) aparecen marcados en el panel superior y el posterior inmediatos al terminal o dispositivo en referencia:



Precaución, consulte los documentos adjuntos (este manual).



Operación de corriente continua (CC) del terminal o dispositivo.



Interruptor de encendido

Définitions

Les messages d'AVERTISSEMENT préviennent l'utilisateur que certaines conditions ou pratiques pourraient entraîner la mort ou des lésions corporelles.

Les messages de MISE EN GARDE signalent des conditions ou pratiques susceptibles d'endommager "Power Platform", ses données, d'autres équipements ou biens matériels.

Les messages NOTA attirent l'attention sur certains renseignements spécifiques.

Symboles

Les symboles suivants de la Commission électrotechnique internationale (CEI) figurent sur le panneau arrière supérieur situé à proximité du terminal ou de l'unité cité:



Mise en garde, consultez les documents d'accompagnement (ce manual).



Fonctionnement du terminal ou de l'unité courant continu (CC).



Interrupteur de tension

Definitionen

WARNUNGEN informieren den Benutzer darüber, daß bestimmte Bedingungen oder Vorgehensweisen körperliche oder tödliche Verletzungen zur Folge haben können.

VORSICHTSHINWEISE kennzeichnen Bedingungen oder Vorgehensweisen, die zu einer Beschädigung von Power Platform, seiner Daten oder anderer Geräte bzw. von Eigentum führen können.

HINWEISE machen auf bestimmte Informationen aufmerksam.

Symbole

Die folgenden Symbole der Internationalen Elektrotechnischen Kommission (International Electrotechnical Commission; IEC) befinden sich auf der Abdeck- und Seitenplatte unmittelbar am betreffenden Terminal oder Gerät.



Vorsichtshinweis, siehe Begleitdokumente (dieses Handbuch).



Gleichstrombetrieb im Terminal oder Gerät.



Netzschalter

Safety Precautions

The following safety precautions must be followed whenever any type of connection is being made to the instrument.

- Connect the green safety (earth) ground first, before making any other connections.
- When connecting to electric circuits or pulse initiating equipment, open their related breakers. DO NOT install any connection of the instrument on live power lines.
- Connections must be made to the instrument first, then connect to the circuit to be monitored.
- Wear safety glasses and insulated gloves when making connections to power circuits.
- Hands, shoes and floor must be dry when making any connection to a power line.
- Make sure the unit is turned OFF before connecting probes to the rear panel.
- Before each use, inspect all cables for breaks or cracks in the insulation. Replace immediately if defective.

PP4300/Task 808

Medidas de seguridad

Las medidas de seguridad siguientes deberán observarse cuando se realice cualquier tipo de conexión al instrumento.

- Antes de hacer cualquier conexión, deberá enchufarse el conector de seguridad verde a tierra.
 - Cuando se haga conexiones a circuitos eléctricos o a equipo de activación por pulso, deberá abrirse sus respectivas cajas de seguridad. NO deberá hacerse ninguna conexión del instrumento en líneas eléctricas bajo tensión.
 - Las conexiones deberán hacerse primero al instrumento y, luego, al circuito a ser monitorizado.
 - Al hacer conexiones a circuitos eléctricos, deberá utilizar anteojos y guantes protectores.
 - Sus manos, zapatos y el piso deberán estar secos en todo momento en que se haga una conexión a un cable eléctrico.
 - Verifique que la unidad esté DESACTIVADA antes de conectar sondas en el panel posterior.
 - Previo a cada uso, deberá verificarse que los cables no estén rotos y que el material aislante no tenga rajaduras. Reemplace de inmediato cualquier parte defectuosa.
-

Mesures de Sécurité

Les mesures de sécurité suivantes doivent être prises chaque fois qu'un type de connexion quelconque est effectué sur l'instrument.

- Connecter d'abord la prise de terre de sécurité verte (terre) avant d'effectuer toute autre connexion.
 - Ouvrir les disjoncteurs correspondants lors d'une connexion à des circuits électriques ou à des équipement de génération d'impulsions. NE PAS effectuer de connexion d'instrument sur des lignes électriques sous tension.
 - Une fois toutes les connexions de l'instrument effectuées, connecter au circuit à contrôler.
 - Porter des lunettes de protection et des gants isolants pour effectuer des connexions aux circuits électriques.
 - S'assurer que les mains, les chaussures et le sol soient secs lors de connexions à une ligne électrique.
 - S'assurer que l'unité est ÉTEINTE avant de connecter les sondes au panneau arrière.
 - Inspecter tous les câbles, avant chaque utilisation, pour s'assurer que les isolants ne sont pas coupés ou fendus. Remplacer immédiatement tous les équipements défectueux.
-

Sicherheitsvorkehrungen

Die folgenden Sicherheitsvorkehrungen sind immer dann zu befolgen, wenn eine Verbindung zum Instrument hergestellt wird.

- Schließen Sie zuerst die grüne Sicherheits-/Erdleitung an, bevor Sie eine andere Verbindung herstellen.
- Öffnen Sie beim Anschluß an elektrische Stromkreise oder Impulsauslösungseinrichtungen die entsprechenden Unterbrecher. Es dürfen KEINE Anschlüsse an das Instrument unter stromführenden Spannungsleitungen montiert werden.
- Die Verbindungen müssen zuerst am Instrument und danach an der zu überwachenden Schaltung hergestellt werden.
- Tragen Sie Schutzbrillen und Isolierhandschuhe, wenn Sie Anschlüsse an den Stromkreisen vornehmen.
- Hände, Schuhe und Fußboden müssen trocken sein, wenn Sie Anschlüsse an den Stromkreisen durchführen.
- Stellen Sie sicher, daß das Gerät AUSgeschaltet ist, bevor Sie an der rückwärtigen Konsole Meßfühler anschließen.
- Prüfen Sie vor jedem Gebrauch alle Kabel auf Bruchstellen und Risse in der Isolierung. Wechseln Sie schadhafte Kabel sofort aus.

Statements and Notices

Notice regarding proprietary rights

This publication contains information proprietary to Dranetz-BMI. By accepting and using this manual, the user agrees that the information contained herein will be used solely for the purpose of operating equipment of Dranetz-BMI.

Copyright

This publication is protected under the copyright laws of the United States Title 17 et seq. No part of this publication may be reproduced, transmitted, transcribed, stored in a retrieval system, or translated into any language or computer language, in any form, by any means, electronic, mechanical, magnetic, optical, chemical, manual or otherwise, without the prior written consent of Dranetz-BMI, 1000 New Durham Road, Edison, New Jersey 08818.

Copyright © 1997, Dranetz-BMI
All Rights Reserved. Printed in the United States of America.

Revision rights

Dranetz-BMI reserves the right to revise this publication from time to time and to make changes in its content without any obligation of notifying previous users of such revisions or changes.

Trademarks

Power Platform, TASKCard, Scope Mode, DRAN-LINK, DRAN-VIEW and Task 808 are registered trademarks of Dranetz-BMI.

Statement of reliability

The information in this manual has been reviewed and is believed to be entirely reliable, however, no responsibility is assumed for any inaccuracies. All material is for informational purposes only and is subject to change without prior notice.

Continued on next page

Statements and Notices, *continued*

Statement of warranty

All products of Dranetz-BMI are warranted to the original purchaser against defective material and workmanship for a period of one year from the date of delivery. Dranetz-BMI will repair or replace, at its option, all defective equipment that is returned, freight prepaid, during the warranty period. There will be no charge for repair provided there is no evidence that the equipment has been mishandled or abused. This warranty shall not apply to any defects resulting from improper or inadequate maintenance, buyer-supplied hardware/software interfacing, unauthorized modification or misuse of the equipment, operation outside of environmental specifications, or improper site preparation or maintenance.

Notice regarding FCC compliance

This device has been tested and found to comply with the limits for a Class A digital device, pursuant to Part 15 of the FCC Rules. These limits are designed to provide reasonable protection against harmful interference when the equipment is operated in a commercial environment. This equipment generates, uses, and can radiate radio frequency energy and, if not installed and used in accordance with the instruction manual, may cause harmful interference to radio communications. Operation of this equipment in a residential area is likely to cause harmful interference in which case the user will be required to correct the interference at his/her own expense.

TABLE OF CONTENTS

| | |
|---|-----------|
| SAFETY SUMMARY | V |
| CHAPTER 1 GETTING STARTED..... | 1 |
| 1.1 Introduction..... | 1 |
| 1.2 Unpack The PP4300..... | 1 |
| 1.3 Check Contents | 2 |
| 1.3.1 Standard Accessories | 2 |
| 1.3.2 Inspect for Damage..... | 2 |
| 1.3.3 Return Shipment..... | 2 |
| CHAPTER 2 INTRODUCTION TO THE PP4300/TASK 808..... | 3 |
| 2.1 PP4300..... | 3 |
| 2.2 The Task 808 Application | 3 |
| 2.2.1 Task 808 Model Options | 3 |
| 2.2.2 Task 808 Power Circuit Configurations | 4 |
| 2.2.4 EASY START™ Feature | 5 |
| 2.2.5 DRAN-LINK and DRAN-VIEW | 5 |
| 2.2.6 Memory Cards (optional)..... | 5 |
| CHAPTER 3 HARDWARE OVERVIEW..... | 7 |
| 3.1 PP4300..... | 7 |
| 3.1.1 Front and Bottom Panels | 9 |
| 3.1.2 Top, Right and Left Panels | 10 |
| 3.1.3 Back Panel..... | 11 |
| 3.1.4 PP4300 Power Requirements..... | 11 |
| 3.2 The Task 808..... | 12 |
| 3.2.1 TASKCard Installation..... | 12 |
| CHAPTER 4 TOURING THE TASK 808 | 15 |
| 4.1 Preparing for the Guided Tours... .. | 15 |
| 4.2 Screen layout..... | 15 |

| | |
|--|-----------|
| 4.3 Navigation Tips | 16 |
| 4.3.1 Using SOFTKeys..... | 16 |
| 4.3.2 Numbered Options | 17 |
| 4.3.3 Highlight Bar..... | 17 |
| 4.4 Data Entry | 18 |
| 4.4.1 Alphabetic Entry..... | 18 |
| 4.4.2 Numeric Entry..... | 18 |
| 4.5 Help Screens | 18 |
| | |
| CHAPTER 5 EASY START TOUR | 21 |
| | |
| 5.1 Prepare the PP4300 | 22 |
| 5.2 Connect the probes | 22 |
| 5.3 Power ON the PP4300 | 23 |
| 5.4 Easy Start -- Configure/Monitor | 25 |
| 5.5 Viewing Data/Reports | 31 |
| 5.5.1 Viewing Scope Mode..... | 31 |
| 5.5.2 Viewing in Meter Mode | 32 |
| | |
| CHAPTER 6 ADVANCED TOUR | 35 |
| | |
| 6.1 Setup Menu | 36 |
| 6.1.1 Easy Start | 36 |
| 6.1.2 Set Programmable Features..... | 36 |
| 6.1.3 Turn Monitoring ON/OFF..... | 38 |
| 6.1.4 Memory Functions | 38 |
| 6.1.5 Set Input Configurations | 45 |
| | |
| CHAPTER 7 REPORTING TOUR | 53 |
| | |
| 7.1 View Data | 54 |
| 7.2 Meter Mode | 64 |
| 7.3 Viewing Harmonics | 68 |
| 7.4 Screen Printing | 69 |
| | |
| APPENDIX A PRODUCT SUPPORT | 71 |

PP4300/Task 808

| | |
|--|-----------|
| A.1 Telephone Support | 71 |
| A.2 Fax Line | 71 |
| A.3 World Wide Web | 71 |
| A.4 Technical support email address | 71 |
| | |
| APPENDIX B MAINTENANCE/SERVICING/RETURN SHIPMENT .. | 73 |
| | |
| B.1 Maintenance/Servicing | 73 |
| B.1.1 Internal Battery Pack Replacement..... | 73 |
| B.1.2 Calibration | 77 |
| | |
| B.3 Return Shipment | 77 |
| B.3.1 Shipping Address | 78 |
| | |
| APPENDIX C OPTIONAL ACCESSORIES | 79 |
| | |
| C.1 Introduction | 79 |
| | |
| C.2 Optional Accessories List | 79 |
| C.2.1 Optional Accessories Descriptions | 80 |
| | |
| C.3 Ordering information | 84 |
| | |
| APPENDIX D PP4300 TECHNICAL SPECIFICATIONS | 85 |
| | |
| D.1 Overview | 85 |
| D.1.1 Dimensions | 86 |
| D.1.2 Environmental..... | 86 |
| D.1.3 System Time Clock | 86 |
| D.1.4 Memory | 86 |
| D.1.5 Memory Card | 86 |
| D.1.6 Power Requirements..... | 86 |
| D.1.7 Input Resistance..... | 87 |
| D.1.8 Installation Categories..... | 87 |
| | |
| D.2 Interfaces | 87 |
| D.2.1 Display | 87 |
| D.2.2 Alarm..... | 87 |
| | |
| D.3 Measured Parameters | 87 |
| D.3.1 Voltage..... | 87 |
| D.3.2 Current | 88 |

| | |
|---|---------------|
| D.3.3 Phase | 88 |
| D.3.4 Frequency | 88 |
| D.3.5 Environmental..... | 88 |
| D.4 Computed Parameters..... | 89 |
| D.4.1 Update Rate | 89 |
| D.4.2 ABC Volts | 89 |
| D.4.3 ABC Amps..... | 89 |
| D.4.4 Real Power | 89 |
| D.4.5 Apparent Power | 90 |
| D.4.6 Reactive Power | 90 |
| D.4.7 Environmental..... | 90 |
| D.5 Resetting the PP4300 to the Factory Configuration | 91 |
| D.5.1 Configurations | 91 |
| APPENDIX E CONNECTING PROBES/COMMON CIRCUIT CONNECTIONS..... | 93 |
| E.1 Making Voltage Connections | 93 |
| E.1.1 Safety Precautions | 95 |
| E.1.2 Connection guidelines | 98 |
| E.1.3 Single phase connection example | 98 |
| E.1.4 Neutral to ground connection example..... | 100 |
| E.2 Connecting a Current Probe | 101 |
| E.2.1 Safety Precautions | 101 |
| E.2.2 Available probes | 102 |
| E.2.3 Reference to Channel Input | 103 |
| E.2.4 Connection Guidelines | 104 |
| E.2.5 Single phase current probe example | 104 |
| E.3 Common Circuit Connections | 105 |
| E.3.1 Overview..... | 105 |
| E.3.2 Safety Precautions | 105 |
| E.3.3 Voltage and current connections | 107 |
| E.3.4 Phasor diagrams..... | 107 |
| E.3.5 Verifying Voltage and Current Connections | 108 |
| E.4 Single Phase..... | 111 |
| E.4.1 Introduction..... | 111 |
| E.4.2 Connection diagram | 111 |
| E.4.3 Single Phase Phasor Diagrams..... | 111 |
| E.5 Split Phase | 112 |

PP4300/Task 808

| | |
|---|------------|
| E.5.1 Introduction..... | 112 |
| E.5.2 Connection diagram | 112 |
| E.5.3 Split Phase Phasor Diagrams..... | 112 |
| E.6 Open Leg Delta | 113 |
| E.6.1 Introduction..... | 113 |
| E.6.2 Connection diagram | 113 |
| E.6.3 Open Leg Delta Phasor Diagrams | 114 |
| E.7 Four Wire Wye..... | 115 |
| E.7.1 Introduction..... | 115 |
| E.7.2 Connection diagram | 115 |
| E.7.3 Four Wire Wye Phasor Diagrams..... | 116 |
| E.8 High-Leg Delta | 117 |
| E.8.1 Introduction..... | 117 |
| E.8.2 Connection diagram | 117 |
| E.8.3 High Leg Delta Phasor Diagrams..... | 118 |
| E.9 Floating or Grounded Delta | 119 |
| E.9.1 Introduction..... | 119 |
| E.9.2 Connection diagram | 119 |
| E.9.3 Floating or Grounded Delta Phasor Diagrams..... | 120 |
| E.10 Two-and-a-half Element | 121 |
| E.10.1 Introduction | 121 |
| E.10.2 Connection Diagram | 121 |
| E.10.3 Two-and-a-half Element Phasor Diagrams | 122 |
| E.11 Connecting to PTs and CTs..... | 123 |
| E.12 Connecting to a Potential Transformer (PT)..... | 124 |
| E.12.1 Definition..... | 124 |
| E.12.2 Connections | 124 |
| E.12.3 Procedure..... | 125 |
| E.12.4 Scale factor | 125 |
| E.13 Connecting to a Current Transformer (CT)..... | 125 |
| E.13.1 Safety Precautions | 125 |
| E.13.2 Description..... | 127 |
| E.13.3 Types of CTs | 127 |
| E.14 Connecting to an Isolated Current Transformer (ISO) | 127 |
| E.14.1 Introduction | 127 |
| E.14.2 Safety Precautions | 127 |
| E.14.3 Connections to ISO box | 129 |

| | |
|---|------------|
| E.14.4 Applications | 129 |
| E.14.5 ISO box connection to a current transformer..... | 129 |
| APPENDIX F MEMORY CARD FUNCTIONS | 131 |
| F.1 Memory Card Battery Replacement..... | 131 |
| F.1.1 Introduction..... | 131 |
| F.1.2 Battery check | 132 |
| F.1.3 Battery types | 132 |
| F.1.4 Battery Safety Precautions | 132 |
| F.1.5 Replacement procedure | 134 |
| F.2 Memory Card Formatting..... | 135 |
| F.2.1 Memory Card | 135 |
| F.2.2 Memory Card Formatting Procedure | 135 |
| APPENDIX G OPERATOR-REPLACEABLE PARTS..... | 137 |
| G.1 Introduction | 137 |
| G.2 To order parts..... | 137 |
| G.3 Parts List..... | 137 |
| APPENDIX H SYSTEM MESSAGES (PP4300)..... | 139 |
| H.1 Introduction | 139 |
| H.2 Message Types..... | 139 |
| H.2.1 Overview..... | 139 |
| H.2.2 One-line messages..... | 139 |
| H.2.3 Full screen messages..... | 139 |
| H.3 Messages | 141 |
| H.3.1 One-line messages..... | 141 |
| H.3.2 Full screen message..... | 141 |
| H.4 TASKCard error messages..... | 142 |
| INDEX | 143 |

About this Manual...

The objectives pursued in designing and writing this manual were twofold:

- 1) to provide easy-to-follow, step-by-step “how to” instructions for first-time users of the Power Platform 4300 with the Task 808, and
- 2) to provide more experienced users with comprehensive reference documentation presented in an easy-to-find format.

Although the PP4300/Task 808 offers many powerful features, it is *not* a complicated instrument. Learning to use the Task 808 should not be complicated either. This manual incorporates structure, layout, fonts, graphics and lean prose – all designed to make this learning process as quick and as helpful as possible.

Organization

Basically, the information in this manual is organized into three major segments:

- Chap 1 - 4 Introductory “getting started” material
- Chap 5 - 7 Guided Tour material, featuring three tours:
 - Easy Start Tour
 - Advanced Tour
 - Reporting Tour
- Appendices - Reference material – lots of details

Chapter 1 Getting Started

1.1 Introduction

The Task 808 is one of a series of TASKCard-based applications from Dranetz-BMI. The Power Platform 4300 serves as the hardware platform for various applications, each of which is stored on PCMCIA-compatible memory cards called TASKCards. Optional memory cards are available for supplementary data storage.

Task 808 applications include:

- Demand and energy surveys
- Power Factor studies
- General three phase volt-ammeter measurements
- Performance qualification
- Sub-metering
- Power use trends establishment
- Metering/utility meter verification
- Nameplate data certification
- Detection of overloaded feeders
- Tracking facility efficiency vs. production output
- Transformer and neutral conductor derating

1.2 Unpack The PP4300

Open the carton carefully. Check the carton inventory and inspect the contents for possible shipping damage.

- Remove all literature, including warranty card
- Remove the PP4300 from the carton
- Remove all accessories from the carton

NOTE - You may wish to save packing cartons and materials to use in the event return shipment is required at some future date (for calibration, etc.).

1.3 Check Contents

Check that the PP4300 and all of the standard accessories are included:

1.3.1 Standard Accessories

| Description | Part Number |
|--|-----------------------------|
| AC Adapter/Battery Charger | 116297-G1 |
| Cable Pouch | 116043-G1 |
| Carrying Strap | 116040-G1 |
| Easel | 116038-G1 |
| Measurement Cable Set, w/Alligator Clips | 116042-G1 |
| User's Guide | OM-4300-TASK808 |
| *Power Cord, Shielded, 115 Vac | 110893-G1 |
| *Power Cord, Shielded, 230 Vac (Euro) | 115369-G1 |
| *Power Cord, Shielded, 230 Vac (UK) | 115368-G1 |
| TASKCard 808 M (or H-M) | TASK808M, or TASK808/H/M |
| Wire Marker Set | 155520 |
| *User specified, one standard only. | |

■ Refer to Appendix C for a complete listing of optional accessories for the Task 808. Make sure all optional accessories ordered are included in the package. If any items are missing, contact the Dranetz-BMI Customer Service Department.

1.3.2 Inspect for Damage

Visually inspect the PP4300 and all accessories for any shipping damage. If unit has been damaged in any way, first notify and file an insurance claim with your carrier or underwriter or both.

1.3.3 Return Shipment

■ Refer to Appendix B Maintenance/Service/Return Shipment for important instructions regarding return shipment of any damaged items.

Chapter 2 Introduction to the PP4300/Task 808

The Task 808 is a TASKCard-based PP4300 application. The patented TASKCard is a removable flash memory card that is installed in the PP4300 and contains an operating system designed for a specific application (task).

2.1 PP4300

The Dranetz-BMI Power Platform[®] 4300 is a portable, hand-held, TASKCard[®] based, eight-channel power meter/monitor. The PP4300 is capable of monitoring, recording and displaying data for four voltage and four current channels simultaneously.

■ *Refer to Chapter 3 Hardware Overview for illustrations and detailed descriptions of the various controls, indicators, and connectors.*

2.2 The Task 808 Application

The Task 808 is an application designed primarily for long-term demand and energy surveys. It is intended for use by electrical facilities plant personnel (engineers as well as electricians), energy management consultants and utility marketing services groups.

2.2.1 Task 808 Model Options

Two Task 808 models are available: the 808/M (Memory) with expandable memory and the 808/H-M (Harmonics-Memory).

NOTE - Any model-specific differences in descriptions or procedures will be documented throughout this manual.

Task 808 - model M

This model (808/M) provides all standard features, including 256K internal memory, plus memory card storage capability. Optional memory cards are available in various capacities, shown in Appendix C.

Task 808 - model H-M

In addition to all standard features, including 256K internal memory and memory card storage capability, this model (808/H-M) provides harmonics data, useful for determining the source and level of the effects created, e.g., by the many energy conservation devices in use today, such as electronic lighting ballasts and adjustable speed drives.

2.2.2 Task 808 Power Circuit Configurations

When TASKCard 808-equipped, the PP4300 can monitor any of the following power circuit configurations:

- Single phase
 - Split phase
 - Four wire wye
 - Floating or grounded delta
 - Open leg delta
 - High leg delta
 - Two-and-a-half element
-
- **WARNING: Refer to Appendix E Connecting Probes/Common Circuit Connections for detailed descriptions of common power monitoring configurations and probe connections.**

 - **ADVERTENCIA: Consulte el Apéndice E Conexión de sondas/Conexión de circuitos comunes para obtener descripciones detalladas sobre configuraciones comunes de monitorización eléctrica y conexiones de sondas.**

 - **AVERTISSEMENT: Se reporter à l'Annexe E, Connexion des sondes / Connexions simples des circuits, pour de plus amples détails concernant les configurations de contrôle de puissance et les connexions des sondes.**

 - **WARNUNG: Im Anhang E "Meßfühler verbinden/ Gängige Schaltverbindungen" finden Sie ausführliche Beschreibungen von gängigen Konfigurationen der Spannungsüberwachung und von Meßfühlerverbindungen.**

While monitoring any of the above configurations (except the three delta configurations), the PP4300 can also be connected to monitor neutral-to-ground voltage and neutral or ground current.

2.2.4 EASY START™ Feature

Both Task 808 versions come equipped with the EASY START feature which prompts users for a few key items of information about the circuit being monitored. EASY START programmatically steps the user through the implementation of a basic setup. The system automatically turns on the correct channel(s) and begins monitoring.

2.2.5 DRAN-LINK and DRAN-VIEW

The PP4300/Task 808 can transfer recorded data to a personal computer for subsequent analysis by DRAN-VIEW (PC software for graphic display of Task 808 data) using either an optional memory card reader or optional isolated communications adapter and DRAN-LINK.

- *Refer to Appendix C Optional Accessories for a description of these options.*

2.2.6 Memory Cards (optional)

An optional memory card may be used with the PP4300 to provide a removable, rugged, compact, solid state mass storage device. Memory cards are used to store events and setups.

Memory cards use low power and have an internal battery for data retention. Various capacities are available, see Appendix C.

The PP4300 treats memory cards much like PCs treat floppy disks, storing files in a DOS format.

- *Refer to Chapter 6 Advanced Tour for a complete overview of memory functions.*

Chapter 3 Hardware Overview

This chapter illustrates and describes the key hardware features of the Power Platform 4300 and the TASKCard 808.

3.1 PP4300

The PP4300 is a self-contained, portable instrument weighing less than 4 pounds and measuring 8" (20.3 cm) high by 12" (30.5 cm) wide by 2.5" (6.4 cm) deep.

The front panel contains the display area, SOFTKeys and keypad. The bottom panel contains two slots: one (on the left) for a TASKCard and one (on the right) for an optional memory card.

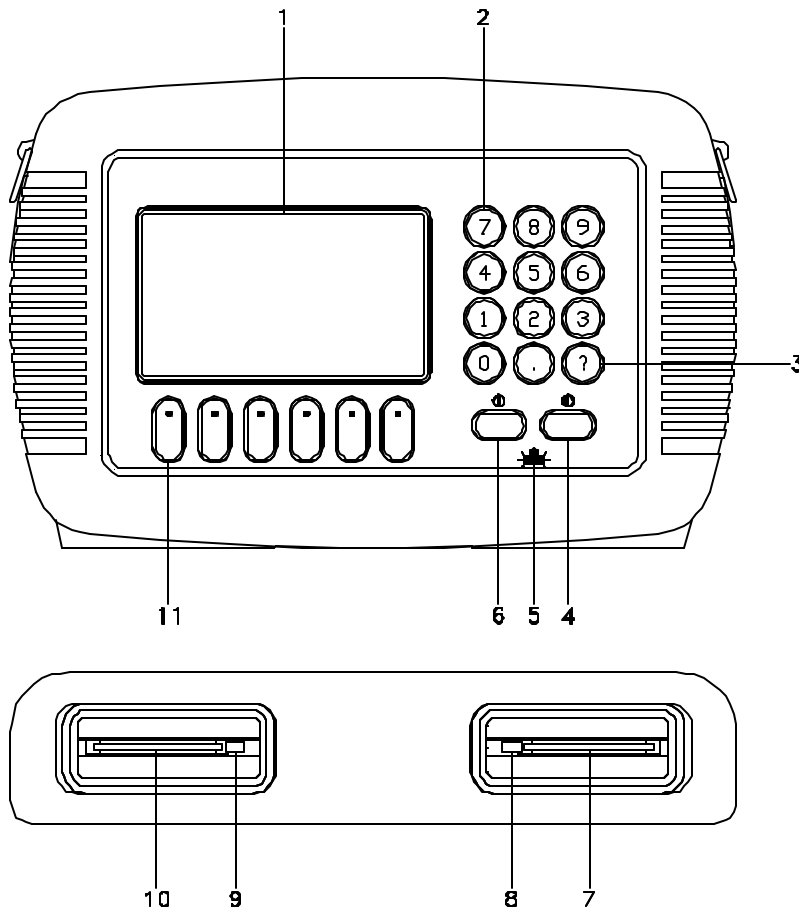

The top panel contains the input voltage and current connectors. The left and right side panels contain the optical interface port and AC adapter/dc input connector, respectively, along with rings for attaching the supplied carrying strap.

Front and Bottom Panels

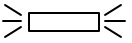

3.1.1 Front and Bottom Panels

The illustration on the facing page references the following items:

- 1 Liquid Crystal Display (LCD). Provides 240 by 128 pixels (dots) of text and graphic information. Has electroluminescent (EL) backlighting for low light level viewing.
- 2 Numeric keypad. Consists of keyboard keys 0 through 9 and decimal point (.). Permits menu selection and numerical data entry.
- 3 Question mark key. Displays Help screen with reference to screen displayed at any time.
- 4 LCD contrast adjustment key. Symbol:  Press and hold for continuous contrast range change, release to stop. Press and quickly release for incremental contrast change.
- 5 Battery charge indicator. LED glows continuously while battery is charging and flashes when fully charged. Symbol: 
- 6 ON/OFF Power Key. Symbol:  Push for ON, push for OFF
- 7 Memory (data) card slot.
- 8 Memory card release. Ejects memory card.
- 9 TASKCard release. Ejects TASKCard.
- 10 TASKCard slot.
- 11 SOFTKeys. Six keys used to select options that appear on bottom of screen. Function selected varies with screen displayed.

3.1.2 Top, Right and Left Panels

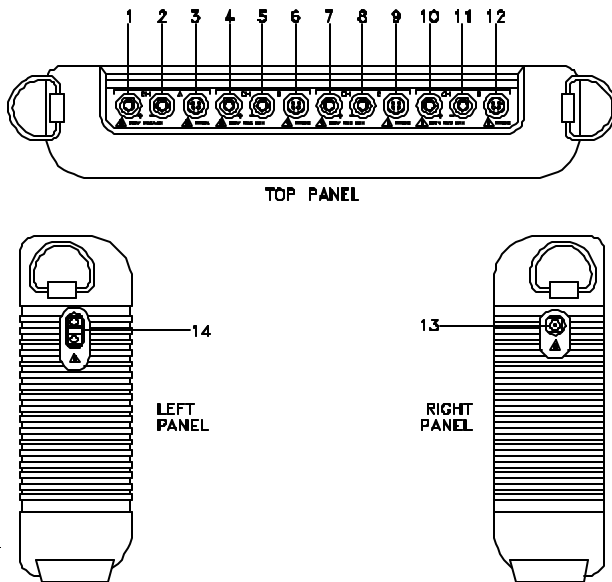

4300 - 18A

Top panel connectors, from left to right (1 through 12), as shown above:

- 1 CH A, + Differential Voltage Input Connector; red
- 2 CH A, - Differential Voltage Input Connector; white
- 3 CH A, PROBE, Current Input Connector
- 4 CH B, + Differential Voltage Input Connector; yellow
- 5 CH B, - Differential Voltage Input Connector; white
- 6 CH B, PROBE, Current Input Connector
- 7 CH C, + Differential Voltage Input Connector; blue
- 8 CH C, - Differential Voltage Input Connector; white
- 9 CH C, PROBE, Current Input Connector
- 10 CH D, + Differential Voltage Input Connector; gray
- 11 CH D, - Differential Voltage Input Connector; white
- 12 CH D, PROBE, Current Input Connector

Side panel connector/port, (13 and 14), as shown above:

- 13 AC Adapter/Battery Charger DC Input Connector
- 14 Optical Serial Data Port

3.1.3 Back Panel

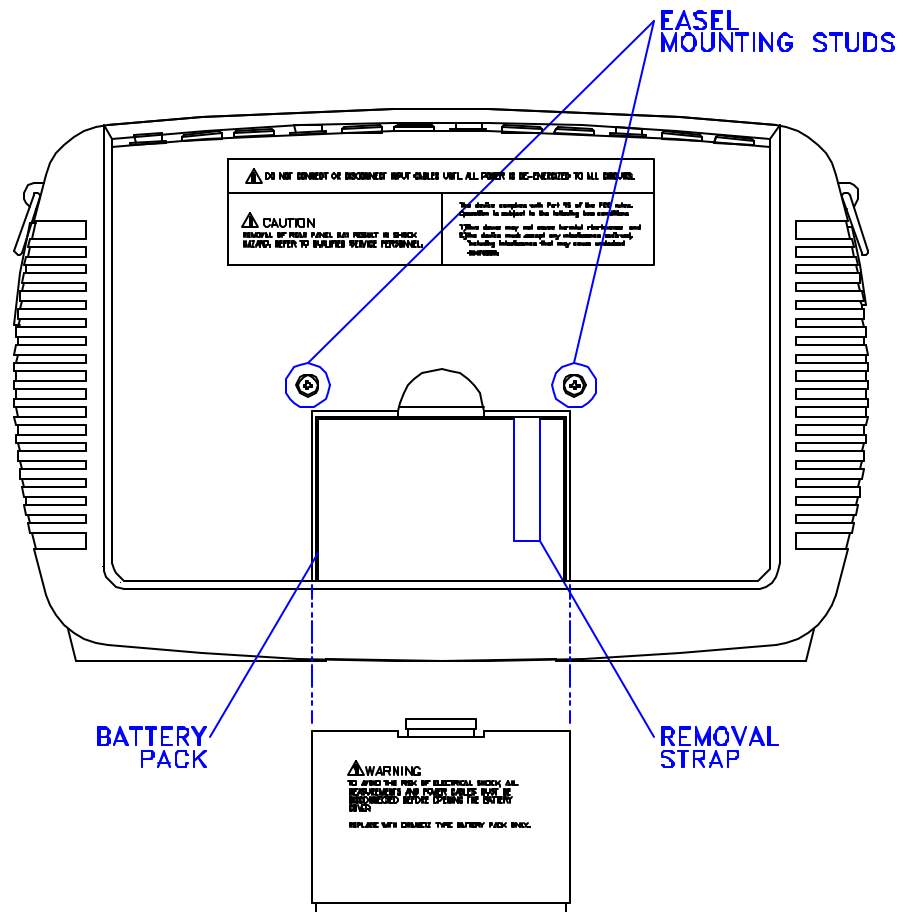

3.1.4 PP4300 Power Requirements

The PP4300 can be operated using either its internal battery pack or the AC Adapter/Battery Charger. Always charge the battery fully before use. The PP4300 will always operate with the AC Adapter/Battery Charger, regardless of the state of charge of the battery.

Charging Battery

Charge the battery pack by connecting the AC adapter output cable to the DC INPUT connector on the right side of the PP4300. Connect the AC adapter power cord to an appropriate outlet. A depleted battery pack can be recharged in 2 hours with the unit OFF and 24 hours with the unit on. The battery charge indicator glows continuously while charging and flashes when fully charged. The indicator light functions only when the unit is turned off and the AC adapter is properly connected.

TASK 808

Length of operation

The PP4300 can operate on a fully charged battery pack for up to four hours. A screen warning will appear during operation when battery charge is low.

AC Power

The PP4300 can be operated from a 50/60 Hz VAC power source using the AC adapter, with or without the battery pack installed.

3.2 The Task 808

3.2.1 TASKCard Installation

Follow these simple steps to install the Task 808 TASKCard.

Step 1 Make sure that the PP4300 is powered OFF. If already ON, press the PP4300 ON/OFF power key to turn unit OFF.

Step 2 Remove TASKCard from its protective holder and check that the plug end of card is clean and free of any obstruction.

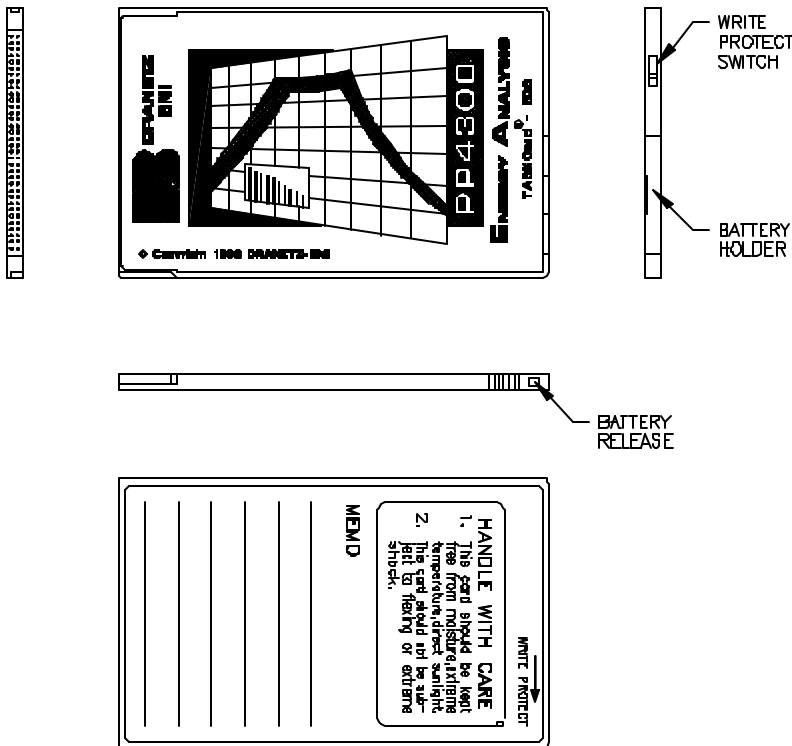

4300-121

If plug end of card is dirty, clean with static-free, dry, low pressure air to remove any foreign material causing obstruction of the plug holes.

Step 3 Verify that the write protect switch (end opposite plug end) is set to the write protect position. Use a pencil point to move the switch to correct position, if required.

Step 4 At the bottom of the unit, position the TASKCard with the label facing front and the plug end facing the TASK CARD slot in the PP4300.

Step 5 Insert the card fully into the slot until resistance is felt, then press firmly until card engagement is felt.

*NOTE - Do not **force** the card into the slot if no card engagement is felt. Remove card and check that there is no foreign object on or in the plug end of the card. Remove any obstruction. Reinsert card and repeat card engagement process. If card cannot be engaged, call Dranetz-BMI Customer Service for instructions.*

■ Refer to Appendix H System Messages for description of TASKCard Error Messages which may be displayed when the unit is powered ON.

Chapter 4 Touring the Task 808

4.1 Preparing for the Guided Tours...

Before jumping into the setup and operation of the Task 808, it is well worth taking a minute or two to review a few simple preliminaries which will help you get started when you begin the Guided Tours.

4.2 Screen layout

All of the Task 808 screens have common elements, such as the following:

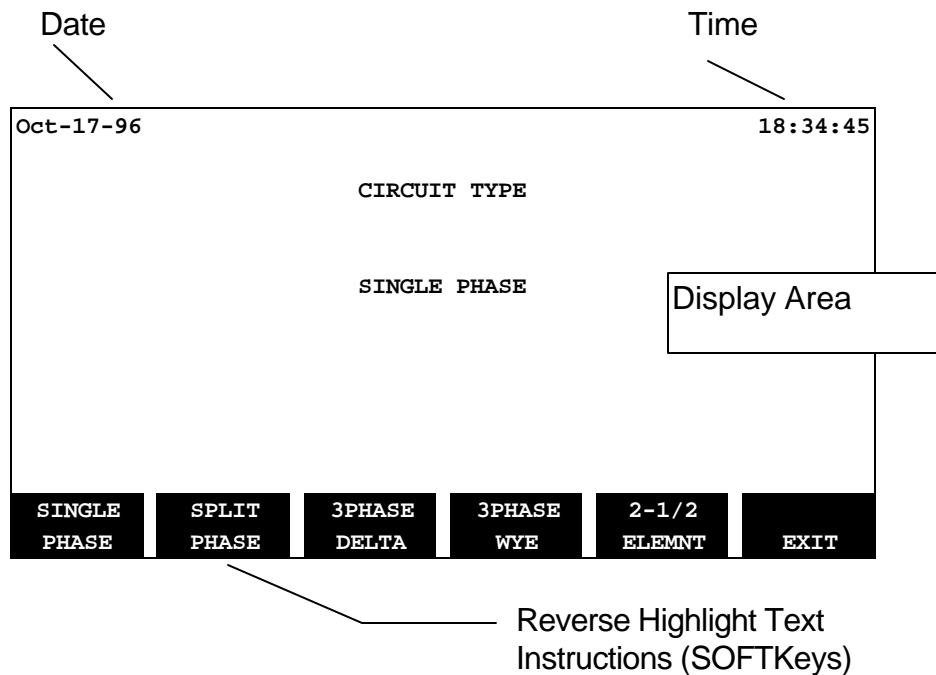

TASK 808

In addition, whenever a graph is displayed, the vertical axis (and scale) for Volts will always be the left axis and the vertical axis (and scale) for Amps will always be the right axis, as shown below:

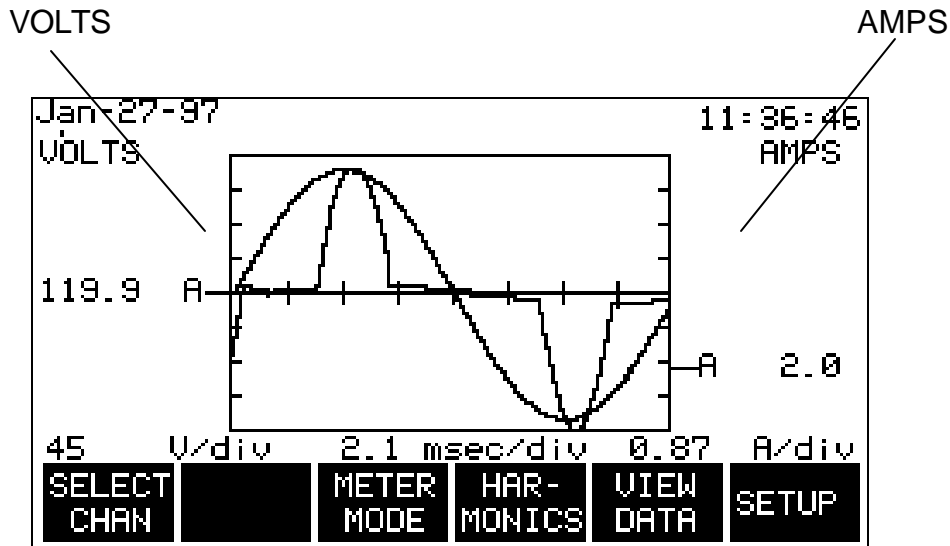

4.3 Navigation Tips

Navigation (moving from screen to screen) is accomplished in two ways:

- 1) Using SOFTKeys, sometimes in conjunction with the highlight bar, and
- 2) Selecting from numbered options.

4.3.1 Using SOFTKeys

The six keys on the PP4300 immediately below the display area are called SOFTKeys and are used to execute the reverse highlight text instruction (such as, **SELECT CHAN**, **METER MODE**, **SETUP**) displayed immediately above each key.

Some SOFTKeys move the highlight from field to field within the display area while other SOFTKeys are used to advance from screen to screen. Other SOFTKeys perform operations, such as, turning features ON and OFF.

*NOTE - Throughout this manual, references to SOFTKeys and their corresponding instructions will be combined into a single phrase, e.g., press the **EXIT** SOFTKey.*

4.3.2 Numbered Options

Several screens consist of a list of numbered options. Simply press the corresponding key on the PP4300's numeric key pad to execute the desired option, e.g., press the 1 key on the "Setup" menu to select Easy Start:

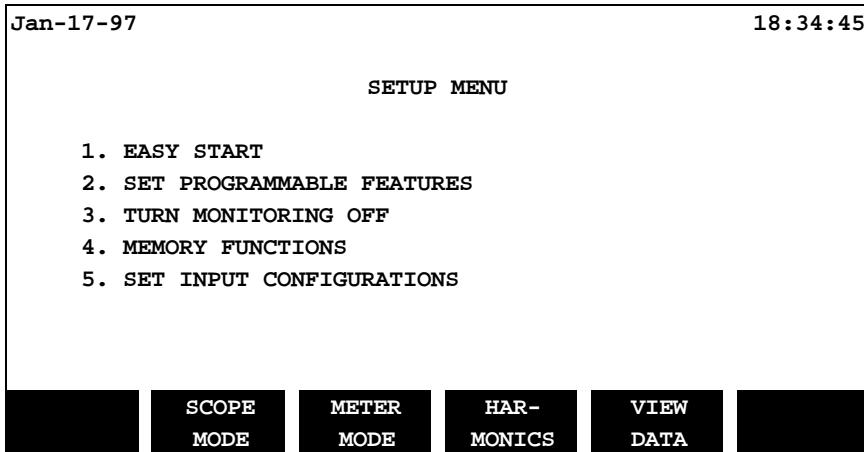

4.3.3 Highlight Bar

Many screens consist of a highlight bar and a list of options with associated values. SOFTKeys are used to highlight, toggle and select values.

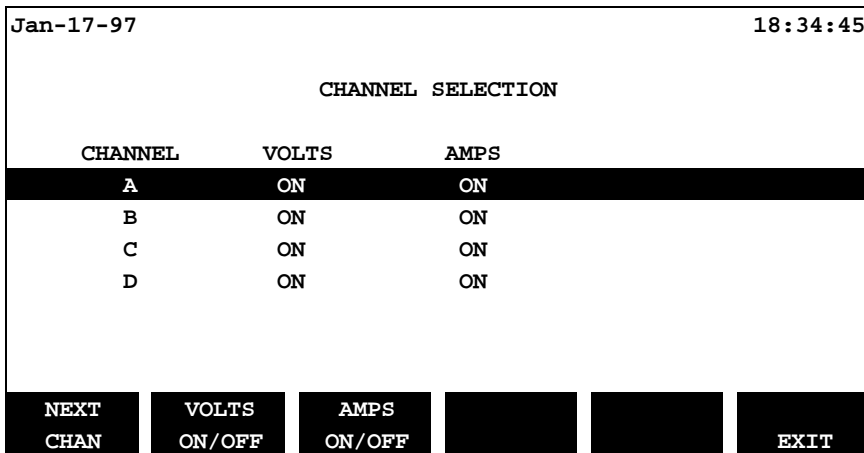

In the example above, the **NEXT CHAN** SOFTKey is used to highlight and select channels. The **VOLTS ON/OFF** and **AMPS ON/OFF** SOFTKeys are used to toggle between ON and OFF. The **EXIT** SOFTKey will implement the selection.

4.4 Data Entry

There are two different methods for manually entering data, depending on whether the data is alphabetic or numeric.

4.4.1 Alphabetic Entry

Alphabetic data must be entered to record the site/file name. Alphabetic data is entered using the special alphabetic entry screen shown below which will automatically be displayed when required:

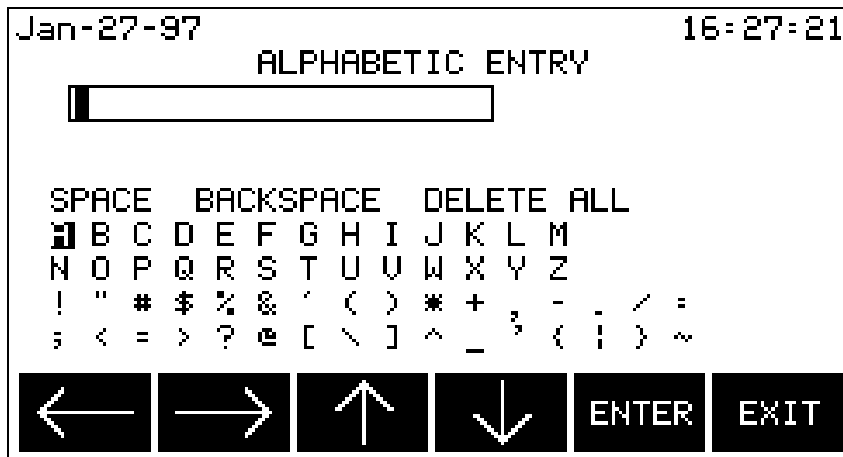

The arrow SOFTKeys are used to highlight desired letters (and SPACE, BACKSPACE, DELETE ALL). The **ENTER** SOFTKey moves highlighted letters into the small text window at the top of the display area until the site/file name is completed.

4.4.2 Numeric Entry

Integers (whole numbers) must be entered to record dates, times and demand intervals. Decimals may be entered to record scale factors, sync parameters, vertical scales and to describe the application. Integers and decimals are entered using the numeric keys and the decimal point on the PP4300's numeric key pad.

4.5 Help Screens

Help screens are available for every screen in the application. Simply press the ? key (question mark key) on the numeric keypad and help for the active screen will be displayed.

On to the Guided Tours...

Now that the preliminaries are completed, continue with the Guided Tours chapters to begin hands-on operation of the Task 808.

Chapters five, six and seven are designed to take the user step by step through the complete setup and operation of the PP4300/Task 808:

Chapter 5 Easy Start Tour - designed to implement a quick, no-frills setup using the programmed EASY START feature.

Chapter 6 Advanced Tour - designed to implement a more sophisticated setup by building on the Easy Start setup.

Chapter 7 Reporting Tour - designed to document the wide array of reporting features in the Task 808.

Recommendation

It is recommended that all three of the guided tours be taken, starting with the Easy Start Tour.

Chapter 5 EASY START Tour

The Easy Start Tour covers the following topics:

- 5.1 Prepare the PP4300**
- 5.2 Connect the Probes**
- 5.3 Power ON the PP4300**
- 5.4 Easy Start -- Configuring/Monitoring**
- 5.5 Viewing Data/Reports**

5.1 Prepare the PP4300

Step 1 Insert the Task 808 TASKCard into the PP4300's TASKCard slot.

■ *Refer to Chapter 3 Hardware Overview for complete TASKCard installation instructions.*

Step 2 Insert a formatted memory card (if applicable) into the PP4300's memory card slot.

■ *Refer to Appendix F Card Functions for complete memory card installation and formatting instructions.*

Step 3 Connect the AC adapter output cable to the DC INPUT connector on the right side of the PP4300. Connect the AC adapter power cord to an appropriate outlet.

5.2 Connect the probes

- **WARNING: Refer to Appendix E Connecting Probes/Common Circuit Connections for detailed descriptions of common power monitoring configurations and probe connections.**
- **ADVERTENCIA: Consulte el Apéndice E Conexión de sondas/Conexión de circuitos comunes para obtener descripciones detalladas sobre configuraciones comunes de monitorización eléctrica y conexiones de sondas.**
- **AVERTISSEMENT: Se reporter à l'Annexe E, Connexion des sondes / Connexions simples des circuits, pour de plus amples détails concernant les configurations de contrôle de puissance et les connexions des sondes.**
- **WARNUNG: Im Anhang E "Meßfühler verbinden/ Gängige Schaltverbindungen" finden Sie ausführliche Beschreibungen von gängigen Konfigurationen der Spannungsüberwachung und von Meßfühlerverbindungen.**

Before powering ON and initiating the Easy Start tour, the probes must be connected. Before connecting anything, **make sure that the circuit to be monitored has been *de-energized*.**

5.3 Power ON the PP4300

Step 1 Press the ON/OFF power button  on the front panel of the PP4300 to turn the power ON.

A screen with the results of self-diagnostic routines will be displayed briefly during power up. All of the self-diagnostic routine results should read PASSED.

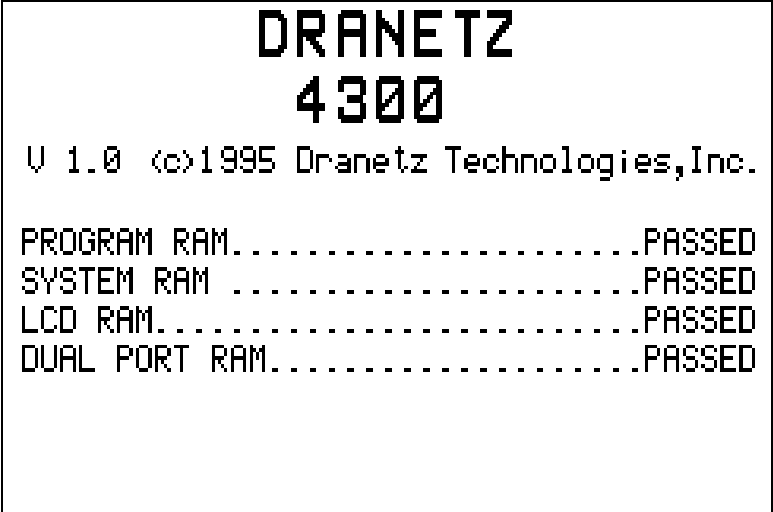

■ Refer to Appendix H System Messages for description of TASKCard Error Messages which may be displayed when the unit is powered ON.

Step 2 Wait for the next screen to be displayed:

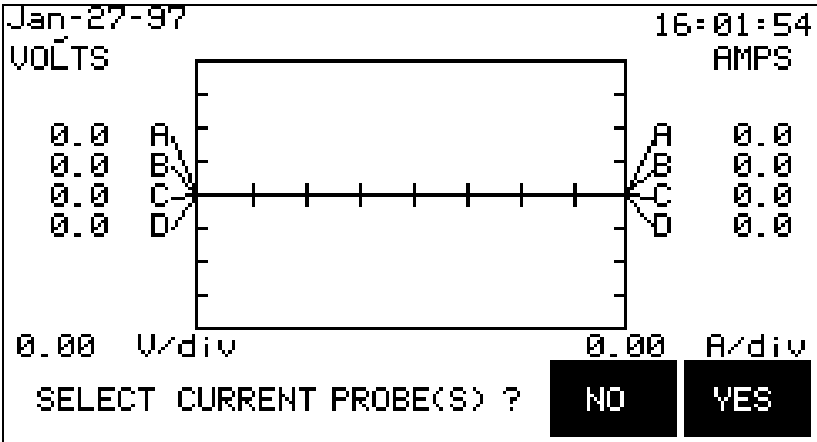

TASK 808

Depending on the PP4300 model in use, the message -- SELECT CURRENT PROBE(S)? -- may be displayed across the bottom of the screen, as a reminder, because correctly identified probe types and scale factors are essential to accurate computations.

The “Scope Mode” screen is a gateway to four major functions of the system: Meter Mode, Harmonics (available to Task 808/H-M model users only), View Data and Setup. The “Scope Mode” screen also acts as a *home* screen from which to branch to other functions of the Task 808.

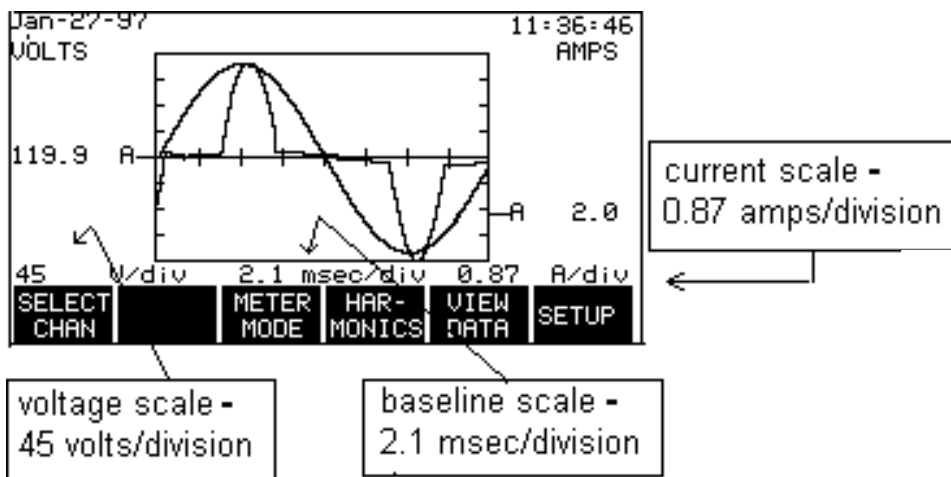

NOTE - When the PP4300 is turned ON, it will always default to the configuration values in effect when the system was last powered OFF. Values for all eight channels will *always* be displayed initially on the “Scope Mode” screen. If the probes are changed while the unit is OFF, all monitored values will be erroneous until the probe and scale factor information is updated.

The message – MONITORING: OFF -- may be displayed across the top of this screen (and across all other screens as well). This message indicates that the PP4300 is not monitoring any circuits, i.e., not recording event data (however, the “Meter Mode,” “Scope Mode” and “Harmonics” screens will still function properly with monitoring OFF). In addition to the obvious, i.e., when the currently active configuration specifies that monitoring is OFF, this message may also be displayed briefly under such circumstances as saving a changed configuration or during the self test. While monitoring is ON, no message is displayed.

Setting the time and date will be covered in the Advanced Tour.

5.4 Easy Start -- Configure/Monitor

Easy Start guides the user step-by-step through a basic configuration process. The final step in the configuration process automatically initiates the circuit monitoring.

Step 1 From the “Scope Mode” screen, press the **NO** SOFTKey to defer selecting current probes until later on in the process. Press the **SETUP** SOFTKey to get started.

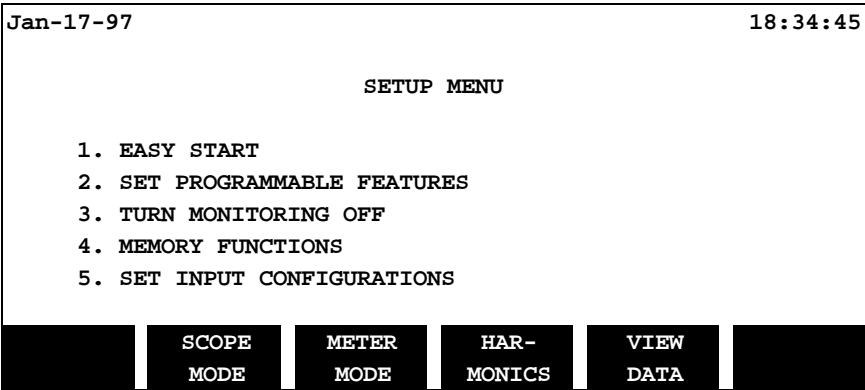

Step 2 At the “Setup Menu,” press the **1** key on the numeric pad to begin the Easy Start process.

The following message will be displayed:

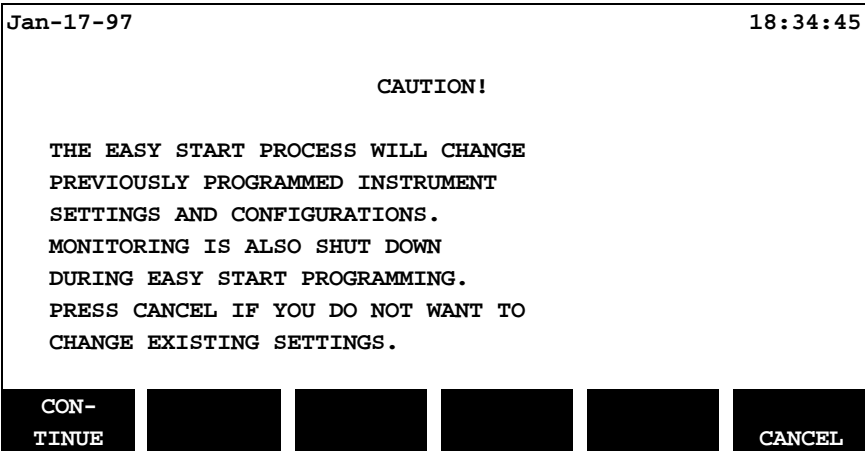

TASK 808

NOTE - The Guided Tours are designed for and are typically followed by users with new PP4300/Task 808 units. If the Task 808 is currently collecting data, you may wish to reschedule these tours when the Task 808 is idle.

Press the **CONTINUE** SOFTKey to display a list of circuit types.

Step 3 Select the desired circuit type by pressing the appropriate SOFTKey.

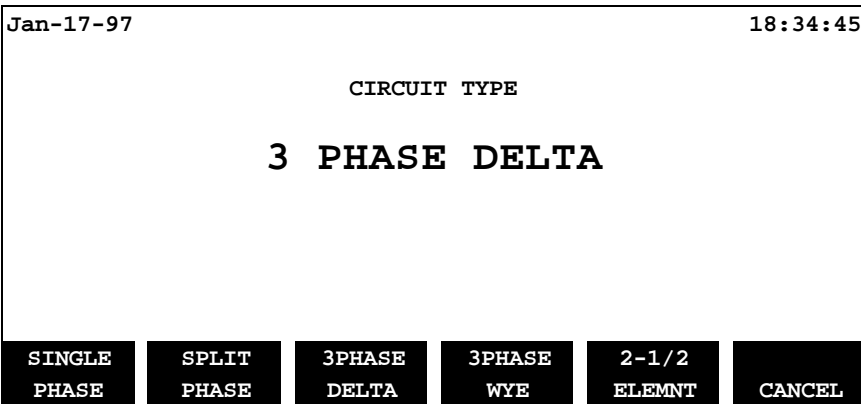

The following safety message will be displayed:

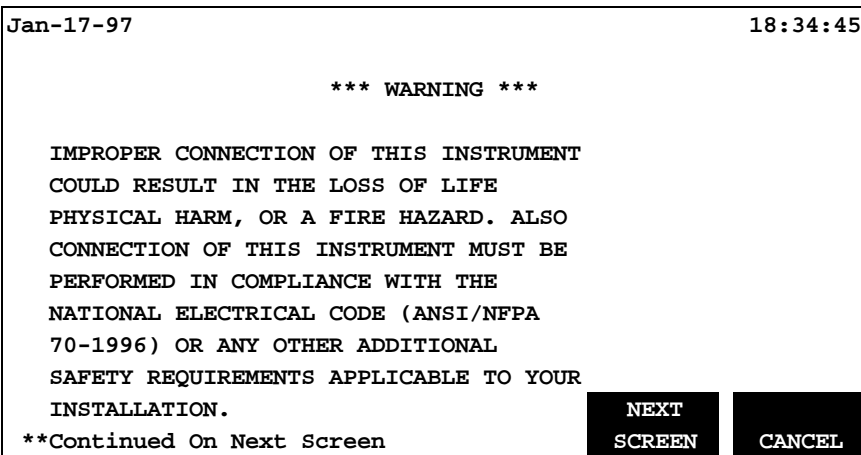

Press the **NEXT SCREEN** SOFTKey to continue. Another safety message will be displayed:

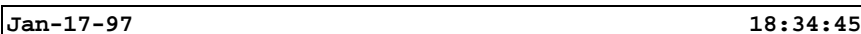

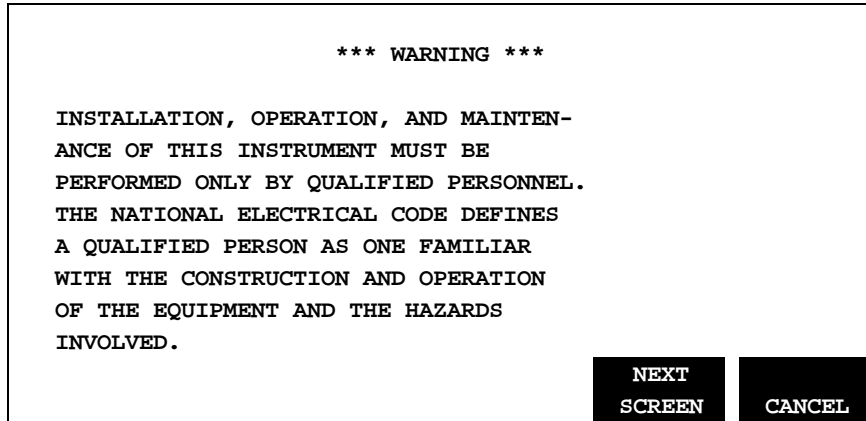

Step 4 Press the **NEXT SCREEN** SOFTKey. A circuit diagram will be displayed showing how to connect the voltage and current probes for the circuit type previously selected.

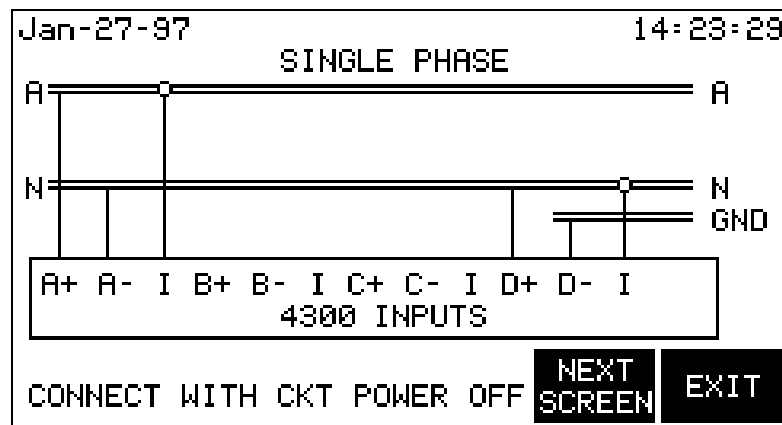

The purpose of this screen is to enable users to verify that all probes have been connected properly. If *not* connected properly, power OFF the PP4300 immediately. Make any necessary changes to the connections, and start the tour over again at 5.3 *Power ON the PP4300*.

Step 5 Press the **NEXT SCREEN** SOFTKey.
The “Current Probes” screen will be displayed.

Jan-17-97 18:34:45

TASK 808

| CURRENT PROBES | |
|----------------|------------|
| CHANNEL | PROBE TYPE |
| A | TR2500 |
| B | TR2500 |
| C | TR2500 |
| D | TR2500 |

NEXT CHAN **NEXT PROBE** **NEXT SCREEN** **CANCEL**

Use the **NEXT CHAN** SOFTKey to highlight channels and the **NEXT PROBE** SOFTKey to toggle through the available current probe types. Specify the probe type for each channel to be monitored (or NONE if the channel will not be monitored). Press the **NEXT SCREEN** SOFTKey when finished with the "Current Probes" screen.

| | |
|--|----------------------------------|
| Jan-17-97 | 18:34:45 |
| ENTER SITE/FILE NAME | |
| PRESENT SITE/FILE NAME: CHILLER | |
| NOTE: THE SITE/FILE NAME WILL BE USED TO NAME FILES STORED ON THE MEMORY CARD. | |
| ENTER NAME | NEXT SCREEN CANCEL |

Step 6 Press the **ENTER NAME** SOFTKey to display the alphabetic entry screen for entry of the site/file name (or press the **NEXT SCREEN** SOFTKey if the site/file name already exists and is OK).

NOTE - The site/file name is important for *two* reasons: 1) it identifies the site where the data was collected, and 2) it becomes the name of the file created when the data is saved. Although up to 20 characters may be used in the name, only the first eight will be used for the file name.

Use the special alphabetic data entry screen shown below to enter the site/file name:

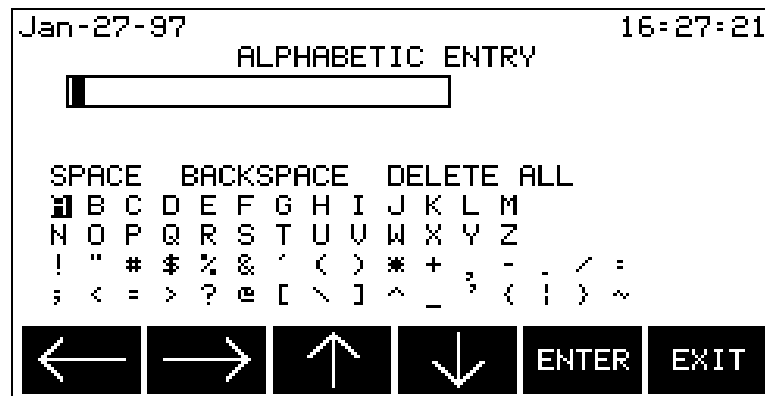

The arrow SOFTKeys are used to highlight desired letters. The **ENTER** SOFTKey moves highlighted letters into the small text window at the top of the display area until the site/file name is completed. Use the numeric keypad for numbers.

Press the **EXIT** SOFTKey when finished. The “Enter Site/File Name” screen will be displayed again.

Press the **NEXT SCREEN** SOFTKey to continue:

TASK 808

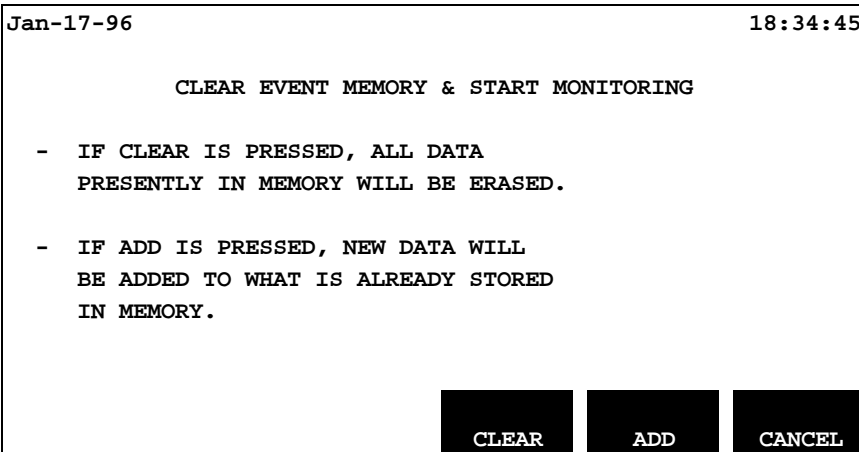

Step 7 Press one of the following SOFTKeys:

CLEAR to clear memory and start collecting event data.

ADD to add new events to those already stored in memory.

CANCEL to quit without changing anything.

If **CLEAR** or **ADD** is selected, circuit monitoring will begin. The “Easy Start Summary” screen will be displayed, summarizing the configuration which has just been defined:

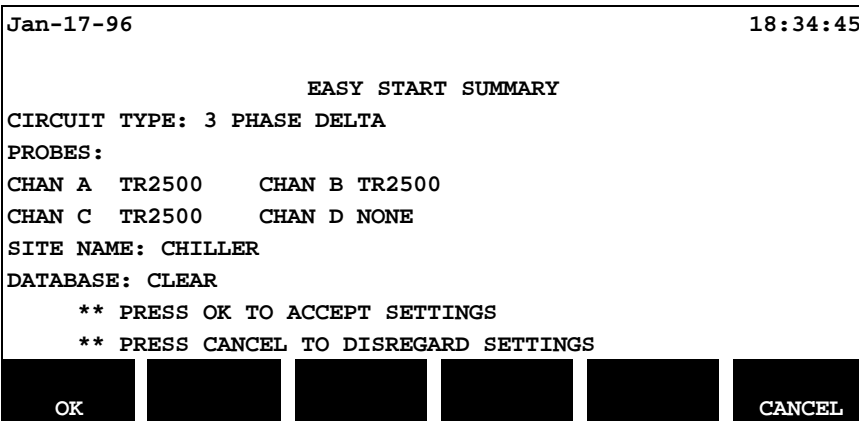

Step 8 Complete the EASY START configuration process by pressing either the **OK** or the **CANCEL** SOFTKey:

| If the configuration is... | Then... |
|----------------------------|---|
| OK | Press the OK SOFTKey to save the configuration. |
| Not OK | Press the CANCEL SOFTKey to quit or start the EASY START process over again from the beginning (without saving the configuration settings). The “Scope Mode” screen will be displayed. |

5.5 Viewing Data/Reports

Once monitoring is ON and data is being collected, user interest naturally shifts from *monitoring* the data to *viewing* the data.

A wealth of viewing options and data formats is available from the “Scope Mode” screen to display the data being collected, including:

- The “Scope Mode” waveform
- The “Meter Mode” data display
- The “Harmonics” graphic and text displays
- The four reporting options from the “View Data” menu

5.5.1 Viewing Scope Mode

The “Scope Mode” screen functions as a power oscilloscope and displays real-time voltage and current waveforms for all eight channels. The display is dynamically updated every two or three seconds.

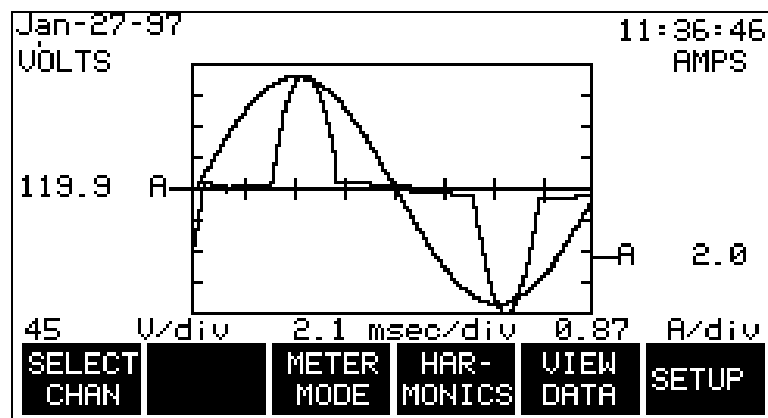

TASK 808

NOTE - At this point, the graph may appear cluttered if data from all eight channels is being displayed. Unwanted data may be filtered out at any time by turning each channel's volts and amps OFF using the "Channel Selection" screen (shown in Step 1 below).

Step 1 Press the **SELECT CHAN** SOFTKey to access the "Channel Selection" screen.

| Jan-17-96 | | 18:34:45 | |
|-------------------|-----------------|----------------|------|
| CHANNEL SELECTION | | | |
| CHANNEL | VOLTS | AMPS | |
| A | ON | ON | |
| B | OFF | OFF | |
| C | OFF | OFF | |
| D | OFF | OFF | |
| NEXT CHAN | VOLTS ON/OFF | AMPS ON/OFF | EXIT |

This screen is used to filter data for display on the "Scope Mode" screen. Toggle volts and amps ON or OFF for each channel as desired. Press the **EXIT** SOFTKey to return to the "Scope Mode" screen.

5.5.2 Viewing in Meter Mode

Step 1 From the "Scope Mode" screen, press the **METER MODE** SOFTKey to display the first of several "Meter Mode" screens.

| Jan-17-96 | | 18:34:45 | | |
|----------------|-------|---------------|--------|-------------|
| METER MODE | | | | |
| CHAN | VOLT | AMP | WATT | VA |
| A | 227.8 | 9.097 | 1.800K | 2.072K |
| B | 229.0 | 9.100 | 1.801K | 2.084K |
| C | 228.3 | 9.146 | 1.810K | 2.088K |
| D | 0.026 | 0.000 | 0.000 | 0.000 |
| ABC | 228.3 | 27.34 | 5.411K | 6.243K |
| NEXT SCREEN | | NEXT METER | | CKT TYPE |
| | | | | EXIT |

Step 2 Press the **CKT TYPE** SOFTKey to verify the “Circuit Type” screen which displays the currently selected circuit type. If desired, a different circuit type may be selected. Press the **EXIT** SOFTKey to return to the “Meter Mode” screen.

Step 3 Spend a minute, using the **NEXT SCREEN**, **NEXT METER**, etc., SOFTKeys to navigate through some of the various displays to get a sense of the different viewing formats which are available in Meter Mode (a detailed explanation of Meter Mode is included in Chapter 7 Reporting Tour). Press the **EXIT** SOFTKey to exit the “Meter Mode” and return to the “Scope Mode” screen.

This completes the Easy Start Guided Tour.

A Footnote on Powering OFF...

NOTE - It is a wise practice to routinely display the “Scope Mode” screen before powering OFF the PP4300. Powering OFF from other screens may nullify configuration changes thought to be implemented. In such cases, the **actual** configuration, on a subsequent power up, could differ from the **expected** configuration.

Chapter 6 Advanced Tour

The Advanced Tour covers the following topics:

- 6.1 Setup Menu**
- 6.1.2 Set Programmable Features Menu**
- 6.1.4 Memory Functions Menu**
- 6.1.5 Set Input Configurations Menu**

6.1 Setup Menu

6.1.1 Easy Start

In Chapter 5 Easy Start Tour, EASY START was the only setup option which was explored. However, the Setup Menu contains many other powerful and important options for configuring the Task 808.

Step 1 From the “Scope Mode” screen, press the **SETUP** SOFTKey.

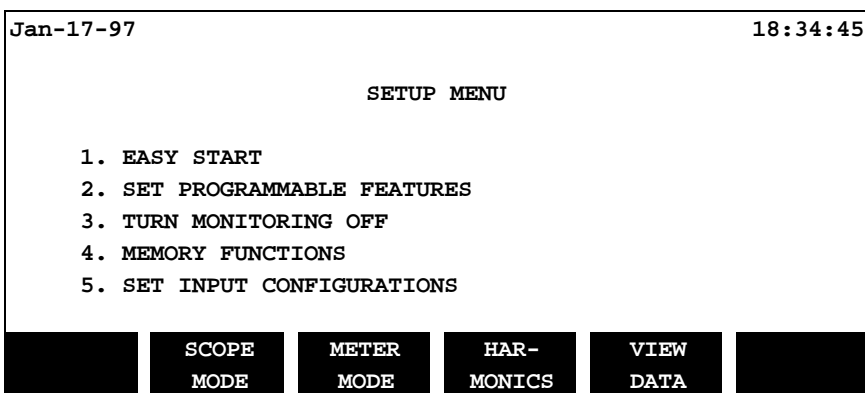

Step 2 Press the **2** key on the PP4300’s numeric keypad to display the “Programmable Features” menu.

6.1.2 Set Programmable Features

The following screen/menu will be displayed:

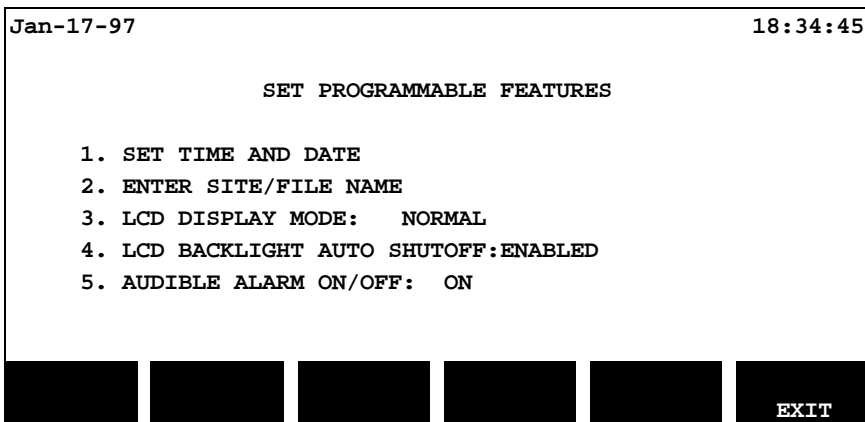

Step 3 Press the **1** key on the numeric keypad to set time and date:

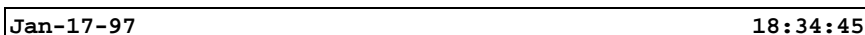

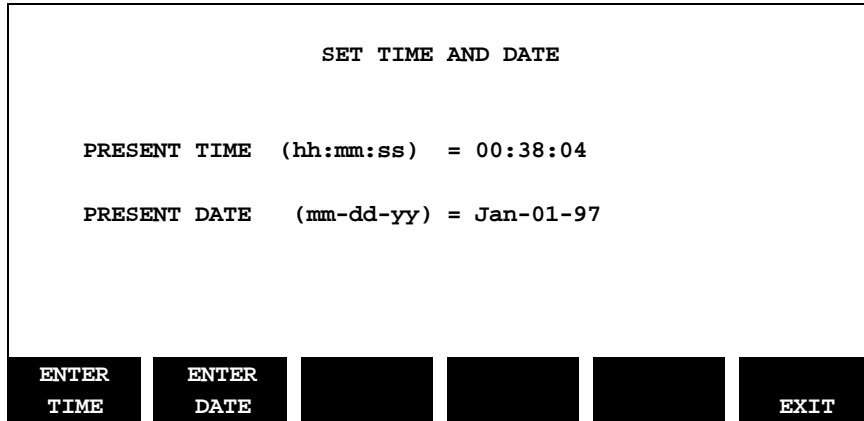

To change the time, press the **ENTER TIME** SOFTKey; Note that the SOFTKey options have changed to facilitate setting the time:



Use the **ENTER** and **BACKSPACE** SOFTKeys, along with the numeric keypad, to set the correct time and date.

NOTE - It is important that the time (24 hour format) and date is set correctly because they are used by the system to identify event data. If changing the time and data becomes necessary, you may wish to clear event memory as well, since any previously recorded events will have an incorrect time and date.

When finished, press the **EXIT** SOFTKey to return to the “Programmable Features” menu.

Step 4 Option 2 ENTER SITE/FILE NAME was reviewed previously during the Easy Start Guided Tour.

Press the **3** key on the numeric keypad to toggle the display mode from NORMAL (blue text and graphics on white background) to INVERTED (white text and graphics on a blue background). Exit and return to this menu to see the implemented result.

If Option 4 LCD BACKLIGHT AUTO-SHUTOFF is enabled, the screen will time out/dim after five minutes has elapsed without any keys being

TASK 808

pressed. Although pressing any key will restore the screen's brightness, the 0 (zero) key is recommended because it is the least likely to affect anything (unintended exit, changing screens, etc.). Auto-shutoff extends battery life and its use is recommended.

Option 5 AUDIBLE ALARM, when set to ON, the unit will sound a one-second beep for each event trigger and a 0.1 second beep for each error condition.

Press the **EXIT** SOFTKey again to return to the "Setup Menu" screen.

6.1.3 Turn Monitoring ON/OFF

Press the **3** key on the numeric keypad to toggle monitoring ON and OFF.

Step 5 Press the **4** key on the numeric keypad to display the "Memory Functions" screen.

6.1.4 Memory Functions

First, a word or two about memory...

Before exploring the memory functions, it is essential that users get a good conceptual understanding of the Task 808's data storage and memory management techniques. For this reason, the Advanced Guided Tour will take a brief *detour* at this point.

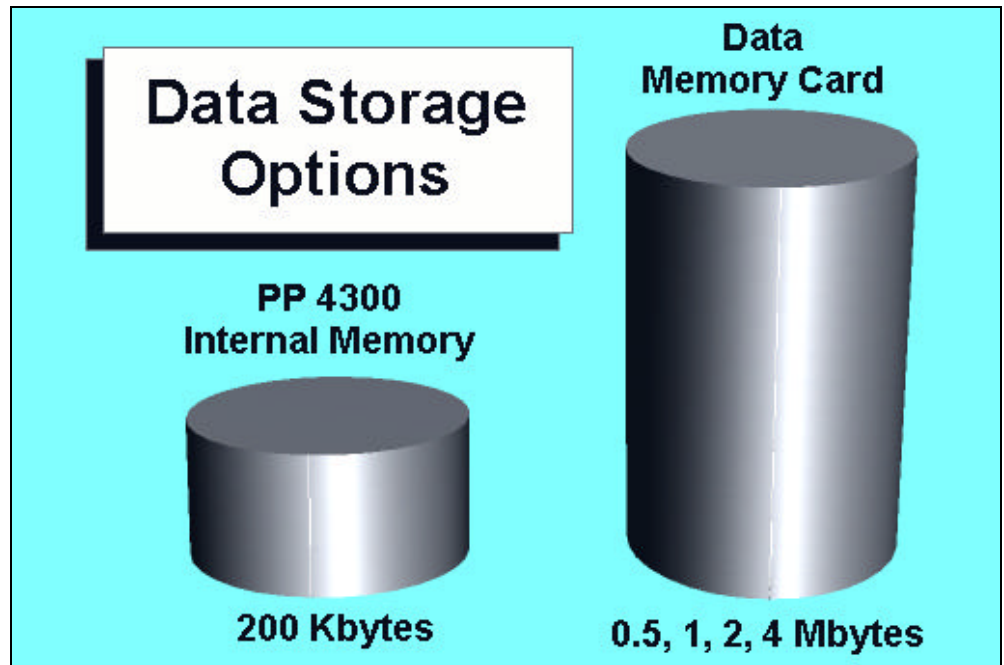

Data Storage

As shown above, the PP4300's memory (referred to as *internal memory*) can store a modest amount of data – about 200 Kbytes (although the actual memory capacity is 256 Kbytes, overhead cuts the useable data memory space to about 200 Kbytes).

Saving Data to Internal Memory

If the system is being operated *without* an optional memory card, configuration data and monitoring data is automatically saved to the PP4300's internal memory. There is no need to "save" the data in the sense that data must be saved on a PC. The PP4300 automatically writes data to the internal memory as it is accumulated.

Optional Memory Card

The optional memory card, however, can hold much more data than the internal memory. Although not an absolute requirement, a memory card is recommended for almost all applications. Various memory card capacities are available, see Appendix C.

Auto-transfer

As data is captured, it is always written directly to the PP4300's internal memory. If a memory card is included in the configuration, data can be automatically copied from internal memory to the memory card as the internal memory fills. This feature is called *Auto-transfer*.

Storage Techniques

When data is collected over extended periods of time, it may exceed the memory capacity of even the memory card. To address this limitation, data is always written to memory using one of the following user-specified techniques: either *Fill and Stop* or *Overwrite*.

Fill and Stop

This technique works just like it sounds: data is written to internal memory until it is full and then the data storage process shuts down. Using this technique, the oldest data is retained, the collection of data is stopped.

Overwrite

This technique also works just like it sounds: data is written to internal memory until it is full and then begins to overwrite, starting with the oldest data first. Using this technique, the most recent data is retained, the oldest data is overwritten.

The following table summarizes how these memory features work together under four different scenarios:

Memory Feature Table

| Memory mode? | Fill and Stop | | Overwrite | |
|--|--|---|---|--|
| Auto-transfer? | Enabled | Disabled | Enabled | Disabled |
| Memory card? | YES | N/A | YES | N/A |
| | Scenario #1 | Scenario #2 | Scenario #3 | Scenario #4 |
| R E S U L T | As PP4300's internal memory fills, data is copied to the memory card. When 200 Kbytes of data has been copied, copying stops, no new data is recorded. | PP4300's internal memory fills and stops. | As PP4300's internal memory fills, data is copied to the memory card. When the memory card is full, copying stops. Internal memory continues to be overwritten. NOTE - the memory card is <i>never</i> overwritten. | PP4300's internal memory fills and is overwritten. |

Now, back to the Advanced Guided Tour...

TASK 808

Memory Functions, Continued

The “Memory Functions” screen is the function control menu for both the internal memory and the optional memory card.

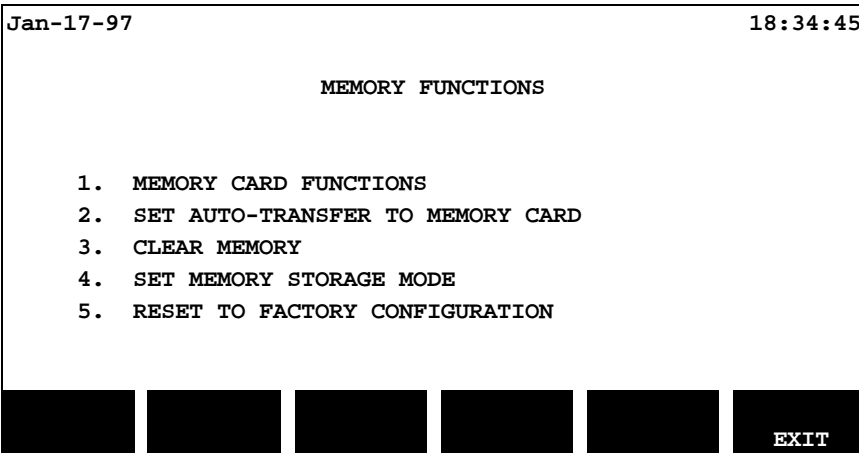

Step 6 Press the 1 key on the numeric keypad to display the **Memory Card Functions** screen. This screen displays the status of the memory card installed. Use this screen to read and write event and setup data on the memory card and to format the memory card (see Appendix F).

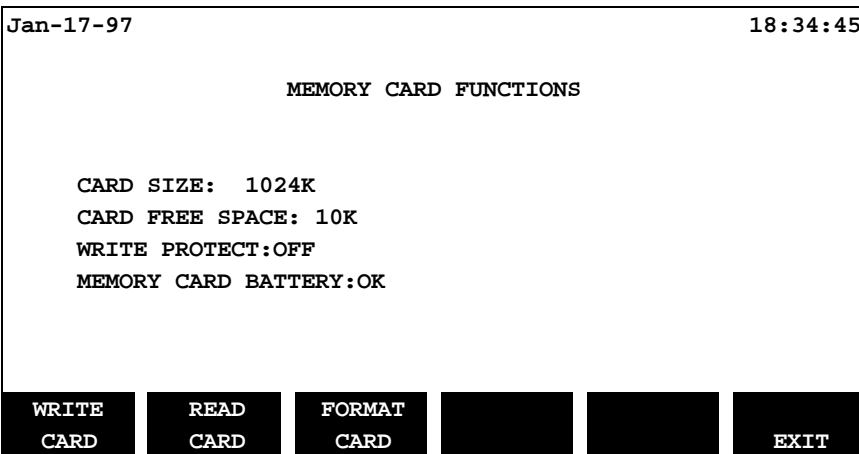

Use the View Data menu shown in Chapter 7 to read the Auto-transfer file.

- **NOTE:** In order to view data stored on a memory card, it must first be read (copied) into internal memory. Reading data from a memory card will erase all data presently in internal memory.

Saving/Reading Data

When data is saved manually to the memory card using the WRITE DATA SOFTKey, an event file (.evt) is created. This file consists of all data currently in internal memory. Using the WRITE SETUPS SOFTKey creates a setup file (.set), which contains the instrument configuration. When Auto-transfer is enabled, data is saved automatically to the memory card and is stored in an Auto-transfer file (.mdb). Event files and setup files are retrieved using the Memory Card Functions screen. Auto-transfer files are retrieved using the View Data screen.

File Sizes

Since the internal memory data storage capacity is 200 Kbytes, files written to memory cards manually will always be 200 Kbyte files (even though the actual amount of data may be less). On the other hand, the size of files created using the Auto-transfer function is limited only by the size of the memory card and typically would be much larger than 200 Kbytes. A procedure has been developed for reading files which were written to the memory card by auto-transfer and which may be several times larger than the 200 Kbyte internal memory. In such cases, only 200 Kbytes can be read into internal memory at a time. Therefore, data is copied from the memory card to internal memory in 200 Kbyte blocks. The user is prompted to enter a start date and time. This becomes the starting point from which the 200 Kbyte block of event data is selected.

Press the **EXIT** SOFTKey to return to the “Memory Functions” screen.

Step 7 Press the **2** key on the numeric keypad to toggle between Auto-transfer *enabled*, Auto-transfer *disabled*. As could be seen from the Memory Features Table (shown earlier), when a memory card is in use, it is usually wise to enable auto-transfer (scenario #3).

NOTE - If the PP4300 is powered ON with a new or freshly formatted memory card installed, and with Auto-transfer enabled, it will appear that much less storage space is available than would be expected. This phenomenon occurs because auto-transfer automatically allocates space. Thus, for example, a two Mbyte card will show only 48K of free space. The actual amount of stored data is shown on the View Data/ “Site Status” screen.

TASK 808

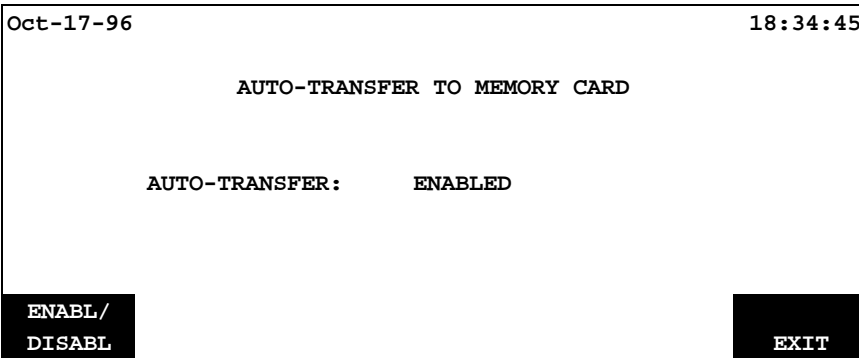

Press the **EXIT** SOFTKey to return to the “Memory Functions” screen.

Step 8 Press the **3** key on the numeric keypad to clear all events stored in the PP4300’s internal memory.

NOTE - Perform this operation *ONLY* if there is no valuable information in internal memory.

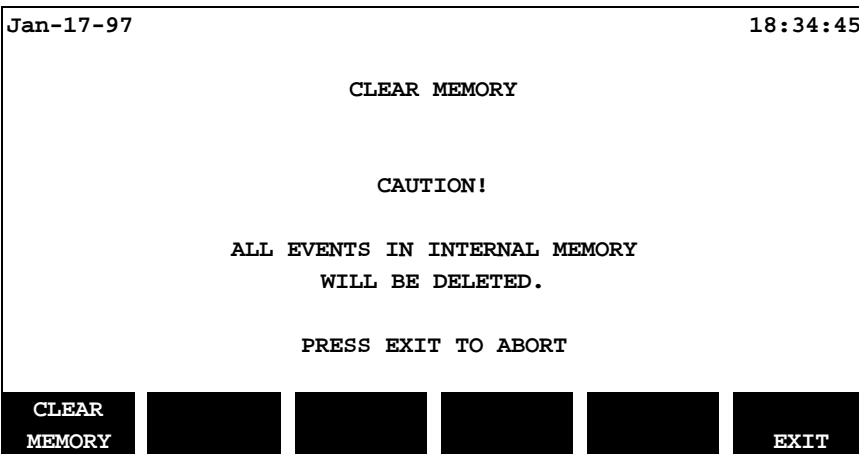

Press the **EXIT** SOFTKey to return to the “Memory Functions” screen without actually clearing any memory.

Step 9 Press the **4** key on the numeric keypad to toggle between *Fill and Stop* and *Overwrite* using the **NEXT MODE** SOFTKey.

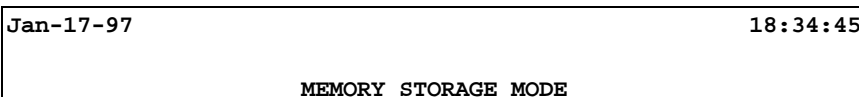

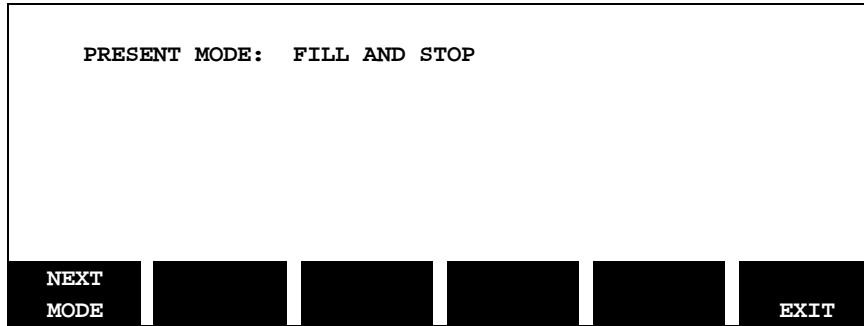

Press the **EXIT** SOFTKey to return to the “Memory Functions” screen.

Step 10 Press the **5** key on the numeric keypad to reset parameter values to the factory configuration, i.e., default settings.

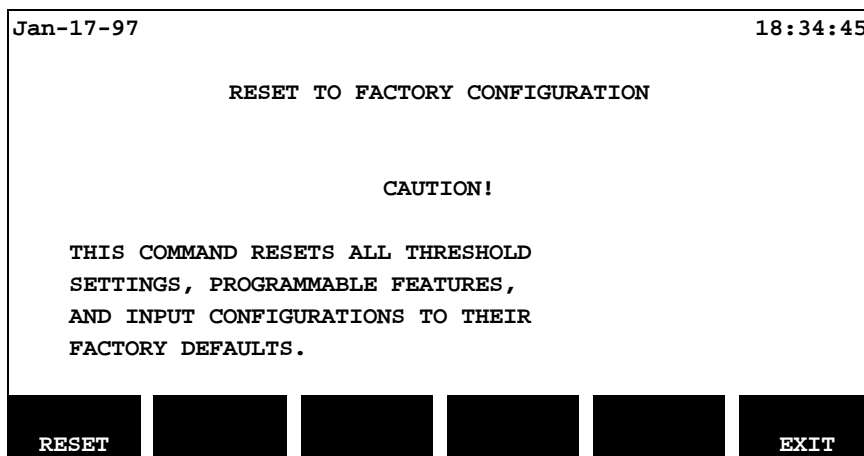

Press the **EXIT** SOFTKey to return to the “Memory Functions” screen (without actually resetting to factory configuration).

■ Refer to Appendix D *PP4300 Technical Specifications for a complete listing of factory default settings.*

Exit from the “Memory Functions” screen and return to the “Setup Menu” screen by pressing the **EXIT** SOFTKey.

6.1.5 Set Input Configurations

From the “Setup Menu” screen, press the **5** key on the numeric keypad to display the “Set Input Configurations” screen.

Several very important parameters are available from the “Set Input Configurations” screen:

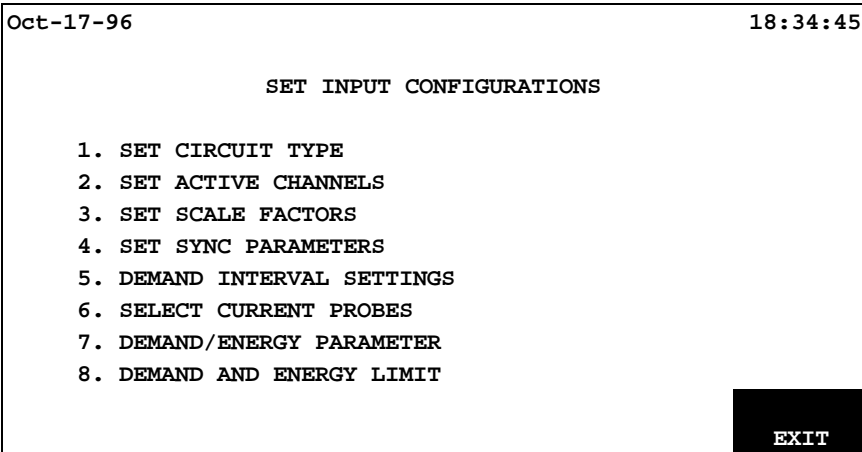
TASK 808

Step 1 Press the **1** key on the numeric keypad to set the circuit type. This screen was previously reviewed in the Easy Start Guided Tour. Exit by pressing the **EXIT** SOFTKey.

Step 2 Press the **2** key on the numeric keypad to display the “Active Channels” screen.

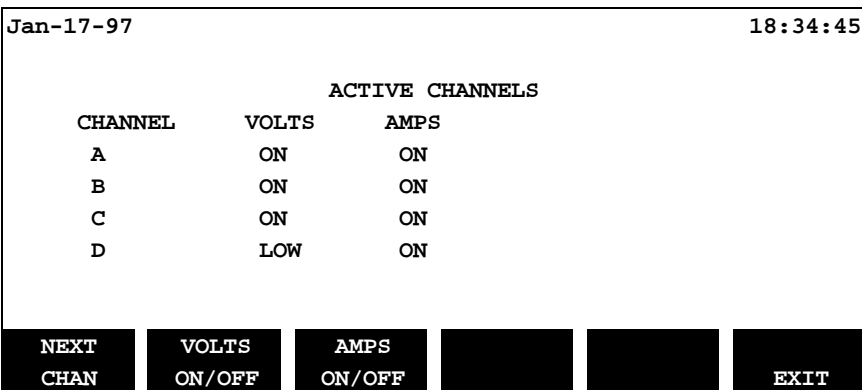

This screen is used to toggle ON or OFF the status of channels A, B and C. *In addition* – if you highlight and toggle channel D, you will notice that there are *three* voltage options for channel D: LOW, HIGH and OFF. The LOW voltage range is from 0.5 to 20.0 Vrms, and is available for channel D hookups, e.g., ground-to-neutral, which may require a much lower range. The HIGH voltage range is the same as ON, i.e., from 10 to 600 Vrms. The “Scale Factors” screen (shown below) displays the actual channel D status setting.

NOTE - The “Active Channels” screen controls the channels which are actively collecting data. A very similar screen, the “Channel Selection” screen, was reviewed in the Easy Start Guided Tour. But that screen, however, only filters the data for display on the “Scope Mode” graph. Unlike the options on the “Active Channels” screen, the “Channel Selection” screen has no control over the collection of data.

Exit by pressing the **EXIT** SOFTKey.

Step 3 Press the **3** key on the numeric keypad to set the voltage and amperage scale factors for each channel.

| | | | |
|---------------|----------------|----------|------|
| Jan-17-97 | | 18:34:45 | |
| SCALE FACTORS | | | |
| CHAN | VOLTS | AMPS | |
| A | 1.0000 | 1.0000 | |
| B | 1.0000 | 1.0000 | |
| C | 1.0000 | 1.0000 | |
| LOW D | 1.0000 | 1.0000 | |
| NEXT CHAN | ENTER SCALE | | EXIT |

The scale factor for all of the listed optional Dranetz-BMI current probes is automatically factored in behind the scenes and should be entered as 1.0 (unless changed on the secondary of another current transformer). However, The scale factors of any non-Dranetz-BMI current or voltage transformer must be accounted for in making accurate measurements. Because the monitored output current or voltage is frequently stepped down (divided) from the original current or voltage, this ratio must be stepped up (multiplied) by the scale factor when computations are performed.

The scale factor is usually marked on the transformer. This value must be entered into the “Set Scale Factors” screen. Refer to the device or the manufacturer’s literature for the scale factor for devices which you may be using.

TASK 808

Scale Factor Calculation - Example

Suppose the 5A secondary output current of a 5000A current transformer is being monitored. The scale factor would be calculated as follows:

$$\frac{\text{CT Full Scale Input} \times \text{Dranetz-BMI Probe Scale Factor}}{\text{CT Full Scale Output}} = \text{Scale Factor}$$

$$\frac{5000}{5} \times 1 = \text{Scale Factor of 1000}$$

Exit the “Scale Factors” screen by pressing the **EXIT** SOFTKey.

Step 4 Press the 4 key on the numeric pad to set the sync (synchronization) parameters. Sync, i.e., maintaining a constant phase relationship between AC signals, may be either external or internal. When set to external, the PP4300 attempts to sync to an incoming voltage signal. When set to internal, the PP4300 uses the nominal frequency when making measurements. External sync is recommended unless no adequate voltage source is available.

Enter a nominal frequency which matches the line frequency so that if the PP4300 loses external sync, it will have a corresponding internal sync. Failure to set this value correctly can result in erroneous data.

```
Jan-17-97 18:34:45
          SYNC PARAMETERS
          SYNC MODE:      EXTERNAL
          NOMINAL FREQUENCY: 60.0
          SELECT SYNC   ENTER   [ ]   [ ]   [ ]   [ ]
          SYNC         FREQ   [ ]   [ ]   [ ]   EXIT
```

Press the **SELECT SYNC** SOFTKey to toggle through the sync mode options. Press the **ENTER FREQ** SOFTKey to enter the frequency (using the numeric keypad). Exit by pressing the **EXIT** SOFTKey.

Step 5 Press the **5** key on the numeric keypad to set the interval, start time and date for the collection of demand data.

```
Jan-17-97 18:34:45
          DEMAND INTERVAL SETTING
          PRESENT INTERVAL: 15 MINUTES
          START TIME:      02:02:13
          START DATE:     Jan-11-96
          START OF NEXT INTERVAL: 18:47:13
          NOTE: DATA WILL FILL A CLEARED MEMORY
          BUFFER IN 6 DAYS ASSUMING NO OTHER
          EVENTS OCCUR.
          SET INTRVL   [ ]   [ ]   [ ]   [ ]   [ ]   [ ]
          INTRVL       [ ]   [ ]   START NOW   START AT   EXIT
```

Press the **SET INTRVL** SOFTKey to change the interval start time and date (watch the screen carefully when selecting this – especially the SOFTKeys -- note that **ENTER** and **BACKSPACE** SOFTKeys become operational).

This screen is especially significant because it calculates how long it will take to fill the internal memory excluding events other than timed demand interval events.

TASK 808

When finished, press the **START NOW** SOFTKey to start collecting immediately, or use the **START AT** SOFTKey to enter a different (and future) start time and date. When finished, the “Set Input Configuration” screen will be displayed.

Step 6 Press the **6** key on the numeric keypad to select current probes (this function was already reviewed in the Easy Start Guided Tour). After making selection, exit by pressing the **EXIT** SOFTKey.

Step 7 Press the **7** key on the numeric keypad to set the demand/energy parameter.

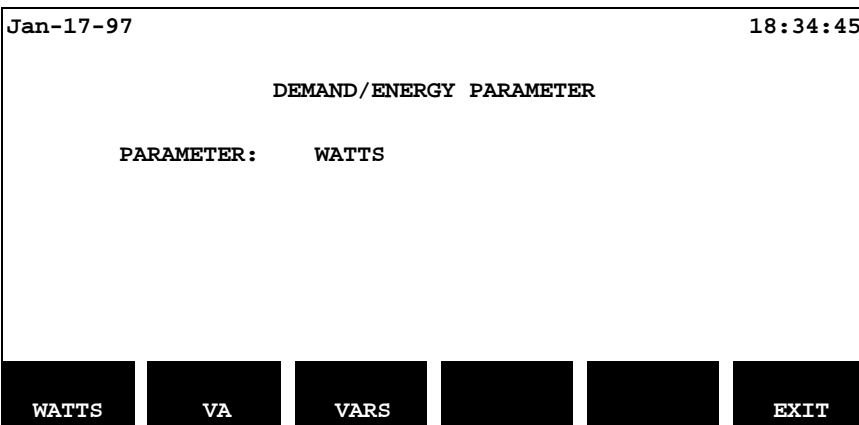

Press the **WATTS**, **VA** or **VARS** SOFTKeys to set the demand/energy parameter. Exit by pressing the **EXIT** SOFTKey.

Step 8 Press the **8** key on the numeric keypad to enable and set demand and energy limits:

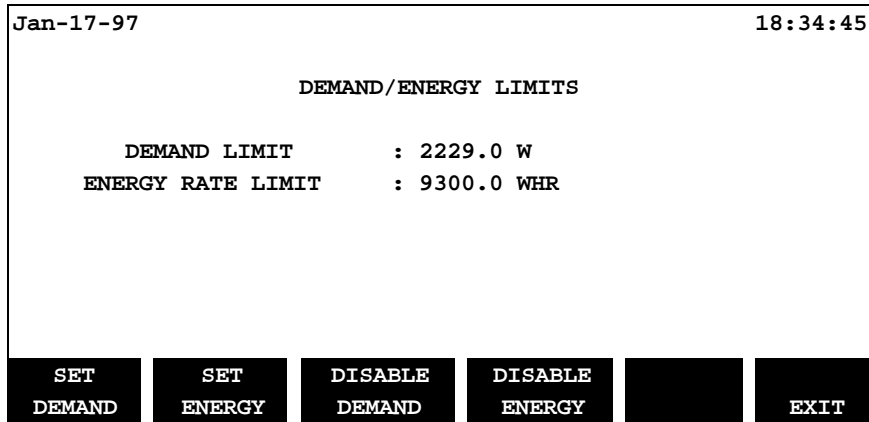

Use the SOFTKeys to **SET**, **ENABLE** or **DISABLE** the limits. The consequences of enabling and setting these limits are as follows:

Demand limit - At the end of each demand interval, the average demand is compared with this limit. If the demand is greater than this limit, it is treated as an event and is recorded.

Energy Rate Limit - The energy rate is computed once every minute. If the rate exceeds this limit, it is treated as an event and is recorded.

Exit by pressing the **EXIT** SOFTKey.

Exit from the "Set Input Configurations" screen by pressing the **EXIT** SOFTKey.

Exit from the "Setup Menu" screen and return to the "Scope Mode" screen by pressing the **SCOPE MODE** SOFTKey.

This completes the Advanced Guided Tour.

Chapter 7 Reporting Tour

The Reporting Tour covers the following topics:

7.1 View Data

7.2 Meter Mode

7.3 Viewing Harmonics (model 808/H-M only)

7.4 Screen Printing

7.1 View Data

The “View Data” menu provides access to graphic displays, reports and the Auto-transfer files.

From the “Scope Mode” screen, press the **VIEW DATA** SOFTKey:

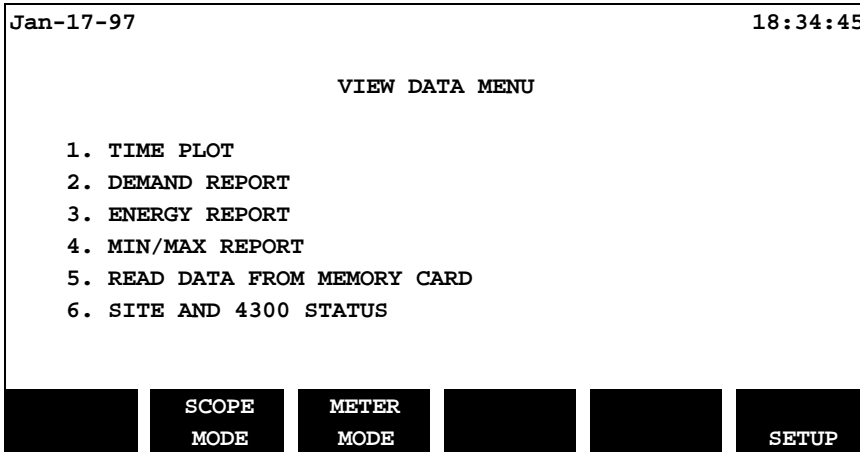

Step 1 From the “View Data” screen, press the **1** key to display the first of the Time Plot graphs.

Definition

A time plot is a graph of a single parameter value, for a single channel, over time. The curve consists of timed events and is redrawn every ten seconds.

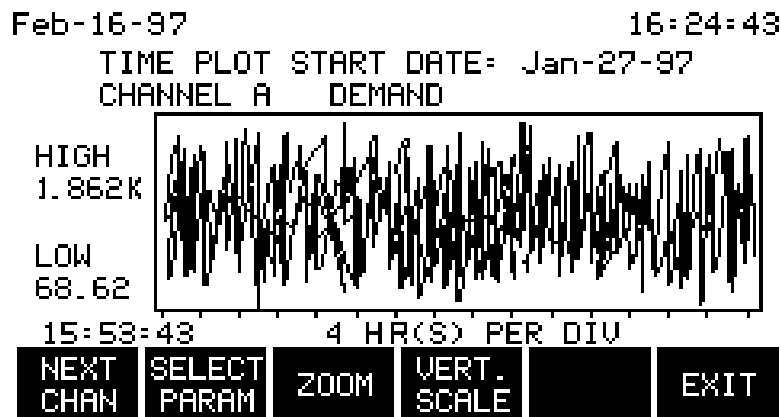

Even though a time plot may cover an extended period of time, it is possible to analyze the data in great detail.

NOTE - START DATE is displayed across the top of the "Time Plot" screen. This is the date on which the time plot data collection started.

Step 2 Select the channel and parameter to be analyzed: Press the **NEXT CHAN** SOFTKey to page through the channels. Press the **SELECT PARAM** SOFTKey to change parameters, by highlighting and selecting the desired parameter from a list.

Step 3 Press the **ZOOM** SOFTKey to begin the analysis.

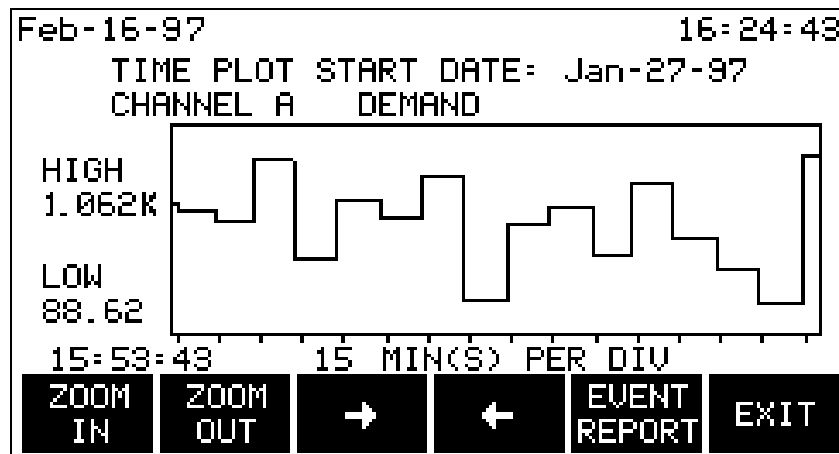

Select an Area of Interest

Use the arrow SOFTKeys to move right and left side brackets inward from the edge of the screen toward the area of interest, until it is bracketed on either side. Then press the **ZOOM IN** SOFTKey. Repeat this process, if necessary, until the exact area of interest has been selected.

Then press the **EVENT REPORT** SOFTKey to display a listing of events, including the date, time and event description for each:

Jan-17-97 18:34:45

TASK 808

| EVENT REPORT | | |
|---------------|--------------|-------------------------|
| DATE | TIME | DESCRIPTION |
| 01-13 | 10:23 | Dmd Int-1.800KW PF 0.86 |
| 01-13 | 10:31 | Dmd Int-1.801KW PF 0.86 |
| 01-13 | 10:39 | MONITOR OFF |
| 01-13 | 10:43 | MONITOR ON |
| 01-13 | 10:44 | Dmd Int-1.790KW PF 0.86 |
| 01-13 | 10:51 | Dmd Int-1.802KW PF 0.86 |
| 01-13 | 10:59 | DATABASE FULL |
| 01-13 | 10:07 | Dmd Int-1.806KW PF 0.86 |
| NEXT EVENT | PAGE DOWN | PAGE UP |
| | | DETAIL |
| | | EXIT |

Seven new Task 808-specific event types have been created:

| Event Report Abbreviation | Full Description |
|---------------------------|--|
| DEMAND CONFIG | demand interval setting and parameter change |
| THRESH CONFIG | energy/demand user-defined threshold change |
| PROBE CONFIG | current probe change |
| Dmd Int | demand interval change |
| Dmd Lim | demand threshold crossing |
| Energy Rate Lmt | energy rate threshold crossing |
| MIDNIGHT SUMMARY | midnight summary |

In addition, each time data in the internal memory is overwritten, an event named "Database Full" is added to the event list.

Step 4 Using the **PAGE DOWN**, **PAGE UP** and **NEXT EVENT** SOFTKeys, locate and highlight the specific event of interest. Then press the **DETAIL** SOFTKey. The "Demand Interval Report" screen will be displayed:

| | | | | | | |
|---|---------------|---------------|--------|--------|------|----------|
| Jan-17-97 | | | | | | 18:34:45 |
| DEMAND INTERVAL REPORT (DEMAND INTERVAL EVENT) | | | | | | |
| EVENT DATE AND TIME :Jan-14-97 20:05:37 | | | | | | |
| DEMAND : | 1.806KW | | | | | |
| INTERVAL ENERGY : | 376.6 W-HR | | | | | |
| DAILY ENERGY : | 15.23K W-HR | | | | | |
| MONTHLY ENERGY : | 47.80K W-HR | | | | | |
| PF : | 0.86 | | | | | |
| | DAILY PEAK | MONTH PEAK | STATUS | ENERGY | EXIT | |

The “Demand Interval Report” screen also provides a gateway to four additional screens, as illustrated below.

Daily Peak/Monthly Peak Reports

These reports have the same format: The Daily Peak contains the four highest peak readings for the day; the Monthly Peak report contains the four highest peak readings for the month.

| | | | | | | |
|---|--------|---------------|--------|--------|------|----------|
| Jan-17-97 | | | | | | 18:34:45 |
| CHANNEL ABC PEAK DEMAND REPORT (DEMAND INTERVAL EVENT) | | | | | | |
| DAILY PEAK DEMAND: Jan-17-97 | | | | | | |
| TIME | W | PF | | | | |
| 14:06 | 41.46K | 1.000 | | | | |
| 13:36 | 41.35K | 1.000 | | | | |
| 13:21 | 41.29K | 1.000 | | | | |
| 10:02 | 41.22K | 1.000 | | | | |
| INTRVL DATA | | MONTH PEAK | STATUS | ENERGY | EXIT | |

Status

The status report format is the same as that of the Meter Mode # 1 report, except that it does not dynamically update. It is a snapshot taken at the time of the event.

Energy

This report provides a snapshot of the energy data for the demand interval event selected.

| | | | | | | |
|---------------------------|--|--|--|--|--|----------|
| Jan-17-97 | | | | | | 18:34:45 |
| CHANNEL ABC ENERGY REPORT | | | | | | |

TASK 808

```
(DEMAND INTERVAL EVENT)

ENERGY RATE:          687.2  W-MN
DAILY:      Jan-13-97  99.29K W-HR
MONTHLY:    Jan-97    99.29K W-HR
DAYS INTO BILLING PERIOD:  23
```

| | | | | | |
|--------|-------|-------|--------|--|------|
| INTRVL | DAILY | MONTH | STATUS | | EXIT |
| DATA | PEAK | PEAK | | | |

Press the **EXIT** SOFTKey *four* times to return to the “View Data” menu.

Step 5 Press the **2** key on the numeric keypad to display the demand report. The content of this report is determined by parameters previously set using options from the “Set Input Configurations” screen.

```
Oct-17-96 18:34:45

CHANNEL ABC PEAK DEMAND REPORT

PRESENT INTERVAL DATA

PRESENT DEMAND:  41.45K  W
PROJECTED DEMAND: 41.40K  W

10 MINUTES INTO 15 MINUTE INTERVAL
```

| | | | | | |
|--|-------|-------|-------|--|------|
| | DAILY | MONTH | EVENT | | EXIT |
| | PEAK | PEAK | DATA | | |

Press **EXIT** to return to the “View Data” menu.

Step 6 Press the **3** key on the numeric pad to display the “Energy” report. A format similar to one shown earlier will be displayed. However, this report is a summary report and is dynamically updated.

```

Jan-17-97                                     18:34:45

                                CHANNEL ABC ENERGY REPORT

ENERGY RATE:                               687.2 W-MN
DAILY:      Jan-13-97                       99.29K W-HR
MONTHLY:    Jan-97                           99.29K W-HR
DAYS INTO BILLING PERIOD:                    23

EVENT
DATA
EXIT
  
```

Press the **EVENT DATA** SOFTKey to display the following menu:

```

Jan-17-97                                     18:34:45

                                EVENT DATA MENU

1. DEMAND INTERVALS
2. LIMIT CROSSINGS
3. MIDNIGHT SUMMARY
4. ALL EVENTS

EXIT
  
```

Display the “Demand Interval” (Event) report by pressing the **1** key on the numeric keypad. This report filters out all events except demand interval events. Press EXIT to return to the “Event Data Menu” screen

Detail (Daily Peak, Monthly peak , Status and Energy) is available for the selected event. Press EXIT to return to the “Event Data Menu” screen

Press the **2** key on the numeric keypad to display another filtered version – the “Limit Crossings” screen (Demand Limit and Energy Rate Limit), if any crossings exist.

Step 7 Press the **3** key on the numeric keypad to display a listing of the “Midnight Summary” reports available.

TASK 808

NOTE - The “Midnight Summary” reports are created automatically each night but displayed only on request.

| | | | | | |
|---------------|--------------|------------------|--------|--|------|
| Jan-17-97 | | 18:34:45 | | | |
| EVENT REPORT | | | | | |
| DATE | TIME | DESCRIPTION | | | |
| 01-13 | 00:00 | MIDNIGHT SUMMARY | | | |
| 01-14 | 00:00 | MIDNIGHT SUMMARY | | | |
| 01-15 | 00:00 | MIDNIGHT SUMMARY | | | |
| 01-16 | 00:00 | MIDNIGHT SUMMARY | | | |
| NEXT EVENT | PAGE DOWN | PAGE UP | DETAIL | | EXIT |

Use the highlight bar to select a date – then press the **DETAIL** SOFTKey to display the Daily Peak Demand.

Press the **4** key on the numeric keypad to display ALL, i.e., the unfiltered event report (illustrated previously).

Step 8 Press the **EXIT** SOFTKey to return to the “View Data” menu. Press the **4** key on the numeric keypad to display the Min/Max report. This report displays daily, weekly and monthly Min/Max data by each channel and by nine parameters:

| | | | |
|-------------------------------|---------------|-------|----------|
| Jan-17-97 | | | 18:34:45 |
| MIN MAX REPORT FOR CHANNEL: A | | | |
| PERIOD | DATE | TIME | VOLTS |
| DAILY MIN. | Jan-17-97 | 10:25 | 100.0 |
| DAILY MAX. | Jan-17-97 | 18:00 | 118.0 |
| WEEKLY MIN. | Jan-10-97 | 20:25 | 86.66 |
| WEEKLY MAX. | Jan-13-97 | 14:04 | 119.9 |
| MONTHLY MIN. | Jan-10-97 | 20:25 | 86.66 |
| MONTHLY MAX. | Jan-13-97 | 14:04 | 119.9 |
| NEXT CHAN | NEXT PARAM | | EXIT |

NOTE - Week and month periods are calendar week (Sun-Sat) and month.

Reading the Auto-transfer file from the memory card

- Exit to the “View Data” menu.
- Insert the memory card containing the data to be read.
- Press the **5** key on the numeric keypad to display the Read Events From Memory Card screen:

| | | | |
|--|--|--|----------|
| Jan-17-97 | | | 18:34:45 |
| READ EVENTS FROM MEMORY CARD | | | |
| CAUTION! | | | |
| EVENTS PRESENTLY IN MEMORY WILL BE DELETED WHEN EVENTS FROM THE CARD ARE COPIED INTO MEMORY. | | | |
| PRESS EXIT TO CANCEL OR PRESS TRANSFER TO CONTINUE | | | |
| TRANS- FER | | | EXIT |

- Observe the caution. Press the TRANSFER SOFTKey. The “View Events by Date and Time” screen is displayed.
- Enter the starting date and time of the desired events to be transferred (not necessarily the default date and time, which is the oldest event date and time).

TASK 808

- ❑ To enter the date, Press the **START DATE** SOFTKey. Use the numeric keypad to enter the two digit month, then press the **ENTER** SOFTKey. Repeat this process for day, year, hour, minute, etc.
- ❑ Press the **READ EVENTS** SOFTKey to begin reading data.

NOTE - If the memory card contains more data than can fit into the internal memory, only as much data as possible will be transferred. After viewing the initial batch of data, note the date and time of the last event. Enter these values into the START DATE/TIME screen to read the remaining data.

Site and 4300 Status

Step 9 Press the **6** key on the numeric keypad to display the “Site Status” screen:

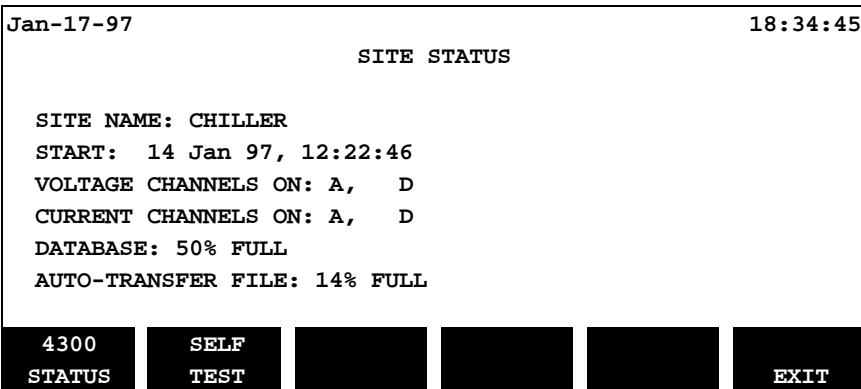

This screen also provides a gateway to two additional screens:

4300 STATUS

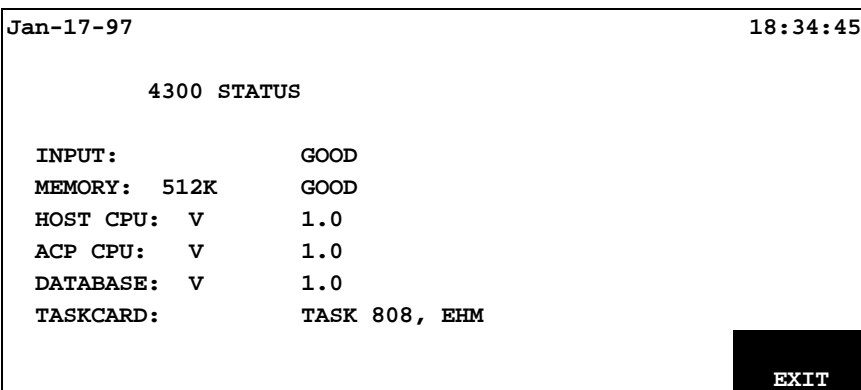

NOTE - "GOOD Input" means the current and voltage measurements are OK and within range limits. The memory test results are the results of the test performed during power ON and if the result is not GOOD, call Dranetz-BMI Customer Service.

V 1.0 is an abbreviation for Version 1.0.

EHM is an abbreviation for Energy/Harmonics/Memory.

Self Test

The self test performs a non-destructive test of the internal memory, although the test *will* interrupt data collection.

```
Jan-17-97                                     18:34:45
                                     RUN SELF TEST
                                     CAUTION!
LOSS OF DATA WILL RESULT IF THIS TEST
IS SELECTED DURING DATA ACQUISITION.
RUN TEST DURING NON-CRITICAL
MONITORING TIMES ONLY.

PRESS BEGIN TEST TO CONTINUE
PRESS EXIT TO ABORT
BEGIN TEST                                     EXIT
```

The reason behind this warning is that the Self Test turns monitoring OFF during the test, then turns it back ON when the test is finished (unless it was already OFF when the test was begun).

Press the **BEGIN TEST** SOFTKey to start the self test.

7.2 Meter Mode

The Meter Mode consists of four different “meters,” or formats, updating in real time. These meters present the monitored data across 35 different screens. Don’t let this number be intimidating, however, because paging through this array of information can be accomplished quickly and easily.

Navigation

Navigation through these various displays is performed using one or more of four navigation SOFTKeys:

- NEXT METER**
- NEXT SCREEN**
- NEXT CHAN**
- NEXT PARAM**

Meter Mode consists of the following screen configuration, in meter sequence, starting with meter #1:

Meter # 1 - This meter provides a spreadsheet display of values for all 11 parameters for all four channels plus ABC. Three screens are required to display values for all 11 parameters.

Use the **NEXT SCREEN** SOFTKey to page from screen to screen.

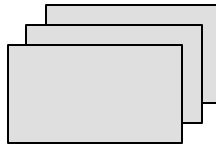

| Jan-17-97 | | | | | 18:34:45 | | | | |
|-------------|-------|------------|--------|----------|----------|------|--|--|--|
| METER MODE | | | | | | | | | |
| CHAN | VOLT | AMP | WATT | VA | | | | | |
| A | 117.4 | 0.743 | -5.927 | 87.26 | | | | | |
| B | 0.879 | 2.091 | 1.554 | 1.839 | | | | | |
| C | 1.001 | 2.000 | 1.765 | 2.003 | | | | | |
| D | 2.316 | 1.264 | 0.866 | 2.929 | | | | | |
| ABC | 117.4 | 0.743 | -5.927 | 87.26 | | | | | |
| NEXT SCREEN | | NEXT METER | | CKT TYPE | | EXIT | | | |

Meter # 2 - This meter emulates a digital volt meter (DVM), displaying all 11 parameter values for each of four channels plus ABC. Three screens each are required to display the values for the 4 channels plus ABC.

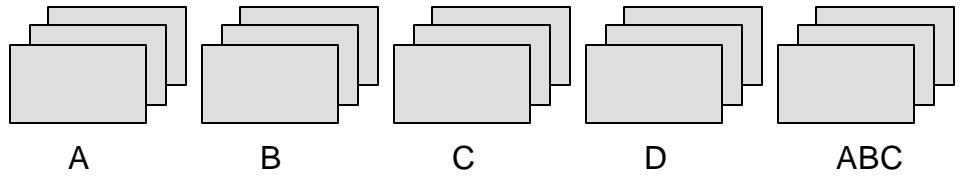

Use **NEXT CHAN** to change channels, **NEXT SCREEN** to page through parameters.

```
Jan-17-9718:34:45
      CHANNEL:  A
      114.5    V
      1.368    I
      143.6    KW
      156.7    KVA
NEXT  NEXT  NEXT  CKT
CHAN  SCREEN METER TYPE EXIT
```

TASK 808

Meter # 3 - This meter emulates a digital volt meter (DVM), displaying a single parameter value for four channels plus ABC. 11 screens are required to display the values for all of the parameters.

Use **NEXT PARAM** to page through the 11 parameters.

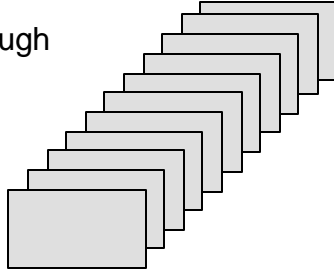

| | |
|-----------------------|-----------------------|
| Jan-17-97 | 18:34:45 |
| VOLTS | |
| A: | 114.5 |
| B: | 1.368 |
| C: | 143.6 |
| D: | 156.7 |
| ABC: | 115.8 |
| NEXT PARAM | PREV PARAM |
| NEXT METER | CKT TYPE |
| | EXIT |

Meter # 4 - This meter is a graphical phase meter displaying the phase angle for either a volts-only or amps-only phasor for *all* four channels. In addition, volts *and* amps phasors are available for *each* of the four channels.

NOTE - Channels with values below 10% of the maximum channel value will not be displayed.

Six screens are required to display the phasors.

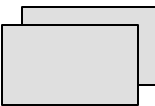
Use  **NEXT PARAM** to toggle between VOLTs and AMPs screens

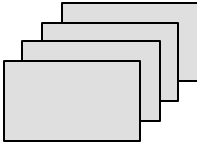
 Use **SINGLE CHAN** to switch to combined VOLTs and AMPs phasors, then use **NEXT CHAN** to page through channels

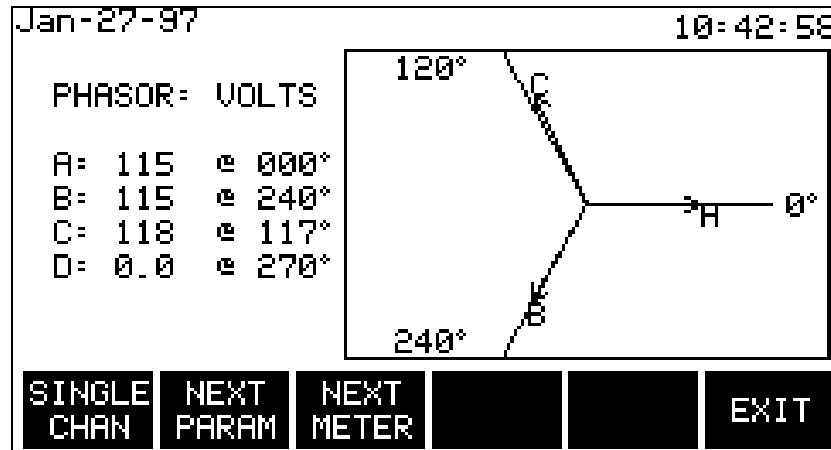

7.3 Viewing Harmonics

NOTE - The harmonics feature is only available on Task 808 model 808/H-M.

Step 1 Press the **HARMONICS** SOFTKey to view harmonics graphs and text screens:

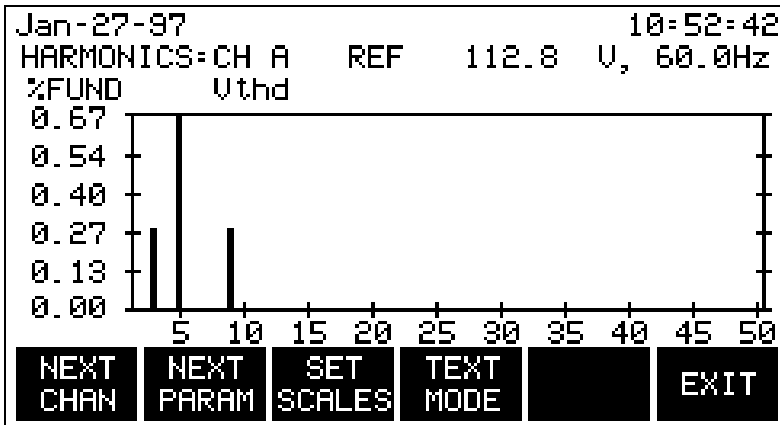

Step 2 Explore some options -- press the **NEXT CHAN** SOFTKey to advance through the channels. Press the **NEXT PARAM** SOFTKey to change parameters (by highlighting and selecting the desired parameter from a list).

Press the **SET SCALES** SOFTKey to toggle the vertical scale between % of fundamental (amount of fundamental frequency, e.g., 50Hz or 60Hz) and % of RMS.

Press the **TEXT MODE** SOFTKey to switch from a graphical to a text format display:

| Jan-17-97 | | | | | | | | 18:34:45 | |
|----------------|-------|------|----|--------------|-----|--------|-------|----------|--|
| HARMONICS:CH A | | | | REF 117.8 V, | | 60.0Hz | | | |
| % FUND | | Vthd | | | | | | | |
| H# | MAG% | PHS | H# | MAG% | PHS | H# | MAG% | PHS | |
| 02 | 0.038 | 094 | 09 | 0.038 | 074 | 16 | 0.019 | 115 | |
| 03 | 4.981 | 205 | 10 | 0.019 | 218 | 17 | 0.132 | 143 | |
| 04 | 0.094 | 186 | 11 | 0.338 | 020 | 18 | 0.019 | 269 | |
| 05 | 2.331 | 177 | 12 | 0.019 | 332 | 19 | 0.094 | 024 | |
| 06 | 0.019 | 138 | 13 | 0.169 | 339 | 20 | 0.019 | 341 | |
| 07 | 0.808 | 175 | 14 | 0.000 | 206 | 21 | 0.282 | 193 | |
| 08 | 0.019 | 044 | 15 | 0.188 | 279 | 22 | 0.019 | 088 | |

| | | | | | |
|------|-------|------|-------|--|------|
| NEXT | NEXT | NEXT | GRAPH | | |
| CHAN | PARAM | SET | MODE | | EXIT |

Mag% is the amplitude of the harmonic. PHS is the phase angle between the harmonic and fundamental of the channel displayed.

NOTE - The watts parameter version of this screen indicates harmonic power direction by the sign in front of the MAG% value. A minus sign (-) indicates that the harmonic power flows from the load to the source. No sign indicates that the harmonic power flows from the source to the load.

Step 3 There are three sets of harmonics. Press the **NEXT SET** SOFTKey to display additional sets of harmonics until the maximum of 50 harmonics is reached. Exit from the “Harmonics” menu and return to the “Scope Mode” screen by pressing the **EXIT** SOFTKey.

7.4 Screen Printing

The currently displayed screen may be printed (using the optional printer) by pressing the period key (.) on the numeric keypad.

This completes the Reports Guided Tour.

Appendix A Product support

Dranetz-BMI provides users with complete technical support.

A.1 Telephone Support

Technical Support and Customer Service is available toll-free, Monday through Friday during normal business hours (Eastern Time) by calling:

1-800-372-6832 or 732-287-3680

A.2 Fax Line

Customers may send fax inquiries to the Dranetz-BMI Customer Service Fax line at any time:

732-248-1834

A.3 World Wide Web

Customers may also check the Dranetz-BMI Web page for additional product and technical information:

<http://www.dranetz-bmi.com>

A.4 Technical support email address

dti.support@dranetz-bmi.com

Appendix B Maintenance/Service/Return Shipment

B.1 Maintenance/Service

No maintenance is required for the PP4300 other than internal battery replacement and calibration.

B.1.1 Internal Battery Pack Replacement

The internal battery pack used in the PP4300 functions as a power source and UPS. Replacement procedures follow the specifications and precautions below. See Appendix F for memory card battery replacement.

Battery Pack Specifications

Location: Battery compartment on the bottom of the unit.

Number of batteries in pack: 6

Type: Sealed, rechargeable NiCad cells

Voltage: 7.2 V dc

Capacity: 1.6 Ah

Length of operation: More than two hours when fully charged and properly maintained.

Suggested replacement interval: Two years.

Part Number: BP4300

NOTE - The length of time that the PP4300 can operate on the battery pack degrades over the life of the batteries and the number of charge/discharge cycles.

Memory backup

A storage capacitor on the CPU board is used for backup of the PP4300's data, configurations, and setup when the battery pack is removed. The capacitor's charge will maintain memory for two hours, meaning that if the battery pack is replaced within two hours, no data will be lost from the internal memory. The capacitor is not operator replaceable.

Battery Pack Safety Precautions

- **WARNING: DO NOT intentionally short circuit the battery pack. The batteries are capable of providing hazardous output currents if short circuited. The Power Platform is equipped with an internal battery charger circuit. Do not attempt to charge the batteries with an external charger other than the Dranetz-BMI battery charger, since improper charging could cause battery explosion.**
- **ADVERTENCIA: NO ponga intencionalmente la batería en cortocircuito. Las baterías son capaces de proporcionar corrientes de salida peligrosas si están en cortocircuito. La Power Platform está equipada con un circuito interno cargador de baterías. No intente cargar las baterías con un cargador externo que no sea el cargador de baterías Dranetz-BMI, puesto que la carga indebida podría hacer que explote la batería.**
- **AVERTISSEMENT: NE PAS court-circuiter délibérément le bloc-batterie. Lors d'un court-circuit, les batteries risquent d'émettre des courants effectifs dangereux. "Power Platform" possède un circuit de chargeur de batterie intégré. Ne pas tenter de charger les batteries au moyen d'un chargeur externe autre que le chargeur de batterie Dranetz-BMI, car un rechargement fautif pourrait entraîner l'explosion de la batterie.**
- **WARNUNG: Die Batterien dürfen NICHT kurzgeschlossen werden. Im Falle eines Kurzschlusses können die Batterien lebensgefährliche Ausgangsströme leiten. Power Platform ist mit einem internen Batterieladegerät ausgestattet. Die Batterien sollten nur mit dem Ladegerät von Dranetz-BMI geladen werden. Die Verwendung eines externen Ladegeräts kann zu einer Explosion der Batterien führen.**

Battery Safety Precautions

The following safety precautions must be adhered to.

- Keep batteries away from children. Never permit a child to play with a battery as an ornament or toy.
 - Do not disassemble battery or battery pack.
 - Do not dispose of battery in fire.
 - Dispose of a used battery promptly in accordance with local Environmental Protection Agency (EPA) regulations.
 - Visually inspect the battery pack for corrosion.
-

Medidas de seguridad de la batería

Deberán observarse las medidas de seguridad siguientes:

- No deberá mantenerse las baterías al alcance de los niños. No deberá permitirse que un niño juegue con una batería.
 - No deberá desensamblarse ninguna batería ni el compartimiento de la misma.
 - No deberá prenderse fuego a una batería.
 - Toda batería agotada deberá desecharse de manera rápida según las normas locales de la Agencia de protección del medio ambiente (EPA).
 - Deberá verificarse que el compartimiento de las baterías no esté corroído.
-

Mesures de sécurité relatives aux batteries

Il est très important de suivre les mesures de sécurité suivantes.

- Ne pas laisser les batteries à la portée des enfants. Ne jamais laisser un enfant jouer avec une batterie.
 - Ne pas démonter de batterie ou de bloc-batterie.
 - Ne pas jeter de batterie dans le feu.
 - Se débarrasser rapidement des batteries usagées en se conformant aux règlements de l'EPA (Agence américaine pour la protection de l'environnement).
 - Inspecter le bloc-batterie à l'oeil nu pour rechercher les signes de corrosion.
-

Batterie-Sicherheitsvorkehrungen

Die folgenden Sicherheitsvorkehrungen müssen beachtet werden.

TASK 808

- Halten Sie Batterien von Kindern fern. Erlauben Sie einem Kind unter keinen Umständen, eine Batterie als Verzierung oder Spielzeug zu benutzen.
 - Nehmen Sie Batterien oder Batteriepackungen nicht auseinander.
 - Entsorgen Sie Batterien nicht durch Verbrennen.
 - Entsorgen Sie verbrauchte Batterien umgehend nach den gesetzlichen Umweltschutzbestimmungen.
 - Prüfen Sie die Batteriepackung optisch auf Korrosion.
-

The batteries have a safety pressure vent to prevent excessive gas build-up. Corrosion indicates that venting has occurred. Possible causes of venting are: a defective charger, excessive temperature, excessive discharge rate, or a defective cell.

If corrosion is excessive, the battery pack may require replacement. Contact Dranetz-BMI Customer Service Department.

Battery Pack Replacement

The PP4300 contains an easily replaceable internal battery pack.

■ *Refer to Appendix D for ordering information.*

- **WARNING: Replace with Dranetz-BMI NiCad battery pack BP4300 only.**
- **ADVERTENCIA: Reemplace con batería Dranetz-BMI NiCad BP4300 solamente.**
- **AVERTISSEMENT: Remplacer par la batterie Dranetz-BMI NiCad BP4300 exclusivement.**
- **WARNUNG: Nur mit Dranetz-BMI NiCad BP4300 Batteriesatz auswechseln.**

NOTE - During normal operation, the battery pack will be slightly warm to the touch.

Procedure

Follow these steps to replace the battery pack.

| Step | Action |
|------|---|
| 1 | Turn OFF power to the circuit being measured. |
| 2 | Press the PP4300 power key to OFF. |
| 3 | Disconnect voltage and current probes from the circuit and the PP4300's rear panel. |
| 4 | On the bottom of the PP4300, push the tab to release the battery cover. |
| 5 | Remove the cover. |
| 6 | Pull up on removal strap and remove battery pack. |
| 7 | Insert the new pack into the compartment making sure to observe polarity markings. |
| 8 | Replace the cover and press down until it latches closed. |
| 9 | If discarding the old battery pack, do so in accordance with Environmental Protection Agency (EPA) regulations. |
| 10 | Press the PP4300 power key to on. |

B.1.2 Calibration

The recommended calibration interval for the PP4300 is once every 12 months.

■ *Refer to Return Shipment section below for instructions.*

B.3 Return Shipment

Notify Dranetz-BMI Customer Service of your intention to return any product for any reason, including calibration. Do not return the unit, for any reason, without prior approval and instructions from Dranetz-BMI.

To return the PP4300 to Dranetz-BMI for calibration, first contact Dranetz-BMI Customer Service department for a Return Material Authorization (RMA) number.

Telephone: **1-800-372-6832 or 732-287-3680**
 Fax: **732-248-1834**

TASK 808

Insert correspondence with instructions and RMA reference number inside the package.

If the unit is returned to Dranetz-BMI for service or repair, wrap the unit securely in heavy packing material and place in a well padded box or crate to prevent shipping damage. If possible, return the unit in its original packing carton or container.

Dranetz-BMI will not be responsible for damage incurred during transit due to inadequate packing by customer.

B.3.1 Shipping Address

Ship packages to:

**Customer Service Department
Dranetz-BMI
1000 New Durham Road
Edison, NJ 08818**

Appendix C Optional Accessories

C.1 Introduction

This appendix lists the optional accessories that are available for the PP4300. Descriptions for some of the accessories follow the list.

C.2 Optional Accessories List

| Accessory | Part Number |
|---|-------------------------|
| Adapter Cable, 658 Current Probe to PP4300 | CA4300 |
| Battery Pack (7.2V at 1.6A) | BP4300 |
| Current Probe, 1 to 500 A | TR2500 |
| Current Probe, 1 to 30 A | TR2021 |
| Current Probe, 1 to 300 A | TR2019B |
| Current Probe, 10 to 1000 A | TR2022 |
| Current Probe, 10 to 3000 A | TR2023 |
| Current Probe, 0.1 to 10 A | TR2510 |
| Current Probe, 10 to 3000 A | TR2520 |
| DRAN-VIEW Windows PC Software | 4300EA 4300EA driver |
| External Battery Charger | XBC4300 |
| Field Handbook for Electrical Energy Management | HB114415 |
| Field Handbook for Power Quality Analysis | HB114414 |
| Isolated Communications Module | PP4300RS232 |
| Isolated Current Transformer | ISO-65X-5 |
| Lockable Portable Case | LPC4300 |
| Memory Card, 512k | CARD-512 |
| Memory Card, 1M | CARD-1M |
| Memory Card, 2M | CARD-2M |
| Memory Card, 4M | CARD-4M |
| Memory Card Reader, Data Bus Plug-in | |
| Memory Card Reader, Parallel Port | |
| Memory Card Reader, Parallel Port, 230 V | |
| Memory Card Reader, Serial Port | |
| Memory Card Reader, Serial Port, 230 V | |
| Portable Field Printer | PFP4300 |

TASK 808

| | |
|--|---------------------|
| Reusable Shipping Container | RSC4300 |
| Soft Carrying Case | SCC4300 |
| TASKCard 808/M | Task-808M |
| TASKCard 808/H-M | Task-808H/M |
| TASKCard-PQLite | TASK-PQLITE |
| TASKCard-PQLite w/Harmonics | TASK-PQLITE/H |
| TASKCard-PQLite w/Harmonics & Memory Card Functions | TASK-PQLITE/H/M |
| TASKCard-PQLite w/Harmonics & Transient Capture | TASK-PQLITE/H/T |
| TASKCard-PQLite w/Harmonics, Transient Capture, & Memory Card Functions | TASK-PQLITE/H/T/M |
| TASKCard-PQLite w/Harmonics, Transient Capture, Memory Card & Energy Functions | TASK-PQLITE/H/T/M/E |
| Voltage Cable Accessory Pack | VCP4300 |

C.2.1 Optional Accessories Descriptions**Adapter cable, 658 current probes to PP4300**

This cable allows connection of current probes made for the Dranetz-BMI Model 658 to the PP4300 current input jacks.

Battery Pack

The internal battery pack, containing six sealed, rechargeable NiCad batteries, is used as the PP4300's primary power source and UPS. These batteries have a length of operation of more than two hours when fully charged and properly maintained.

Current probes

There are seven Dranetz-BMI current probes which can be used with the PP4300: models TR2500, TR2510, TR2520, TR2021, TR2019B, TR2022, TR2023.

TR2500, TR2510, TR2520: These models will measure rms currents from 1 to 500 A, 0.1 to 10 A, 10 to 3000 A, respectively, and plug directly into any of the current inputs on the rear panel.

TR2021, TR2019B, TR2022, TR2023: These four probes were initially made for the Dranetz-BMI model 658 but can be used with the PP4300 by using an adapter cable (part number 116002-G1). They can measure rms currents in the ranges of 0 to 30 A, 1 to 300 A, 10 to 1000 A, and 10 to 3000 A, respectively.

TASK 808

Memory cards

Memory cards are available in 512K, 1Mb, 2Mb and 4Mb capacities, and are recommended for most applications.

External Battery Charger

This device charges a battery pack while the PP4300 is in use.

Field Handbook for Electrical Energy Management

This reference handbook provides a comprehensive guide for information related to conducting a thorough energy audit, power distribution analysis, and methods of remedying inefficiencies of energy management.

Field Handbook for Power Quality Analysis

This handbook is divided into six sections containing step-by-step instructions for discovering and solving complex power quality problems. Example waveforms and case studies are included.

Isolated Communications Module

The communications module is an optically isolated device using infrared light to transfer text and graphics to a PC or printer. The communications module is designed to connect the Dranetz-BMI PP4300 optical serial port to a standard RS232 serial port. This interface can be connected to an Epson graphics-compatible printer for printing screens, or to a PC running DRAN-LINK to download data. This data can then be viewed using the DRAN-VIEW application.

Isolated Current Transformer

This device allows the connection of other industry-standard 5A output current transformers to Dranetz-BMI equipment.

Lockable Portable Case

The Lockable Portable Case is an optional accessory for the Power Platform 4300 (PP4300). It consists of a rugged, high impact plastic case, a voltage measurement cable assembly and a domestic 115 VAC cable assembly. The cables, case and all connections are waterproof and designed to meet NEMA 4X requirements. The LPC4300 allows the PP4300 to be operated and left unattended in harsh industrial environments.

Memory card readers

Three types of memory card readers are available as options. Each reader provides a different means of communications with an IBM compatible computer. The three types are: RS232 serial port, parallel port, and data bus plug-in.

Portable Field Printer

This optional printer is used for printing PP4300 screens. The printer is small and lightweight with a direct interface to the PP4300's RS232 communications port adapter.

Reusable Shipping Container

Lockable, high-impact plastic case with foam insulation for protecting the PP4300 during shipping.

Soft Carrying Case

Heavy-duty, padded, nylon carrying case. Includes pockets for cable set, current probes, and other accessories.

TASKCard 808

The Task 808 is available in two configurations, the Task 808/M (with memory option) and Task 808/H-M (with Harmonics and Memory options). This TASKCard changes the PP4300 to a power quantity monitor so that it measures, records, and displays electric power parameters such as demand, energy, and power factor. This can help you cut costs by identifying equipment that is operating inefficiently.

TASKCard PQLite

The PQLite TASKCard is available in the six configurations described below:

PQLite: This TASKCard changes the PP4300 to a power quality monitor which can record sags, swells, interruptions and power.

PQLite/H (w/harmonics): This TASKCard changes the PP4300 to a power quality monitor which can record sags, swells, interruptions, power and harmonics.

PQLite/H/M (w/harmonics & memory): This TASKCard changes the PP4300 to a power quality monitor which can record sags, swells, interruptions, power, harmonics and memory card functions, which allow data to be saved to an optional memory card manually, automatically, or both.

PQLite/H/T (w/harmonics, transient capture): This TASKCard changes the PP4300 to a power quality monitor which can record sags, swells, interruptions, power, harmonics and transients.

PQLite/H/T/M (w/harmonics, transient capture and memory): This TASKCard changes the PP4300 to a power quality monitor which can record sags, swells, interruptions, power, harmonics, transients and

TASK 808

memory card functions, which allow data to be saved to an optional memory card manually, automatically, or both.

PQLite/H/T/E/M (w/harmonics, transient capture, energy and memory):

This TASKCard changes the PP4300 to a power quality monitor which can record sags, swells, interruptions, power, harmonics, transients, demand, energy and memory card functions, which allow data to be saved to an optional memory card manually, automatically, or both.

Voltage Cable Accessory Pack

Contains one, single phase measurement cable which allows measurement of a single phase circuit using a standard 115 Vrms AC outlet, and four jumper cables which allow easy interconnection of the measurement cables.

C.3 Ordering information

To order accessories, contact the Dranetz-BMI Customer Service Department:

Telephone: **1-800-372-6832 or 732-287-3680**

Fax: **732-248-1834**

Appendix D PP4300 Technical Specifications

D.1 Overview

The Dranetz-BMI PP4300 is a self-contained, portable instrument designed for the measurement of power demand.

Demand defined. The demand is the load which is drawn from the source of supply at the receiving terminals, averaged over a suitable and specified interval of time, such as fifteen minutes or a half-hour. Demand is expressed in kilowatts, kilovolt-amperes, amperes, or other suitable units.

Note that as demand is measured in watts, etc., and not in watt-hours, etc., it is shown by an indicating and not an integrating device.

Measure of the demand. The demand is usually measured in kilowatts; but where power factor is an important item, the reactive kilovolt-amperes and sometimes kilovolt-ampere demand are measured. The demand of an installation is defined as the load which is drawn from the source of supply at the receiving terminals, averaged over a certain period of time. This interval of time usually used is 15 minutes, although in certain cases other intervals are used, such as 5 minutes, 30 minutes, or 60 minutes. It is very seldom that a customer is billed on instantaneous demand, unless the short high peaks may be of such a nature as to interfere with the stability of the system.

The principal factor which limits the load which the equipment of a system can carry is temperature. Because this equipment has mass, the final temperature is reached only after an appreciable period of time for a given load. The heating of the equipment does not follow any simple law. In a generator, the armature losses vary as the square of the current, and the field losses vary with the power factor as well as the current. In other parts of the equipment, the heating follows somewhat different laws. In general, it might be said that most of the change in temperature occurs during the first 15 or 30 minutes after the load is applied.

TASK 808

D.1.1 Dimensions

Size: 12" Width x 2.5" Depth x 8" Height (30.5 x 6.4 x 20.3 cm)

Weight: 4 pounds (8.8 kg)

D.1.2 Environmental

Operating: 5 to 45 °C (41 to 113 °F)

Storage: -20 to 55 °C (-4 to 131 °F)

Humidity: 10% to 90% non-condensing

D.1.3 System Time Clock

Crystal controlled. 1 second resolution.
Event time clock displays to 10 msec resolution.
Time displayed in 24 hour format HH:MM:SS.
Accurate to 60 seconds per month.

D.1.4 Memory

256 Kbytes of standard non-volatile data RAM (event storage).
256 Kbytes of standard volatile data RAM (system memory).
256 Kbytes of program EEPROM (system memory).

D.1.5 Memory Card

512 Kbytes to 4 Mbytes depending on the optional memory card capacity.

D.1.6 Power Requirements

Voltage: 12 Vdc

Consumption: 18 watts max.

D.1.7 Input Resistance

Voltage input: 8 M Ω

Current input: 200 k Ω

D.1.8 Installation Categories

Mains supply: Installation Category II, Pollution Degree 2

Measurement inputs: Installation Category III, Pollution Degree 2

D.2 Interfaces

D.2.1 Display

Type: Negative Transmissive Liquid Crystal Display (LCD) with Electroluminescent (EL) backlighting.

Resolution: 240 x 128 dot matrix.

D.2.2 Alarm

Audible alarm of short duration (approximately 0.1 second) indicates an error condition. Audible alarm of long duration (approximately 1 second) indicates an event trigger.

D.3 Measured Parameters

D.3.1 Voltage

Four fully differential voltage channels:

Channels A,B,C range: 10-600 Vrms max.

Channel D low range: 0.5-20 Vrms max.

Channel D high range: 10-600 Vrms max.

TASK 808

Crest factor: Maximum 1.7 at full scale.

Accuracy: $\pm 1.0\%$ of reading $\pm 0.05\%$ full scale, with input $> 10\%$ full scale.

D.3.2 Current

Four independent current input channels.

Channels A,B,C,D range: 10-200% of full scale current probe rating.

Channels A,B,C,D crest factor: Maximum of 3 at full scale.

Accuracy: $\pm 1.0\%$ of reading $\pm 0.05\%$ of full scale, at fundamental frequency, plus current probe accuracy.

D.3.3 Phase

Each voltage/current pair (i.e. Channel A voltage, Channel A current) is sampled simultaneously to preserve phase relationship.

D.3.4 Frequency:

Fundamental range: 30-60 Hz (TASKCard dependent)

Accuracy: $\pm 0.2\%$ of reading

D.3.5 Environmental

All specifications are met over the operating range.

D.4 Computed Parameters

D.4.1 Update Rate

All parameters (except harmonic) are updated once per second. Harmonic based parameters are updated every 5 seconds.

D.4.2 ABC Volts

Calculated as the geometric mean of the three phases. See note.

$$V_{ABC} = \sqrt{(V_A^2 + V_B^2 + V_C^2) / 3}$$

D.4.3 ABC Amps

Calculated as the sum of the three phases. See note.

$$I_{ABC} = I_A + I_B + I_C$$

D.4.4 Real Power

Single Phase: Average of instantaneous power samples taken as the product of voltage and current samples. Includes sign to indicate direction of power flow: + from source to load, - from load to source.

$$W = (1 / N) \sum_{n=1}^N V_n I_n$$

Three Phase: Calculated as the sum of the three phases. Includes sign to indicate direction of power flow: + from source to load, - from load to source. See note.

$$W_{ABC} = W_A + W_B + W_C$$

Accuracy: $\pm 2\%$ of reading $\pm 0.2\%$ of full scale at fundamental frequency.

- **NOTE:** Not All ABC values are three phase. They are based on the wiring configuration, which can be single-phase, split-phase, wye, or delta. Totals are based on the number of phases for calculations.

TASK 808

D.4.5 Apparent Power

Single Phase: Calculated as volts rms times amps rms.

$$VA = V_{RMS} \cdot I_{RMS}$$

Three Phase: Calculated as the vector sum of VAR_{ABC} and W_{ABC}

$$VA_{ABC} = \sqrt{VAR_{ABC}^2 + W_{ABC}^2}$$

Accuracy: $\pm 2\%$ of reading $\pm 0.2\%$ of full scale at fundamental frequency.

Power Factor: Calculated as real power divided by apparent power. Includes sign to indicate leading or lagging load current.

$$PF = W/VA$$

Accuracy: ± 0.05 typical

D.4.6 Reactive Power

Single Phase: Calculated as vector difference between VA and W. A sign is affixed to the VAR's magnitude to indicate whether the current lags or leads toe voltage, i.e., whether the circuit is primarily inductive or capacitive. A plus (+) sign indicates that the current *lags* the voltage (inductive). A minus (-) sign indicates the current *leads* the voltage (capacitive).

$$VAR = \sqrt{(VA)^2 - W^2}$$

Three Phase: Calculated as the sum of the three phases. Includes sign to indicate direction.

$$VAR_{ABC} = VAR_A + VAR_B + VAR_C$$

Accuracy: $\pm 2\%$ of reading, $\pm 0.2\%$ of full scale at power factor = 1.

D.4.7 Environmental

All specifications are met over the operating range.

D.5 Resetting the PP4300 to the Factory Configuration

Definition

The factory configuration of the PP4300 is the default setting of the monitoring setup, input configurations, and programmable features of the PP4300 when it left the factory.

D.5.1 Configurations

Factory configuration consists of the following.

| Item | Factory Setting |
|-----------------------------|------------------------|
| Input Channels Setup | All channels set to on |
| Channel D Setting | High range |
| Circuit Type | Single phase |
| Scale Factors | All set to 1 |
| Interval for Timed Readings | 15 minutes |
| Site Name | 4300 |
| Memory Auto-transfer | Disabled |
| Memory Storage Type | Overwrite |
| Alarm | On |
| LCD Backlight Auto-Shutoff | Enabled |
| LCD Display Mode | Normal |

Appendix E Connecting Probes/Common Circuit Connections

E.1 Making Voltage Connections

This section describes how to connect the PP4300 to make basic voltage measurements.

- **WARNING: Death, serious injury, or fire hazard could result from improper connection of this instrument. Read and understand this manual before connecting this instrument. Follow all installation and operating instructions while using this instrument.**

Connection of this instrument must be performed in compliance with the National Electrical Code (ANSI/NFPA 70-1996) of USA and any additional safety requirements applicable to your installation.

Installation, operation, and maintenance of this instrument must be performed by qualified personnel only. The National Electrical Code defines a qualified person as "one familiar with the construction and operation of the equipment and the hazards involved."

-
- **ADVERTENCIA: Una conexión incorrecta de este instrumento puede producir la muerte, lesiones graves y riesgo de incendio. Lea y entienda este manual antes de conectar. Observe todas las instrucciones de instalación y operación durante el uso de este instrumento.**

La conexión de este instrumento debe ser hecha de acuerdo con las normas del Código Eléctrico Nacional (ANSI/NFPA 70-1996) de EE. UU., además de cualquier otra norma de seguridad correspondiente a su establecimiento.

La instalación, operación y mantenimiento de este instrumento debe ser realizada por personal calificado solamente.

El Código Eléctrico Nacional define a una persona calificada como "una que esté familiarizada con la construcción y operación del equipo y con los riesgos involucrados."

- **AVERTISSEMENT: Si l'instrument est mal connecté, la mort, des blessures graves, ou un danger d'incendie peuvent s'en suivre. Lisez attentivement ce manuel avant de connecter l'instrument. Lorsque vous utilisez l'instrument, suivez toutes les instructions d'installation et de service.**

Cet instrument doit être connecté conformément au National Electrical Code (ANSI/NFPA 70-1996) des Etats-Unis et à toutes les exigences de sécurité applicables à votre installation.

Cet instrument doit être installé, utilisé et entretenu uniquement par un personnel qualifié. Selon le National Electrical Code, une personne est qualifiée si "elle connaît bien la construction et l'utilisation de l'équipement, ainsi que les dangers que cela implique."

- **WARNUNG: Der falsche Anschluss dieses Gerätes kann Tod, schwere Verletzungen oder Feuer verursachen. Bevor Sie dieses Instrument anschliessen, müssen Sie die Anleitung lesen und verstanden haben. Bei der Verwendung dieses Instruments müssen alle Installation- und Betriebsanweisungen beachtet werden.**

Der Anschluss dieses Instruments muss in Übereinstimmung mit den nationalen Bestimmungen für Elektrizität (ANSI/NFPA 70-1996) der Vereinigten Staaten, sowie allen weiteren, in Ihrem Fall anwendbaren Sicherheitsbestimmungen, vorgenommen werden.

Installation, Betrieb und Wartung dieses Instruments dürfen nur von Fachpersonal durchgeführt werden. In dem nationalen Bestimmungen für Elektrizität wird ein Fachmann als eine Person bezeichnet, welche "mit der Bauweise und dem Betrieb des Gerätes sowie den dazugehörigen Gefahren vertraut ist."

E.1.1 Safety Precautions

The following safety precautions must be followed whenever any type of connection is being made to the instrument.

- Connect the green safety (earth) ground first, before making any other connections.
 - When connecting to electric circuits or pulse initiating equipment, open their related breakers. **DO NOT** install any connection of the instrument on live power lines.
 - Connections must be made to the instrument first, then connect to the circuit to be monitored.
 - Wear safety glasses and insulated gloves when making connections to power circuits.
 - Hands, shoes and floor must be dry when making any connection to a power line.
 - Make sure the unit is turned OFF before connecting probes to the rear panel.
 - Before each use, inspect all cables for breaks or cracks in the insulation. Replace immediately if defective.
-

Medidas de seguridad

Las medidas de seguridad siguientes deberán observarse cuando se realice cualquier tipo de conexión al instrumento.

- Antes de hacer cualquier conexión, deberá enchufarse el conector de seguridad verde a tierra.
- Cuando se haga conexiones a circuitos eléctricos o a equipo de activación por pulso, deberá abrirse sus respectivas cajas de seguridad. **NO** deberá hacerse ninguna conexión del instrumento en líneas eléctricas bajo tensión.
- Las conexiones deberán hacerse primero al instrumento y, luego, al circuito a ser monitorizado.
- Al hacer conexiones a circuitos eléctricos, deberá utilizar anteojos y guantes protectores.
- Sus manos, zapatos y el piso deberán estar secos en todo momento en que se haga una conexión a un cable eléctrico.
- Verifique que la unidad esté **DESACTIVADA** antes de conectar sondas en el panel posterior.
- Previo a cada uso, deberá verificarse que los cables no estén rotos y que el material aislante no tenga rajaduras. Reemplace de inmediato cualquier parte defectuosa.

Mesures de Sécurité

Les mesures de sécurité suivantes doivent être prises chaque fois qu'un type de connexion quelconque est effectué sur l'instrument.

- Connecter d'abord la prise de terre de sécurité verte (terre) avant d'effectuer toute autre connexion.
 - Ouvrir les disjoncteurs correspondants lors d'une connexion à des circuits électriques ou à des équipement de génération d'impulsions. NE PAS effectuer de connexion d'instrument sur des lignes électriques sous tension.
 - Une fois toutes les connexions de l'instrument effectuées, connecter au circuit à contrôler.
 - Porter des lunettes de protection et des gants isolants pour effectuer des connexions aux circuits électriques.
 - S'assurer que les mains, les chaussures et le sol soient secs lors de connexions à une ligne électrique.
 - S'assurer que l'unité est ÉTEINTE avant de connecter les sondes au panneau arrière.
 - Inspecter tous les câbles, avant chaque utilisation, pour s'assurer que les isolants ne sont pas coupés ou fendus. Remplacer immédiatement tous les équipements défectueux.
-

Sicherheitsvorkehrungen

Die folgenden Sicherheitsvorkehrungen sind immer dann zu befolgen, wenn eine Verbindung zum Instrument hergestellt wird.

- Schließen Sie zuerst die grüne Sicherheits-/Erdleitung an, bevor Sie eine andere Verbindung herstellen.
- Öffnen Sie beim Anschluß an elektrische Stromkreise oder Impulsauslösungseinrichtungen die entsprechenden Unterbrecher. Es dürfen KEINE Anschlüsse an das Instrument unter stromführenden Spannungsleitungen montiert werden.
- Die Verbindungen müssen zuerst am Instrument und danach an der zu überwachenden Schaltung hergestellt werden.
- Tragen Sie Schutzbrillen und Isolierhandschuhe, wenn Sie Anschlüsse an den Stromkreisen vornehmen.
- Hände, Schuhe und Fußboden müssen trocken sein, wenn Sie Anschlüsse an den Stromkreisen durchführen.
- Stellen Sie sicher, daß das Gerät AUSgeschaltet ist, bevor Sie an der rückwärtigen Konsole Meßfühler anschließen.
- Prüfen Sie vor jedem Gebrauch alle Kabel auf Bruchstellen und Risse

in der Isolierung. Wechseln Sie schadhafte Kabel sofort aus.

Description: Voltage measurement cables with plug-on alligator clips are provided as standard accessories, stored in a cable pouch (Measurement cable set, part number 116042-G1).

Voltage Rating: All voltage measurement cables and alligator clips are rated at 600 Vrms max. For measuring voltages greater than 600 Vrms, potential transformers (PTs) must be used.

Contents of Measurement Cable Set: The voltage measurement cable set shown below (positioned relative to actual use) consists of eight, 6-foot measurement cables and eight alligator clips (maximum jaw opening, 3/4 in (20 mm)). The alligator clips are red (+) or black (-) for each of the four channels. One red (channel A), one yellow (channel B), one blue (channel C), one gray (channel D) and four white cables are provided.

The cable pouch included is not illustrated.

E.1.2 Connection guidelines

Follow these guidelines when making voltage connections.

- ❑ Refer to the measurement cable set figure for color coding of probes that connect to input channel connectors A, B, C, and D.
- ❑ Each channel input has plus (+) and minus (-) differential inputs of 60 to 600 Vrms max.
- ❑ Channel D has an additional low voltage range of 0.5 to 20 Vrms max. for low voltage measurements.

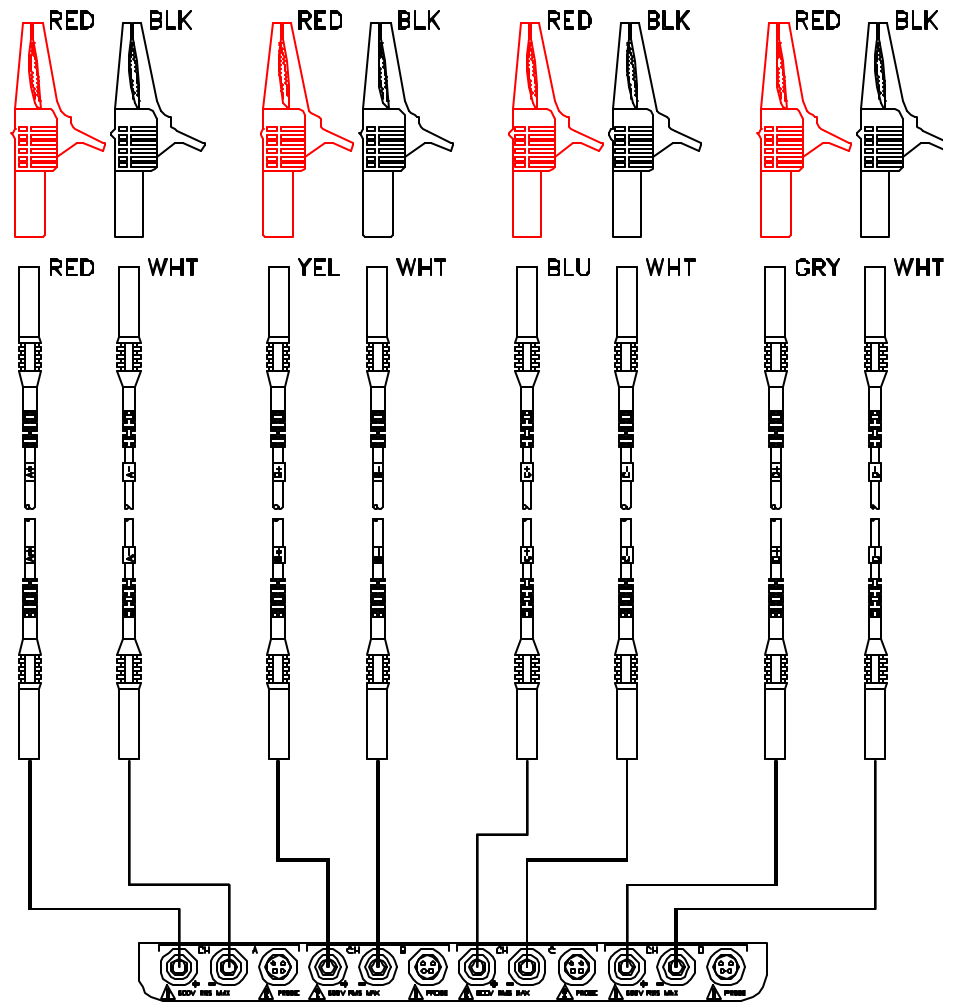

E.1.3 Single phase connection example

The following figure shows a voltage connection to a single phase circuit for channel A.

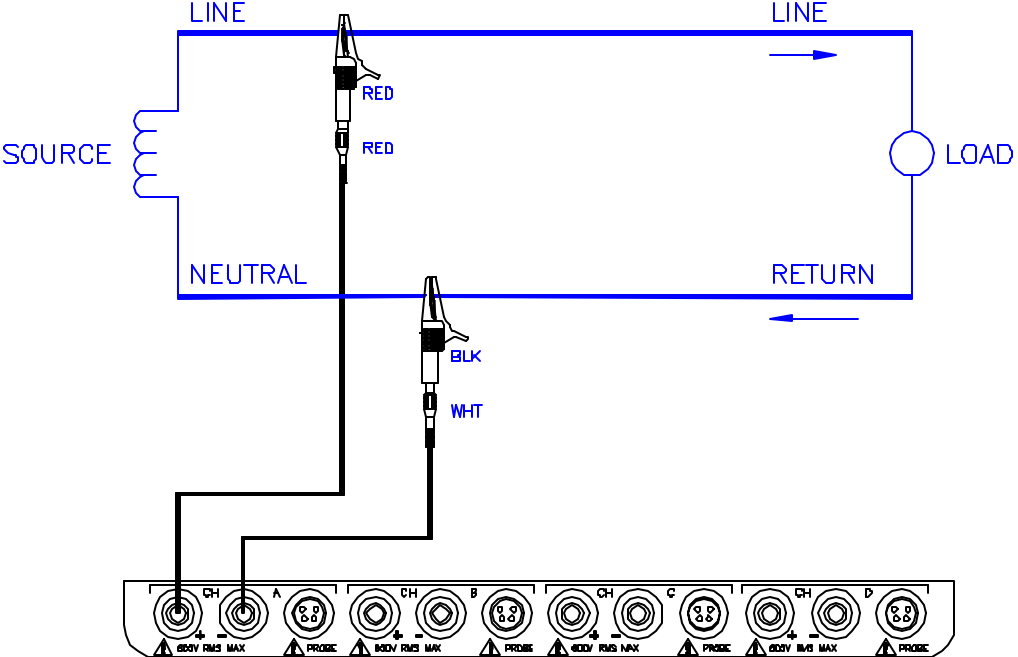

TASK 808

E.1.4 Neutral to ground connection example

The following figure shows a voltage connection using channel D as a differential input for measuring neutral-to-ground voltage.

Connections are identical for split phase, high-leg delta, and wye configurations. One probe connects the source neutral line to the D+ input. Another probe connects the ground to the D- input. Any channel input may be used to perform this measurement but Channel D is usually used because it provides a low voltage range of 0.5 to 20 Vrms.

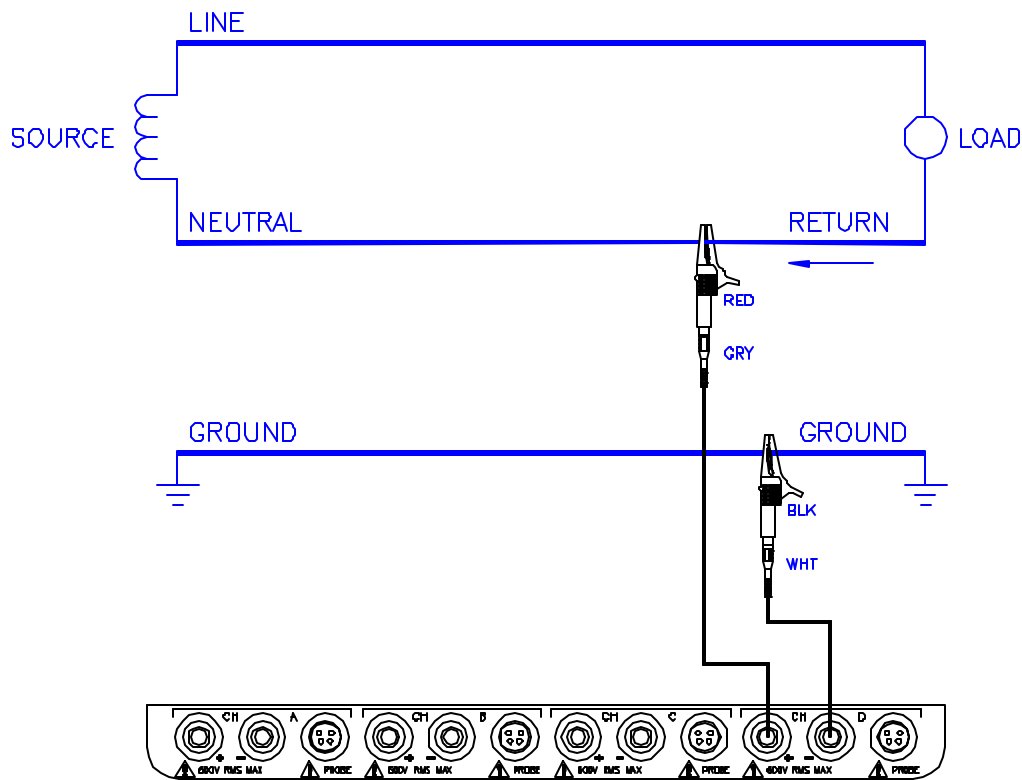

E.2 Connecting a Current Probe

E.2.1 Safety Precautions

- DO NOT attempt to measure current in any circuit in which the circuit to ground voltage exceeds the insulation rating of the current probe (600 Vrms max).
 - Make sure the jaws of the current probe are tightly closed. Keep mating surfaces clean and free from foreign matter.
-

Medidas de seguridad

- NO deberá intentar medir la corriente eléctrica en ningún circuito en que el voltaje del mismo a tierra sea mayor al promedio de aislamiento de la sonda eléctrica (600 Vrms máx).
 - Verifique que la mordaza de la sonda eléctrica esté bien apretada. Mantenga las superficies de fusión limpias y libres de materia extraña.
-

Mesures de sécurité

- NE PAS essayer de mesurer le courant dans un circuit où la tension est supérieure au régime d'isolation de la sonde (600 Vrms max.).
 - S'assurer que les mâchoires de la sonde sont bien serrées. S'assurer que la surface de contact est propre et exempte de corps étrangers.
-

Sicherheitsvorkehrungen

- Versuchen Sie NICHT, den Strom in einem Schaltkreis zu messen, in dem der Durchgang zur Erdspannung den Isolierwert des Spannungsmeßfühlers (600 Volt Effektivwert) übersteigt.
- Stellen Sie sicher, daß die Klemmbacken des Spannungsmeßfühlers fest geschlossen sind. Halten Sie die zusammengehörigen Oberflächen sauber und frei von Fremdteilen.

- **WARNING: When using the TR2021, TR2021A or TR2510 current probe, DO NOT clamp the probe jaws around a non-**

insulated wire. These probes are designed for use around insulated wire only.

- **ADVERTENCIA:** Cuando utilice sondas de corriente TR2021, TR2021A o TR2510 NO sujete las mordazas de la sonda alrededor de un alambre sin aislamiento. Estas sondas están diseñadas para usarse alrededor de cables aislados únicamente.
- **AVERTISSEMENT:** Lorsque vous utilisez la sonde de courant TR2021, TR2021A ou TR2510, **NE CLAMPEZ PAS** les mâchoires de la sonde autour d'un fil non isolé. Ces sondes sont conçues pour emploi exclusif autour de fils isolés.
- **WARNUNG:** Bei der Verwendung der Stromsonde TR2021, TR2021A oder TR2510 die Sondenbacken **NICHT** um einen nicht isolierten Draht klemmen. Diese Sonden sind nur für den Einsatz um isolierten Draht vorgesehen.

E.2.2 Available probes

Several Dranetz-BMI current probes can be used with the PP4300: models TR2500, TR2510, TR2520, TR2021, TR2019B, TR2022, TR2023. The TR2500, 2510 and 2520 will plug directly into any of the current inputs on the rear panel, the others are used with the Dranetz-BMI model 658 but can be connected to the PP4300 with an adapter cable. Typical current probes are illustrated on the following page.

■ *Refer to Appendix C Optional Accessories for additional information regarding the adapter cable and models TR2500, 2510, 2520.*

Probe positioning: An arrow marking on the handle is a guide to ensure that you position the probe with the arrow pointing in the direction of current flow to the load when monitoring the line conductor. Correct position of the probe is necessary for correct power measurements, where in-phase voltage and current measurements are necessary. A positive watts reading indicates that the probe is pointed towards the load, and a negative reading indicates that the probe is pointed towards the source.

E.2.3 Reference to Channel Input

Because no reference at the probe end identifies which channel is being monitored, a wire marker kit is supplied as a standard accessory to help in probe/channel identification. This kit provides color-coded channel marker labels to attach to both the probe handle and the plug end of the probe.

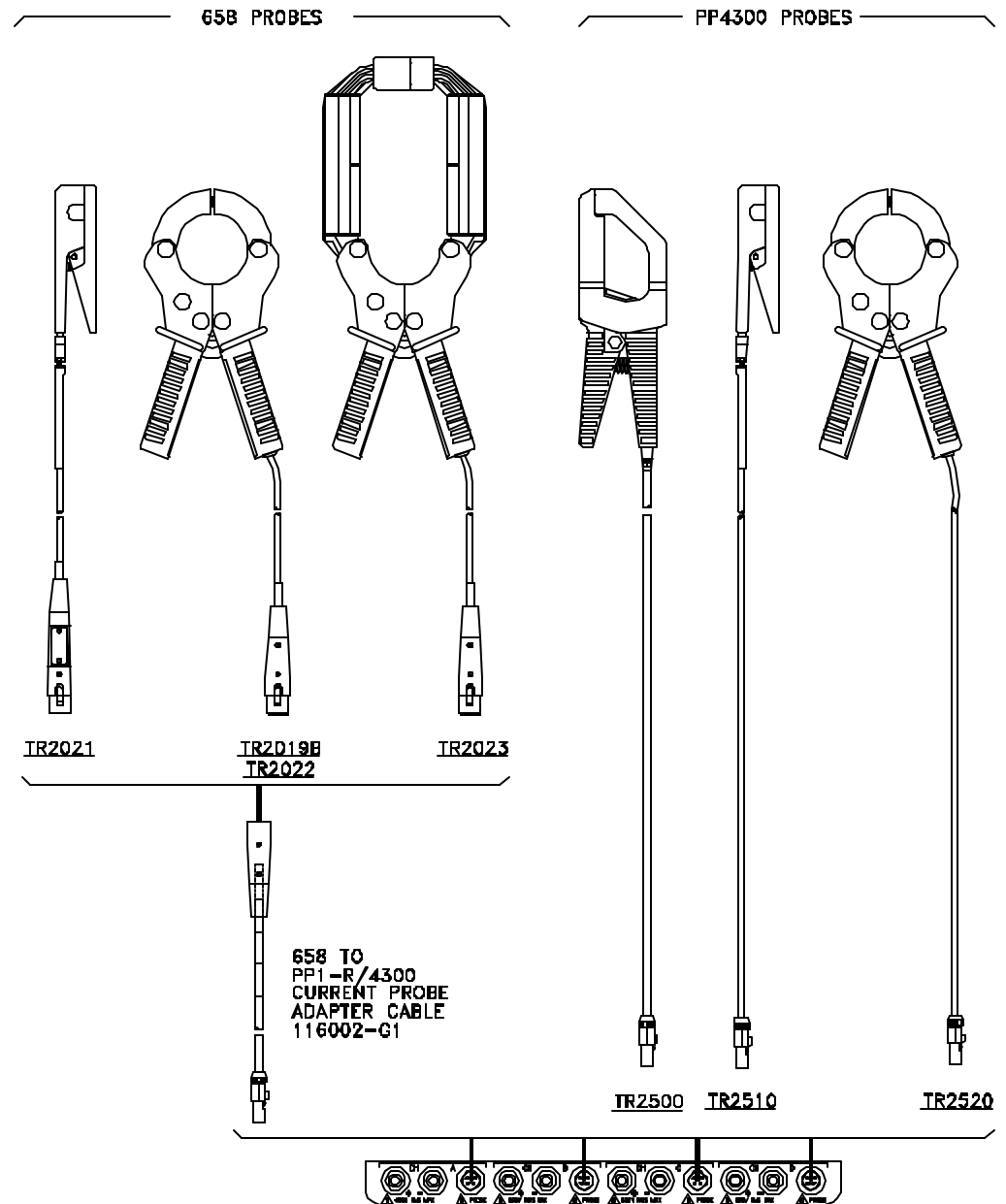

TASK 808**E.2.4 Connection Guidelines**

Follow these guidelines when making current connections.

- ❑ Position the probe with the arrow on the handle pointing towards the load.
- ❑ For greatest accuracy, use a probe that is rated at no more than twice the nominal value you expect to measure.
- ❑ Measuring currents less than 10% of full scale can lead to erroneous results.

E.2.5 Single phase current probe example

The following figure shows how to connect a current probe to channel A for current monitoring of a single phase line.

The current probe may be connected to the return line if desired to measure the return current when checking for load current leakage, loop current relationships, etc. If measuring the return line, position the probe with the arrow pointing toward the source.

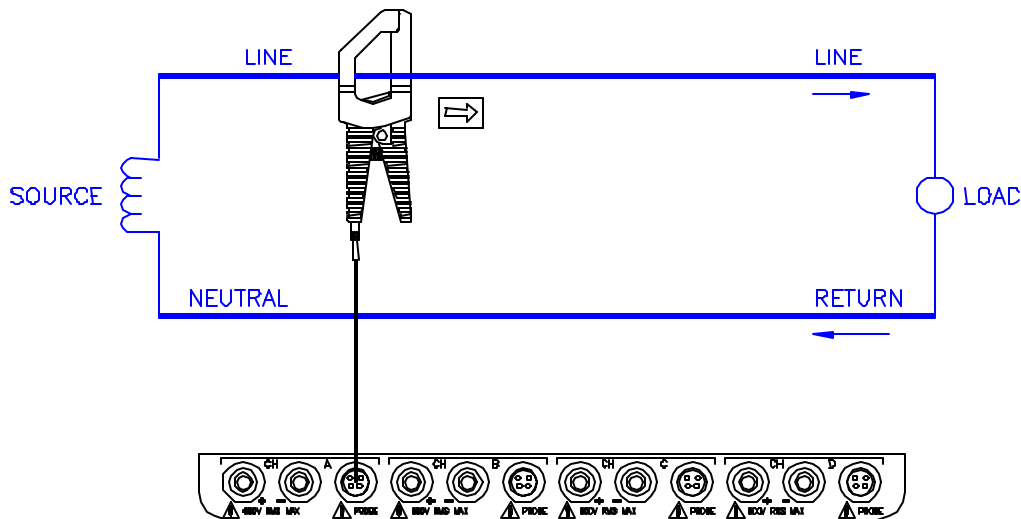

The connection shown above is not recommended without a voltage connection to ensure frequency synchronization. If this configuration is used, then an internal frequency reference must be entered.

E.3 Common Circuit Connections

E.3.1 Overview

Who should read this section

If you are making power measurements, follow these diagrams so that your ABC values are calculated correctly.

The following connections are shown:

- Single phase
- Split phase
- Four wire wye
- Floating or grounded delta
- Open leg delta
- High leg delta
- Two-and-a-half element

E.3.2 Safety Precautions

The following safety precautions must be followed whenever any type of connection is being made to the instrument.

- Connect the green safety (earth) ground first, before making any other connections.
- When connecting to electric circuits or pulse initiating equipment, open their related breakers. **DO NOT** install any connection of the instrument on live power lines.
- Connections must be made to the instrument first, then connect to the circuit to be monitored.
- Wear safety glasses and insulated gloves when making connections to power circuits.
- Hands, shoes and floor must be dry when making any connection to a power line.
- Make sure the unit is turned OFF before connecting probes to the rear panel.
- Before each use, inspect all cables for breaks or cracks in the insulation. Replace immediately if defective.

TASK 808

Medidas de seguridad

Las medidas de seguridad siguientes deberán observarse cuando se realice cualquier tipo de conexión al instrumento.

- Antes de hacer cualquier conexión, deberá enchufarse el conector de seguridad verde a tierra.
 - Cuando se haga conexiones a circuitos eléctricos o a equipo de activación por pulso, deberá abrirse sus respectivas cajas de seguridad. NO deberá hacerse ninguna conexión del instrumento en líneas eléctricas bajo tensión.
 - Las conexiones deberán hacerse primero al instrumento y, luego, al circuito a ser monitorizado.
 - Al hacer conexiones a circuitos eléctricos, deberá utilizar anteojos y guantes protectores.
 - Sus manos, zapatos y el piso deberán estar secos en todo momento en que se haga una conexión a un cable eléctrico.
 - Verifique que la unidad esté DESACTIVADA antes de conectar sondas en el panel posterior.
 - Previo a cada uso, deberá verificarse que los cables no estén rotos y que el material aislante no tenga rajaduras. Reemplace de inmediato cualquier parte defectuosa.
-

Mesures de Sécurité

Les mesures de sécurité suivantes doivent être prises chaque fois qu'un type de connexion quelconque est effectué sur l'instrument.

- Connecter d'abord la prise de terre de sécurité verte (terre) avant d'effectuer toute autre connexion.
- Ouvrir les disjoncteurs correspondants lors d'une connexion à des circuits électriques ou à des équipement de génération d'impulsions. NE PAS effectuer de connexion d'instrument sur des lignes électriques sous tension.
- Une fois toutes les connexions de l'instrument effectuées, connecter au circuit à contrôler.
- Porter des lunettes de protection et des gants isolants pour effectuer des connexions aux circuits électriques.
- S'assurer que les mains, les chaussures et le sol soient secs lors de connexions à une ligne électrique.
- S'assurer que l'unité est ÉTEINTE avant de connecter les sondes au panneau arrière.
- Inspecter tous les câbles, avant chaque utilisation, pour s'assurer que les isolants ne sont pas coupés ou fendus. Remplacer immédiatement

tous les équipements défectueux.

Sicherheitsvorkehrungen

Die folgenden Sicherheitsvorkehrungen sind immer dann zu befolgen, wenn eine Verbindung zum Instrument hergestellt wird.

- Schließen Sie zuerst die grüne Sicherheits-/Erdleitung an, bevor Sie eine andere Verbindung herstellen.
 - Öffnen Sie beim Anschluß an elektrische Stromkreise oder Impulsauslösungseinrichtungen die entsprechenden Unterbrecher. Es dürfen KEINE Anschlüsse an das Instrument unter stromführenden Spannungsleitungen montiert werden.
 - Die Verbindungen müssen zuerst am Instrument und danach an der zu überwachenden Schaltung hergestellt werden.
 - Tragen Sie Schutzbrillen und Isolierhandschuhe, wenn Sie Anschlüsse an den Stromkreisen vornehmen.
 - Hände, Schuhe und Fußboden müssen trocken sein, wenn Sie Anschlüsse an den Stromkreisen durchführen.
 - Stellen Sie sicher, daß das Gerät AUSgeschaltet ist, bevor Sie an der rückwärtigen Konsole Meßfühler anschließen.
 - Prüfen Sie vor jedem Gebrauch alle Kabel auf Bruchstellen und Risse in der Isolierung. Wechseln Sie schadhafte Kabel sofort aus.
-

E.3.3 Voltage and current connections

This section contains numerous drawings of both voltage and current probe connections that are required when power measurements are to be made.

Voltage: Voltage measurement cables are connected to the individual source or load line and are referenced to the return (common) line voltage measurement cable connection for greatest accuracy.

Current: Current probes are connected to each line and positioned to measure currents with reference to the voltage measurement cable. Incorrectly positioned current probes may produce erroneous power measurement.

E.3.4 Phasor diagrams

Correct phasor diagrams (for resistive loads) are shown for each connection.

E.3.5 Verifying Voltage and Current Connections

Introduction

Correct voltage and current connection of single phase, split phase, or polyphase connections can be verified using phasor diagrams. Phasor diagrams are graphic representations that show the magnitude and angular relationship of each phase of a monitored connection. Each connection diagram on the following pages shows the correct voltage and current phasor diagrams (for resistive loads) for that circuit.

The PP4300 Phasor diagrams are dynamically updated every 5 seconds.

Single phase

A single phase voltage or current phasor is displayed as a single line showing a channel reference at 0 degrees and a magnitude relative to its measured value. An arrowhead on the line indicates direction.

Split phase

Split phase vectors are displayed as dual lines showing channel references and magnitudes and opposite (180 degrees) directions.

Three phase

Three phase vectors are displayed as three lines, 120 degrees apart in a resistive load (unity power factor). Phase displacement will occur in a reactive load.

Correct 3-phase *voltage* phasor connections

The voltage phasor display shown below is for a three phase, four wire, wye connection.

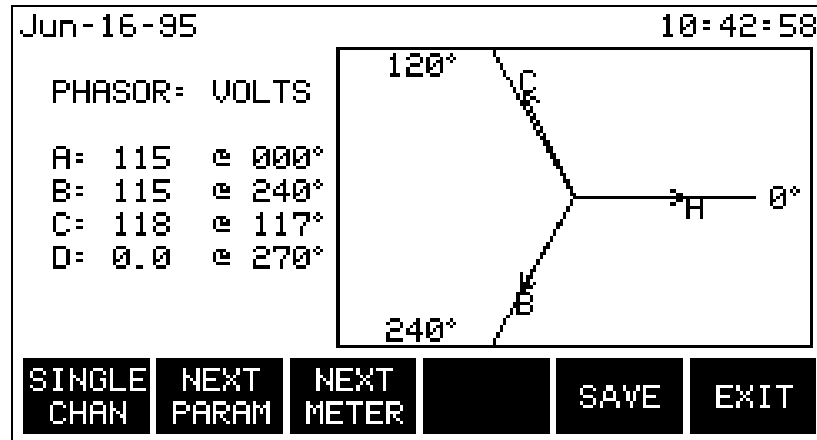

Correct 3-phase *current* phasor connections

The current phasor display shown below is for a three phase, 4 wire wye connection.

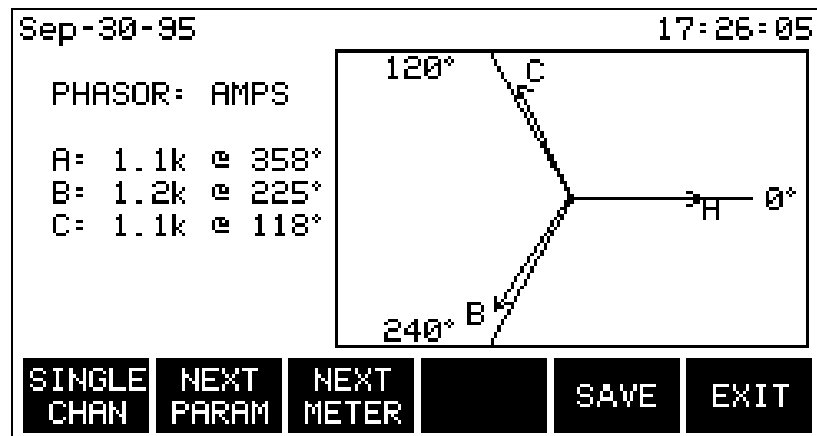

TASK 808

Incorrect current phasor diagram

The following phasor display shows an incorrect current probe connection. The phasor for channel C is 180 degrees out of phase. This can be corrected by reconnecting the probe so that the arrow on the probe handle points toward the load.

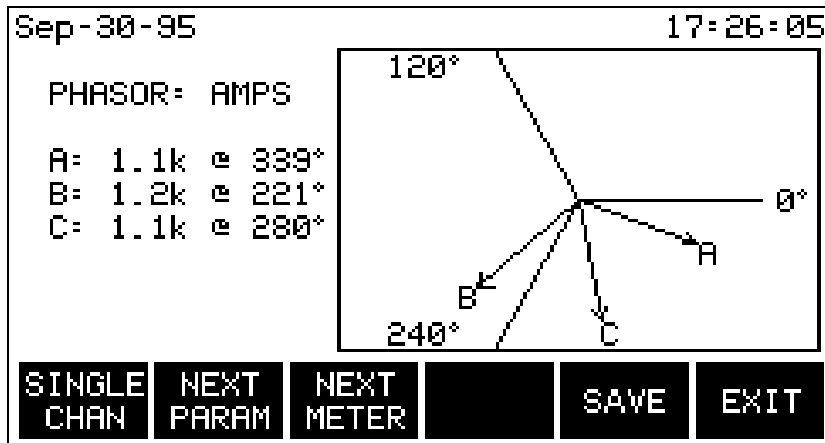

Single channel phasor diagram

The following display shows the voltage and current phasors for channel A.

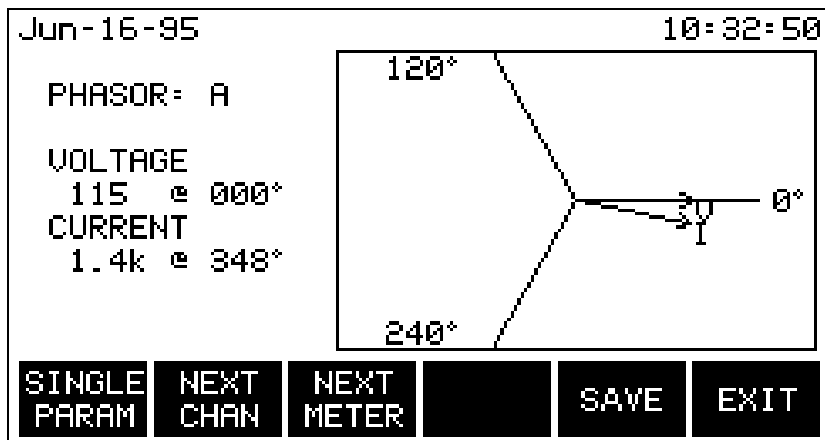

NOTE - All phasor diagrams for connections E.4 through E.10 (on the following pages) are drawn assuming balanced, resistive loads.

E.4 Single Phase

E.4.1 Introduction

When making voltage connections to a single phase circuit use channel A differential inputs as shown below.

Connect the current probe with the arrow on the handle pointing toward the load or an erroneous power reading will result.

E.4.2 Connection diagram

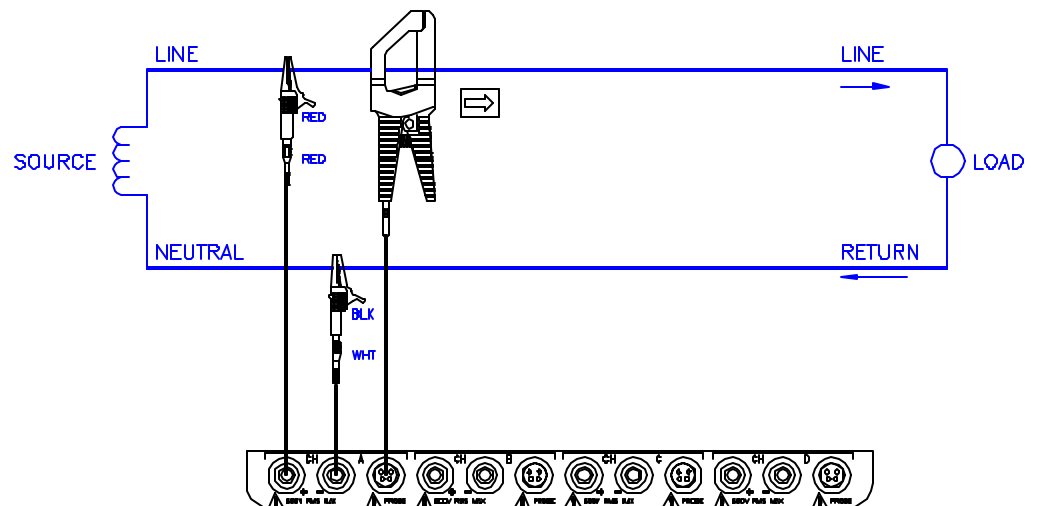

E.4.3 Single Phase Phasor Diagrams



E.5 Split Phase

E.5.1 Introduction

When making split phase measurements use both channels A and B for voltage and current connections. The neutral is chosen as the reference for measurement purposes.

E.5.2 Connection diagram

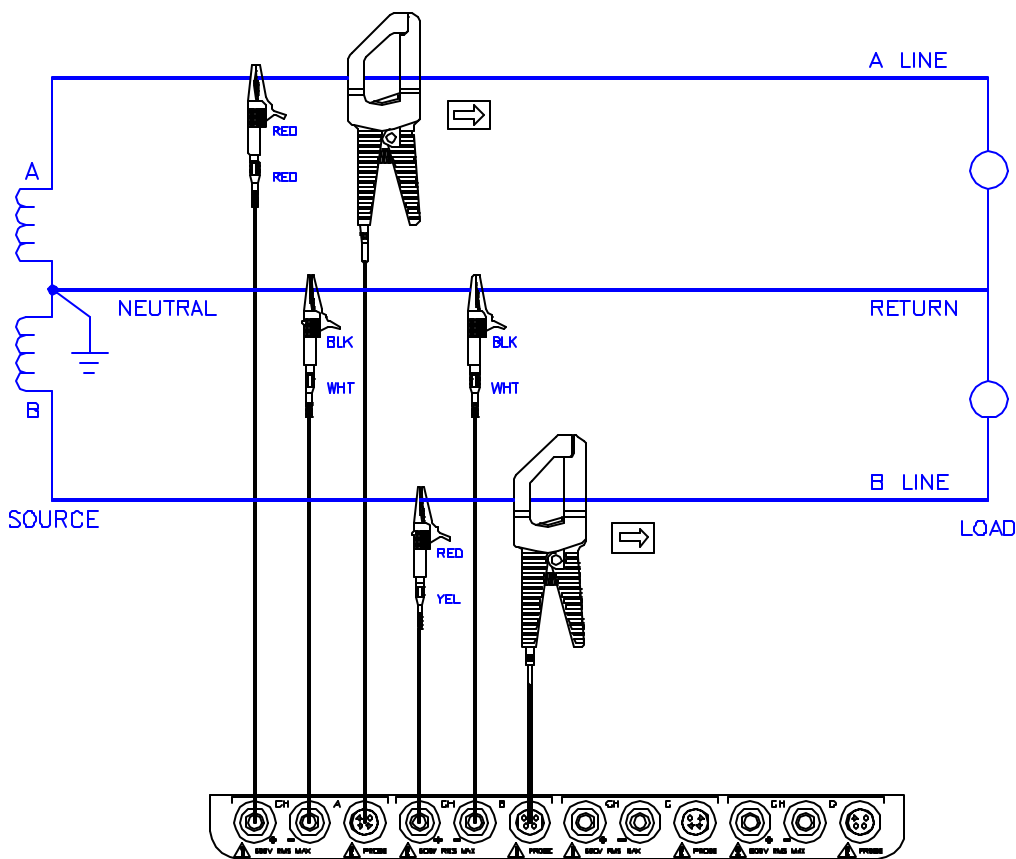

E.5.3 Split Phase Phasor Diagrams



E.6 Open Leg Delta

E.6.1 Introduction

The figure below shows the open leg delta with phase A-C connected to channel A and phase B-C connected to channel B. Current probes are connected to channels A and B.

For ABC channel values to be correct, set the Task 808's input configuration circuit type to *Split Phase*.

E.6.2 Connection diagram

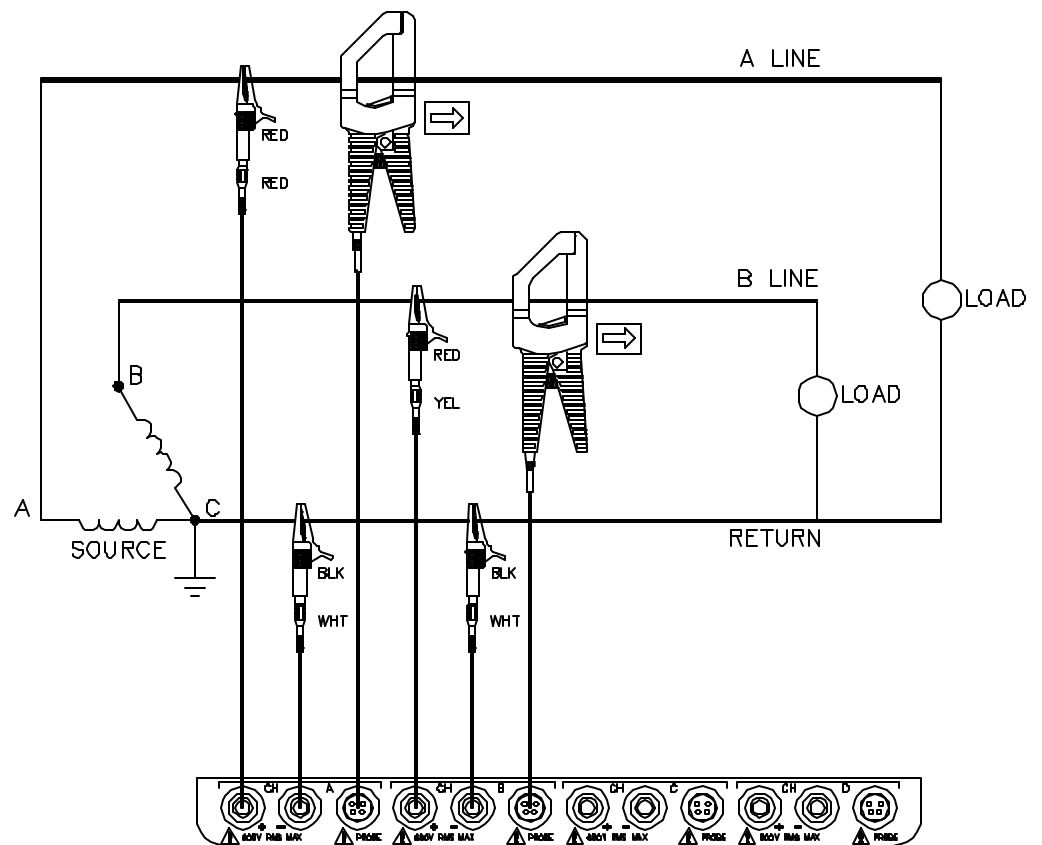

TASK 808

E.6.3 Open Leg Delta Phasor Diagrams

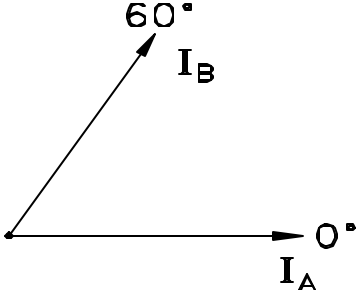
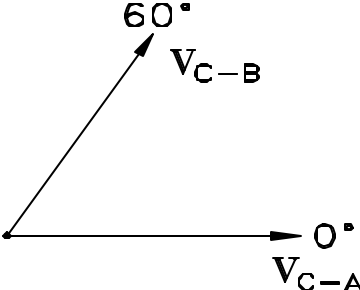

E.7 Four Wire Wye

E.7.1 Introduction

Channels A, B, and C are connected to voltage and current probes. The neutral is connected to common and is the reference for the three channels.

E.7.2 Connection diagram

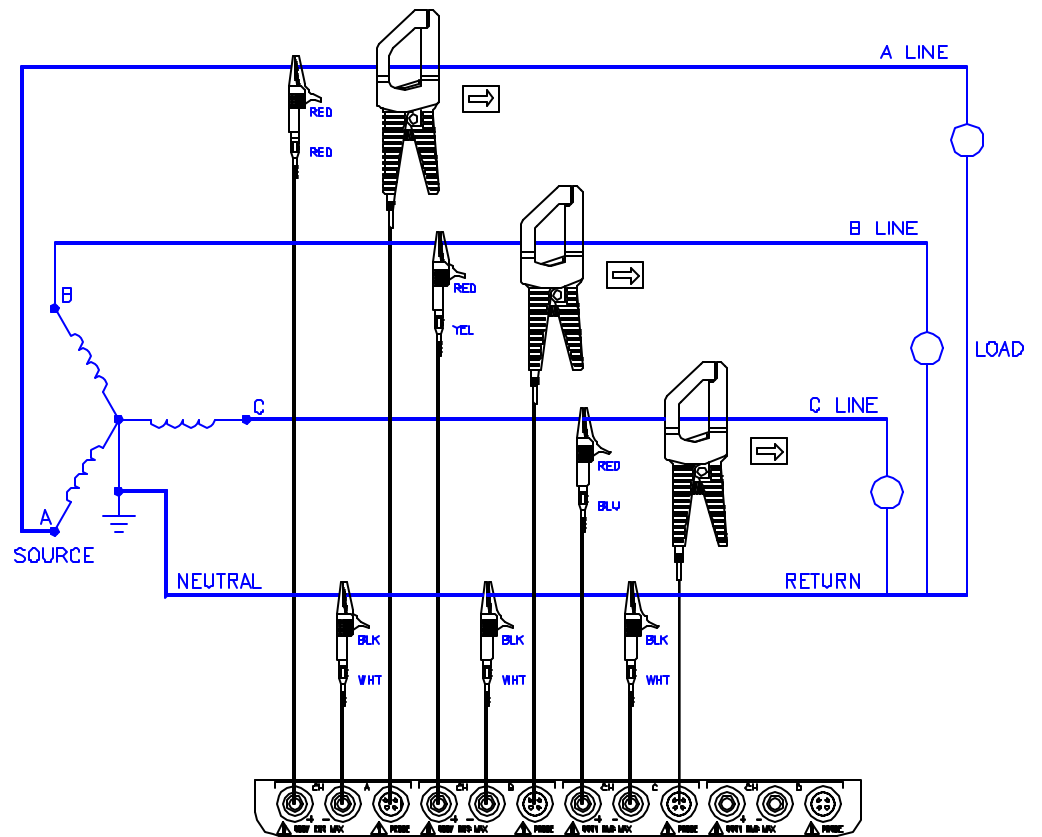

TASK 808

E.7.3 Four Wire Wye Phasor Diagrams

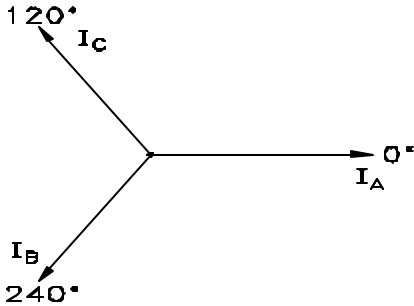
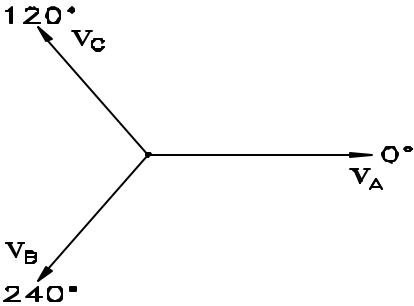

E.8 High-Leg Delta

E.8.1 Introduction

In the high-leg delta connection, also called delta with center tap or red-legged delta, the 4-wire delta connected 120/240V source is connected with one phase connected to ground at mid-point. This phase provides 120V at phases A and C to ground. Phase C is designated the high-leg connection and is measured at 208V ($120V \times 1.73 = 208V$) to ground. The National Electrical Code (1996 NEC 215-8) identifies the high-leg phase as the orange colored line.

For ABC channel values to be correct, set the Task 808's input configuration circuit type to *3 phase wye*.

E.8.2 Connection diagram

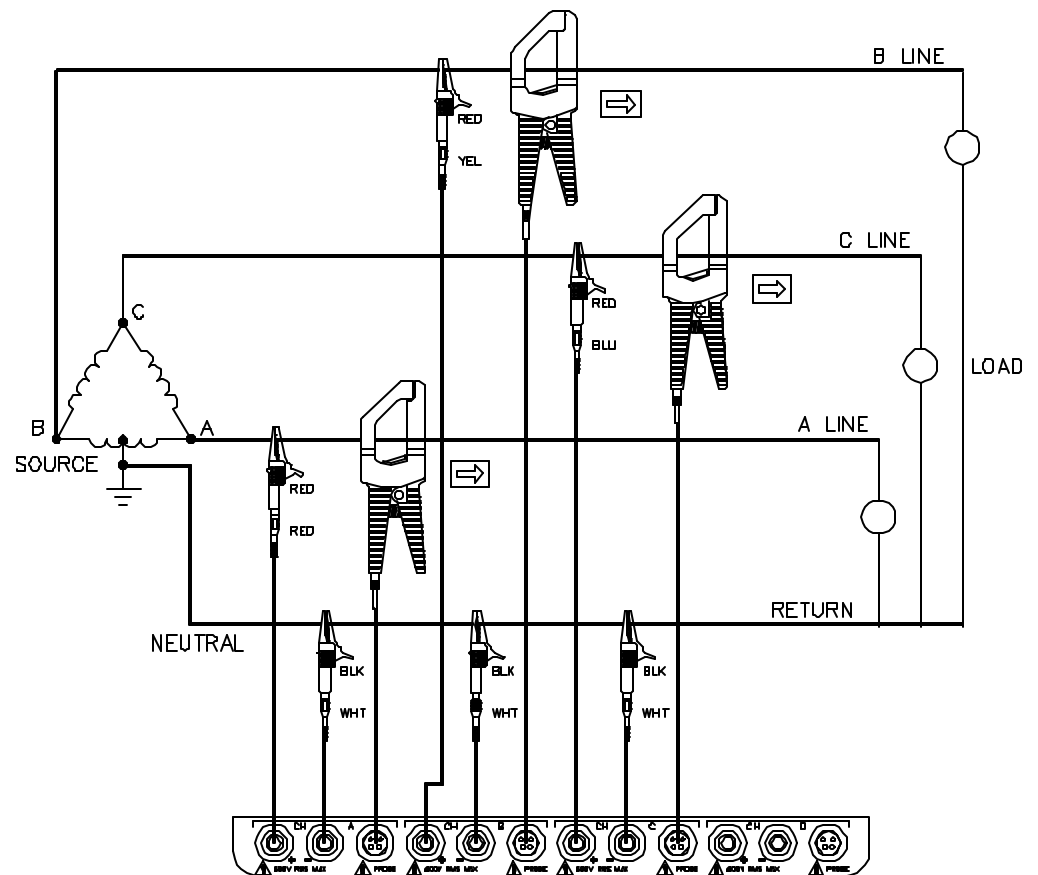

TASK 808

E.8.3 High Leg Delta Phasor Diagrams

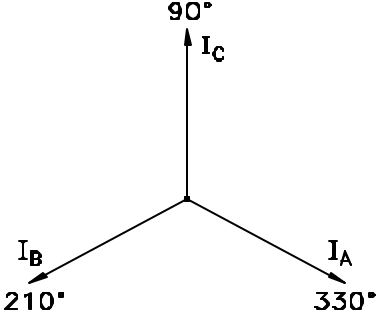
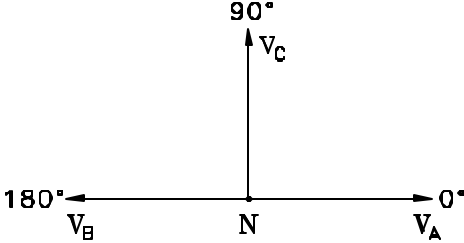

E.9 Floating or Grounded Delta

E.9.1 Introduction

In this power connection, the PP4300 uses voltage channels A, B, and C as differential inputs with channel A using source voltage A-B, channel B using B-C, and channel C using C-A as the reference. Current probes are connected to channels A, B, and C. For the grounded delta, channel C should be connected to the grounded leg. If only two channels are used (only two CTs available), then the voltage B-C in channel B and C-A in channel A should be used, along with the CTs on channels A and B.

E.9.2 Connection diagram

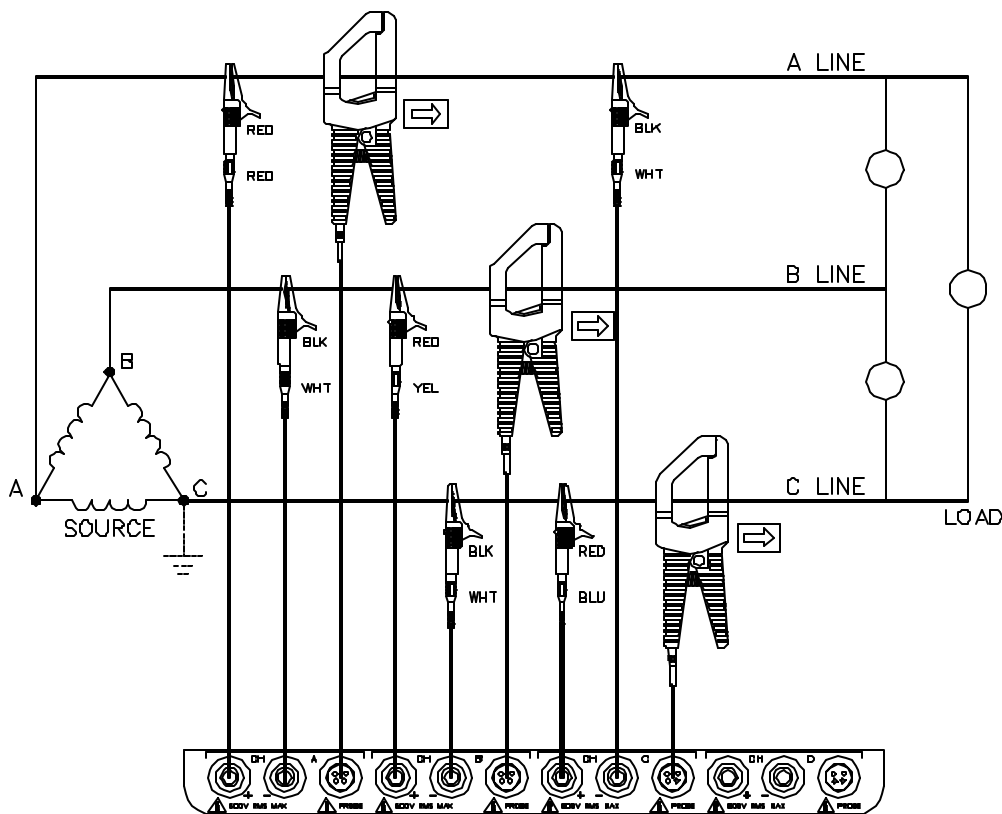

E.9.3 Floating or Grounded Delta Phasor Diagrams

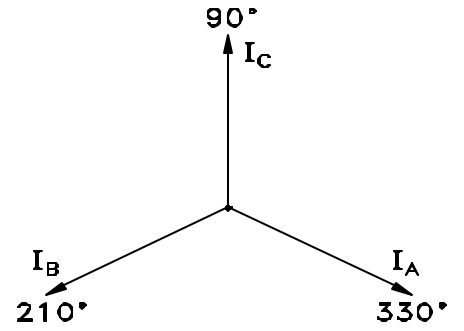
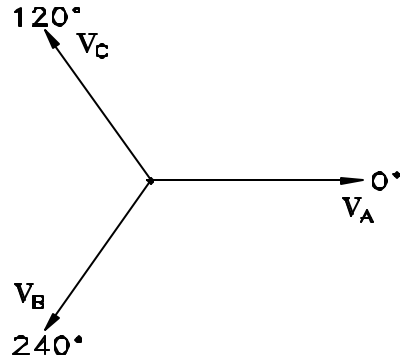

E.10 Two-and-a-half Element

E.10.1 Introduction

For older type 2 ½ element (stator) metering circuits, the two voltage channels A and C are used, along with the three current channels as shown below. Voltage B is not connected and is calculated by the Task 808.

E.10.2 Connection Diagram

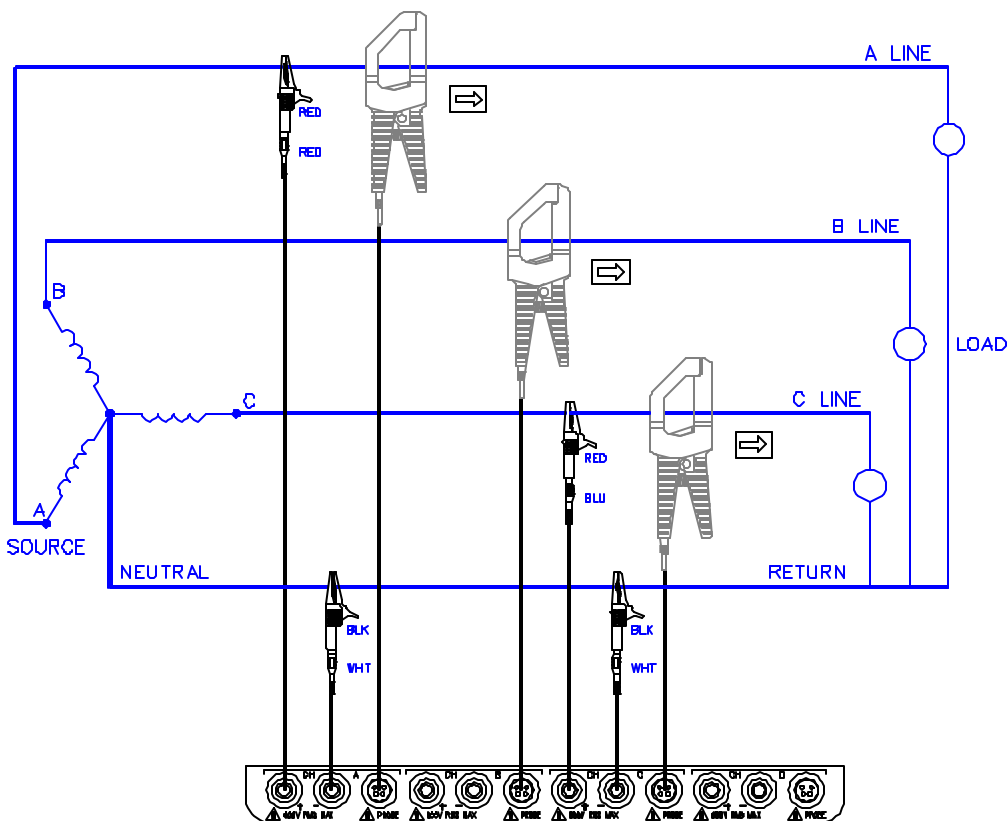

E.10.3 Two-and-a-half Element Phasor Diagrams**Explanation of values displayed**

The 2 1/2 element configuration is used to replicate wattmeters where there are two voltages and three currents. The wattmeter may have one of two internal configurations. One type uses two stators with two current coils, plus an additional 'Z-coil' current coil. The other type uses two stators with two current coils, where the third current circuit is run through both current coils.

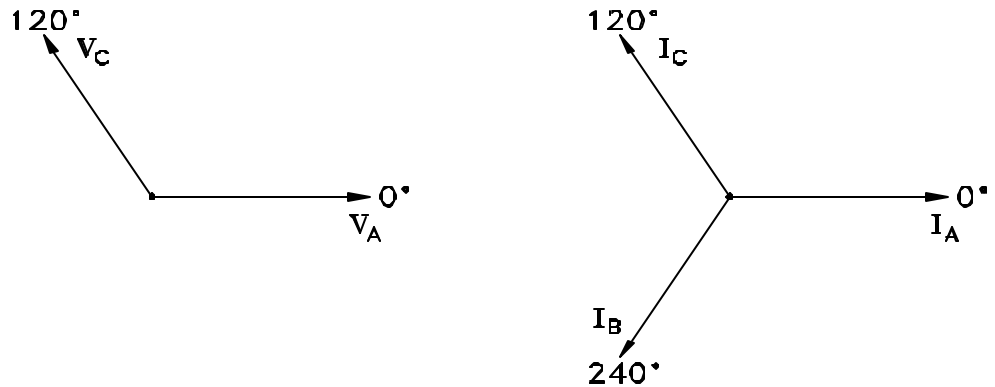

“The assumption is made in this meter that the phasor sum of the two line-to-neutral voltages is exactly equal and opposite in phase to the third line-to-neutral voltage. When this condition exists, the metering is correct regardless of current or power-factor unbalance. The assumption, however, is correct only if the phase voltages are balanced. If the voltages are not balanced, metering errors are present, the magnitude of which depend upon the degree of voltage unbalance.”¹ To calculate the percent error, refer to the *Handbook for Electricity Metering*, page 155, figure 7-24 (Error Curves).²

In the TASK808, the “missing” voltage phase is phase ‘B’. Only the current is directly measured. Since the remaining phase ‘B’ values are derived and not measured directly, these values are displayed as ‘XXXX’.

^{1, 2} Edison Electric Institute, *Handbook for Electricity Metering*, 9th ed. (Washington, D.C.: EEI, 1992), 154-55.

E.11 Connecting to PTs and CTs

Before attempting to connect to the secondary of PTs (potential or voltage transformers) and CTs (current transformers), the user should have a thorough understanding of how the primary and secondary of these devices are connected. There are many different configurations used in electric utility and industrial facilities, which vary depending on their intended use, such as inputs to relays or revenue metering. Variations include both the number of PTs and CTs (3 and 3, 2 and 3, 2 and 2, etc.), as well as the wiring configurations (3 wire wye, 3 wire floating delta, grounded delta, etc.).

The following guidelines can be used along with the instructions supplied by the instrumentation manufacturer to cover several frequently encountered circumstances:

| If the type of circuit being monitored is: | Then the most likely circuit configuration for the described application is: |
|--|--|
| Three phase delta with two PTs having a common ground | Open leg delta |
| Three phase delta with three PTs or three phase wye without a neutral connection | Floating delta |
| Three phase wye with a neutral | Four wire wye |
| 2 ½ element metering configuration | 2 ½ element |

- **WARNING: Refer to the circuit connection schematics shown in this appendix and to the PT manufacturer’s information for assistance in determining the proper connections to a PT.**
- **ADVERTENCIA: Consulte el esquema de conexiones de circuitos que aparece en este apéndice, y la información sobre TP (transformador potencial) del fabricante, para obtener ayuda para determinar las conexiones correspondientes a un TP.**
- **AVERTISSEMENT: Se reporter aux schémas de connexion des circuits présentés dans cette annexe et aux informations fournies par le fabricant du transformateur de tension (PT) pour toute assistance concernant les connexions correctes à un transformateur de tension.**

- **WARNUNG:** Die in diesem Anhang gezeigten Skizzen von Schaltverbindungen und die Herstellerinformationen zum Spannungsteilertransformator helfen Ihnen, die richtigen Anschlüsse an einen Spannungsteilertransformator festzulegen.

E.12 Connecting to a Potential Transformer (PT)

- **NOTE:** Potential transformers are not manufactured by Dranetz-BMI and are discussed here for informational purposes only.

E.12.1 Definition

A potential transformer (PT), also referred to as a voltage instrument transformer, provides the necessary step-down ratio to reduce the high voltage of circuits above 600 Vrms to a level for safe measurement. A PT also provides isolation and proper connections for instrument attachment.

E.12.2 Connections

PTs are usually fixed in position and require that the voltage measurement cable(s) be connected to their terminal connections.

- **WARNING:** Refer to the manufacturer's instructions, related to the PT, for exact information for probe connection for voltage monitoring. Do not exceed 600 Vrms input to the PP4300 voltage inputs.
- **ADVERTENCIA:** Consulte las instrucciones del fabricante referentes a TP (transformador potencial), para la información exacta de la conexión de sonda a fin de monitorear el voltaje. No supere la entrada de 600 Vrms a las entradas de voltaje de PP4300.
- **AVERTISSEMENT:** Se reporter aux instructions du fabricant relatives au transformateur de tension (Potential Transformer - PT) pour obtenir les renseignements exacts sur la connexion de sonde utilisée pour la surveillance du courant. Ne pas dépasser l'entrée de tension efficace de 600 RMS dans les entrées de tension de PP4300 volts.
- **WARNUNG:** Genaue Informationen zur Meáfühlerverbindung für die Spannungsüberwachung entnehmen Sie bitte den Anleitungen des Herstellers (siehe

Spannungsteilertransformator). Die Eingangsspannung von 600 V (Effektivwert) in die PP4300 Spannungseingänge sollte nicht überschritten werden.

E.12.3 Procedure

Follow these steps to connect voltage measurement cables to a potential transformer.

| Step | Action |
|------|--|
| 1 | Turn OFF power to the PT. |
| 2 | Connect the colored voltage measurement cables to the channel inputs on the PP4300's rear panel. |
| 3 | Connect the colored voltage measurement cables to the PT's connections in accordance with the manufacturer's instructions. |
| 4 | Turn ON power to the PT. |

E.12.4 Scale factor

The scale factor of the PT must be accounted for in making accurate voltage measurements. Because the monitored output voltage of the PT is stepped-down (divided) from the original voltage, this ratio must be stepped-up (multiplied) by the PP4300 when voltage computations are performed. The PT scale factor is usually imprinted on the PT assembly and is entered into the PP4300 on the "Scale Factors" screen. Refer to the PT manufacturer's literature for the scale factor for the device you are using. See *Scale Factor Calculation Example* in Chapter 6.

E.13 Connecting to a Current Transformer (CT)

- **NOTE:** Current transformers are not manufactured by Dranetz-BMI and are discussed here for informational purposes only.

E.13.1 Safety Precautions

The following safety precautions apply to current transformer (CT) connections.

- Never energize a CT with the secondary open.
- Never disconnect the secondary of a CT with primary energized.

TASK 808

Medidas de seguridad

Las medidas de seguridad siguientes corresponden a conexiones de transformadores eléctricos (CT).

- Nunca deberá poner bajo tensión un CT con el transformador secundario abierto.
 - Nunca deberá desconectar el transformador secundario de un transformador eléctrico si el transformador primario está bajo tensión.
-

Mesures de sécurité

Les mesures de sécurité suivantes s'appliquent aux connexions de transformateurs de courant.

- Un jamais mettre un transformateur sous tension lorsque la bobine secondaire est ouverte.
 - Ne jamais déconnecter la bobine secondaire d'un transformateur lorsque la bobine primaire est sous tension.
-

Sicherheitsvorkehrungen

Die folgenden Sicherheitsvorkehrungen gelten für Anschlüsse an Transformatoren.

- Führen Sie einem Transformator niemals Strom zu, wenn die Niederspannungsseite geöffnet ist.
 - Lösen Sie niemals die Verbindung der Niederspannungsseite eines Transformators, wenn die Oberspannungsseite unter Strom steht.
-

- **WARNING: Refer to the manufacturer's instructions related to the CT for exact information for connections for current monitoring. Do not exceed manufacturer's ratings.**
- **ADVERTENCIA: Consulte las instrucciones del fabricante referentes a TC (transformador de corriente) para la información exacta de las conexiones a fin de monitorear la corriente. No exceda las capacidades nominales del fabricante.**
- **AVERTISSEMENT: Se reporter aux instructions du fabricant relatives au transformateur de courant (Current Transformer - CT) pour obtenir les renseignements exacts sur les connexions**

utilisées pour la surveillance du courant. Ne pas dépasser la puissance recommandée par le fabricant.

- **WARNUNG: Genaue Informationen zu Verbindungen für die Stromüberwachung entnehmen Sie bitte den Anleitungen des Herstellers (siehe Stromumwandler). Die Grenzwerte des Herstellers sollten nicht überschritten werden.**

E.13.2 Description

Current transformers, also known as instrument transformers, reduce high level currents to low level currents so they can be safely monitored. These devices are similar to PTs used for voltage measurements in that both reduce values for safe measurement. The reduction, or step-down ratio, is stated as a scale factor that is used by the PP4300 to step-up the measured value to its original value.

E.13.3 Types of CTs

There are single-phase CTs and polyphase CTs dependent on the source transformer used. Current reduction ratios vary widely and are also dependent on the source transformer used. Rating plates attached to the CT provide information about the ratio and current limitations.

E.14 Connecting to an Isolated Current Transformer (ISO)

E.14.1 Introduction

Low current monitoring devices made by Dranetz-BMI are called isolated current transformers or ISO boxes. The Dranetz-BMI ISO box has a 5 A current range. See *Set Input Configurations* in Chapter 6 for information on scale factors. See Appendix C for ISO box description.

E.14.2 Safety Precautions

The following safety precautions apply to ISO box connections in addition to those safety precautions stated at the beginning of this Appendix.

- Never energize an ISO box with the secondary open.
- Never disconnect the secondary of an ISO box with primary energized.

TASK 808

Medidas de seguridad

Las medidas de seguridad siguientes, además de aquellas que aparecen al principio de este apéndice, corresponden a conexiones de caja ISO.

- Nunca deberá ponerse bajo tensión una caja ISO con el transformador secundario abierto.
 - Nunca deberá desconectarse el transformador secundario de una caja ISO mientras esté bajo tensión el transformador primario.
-

Mesures de sécurité

Les mesures de sécurité suivantes s'appliquent aux connexions de boîte ISO en plus des mesures de sécurité présentées au début de cette annexe.

- Ne jamais mettre une boîte ISO sous tension lorsque la bobine secondaire est ouverte.
 - Ne jamais déconnecter la bobine secondaire d'une boîte ISO lorsque la bobine primaire est sous tension.
-

Sicherheitsvorkehrungen

Die folgenden Sicherheitsvorkehrungen für ISO-Dosenanschlüsse gelten zusätzlich zu den Sicherheitsvorkehrungen, die zu Beginn dieses Anhangs genannt wurden.

- Führen Sie einer ISO-Dose niemals Strom zu, wenn die Niederspannungsseite geöffnet ist.
 - Lösen Sie niemals die Verbindung der Niederspannungsseite einer ISO-Dose, wenn die Oberspannungsseite unter Strom steht.
-

- **WARNING: Physical injury or equipment damage could result if ISO boxes are improperly connected. Do not connect an ISO box between two conductors which are at different voltage potentials.**
- **ADVERTENCIA: Podrían producirse lesiones físicas o daños al equipo si se conectan indebidamente las cajas del transformador aislado de corriente (ISO). No conecte una caja del ISO entre dos conductores que tengan distintos potenciales de voltaje.**

- **AVERTISSEMENT: Une mauvaise connexion des transformateurs d'intensité isolés (ISO) peut provoquer des blessures corporelles ou des dégâts matériels. Ne pas relier les transformateurs ISO entre deux conducteurs de tensions différentes.**
- **WARNUNG: Falsch angeschlossene ISO-Kästen (Isolierte Stromumwandler) können zu körperlichen Verletzungen oder Geräteschäden führen. Schliessen Sie einen ISO-Kasten nicht zwischen zwei Leiter mit unterschiedlichem Spannungspotential.**

E.14.3 Connections to ISO box

The ISO box has terminal posts labeled X1 and X2 that are connected in series only with an ac current source. In normal connections, where phasing of current and voltages are important for power measurements, the X1 terminal is connected towards the source input line.

When connecting to CTs, the X1 terminal is normally connected to the H1 terminal of the device for correct reference phasing.

Where power measurements or voltage/current phase relationships are not important, the X1 and X2 terminals may be connected in series with the output device in any line (hot or return) or in any relationship of X1/X2.

E.14.4 Applications

ISO boxes can be used in a number of ways. These methods include:

- connecting them to the secondary of CTs for metering by the PP4300.
- inserting them in series with the load current to measure low current values.
- connecting them to a non-Dranetz-BMI clamp-on current transformer and using that CT to monitor current with the PP4300.

E.14.5 ISO box connection to a current transformer

The figure below shows an ISO box connected from any current channel input to a permanently installed CT. The connection shown is made in the load return line for current monitoring only. Polarities of the ISO box and CT are kept in-phase by matching markings of X1 to H1. Scale factors of both devices must be multiplied together to get the resultant scale factor.

TASK 808

See *Set Input Configurations* in Chapter 6 for more information about scale factors.

- **CAUTION: DO NOT** exceed current limits of the ISO box.
- **PRECAUCION: NO** exceda los límites de corriente de la caja del ISO.
- **ATTENTION: NE PAS** dépasser les limites d'intensité du transformateur ISO.
- **VORSICHT: Die aktuellen Grenzwerte** für den ISO-Kasten sollten **NICHT** überschritten werden.

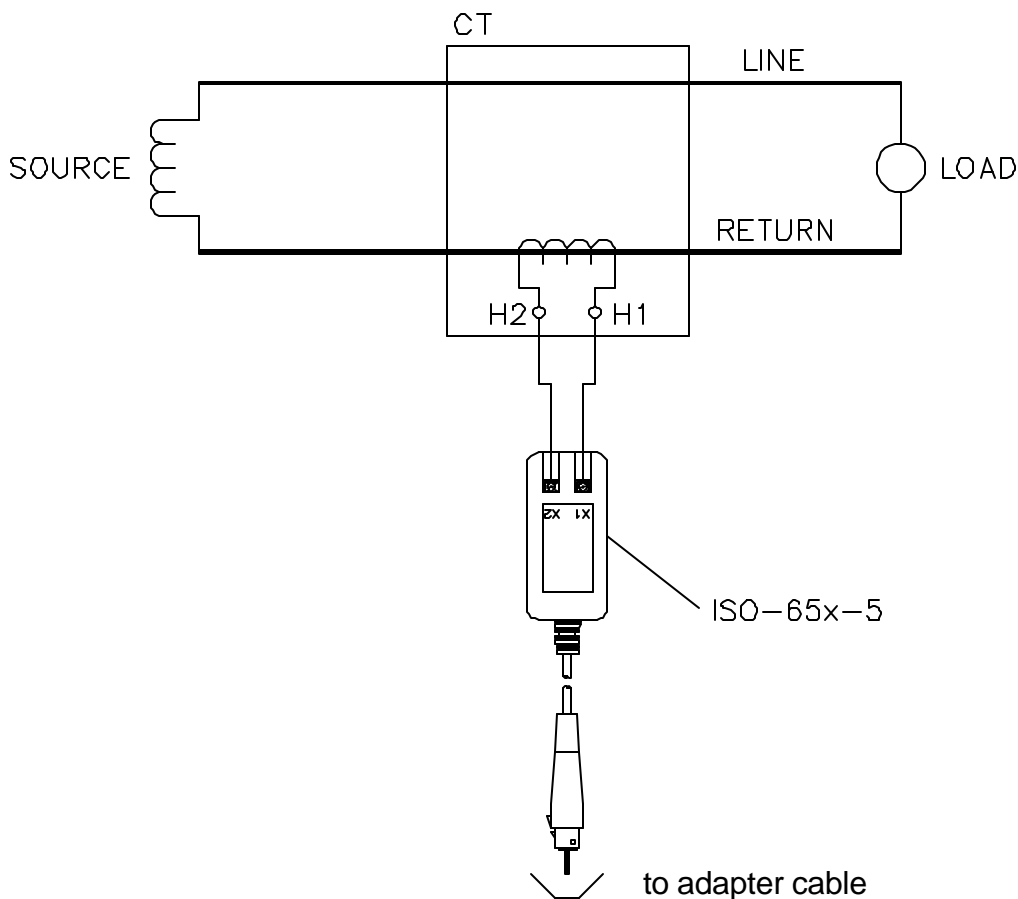

Appendix F Memory Card Functions

F.1 Memory Card Battery Replacement

F.1.1 Introduction

Replacement of the 3-volt lithium battery in the memory card is needed when the battery message in the “Memory Card Function” screen states the battery is depleted. Replacement is simple and requires no special tools. Two physically different types of batteries are used due to different manufacturers of the memory card. The correct replacement type must be used.

- **WARNING:** The battery used in this device may present a fire or chemical burn hazard if mistreated. Do not recharge, disassemble, or dispose of in fire. Replace battery with Panasonic BR2325 or CR2025 only. Use of another type battery may present a risk of fire or explosion.
- **ADVERTENCIA:** La batería empleada en este dispositivo puede presentar un peligro de incendio o quemadura química si se manipula indebidamente. No recargue, desarme ni deseche en el fuego. Cambie la batería por una Panasonic BR2325 o CR2025 solamente. El uso de cualquier otro tipo de batería puede presentar un peligro de incendio o explosión.
- **AVERTISSEMENT:** La batterie utilisée dans cette unité peut présenter des risques d'incendie ou de brûlures chimiques par suite d'une utilisation abusive. Ne pas recharger, démonter, ni jeter au feu. Remplacer uniquement la batterie par une batterie Panasonic BR2325 ou CR2025. L'utilisation d'un tout autre modèle de batterie peut entraîner des risques d'incendie ou d'explosion.
- **WARNUNG:** Die in diesem Gerät verwendete Batterie kann im Falle einer unsachgemäßen Behandlung zu Bränden oder chemischen Verätzungen führen. Sie sollte nicht wiederaufgeladen, auseinandergenommen oder verbrannt werden. Ersetzen Sie die Batterie nur mit Batterien vom Typ Panasonic BR2325 oder CR2025. Die Verwendung eines anderen Batterietyps kann Brände oder Explosionen hervorrufen.

TASK 808

F.1.2 Battery check

To check the condition of the memory card battery, perform the following steps.

| Step | Action |
|-------------|--|
| 1 | Insert questionable memory card in memory card slot on PP4300 and press card in firmly. |
| 2 | From the "Scope Mode" screen, press SETUP. |
| 3 | From Setup Menu select 4, Memory Functions. |
| 4 | From Memory Functions menu, select 1, Memory Card Functions. |
| 5 | Verify Memory Card Battery = OK. If OK, do not replace the battery. If not OK, proceed to replacement procedure. |
| 6 | If message says OK, but the memory card is faulty, try a different memory card for operation. If the replacement memory card operates OK, the original memory card is faulty and should be replaced. |

F.1.3 Battery types

There are two types of physically different memory card batteries. Both batteries are 3-Volt, lithium, wafer type.

| Part Number | Diameter | Thickness |
|--------------------|-----------------|------------------|
| Panasonic CR2025 | 0.79" (20mm) | 0.1" (2.5mm) |
| Panasonic BR2325 | 0.9" (23mm) | 0.1" (2.5mm) |

F.1.4 Battery Safety Precautions

The following safety precautions must be adhered to.

- Keep batteries away from children. Never permit a child to play with a battery as an ornament or toy.
- Do not disassemble battery or battery pack.
- Do not dispose of battery in fire.
- Dispose of a used battery promptly in accordance with local Environmental Protection Agency (EPA) regulations.

Medidas de seguridad de la batería

Deberán observarse las medidas de seguridad siguientes:

- No deberá mantenerse las baterías al alcance de los niños. No deberá permitirse que un niño juegue con una batería.
 - No deberá desensamblarse ninguna batería ni el compartimiento de la misma.
 - No deberá prenderse fuego a una batería.
 - Toda batería agotada deberá desecharse de manera rápida según las normas locales de la Agencia de protección del medio ambiente (EPA).
-

Mesures de sécurité relatives aux batteries

Il est très important de suivre les mesures de sécurité suivantes.

- Ne pas laisser les batteries à la portée des enfants. Ne jamais laisser un enfant jouer avec une batterie.
 - Ne pas démonter de batterie ou de bloc-batterie.
 - Ne pas jeter de batterie dans le feu.
 - Se débarrasser rapidement des batteries usagées en se conformant aux règlements de l'EPA (Agence américaine pour la protection de l'environnement).
-

Batterie-Sicherheitsvorkehrungen

Die folgenden Sicherheitsvorkehrungen müssen beachtet werden.

- Halten Sie Batterien von Kindern fern. Erlauben Sie einem Kind unter keinen Umständen, eine Batterie als Verzierung oder Spielzeug zu benutzen.
- Nehmen Sie Batterien oder Batteriepackungen nicht auseinander.
- Entsorgen Sie Batterien nicht durch Verbrennen.
- Entsorgen Sie verbrauchte Batterien umgehend nach den gesetzlichen Umweltschutzbestimmungen.

TASK 808

F.1.5 Replacement procedure

To remove and replace a memory card battery, proceed as follows:

| Step | Action |
|------|--|
| 1 | Remove memory card from PP4300. |
| 2 | Refer to figure below. Gently press in battery release with pencil point and remove battery holder. |
| 3 | Remove battery from holder and identify the type battery used. If type is not identified on body of battery refer to table above for battery dimensions. |
| 4 | Insert the exact type replacement battery in holder with plus (+) terminal facing up. |
| 5 | Insert battery holder into memory card and press in until locked in position. |
| 6 | Dispose of battery promptly. See battery safety precautions above. |

Typical memory card battery replacement:

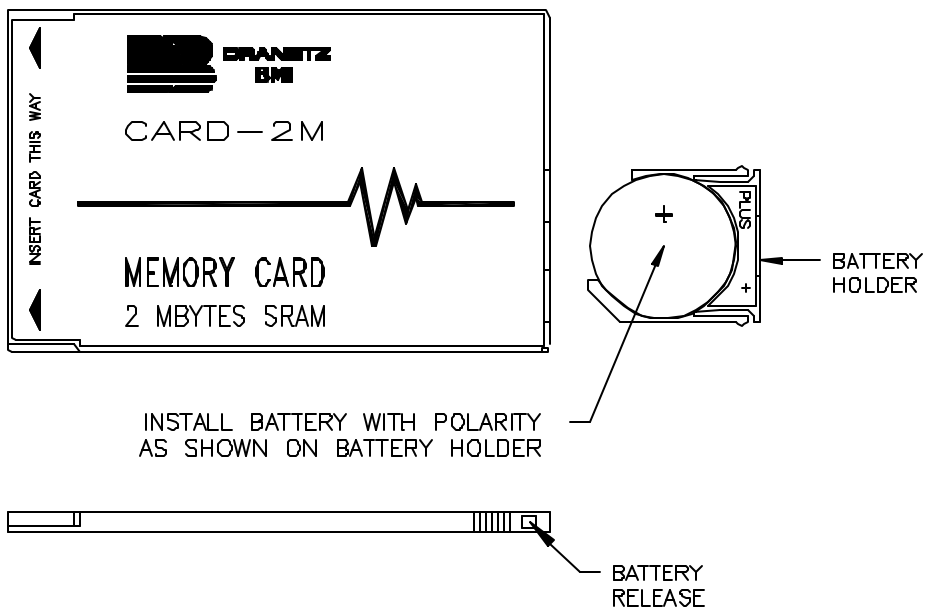

F.2 Memory Card Formatting

F.2.1 Memory Card

Optional memory cards for the Task 808 are available in various capacities, shown in Appendix C.

F.2.2 Memory Card Formatting Procedure

Step 1 From the “Memory Functions” menu, press 1 to display the “Memory Card Functions” screen. This screen automatically displays a status of the memory card.

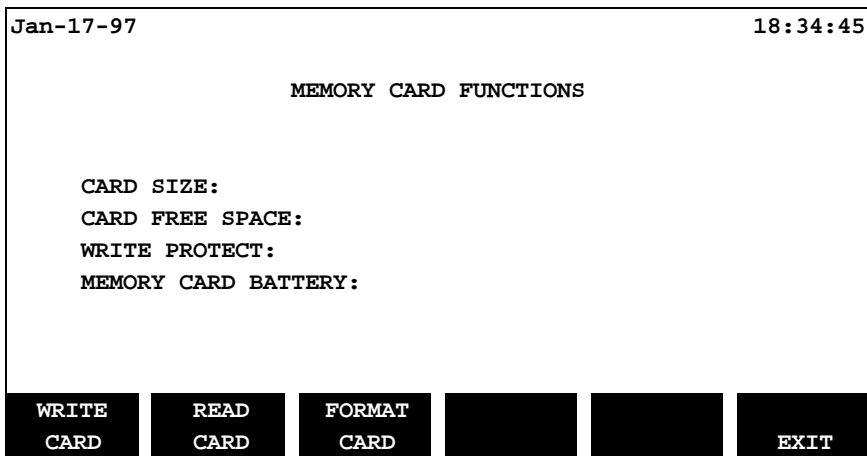

NOTE - If the memory card is not formatted (or not seated in the slot properly), no values will be displayed. New memory cards are not formatted and must be formatted before use.

Step 2 To format a memory card:

insert the card – make sure it is seated securely
press the **FORMAT CARD** SOFTKey

TASK 808

Read the warning – press the **YES** SOFTKey if you wish to continue formatting. When the formatting is finished, values will be displayed on the “Memory Card Functions” screen:

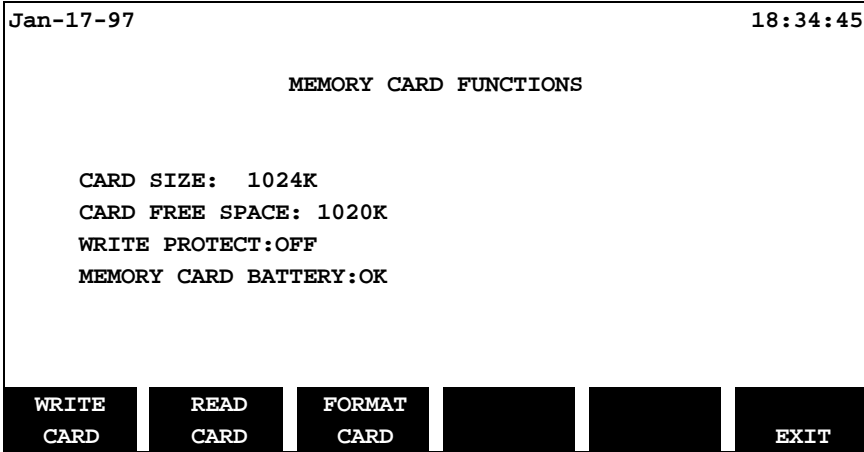

Appendix G Operator-Replaceable Parts

G.1 Introduction

The following parts are easily replaced by the operator and do not require special tools or access to the interior of the unit.

G.2 To order parts

Call Dranetz-BMI Customer Service at:

(732) 287-3680 or 1-800-372-6832

G.3 Parts List

| Part Description | Part # |
|---|-----------|
| AC Adapter/Battery Charger | 116297-G1 |
| Battery Door | 116037-G1 |
| Battery Pack | BP4300 |
| Cable Pouch | 116043-G1 |
| Measurement Cable Set w/Alligator clips | 116042-G1 |
| Rubber Skin | 116035-G1 |

Measurement Cable Set, parts list

| Part Description | Part Number |
|---|-------------|
| Alligator Clip, red | 900371 |
| Alligator Clip, black | 900372 |
| Cable Pouch | 116043-G1 |
| Interconnecting Cable Assy, Red, 72 in. (182.9 cm) | 900366 |
| Interconnecting Cable Assy, Yellow, 72 in. (182.9 cm) | 900367 |
| Interconnecting Cable Assy, Blue, 72 in. (182.9 cm) | 900368 |
| Interconnecting Cable Assy, Gray, 72 in. (182.9 cm) | 900369 |
| Interconnecting Cable Assy, White, 72 in. (182.9 cm) | 900370 |

This page intentionally left blank.

Appendix H System Messages (PP4300)

H.1 Introduction

Display messages provide PP4300 operating information or describe an error condition. This appendix describes the types of messages that can appear, lists the messages, and gives instructions about what to do next. Self-explanatory messages are not included.

H.2 Message Types

H.2.1 Overview

There are three types of messages: Normal One-Line, Important One-Line, and Full Screen. When an important message is displayed it is automatically saved to memory for recall at a later time.

H.2.2 One-line messages

All one-line messages are displayed on the top line of the screen between the time and date, and are a maximum of 21 characters long. They are displayed as long as the condition exists.

Normal one-line messages: Normal one-line messages are displayed in regular text.

Important one-line messages: Important one-line messages are displayed in reverse video.

H.2.3 Full screen messages

Full screen messages warn of potential system problems. Press any key to remove the screen message.

Priority

In general, a more important message will take priority over a less important one, with the exception of full screen messages which are displayed until a key is pressed.

When two or more one-line message are active, they are alternately cycled every two seconds. The priority is as follows:

TASK 808

| Priority | Description |
|-----------------|---|
| 1 | All new one-line messages are displayed immediately, accompanied by a short beep, then normal message cycling is resumed. |
| 2 | When there are important one-line messages, only these will be cycled until they are cleared. |
| 3 | When there is only one important one-line message displayed, no normal one-line messages will cycle until the displayed message is cleared. |
| 4 | No one-line messages are displayed on Help screens, but full screen messages will operate normally. |
| 5 | Full screen messages will always take precedence over any type of one-line display. |

H.3 Messages

H.3.1 One-line messages

Sync Lost Ch A, B, C, or D.

The unit cannot synchronize to the specified channel. Either no voltage or a voltage outside the sync range is being applied. If the unit continues to switch between Sync Lost and Sync Acquired, you may have to change to internal sync.

Sync Acquired Ch A, B, C, or D.

The unit has synchronized to the specified voltage channel.

Probe Ch A, B, C, or D-Connect.

A current probe has been connected to the specified channel.

Probe Ch A, B, C, or D-Disconnect.

The current probe on the specified channel has been disconnected.

Volts Overload Ch A, B, C, or D.

The voltage range for the specified channel has been exceeded.

Amps Overload Ch A, B, C, or D.

The current range for the specified channel has been exceeded. Use a probe with a range appropriate for your measurements.

Volts Over-range Ch A, B, C, or D.

The voltage safety limit for the specified channel has been exceeded. Turn OFF power to the circuit and disconnect the unit.

Amps Over-range Ch A, B, C, or D.

The current safety limit for the specified channel has been exceeded. Turn OFF power to circuit and disconnect the unit.

H.3.2 Full screen message

Battery Low.

The charge on the internal battery is low. Charge the battery by connecting the AC adapter output cable to the DC INPUT connector on the right side of the PP4300. Connect the AC adapter power cord to an appropriate

TASK 808

outlet. A depleted battery pack can be recharged in 2 hours with the unit OFF and 24 hours with the unit ON.

H.4 TASKCard error messages

The following table describes the possible error messages when loading the TASKCard and the corrective action to take for each.

| Error Message | What to do Next |
|--|---|
| TASKCard Not Found. Please Install TASKCard. | TASKCard may not be installed or is installed incorrectly. Turn OFF power and check TASKCard installation. |
| Corrupt TASKCard. Please Install TASKCard. | A TASKCard was found but it was not recognized as a valid TASKCard. Turn OFF power and recheck TASKCard. If the TASKCard is properly inserted, there may be a problem. Notify Dranetz-BMI for further assistance. |
| WARNING: The Task Card found: (now installed) Is different than last used: (previous Task Card) CHANGING TASK CARDS MAY ERASE MEMORY! | Press any key to continue or turn OFF the unit and reinstall the last TASKCard used. |
| Any of the following: DSP Processor Download Failed DSP Processor Will Not Respond | TASKCard download problem. Notify Dranetz-BMI for further assistance. |

Index

A

AC Adapter/Battery Charger, 11
accessories, 1, 2, 79, 82, 83, 97
AUDIBLE ALARM, 36, 38
Auto-transfer, 39, 41, 43, 91

B

battery pack, 11, 12, 73, 74, 76, 77, 80
Battery Pack Replacement, 73

C

Calibration, 77
circuit type, 26, 27, 33, 46, 112, 116
Common Circuit Connections, 22, 93, 104
Connection guidelines, 98
Current, 100, 103, 107, 124, 126
current probes, 25, 27, 47, 50, 77, 80, 82, 101, 106, 114
Current Transformer, 47, 48
Customer Service, 71, 77, 78

D

Daily Peak, 57, 59, 60
data memory card, 3, 4, 5, 7, 9, 22, 39, 40, 41, 42, 43, 61, 62, 135
Default, 91
Delta
 floating,, 118
 high-leg,, 116
 open, 112
Demand, 1, 51, 56, 57, 59, 60, 85
display mode, 37

E

Easy Start, xvii, 5, 17, 19, 21, 22, 25, 30, 31, 33, 36, 37, 46, 47, 50
email address, 71
energy, x, 1, 3, 4, 50, 51, 56, 57, 81, 82, 83
Energy Rate Limit, 51, 59
Error messages, 139, 141
Event, 43, 56, 59, 61, 86
event types, 56

F

Factory, 91
Fill and Stop, 40, 41, 44
Floating or Grounded Delta, 118
Four wire wye, 4, 104, 122

G

grounded delta, 4, 104, 118, 122

H

Handbook, 81
Harmonics, 3, 4, 24, 31, 53, 63, 68, 69, 80, 82, 83
Help, 9, 18, 140
High leg delta, 4, 104
Hotline, 71

I

Internal Battery, 73
internal memory, 3, 4, 39, 40, 41, 43, 44, 50, 56, 63, 74
Isolated Current Transformer (ISO), 126

L

LCD
 specifications, 87
LCD BACKLIGHT AUTO-SHUTOFF, 38

M

Measurement cable set, 97
Memory, 3, 5, 35, 38, 39, 41, 42, 43, 44, 45, 61, 63, 74, 79, 80, 81, 82,
 86, 91, 131, 132, 135, 136
memory card, 1, 5, 81
Memory Card Battery Replacement, 131
Memory Card Functions screen, 42
Memory Functions, 42
Messages
 descriptions, 141
 priority, 139
Meter Mode, 24, 31, 32, 33, 53, 57, 64
Midnight Summary, 60
Monthly Peak, 57

N

Neutral to ground connection example, 99

O

Open leg delta, 4, 104, 122

optical interface port, 7

Optional Accessories, 79

Overwrite, 40, 41, 44, 91

P

Potential Transformer, 47

Power, 110, 111, 112, 116, 118

Power Factor, 1, 90

PP4300, xvii, 1, 22, 23, 24, 26, 39, 43, 73, 85, 91

Probes, 2, 4, 21, 22, 27, 28, 93

Programmable Features, 35, 36, 37

R

read and write event and setup data, 42

Reading the Auto-transfer file, 61

Replaceable Parts, 137

Return Shipment, 73, 77

S

Saving/Reading Data, 43

scale factor, 18, 24, 47, 48, 124, 126

Scale Factor Calculation - Example, 48

Scope Mode, ix, 24, 25, 31, 32, 33, 36, 47, 51, 54, 69, 132

Self Test, 63

Set Input Configurations, 46

Setup Menu, 25, 35, 36, 38, 45, 46, 51, 132

Shipping Address, 78

Single phase, 4, 91, 103, 104, 107

Single phase connection example, 98, 110

Spare, 137

Specifications

 computed, 89

 interfaces, 87

 measured, 87

Split phase connection example, 111

Split phase, 4, 104, 107

Standard Accessories, 2

sync mode, 49

T

Task 808, i, ix, xvii, 2, 3, 4, 5, 12, 15, 19, 22, 24, 26, 36, 38, 56, 68, 82, 112, 116, 120, 135

TASKCard, ix, 2, 3, 4, 7, 9, 12, 13, 22, 23, 80, 82, 83, 88, 142
error messages, 142
optional, 82

technical support, 71

time and date, 24, 37, 49, 50

Time Plot, 54, 55

Two-and-a-half Element, 120

V

View Data menu, 54

Voltage, 98, 99, 107, 123

W

waveforms, 31, 81

Web page, 71