



**Advanced Test Equipment Rentals**  
**www.atecorp.com 800-404-ATEC (2832)**

## **User Manual**

**Tektronix**

**TLS 216**  
**Logic Scope**  
**070-8834-01**

This document supports firmware version 1.0.2e  
and above.

## Instrument Serial Numbers

Each instrument manufactured by Tektronix has a serial number on a panel insert or tag, or stamped on the chassis. The first letter in the serial number designates the country of manufacture. The last five digits of the serial number are assigned sequentially and are unique to each instrument. Those manufactured in the United States have six unique digits. The country of manufacture is identified as follows:

B010000	Tektronix, Inc., Beaverton, Oregon, USA
E200000	Tektronix United Kingdom, Ltd., London
J300000	Sony/Tektronix, Japan
H700000	Tektronix Holland, NV, Heerenveen, The Netherlands

Instruments manufactured for Tektronix by external vendors outside the United States are assigned a two digit alpha code to identify the country of manufacture (e.g., JP for Japan, HK for Hong Kong, IL for Israel, etc.).

Tektronix, Inc., P.O. Box 500, Beaverton, OR 97077

Printed in U.S.A.

Copyright © Tektronix, Inc., 1993. All rights reserved. Tektronix products are covered by U.S. and foreign patents, issued and pending. The following are registered trademarks: TEKTRONIX, TEK, TEKPROBE, and SCOPE-MOBILE. BusForm, GURU, and QUICKCLIP are trademarks of Tektronix.

Epson is a registered trademark of Epson America, Inc.

Deskjet, Laserjet, and Thinkjet are registered trademarks of Hewlett-Packard Corporation.

GPIB-PCII and GPIB-PCIIA are registered trademarks of National Instruments Corporation.

HP is a registered trademark of Hewlett-Packard Corporation.

IBM is a registered trademark of International Business Machines.

Interleaf is a trademark of Interleaf, Inc.

Microsoft is a registered trademark of Microsoft Corporation.

PostScript is a registered trademark of Adobe Systems Incorporated.

## TLS 216 WARRANTY

Tektronix warrants that this product will be free from defects in materials and workmanship for a period of three (3) years from the date of shipment. If any such product proves defective during this warranty period, Tektronix, at its option, either will repair the defective product without charge for parts and labor, or will provide a replacement in exchange for the defective product.

In order to obtain service under this warranty, Customer must notify Tektronix of the defect before the expiration of the warranty period and make suitable arrangements for the performance of service. Customer shall be responsible for packaging and shipping the defective product to the service center designated by Tektronix, with shipping charges prepaid. Tektronix shall pay for the return of the product to Customer if the shipment is to a location within the country in which the Tektronix service center is located. Customer shall be responsible for paying all shipping charges, duties, taxes, and any other charges for products returned to any other locations.

This warranty shall not apply to any defect, failure or damage caused by improper use or improper or inadequate maintenance and care. Tektronix shall not be obligated to furnish service under this warranty a) to repair damage resulting from attempts by personnel other than Tektronix representatives to install, repair or service the product; b) to repair damage resulting from improper use or connection to incompatible equipment; or c) to service a product that has been modified or integrated with other products when the effect of such modification or integration increases the time or difficulty of servicing the product.

**THIS WARRANTY IS GIVEN BY TEKTRONIX WITH RESPECT TO THIS PRODUCT IN LIEU OF ANY OTHER WARRANTIES, EXPRESSED OR IMPLIED. TEKTRONIX AND ITS VENDORS DISCLAIM ANY IMPLIED WARRANTIES OF MERCHANTABILITY OR FITNESS FOR A PARTICULAR PURPOSE. TEKTRONIX' RESPONSIBILITY TO REPAIR OR REPLACE DEFECTIVE PRODUCTS IS THE SOLE AND EXCLUSIVE REMEDY PROVIDED TO THE CUSTOMER FOR BREACH OF THIS WARRANTY. TEKTRONIX AND ITS VENDORS WILL NOT BE LIABLE FOR ANY INDIRECT, SPECIAL, INCIDENTAL, OR CONSEQUENTIAL DAMAGES IRRESPECTIVE OF WHETHER TEKTRONIX OR THE VENDOR HAS ADVANCE NOTICE OF THE POSSIBILITY OF SUCH DAMAGES.**

## P6240 WARRANTY

Tektronix warrants that this product will be free from defects in materials and workmanship for a period of one (1) year from the date of shipment. If any such product proves defective during this warranty period, Tektronix, at its option, either will repair the defective product without charge for parts and labor, or will provide a replacement in exchange for the defective product.

In order to obtain service under this warranty, Customer must notify Tektronix of the defect before the expiration of the warranty period and make suitable arrangements for the performance of service. Customer shall be responsible for packaging and shipping the defective product to the service center designated by Tektronix, with shipping charges prepaid. Tektronix shall pay for the return of the product to Customer if the shipment is to a location within the country in which the Tektronix service center is located. Customer shall be responsible for paying all shipping charges, duties, taxes, and any other charges for products returned to any other locations.

This warranty shall not apply to any defect, failure or damage caused by improper use or improper or inadequate maintenance and care. Tektronix shall not be obligated to furnish service under this warranty a) to repair damage resulting from attempts by personnel other than Tektronix representatives to install, repair or service the product; b) to repair damage resulting from improper use or connection to incompatible equipment; or c) to service a product that has been modified or integrated with other products when the effect of such modification or integration increases the time or difficulty of servicing the product.

**THIS WARRANTY IS GIVEN BY TEKTRONIX WITH RESPECT TO THIS PRODUCT IN LIEU OF ANY OTHER WARRANTIES, EXPRESSED OR IMPLIED. TEKTRONIX AND ITS VENDORS DISCLAIM ANY IMPLIED WARRANTIES OF MERCHANTABILITY OR FITNESS FOR A PARTICULAR PURPOSE. TEKTRONIX' RESPONSIBILITY TO REPAIR OR REPLACE DEFECTIVE PRODUCTS IS THE SOLE AND EXCLUSIVE REMEDY PROVIDED TO THE CUSTOMER FOR BREACH OF THIS WARRANTY. TEKTRONIX AND ITS VENDORS WILL NOT BE LIABLE FOR ANY INDIRECT, SPECIAL, INCIDENTAL, OR CONSEQUENTIAL DAMAGES IRRESPECTIVE OF WHETHER TEKTRONIX OR THE VENDOR HAS ADVANCE NOTICE OF THE POSSIBILITY OF SUCH DAMAGES.**



## EC Declaration of Conformity

We

Tektronix Holland N.V.  
Marktweg 73A  
8444 AB Heerenveen  
The Netherlands

declare under sole responsibility that the

***TLS 216 Logic Scope***

meets the intent of Directive 89/336/EEC for Electromagnetic Compatibility.  
Compliance was demonstrated to the following specifications as listed in the Official  
Journal of the European Communities:

EN 50081-1 Emissions:

EN 55022      Class B Radiated and Conducted Emissions  
EN 60555-2    AC Power Line Harmonic Emissions

EN 50082-1 Immunity:

IEC 801-2      Electrostatic Discharge Immunity  
IEC 801-3      RF Electromagnetic Field Immunity  
IEC 801-4      Electrical Fast Transient/Burst Immunity  
IEC 801-5      Power Line Surge Immunity



# Table of Contents

<b>List of Figures</b> .....	<b>iii</b>
<b>List of Tables</b> .....	<b>vii</b>
<b>Safety Summary</b> .....	<b>ix</b>
<b>Preface</b> .....	<b>xi</b>
<b>Getting Started</b>	
<b>Product Description</b> .....	<b>1-1</b>
<b>Start Up</b> .....	<b>1-3</b>
<b>Setting Up for Examples</b> .....	<b>1-7</b>
<b>Example 1: Displaying Waveforms</b> .....	<b>1-11</b>
<b>Example 2: Grouping Waveforms</b> .....	<b>1-17</b>
<b>Example 3: Taking Measurements Automatically</b> .....	<b>1-23</b>
<b>Example 4: Saving Setups</b> .....	<b>1-29</b>
<b>Operating Basics</b>	
<b>Overview</b> .....	<b>2-1</b>
<b>At a Glance</b> .....	<b>2-3</b>
<b>Triggering</b> .....	<b>2-13</b>
<b>Acquisition</b> .....	<b>2-19</b>
<b>Scaling and Positioning Waveforms</b> .....	<b>2-23</b>
<b>Measurements</b> .....	<b>2-27</b>
<b>Reference</b>	
<b>Overview</b> .....	<b>3-1</b>
<b>Adjusting the Horizontal Setup</b> .....	<b>3-3</b>
<b>Adjusting the Vertical Setup</b> .....	<b>3-7</b>
<b>Autosetting the Logic Scope</b> .....	<b>3-13</b>
<b>Choosing an Acquisition Mode</b> .....	<b>3-17</b>
<b>Choosing a Group Display Mode</b> .....	<b>3-23</b>
<b>Communicating with Remote Instruments</b> .....	<b>3-31</b>
<b>Customizing the Display</b> .....	<b>3-35</b>
<b>Customizing the Display Colors</b> .....	<b>3-41</b>
<b>Doing a Probe Cal</b> .....	<b>3-49</b>
<b>Doing a Signal Path Compensation</b> .....	<b>3-53</b>
<b>Grouping Waveforms</b> .....	<b>3-55</b>
<b>Managing the File System</b> .....	<b>3-61</b>

<b>Measuring Waveforms Automatically</b> .....	<b>3-67</b>
<b>Measuring Waveforms with Cursors</b> .....	<b>3-81</b>
<b>Printing a Hardcopy</b> .....	<b>3-87</b>
<b>Probing of Circuits</b> .....	<b>3-97</b>
<b>Saving and Recalling Setups</b> .....	<b>3-105</b>
<b>Saving and Recalling Waveforms</b> .....	<b>3-109</b>
<b>Selecting Groups and Channels</b> .....	<b>3-117</b>
<b>Triggering After Delay</b> .....	<b>3-121</b>
<b>Triggering on Edges</b> .....	<b>3-127</b>
<b>Triggering on Patterns</b> .....	<b>3-131</b>
<b>Triggering on Pulses</b> .....	<b>3-141</b>
<b>Triggering on a Sequence</b> .....	<b>3-147</b>
<b>Triggering on Signals</b> .....	<b>3-159</b>
<b>Triggering on States</b> .....	<b>3-165</b>
<b>Viewing Help</b> .....	<b>3-171</b>
<b>Viewing Status</b> .....	<b>3-173</b>
<b>Zooming on Waveforms</b> .....	<b>3-175</b>

## **Appendices**

<b>Appendix A: Options and Accessories</b> .....	<b>A-1</b>
<b>Appendix B: Algorithms</b> .....	<b>B-1</b>
<b>Appendix C: Packaging for Shipment</b> .....	<b>C-1</b>
<b>Appendix D: Factory Initialization Settings</b> .....	<b>D-1</b>

## **Glossary**

## **Index**



# List of Figures

<b>Figure 1-1: Rear Panel Controls Used in Start Up</b> .....	1-4
<b>Figure 1-2: ON/STBY Button</b> .....	1-5
<b>Figure 1-3: Probe Connections for the Examples</b> .....	1-7
<b>Figure 1-4: SETUP Button Location</b> .....	1-8
<b>Figure 1-5: The Setup Menu</b> .....	1-8
<b>Figure 1-6: Trigger Controls</b> .....	1-9
<b>Figure 1-7: The Display After Factory Initialization</b> .....	1-10
<b>Figure 1-8: The Group Buttons and LEDs</b> .....	1-11
<b>Figure 1-9: Group Readouts</b> .....	1-13
<b>Figure 1-10: The VERTICAL and HORIZONTAL Controls</b> .....	1-14
<b>Figure 1-11: TRIGGER Controls</b> .....	1-15
<b>Figure 1-12: AUTOSET Button Location</b> .....	1-15
<b>Figure 1-13: The Display After Pressing Autoset</b> .....	1-16
<b>Figure 1-14: Vertical Waveform Groups</b> .....	1-18
<b>Figure 1-15: Group 6 Displayed as a Timing Diagram</b> .....	1-20
<b>Figure 1-16: Binary Value of a Group</b> .....	1-21
<b>Figure 1-17: Measure Main Menu and Select Measurement Side Menu</b> .....	1-24
<b>Figure 1-18: Four Simultaneous Measurement Readouts</b> .....	1-25
<b>Figure 1-19: General Purpose Knob Indicators</b> .....	1-26
<b>Figure 1-20: Snapshot of Channel 2</b> .....	1-28
<b>Figure 1-21: Save/Recall Setup Menu</b> .....	1-30
<b>Figure 2-1: Triggered Versus Untriggered Displays</b> .....	2-13
<b>Figure 2-2: Trigger Holdoff Time Ensures Valid Triggering</b> .....	2-16
<b>Figure 2-3: Slope and Level Controls Help Define the Trigger</b> .....	2-17
<b>Figure 2-4: Acquisition: Input Analog Signal, Sample, and Digitize</b> .....	2-19
<b>Figure 2-5: Real-Time Sampling</b> .....	2-20
<b>Figure 2-6: Scaling and Positioning</b> .....	2-23
<b>Figure 2-7: Aliasing</b> .....	2-25
<b>Figure 2-8: Graticule, Cursor, and Automated Measurements</b> .....	2-27
<b>Figure 2-9: Cursor Modes</b> .....	2-28
<b>Figure 3-1: Horizontal Controls</b> .....	3-3
<b>Figure 3-2: Record View and Time Base Readout</b> .....	3-4
<b>Figure 3-3: Vertical Controls</b> .....	3-8

Figure 3-4: Vertical Readout and Vertical Controls Menu .....	3-10
Figure 3-5: How the Acquisition Modes Work .....	3-18
Figure 3-6: Acquisition Menu and Readout .....	3-19
Figure 3-7: Acquire Menu — Stop After .....	3-20
Figure 3-8: Display Modes .....	3-24
Figure 3-9: Snapshot of Group Status .....	3-25
Figure 3-10: Group Display Mode Menu .....	3-26
Figure 3-11: Group Display Mode Set to Analog Select .....	3-27
Figure 3-12: Typical GPIB Network Configuration .....	3-32
Figure 3-13: Stacking GPIB Connectors .....	3-32
Figure 3-14: Connecting the Logic Scope to a Controller .....	3-33
Figure 3-15: Utility Menu .....	3-34
Figure 3-16: Snapshot of Display Status .....	3-35
Figure 3-17: Display Menu — Style Settings .....	3-36
Figure 3-18: Trigger Point and Level Indicators .....	3-38
Figure 3-19: Snapshot of Display Status .....	3-41
Figure 3-20: Display Menu — Color Settings .....	3-42
Figure 3-21: Display Menu — Change Colors .....	3-44
Figure 3-22: Display Menu — Map Group Colors .....	3-45
Figure 3-23: Display Menu — Restore Colors .....	3-46
Figure 3-24: Probe Cal Menu and Probe Cal Display .....	3-51
Figure 3-25: Performing a Signal Path Compensation .....	3-54
Figure 3-26: Groups — Valid and Invalid .....	3-56
Figure 3-27: Vertical Readout Displaying Two Group Readouts ....	3-57
Figure 3-28: The Group Definition Menu .....	3-58
Figure 3-29: File Utilities Menu and Listing .....	3-62
Figure 3-30: File System — Labelling Menu .....	3-64
Figure 3-31: Measurement Readouts .....	3-68
Figure 3-32: Measure Menu .....	3-71
Figure 3-33: Measure Menu — Gating .....	3-72
Figure 3-34: Measure Menu — Reference Levels .....	3-74
Figure 3-35: Measure Delay Menu — Delay To .....	3-75
Figure 3-36: Measure Setup Menu .....	3-77
Figure 3-37: Snapshot Menu and Readout .....	3-79
Figure 3-38: Cursor Types .....	3-81
Figure 3-39: Cursor Modes .....	3-82
Figure 3-40: Vertical Bar Cursor Readout (With Binary Readout) ..	3-83
Figure 3-41: Cursor Menu and Readouts — Paired Cursors Selected .....	3-84

<b>Figure 3-42: Utility Menu — System I/O</b> .....	3-88
<b>Figure 3-43: Hardcopy Formats</b> .....	3-89
<b>Figure 3-44: Date and Time Display</b> .....	3-90
<b>Figure 3-45: Connecting the Logic Scope Directly to the Hardcopy Device</b> .....	3-91
<b>Figure 3-46: Connecting the Logic Scope and Hardcopy Device Via a PC</b> .....	3-93
<b>Figure 3-47: Basic Probe Connection</b> .....	3-98
<b>Figure 3-48: Installing Accessories — Standard and Optional</b> .....	3-99
<b>Figure 3-49: A Probe Adds Resistance, Capacitance, and Inductance</b> .....	3-103
<b>Figure 3-50: Signal Variation Introduced by Probe Ground Lead (1 ns/division)</b> .....	3-103
<b>Figure 3-51: Save/Recall Setup Menu</b> .....	3-105
<b>Figure 3-52: Save Group Menu</b> .....	3-111
<b>Figure 3-53: Save Group to File Menu</b> .....	3-112
<b>Figure 3-54: More Menu for Displaying Reference Groups</b> .....	3-113
<b>Figure 3-55: The Vertical Readout</b> .....	3-118
<b>Figure 3-56: Delayed Runs After Main</b> .....	3-121
<b>Figure 3-57: Delayed Triggerable</b> .....	3-122
<b>Figure 3-58: How the Delayed Triggers Work</b> .....	3-123
<b>Figure 3-59: Delayed Trigger Menu</b> .....	3-125
<b>Figure 3-60: Snapshot of Trigger Status</b> .....	3-128
<b>Figure 3-61: Main Trigger Menu — Edge Type</b> .....	3-129
<b>Figure 3-62: Snapshot of Trigger Status</b> .....	3-134
<b>Figure 3-63: Pattern Trigger Menu</b> .....	3-135
<b>Figure 3-64: Triggering on a Pattern: Time Out Qualified</b> .....	3-137
<b>Figure 3-65: Time-Qualified Pattern Triggering: &gt; Time</b> .....	3-138
<b>Figure 3-66: Pulse Trigger Readouts</b> .....	3-142
<b>Figure 3-67: Pulse Trigger Menu</b> .....	3-143
<b>Figure 3-68: Trigger Readout</b> .....	3-150
<b>Figure 3-69: Sequence Trigger Menu</b> .....	3-151
<b>Figure 3-70: Triggering on a Sequence: &gt; Time, Minimum Time Qualification</b> .....	3-155
<b>Figure 3-71: Time-Qualified Pattern Triggering: Time Out</b> .....	3-156
<b>Figure 3-72: TRIGGER Controls and Status Lights</b> .....	3-159
<b>Figure 3-73: Trigger Type, Record View, Trigger Position, and Trigger Level Bar Readouts</b> .....	3-161
<b>Figure 3-74: Snapshot of Trigger Status</b> .....	3-166
<b>Figure 3-75: State Trigger Menu</b> .....	3-167

<b>Figure 3-76: Initial Help Screen</b> .....	<b>3-171</b>
<b>Figure 3-77: Status Menu — System</b> .....	<b>3-173</b>
<b>Figure 3-78: Zoom Mode with Horizontal Lock Set to All</b> .....	<b>3-177</b>
<b>Figure B-1: MCross Calculations</b> .....	<b>B-4</b>
<b>Figure B-2: Fall Time</b> .....	<b>B-7</b>
<b>Figure B-3: Hold Time</b> .....	<b>B-8</b>
<b>Figure B-4: Rise Time</b> .....	<b>B-12</b>
<b>Figure B-5: Setup Time</b> .....	<b>B-14</b>
<b>Figure B-6: Skew Time</b> .....	<b>B-15</b>
<b>Figure B-7: Choosing Minima or Maxima to Use for Envelope Measurements</b> .....	<b>B-16</b>

## List of Tables

<b>Table 1–1: Fuse and Fuse Cap Part Numbers</b> .....	<b>1–4</b>
<b>Table 3–1: Autoset Defaults</b> .....	<b>3–15</b>
<b>Table 3–2: Logic Family Presets</b> .....	<b>3–29</b>
<b>Table 3–3: Measurement Definitions</b> .....	<b>3–68</b>
<b>Table 3–4: Probe-Related Accessories</b> .....	<b>3–100</b>
<b>Table 3–5: Group Selection Priority</b> .....	<b>3–120</b>
<b>Table 3–6: Logic Qualifiers</b> .....	<b>3–131</b>
<b>Table 3–7: Time Qualifiers</b> .....	<b>3–132</b>
<b>Table 3–8: Pulse Trigger Definitions</b> .....	<b>3–142</b>
<b>Table 3–9: Logic Functions</b> .....	<b>3–148</b>
<b>Table 3–10: Time Qualifiers</b> .....	<b>3–148</b>
<b>Table 3–11: State Triggers</b> .....	<b>3–165</b>
<b>Table 3–12: Zoom Defaults</b> .....	<b>3–178</b>
<b>Table A–1: International Power Cords</b> .....	<b>A–1</b>
<b>Table A–2: Standard Accessories</b> .....	<b>A–2</b>
<b>Table A–3: Optional Accessories</b> .....	<b>A–3</b>
<b>Table A–4: Accessory Software</b> .....	<b>A–4</b>
<b>Table D–1: Factory Initialization Defaults</b> .....	<b>D–1</b>



# Safety Summary

Please take a moment to review these safety precautions. They are provided for your protection and to prevent damage to the logic scope. This safety information applies to all operators and service personnel.

## Symbols and Terms

These two terms appear in manuals:



---

**CAUTION.** These statements identify conditions or practices that could result in damage to the equipment or other property.

---



---

**WARNING.** These statements identify conditions or practices that could result in personal injury or loss of life.

---

These two terms appear on equipment:

- **CAUTION** indicates a personal injury hazard not immediately accessible as one reads the marking or a hazard to property including the equipment itself.
- **DANGER** indicates a personal injury hazard immediately accessible as one reads the marking.

This symbol appears in manuals:



Static-Sensitive Devices

These symbols appear on equipment:



**DANGER**  
High Voltage



Protective ground  
(earth) terminal



**ATTENTION**  
Refer to  
manual

## Specific Precautions

Observe all of these precautions to ensure your personal safety and to prevent damage to either the logic scope or equipment connected to it.

### **Power Source**

The logic scope is intended to operate from a power source that will not apply more than 250 V<sub>RMS</sub> between the supply conductors or between either supply conductor and ground. A protective ground connection, through the grounding conductor in the power cord, is essential for safe system operation.

### **Grounding the Logic Scope**

The logic scope is grounded through the power cord. To avoid electric shock, plug the power cord into a properly wired receptacle where earth ground has been verified by a qualified service person. Do this before making connections to the input or output terminals of the logic scope.

Without the protective ground connection, all parts of the logic scope are potential shock hazards. This includes knobs and controls that may appear to be insulators.

### **Use the Proper Power Cord**

Use only the power cord and connector specified for your product. Use only a power cord that is in good condition.

### **Use the Proper Fuse**

To avoid fire hazard, use only the fuse specified in the parts list for your product, matched by type, voltage rating, and current rating.

### **Do Not Remove Covers or Panels**

To avoid personal injury, do not operate the logic scope without the panels or covers.

### **Electric Overload**

Never apply a voltage to a connector on the logic scope that is outside the voltage range specified for that connector.

### **Do Not Operate in Explosive Atmospheres**

The logic scope provides no explosion protection from static discharges or arcing components. Do not operate the logic scope in an atmosphere of explosive gases.

### **Provide Proper Ventilation**

To prevent overheating, keep the logic scope ventilation holes free from obstruction.

### **Do Not Operate With Suspected Failures**

If you suspect the logic scope is damaged, have it inspected by a qualified service person.



# Preface

This is the User Manual for the TLS 216 Logic Scope.

Section 1 *Getting Started* familiarizes you with the operation of your logic scope.

Section 2 *Operating Basics* covers basic principles of the operation of the logic scope. The topics covered help you understand why your logic scope operates the way it does.

Section 3 *Reference* teaches you how to perform specific tasks. See page 3–1 for a complete list of tasks covered in that section.

The *Appendices* provide an options listing, an accessories listing, and other useful information.

## Conventions

In the *Getting Started* and *Reference* sections, you will find various procedures which contain steps of instructions for you to perform. To keep those instructions clear and consistent, this manual uses the following conventions:

- Names of front-panel controls and menu labels appear in boldface print.
- Names also appear in the same case (initial capitals, all uppercase, etc.) in the manual as is used on the logic scope front panel and menus. Front panel names are all upper case letters, for example, **GROUP MENU** and **GROUP 1**.
- Instruction steps are numbered. The number is omitted if there is only one step.
- When steps require that you make a sequence of selections using front-panel controls and menu buttons, an arrow ( → ) marks each transition between a front panel button and a menu, or between menus. Also, whether a name is a main menu or side menu item is clearly indicated: Press **HORIZONTAL MENU** → **Record Length** (main) → **500 points in 10 divs** (side) → **Trigger Position** (main) → **Set to 20%** (side).

Using the convention just described results in instructions that are graphically intuitive and simplifies procedures. For example, the instruction just given replaces these five steps:

1. Press the front-panel button **HORIZONTAL MENU**.
2. Press the main menu button **Record Length**.

3. Press the side menu button **500 points in 10 divs**.
4. Press the main menu button **Trigger Position**
5. Press the side menu button **Set to 20%**

Sometimes you may have to make a selection from a popup menu: Press **TRIGGER MENU** → **Type** (main) → **Edge** (pop-up). In this example, you repeatedly press the main menu button **Type** until **Edge** is highlighted in the pop-up menu.

## Related Manuals

The following documents are related to the use or service of the logic scope.

- The *TLS 216 Programmer Manual* (Tektronix part number 070-8835-XX) describes using a computer to control the logic scope through the GPIB interface.
- The *TLS 216 Reference* (Tektronix part number 070-8833-XX) gives you a quick overview of how to operate your logic scope.
- The *TLS 216 Performance Verification and Specifications Technical Reference* (Tektronix part number 070-8832-XX) tells how to verify the performance of the logic scope.
- The *TLS 216 Service Manual* (Tektronix part number 070-8831-XX) provides information for maintaining and servicing your logic scope to the module level.



# Product Description

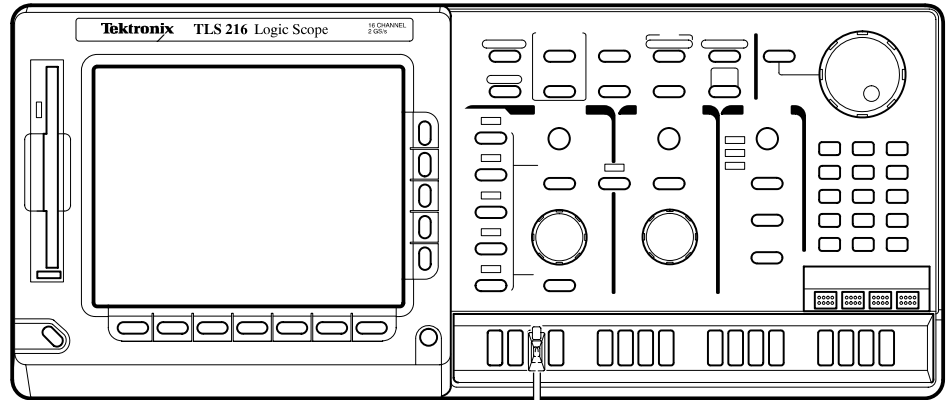

The Tektronix TLS 216 Logic Scope is a superb tool for analyzing and debugging digital circuits. Its performance addresses the needs of digital designers and troubleshooters of such circuits with the following features:

- sixteen channels, equipped with sixteen 2.5 pF FET probes, for acquiring waveforms from digital circuits
- three display modes — displays analog waveforms, digital BusForms, and dual-threshold timing diagrams
- four threshold level presets based on four logic families, TTL, CMOS, +ECL, and -ECL, for deriving digital levels for BusForm™ and timing diagram displays
- five trigger types — Edge, Pulse, Pattern, State, and Sequence
- 500 MHz maximum bandwidth, a 2 Gigasamples/second maximum digitizing rate, eight-bit digitizers, and up to a 2,000-sample record length per channel
- full GPIB software programmability and hardcopy output using GPIB, RS-232, or Centronics ports
- complete measurement and documentation capability
- intuitive operation using graphic icons and the more familiar and traditional horizontal and vertical knobs
- on-line help at the touch of a button

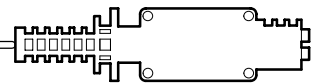

## Product Specification

The product specification is found in the *TLS 216 Performance Verification and Specifications Technical Reference* which is shipped as a standard accessory with the TLS 216 Logic Scope.

# Start Up

Before you use the TLS 216 Logic Scope, ensure that it is properly installed and powered on.

## Before You Begin

To ensure maximum accuracy for your most critical measurements, you should know about signal path compensation.

Be sure you compensate your logic scope for the surrounding temperature. This action, called *Signal Path Compensation (SPC)*, ensures maximum possible accuracy for your most critical measurements. See *Doing a Signal Path Compensation* on page 3–53 for a description of use and operation of this feature.

## Operation

To properly install and power on the logic scope, do the following tasks.

### Installation

1. Be sure you have the appropriate operating environment. Specifications for temperature, relative humidity, altitude, vibrations, and emissions are included in the manual *TLS 216 Performance Verification and Specification* shipped with this logic scope.
2. Leave space for cooling. Do this task by verifying that the air intake and exhaust holes on the sides of the cabinet (where the fan operates) are free of any airflow obstructions. Leave at least 5.1 cm (2 inches) free on each side.



---

**WARNING.** To avoid electrical shock, be sure that the power cord is disconnected before checking the fuse.

---

3. Check the fuse to be sure it is the proper type and rating (stated on rear panel). You can use either of two fuses. (See Figure 1-1 for fuse location.) Each fuse requires its own cap. (See Table 1–1.) The logic scope is shipped with the UL approved fuse installed.
4. Check that you have the proper electrical connections. The logic scope requires 90 to 250 VAC<sub>RMS</sub>, continuous range, 47 Hz to 63 Hz, and may require up to 300 W.

5. Connect the proper power cord from the rear-panel power connector (see Figure 1-1) to the power system.

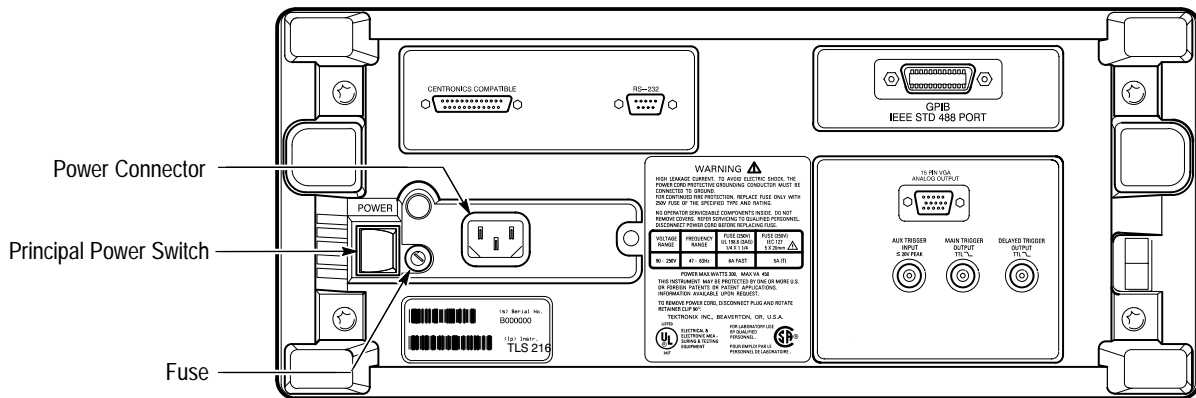

Figure 1-1: Rear Panel Controls Used in Start Up

Table 1-1: Fuse and Fuse Cap Part Numbers

Fuse	Fuse Part Number	Fuse Cap Part Number
.25 inch × 1.25 inch (UL 198.6, 3AG); 6 A FAST, 250 V.	159-0013-00	200-2264-00
5 mm × 20 mm (IEC 127); 5 A (T), 250 V.	159-0210-00	200-2265-00

6. Remove the front cover by grasping its left and right edges and snapping it off of the front subpanel. (When reinstalling, align and snap back on.)

**Power On**

1. Check that the rear-panel principal power switch is on. (See Figure 1-1.) The principal power switch controls all AC power to the instrument.
2. If the logic scope is not powered on (the screen is blank), press the front-panel **ON/STBY** button to toggle it on. (See Figure 1-2.)

The ON/STBY button controls power to most of the instrument circuits. Power continues to go to certain parts even when this switch is set to STBY.

Once the logic scope is installed, it is typical to leave the principal power switch on and use the ON/STBY button as the power switch.

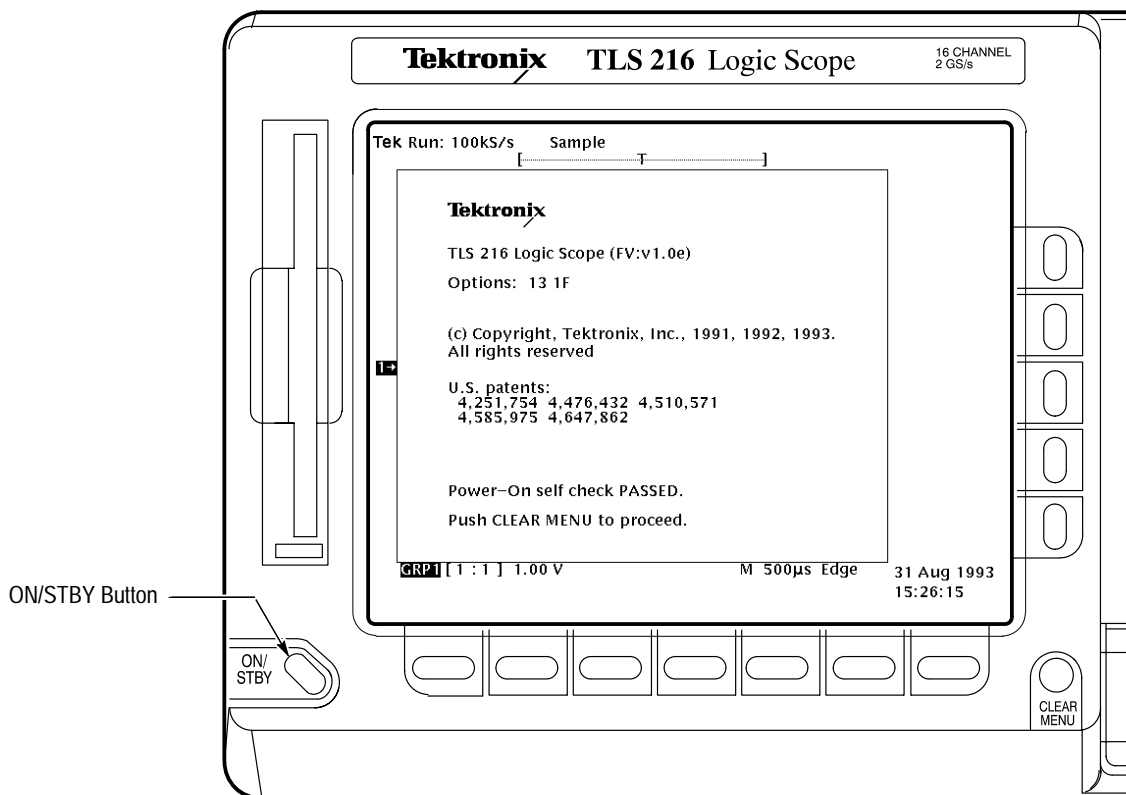

Figure 1-2: ON/STBY Button

**Self Test** Check the self test results. The logic scope automatically performs power-up tests each time it is turned on. It will display a status screen that states whether or not it passed self test. (If the self test passed, the logic scope removes the status display screen after a few seconds.)

If the self test fails, call your local Tektronix Service Center. Depending on the type of failure, you may still be able to use the logic scope before it is serviced.

**Power Off** Press the **ON/STBY** switch to turn off the logic scope.





# Setting Up for Examples

Perform the following tasks to connect input signals to the TLS 216 Logic Scope, to reset it, and to become acquainted with its display screen. Once completed, these tasks ready the logic scope for use in the examples that follow.

Perform the examples that follow this subsection to learn how to display and measure waveforms with the logic scope.

## Connect the Input Signals

Do the following steps to couple input signals to the logic scope for use in the examples.

1. Remove all probes and signal inputs from the 16 input connectors along the lower right of the front panel.
2. Connect a probe to each of the Channel 1 through Channel 4 inputs using four of the probes supplied with the logic scope. (See Figure 1-3.)
3. Connect the input of the four probes to any four of the 16 probe calibration outputs. (See Figure 1-3). Be sure to connect so the positive terminal of the each probe (indicated by three ribs at the end of the probe tip) goes to the positive (upper) terminal of the probe calibration output.

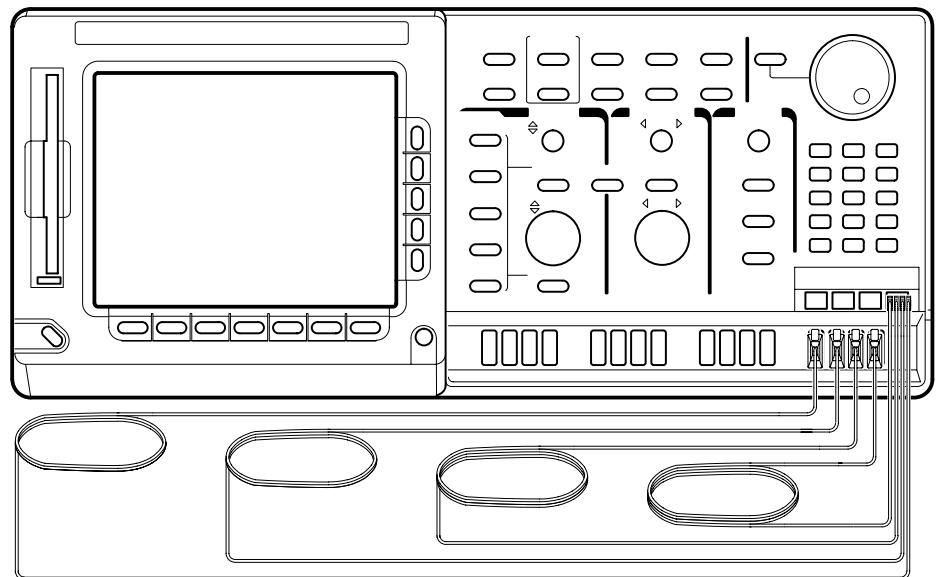

Figure 1-3: Probe Connections for the Examples

## Reset the Logic Scope

Do the following steps to reset the logic scope to a known factory default state before doing the examples. (You can reset the logic scope anytime you begin a new task and need to “start fresh” with known default settings.)

1. Press the save/recall **SETUP** button to display the Setup menu (Figure 1-4).

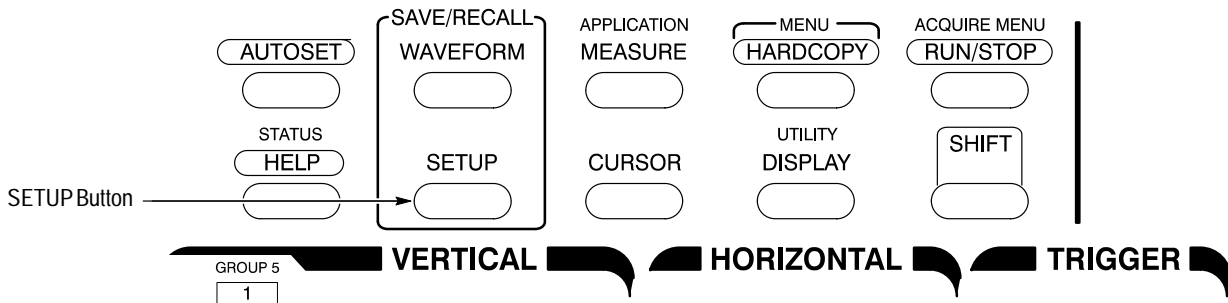

Figure 1-4: SETUP Button Location

The logic scope displays *main menus* along the bottom of the screen. Figure 1-5 shows the Setup main menu.

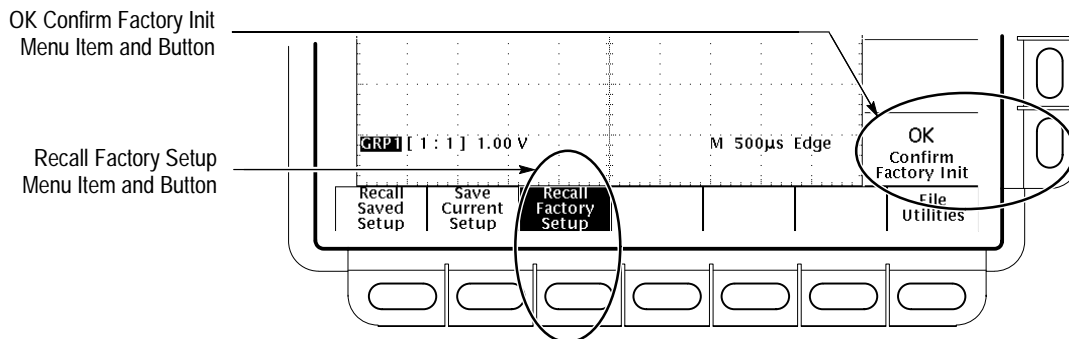

Figure 1-5: The Setup Menu

2. Press the button directly below the **Recall Factory Setup** menu item.

The display shows *side menus* along the right side of the screen. The buttons to select these side menu items are to the right of the side menu.

Because an accidental instrument reset could destroy a setup that took a long time to create, the logic scope asks you to verify the Recall Factory Setup selection. (See Figure 1-5.)

3. Press the button to the right of the **OK Confirm Factory Init** side menu item.

---

**NOTE.** This manual uses the following notation to represent the sequence of selections you made in steps 1, 2 and 3: Press save/recall **SETUP** → **Recall Factory Setup** (main) → **OK Confirm Factory Init** (side).

---



Note that a clock icon appears on screen. The logic scope displays this icon when performing operations that take longer than several seconds.

4. Press **SET LEVEL TO 50%** to be sure the logic scope triggers on the input signal. (See Figure 1-6.)

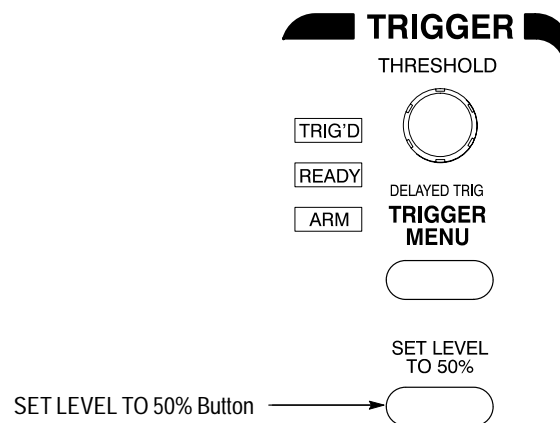

Figure 1-6: Trigger Controls

## Examine the Display Elements

Read the following information to become familiar with the logic scope display before doing the examples.

Figure 1-7 shows the display that results from the instrument reset. Note the following characteristics.

The *logic scope* always displays a single group (Group 1) which contains only one channel (Channel 1) after a reset.

The *trigger threshold bar* shows that the logic scope triggered the waveform at a threshold level near 50% of its amplitude (from step 4).

The *trigger position indicator* shows that the trigger position of the waveform is located at the horizontal center of the graticule.

The *group reference indicator* shows the vertical position of any channels that Group 1 contains when the channels have no input signal. For the current group display mode (Analog), this indicator points to the ground level for all channels in the group when vertical offset is set to 0 V in the group menu; when vertical offset is *not* set to 0 V, it points to the vertical offset level.

The *trigger readout* shows that the logic scope triggers using the edge of a signal (rising or falling signal transitions that pass through the trigger threshold).

The *time base readout* shows that the main time base is set to a horizontal scale of 500  $\mu\text{s}/\text{div}$ .

The *vertical readout* indicates that Group 1 is displayed and that it includes Channel 1 as the first and also the last channel in the group. The logic scope uses this format for each group readout in the vertical readout: *group number [last channel:first channel] group volts/division setting*.

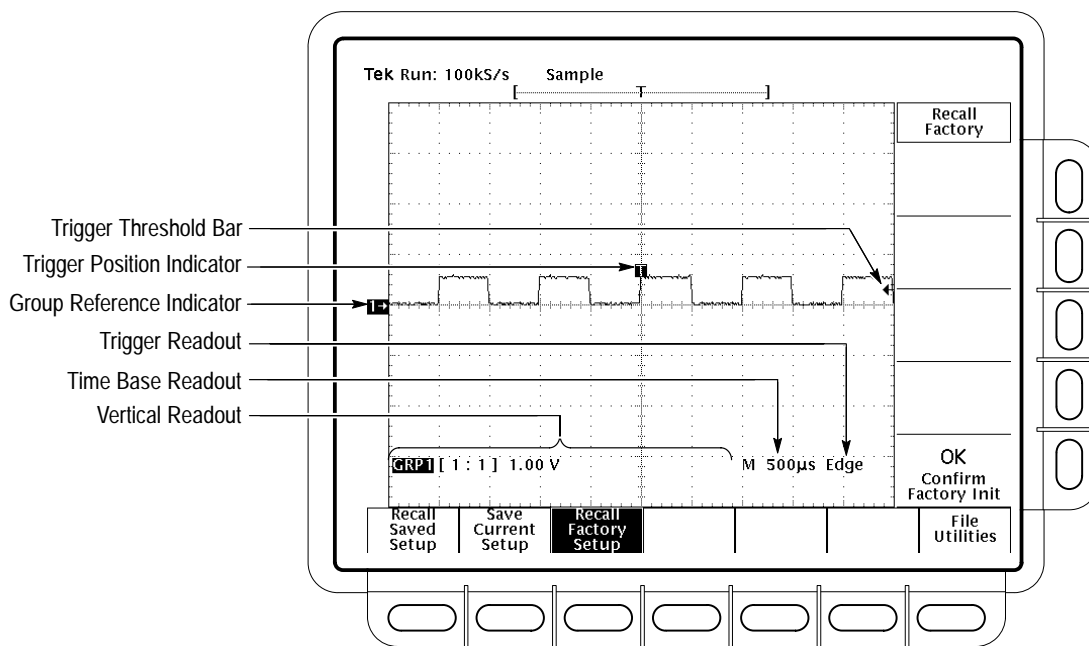

**Figure 1-7: The Display After Factory Initialization**

Right now, the channel, time base, and trigger readouts appear in the graticule area to make room for display of the menu. You can press the CLEAR MENU button any time to remove any menus and to move the readouts below the graticule.

## Example 1: Displaying Waveforms

The TLS 216 Logic Scope can be operated as a full-featured digitizing storage oscilloscope with up to 16 live and 16 reference waveforms on screen. Do the following tasks to learn how to display individual waveforms, to adjust those waveforms individually, and how to use the Autoset function.

### Display a Waveform

The default settings established by doing a reset display one waveform group containing one channel on screen. Do the following steps to add additional groups, with one channel for each group.

1. If you have changed *any* control settings since resetting the logic scope, reset it now: press **SETUP** → **Recall Factory Setup** (main) → **OK Confirm** **Factory Init** (side). Press **SET LEVEL TO 50%**.
2. Locate the **VERTICAL** section of the front panel and the group selection buttons it contains. (See Figure 1-8.) These are labeled **GROUP 1** through **GROUP 8** and **MORE**. (Pressing **SHIFT** before pressing a group button selects the group appearing above the button: one of **GROUP 5** through **GROUP 8**.)

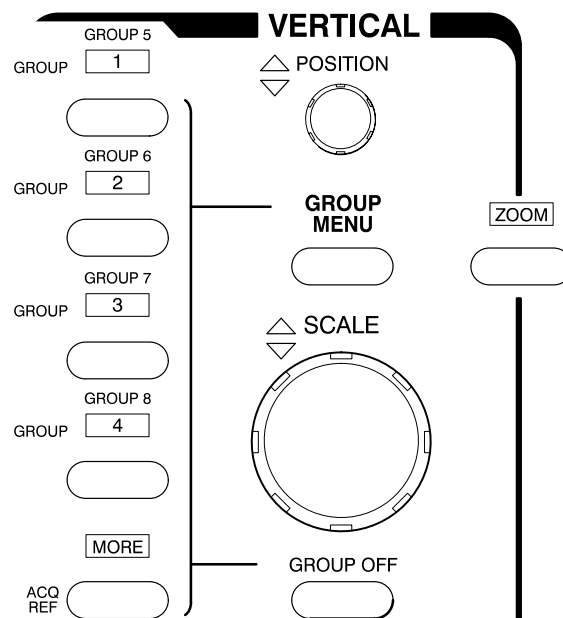

Figure 1-8: The Group Buttons and LEDs

Each of the group buttons has an LED above it. Right now, the GROUP 1 LED is on. This LED indicates that the vertical controls are set to adjust Group 1.

3. Disconnect the Channel 2 probe from the probe calibration output.
4. Press **GROUP 2**.

The display shows a second waveform, which represents the signal on Channel 2 in Group 2. Since there is nothing connected to the Channel 2 probe, this waveform is a flat line.

There are several other important things to observe:

- The vertical readout displays settings for both Group 1, which contains Channel 1, and Group 2, which contains Channel 2.
- The logic scope created Group 2 containing only one channel — the lowest-numbered channel not belonging to any group.
- The group readout for each group indicates *single* channel groups by displaying the channel it contains as the first and last channel. (See Figure 1-9.)
- There are two group indicators at the left edge of the graticule. Right now, they overlap.
- The LED next to the GROUP 2 button is now on, and the GROUP 1 LED is off. Because the knobs control only one group at a time, the vertical controls are now set to adjust Group 2.

---

**NOTE.** *The logic scope still triggers on Channel 1. It does not change trigger source when adding (or removing) groups. (You can change the trigger source to any channel by using the TRIGGER MENU button to display the trigger menu.)*

---

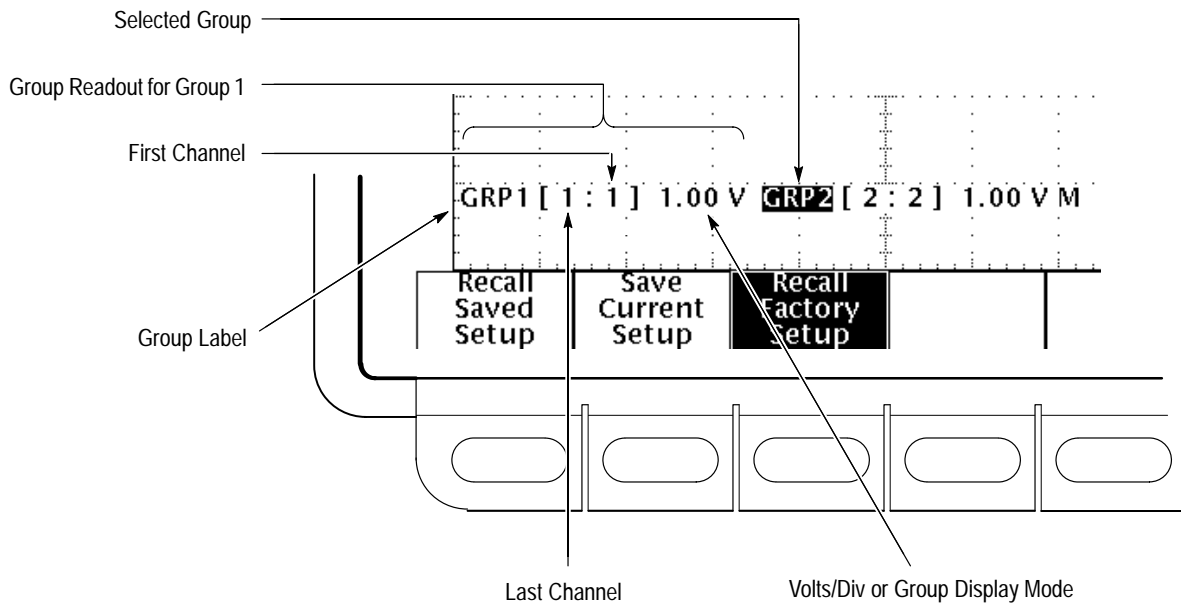

Figure 1-9: Group Readouts

## Adjust Each Waveform

Each example waveform group contains only one channel that, in turn, contains only one waveform. Thus, adjusting a group is the same as adjusting a waveform.

Do the following steps to select each waveform individually and to adjust its size and placement. Refer to Figure 1-10 for knob locations.

1. Press **GROUP 1**. Note the logic scope displays the waveform of the selected group “highlighted” on screen.
2. Turn the vertical **SCALE** knob clockwise. Observe the change in the selected waveform and the group readout at the bottom of the display.
3. Turn the vertical **POSITION** knob first one direction, and then the other. Observe the change in the displayed waveform, and note the group indicator at the left side of the graticule moves with the group. (Also note the group indicator of the *selected* group appears in reverse video. (See Figure 1-9.) Then return the waveform to the center of the graticule.
4. Turn the horizontal **SCALE** knob one click clockwise. Observe the time base readout at the bottom of the display. With the time base set to 250  $\mu\text{s}/\text{div}$  now, you should see two complete waveform cycles on the display.



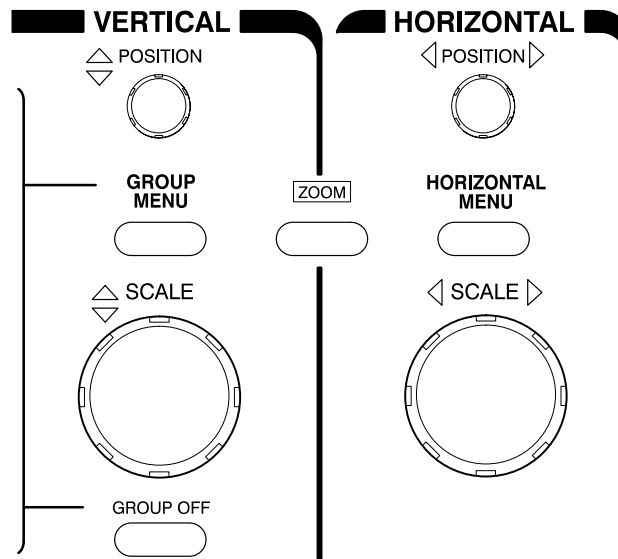

Figure 1-10: The VERTICAL and HORIZONTAL Controls

5. Reconnect the **CH 2** probe to the probe compensator output.
6. Press **GROUP 2**. Adjust vertical scale and position using the same controls as you used above.

As you see, pressing a group button sets the vertical controls to operate on the group selected. (The vertical position and scale knobs always affect all channels in the selected group in the same way.) It also adds the group and its channel(s) to the display if that group is not already defined.

## Autoset the Waveforms

When you first connect a signal to a channel and display it, the logic scope may not scale and trigger that signal correctly. Use the autoset function, and you should quickly get a meaningful display.

1. Reset the logic scope: press Save/Recall **SETUP** → **Recall Factory Setup** (main) → **OK Confirm Factory Init** (side). Press **SET LEVEL TO 50%**.
2. To create an unstable display, slowly turn the trigger **THRESHOLD** knob (see Figure 1-11) first one direction, and then the other. Observe what happens when you move the trigger threshold level above the highest part of the displayed waveform. Leave the trigger threshold so the display remains untriggered.

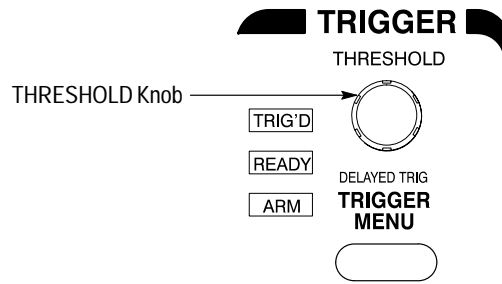

Figure 1-11: TRIGGER Controls

3. Press **AUTOSET** (see Figure 1-12) and observe the stable waveform display.

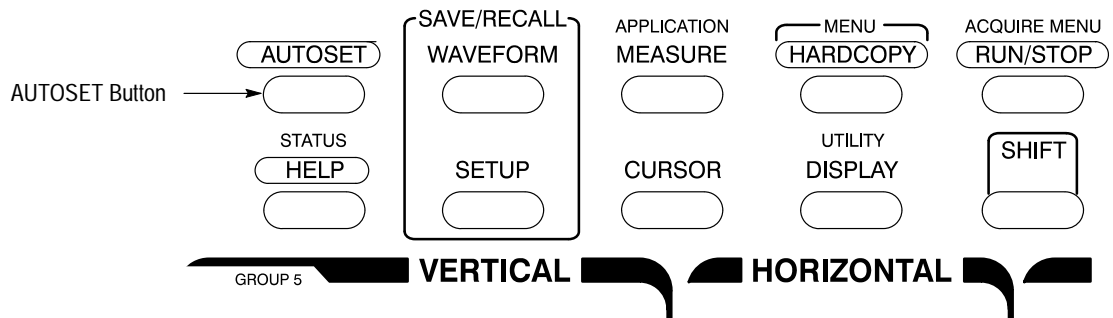

Figure 1-12: AUTOSET Button Location

Figure 1-13 shows the display after pressing **AUTOSET**. If necessary, you can adjust the waveform now by using the knobs discussed earlier in this example.

**NOTE.** Executing Autoset forces the display mode to Timing Diagram for all the groups displayed. A table of all default settings after an autoset appears on page 3-15.

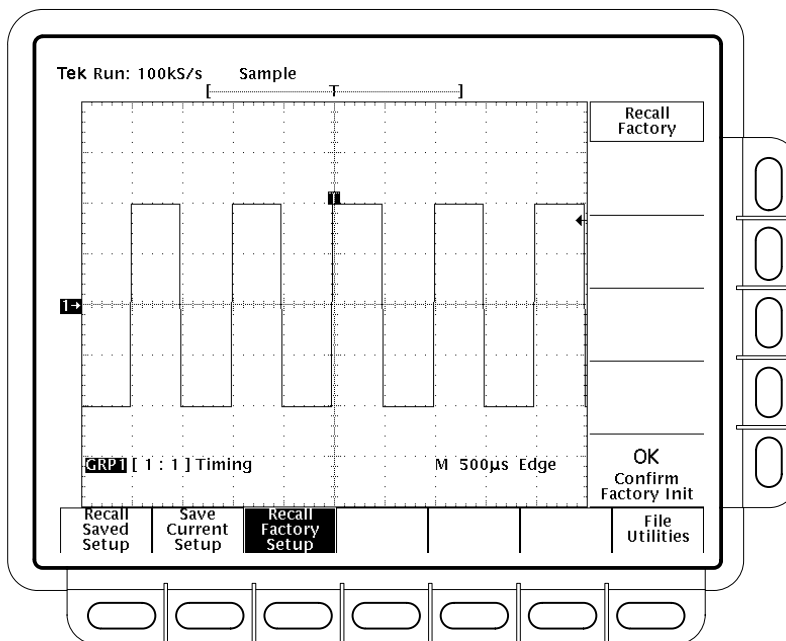

Figure 1-13: The Display After Pressing Autoset

## Removing a Waveform from the Display

Pressing the **GROUP OFF** button ends display of the currently selected group of waveforms. Since in this example each group includes only one channel, turning off a group turns off the display of only one waveform. (Groups that include more than one channel end the display of more than one waveform when turned off.)

1. Press **GROUP 2**.
2. Press **GROUP OFF** (located below the vertical **SCALE** knob).

Since Group 2 was selected when you pressed the **GROUP OFF** button, the logic scope ended display of the Group 2 waveform. Note the vertical readout displays “OFF” in the Group 2 readout. When turned off, a group exists but is not displayed.

The Group 1 LED is lit. Group 1, containing Channel 1, has become the selected group. When you end display of the last group, one group LED remains on (one group must always be selected).

3. Press **GROUP OFF** again to end display of the Group 1 waveform.

**HINT:** Although channels you remove are not acquired (sampled and digitized), you can still select them to provide sources for triggering.

## Example 2: Grouping Waveforms

The TLS 216 Logic Scope displays and controls waveforms as groups of one or more waveforms, with eight groups available for display at the same time. Once grouped, you can display waveforms as analog waveforms, or as digital levels on a bus (BusForms™), or as a timing diagram, depending on which display mode best helps you analyze your digital circuit.

Do the following tasks to learn to how to define and display groups of waveforms, to adjust the waveforms as a group, and to choose a display mode.

### Display a Waveform Group

Do the following steps to define and display a waveform group.

1. If you are not continuing from the previous example, follow the instructions on page 1–7 under the heading “Setting Up for the Examples.”
2. If you have changed *any* control settings since resetting the logic scope, reset it now: press Save/Recall **SETUP** → **Recall Factory Setup** (main) → **OK Confirm Factory Init** (side). Press **SET LEVEL TO 50%**.
3. Use the vertical **POSITION** knob to move **GROUP 1** to the top of the display.
4. Press **SHIFT**, and then press **GROUP 6**. There are several changes to the display:
  - The vertical readout indicates that a new group (Group 6) has been created containing the first available channel (that is, the lowest numbered channel not already belonging to a group—in this case, Channel 2).
  - The Group 1 readout no longer appears in the vertical readout. The vertical readout displays the group labels in two pages: Group 1 through Group 4 on page one, and Group 5 through Group 8 on page two. To force the readout to display group labels in either of these two pages, select a group in the desired page.
  - The logic scope lights the LED below Group 6 to indicate it is selected. It lights the same LED when Group 2 is selected. You can always determine the selected group by looking at the vertical readout. It always displays the selected group with its label in reverse video.
  - The logic scope displays each group (up to the sixth displayed) in a different color to help you distinguish one group from another (the group

indicators at the left side of the screen can also be used to identify each group).

5. Press **GROUP MENU** to display the menu for defining the selected group.
6. Press **Group Definition** in the main menu.

Note that the side menu settings for First Channel, Last Channel, and Selected Channel match the GROUP 6 readout. With the same channel (2) set for First Channel and Last Channel, the group is currently defined to include only one channel.

7. Press **First Channel** in the side menu. In the key pad, press **3**, and then press **ENTER**.
8. Press **Last Channel** in the side menu. In the key pad, press **6**, and then press **ENTER**.

Observe that Channels 3 through 6 are displayed as a superimposed, contiguous, four-channel group. (See Figure 1-14.) The driven channels, Channel 3 and Channel 4, appear as closely overlapped waveforms; the channels not coupled to probe calibration signals, Channel 5 and Channel 6, appear as closely overlapped flat lines.

In addition to using the key pad, you can turn the general purpose knob or toggle the appropriate side menu button to set the first, last, and selected channels.

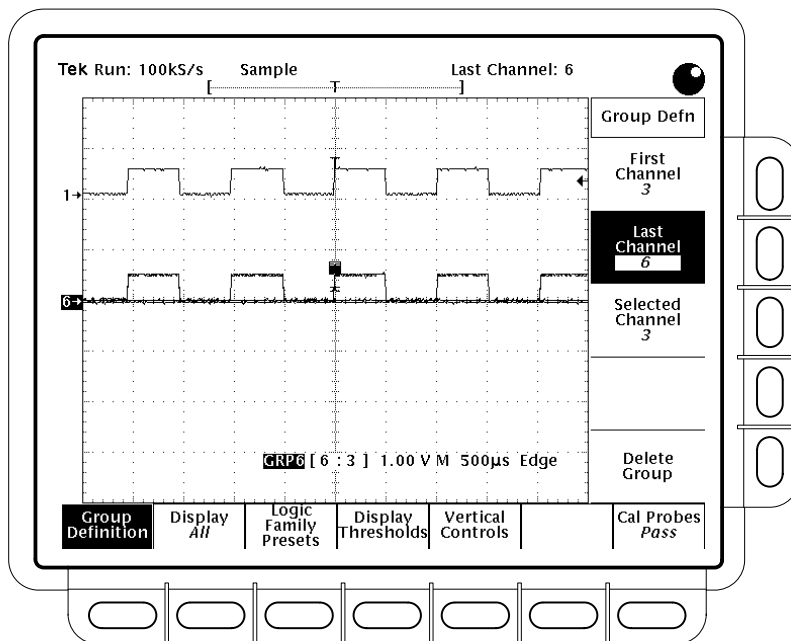

Figure 1-14: Vertical Waveform Groups

## Adjust the Waveform Group

When a waveform group contains multiple channels, adjusting a group adjusts all channels and waveforms in the group. Do the following steps to adjust all waveforms in a group at the same time.

1. Turn the vertical **SCALE** knob clockwise. Observe that all selected waveforms are affected equally. (Channels 5 and 6 contain no waveforms and therefore do not change amplitude on screen.)
2. Turn the vertical **POSITION** knob first one direction, and then the other. Observe the change in the display position of all waveforms in the group. Return the waveform group to the center of the graticule.
3. Turn the horizontal **SCALE** knob one click clockwise. Observe the time base readout at the bottom of the display. It should read out a time base setting of 250  $\mu\text{s}/\text{div}$  now, and you should see two complete waveform cycles on the display.

## Select a Single Channel

The display of waveforms in an overlapping group sometimes makes it difficult to see an individual waveform. Do the following steps to select a channel and display it without any other channel (in the same group) appearing on screen.

1. Press **Group Definition** in the main menu.
2. Press **Selected Channel** in the side menu. In the key pad, press **3**, and then press **ENTER**.
3. Press **Display** in the main menu.
4. Press **Analog** in the side menu to toggle it to **Selected**.

Observe that Channels 4 through 6 are no longer displayed. The logic scope turns off the display of all but the waveform acquired by the selected channel (Channel 3 from step 2).

5. Press **Analog** in the side menu to toggle it to **ALL** before continuing with the example task that follows.

---

**NOTE.** *Adjusting the Vertical SCALE and POSITION knobs scales and positions all waveforms in the groups regardless of whether ANALOG ALL or ANALOG SELECTED is set in the Group Mode menu.*

---

## Select a Display Mode

The logic scope can display a waveform group in any of three display modes: *Analog*, *BusForm*, or *Timing Diagram*. The waveform group currently displayed appears in Analog mode, which displays analog waveforms overlapped, with their ground levels superimposed, when set to ALL. Do the following steps to select a new display mode.

1. Press **Display** in the main menu.
2. Press **Timing Diagram**. Use the vertical position knob to center the display vertically.

There are several important points to observe here (see Figure 1-15):

- The logic scope vertically skews the waveforms relative to each other so you can compare and measure the time relation between any two waveform edges of all waveforms in the group.
- The logic scope intensifies the channel currently selected in the Group Definition menu (true for all display modes).
- The logic scope displays the waveforms as flat lines, since **Timing Diagram** and **Bus** modes display amplitude levels based on how they compare relative to the settings for Display Thresholds. (The amplitude of the probe calibration signal qualifies as a low TTL level at all times.)

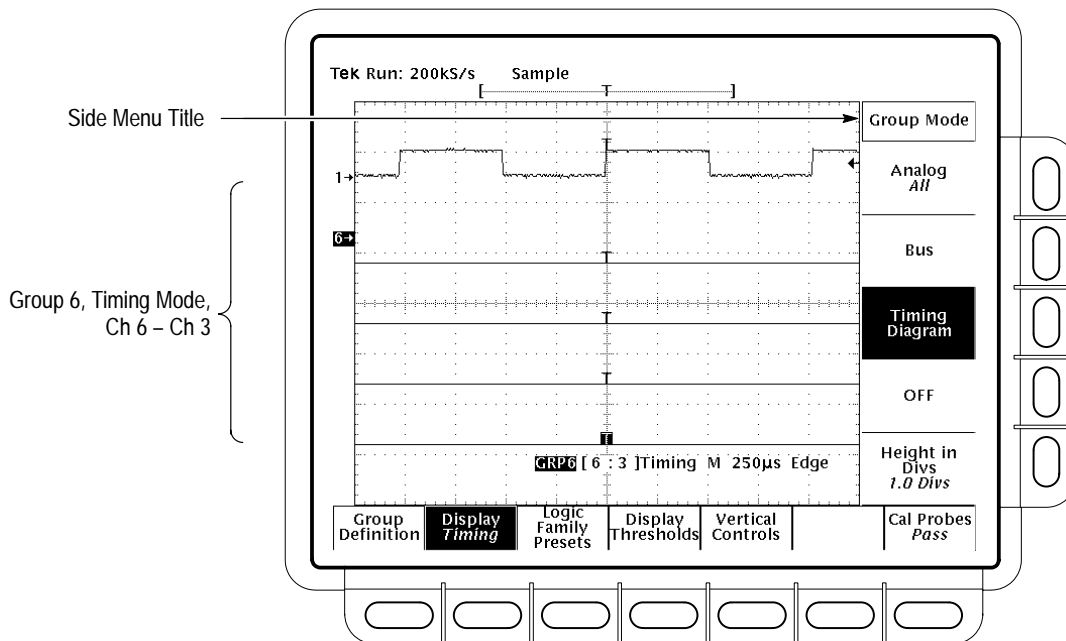

Figure 1-15: Group 6 Displayed as a Timing Diagram

3. Press **Display Thresholds**, and then press **Vhigh, min**.
4. Enter 400 mv using the key pad (press 0.4, and then press **ENTER**). The logic scope now displays the 500 mV probe waveforms as time related digital waveforms, since 500 mV exceeds the minimum **Vhigh**.

## Determining the Binary Value of a Group

When displaying a group in BusForm or Timing Diagram mode, you are probably interested in its digital value. The logic scope can display the binary value of the selected group based on the levels of the waveforms the group contains. Do the following steps to display the binary value of a group.

1. Press **CURSOR**.
2. Press **Function** in the main menu, and then **V Bars** in the side menu.
3. Rotate the general purpose knob until the selected cursor (the solid one) moves into the positive half cycle of the two displayed waveforms.
4. Read the binary value of all acquired waveforms in the cursor readout (see Figure 1-16). The most significant bit (left-most bit in the readout) corresponds to the highest numbered channel currently acquired.

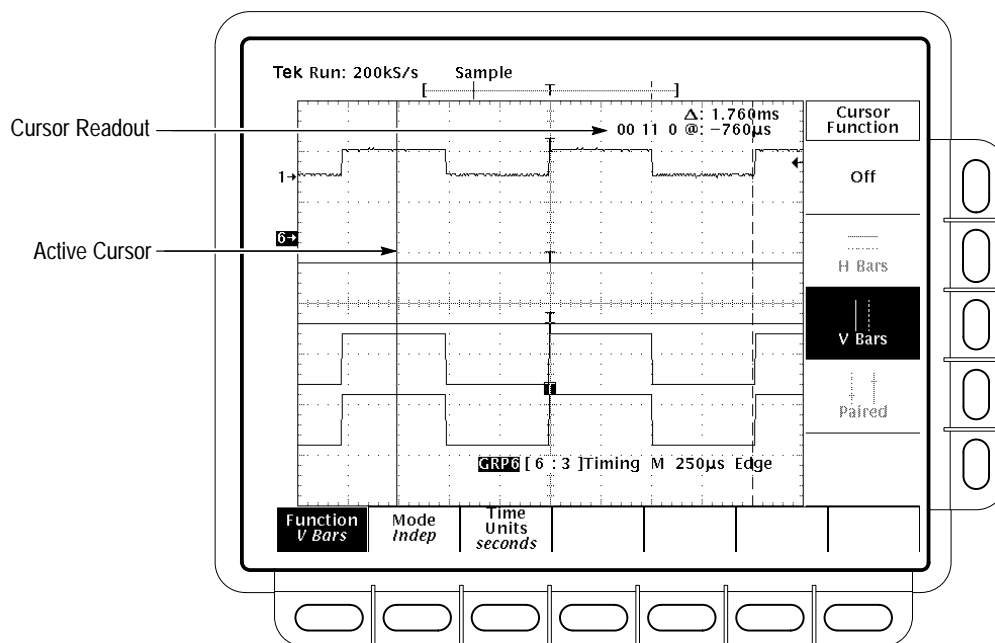

Figure 1-16: Binary Value of a Group



---

**NOTE.** You might wonder why channel 1 displays a zero in the binary readout instead of one. Remember, the logic scope displays binary values based on logic thresholds. The procedure just listed changed only the Group 2 threshold levels and, therefore, the probe calibration signal in Group 1 still qualifies as a low logic level.

---

Cursors also measure time and amplitude. Read about using cursors (and the binary readout) in *Measuring Waveforms with Cursors* on page 3–81.

## Deleting Waveform Groups

When creating new groups, you may want to delete groups you no longer use. Do the following steps to delete a waveform group and make its channels available for creating new groups.

1. Press the button corresponding to the group, one of Group 1 through Group 8, that you want to delete.
2. Press **GROUP MENU** → **Group Definition** (main) → **Delete Group**.

The logic scope removes the group which, in turn, removes all its channels and its readout from the screen. It continues to make the released channels available for including in new or existing groups or for use as trigger sources. However, it will not display them until you include them in a new or existing group.

---

**NOTE.** You cannot delete all groups. If you try to delete the last defined group, the logic scope will retain the group, assign it Channel 1 as first, last, and selected channel, and display it on screen.

---

---

**NOTE.** Sometimes you may just want to end display of a group, rather than deleting that group. In that case, use the **GROUP OFF** button to turn the display of the selected group off. To later restore display of the group, select it and turn it on in the *Display Group Mode* menu (press **GROUP MENU**).

---

## Example 3: Taking Measurements Automatically

The TLS 216 Logic Scope can measure many waveform parameters automatically and read out the numeric results on screen. Do the following tasks to discover how to select various measurements, to take them on various waveforms, and to display a snapshot of most measurements.

### Select the Measurements

To use the automated measurement system, you must have a stable display of your signal. Also, the waveform must have all the segments necessary for the measurement you want. For example, a rise time measurement requires at least one rising edge, and a frequency measurement needs at least one complete cycle.

1. If you are not continuing from the previous example, follow the instructions on page 1–7 under the heading *Setting Up for the Examples*.
2. If you have changed *any* control settings since resetting the logic scope, reset it now: press **SETUP** → **Recall Factory Setup** (main) → **OK Confirm** **Factory Init** (side).
3. Press **AUTOSET**.
4. Press **MEASURE** to display the Measure main menu. (See Figure 1-17.)
5. If it is not already selected, press **Select Measrmnt** (main). The readout for that menu item indicates which channel or group the measurement will be taken from. The logic scope takes most automated measurements on the currently selected channel in the currently selected group.

The Select Measurement side menu lists some of the measurements that can be taken on waveforms. The logic scope can take many different measurements. It can continuously update and display up to four measurements at any one time. Pressing the button next to the –more– menu item brings up the other measurement selections.



6. Press **Frequency** (side). If the **Frequency** menu item is not visible, press –more– (side) repeatedly until the **Frequency** item appears. Then press **Frequency** (side).

Observe that the frequency measurement appears within the graticule area at the right side. The measurement readout includes the notation C1, meaning that the measurement is taken on the Channel 1 waveform.

To take a measurement on another channel, make sure the selected group contains that channel (use the group front-panel buttons). Then use the

Group Definition menu to select the channel. Return to the Measure menu to select the measurement.

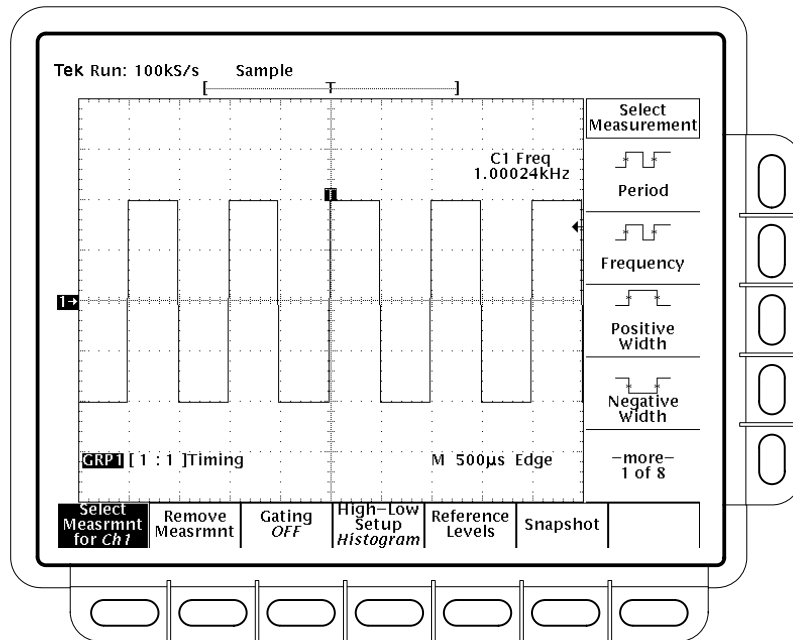
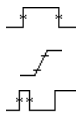

Figure 1-17: Measure Main Menu and Select Measurement Side Menu

7. Press **GROUP MENU** → **Group Definition** (main) → **Last Channel** (side). Press **Last Channel** again to increment it to 2. Press **AUTOSET**.
8. Press **Selected Channel** (side) twice to select it and increment it to Channel 2.

Note that, for any group, the logic scope intensifies the selected waveform in that group on screen to help you identify it.

9. Press **MEASURE** → **Select Measmnt** (main).
10. Press **Positive Width** (side) → **-more-** (side) → **Rise Time** (side) → **Positive Duty Cycle** (side).



Observe from the measurement readouts that the logic scope takes all three measurements on the channel you just selected, Channel 2.

11. To move the measurement readouts outside the graticule area, press **CLEAR MENU**. (See Figure 1-18.)

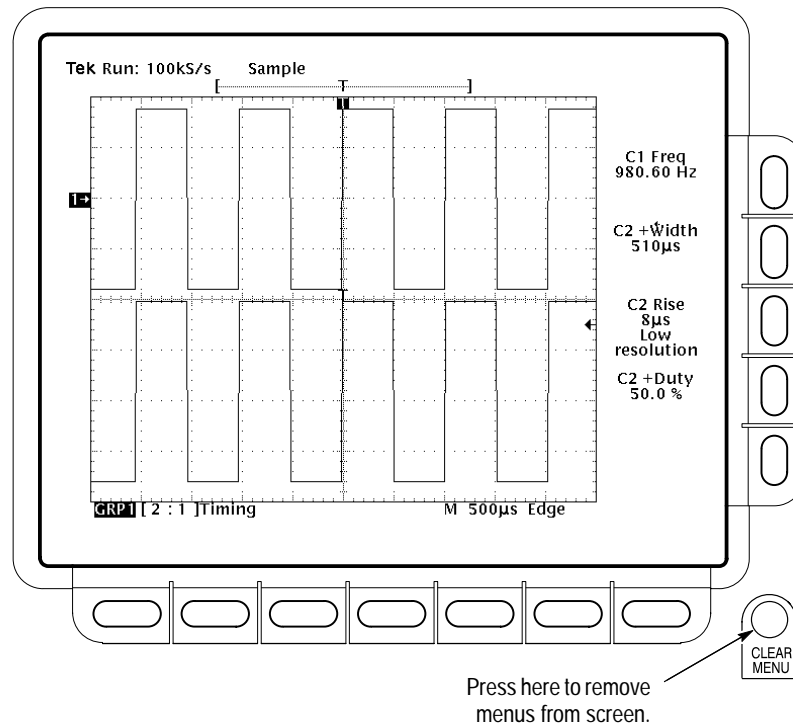

Figure 1-18: Four Simultaneous Measurement Readouts

## Remove Measurement Readouts

The Measure menu lets you remove measurements you no longer want displayed. You can remove any one measurement, or you can remove them all at once.

Press **MEASURE** → **Remove Measrmtnt** (main) → **Measurement 1**, **Measurement 2**, and **Measurement 4** (side) to remove those measurements. Leave the rise time measurement displayed.

## Changing the Measurement Reference Levels

By default, the measurement system will use the 10% and 90% levels of the waveform for taking the rise time measurement. You can change these values to other percentages or change them to absolute voltage levels.



To examine the current values, press **Reference Levels** (main) → **High Ref** (side).

**The General Purpose Knob**

The general purpose knob is now set to adjust the high reference level. (See Figure 1-19.)

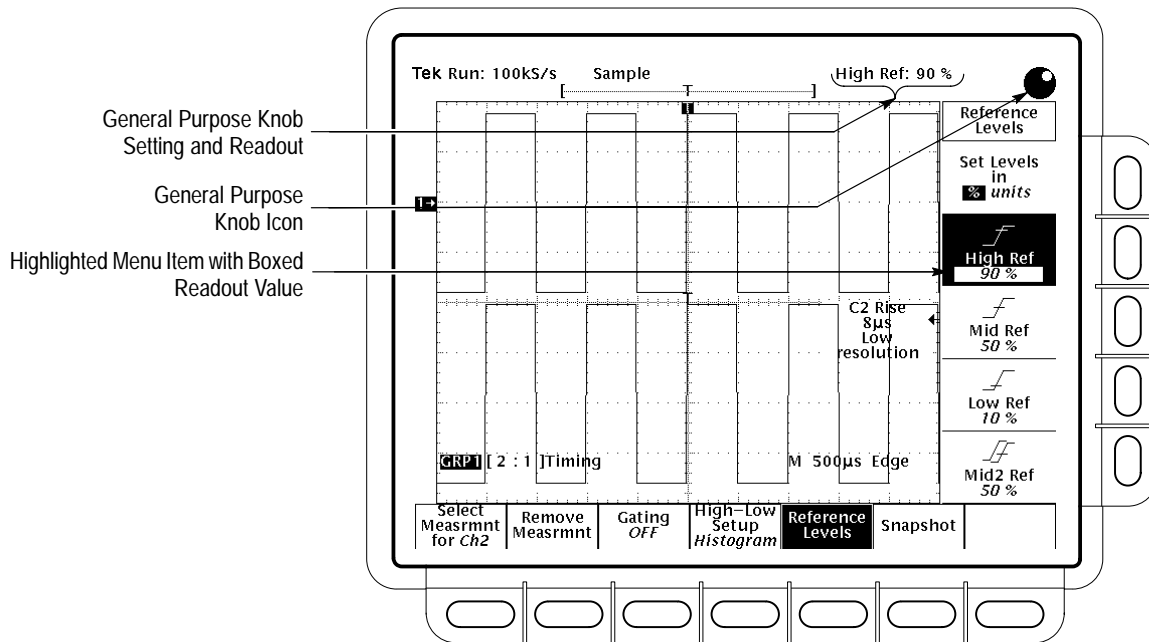

**Figure 1-19: General Purpose Knob Indicators**

There are several important things to observe on the screen:



- The knob icon appears at the top of the screen. Its presence indicates that the general purpose knob has just been set to adjust a parameter.
- The upper-right corner of the screen shows the readout High Ref: 90%.
- The High Ref side menu item is highlighted, and a box appears around the 90% readout in the High Ref menu item. The box indicates that the general purpose knob is currently set to adjust that parameter.

Turn the general purpose knob left and right, and then use it to adjust the high level to 80%. This adjustment sets the high measurement reference to 80%.

**NOTE.** To make large changes quickly with the general purpose knob, press the *SHIFT* button before turning the knob. When the light above the *SHIFT* button is lit and the display says *Coarse Knobs* in the upper-right corner, the general purpose knob speeds up significantly.

## The Numeric Keypad

Any time the general purpose knob is set to adjust a numeric parameter, you can enter the value as a number using the keypad instead of using the knob. Always end the entry of a number by pressing the ENTER (↵) key.

The numeric keypad also provides multipliers for engineering exponents, such as m for milli, M for mega, and  $\mu$  for micro. To enter these multiplier values, press the **SHIFT** button, then press the multiplier.



1. Press **Low Ref** (side).
2. On the numeric keypad, press the **2**, the **0**, and the **ENTER** (↵) buttons, which sets the low measurement reference to 20%. Observe that the rise-time value has changed.
3. Press **Remove Measrmt** (main) → **All Measurements** (side). The display will return to its original state.

## Take a Snapshot of Measurements

You have seen how the logic scope can display up to four individual automated measurements on screen. You can also pop up a display of almost all the automated measurements available in the Select Measrmts side menus. This *snapshot* of measurements is taken on the currently selected waveform in the currently selected group. (Use the group front-panel buttons to select the group; use the Group Menu to select the channel in the selected group.)

As when displaying individual measurements, you must have a stable display of your signal, and the signal must have all the segments necessary for the measurement you want.

1. Press **Snapshot** (main) to pop up a snapshot of all available single waveform measurements. (See Figure 1-20).

The snapshot display includes the notation Ch 2, meaning that the logic scope took the measurements listed on the Channel 2 waveform. To take a snapshot of a waveform in another channel, first select the group that includes the channel and then select the channel.

The snapshot measurements do not continuously update. Snapshot executes a one-time capture of all measurements and does not update those measurements unless you execute another snapshot.

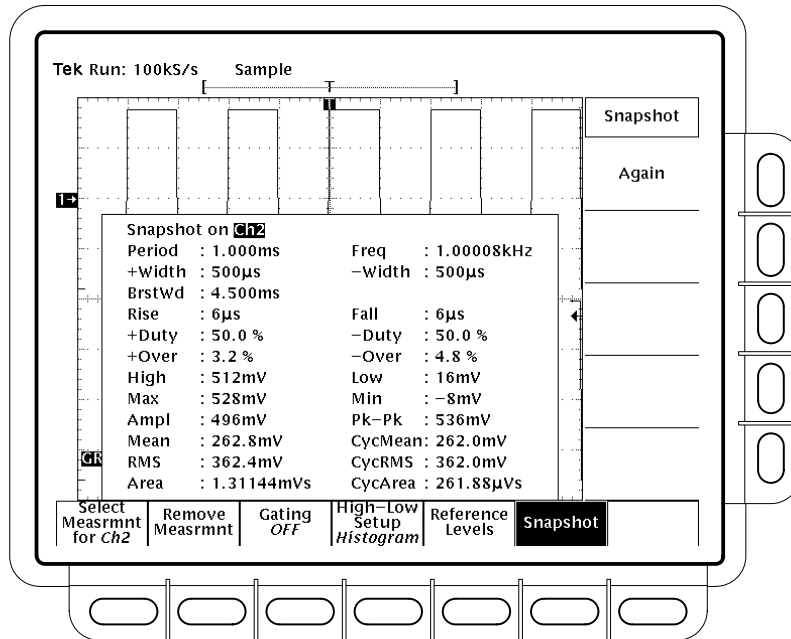

Figure 1-20: Snapshot of Channel 2

2. Press **Again** (side) to do another snapshot and update the snapshot measurements.
3. Press **Remove Measrmt** (main) to remove the snapshot display. (You can also press CLEAR MENU, but a new snapshot will be executed the next time you display the Measure menu.)

## Example 4: Saving Setups

The TLS 216 Logic Scope can save its control settings and recall them later to quickly re-establish the previously saved setup. The logic scope provides several storage locations where you can save the setups. Do the following tasks to save a setup and then to recall it.

---

**NOTE.** Besides being able to save several complete setups, the logic scope remembers all the current control settings when you power it off. You can power on and continue with the same setup as when you left off. You do not have to reconstruct the setup.

---

### Save a Setup

First, you need to create an instrument setup you want to save. The next several steps establish a two-waveform display with a measurement on one waveform. The setup created is complex enough that you might prefer not to go through all these steps each time you want that display.

1. If you are not continuing from the previous example, follow the instructions on page 1–7 under the heading “Setting Up for the Examples.”
2. If you have changed *any* control settings since resetting the logic scope, reset it now: press Save/Recall **SETUP** → **Recall Factory Setup** (main) → **OK Confirm Factory Init** (side).
3. Press **AUTOSET**.
4. Press **MEASURE** → **Select Measrmnt** (main) → **Frequency** (side). (Press the **–more–** side menu item if the **Frequency** selection does not appear in the side menu.)
5. Press **GROUP 2**.
6. Press Save/Recall **SETUP** → **Save Current Setup** (main) to display the Setup main menu. (See Figure 1-21.)



---

**CAUTION.** Setup locations in the side menu appear with the label *user* if they already contain a stored setup and with the label *factory* if they do not. To avoid overwriting (and losing forever) a saved setup, save your current setup in a location labeled *factory*; otherwise, save it in any setup location desired.

---



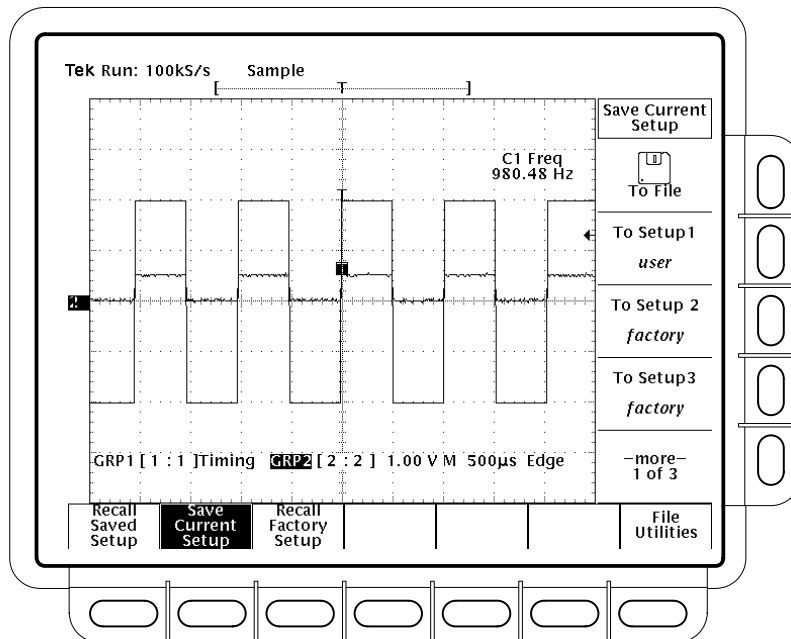

Figure 1-21: Save/Recall Setup Menu

7. Press one of the **To Setup** side menu buttons to store the current instrument settings into that setup location. Remember which setup location you selected for use later.

There are more setup locations than can be listed at one time in the side menu. The **-more-** side menu item gives you access to all the setup locations.

Once you have saved a particular setup, you can change the settings as you wish, knowing that you can come back to that setup at any time.

8. Press **GROUP OFF** twice to turn both groups off.

## Recall a Setup

To recall the setup, press Save/Recall **SETUP** → **Recall Saved Setup** (main) → **Recall Setup** (side) for the setup location you used in the last exercise. The groups you just removed (in step 8, above) should appear in the recalled setup.

This completes the examples. To restore the default settings, press Save/Recall **SETUP** → **Recall Factory Setup** (main) → **OK Confirm Factory Init** (side).



# Overview

This section describes the basic concepts of operating the TLS 216 Logic Scope. Understanding the basic concepts of your logic scope will help you use it much more effectively.

The first part, *At a Glance*, quickly shows you how the logic scope controls are organized and gives some very general operating instructions. It also contains an overview of all the main menus. This part includes the titles:

- *Front Panel Map—Left Side*
- *Front Panel Map—Right Side*
- *Rear Panel Map*
- *Display Map*
- *To Operate a Menu*
- *Menu Map*

The second part explains the following concepts:

- The triggering system, which establishes conditions for acquiring signals. Properly set, triggers can convert displays from unstable jumbles or blank screens into meaningful waveforms. See *Triggering* on page 2–13.
- The acquisition system, which converts analog data into digital form. See *Acquisition* on page 2–19.
- The waveform scaling and positioning system, which changes the dimensions of the waveform display. Scaling waveforms involves increasing or decreasing their displayed size. Positioning means moving them up, down, right, or left on the display. See *Scaling and Positioning Waveforms* on page 2–23.
- The measurement system, which provides numeric information on the displayed waveforms. You can use graticule, cursor and automated measurements. See *Measurements* on page 2–27.

At the end of each topic, *To Find More Information* points you to sources where more information can be found.

To explore these topics in more depth and to read about topics not covered in this section, see *Reference*. Page 3–1 lists the topics covered.



# At a Glance

The *At a Glance* section contains illustrations of the display, the front and rear panels, and the menu system. These illustrations will help you understand and operate the logic scope. This section also contains a visual guide to using the menu system.

## Front Panel Map — Left Side

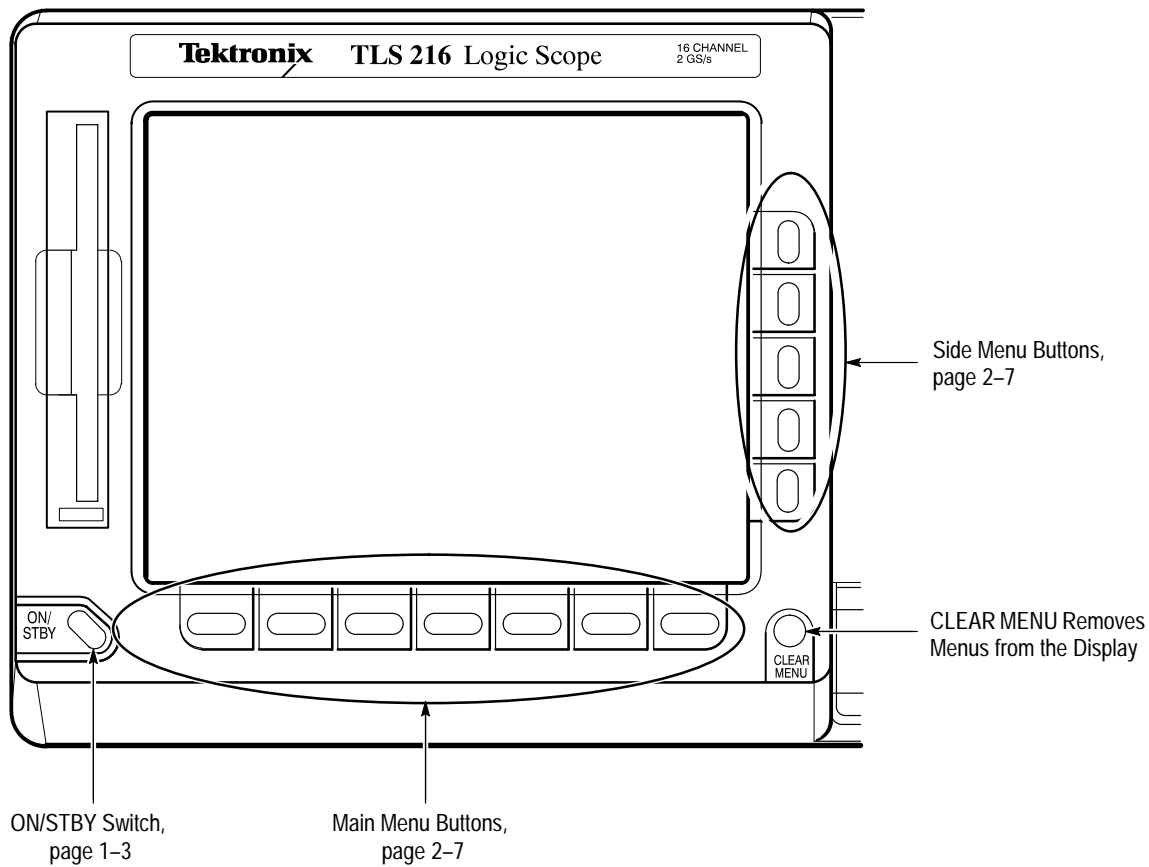

# Front Panel Map — Right Side

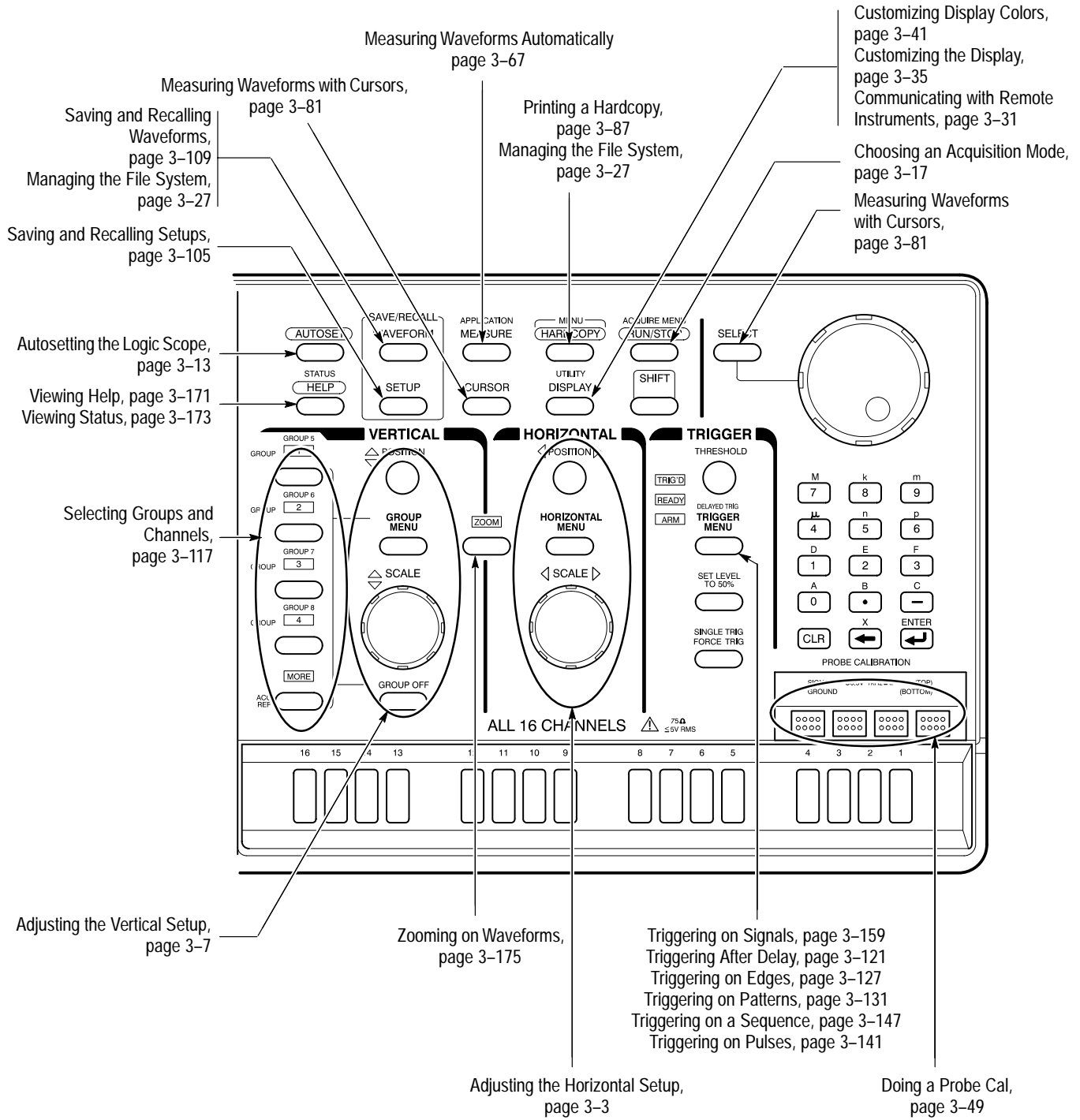

# Rear Panel Map

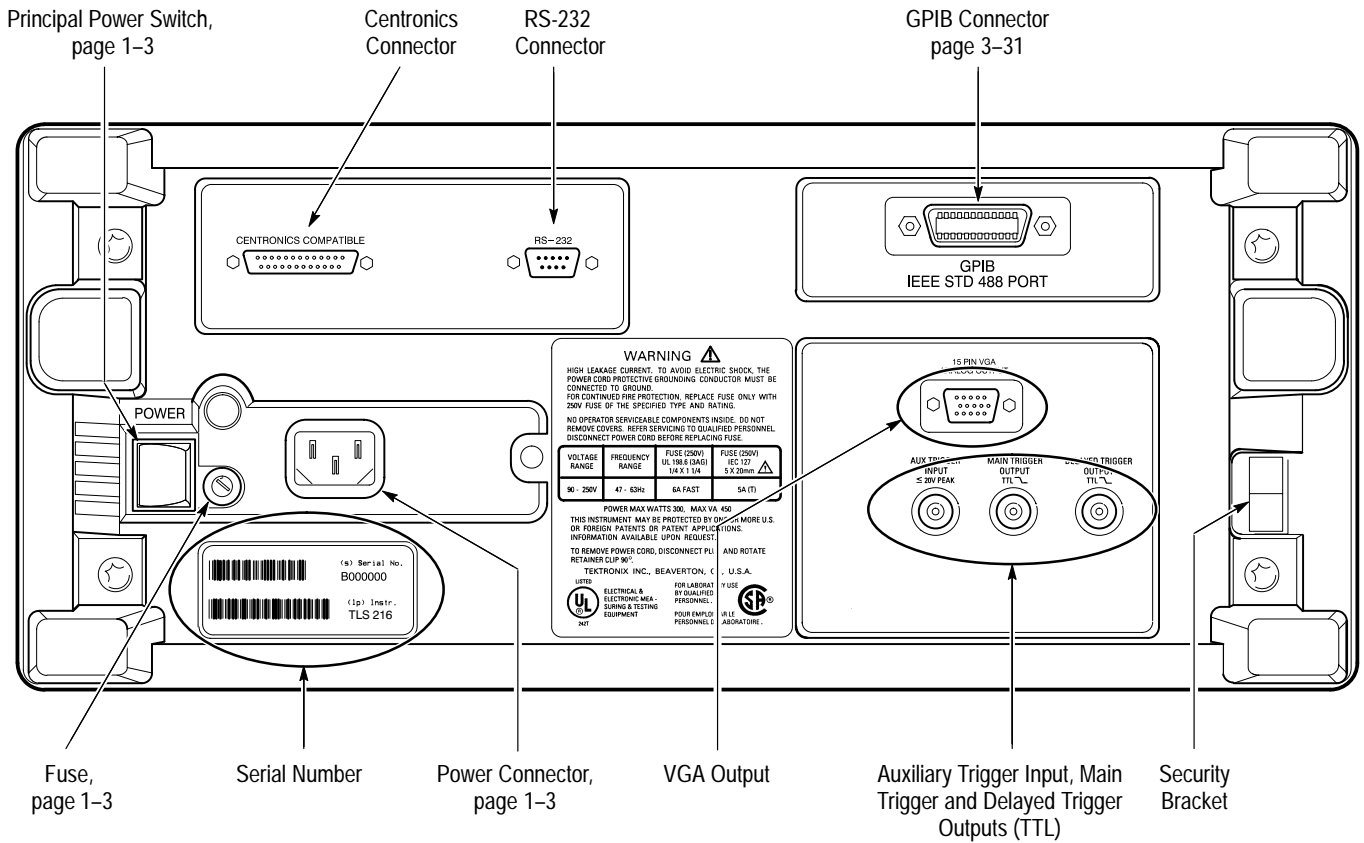

# Display Map

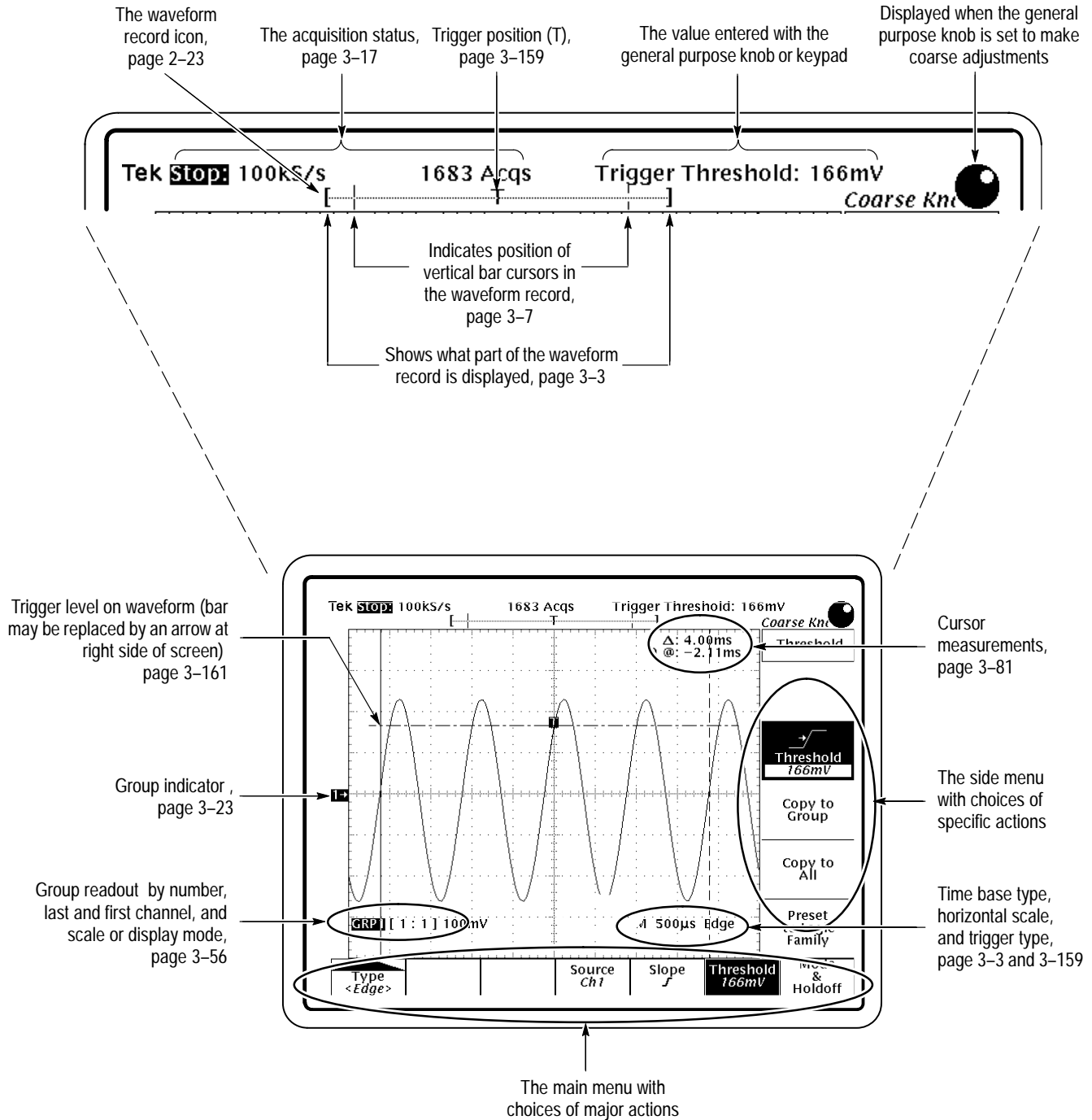





## To Operate a Pop-Up Menu

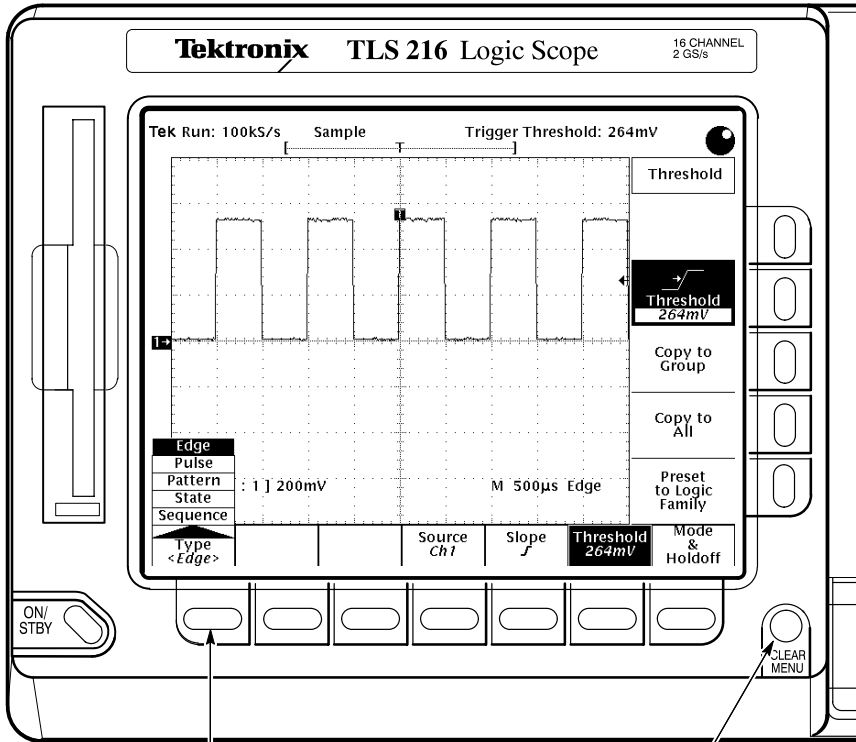

Press  
to display pop-ups.

Press here to  
remove menus from  
screen.

Press it again  
to advance to the next selection.

A pop-up selection changes the other  
main menu titles.

# Menu Map

Press these buttons:

To bring up these menus:

Acquire Menu  
(see page 3-17)

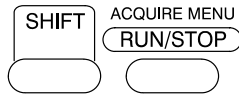

Mode <i>Sample</i>	Stop After <i>R/S button</i>						
-----------------------	---------------------------------	--	--	--	--	--	--

Application Menu  
(see the Programmer manual for more details)

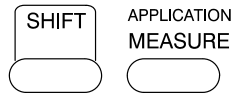

--	--	--	--	--	--	--	--

Cursor Menu  
(see page 3-81)

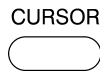

Function <i>OFF</i>	Mode <i>Indep</i>	Time Units <i>seconds</i>					
------------------------	----------------------	------------------------------	--	--	--	--	--

Delayed Trigger Menu – Edge  
(see pages 3-121 and 3-127)

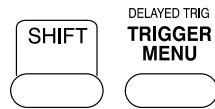

Edge							
Pulse							
Pattern							
State							
Sequence							
Type <i>&lt;Edge&gt;</i>			Source <i>Ch1</i>	Slope <i>f</i>	Threshold <i>2.84 V</i>	Delay by <i>Runs After</i>	

Delayed Trigger Menu – Pulse  
(see pages 3-121 and 3-141)

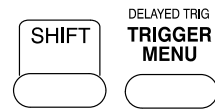

Edge							
Pulse							
Pattern							
State							
Sequence							
Type <i>&lt;Pulse&gt;</i>	Class <i>&lt;Glitch&gt;</i>	TrigWhen <i>True &lt;</i>	Source <i>Ch1</i>	Polarity <i>Positive</i>	Threshold <i>2.84 V</i>	Delay by <i>Runs After</i>	

Delayed Trigger Menu – Pattern  
(see pages 3-121 and 3-131)

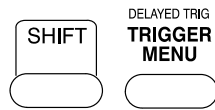

Edge							
Pulse							
Pattern							
State							
Sequence							
Type <i>&lt;Pattern&gt;</i>	Time Qual <i>&lt;Limit&gt;</i>	Pattern Trig When <i>True &gt;</i>	Define Start <i>Pattern</i>	Define End <i>Logic AND</i>	Set Thresholds	Delay by <i>Runs After</i>	

Delayed Trigger Menu – Sequence  
(see pages 3-121 and 3-147)

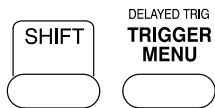

Edge							
Pulse							
Pattern							
State							
Sequence							
Type <i>&lt;Sequence&gt;</i>	Time Qual <i>&lt;Limit&gt;</i>	Sequence Trig When <i>True &gt;</i>	Define Start <i>Pattern</i>	Define End <i>Pattern</i>	Set Thresholds	Delay by <i>Runs After</i>	

Press these buttons:

To bring up these menus:

Delayed Trigger Menu – State  
(see pages 3–121 and 3–165)

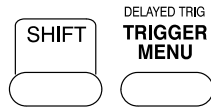

Edge					
Pulse					
Pattern					
State					
Sequence					
Type <State>	Clock Source <i>Ch 1</i>	Define Pattern	Define Logic <i>AND</i>	Set Thresholds	Delay by <i>Runs After</i>

Display Menu – Settings Color  
(see page 3–41)



Display						
Color						
Settings <Color>	Palette <i>Normal</i>	Change Colors	Map Group Colors	Map Reference Colors	Options	Restore Colors

Display Menu – Settings Display  
(see page 3–35)



Display						
Color						
Settings <Display>	Style <i>Vectors</i>	Intensity	Readout Options	Filter <i>Sin(x)/x</i>	Graticule <i>Full</i>	

Group Menu  
(see pages 3–23 and 3–55)



Group Definition	Display <i>All</i>	Logic Family Presets	Display Thresholds	Vertical Controls		Cal Probes <i>Initialized</i>
------------------	-----------------------	----------------------	--------------------	-------------------	--	----------------------------------

Hardcopy Menu  
(see page 3–87)

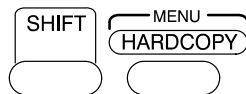

Format <i>Interleaf</i>	Layout <i>Portrait</i>	Palette <i>Hardcopy</i>	Port <i>GPIO</i>	Clear Spool		File Utilities
----------------------------	---------------------------	----------------------------	---------------------	-------------	--	----------------

Horizontal Menu  
(see page 3–3)



Time Base <i>Main</i>	Trigger Position <i>50%</i>	Record Length <i>500</i>	Horiz Scale (/div)	Horiz Pos		
--------------------------	--------------------------------	-----------------------------	-----------------------	-----------	--	--

Main Trigger Menu – Edge  
(see page 3–127)



Edge					
Pulse					
Pattern					
State					
Sequence					
Type <Edge>		Source <i>Ch 1</i>	Slope <i>f</i>	Threshold <i>260mV</i>	Mode & Holdoff

Main Trigger Menu – Pulse  
(see page 3–141)



Edge						
Pulse						
Pattern						
State						
Sequence						
Type <Pulse>	Class <Width>	Trig When	Source <i>Ch 1</i>	Polarity <i>Positive</i>	Threshold <i>2.84 V</i>	Mode & Holdoff

Press these buttons:

To bring up these menus:

Main Trigger Menu – Pattern  
(see page 3–131)



Edge						
Pulse						
<b>Pattern</b>						
State						
Sequence						
Type <Pattern>	Time Qual <Limit>	<b>Pattern Trig When True &gt;</b>	Define Pattern	Define Logic AND	Set Thresholds	Mode & Holdoff

Main Trigger Menu – State  
(see page 3–165)



Edge						
Pulse						
Pattern						
<b>State</b>						
Sequence						
Type <State>		<b>Clock Source Ch1</b>	Define Pattern	Define Logic AND	Set Thresholds	Mode & Holdoff

Main Trigger Menu – Sequence  
(see page 3–147)



Edge						
Pulse						
Pattern						
State						
<b>Sequence</b>						
Type <Sequence>	Time Qual <Limit>	<b>Sequence Trig When True &gt;</b>	Define Start Pattern	Define End Pattern	Set Thresholds	Mode & Holdoff

Measure Menu (see  
page 3–67)



<b>Select Measrmt for Ch1</b>	Remove Measrmt	Gating OFF	High–Low Setup Histogram	Reference Levels	Snapshot	
---------------------------------------	-------------------	---------------	--------------------------------	---------------------	----------	--

More Menu  
(see page 3–117)



Reference Group Ref 1	Reference Group Definition	<b>Display Mode Bus</b>		Display Thresholds	Vertical Controls	
-----------------------------	----------------------------------	---------------------------------	--	-----------------------	----------------------	--

Save/Recall Setup Menu  
(see page 3–105)



<b>Recall Saved Setup</b>	Save Current Setup	Recall Factory Setup				File Utilities
-----------------------------------	--------------------------	----------------------------	--	--	--	-------------------

Save/Recall Waveform Menu  
(see page 3–109)

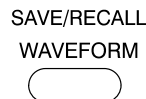

<b>Recall Group to Ref</b>	Save Group Ref 1	Delete Refs				File Utilities
------------------------------------	---------------------	----------------	--	--	--	-------------------

Status Menu  
(see page 3–173)

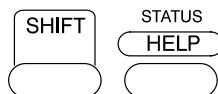

<b>System</b>	Waveform	Trigger	Banner			
---------------	----------	---------	--------	--	--	--

Press these buttons:

To bring up these menus:

Utility Menu – Calibration  
(see page 3–53)

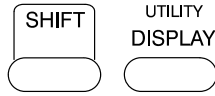

Config						
I/O						
Cal						
Diag/Err						
System <Cal>	Signal Path Pass	Voltage Reference Pass	Frequency Response Pass	Pulse Trigger Pass		

Utility Menu – Config  
(see pages 3–108 and 3–89)

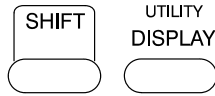

Config						
I/O						
Cal						
Diag/Err						
System <Config>	1ek Secure Erase Memory	Set Date & Time				

Utility Menu – Diagnostics  
(see the Service manual)

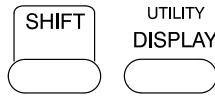

Config						
I/O						
Cal						
Diag/Err						
System <Diag/Err>	Area <All Areas>	Tests Select All	Execute	Loop Once		Error Log

Utility Menu – I/O – GPIB  
(see page 3–31)

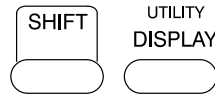

		GPIB RS232				
System <I/O>	Port <GPIB>	Configure Talk/Listen				

Utility Menu – I/O – RS232  
(see page 3–31)

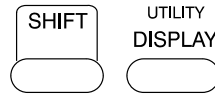

		GPIB RS232				
System <I/O>	Port <RS232>	Configure Hardcopy	Hardware Setup	Software Setup		

Zoom Menu  
(see page 3–175)



Zoom
OFF
ON
Horizontal Lock All
Reset Zoom Factors

# Triggering

This section describes the edge trigger of the main trigger system and explores, in a general sense, the topic of triggering. The TLS 216 Logic Scope also has pulse, pattern, state, and sequence triggers for triggering on digital and pulse waveforms, and a delayed trigger system. Section 3 describes these trigger types and the delayed trigger system.

Triggers determine when the logic scope starts acquiring and displaying a waveform. They help create meaningful waveforms from unstable jumbles or blank screens. (See Figure 2-1.)

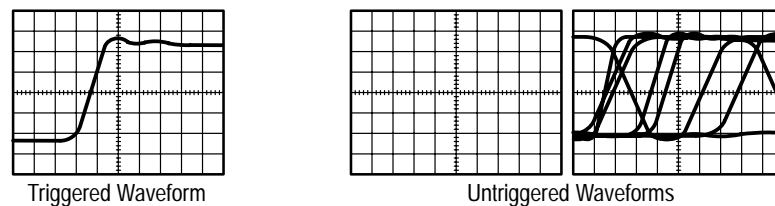

**Figure 2-1: Triggered Versus Untriggered Displays**

The trigger event establishes the time-zero point in the waveform record, and all points in the record are located in time with respect to that point. The logic scope continuously acquires and retains enough sample points to fill the pretrigger portion of the waveform record (that part of the waveform that is displayed *before*, or to the left of, the triggering event on screen).

When a trigger event occurs, the logic scope starts acquiring samples to build the posttrigger portion of the waveform record (displayed *after*, or to the right of, the trigger event). Once a trigger is recognized, the logic scope will not accept another trigger until the acquisition is complete.

The basic trigger is the edge trigger. An edge trigger event occurs when the trigger *source* (the signal that the trigger circuit monitors) passes through a specified voltage *level* (the trigger threshold) in a specified *direction* (the trigger *slope*).

## Trigger Sources

You can derive your trigger from various sources. The logic scope DC couples all source signals to the triggering circuit.

*Input channels* provide the most commonly used trigger source. The trigger source can be any one of the 16 input channels. The channel you select as a trigger source will function whether it is displayed or not, or whether it belongs to a waveform group or not.



*AC Line Voltage* is the trigger source most often used when you are looking at signals related to the power line frequency. Examples include devices such as lighting equipment and power supplies. Because the logic scope generates the trigger, you do not have to input a signal to create it.

*Auxiliary Trigger* is the trigger source most often used in digital design and repair. For example, you might want to trigger with an external clock or with a signal from another part of the circuit. To use the auxiliary trigger, connect the external triggering signal to the Auxiliary Trigger input connector on the logic scope rear panel.

## Types

The logic scope includes five standard trigger types in both the main and the delay trigger systems. All five types are described in individual articles found in the Section 3 *Reference*. A brief definition of each type follows:



*Edge* is the “basic” or general-purpose trigger. You can use it with both analog and digital test circuits. An edge trigger event occurs when the trigger source (the signal the trigger circuit is monitoring) passes through a specified voltage level in the specified direction (the trigger slope).



*Pulse* is a special-purpose trigger primarily used on digital circuits. Two classes of pulse triggers are width and glitch. Triggering occurs when time constraints you specify on pulse or glitch width are satisfied.

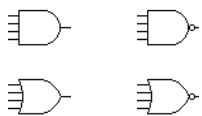

*Pattern* is a special-purpose trigger primarily used on digital logic circuits. You select Boolean operators and define logic levels for the trigger sources. Triggering occurs when the Boolean conditions are satisfied relative to a time limit or time range you specify.

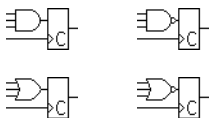

*State* is a special-purpose trigger primarily used on digital logic circuits. Like pattern trigger, you select Boolean operators and define logic levels for trigger sources. Triggering occurs when the Boolean conditions are satisfied at the active edge of the clock.

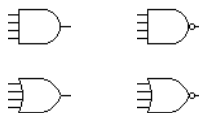

*Sequence* is a special-purpose trigger primarily used on digital logic circuits. Like pattern trigger, you select Boolean operators and define logic levels for trigger sources, but you do so for two events, a start event and a stop event. Triggering occurs when the Boolean conditions are first satisfied, for the start event and then for the end event, relative to a time limit or time range you specify.



## Trigger Modes

The trigger mode determines how the logic scope behaves in the absence of a trigger event. The logic scope provides two different trigger modes, *normal* and *automatic*.

*Normal* trigger mode allows the logic scope to acquire a waveform only when it is triggered. If no trigger occurs, the logic scope will not acquire a waveform. (You can push **FORCE TRIGGER** to force the logic scope to make a single acquisition.)

*Automatic* trigger mode (auto mode) allows the logic scope to acquire a waveform even if a trigger does not occur. Auto mode uses a timer that starts after a trigger event occurs. If another trigger event is not detected before the timer times out, the logic scope forces a trigger anyway. The length of time it waits for a trigger event depends on the time base setting.

Be aware that auto mode, when forcing triggers in the absence of valid triggering events, does not sync the waveform on the display. In other words, successive acquisitions will not be triggered at the same point on the waveform; therefore, the waveform will appear to roll across the screen. Of course, if valid triggers occur the display will become stable on screen.

Since auto mode will force a trigger in the absence of one, you can use it to monitor signals the amplitude level of which is your only concern. Although the unsynced waveform may “roll” across the display, it will not “freeze” as it would in normal trigger mode. Monitoring of a power supply output is an example of such an application.

## Holdoff

When a trigger event is recognized, the logic scope disables the trigger system until acquisition is complete. In addition, the trigger system remains disabled during the holdoff period that follows each acquisition. You can set holdoff to help ensure a stable display.

For example, the trigger signal might be a complex waveform with many possible trigger points. Though the waveform is repetitive, a simple trigger might get you a series of patterns on the screen instead of the same pattern each time.

Digital pulse trains are good examples (see Figure 2-2). Each pulse looks like any other, so many possible trigger points exist. Not all of these will result in the same display. The holdoff period allows the logic scope to trigger on the correct edge, resulting in a stable display.

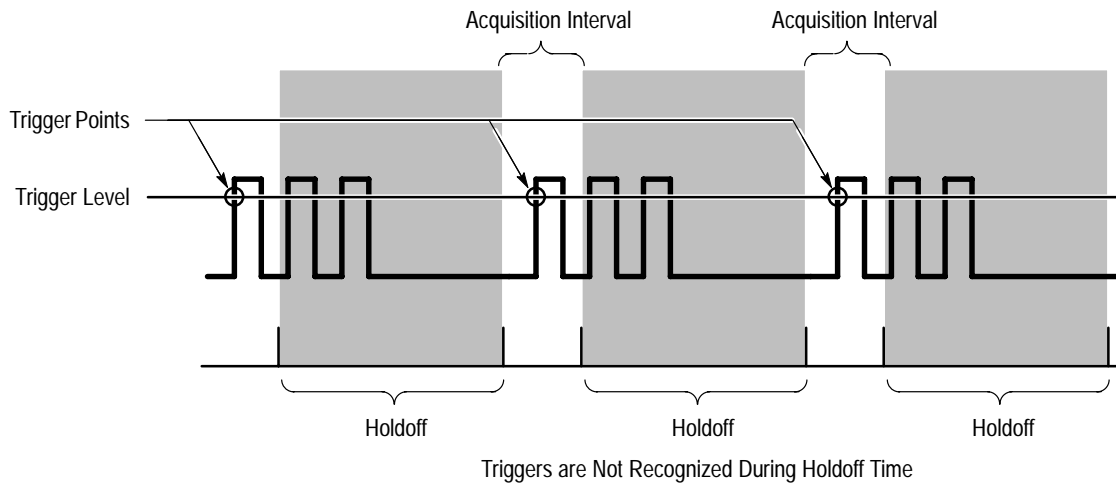

Figure 2-2: Trigger Holdoff Time Ensures Valid Triggering

Holdoff is settable from 0% (minimum holdoff available) to 100% (maximum available). To see how to set holdoff, see *Set Mode & Holdoff* on page 3–129. The minimum and maximum holdoff varies with the horizontal scale. See the characteristic called *Holdoff, Variable, Main Trigger* in the *TLS Performance Verification and Specifications* shipped with the logic scope for the typical minimum and maximum values.

## Trigger Position



The adjustable *trigger position* defines where on the waveform record the trigger occurs. It lets you properly align and measure data within records. The part of the record that occurs *before* the trigger is the pretrigger portion. The part that occurs *after* the trigger is the posttrigger portion.

To help you visualize the trigger position setting, the top part of the display has an icon indicating where the trigger occurs in the waveform record. You use the Horizontal menu to select what percentage of the waveform record will contain pretrigger information.

Many users find displaying pretrigger information a valuable troubleshooting technique. For example, when trying to find the cause of an unwanted glitch in your test circuit, trigger on the glitch and make the pretrigger period large enough to capture the data before the glitch. By analyzing what happened before the glitch, you may uncover clues about its source.

## Slope and Threshold

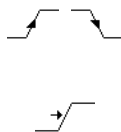

The slope control determines whether the logic scope finds the trigger point on the rising or the falling edge of a signal. (See Figure 2-3.)

You set trigger slope by selecting Slope in the Main Trigger menu and then selecting from the rising or falling slope icons in the side menu that appears.

The threshold control determines where on that edge the trigger point occurs. (See Figure 2-3.)

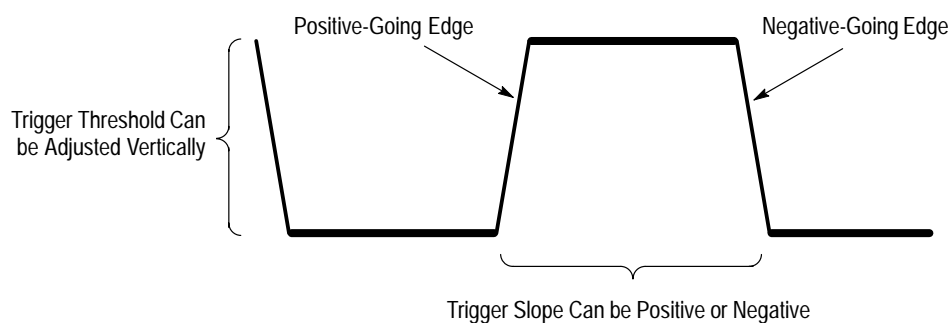

**Figure 2-3: Slope and Level Controls Help Define the Trigger**

The logic scope lets you set the main trigger level with the trigger THRESHOLD knob (pulse and edge triggers only).

## Delayed Trigger

As mentioned earlier in this section, there is also a delayed trigger system that provides all the functions of the main trigger. When using the delayed time base, you can also delay the acquisition of a waveform for a user-specified time or a user-specified number of delayed trigger events (or both) after a main trigger event.

## To Find More Information

See *Triggering After Delay*, on page 3–121, to learn about taking acquisition that are delayed by time or events from the main trigger event.

See *Trigger on Edges*, on page 3–127, to learn how to trigger on the edge of a input signal.

See *Triggering on Patterns*, on page 3–131, to learn how to trigger on an input pattern of logic levels you define.

See *Triggering on Pulses*, on page 3–141, to learn how to trigger on or ignore glitches and pulses based on their duration.

See *Triggering on a Sequence*, on page 3–147, to learn how to trigger on a sequence of two patterns of logic levels.

See *Triggering on Signals*, on page 3–159, to learn about the trigger controls and features that are common to several or all five trigger types.

See *Triggering on States*, on page 3–165, to learn how to trigger on an input pattern of logic levels that are TRUE at the active edge of a clock signal.

# Acquisition

Acquisition is the process of sampling the analog input signal, converting it into digital data, and assembling it into a waveform record. The TLS 216 Logic Scope creates a digital representation of the input signal by sampling the voltage level of the signal at regular time intervals. (See Figure 2-4.)

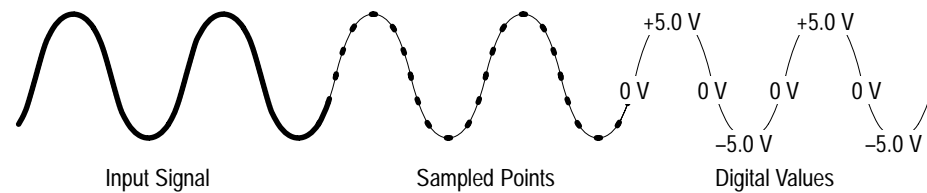

**Figure 2-4: Acquisition: Input Analog Signal, Sample, and Digitize**

The sampled points are stored in memory along with corresponding timing information. You can use this digital representation of the signal for display, measurements, or further processing.

You specify how the logic scope acquires data points and assembles them into a waveform record.

## Sampling and Digitizing

The trigger point marks time zero in a waveform record. All record points before the trigger event make up the pretrigger portion of the waveform record. Every record point after the trigger event is part of the posttrigger portion. All timing measurements in the waveform record are made relative to the trigger event.

Each time the logic scope takes a sample, it digitizes it to produce a numeric representation of the signal.

The logic scope creates a waveform record containing a user-specified number of data points. Each record point represents a certain voltage level that occurs a determined amount of time from the trigger event.

### Record Length

The record length determines the number of points that make up the waveform record. Use the record length in the Horizontal menu. The logic scope provides record lengths of 500, 1000, and 2000 points.

**Sampling** Sampling is the process of converting the analog input signal to digital data for display and processing. (See Figure 2-5.)

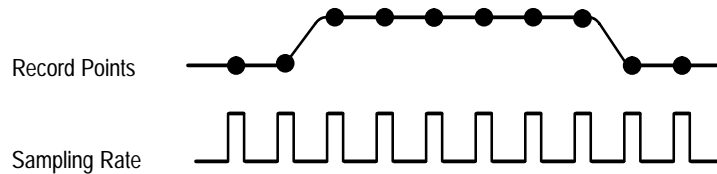

**Figure 2-5: Real-Time Sampling**

Two factors that affect real-time sampling are *interleaving* and *interpolation*.

**Interpolation** Turning the Horizontal SCALE knob clockwise causes the scope to assign shorter time periods to the waveform record. The smaller the time period gets, the faster the logic scope needs to acquire record points to fill up the record.

If you turn the Horizontal SCALE knob to a point that the time base is faster than 25 ns, the logic scope will not acquire enough samples for a complete waveform record. When that happens, the logic scope uses a process called interpolation to create the intervening points in the waveform record. There are two options for interpolation: linear or  $\sin(x)/x$ .

*Linear interpolation* computes record points between the samples acquired by using a straight line fit. It assumes all the interpolated points fall in their appropriate point in time on that straight line. Linear interpolation is useful for many waveforms such as pulse trains.

*Sin(x)/x interpolation* computes record points using a curve fit between the actual values acquired. It assumes all the interpolated points fall along that curve. That is particularly useful when acquiring more rounded waveforms such as sine waves. Actually, it is appropriate for general use, although it may introduce some overshoot or undershoot in signals with fast rise times.

---

**NOTE.** When using either type of interpolation, you may wish to set the display style so that the real samples are displayed intensified relative to the interpolated samples. The instructions under To Choose a Display Style on page 3–36 explain how to turn on intensified samples.

---

## Acquisition Modes

The logic scope supports three acquisition modes.

- Sample
- Envelope
- Average

Sample acquisition mode, which acquires in real time, is the mode most commonly used. You can read about Sample and the other acquisition modes in *Choosing an Acquisition Mode*, beginning on page 3–17.

## Bandwidth

*Bandwidth* refers to the range of frequencies that the logic scope can acquire and display accurately (that is, with less than 3 dB attenuation).

You can set different bandwidths with the logic scope. Lower bandwidth settings let you eliminate the higher frequency components of a signal. The TLS 216 offers Full (500 MHz) and 20 MHz bandwidth settings.

## Coupling

The TLS 216 Logic Scope provides DC coupling for all input channels. The input resistance of each channel is 1 M $\Omega$  at the probe tip or 50  $\Omega$  with the optional coaxial adapter.

## To Find More Information

See *Choosing an Acquisition Mode*, on page 3–17, to learn how to select the best acquisition mode to suit your measurement task.





# Scaling and Positioning Waveforms

Scaling and positioning waveforms means increasing or decreasing their displayed size and moving them up, down, right, and left on the display. Since the TLS 216 Logic Scope controls *groups* of waveforms, it scales and positions all waveforms in the group at the same time. This section discusses how to scale and position waveform groups in Analog mode.

Two display icons, the group indicator and the record view, help you quickly see the position of the waveform in the display. (See Figure 2-6.) The ground reference icon points to the ground level for all waveforms in the group (display mode must be set to analog) when group offset is set to 0 V. When you change vertical scale, each waveform in the group contracts or expands around this level. The record view, at the top of the display, indicates where the trigger occurs and what part of the waveform record is displayed.

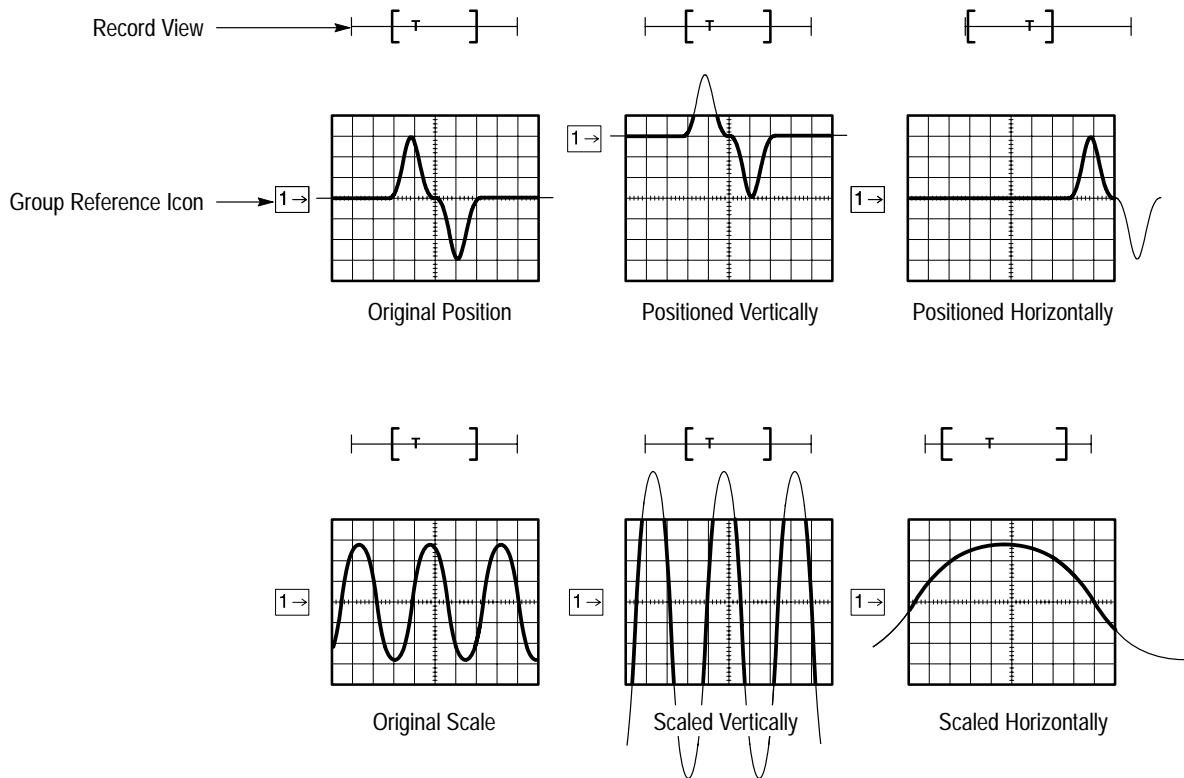

Figure 2-6: Scaling and Positioning

## Vertical System

You can adjust the vertical position of the selected waveform group by moving it up or down on the display. For example, when trying to compare two groups of waveforms, you can put one above another and compare them, or you can overlay them on top of each other. To move the selected waveform group, turn the Vertical POSITION knob.

Besides using the position knob, you can set the vertical position to an exact number. You do that with the Position selection in the Vertical menu and the general purpose knob and/or the keypad.

**Scale** You can also alter the vertical scale. The logic scope shows the scale (in volts per division) for each active group of channels toward the bottom left of the display. As you turn the vertical SCALE knob clockwise, the scale decreases. The decreased scale results in higher resolution because you see a smaller part of each waveform. As you turn the knob counterclockwise, the scale increases allowing you to see more of each waveform but with lower resolution.

**Offset** Vertical offset changes where the group reference indicator is shown with respect to the graticule. Offset adds a voltage to the reference indicator without changing the scale. That feature allows you to move the waveform group up and down over a large area without decreasing the resolution.

Offset is useful in cases where a waveform has a DC bias. One example is looking at a small ripple on a power supply output. You may be trying to look at a 100 mV ripple on top of a 12 V supply. The range available with offset can prove valuable as you try to move and scale the ripple to meet your needs.

## Horizontal System

Adjusting the horizontal position of waveform groups moves them right or left on the display. That is useful when the record length of a waveform is so large (greater than 500 points) that the logic scope cannot display the entire waveform record at one time.

You can also adjust the scale of the waveform. For example, you might want to see just one cycle of a waveform to measure the overshoot on its rising edge.

You adjust the horizontal scale of the displayed waveform records using the horizontal SCALE knob and the horizontal position using the horizontal POSITION knob.

The logic scope shows the actual scale in the bottom right of the display. The scale readout shows the time per division used. Since all groups containing live

(as opposed to saved reference) waveforms use the same time base, the logic scope only displays one value for all the active channels.

### Aliasing

When aliasing happens, you see a waveform with a frequency lower than the actual waveform being input or a waveform that is not stable even though the light next to TRIG'D is lit. Aliasing occurs because the logic scope cannot sample the signal fast enough to construct an accurate waveform record (Figure 2-7).

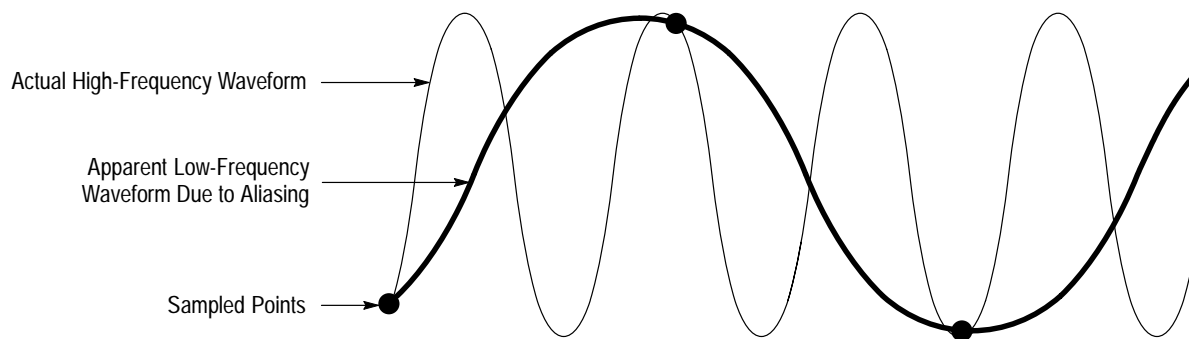

Figure 2-7: Aliasing

One simple way to check for aliasing is to slowly change the horizontal scale (time per division setting). If the shape of the displayed waveform changes drastically, you may have aliasing.

In order to represent a signal accurately and avoid aliasing, you must sample the signal more than twice as fast as the highest frequency component. For example, a signal with frequency components of 500 MHz would need to be sampled at a rate faster than 1 Gigasamples/second.

There are various ways to prevent aliasing. Try adjusting the horizontal scale, or simply press the AUTOSET button. You can also counteract some aliasing by changing the acquisition mode in the Acquisition menu. For example, if you are using the sample mode and suspect aliasing, try changing to envelope mode. Since the envelope mode searches for multiple acquisitions with the highest and lowest values, it can detect faster signal components over time.

### Delayed Time Base

You can set a main time base and a delayed time base. Each time base has its own trigger. There are two types of delayed time base acquisitions, with each based on its triggering relationship to the main time base. These are delayed runs after main and delay triggerable (after time, events, or both) acquisitions.

The delayed time base is useful in catching events that follow other events. See *Triggering* on page 2-13 for more information on the delayed trigger.

## Zoom

You can use zoom to see more detail without changing the acquired signal. When you use zoom, a portion of the waveform record can be expanded or compressed on the display, but the record points stay the same. When expanding waveforms vertically, zoom expands all waveforms in the selected group.

To display the cursor menu, press the ZOOM button. Use zoom when you wish to temporarily expand a waveform to inspect small feature(s) on that waveform. For example, to temporarily expand the front corner of a pulse to inspect its aberrations, use zoom to expand it horizontally and vertically. After you are finished, you can return to your original horizontal scale setting by pressing one menu button. (The zoom feature is also handy if you have acquired a waveform while using the fastest time per division and want to further expand it horizontally.)

## Autoset

Autoset lets you quickly obtain a stable waveform display. It automatically adjusts a wide variety of settings including vertical and horizontal scaling. Other settings affected include trigger coupling, type, position, slope, mode, and display intensities. *Autosetting the Logic Scope* on page 3–13 describes in detail what autoset does.

## To Find More Information

See *Autosetting the Logic Scope*, on page 3–13 to learn how to execute an Autoset and the setup defaults it puts into effect.

See *Adjusting the Horizontal Setup*, on page 3–3.

See *Adjusting the Vertical Setup*, on page 3–7.

See *Choosing a Group Display Mode*, on page 3–23, to learn how to vertically size waveform groups in BusForm and Timing Diagram display modes.

See *Triggering After Delay*, on page 3–121, to learn how to set up to capture an event that occurs after another.

See *Zooming on Waveforms*, on page 3–175, to learn how to magnify on screen the waveform groups you acquire.

# Measurements

The TLS 216 Logic Scope not only displays graphs of voltage versus time, it also can help you measure the displayed information. (See Figure 2-8.)

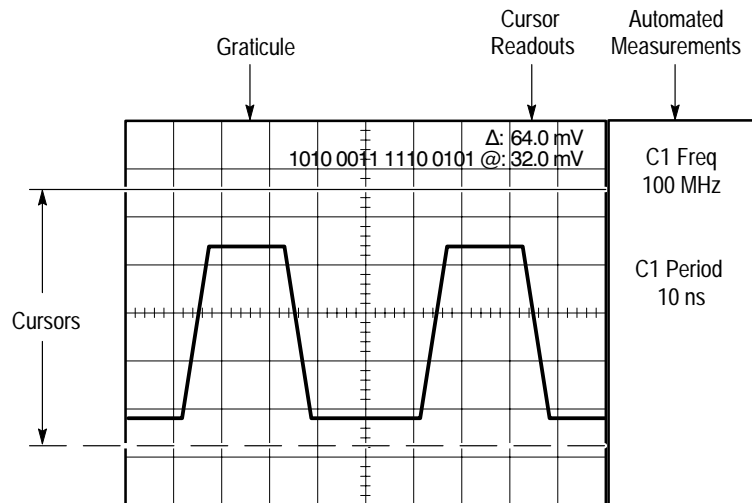

Figure 2-8: Graticule, Cursor, and Automated Measurements

## Measurement Classes

The logic scope provides three measurement classes. They are: graticules, cursors, and automated measurements. Each of these classes, or tools, can measure individual waveforms in any waveform group you select.

### Graticule Measurements

Graticule measurements provide you with quick, visual estimates. For example, you might look at a waveform amplitude and say “it is a little more than 100 mV.”

You can perform simple measurements by counting the number of major and minor graticule divisions involved and multiplying by the scale factor.

For example, if you counted five major vertical graticule divisions between a minimum and maximum values of a waveform and knew you had a scale factor of 100 mV/division, then you could easily calculate your peak-to-peak voltage:

$$5 \text{ divisions} \times 100 \text{ mV/division} = 500 \text{ mV.}$$

### Cursor Measurements

Cursors are fast and easy-to-understand measurements. You take measurements by moving the cursors and reading their numeric values from the on screen readouts, which update as you adjust their positions.

Cursors appear in pairs. One part of the pair is *active* and the other *inactive*. You move the active cursor (the solid line) using the general purpose knob. The SELECT button lets you select (toggle) which cursor bar is active or inactive. The inactive cursor is a dashed line on the display.

To display the cursor menu, press the CURSOR button. There are three kinds of cursors available in that menu:

- Horizontal bar cursors measure vertical parameters (typically volts).
- Vertical bar cursors measure horizontal parameters (typically time or frequency). They also measure the binary value at the selected cursor for the selected group of waveforms. (See *Measuring Waveforms with Cursors* on page 3–81 for more information on binary cursor measurements.)
- Paired cursors measure both vertical parameters (typically volts) and horizontal parameters (typically time or frequency).

There are also two modes for cursor operation available in the cursor menu: *independent* and *tracking*. (See Figure 2-9.)

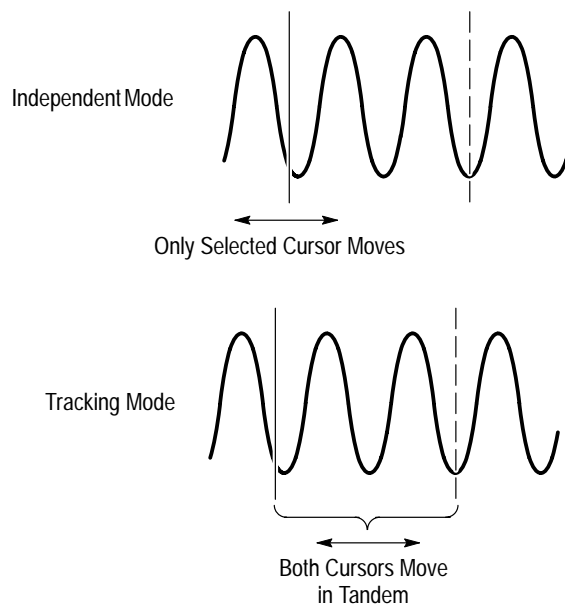

Figure 2-9: Cursor Modes

- Independent mode cursors operate as was earlier described; that is, you move *one* cursor at a time (the active cursor) using the general purpose knob, and you use the SELECT button to toggle which cursor bar is active.
- Tracking mode cursors operate in tandem: you move *both* cursors at the same time using the general purpose knob. To adjust the solid cursor relative to the dashed cursor, you push the SELECT button to suspend cursor tracking and use the general purpose knob to make the adjustment. A second push toggles the cursors back to tracking.

You can read more detailed information about how to use cursors in *Measuring Waveforms with Cursors*, beginning on page 3–81.

## Automated Measurements

You make automated measurements merely by pressing a few buttons. The logic scope does all the calculating for you. Because these measurements use the waveform record points, they are more accurate than cursor or graticule measurements.

Press the MEASURE button for the automated measurement menus. These menus let you make *amplitude* (typically in volts; sometimes in %), *time* (typically in seconds or hertz), and *area* (in volt-seconds) measurements.

Although the logic scope scales and positions waveforms in groups, it takes automated measurements on or between individual waveforms. You can select and display up to four measurements, each taken on an individual waveform channel, at a time. (Some measurements, such as Setup, Hold, and Skew, are taken on more than one waveform. See Table 3–3 on page 3–68 for a list of all the automatic measurements and their definitions.)

You can make automated measurements on the entire waveform record or just on a specific part. The gating selection in the Measurement menu lets you use the vertical cursors to limit the measurement to a section of the waveform record.

The snapshot selection in the Measurement menu lets you display almost all of the measurements at once. You can read about snapshot under *To Take a Snapshot of Measurements* on page 3–78.

Automated measurements use readouts to show measurement status. These readouts are updated as the logic scope acquires new data or if you change settings.

## To Find More Information

See *Appendix B: Algorithms*, for details on how the logic scope calculates each automatic measurement.

See *Example 3: Automated Measurements*, on page 1–23, for a tutorial on automatic measurements.

See *Measuring Waveforms Automatically*, on page 3–67, to learn more detail about taking automatic measurements.

See *Measuring Waveforms with Cursors*, on page 3–81, to learn how to take cursor measurements.





# Overview

This section contains articles that describe the details of operating the logic scope. Each article describes an operating task, such as adjusting the vertical setup or measuring waveforms with cursors. Each article appears in the order listed below. Use this section to answer specific questions about instrument operation. The operating tasks include:

- Adjusting the Horizontal Setup
- Adjusting the Vertical Setup
- Autosetting the Logic Scope
- Choosing an Acquisition Mode
- Choosing a Group Display Mode
- Communicating with Remote Instruments
- Customizing the Display
- Customizing the Display Colors
- Doing a Probe Cal
- Doing a Signal Path Compensation
- Grouping Waveforms
- Managing the File System
- Measuring Waveforms Automatically
- Measuring Waveforms with Cursors
- Printing a Hardcopy
- Probing of Circuits
- Saving and Recalling Setups
- Saving and Recalling Waveforms
- Selecting Groups and Channels
- Triggering After Delay
- Triggering on Edges
- Triggering on Patterns

- Triggering on Pulses
- Triggering on a Sequence
- Triggering on Signals
- Triggering on States
- Viewing Help
- Viewing Status
- Zooming on Waveforms

---

**NOTE.** *Many of these operating tasks list steps you perform to accomplish the task. You should read Conventions in the Preface to this manual before reading about these tasks.*

---

# Adjusting the Horizontal Setup

The TLS 216 Logic Scope lets you scale (change the time base) and position waveform groups horizontally on the screen. To perform these basic operations, you use the horizontal knobs and menu.

This article describes how to check the current horizontal setup and how to use the horizontal controls to scale, position, select a main or delayed time base, set the trigger position, set the group record length, and make other horizontal settings.

## To Scale and Position

You can adjust the horizontal scale and position of waveform groups in the display from the front panel without accessing menus.

To horizontally scale (size) any waveform group displayed, turn the Horizontal **SCALE** knob. (See Figure 3-1).

Changing the horizontal scale changes the time base, or time per division setting. By changing the horizontal scale, you can horizontally spread the particular portion of the waveform on which you wish to focus over more of the display screen.

To horizontally position any waveform group displayed, turn the Horizontal **POSITION** knob. (See Figure 3-1).

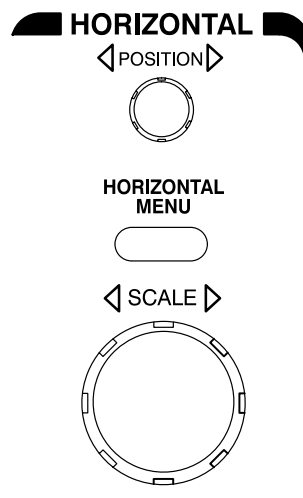

Figure 3-1: Horizontal Controls

To adjust the horizontal position more quickly, press the **SHIFT** button. When the label above the shift button lights and the display reads *Coarse Knobs* in the upper right corner, the Horizontal POSITION knob speeds up significantly.

By adjusting the horizontal position, you can move the group right or left to see different portions of it. For those waveform groups with record lengths longer than the display, the Horizontal POSITION knob can bring any off-screen portion on to the screen for viewing.

When you use either the Horizontal SCALE or POSITION knobs, you will affect all the waveform records in all groups displayed, including those that have their display mode set to off.

## To Check Horizontal Settings

To quickly determine the horizontal scale, check the *Time Base Readout* at the lower right corner of the display. It shows the time/division settings and the time base — main (M), delayed (D), or both (M and D). (See Figure 3-2).

To quickly determine the size and location of the waveform record, check the *Record View* at the top of the display. The square bracketed area of this readout represents the display. The Record View also shows the location of the trigger point relative to the display. (See Figure 3-2.) (It also shows cursor location if cursors are turned on.)

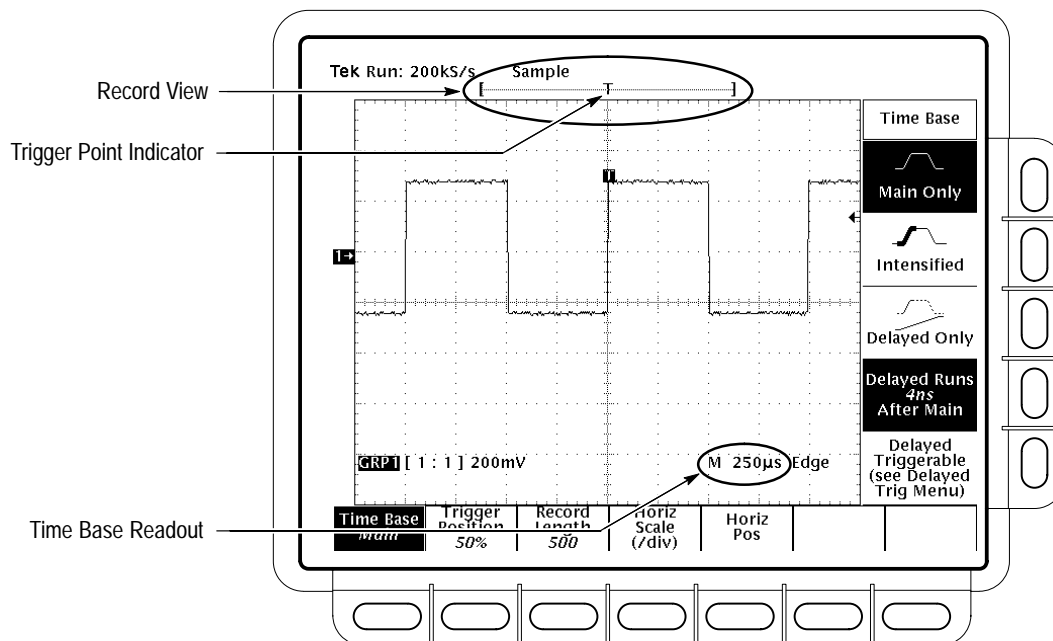

Figure 3-2: Record View and Time Base Readout

To check on the overall horizontal setup, press the **SHIFT → STATUS → System** (main) → **System** (side).

## To Set Up from Menus

Use the horizontal menu to select either a main or delayed time base for viewing acquisitions, to set the acquisition record length, and to set the trigger position in the acquisition. You can also change horizontal position or scale from the horizontal menu.

### Choose the Main or Delayed Time Base

To select between the Main and Delayed views of the time base, press **HORIZONTAL MENU → Time Base** (main) → **Main Only, Intensified, or Delayed Only** (side).

By pressing Intensified, you display a colored zone that shows where the delayed trigger record length *could* occur relative to the main trigger. The start of the intensified zone corresponds to the possible start point of the delayed trigger. The end of the zone corresponds to the end of the waveform record.

You also can select Delayed Runs After Main or Delayed Triggerable. For more information on how to use these two menu items, see *Triggering After Delay* on page 3–121.

### Set the Trigger Position

To define how much of the record will be pretrigger and how much will be posttrigger information, press **HORIZONTAL MENU → Trigger Position** (main) → **Set to 20%, Set to 50%, or Set to 80%** (side), or press **Pretrigger** (side) and use the general purpose knob or the keypad to set the amount of pretrigger.

### Set the Record Length and Fit To Screen

To set the waveform record length, press **HORIZONTAL MENU → Record Length** (main). Choose among the various record length choices appearing in the side menu.

To fit an acquired waveform to the visible screen, press **HORIZONTAL MENU → Record Length** (main). Then toggle **Fit to Screen** to ON from the side menu. To turn off this feature, toggle **Fit to Screen** to OFF.

Using Fit to Screen is similar to using Zoom mode and changing the Horizontal Scale setting until the waveform fits the screen.

### Set the Horizontal Scale

To change the horizontal scale (time per division) numerically in the menu instead of using the Horizontal **SCALE** knob, press **HORIZONTAL MENU → Horiz Scale** (main) → **Main Scale or Delayed Scale** (side), and use the keypad or the general purpose knob to change the scale values.

### **Set the Horizontal Position**

To set the horizontal position to specific values in the menu instead of using the Horizontal **POSITION** knob, press **HORIZONTAL MENU** → **Horiz Pos** (main) → **Set to 10%**, **Set to 50%** or **Set to 90%** (side). The percent you set determines how much of the waveform will be displayed to the left of the display center.

You can also control whether changing the horizontal position setting affects all displayed waveforms, just the live waveforms, or only the selected waveform group. The Horizontal Lock setting in the Zoom menu determines which waveforms the horizontal position knob adjusts whether zoom is on or not. Specifically, it acts as follows:

*Group* — only the waveform group currently selected can be zoomed and positioned horizontally

*Live* — all groups except reference groups can be zoomed and positioned horizontally at the same time. If a reference group is selected, only that reference group will be positioned.

*All* — all groups including reference groups can be zoomed and positioned horizontally at the same time

See *Zooming on Waveforms*, on page 3–175 for the steps to set the horizontal lock feature.

## **To Find More Information**

See *Scaling and Positioning Waveforms*, on page 2–23.

See *Triggering After Delay*, on page 3–121.

See *Zooming on Waveforms*, on page 3–175.

# Adjusting the Vertical Setup

The TLS 216 Logic Scope allows you to scale (change the volts/division setting), position, and otherwise control waveform groups vertically on the screen. To perform these basic operations, you use the vertical knobs and the Group menu.

This article describes how to check the current vertical setup and how to use the vertical controls to scale, position, offset, and set the bandwidth limit of any waveform group you select. (See *Selecting a Group and Channel*, on page 3–117 to learn how to select a group.)

## To Understand the Vertical Controls

To effectively use the vertical controls, consider how they operate with regard to the group display mode:

- The vertical position, bandwidth, and offset controls operate directly on the *selected* group regardless of its display mode: Analog, BusForm, or Timing Diagram.
- A group displayed in Analog mode changes vertical size on screen directly with the Vertical Scale knob. The Vertical Scale knob adjusts the vertical scale of the acquisition hardware regardless of the group display mode.
- A group displayed in either BusForm or Timing Diagram mode has its vertical display size set independently of the vertical scale. You set it directly in divisions of difference between the logic HIGH and LOW values these two modes display.

### Clipping

Vertical scale settings that result in input signal levels that drive the acquisition hardware beyond  $\pm$ five divisions of its ground reference level (center screen, with vertical position and offset set to zero) become clipped. Clipped waveform groups cause the notice “Clipping” to appear above the Vertical Readout, in the lower left corner of the display. In such a case, adjust the vertical scale (or offset) until the notice disappears.

### Vertical Scaling vs. Display Mode

Just because the vertical scale setting does not directly control the size of BusForm and Timing Diagram groups, does not mean you should ignore it. Groups with waveforms clipped in Analog mode are clipped when delivered for comparison against the display threshold levels in BusForm and Timing Diagram modes. Clipped input signals may compare incorrectly and therefore result in an incorrect digital representation of the input signals. (See *Choosing a Group*



*Display Mode* on page 3–23 for information on BusForm and Timing Diagram mode groups.)

## To Scale and Position Waveform Groups

You can adjust the vertical scale and position of the waveform groups in the display from the front panel without accessing menus.

To vertically scale the selected waveform group, turn the Vertical **SCALE** knob. This knob controls the vertical size of the selected group only if its group display mode is Analog. (See Figure 3-3.)

Changing the vertical scale changes the volts per division setting. By changing the vertical scale of a group displayed in analog format, you vertically expand or contract all waveforms in the group.

To vertically position the selected group, turn the Vertical **POSITION** knob. (See Figure 3-3.) This knob controls only the selected group and operates independently of the display mode.

To adjust the vertical position more quickly, press the **SHIFT** button. When the light above the SHIFT button is on and the display says *Coarse Knobs* in the upper right corner, the Horizontal POSITION knob speeds up significantly.

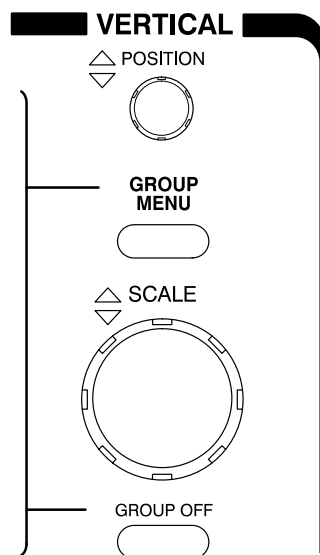

Figure 3-3: Vertical Controls

---

**NOTE.** Vertical positioning is a display function. Changing position simply moves the ground reference level of a group above or below the zero position level (center screen). You also can adjust the group position by adjusting the offset using the Vertical Controls menu (discussed later in this article). See **NOTE** on page 3–10.

---

## To Check Vertical Settings

To quickly determine the vertical scale for the selected group, check the *Vertical Readout* at the bottom of the display. It lists each group by number and lists the last and first channel of each group.

If the group display mode is Analog, the readout also shows the group volts/division setting. If the group display mode is Off, BusForm, or Timing Diagram, **OFF**, **Bus**, or **Timing** replaces its volts/division readout. (See Figure 3-4.)

---

**NOTE.** The *Vertical Readout* varies its display based on the logic scope setup. See *To Check Group Settings* on page 3–56 for a complete description of the *Vertical Readout*.

---

To check on overall vertical setup, press **SHIFT** → **STATUS** → **Waveform** (main) → **Groups** (side).

## To Set Up from the Vertical Controls Menu

To access the Vertical Controls menu, press **GROUP MENU** → **Vertical Controls** (main). (See Figure 3-4.) Use this menu to set vertical offset and bandwidth (full or limited) of the selected group. You can also change the vertical position to a specific number of divisions from center screen from this menu instead of using the Vertical POSITION knob.

### Set the Bandwidth

To include or eliminate the higher frequency components, change the bandwidth of the selected group.

1. Press **GROUP MENU** → **Vertical Controls** (main).
2. Toggle **Bandwidth** (side) to **Full** or **20 MHz**.

### Adjust Position

To set the vertical position, press **GROUP MENU** → **Vertical Controls** (main) → **Position** (side) and use the general purpose knob or keypad to set position in divisions. Press **Set to Position 0 divs** (side) if you want to reset the position of the selected group to center screen.

**Adjust Offset** To set the vertical offset, press **GROUP MENU** → **Vertical Controls** (main) → **Offset** (side) and use the general purpose knob or keypad. Press **Set to Offset to 0 V** (side) if you want to reset the offset to zero.

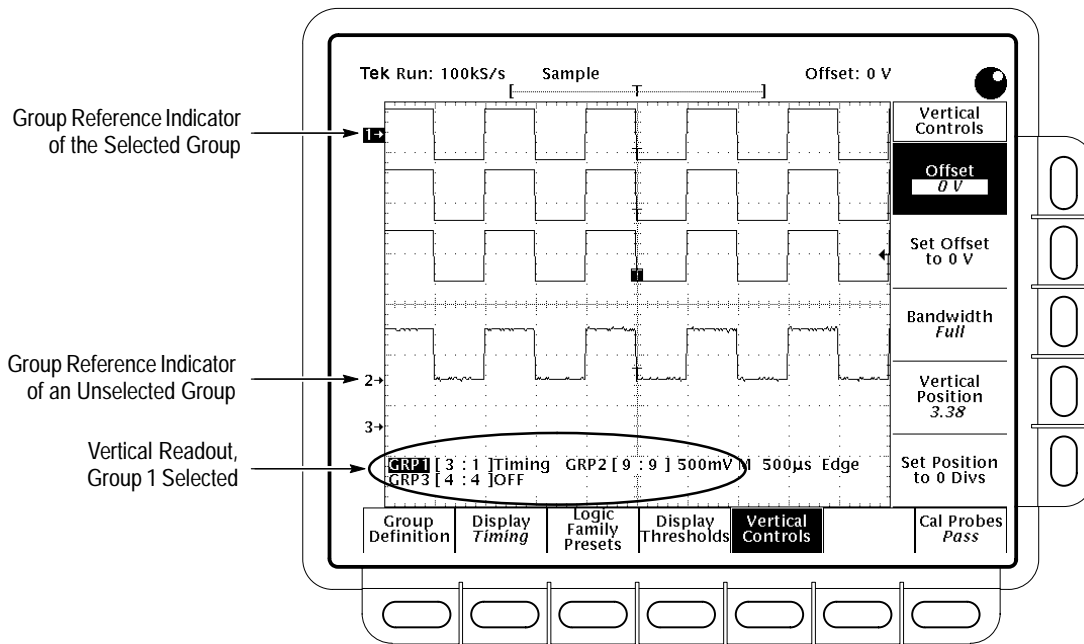

**Figure 3-4: Vertical Readout and Vertical Controls Menu**

Offset lets you subtract DC bias from the waveform. By subtracting the DC Bias, you can ignore it and set the vertical scale to properly size the AC components. For example, you might be trying to measure a small AC ripple on a power supply output. It may be a 100 mV ripple on top of a 5 V supply. Using offset, you can offset the DC bias and set the scale to best display the ripple.

**NOTE.** Unlike vertical position, vertical offset is not a function of the display system. Changing offset adds an offset voltage to the acquisition system hardware to compensate for DC bias. Changing position simply adjusts the display. Positioning cannot compensate for DC bias.

## To Find More Information

See *Choosing a Group Display Mode*, on page 3–23.

See *Grouping Waveforms*, on page 3–55.

See *Selecting Groups and Channels*, on page 3–117.

See *Scaling and Positioning Waveforms*, on page 2–23.

See *Zooming on Waveforms*, on page 3–175.



# Autosetting the Logic Scope

The TLS 216 Logic Scope can autose on waveform groups to quickly obtain a stable display of a waveform of usable size. Once you select a group and its channel, a single button press sets up the front-panel controls based on the signal in that channel.

To use Autoset effectively, you need only learn a few rules that Autoset uses to set up the display. This article describes those rules, describes how to execute an Autoset, and lists the setup defaults in effect after an Autoset.

## To Understand Autoset

To understand Autoset, consider the general procedure the logic scope uses when autosetting on the selected group and its selected channel.

1. Autoset analyzes the currently selected channel in the currently selected group (Group 1 through Group 8).
2. Autoset attempts to classify the logic family of the group based on the minimum and maximum voltage levels it finds for the channel.
3. Autoset then sets the vertical scale, height, position, and offset, and the display thresholds,  $V_{high\ min}$  and  $V_{low\ max}$ , for all groups currently defined, to match the logic family it classifies for the channel it analyzes.
4. Autoset modifies the vertical scale, height, and position that it sets to accommodate the total number of channels it required to display.
5. Autoset then sets the display mode for all *live* groups to Timing Diagram.
6. Autoset sets horizontal scale and trigger threshold level based on the channel it analyzes.

Consider the rules the logic scope uses when autosetting on the selected group and its selected channel.

- Autoset only analyzes *live* groups, not reference groups.
- Autoset displays any reference group on screen at the time it executes; however, it does not change any of its parameters.
- Autoset does not create new acquisition groups unless all of the *live* groups, Group 1 through Group 8, have been deleted. In this case, the logic scope defines Group 1 to include only Channel 1 and then autosets based on this channel.

- Autoset displays all the *live* groups currently defined because, as described previously, it switches their display modes to Timing Diagram.

---

**NOTE.** Autoset may change vertical position in order to position the waveform group appropriately. It always sets vertical offset based on the selected channel in the selected group.

---

## To Autoset the Logic Scope

To Autoset on the waveform of your choice, do the following steps to select the group containing the waveform, select the waveform channel in that group, and execute Autoset.

1. Press the group selection button (such as **GROUP 1**) that contains the channel to make it active.
2. Press **GROUP MENU** → **Group Definition** (main) → **Selected Channel** (side).
3. Use the keypad to set the selected channel for the selected group.
4. Press **AUTOSET**.

Autoset always uses the selected channel in its selected group, no matter how many other groups are displayed.

If you use Autoset when none of groups 1 through 8 are displayed (that is, they have been deleted) the logic scope will create Group 1, define it to include only Channel 1, and Autoset based on that channel.

---

**NOTE.** After Autoset executes, channels other than the selected channel may appear as flat lines, have vertical and horizontal scale changes, and so on. These nonselected channels appear as just described because their display thresholds, vertical amplitude, frequency, and other characteristics differ greatly from those chosen for the selected channel. This is normal operation.

Because nonselected channels can be improperly vertically scaled, the message “Clipping” may appear. To tell if it is clipped, examine a channel after switching the group containing it to Analog display mode. If it is clipped, increase the volts/division setting.

---

## Autoset Defaults

Autoset makes adjustments in these categories of settings: Acquisition, Display, Horizontal, Trigger, and Vertical. Table 3–1 lists the Autoset defaults.

**Table 3–1: Autoset Defaults**

Control	Changed by Autoset to
Selected Group	Currently selected live group; if no group is defined, Group 1 is created and selected
Selected Channel	Currently selected channel in the currently selected group; if no group is defined, Group 1 is created and Ch 1 is selected
Acquire Mode	Sample
Acquire Stop After	RUN/STOP button only
Display Style	Vectors
Display Intensity — Overall	If less than 50%, set to 75%
Display Format	YT
Group Display Format	Timing Diagram
Group Display Height in Divs	$(8 - (0.2 \times \text{No. of Channels Displayed}))$ divided by the No. of Channels Displayed
Group Display Thresholds	Determined based on the currently selected channel in the currently selected group
Horizontal Position	Centered within the graticule window
Horizontal Scale	Determined based on the currently selected channel in the currently selected group
Horizontal Time Base	Main Only
Horizontal Record Length	Unchanged
Trigger Position	Unchanged
Trigger Type	Edge
Trigger Source	Currently selected channel in the currently selected group
Trigger Level	Midpoint of data for the trigger source
Trigger Slope	Positive
Trigger Holdoff	0
Vertical Scale	Determined based on the peak-peak amplitude of the currently selected channel in the currently selected group
Vertical Bandwidth	Full



**Table 3-1: Autoset Defaults (Cont.)**

<b>Control</b>	<b>Changed by Autoset to</b>
Vertical Offset	Determined based on the currently selected channel in the currently selected group
Zoom	Off

## To Find More Information

See *Adjusting the Vertical Scale* on page 3-7.

See *Choosing a Group Display Mode* on page 3-23.

See *Selecting Groups and Channels* on page 3-117.

# Choosing an Acquisition Mode

The TLS 216 Logic Scope provides three modes for acquiring signals, digitizing them, and displaying them as waveforms on screen. To choose from these modes, you need to understand how each mode acquires and processes the signals you input to the logic scope.

This article briefly describes each mode: how each acquisition mode operates, how to check acquisition mode and status, how to choose an acquisition mode, and how to start and stop acquisitions.

## To Understand the Acquisition Modes

To more effectively use the acquisition modes, take the following steps to become familiar with all three modes the logic scope uses to acquire data: *Sample*, *Envelope*, and *Average*.

1. Examine Figure 3-5 to get a quick overview of the different modes and lists the benefits of each. It will help you select the appropriate mode for your application.
2. Read the following descriptions of how each mode works. Knowing how each mode works helps you apply them properly to specific applications.

### Sample Mode



In Sample mode, the logic scope creates a record point by saving the first sample (of perhaps many) during each acquisition interval. (An acquisition interval is the time covered by the waveform record divided by the record length.) Sample mode is the default mode.

Sample mode operates in real time on a single trigger event, provided the logic scope can acquire enough samples for each trigger event.

### Envelope Mode



Envelope mode allows you to acquire and display a waveform record that shows the extremes in variation over several acquisitions. You specify the number of acquisitions over which to accumulate the data. The logic scope saves the highest and lowest values in two adjacent intervals. Envelope mode gathers peaks over many trigger events.

After each trigger event, the logic scope acquires data and then compares the min/max values from the current acquisition with those stored from previous acquisitions. The final display shows the most extreme values for all the acquisitions for each point in the waveform record.

Envelope mode only operates on multiple acquisitions.

**Average Mode**



Average mode allows you to acquire and display a waveform record that is the averaged result of several acquisitions. This mode reduces random noise. The logic scope acquires data after each trigger event using Sample mode. It then averages the record point from the current acquisition with those stored from previous acquisitions.

Average mode only operates on multiple acquisitions.

Single Waveform Acquisition	Takes One Acquisition per Trigger	Acquisition Mode	Waveform Drawn on CRT
		 <b>Sample</b> Uses first sample in each interval over single acquisition This is the default mode.	
Multiple Waveform Acquisitions	Takes a User-Specified Number of Acquisitions per Trigger	Acquisition Mode	Waveform Drawn on CRT
	Acquisition 1      2      3  Uses Sample Mode for Each Acquisition	 <b>Envelope</b> Finds highest and lowest record points over many acquisitions Use to reveal variations in the signal across time.	
Multiple Waveform Acquisitions	 Uses Sample Mode for Each Acquisition	 <b>Average</b> Calculates average value for each record point over many acquisitions Use to reduce apparent noise in a repetitive signal.	

Figure 3-5: How the Acquisition Modes Work

## To Check Acquisition Status

To quickly tell if the acquisition system is running or stopped, check the *Acquisition Readout* at the top of the display. (See Figure 3-6.) The “acquiring” state shows the sample rate and acquisition mode. The “stopped” state shows the number of acquisitions acquired since the last stop or major change.

To check on the overall horizontal setup, press **SHIFT** → **STATUS** → **System** (main) → **System** (side).

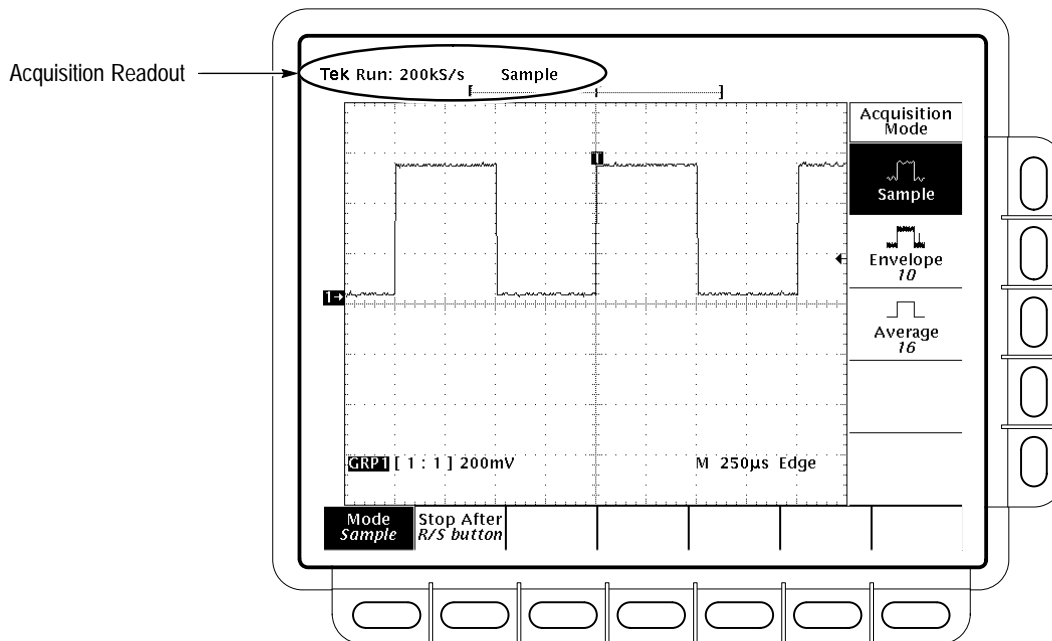

Figure 3-6: Acquisition Menu and Readout

## To Choose an Acquisition Mode

To bring up the acquisition menu (Figure 3-6), press **SHIFT** → **ACQUIRE MENU**.

### Select an Acquisition Mode

To choose how the logic scope will create points in the waveform record, press **SHIFT** → **ACQUIRE MENU** → **Mode** (main) → **Sample**, **Envelope**, or **Average** (side).

When you select **Envelope** or **Average**, you can enter the number of waveform records to be enveloped or averaged using the keypad or the general purpose knob.

**NOTE.** The logic scope interpolates between samples at horizontal scale settings faster than 25 ns/div. See Sampling and Digitizing on page 2–19 for a discussion of interpolation.

### Set Stop After Mode

To choose to acquire exactly one waveform sequence or to acquire waveforms continuously under manual control: press **SHIFT** → **ACQUIRE MENU** → **Stop After** (main) → **RUN/STOP button only** or **Single Acquisition Sequence** (side). (See Figure 3-7.) Make your selection based on the following criteria.

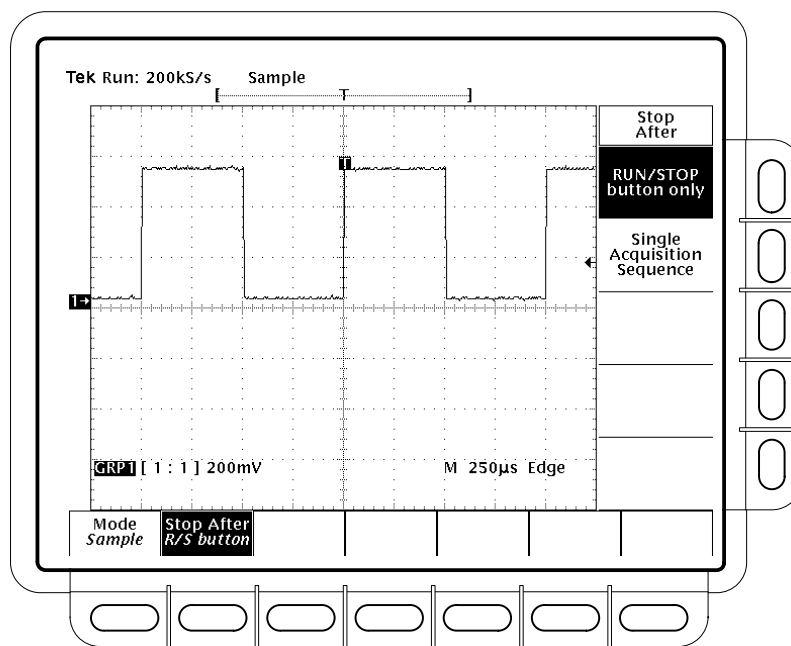

Figure 3-7: Acquire Menu — Stop After

- Press **RUN/STOP button only** (side) to use the **RUN/STOP** button to start and stop acquiring. Pressing the **RUN/STOP** button once will stop the acquisitions. The upper left hand corner in the display will say “Stopped” and show the number of acquisitions. If you press the button again, the logic scope will resume acquiring.
- Press **Single Acquisition Sequence** (side) to use the **RUN/STOP** button to run a single sequence of acquisitions. In Sample mode, the logic scope will acquire a waveform record with the first valid trigger event and stop.

In Envelope or Average mode, the logic scope will make the specified number of acquisitions to complete the averaging or enveloping task when taking a single sequence acquisition.

---

**NOTE.** *To quickly select Single Acquisition Sequence without displaying the Acquire and Stop After menus, press SHIFT, and then FORCE TRIG. Now the RUN/STOP button operates as just described. (You still must display the Acquire menu and then the Stop After menu to leave single acquisition sequence operation.)*

---

## To Find More Information

See *Acquisition*, on page 2–19.



# Choosing a Group Display Mode

The TLS 216 Logic Scope displays the waveform groups you define in your choice of three display modes: *Analog*, *BusForm*, and *Timing Diagram*. To understand which mode to use for your application, you must first consider how each mode affects the waveform data that a group displays on screen.

This article describes the three group display modes, how to identify the display mode for any group, and how to select a new mode for a group. Also, this article covers how to define group thresholds and set the display height for *BusForm* and *Timing Diagram* groups.

## To Understand Group Modes

To understand group display modes, consider how each mode displays waveforms.

*Analog* displays each waveform in the group as the analog of its input signal. All waveforms in the group have superimposed ground references. (See Figure 3-8.) Unlike for the following modes, the logic scope scales *Analog* groups vertically on screen when you use the Vertical SCALE knob. Also, the group reference indicator for the group (left side of screen) points to the ground reference level for the group in *Analog* mode if vertical offset is set to zero. Use *Analog* mode to measure the actual response of a group of waveforms.

*Analog* mode is the only group display mode that can be switched between a display of all the channels in a group and display of a single channel in a group.

*BusForm* displays each waveform in the group as one or more of three digital logic levels defined as HIGH, LOW, or indefinite (between HIGH and LOW). The level of each waveform displayed depends on how the instantaneous level of its input signal compares with two threshold levels that you define. (See Figure 3-8.) Use *BusForm* mode to measure the idealized response of waveforms with respect to defined thresholds.

As with *Analog* mode, all waveforms in the group have superimposed ground references. (The group reference indicator points to the midlevel for the group instead of the ground level.) However, in *BusForm* mode the logic scope does not display waveform height in volts/division but as a number of divisions between the HIGH and LOW levels (group height) that you specify. (However, see **NOTE** about clipping on page 3–28.) (See Figure 3-8.)

*Timing Diagram* displays each waveform in the group as one or more of three digital logic levels like *BusForm*. However, unlike *BusForm*, the logic scope vertically offsets the ground reference of each waveform, so that the waveforms are separated vertically on screen. (The group reference indicator points to the



midlevel of the last channel (highest numbered) include in the group.) Use Timing Diagram mode to measure timing relationships between the waveforms included in the group.

*OFF* removes the display of all waveforms in the group. Only the waveforms are turned off, the group ground reference, trigger position, and trigger bar indicators remain on screen. You can select, position, and scale a group regardless of whether it is on or off. Use Off to make room for other groups on screen without deleting the group.

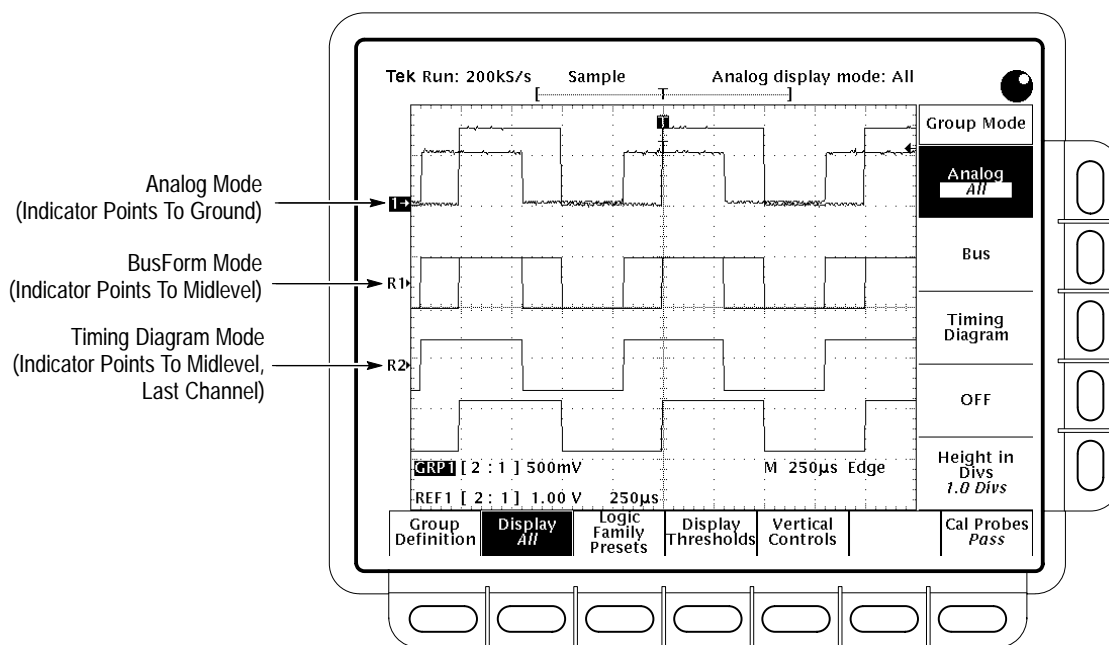

Figure 3-8: Display Modes

In Figure 3-8, the logic scope is displaying the same group (Group 1) of two waveforms in the different display modes. (Group 1 was saved to Ref 1 and Ref 2 and both reference groups were displayed in the modes indicated.) Note that while the Analog group shows the difference in amplitude between the overlapped waveforms, BusForm and Timing Diagram show the waveforms as if they had the same amplitudes. This difference occurs because the logic scope displays BusForm and Timing Diagram waveforms as HIGH or LOW logic levels based on their relationship to thresholds.

## To Check the Display Mode

To quickly determine the mode of any defined group, look at the Vertical Readout. It shows each group by number, along with the volts/division setting for each group displayed in Analog mode. Groups displayed in BusForm or Timing Diagram modes display *Bus* or *Timing* rather than the volts/division setting. (See Figure 3-8.)

**NOTE.** The Vertical Readout displays group readouts for one of two pages of groups at a time, where page one displays Group 1 through Group 4 and page two displays Group 5 through Group 8. To force the readout to display a certain page, select a group included in that page. Use the group selection buttons or the More menu to select the desired group.

**NOTE.** The Vertical Readout also varies its display in other ways based on the logic scope setup. See To Check Group Settings on page 3–56 for a complete description of the Vertical Readout.

To determine the overall status of all groups, press **SHIFT** → **STATUS** → **Waveform** (main) → **Groups** (side). (See Figure 3-9.)

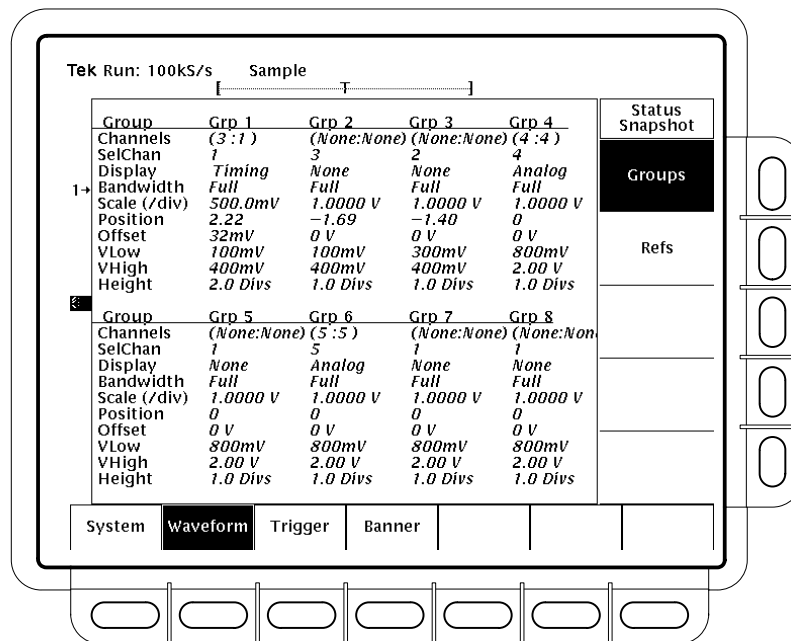

Figure 3-9: Snapshot of Group Status

## To Select a Group Mode

To select a group display mode, do the following steps.

1. Press any of group selection buttons **GROUP 1** through **GROUP 4** on the right side of the display. Or press **SHIFT**, and then press any of group selection buttons **GROUP 5** through **GROUP 8**. (The MORE button allows you to select internally stored Ref waveform groups for display and manipulation.)

The selected group is indicated by the lighted LED above each button.

2. Press **GROUP MENU** → **Display** (main) → **Analog, Bus, Timing Diagram**, or **OFF** (side). (See Figure 3-10.)

To read about the group display modes see *To Understand Group Display Modes* on page 3–23.

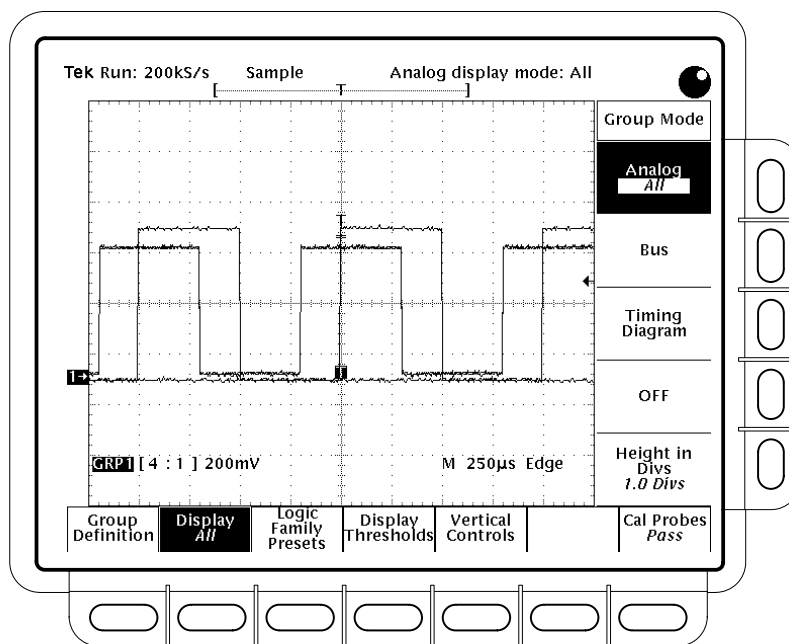

Figure 3-10: Group Display Mode Menu

## To Display Only the Selected Channel

For groups displayed in Analog mode, you can remove the display of all but the *selected* channel. To toggle between a display of all the channels in a group and a display of only the selected channel, do the following steps.

1. Press **GROUP MENU** → **Display** (main) → **Analog** (side).
2. Press **Analog** (side) again to toggle between the **All** and **Select** settings.

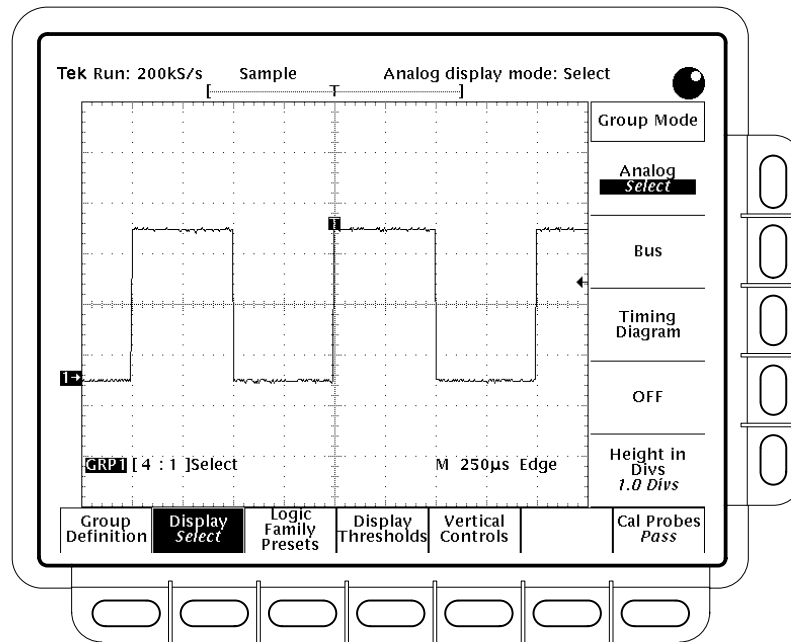

Figure 3-11: Group Display Mode Set to Analog Select

Note that the logic scope replaces the volt/division setting with the word *Select* when you toggle to that setting.

---

**NOTE.** You can change the selected channel using the Group Definition menu. (See *Selecting Groups and Channels on page 3-117.*)

---

## To Define Group Thresholds and Height

If displaying waveform groups in BusForm or Timing Diagram display mode, you must set the display thresholds and group height. To set these parameters for the currently selected group, do the following steps:

1. Press **GROUP MENU** → **Display Thresholds** (main).
2. Press **Vhigh, min** and use the general purpose knob or keypad to set the voltage level the waveform group must exceed to be displayed as a HIGH.
3. Press **Vlow, max** and use the general purpose knob or keypad to set the voltage level the waveform group must *not* exceed to be displayed as a LOW.

---

**NOTE.** You cannot set a Vhigh, min that is less than Vlow, max or a Vlow, max that is greater than Vhigh, min. When such a setting is attempted, the logic scope automatically adjusts both values to keep their relationship correct.

---

4. Press **Display Thresholds** (main) → **Height in Divs** (side) and use the keypad to set the height of all waveforms in the currently selected group.

---

**NOTE.** Although the Vertical Scale knob does not size BusForm and Timing Diagram mode groups on screen, you should set it to a level that displays your digital waveforms properly. For example, if your waveforms are clipped in Analog mode, they will be clipped in BusForm and Timing Diagram modes as well (“Clipping” appears on screen). Adjust the Vertical Scale knob until clipping stops.

---

To select preset **Vhigh, min** and **Vlow, max** thresholds that correspond to those of certain well-defined logic families, do the following step.

Press **GROUP MENU** → **Logic Family Presets** (main) (side) → **TTL, CMOS, +ECL, or -ECL** (side).

Table 3–2 lists the settings the logic scope adopts for the selected group for each logic family. Be aware that the selected family preset changes the vertical scale and offset settings even if the display mode for the group is Analog. So, if your vertical readout for a group is GRP1[1:1] 500 mV and you select TTL, the readout changes to GRP1[1:1] 1.00 V and the display offsets 1.4 volts relative to the group reference indicator.

Table 3–2: Logic Family Presets

Family	Vhigh, min	Vlow, max	Vertical Scale	Offset
TTL	2.0 V	0.8 V	1 V/div	1.4 V
CMOS	3.0 V	1.0 V	1 V/div	2.5 V
+ECL	3.9 V	3.5 V	200 mV/div	3.7 V
-ECL	-1.1 V	-1.4 V	200 mV/div	-1.3 V

To store and recall your own **Vhigh, min** and **Vlow, max** thresholds, do the following steps.

1. Do steps 1 through 3 on page 3–28 to set the display threshold levels you want to store for later recall.
2. Press **GROUP MENU** → **Logic Family Presets** (main) → **–more–** (side) → **Store User1 Preset** or **Store User2 Preset**. The logic scope saves the display threshold levels of the currently selected group.
3. Press **GROUP MENU** → **Logic Family Presets** (main) → **–more–** (side) → **Set to User1 Preset** or **Set to User2 Preset** to recall the stored user-defined display threshold presets for the currently selected group.

## To Remove a Group from the Display

To remove the display of a group, select the group and press the **GROUP OFF** button. (Alternately, you could set the display mode to Off in the Display Mode menu.) Removing the display of a group also removes from the display any automated measurements being made on any waveforms in that group.

When you turn off a group using the **GROUP OFF** button, the logic scope automatically selects the next highest priority group. Figure 3–5 on page 3–120 shows how the logic scope prioritizes waveforms. When you turn off a group using the Display Mode menu, it still remains the selected group.

## To Find More Information

See *Adjusting the Vertical Setup*, on page 3–7.

See *Grouping Waveforms*, on page 3–55.

See *Saving and Recalling Waveforms*, on page 3–109.

See *Selecting Groups and Channels*, on page 3–117.



# Communicating with Remote Instruments

The TLS 216 Logic Scope can connect into a system environment, so you can control it remotely or exchange measurement or waveform data between it and a computer. This article explains how to prepare and setup the logic scope for control and operation over the IEEE Std 488.2-1987 (GPIB) interface.

## To Prepare for Remote Operation

To transfer data between the logic scope and other instruments over the GPIB, do the following tasks to make sure the instruments support GPIB protocols and observe GPIB Interface requirements.

### Check for GPIB Protocols

Make sure the instruments to be connected support the GPIB protocols. These protocols cover:

- Remote instrument control
- Bidirectional data transfer
- Device compatibility
- Status and event reporting

To simplify the development of GPIB systems, include instruments that use Tektronix defined codes and formats for messages that travel over the GPIB. Each device that follows these codes and formats, such as the TLS 216 Logic Scope, supports standard commands. Use of instruments that support these commands can greatly simplify development of GPIB systems.

### Know the GPIB Interface Requirements

To prepare to connect the logic scope to GPIB networks, read and follow these rules:

- Connect no more than 15 devices, including the controller, to a single bus.
- Connect one device load every two meters (about six feet) of cable length to maintain bus electrical characteristics. (Generally, each instrument represents one device load on the bus.)
- Do not exceed 20 meters (about 65 feet) of the total cumulative cable length.
- Turn on at least two-thirds of the device loads present when you use your network.



- Include only one cable path between devices on your network. (See Figure 3-12.) Do not create loop configurations.

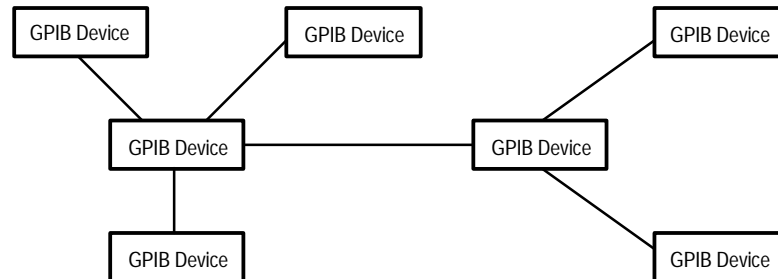
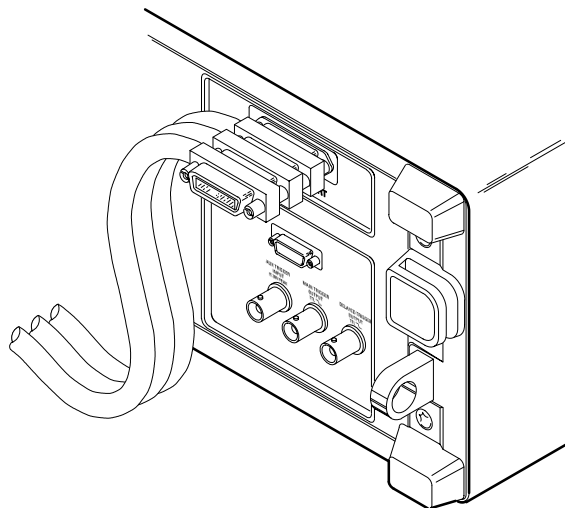

**Figure 3-12: Typical GPIB Network Configuration**

### Obtain the Proper Interconnect Cabling

To connect the logic scope to a GPIB network, obtain at least one GPIB cable. Connecting two GPIB devices requires an IEEE Std 488.1-1987 GPIB cable (available from Tektronix, part number 012-0991-00).

The standard GPIB cable connects to a 24-pin GPIB connector located on the rear panel of the logic scope. The connector has a D-type shell and conforms to IEEE Std 488.1-1987. You can stack GPIB connectors on top of each other. (See Figure 3-13.)



**Figure 3-13: Stacking GPIB Connectors**

## To Set Up for Remote Operation

To set up remote communications, be sure your setup will meet GPIB protocol and interface requirements just described. Then do the following procedures.

### Connect the Logic Scope to the GPIB

To connect the logic scope, plug an IEEE Std 488.2-1987 GPIB cable into the GPIB connector on the logic scope rear panel and into the GPIB port on your controller. (See Figure 3-14.)

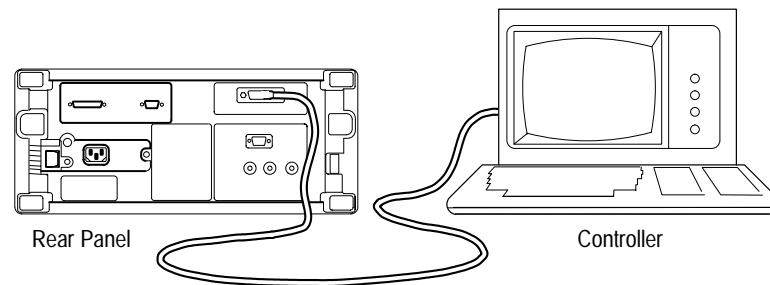

Figure 3-14: Connecting the Logic Scope to a Controller

### Select GPIB Port

To select the GPIB port, press **SHIFT** → **UTILITY** → **System** (main) → **I/O** (pop-up) → **Port** (main) → **GPIB** (pop-up).

### Configure the GPIB Port

You must set two important GPIB parameters: mode and address. To set those parameters:

Press **SHIFT** → **UTILITY** → **System** (main) → **I/O** (pop-up) → **Port** (main) → **GPIB** (pop-up) → **Configure** (main) → **Talk/Listen Address**, **Hardcopy (Talk Only)**, or **Off Bus** (side). (See Figure 3-15.)

*Talk/Listen Address* configures the port for controller-based system operation. Use the general purpose knob or the keypad to define the address.

*Hardcopy (Talk Only)* configures the port for the hardcopy output without controller supervision. Once so configured, the logic scope will send the hardcopy data to any listeners on the bus when the **HARDCOPY** button is pressed.

Pressing **HARDCOPY** with the port configured any other way causes an error, and the logic scope responds with a message saying the selected hardcopy port is currently unavailable.

*Off Bus* disconnects the logic scope from the bus.

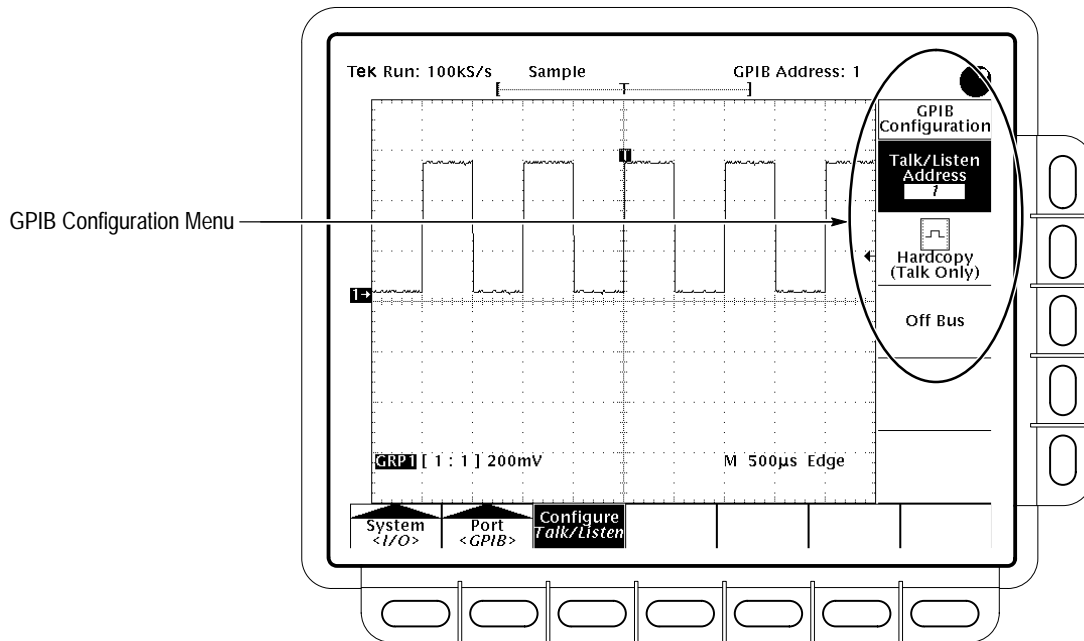

Figure 3-15: Utility Menu

## To Find More Information

See *Saving a Hardcopy*, on page 3–87.

See the *TLS 216 Programmer Manual*, Tektronix part number 070-8835-XX.

# Customizing the Display

The TLS 216 Logic Scope can display waveform groups in different ways. This article describes how to use the Display menu to adjust the logic scope display style, intensity level, and graticule. It also describes how to select among several display readout options.

## To Check Display Status

To quickly check the current display settings, press the **SHIFT** → **STATUS** → **System** (main) → **Display** (side). (See Figure 3-16.)

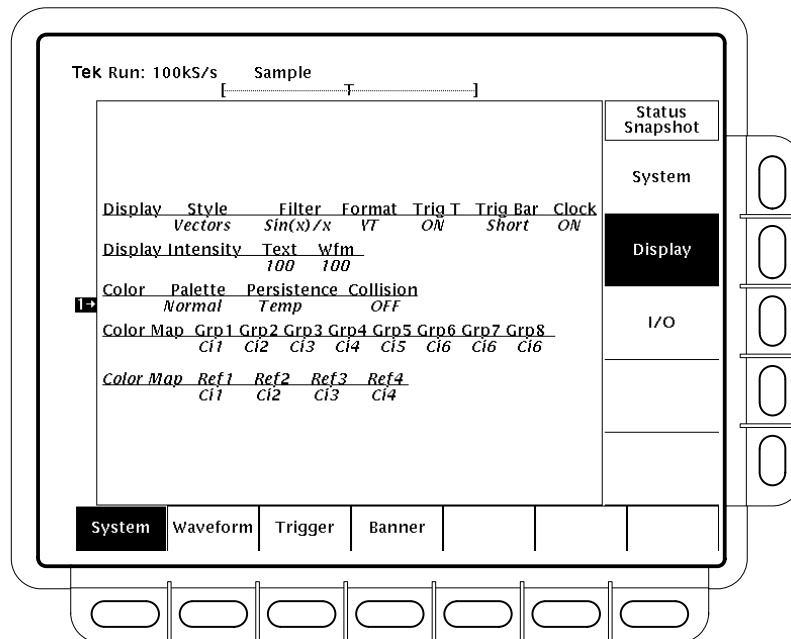

Figure 3-16: Snapshot of Display Status

## To Access Display Settings

To bring up the Display settings menu, press **DISPLAY** → **Settings** (main) → **Display** (pop-up).

The Display Settings menu allows you to change the style, intensity, graticule, readout options, and filter setup as described below. The Color Settings menu allows you to change color settings for various display components such as

waveforms and text. For more information on color, see *Customizing the Display Color* on page 3–41.

## To Choose a Display Style

To choose among the five display styles, press **DISPLAY** → **Style** (main) → **Vectors**, **Intensified Samples**, **Dots**, **Infinite Persistence**, or **Variable Persistence** (side) (Figure 3-17).

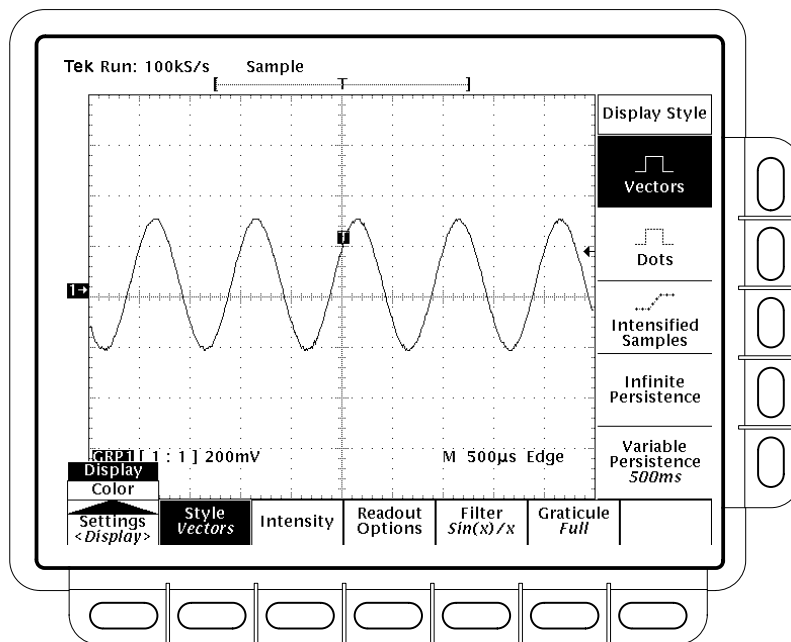

**Figure 3-17: Display Menu — Style Settings**



*Vectors* style displays vectors (lines) between the record points.



*Dots* style displays waveform record points as dots.



*Intensified Samples* style also displays waveform record points as dots. However, the points actually sampled are displayed in the Zone color. (That is, they appear in the color labeled “Zone” in the color palette currently in use. See *Customizing the Display Color* on page 3–41.)

In addition to choosing Intensified Samples in the side menu, the logic scope must be interpolating or Zoom must be on with a horizontal expansion of greater than 1X. See *Interpolation* on page 2–20. See *Zooming on Waveforms* beginning on page 3–175.

*Variable Persistence* style accumulates the record points on screen over many acquisitions and displays them only for a specific time interval. In that mode, the display behaves like that of an analog oscilloscope. You enter the time for that option with the keypad or the general purpose knob.

*Infinite Persistence* style accumulates the record points until you change a control (such as scale factor) that causes the display to be erased.

## To Set Intensity

Use the Display Intensity menu to set text, graticule, and waveform intensity (brightness) levels. To set the intensity:

1. Press **DISPLAY** → **Intensity** (main) → **Text/Grat** or **Waveform** (side).
2. Enter the intensity percentage values with the keypad or the general purpose knob.

All intensity adjustments operate over a range from 20% (close to fully off) to 100% (fully bright).

## To Set Readout Options

Readout options control whether the trigger indicator, trigger bar, and current date and time appear on the display. The options also control the style of trigger level bar, long or short, the logic scope displays. To set the readout options:

1. Press **DISPLAY** → **Readout** (main).
2. Press **Display 'T' @ Trigger Point** (side) to toggle on and off the display of a 'T' to indicate the trigger point. (The trigger point indicates the position of the trigger in the waveform record.)
3. Press **Trigger Bar Style** (side) to select either the short or the long trigger bar or to turn the trigger bar off. (See Figure 3-18. Note that both styles are shown for illustrating purposes, but you can only display one style at a time.)

The trigger bar is a visual indicator of the trigger threshold level. The logic scope only displays the trigger bar when the trigger source is a waveform displayed in a live (as opposed to reference) group. It displays two trigger bars when displaying delay triggerable acquisition — one for the main and one for the delayed timebase.

Sometimes, especially when using the hardcopy feature, you may wish to display the current date and time on screen. For more information about displaying and setting date and time, see *Date/Time Stamp the Hardcopy* on page 3–89.

4. Press **Display Date/Time** (side) to turn it on or off. Press **Clear Menu** to see the current date and time.

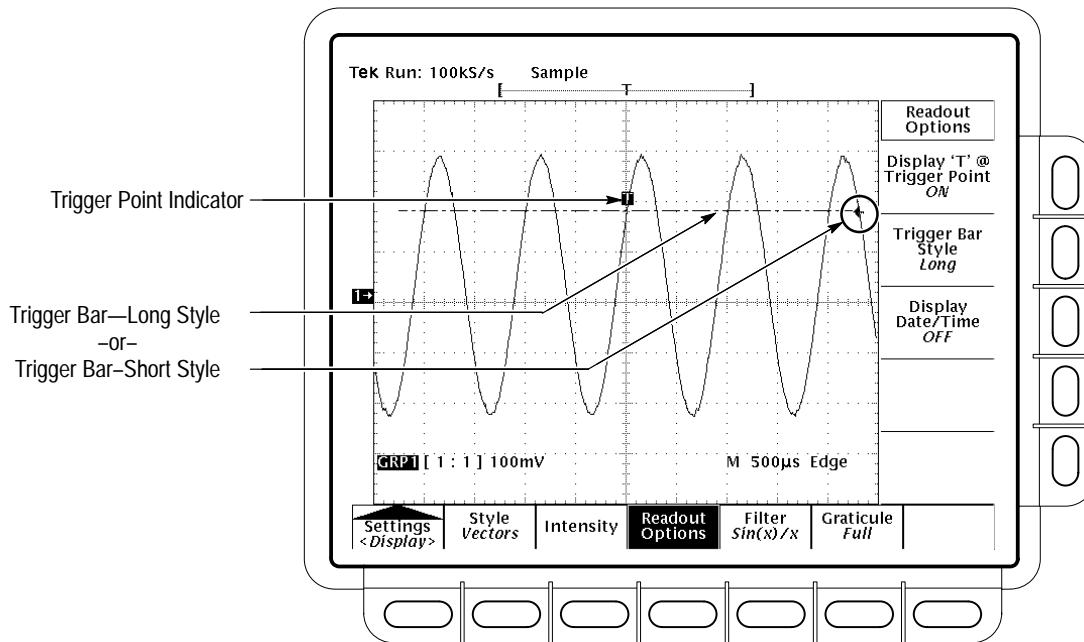

Figure 3-18: Trigger Point and Level Indicators

## To Set Filter Type

The display filter types are  $\sin(x)/x$  interpolation and linear interpolation. (For information on both types of interpolation, see *Interpolation* on page 2–20.) To change the filter type, press **DISPLAY** → **Filter** (main) → **Sin(x)/x Interpolation** or **Linear Interpolation** (side).

---

**NOTE.** When the horizontal scale is less than 25 ns/div, or when using the ZOOM feature to expand waveforms horizontally, interpolation occurs. (The filter type, linear or  $\sin(x)/x$ , depends on which is set in the Display menu.) Otherwise, interpolation is not needed. See Sampling and Digitizing on page 2–19 for a discussion of sampling including interpolation.

---

## To Choose a Graticule

To change the graticule, press **DISPLAY** → **Graticule** (main) → **Full**, **Grid**, **Cross Hair**, or **Frame**.



*Full* displays a grid, cross hairs and a frame.



*Grid* displays a frame and a grid.



*Cross Hair* displays cross hairs and a frame.



*Frame* displays just a frame.

## To Find More Information

See *Acquisition* on page 2–19.

See *Customizing the Display Colors* on page 3–41.





# Customizing the Display Colors

The TLS 216 Logic Scope can display waveform groups in different colors. This article describes how to use the Display menu to choose the colors in which the various display objects appear.

## To Check Display Status

To quickly check the current display settings, press the **SHIFT** → **STATUS** → **System** (main) → **Display** (side). (See Figure 3-19).

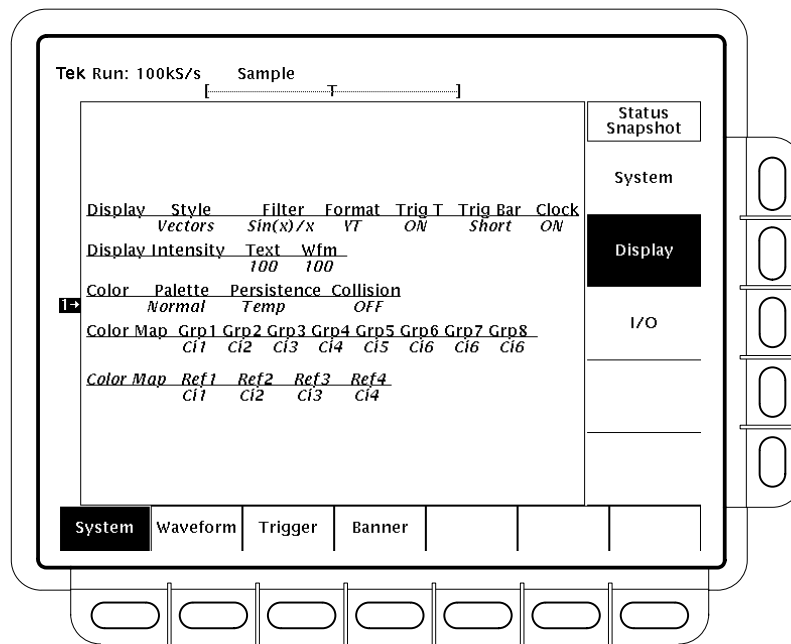

Figure 3-19: Snapshot of Display Status

## To Access Display Colors

To bring up the Display Color menu, press **DISPLAY** → **Settings** (main) → **Color** (pop-up). (See Figure 3-20.)

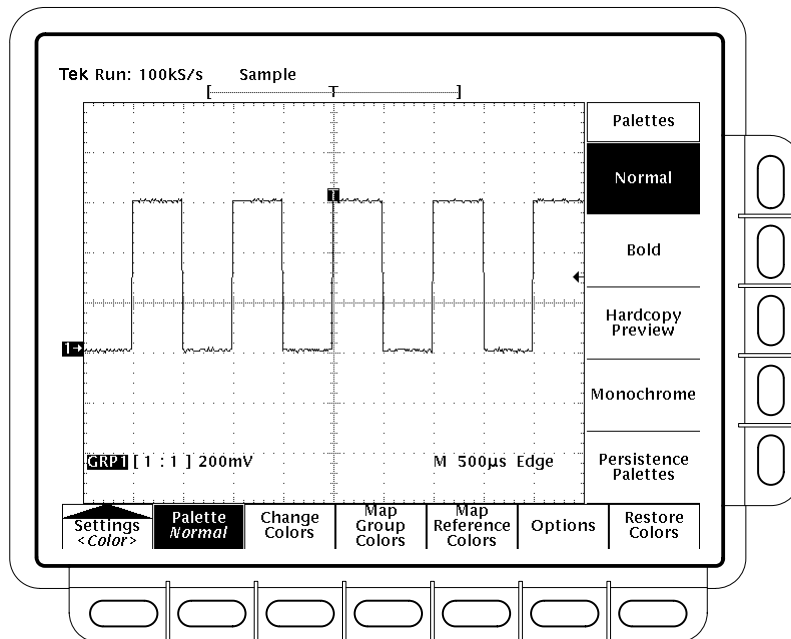

Figure 3-20: Display Menu — Color Settings

The **Color** menu allows you alter the color settings for various display components such as waveforms and text. The **Display** menu lets you adjust the style, intensity level, graticule, and format features. For more information on display, see *Customizing the Display* on page 3–35.

## To Choose a Palette

To select a palette of 12 colors from a menu of pre-set palettes:

1. Press **Palette** in the main menu.
2. Select one of the palettes in the side menu. Choose from **Normal**, **Bold**, **Hardcopy Preview** or **Monochrome**.

To display a side menu of palettes suitable for use with persistence-style displays:

1. Press **Persistence Palettes**.
2. Select one of the palettes in the Persistence Palettes side menu.

To preview the persistence palette you select, press **View Palette** in the main menu.

To quit preview mode, press **Persistence Palette**.

To return to the Palettes menu, press **CLEAR MENU**.

To select persistence-style displays, see *To Choose a Display Style* on page 3–36.

---

**NOTE.** *If you have selected a color palette, operating the logic scope at higher room temperatures can temporarily degrade display quality. (Display will not be as sharp.) Displaying a very high intensity palette, such as the Hardcopy palette, can also temporarily degrade the display.*

---

---

**NOTE.** *You may want to select the Hardcopy Preview palette when printing to color printers and plotters. The default colors in that palette provide a white background and fully saturated primary colors, which result in good copies of the display screen when sent to most color printers and plotters.*

---

## To Change Palette Colors

To change the color of the current palette, select a color and vary the following attributes:

*Hue* which is the wavelength of light reflected from the surface. It varies continuously along the color spectrum as produced by a rainbow.

*Lightness* which is the amount of light reflected from the surface. It varies from black, to the nominal color, to white.

*Saturation* which is the intensity of color. Completely desaturated color is gray. Completely saturated color of any hue is that color at its most intense level.

1. Select the main menu **Change Colors** item. (See Figure 3-21.)
2. Select one of the colors displayed by pressing (repeatedly) **Color** in the side menu. A scrolling box cursor moves to enclose the selected color. If you want to use the factory default for this color index, press the side menu **Reset to Factory Color**.
3. Press **Hue** in the side menu and use the general purpose knob or keypad to select the desired hue. Values range from 0 to 359. Sample values are: 0 = blue, 60 = magenta, 120 = red, 180 = yellow, 240 = green, 360 = cyan.
4. Press **Lightness** in the side menu and use the general purpose knob or keypad to select the lightness you desire. A value of 0 results in black. A value of 50 provides the nominal color. A value of 100 results in white.

5. Press **Saturation** in the side menu and use the general purpose knob or keypad to select the saturation you desire. A value of 100 provides a pure color. A value of 0 provides gray.

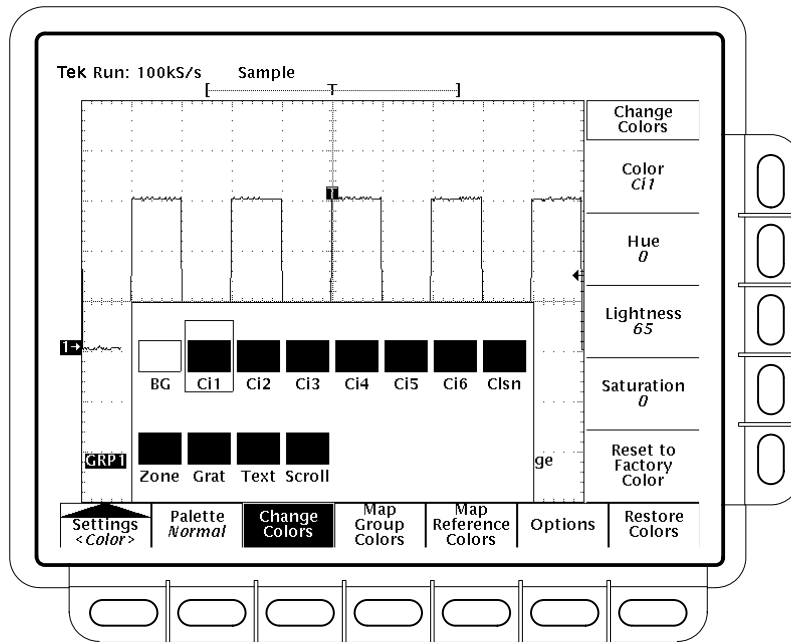

Figure 3-21: Display Menu — Change Colors

## To Change Color of Groups

To define the color of a waveform group:

1. Press **Map Group Colors** in the main menu. (See Figure 3-22.)
2. Press (repeatedly) **Group** in the side menu to cycle to any one of Group 1 through Group 8. A scrolling box cursor moves to enclose the selected color currently assigned to the group you select.
3. Press (repeatedly) **Color** in the side menu to cycle to and apply any of the color choices to the group just selected. The scrolling box cursor now moves to enclose the selected color that you assign to the group you selected in step 2.

To return any group to its factory default color, select the group as in step 2 and press **Reset to Factory Color** in the side menu.

**NOTE.** Since there are six colors available for assignment to eight groups, some colors must be used for more than one group.

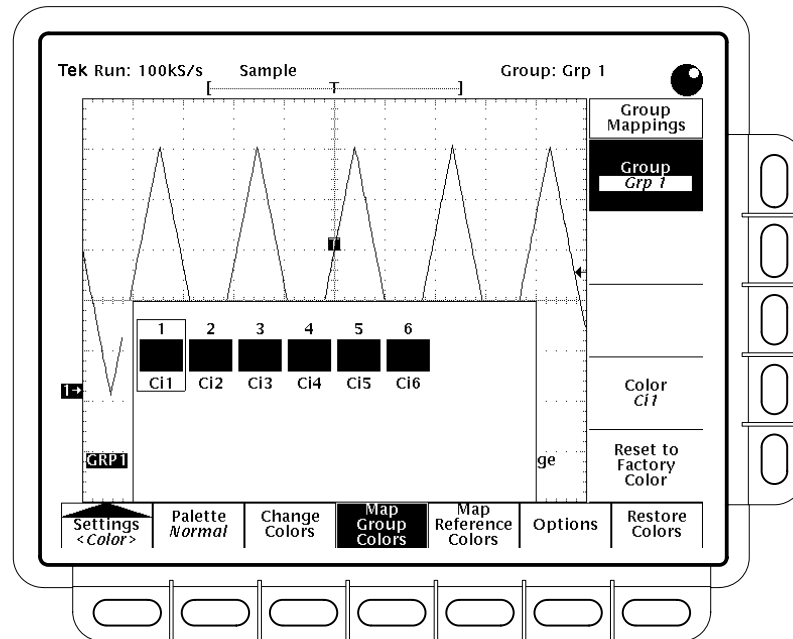

Figure 3-22: Display Menu — Map Group Colors

## To Change the Color of Reference Groups

To define the color of reference groups of waveforms:

1. Press **Map Reference Colors** in the main menu.
2. Press (repeatedly) **Ref** in the side menu to cycle to any one of reference groups **Ref 1** through **Ref 4**.
3. Press (repeatedly) **Color** in the side menu to cycle to and apply any of the color choices to the reference group just selected.

To return any group to its factory default color, select it as in step 2 and press **Reset to Factory Color** in the side menu.

## To Highlight Waveform Overlaps

To highlight those areas where one waveform crosses another waveform with a special color:

1. Press **Options** in the main menu.
2. Press **Collision Contrast** in the side menu to toggle it **ON**.

With Collision Contrast turned on, waveform intersections (points where they overlap) appear in the color assigned to collisions in the currently selected color palette.

## To Restore Default Colors

To restore colors to their factory default settings:

1. Press **Restore Colors** in the main menu. (See Figure 3-23.)

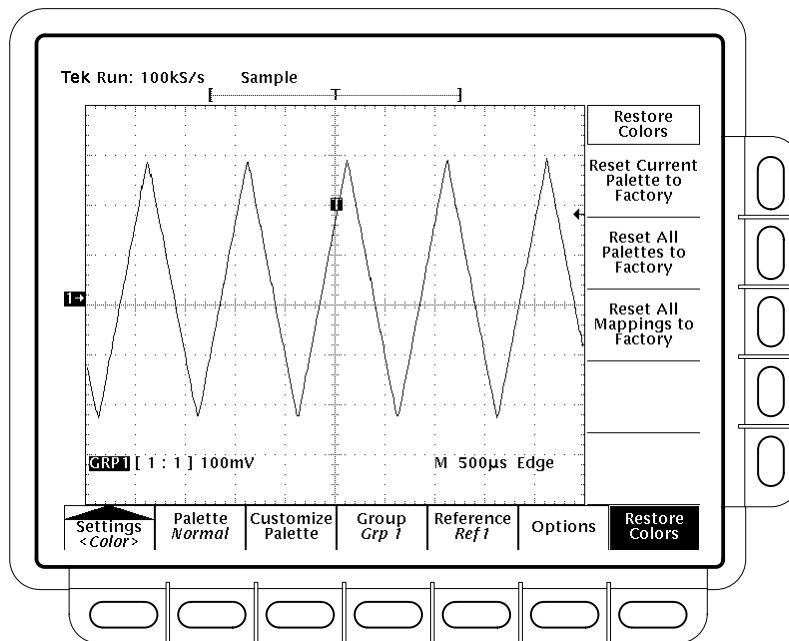

Figure 3-23: Display Menu — Restore Colors

2. Press any of the following side menu buttons:

*Reset Current Palette To Factory* — restores any colors customized in the palette currently controlling the display to their factory settings. The hue,

lightness, and saturation of every color in the palette are reset. Palettes not selected are not reset.

*Reset All Palettes To Factory* restores all customized colors in all palettes to their factory settings. The hue, lightness, and saturation of every color in all palettes are reset, whether selected or not.

*Reset All Mappings To Factory* restores all live and reference groups to their default colors.

## To Find More Information

See *Customize the Display* on page 3–35.





# Doing a Probe Cal

The TLS 216 Logic Scope can compensate its entire signal path, from probe tip to digitized signal, to improve the gain and offset accuracy of the P6240 probe. By executing *Probe Cal* on a channel with its probe installed, you can optimize the capability of the logic scope to make accurate measurements using that channel and probe. This article describes how to run Probe Cal.

---

**NOTE.** *Run a Probe Cal anytime you wish to ensure that you take measurements with the best accuracy possible. You should also run a Probe Cal if you have changed to a different P6240 probe since the last Probe Cal was performed.*

---

## To Run a Probe Cal

The logic scope attempts to calibrate the probe for all channels defined as part of the currently selected group. To select, define, and run Probe Cal on a group, do the following steps:

1. Install each probe to be calibrated on the input channel on which it is to be used.
2. Power on the logic scope and allow a 20 minute warm-up before doing this procedure.
3. Press **SHIFT** → **UTILITY** → **System** (main) → **Cal** (pop-up).
4. Look at the status label under **Signal Path** in the main menu. If the status does not read **Pass**, perform a signal path compensation (see *Doing a Signal Path Compensation*, page 3–53). Then continue with this procedure.
5. Press the front-panel button corresponding to the group that is to contain the probes you intend to calibrate. Press **SHIFT** if selecting any of Group 1 through Group 8.
6. Press **GROUP MENU** → **Group Definition** (main) → **First Channel** (side). Use the keypad to select the first channel in the group.
7. Press **Last Channel** (side). Use the keypad to select the last channel in the group.

The selected group and the channels it includes appear in the readout at the bottom of the screen. It appears in the following format *GRP Number[Last Channel:First Channel]*. Probe Cal will run on all channels between first and last (inclusive).

---

**NOTE.** The channel of each probe you intend to run Probe Cal on must belong to a group. To define groups, see Grouping Waveforms on page 3–55.

---

8. Connect each probe tip to **PROBE CALIBRATION** signals available from the front panel.

---

**NOTE.** You can run Probe Cal with the Y-lead adapter accessory installed on the probe. However, if any probe has it installed, all probes in the group should have it installed. With or without the adapter, be careful to observe proper polarity when connecting to the probe calibration signal.

---

9. Press **Cal Probes** (main).

10. Press **OK Compensate Probe** (side).



11. Wait for Probe Cal to complete (one to ten minutes).

Before Probe Cal completes, if any probe/input combination has not been compensated, the word *Initialized* appears under *Cal Probes* in the main menu. When Probe Cal completes, the following actions occur:

- The clock icon will disappear.
- If every probe in the selected group compensates successfully, the word *Pass* appears under *Cal Probes* in the main menu.
- If any probe in selected group fails to compensate successfully, the word *Fail* appears under *Cal Probes* in the main menu. Examine the probe connections to logic scope and repeat step 10.
- If Probe Cal did not complete successfully, you may get the message *Compensation Error*. This error implies that the probe gain (2% error) and/or offset (50 mV) is too great to be compensated. You can substitute another probe and restart. You may want to have your probe checked by service personnel.

12. After the clock icon disappears, verify the word *Initialized* changed to *Pass* under *Cal Probe* in the main menu. (See Figure 3-24.)

13. If desired, repeat this procedure beginning at step 1 to compensate for other probe/channel combinations. But before you do so, be sure you give every probe a 20-minute warm-up period from the time you install it.

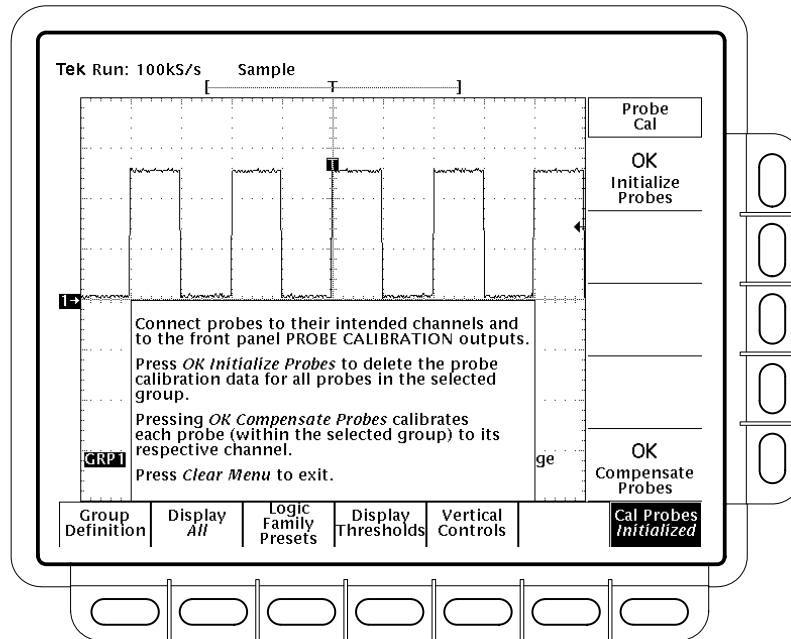

Figure 3-24: Probe Cal Menu and Probe Cal Display

## To Initialize Probes

If, for any reason, you do not want to use the probe calibration stored for a group of channels, you can erase it. To erase the probe calibration for any group of channels, do the following procedure:

1. Press the front-panel button corresponding to the group that contain the channels for which you intend to erase probe calibration. Press **SHIFT** if selecting any of one of Group 5 through Group 8.
2. Press **GROUP MENU** → **Cal Probes** (main).
3. Press **OK Initialize Probes** (side).

Once erased, probe calibration data cannot be recovered.

## Changing Probes

If you move a probe to another channel, you should include that probe in a group and compensate it again.

Redefining groups does not require a new Probe Cal unless you move any probe to a channel other than which it was compensated with. For instance, you can define Group 1 to include all 16 channels, install all probes on all channels, and

compensate all the probe/channel combinations at once. After doing so, you can redefine Group 1 to include fewer channels and then create new groups of compensated probe/channel combinations.

If a Probe Cal has never been performed on an input channel or if its stored Probe Cal data is erased using the Probe Cal menu (see *To Initialize Probes* in this article), the logic scope displays *Initialized* status in its Group menu.

If you execute a successful Probe Cal on an input channel, the logic scope stores the compensation data it derived in non-volatile memory. Therefore, this data is available when you turn the logic scope off and back on, when you change probes, etc.

# Doing a Signal Path Compensation

The TLS 216 Logic Scope allows you to compensate the internal signal path used to acquire the waveforms you measure. This article details the procedure for executing a signal path compensation (SPC) which optimizes the capability of the logic scope to make accurate measurements based on the ambient temperature.

---

**NOTE.** Run an SPC anytime you wish to ensure that measurements you take are made with the best accuracy possible. You should also run SPC if the temperature has changed more than 5° C since the last SPC was performed.

---

## To Run SPC

To signal-path compensate the logic scope:

1. Power on the logic scope and allow a 20-minute warm-up before doing this procedure.
2. Disconnect any input signals you may have connected from all input channels.



---

**CAUTION.** When doing steps 3 and 4, do not turn off the logic scope until signal-path compensation completes. If you interrupt (or lose) power to the instrument while signal-path compensation is running, the logic scope logs a message in its error log. If such a case occurs, rerun signal-path compensation.

---



3. Press **SHIFT UTILITY** → **System** (main) → **Cal** (pop-up) → **Signal Path** (main) → **OK Compensate Signal Paths** (side).
4. Wait for signal path compensation to complete (about 16 minutes). While it progresses, a “clock” icon (shown at left) is displayed on-screen. When compensation completes, the status message updates to *Pass* or *Fail* in the main menu.
5. Verify the word *Pass* appears under **Signal Path** in the main menu. (See Figure 3-25.)

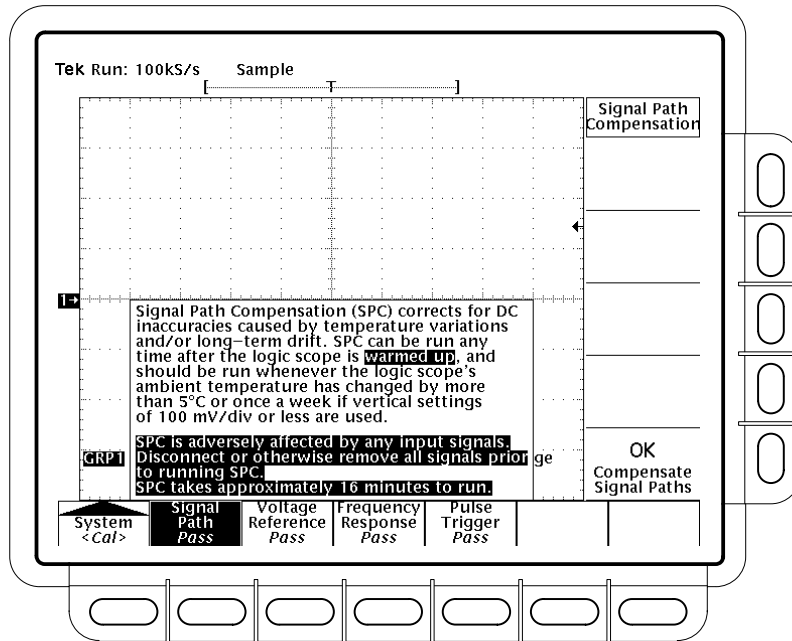

Figure 3-25: Performing a Signal Path Compensation

# Grouping Waveforms

The TLS 216 Logic Scope operates on channels and the waveforms they acquire only as individual groups. To perform even basic operations on any waveform, such as displaying, vertically positioning, and vertically scaling it, you must first know how to include it in a group. This article describes the group concept and how to define, display, and remove groups.

## To Understand Waveform Groups

To more fully understand what a group is, consider its characteristics.

*Groups contain one or up to sixteen channels.* You must assign a channel to a group for it to be displayed. See Figure 3-26.

*Groups use only contiguous channels.* For example, a group can contain channels 5 through 10, but not channels 5 through 8 plus 10.

*Groups cannot share channels.* For example if Group 1 contains channel 10, no other group can include channel 10.

*Groups are the objects you display, vertically scale, and vertically position.* You can adjust a single channel like a group only if you make it the only channel in a group and adjust that group.

*Groups can be displayed in any of three display modes: Analog, BusForm, or Timing Diagram.*

### Focusing on Groups

Groups allow you to control channels and display the signals they acquire as a single object or a group, which often best matches the way you want to look at and measure those signals. For instance, you might wish to measure setup and hold times of a data bus relative to a clock. Setup and hold times depend on the behavior of *all* the data lines on the bus. Therefore, using the logic scope to display the data lines as a group and to measure the group against the clock signal is more efficient than comparing each line individually to the clock.

### Focusing on Channels

Do not think that because the logic scope focuses on groups, individual channels cannot be displayed and measured. The ability to operate like a multi-channelled digitizing storage oscilloscope (DSO) is a key feature of this product.

To use the logic scope as, for instance, a four channel DSO, you define Group 1 through Group 4 to contain one channel each (for instance Channel 1 through Channel 4, respectively). Because the logic scope treats waveform groups much like a DSO treats channels (displays them, vertically positions them, and so on)



operations on a group now control a single channel and its waveform. See *Example 1: Displaying Waveforms* on page 1–11 to learn more about using the logic scope as a DSO.

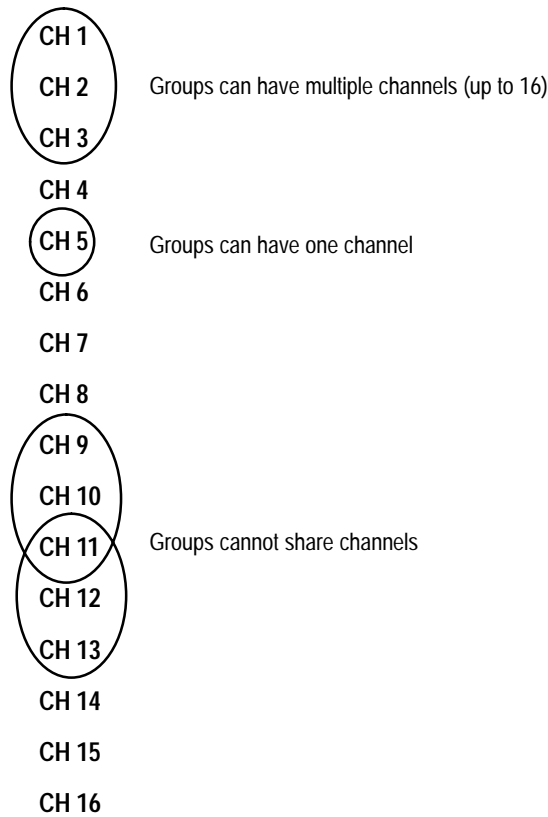

Figure 3-26: Groups—Valid and Invalid

## To Check Group Settings

To determine the composition (first and last channel) of any group displayed, check the *Vertical Readout* at the bottom of the display. (See Figure 3-27.)

The Vertical Readout includes group readouts. Each group readout labels each group in the readout by number and indicates its last and first channel. In addition, the Vertical Readout:

- displays only groups that are defined.
- displays the label of the selected group in reverse video. (See Figure 3-27.)
- displays OFF in the group readout for any group that is turned off in its Display Mode menu.

- displays the volts/division setting next to the group label of groups that are set to Analog mode with *all* channels in the group displayed. If set to Analog mode with only the *selected* channel displayed, the word *Select* replaces the volts/division readout. (See *Choosing a Group Display Mode*, which begins on page 3–23 for information about group modes.)
- displays the display mode, Bus or Timing, next to the group labels of groups set to BusForm or Timing Diagram modes.
- displays the contents of the group by listing the first and last channel it contains.
- displays only one of the two “pages” of live groups at a time: Group 1 through Group 4 or Group 5 through Group 8, whichever page contains the currently selected group.
- displays the reference group currently selected in the Group More menu. (If MORE is lighted, the live group readouts are removed from the Vertical Readout.)

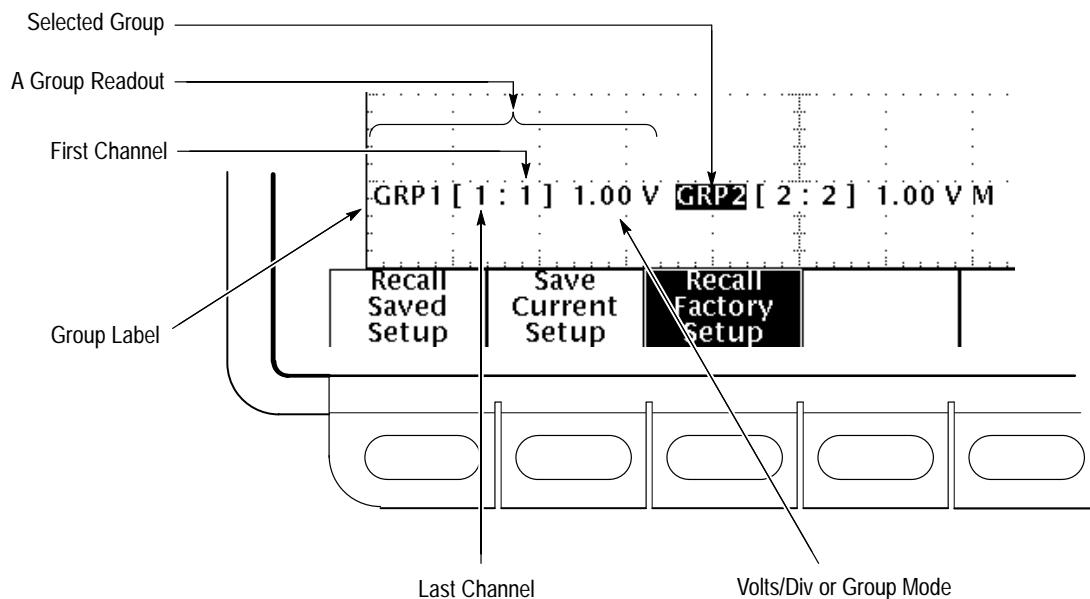

Figure 3-27: Vertical Readout Displaying Two Group Readouts

The group reference indicator for the selected group appears along the left side of the display. See Figure 3-28.

To check the overall group setup, press **SHIFT** → **STATUS** → **Waveform** (main) → **Groups** (side).

## To Define a Group

To define a waveform group, you select the group, specify the channels it contains and designate one of the channels as the selected channel. To do so, perform the following steps.

1. Press any of group selection buttons **GROUP 1** through **GROUP 4** on the right side of the display. Or press **SHIFT**, and then press any of group selection buttons **GROUP 5** through **GROUP 8**. (The **MORE** selection button allows you to select internally stored *Ref* groups of saved waveforms for display.)
2. Press **Group Definition** (main) → **First Channel** (side). Use the key pad to select the first channel in the group.
3. Press **Last Channel** (side). Use the key pad to select the last channel in the group.
4. Press **Selected Channel** (side). Use the key pad to designate the selected channel in the group.

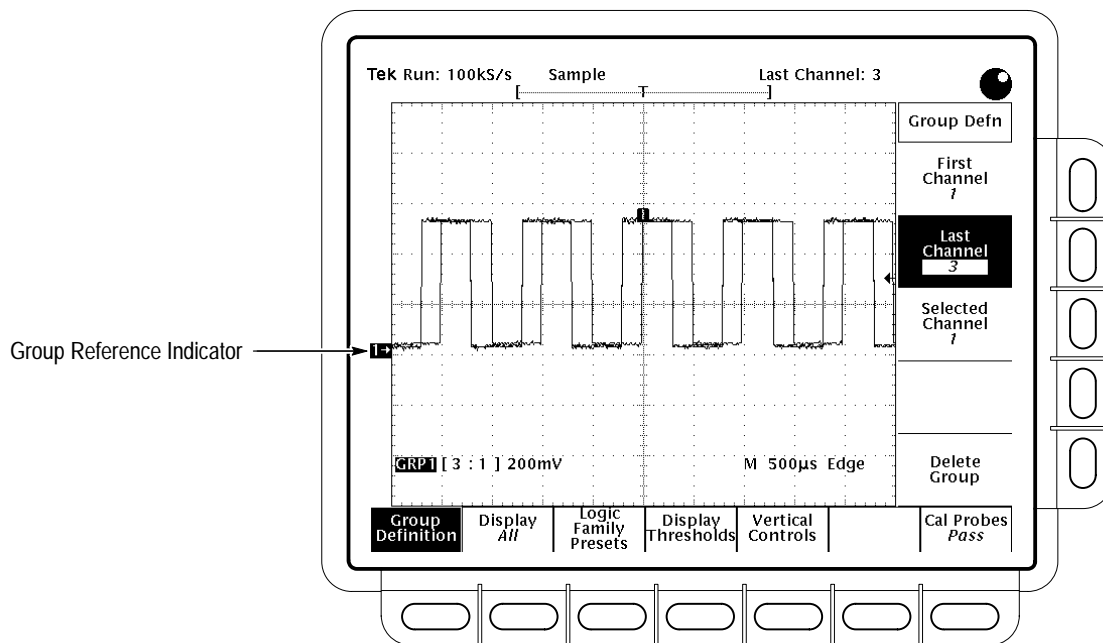

Figure 3-28: The Group Definition Menu

Several operating characteristics can be observed when you perform the steps just listed:

- Selecting a group not yet defined creates the group using a single channel. The logic scope uses the lowest numbered channel not yet assigned to a group.
- When defining a first channel or last channel, the logic scope ignores the input of any channels belonging to another group.
- Attempting to increase the first channel to a higher numbered channel than that set for last channel sets both the first and last channels to the higher numbered channel. This operation results in a single channel group.
- Attempting to decrease the last channel to a lower numbered channel than that set for last channel sets both the first and last channels to the lower numbered channel. This operation results in a single channel group.

You can also increment the first, last, and selected channels by repeatedly pressing their menu button in the side menu after selection.

## To Delete a Group

To delete a group do the following steps:

1. Press the group selection button (**GROUP 1** through **GROUP 8**) to select the group you want to delete.
2. Press **Group Definition** (main) → **Delete Group** (side). The logic scope takes the following actions:
  - Removes the group and its vertical readout from the display.
  - Removes any automated measurements on channels in the group.
  - Releases all channels in the group so that they are available for including in existing groups or new groups you create.

---

**NOTE.** Channels selected as trigger sources in the trigger menus continue to be the trigger source regardless of whether it belongs to a group that is displayed, or turned off, or deleted (belongs to no group at all).

---

## To Find More Information

See *Adjusting the Vertical Scale* on page 3–7.

See *Choosing a Group Display Mode* on page 3–23.

See *Selecting Groups and Channels* on page 3–117.

See *Example 1: Displaying Waveforms* on page 1–11.

See *Example 2: Grouping Waveforms* on page 1–17.

# Managing the File System

The TLS 216 Logic Scope provides file utilities and a floppy disk drive for saving, recalling, and otherwise managing the hardcopies, setups, and waveforms you save to a 720 Kbyte or 1.44 Mbyte floppy disk. This article describes how to *manage* these files using the File Utilities menu, which appears in the Hardcopy, Save Setup, and Save Waveforms menus. The articles that contain descriptions for saving and/or recalling hardcopies, setups, and waveforms are listed at the end of this article. (See page 3–66.)

## To Understand the File System

Before you use the file system, read about the conventions it uses when naming files and about the the wild card files used to manage and to help store information to the file system.

### File Name Conventions

The logic scope saves files with names appended with default suffixes. These default suffixes relate to the type of file saved. A file of the form:

*FILENAME.GRP* contains a saved waveform reference group. (See Figure 3-29.)

*FILENAME.FMT* contains a saved hardcopy. In this case, the suffix .FMT is replaced by a suffix representing the currently selected hardcopy format. For example, .TJ appears for ThinkJet hardcopies and .PCX for PCX hardcopies.

*FILENAME.SET* contains a saved logic scope control setup.

### Wild Card Files

The logic scope file system provides “wild card” files to use in saving, copying, and deleting files. These special purpose files are not real files, but they are used to create or delete real files. A file of the form:

\*.\* selects all files in a directory.

*TEK?????.GRP* creates a new, uniquely named group file when you save a waveform group from the Save/Recall Waveform menu.

*TEK?????.FMT* creates a new, uniquely named hardcopy file when you press hardcopy and have set Port to File in the Hardcopy menu.

*TEK?????.SET* creates a new, uniquely named setup file when you save a logic scope setup from the Save/Recall Setup menu.

The logic scope creates the default wild card files upon power up. (You can rename the *TEK?????.* files, but they are renamed with their default names when power is cycled.) To use these default files, you select the file with the suffix that

corresponds to the object you wish to save: a logic scope group, hardcopy, or setup. When you save the object, the logic scope stores it on the disk and gives it a unique name.

The name given the object includes a serial number based on the order in which it was created. For example, the logic scope saves the first group you save to the file TEK00001.GRP, the second to TEK00002.GRP, and so on, if you have selected the TEK?????.GRP wild card file.

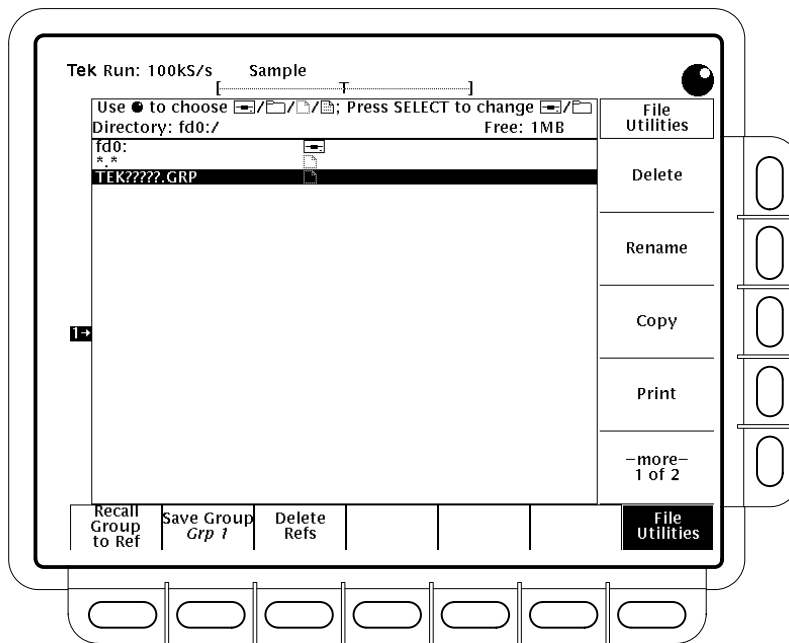

Figure 3-29: File Utilities Menu and Listing

## To Use the File Utilities

The File Utilities allow you to delete, rename, copy, or print files; lock out or allow overwriting or deleting of those files; create and delete directories; and format disks. To use these utilities, do the procedure *Access the File Utilities*, and then do the procedures that follow.

### Access the File Utilities

1. Press either the **SETUP** button to bring up the **Save/Recall Setup** menu, the **WAVEFORM** button to bring up the **Save/Recall Waveform** menu, or the **SHIFT → HARDCOPY MENU** button to bring up the **Hardcopy** menu.
2. Press **File Utilities** (main) to bring up the **File Utilities** side menu. (See Figure 3-29.)

---

**NOTE.** *The amount of free space on the disk is shown in the upper right corner of the display. The logic scope shows the amount in Kbytes, where each Kbyte equals 1024 bytes.*

---

### Delete a File or Directory

To delete a file, turn the general purpose knob to scroll the cursor over the name of the file to delete. Then press **Delete** (side).

To delete all files in the file list, turn the general purpose knob to scroll the cursor to the \*.\* selection, and then press **Delete** (side).

To delete a directory, do the following steps:

1. Turn the general purpose knob to scroll the cursor over the name of the directory to delete. Press **Delete** (side).

If the directory selected is empty, the logic scope will delete the directory. If the directory is not empty, the logic scope will pop up a warning that deleting the directory deletes its contents. The logic scope deletes directories recursively, which removes both the directory and its contents.

2. To delete the directory *and* its contents, press **OK Delete FileName** (side). To return to the **File Utilities** menu *without* deleting the directory, press the front-panel button **CLEAR MENU**.

### Rename a File or Directory

To rename a file or directory, do the following steps:

1. Turn the general purpose knob to scroll the cursor over the name of the file or directory to rename. For example, to rename the target file whose default name is **TEK?????.SET**, set the cursor over its name.
2. Press **Rename** (side). The labelling menu will appear. (See Figure 3-30.)
3. Turn the general purpose knob to select a letter, and press **Enter Char** (main) to add it to the new name you are creating. Repeat this step until you have entered the entire name.
4. Press **OK Accept** (side) to rename the file or directory with the name you have entered.

To revise the name you created, use the ←, →, **Back Space**, or **Delete** keys in the main menu to edit the name before pressing **OK Accept** (side).

To discard the name you created and start over, press the **Clear** key in the main menu before pressing **OK Accept** (side).



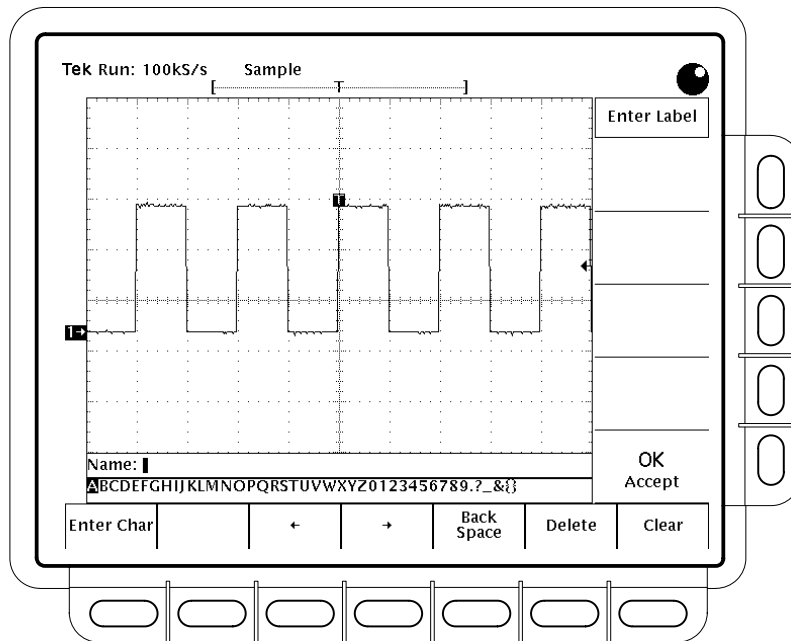

Figure 3-30: File System — Labelling Menu

### Copy a File or Directory

To copy a file or directory, do the following steps:

1. Turn the general purpose knob to scroll the cursor over the name of the file to copy.
2. Press **Copy** (side). The file menu will reappear with the names of directories to copy to.
3. Turn the general purpose knob to scroll the cursor over the name of the directory in which you want to copy the file and press **Copy <name> to Selected Directory** (side).

The logic scope copies all directories recursively. “Copies recursively” means it copies both the directory and its contents.

To copy all files, select the \*.\* entry.

### Print a File

To print a file, do the following steps:

1. Turn the general purpose knob to scroll the cursor over the name of the file to print.
2. Press **Print** (side). The **Print To** side menu will appear.
3. Select the port to print to from these choices: **GPIB**, **RS-232**, or **Centronics** (side). The logic scope will immediately begin sending the file in its raw

form out the port. The device (printer) receiving the file must be capable of printing the particular file format.

### Create a Directory

To create a new directory, do the following steps:

1. Press **Create Directory** (side). The labelling menu will appear.
2. Turn the general purpose knob to select a letter, and press **Enter Char** (main) to add it to the directory name you are creating. Repeat this step until you have entered the entire name.
3. Press **OK Accept** (side) to label the file or directory with the name you have entered.

To revise the name you created, use the ←, →, **Back Space**, or **Delete** keys in the main menu to edit the name before pressing **OK Accept** (side).

To discard the name you created and start over, press the **Clear** key in the main menu before pressing **OK Accept** (side).

### Set Confirm Delete

To turn on or off the confirm delete message, toggle **Confirm Delete** (side).

When the confirm delete option is off, the logic scope will allow you to immediately delete files or directories. When the confirm option is on, the logic scope warns you before it deletes files and gives you a chance to reconsider.

### Set the Overwrite Lock

To turn on or off the file overwrite lock, toggle **Overwrite Lock** (side).

When overwrite lock is on, the logic scope will not permit you to write over an existing file of the same name.

### Format a Disk

To format a 720 Kbyte or 1.44 Mbyte disk, turn the general purpose knob to scroll the cursor over the name of the drive containing the disk to be formatted (fd0:). Then, press **Format** (side).

### Change Directories

To make a subdirectory the working directory, turn the general purpose knob to scroll the cursor over the name of the subdirectory. Press **SELECT** to change to that subdirectory.

To make the parent directory the working directory, turn the general purpose knob to scroll the cursor over the special-purpose directory name “..” listed in all subdirectories. Press **SELECT** to change to the directory containing the subdirectory.

## To Find More Information

See *Printing a Hardcopy*, on page 3–87.

See *Saving and Recalling Setups*, on page 3–105.

See *Saving and Recalling Waveforms*, on page 3–109.

# Measuring Waveforms Automatically

The TLS 216 Logic Scope provides Measure, a feature for automatically measuring the waveforms contained in the groups it acquires. If your measurement is one of the 28 measurements available, the logic scope can take the measurement and display it on screen.

This article describes automatic measurements — how to select them, display them, restrict them to part of the waveform record, and how to take a snapshot of them. For information on cursor and graticule measurements, see *Measuring Waveforms with Cursors* on page 3–81 and *Measurements* on page 2–27.

## To Understand Automated Measurements

Taking an automated measurement is generally more accurate and much quicker than taking measurements by counting graticule lines. Plus, an automatic measurement continuously updates on the screen as the logic scope acquires new waveform data. To learn how to use Measure, consider some of its operating characteristics.

- The logic scope displays up to four measurements at one time. See Figure 3-31. (There is also a way to display all the single-waveform measurements at once. See *Snapshot of Measurements* on page 3–78.)
- The logic scope moves the measurements from the graticule area into the side menu area if you press **CLEAR MENU**.
- The logic scope calculates waveform parameters from the data acquired over the entire waveform record, not just the portion displayed on screen, *unless* measurement gating is turned on.
- The logic scope calculates waveform parameters only from data acquired over that part of the waveform enclosed by the vertical cursors *if* measurement gating is turned on. (See page 3–72 for a discussion of gated measurements.)

To learn what measurements are available and how they are defined, read Table 3–3. It includes a brief definition of each of the automated measurements the logic scope provides.

To learn more details about how the logic scope calculates each measurement, see *Appendix B: Algorithms* in this manual.

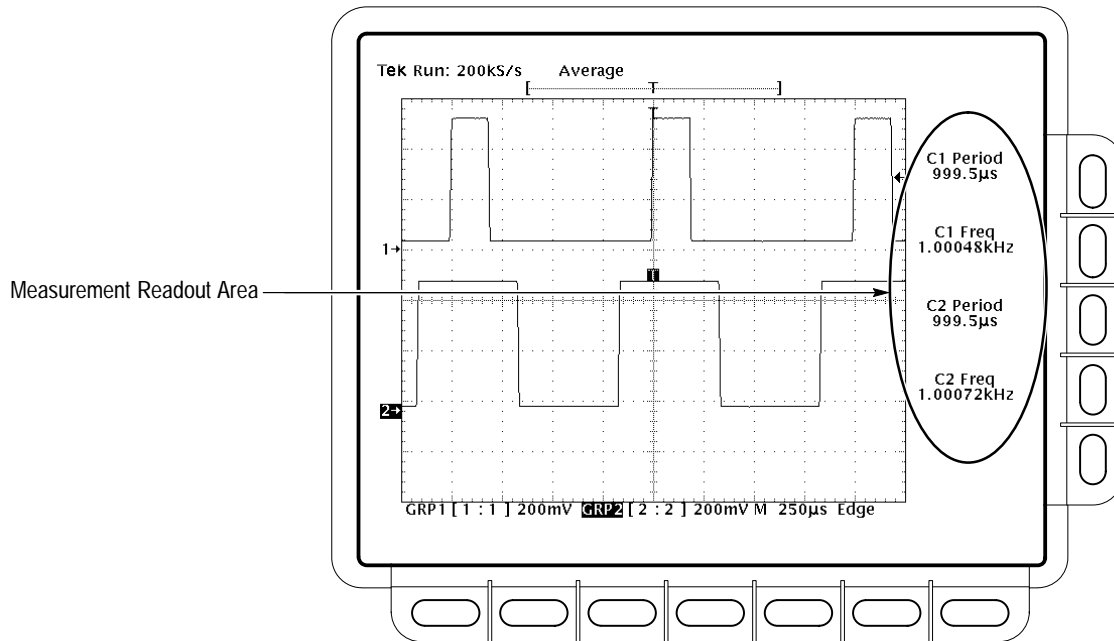

Figure 3-31: Measurement Readouts

Table 3-3: Measurement Definitions





























Name	Definition
 <b>Amplitude</b>	Voltage measurement. The high value less the low value measured over the entire waveform or gated region.  Amplitude = High – Low
 <b>Area</b>	Voltage over time measurement. The area over the entire waveform or gated region in volt-seconds. Area measured above ground is positive; area below ground is negative.
 <b>Cycle Area</b>	Voltage over time measurement. The area over the first cycle in the waveform, or over the first cycle in the gated region, in volt-seconds. Area measured above ground is positive; area below ground is negative.
 <b>Burst Width</b>	Timing measurement. The duration of a burst. Measured over the entire waveform or gated region.
 <b>Cycle Mean</b>	Voltage measurement. The arithmetic mean over the first cycle in the waveform or the first cycle in the gated region.
 <b>Cycle RMS</b>	Voltage measurement. The true Root Mean Square voltage over the first cycle in the waveform, or over the first cycle in the gated region.
 <b>Delay</b>	Timing measurement. The time between the MidRef crossings of two different traces or the gated region of the traces.
 <b>Fall Time</b>	Timing measurement. Time taken for the falling edge of the first pulse in the waveform or gated region to fall from a High Ref value (default = 90%) to a Low Ref value (default = 10%) of its final value.

Table 3-3: Measurement Definitions (Cont.)

Name	Definition
 <b>Frequency</b>	Timing measurement for the first cycle in the waveform or gated region. The reciprocal of the period. Measured in Hertz (Hz) where 1 Hz = 1 cycle per second.
 <b>High</b>	The value used as 100% whenever High Ref, Mid Ref, and Low Ref values are needed (as in fall time and rise time measurements). Calculated using either the min/max or the histogram method. The min/max method uses the maximum value found. The histogram method uses the most common value found above the mid point. Measured over the entire waveform or gated region.
 <b>Hold</b>	Timing measurement. The time between the first transition to an illegal state for all waveforms in a group (except the clock) and the clocking edge of the waveform in the channel specified as the clock. The clock can be any channel. It does not have to be included in the measured group. Logic levels are dictated by High Ref and Low Ref.
 <b>Low</b>	The value used as 0% whenever High Ref, Mid Ref, and Low Ref values are needed (as in fall time and rise time measurements). May be calculated using either the min/max or the histogram method. With the min/max method, it is the minimum value found. With the histogram method, it refers to the most common value found below the mid point. Measured over the entire waveform or gated region.
 <b>Maximum</b>	Voltage measurement. The maximum amplitude. Typically the most positive peak voltage. Measured over the entire waveform or gated region.
 <b>Mean</b>	Voltage measurement. The arithmetic mean over the entire waveform or gated region.
 <b>Minimum</b>	Voltage measurement. The minimum amplitude. Typically the most negative peak voltage. Measured over the entire waveform or gated region.
 <b>Negative Duty Cycle</b>	Timing measurement of the first cycle in the waveform or gated region. The ratio of the negative pulse width to the signal period expressed as a percentage. $NegativeDutyCycle = \frac{NegativeWidth}{Period} \times 100\%$
 <b>Negative Overshoot</b>	Voltage measurement. Measured over the entire waveform or gated region. $NegativeOvershoot = \frac{Low - Min}{Amplitude} \times 100\%$
 <b>Negative Width</b>	Timing measurement of the first pulse in the waveform or gated region. The distance (time) between MidRef (default 50%) amplitude points of a negative pulse.
 <b>Peak to Peak</b>	Voltage measurement. The absolute difference between the maximum and minimum amplitude in the entire waveform or gated region.
 <b>Phase</b>	Timing measurement. The amount one waveform leads or lags another in time. Expressed in degrees, where 360° comprise one waveform cycle.
 <b>Period</b>	Timing measurement. The time it takes for the first complete signal cycle to happen in the waveform or gated region. The reciprocal of frequency. Measured in seconds.
 <b>Positive Duty Cycle</b>	Timing measurement of the first cycle in the waveform or gated region. The ratio of the positive pulse width to the signal period expressed as a percentage. $PositiveDutyCycle = \frac{PositiveWidth}{Period} \times 100\%$
 <b>Positive Overshoot</b>	Voltage measurement over the entire waveform or gated region. $PositiveOvershoot = \frac{Max - High}{Amplitude} \times 100\%$

**Table 3–3: Measurement Definitions (Cont.)**

Name		Definition
	<b>Positive Width</b>	Timing measurement of the first pulse in the waveform or gated region. The distance (time) between MidRef (default 50%) amplitude points of a positive pulse.
	<b>Rise time</b>	Timing measurement. Time taken for the leading edge of the first pulse in the waveform or gated region to rise from a Low Ref value (default = 10%) to a High Ref value (default = 90%) of its final value.
	<b>RMS</b>	Voltage measurement. The true Root Mean Square voltage over the entire waveform or gated region.
	<b>Setup</b>	Timing measurement. The time between the last transition to a legal state for all waveforms in a group (except the clock) and the clocking edge of the waveform specified as the clock. The clock can be any channel. It does not have to be included in the measured group. Logic levels are dictated by High Ref and Low Ref.
	<b>Skew</b>	Timing measurement. The time between the first transition to an illegal state for all waveforms in a group and last transition to a legal state for the same waveforms. Logic levels are dictated by High Ref and Low Ref.

## To Measure a Single Waveform

To take an automatic measurement, you must do the following steps.

1. Obtain a stable display of the waveform to be measured. Pressing **AUTO-SET** may help.
2. Select a group and channel. The article *Selecting Groups and Channels* on page 3–117 explains how to do these tasks.
3. Access the Measure menu, and turn on a measurement.

Do the following procedures to take single channel automatic measurements.

### Select a Measurement

To select your single channel measurement, do the following steps.

1. Use the group selection buttons to select a group. Then use the Group menu to select a channel.
2. Press **MEASURE** → **Select Measrmnt** (main). (See Figure 3-32.)
3. Select a measurement from the side menu.

When taking measurements, consider the following hints.

- To determine the channel on which the logic scope takes the measurement, check the measurement readout.

- To take a measurement on a different waveform, simply select the group that it belongs to, select the channel, and then choose the measurements you want.
- To take a fifth measurement, remove one or more of the existing measurements. The logic scope takes a maximum of four measurements at a time.
- To avoid measurement error on a noisy signal, be sure you are not measuring the noise. For example, you might measure the frequency or period of the noise when you want that of the waveform. Switching to Average acquisition mode may help by reducing the noise.
- To avoid measurement errors due to improper display, adjust the scale of the measured waveform when the logic scope displays warnings indicating improper measurement conditions, such as *low signal amplitude*, *low resolution*, and *clipping*.
- To move all measurements outside the graticule area, press **CLEAR MENU**.

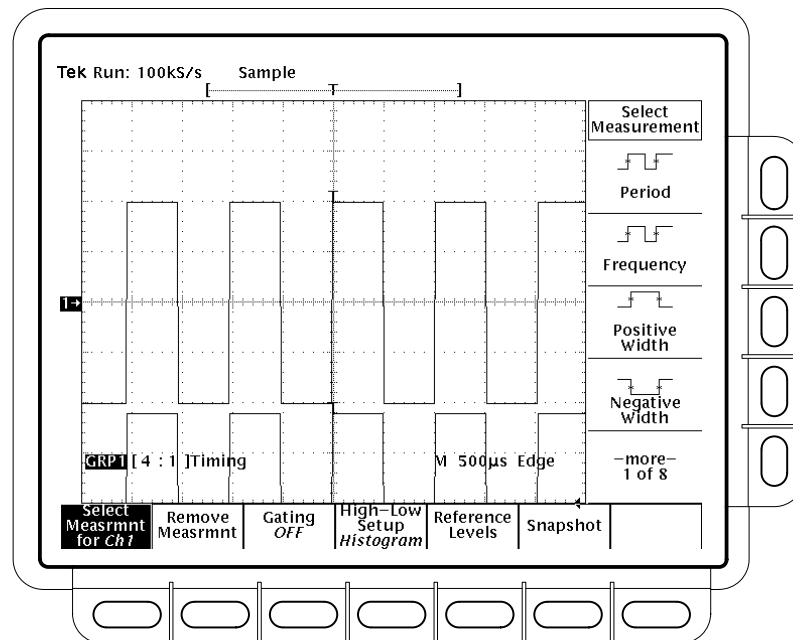

Figure 3-32: Measure Menu

### Remove a Measurement

To remove a measurement, use the Remove Measurement menu.

1. Press **MEASURE** → **Remove Measrmnt** (main).
2. Select one or more of **Measurement 1** – **Measurement 4** from the side menu. If you want to remove all the measurements at one time, press **All**



**Measurements** (side). Select your measurement based on its position in the readout. (See the following **NOTE**.)

**NOTE.** As you create measurements, they are displayed in the order created. Measurement 1 is the top readout, Measurement 2 is below it, and so on. (See Figure 3-31 on page 3–68.) Once you display a measurement readout, it stays in its position. It does not move upwards when you remove any readouts above it.

**Turn on Gating**

To limit *all* automated measurements to a specific part of the waveform record, do the following steps:

1. Press **MEASURE** → **Gating** (main) → **Gate with V Bar Cursors** (side). (See Figure 3-33.)

Turning gating on turns on the V Bar cursors. These cursors now define the section of the waveform you want the logic scope to measure. This section is called the gated region.

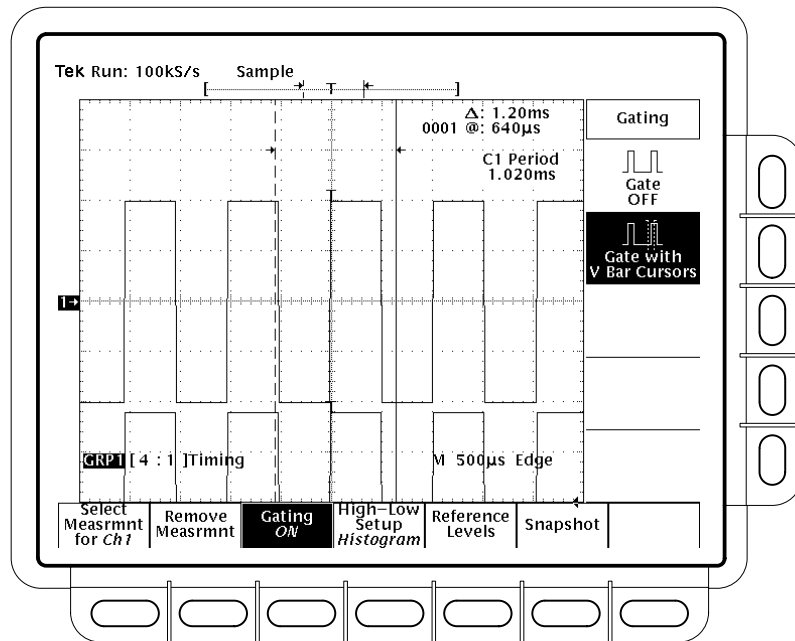

**Figure 3-33: Measure Menu — Gating**

2. Using the general purpose knob, move the selected (the active) cursor. Press **SELECT** to change which cursor is active. Adjust the cursors until they just span the measurement area.

Turning V Bar cursors off in the Cursor menu will *not* turn gating off. (Gating arrows remain on screen to indicate the area over which the measurement is gated.) You must turn gating off in the Gating side menu.

---

**NOTE.** *If you turn off horizontal locking and adjust the horizontal position of one waveform independent of the other, the cursors maintain their positions relative to the selected waveform only. Therefore, they appear to no longer gate the correct region on any group not selected. The logic scope still takes the gated measurements on any group not selected using the correct gated region. Select the group (or restore horizontal locking) to see the cursors positioned properly on any group.*

---

### Adjust the High-Low Setup

To choose a new high-low setup, do the following steps:

1. Press **MEASURE**.
2. Press **High-Low Setup** (main) → **Histogram** or **Min-Max** (side). If you select **Min-Max**, you may also want to check or revise values using the Reference Levels main menu. The two setup types are described below.

*Histogram* sets the values statistically. It selects the most common value either above or below the mid point, depending on whether it is defining the high or low reference level. Since this statistical approach ignores short term aberrations (overshoot, ringing, and so on), Histogram is the best setting for examining pulses.

*Min-Max* uses the highest and lowest values of the waveform record. This setting is best for examining waveforms that have no large, flat portions at a common value, such as sine wave and triangle waves—almost any waveform except for pulses.

The logic scope uses the selected high-low setup for all measurements derived based on those levels.

### Set the Reference Levels

To set the reference levels, do the following steps:

1. Press **MEASURE** → **Reference Levels** (main).
2. Toggle **Set Levels in** (side) to choose between **%** and **units**. (See Figure 3-34.) The two selections are described below.

**%** sets reference levels as a percentage between High (100%) and Low (0%) levels. It is useful for general purpose applications and is the default selection.

**Units** sets the levels as in the units of measurement (typically volts). Use this selection when setting a reference level to precise values. For example, if

measuring specifications on an RS-232-C circuit, you might select Units and set the levels to precisely match the RS-232-C voltage values.

3. Press **High Ref**, **Mid Ref**, **Low Ref**, or **Mid2 Ref** (side). Use the general purpose knob or keypad to enter the values.



*High Ref* sets the high reference level. The default is 90%.



*Mid Ref* sets the middle reference level. The default is 50%.



*Low Ref* sets the low reference level. The default is 10%.



*Mid2 Ref* sets the middle reference level used on the second waveform specified in the Delay, Phase, Hold, and Setup Measurements. The default is 50%.

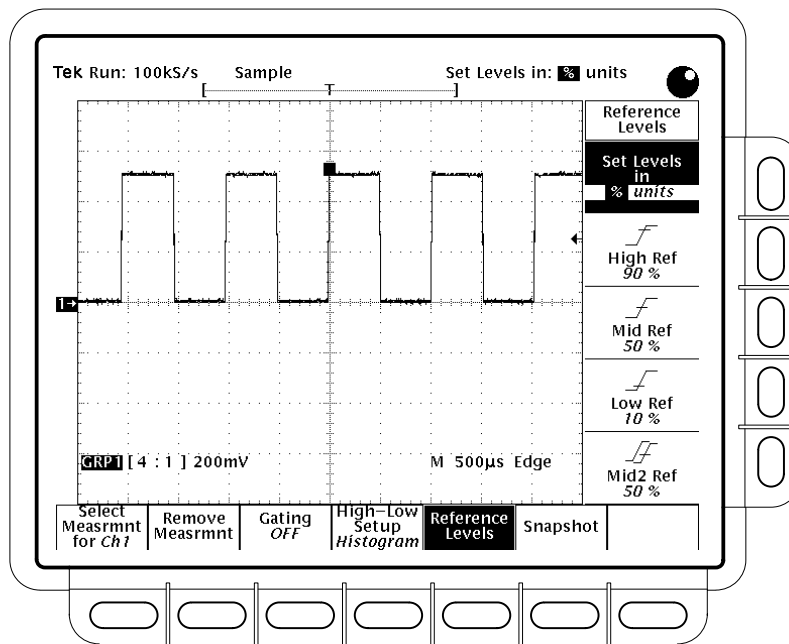

Figure 3-34: Measure Menu — Reference Levels

The logic scope uses the reference levels you set for all measurements derived based on those levels.

## To Take Measurements on Multiple Waveforms

The logic scope takes Delay and Phase measurements on two channels instead of one. The logic scope takes measurements of a group of channels when taking Setup, Hold, and Skew measurements. Table 3–3 on page 3–68 defines these measurements. Do the following procedures to these automated measurements.

### Measure Delay

To measure delay, you select the waveform to measure delay *to* (the waveform to measure delay *from* is the selected channel in the selected group). Then you select the edges on the two waveforms. To do these tasks, do the following steps.

1. Press **MEASURE** → **Select Measrmt** (main) → **Delay** (side). This sequence brings up the Measure Delay main menu. (See Figure 3-35.)
2. Press **Delay To** (main) → **Measure Delay to** (side).

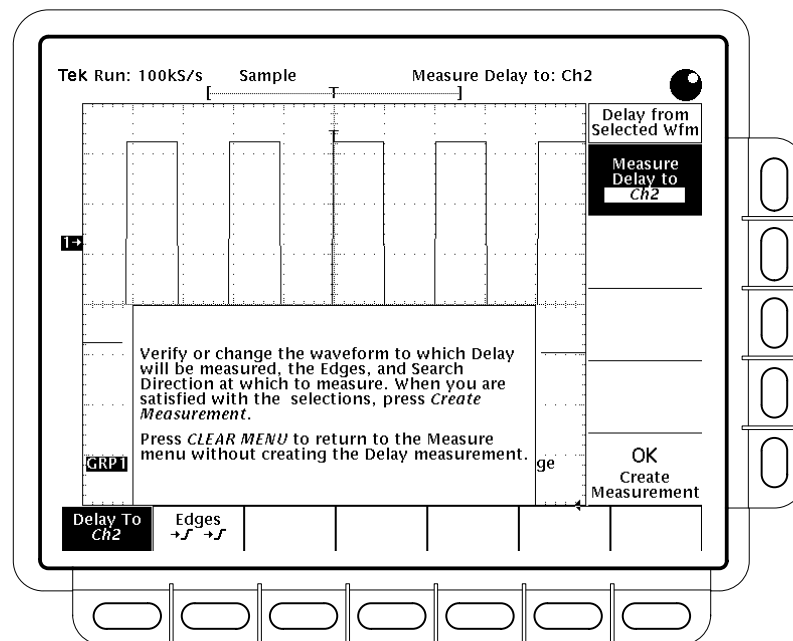

Figure 3-35: Measure Delay Menu — Delay To

3. Press **Measure Delay to** (side) repeatedly to choose the delay *to* waveform. The choices are live channels **Ch1** through **Ch16** and the reference channels **Ref1(1)** through **Ref4(16)**. You can also use the general purpose knob to speed scrolling through the menu choices.

Note that since reference waveforms acquired in the same channel can be saved to different reference (Channel 1 can appear in all four reference groups), any one of 16 channels can be specified for each reference group. A

waveform for the specified channel must exist in the specified reference, or the logic scope displays an error message.

4. Press **Edges** (side). A side menu of delay edges and directions will appear.
5. Choose from one of the combinations displayed on the side menu.

The upper waveform on each menu label represents the *from* waveform, and the lower one represents the *to* waveform.

The direction arrows on each menu label let you specify a forward search on both waveforms or a forward search on the *from* waveform and a backwards search on the *to* waveform. The latter case is useful for isolating a specific pair of edges out of a stream.

6. Press **Delay To** (main) → **OK Create Measurement** (side) to take the measurement you have specified.

To exit the Measure Delay menu without creating a delay measurement, press **CLEAR MENU**, which returns you to the Measure menu.

### Measure Phase

To measure phase, select the waveform to measure phase *to* (the waveform to measure phase *from* is the selected channel in the selected group). Then create the phase measurement as was just described for the delay measurement. You do not select waveform edges when measuring phase.

### Measure Setup

To measure setup, you select the waveform group to measure, the channel that contains its clock, and the edge of the clock you want to measure setup relative to. To do these tasks, perform the following steps:

1. Use the group selection buttons to select any live or reference group.
2. Press **MEASURE** → **Select Measrmnt** (main) → **Setup** (side). (Press **-More-** (side) as needed to display the setup items.) (See Figure 3-36.)

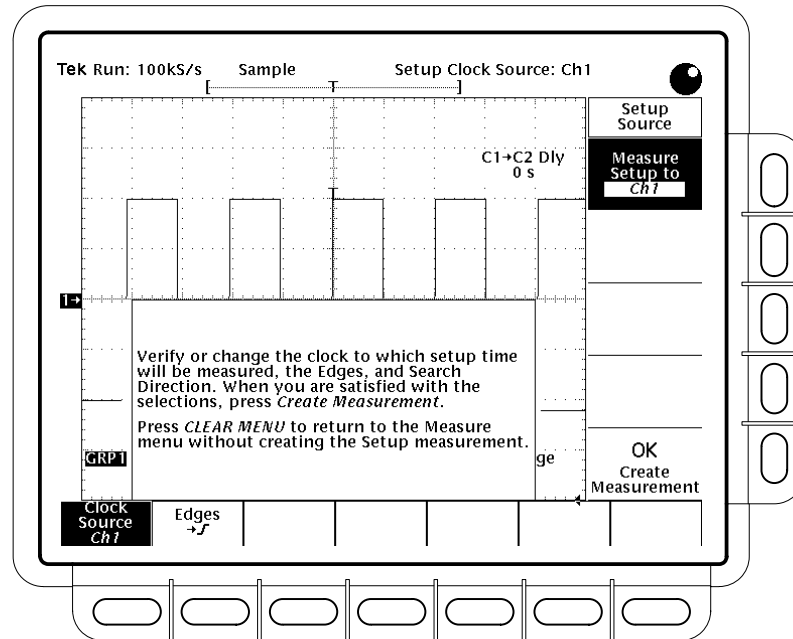

Figure 3-36: Measure Setup Menu

3. Press **Clock Source** (main) → **Measure Setup to** (side). Repeatedly press **Measure Setup to** (side) until the clock you wish to measure setup time against appears.
4. Press **Edges** (main) and specify a positive or negative clock in the side menu.
5. To complete the measurement you have specified, press **Clock Source** (main) → **OK Create Measurement** (side).

To exit the Measure Setup menu without creating a setup measurement, press **CLEAR MENU**, which returns you to the Measure menu.

**Measure Hold** To measure hold, use the process just outlined for *Measure Setup*. Select **Hold** (side) instead of **Setup** (side) when you do step 2.

**Measure Skew** To measure skew, simply select it, press **MEASURE** → **Select Measurement** (main) → **Skew** (side).

## To Take a Snapshot of Measurements

To display all single waveform measurements at one time, first obtain a stable display of the waveform to be measured. (Pressing AUTOSET may help.) Then, do the following steps:

1. Press **MEASURE** → **Snapshot** (main).
2. Press either **Snapshot** (main) or **Again** (side) to take another snapshot. Press **Remove Measrmnt** (main) to remove the snapshot without leaving the Measure menu.

The readout area for a snapshot of measurements is a pop up display that covers about 80% of the graticule area. (See Figure 3-37.) Note that the snapshot display tells you the channel that the snapshot is taken on.

### Considerations When Taking Snapshots

To use snapshot effectively, become familiar with the following operating hints:

- To avoid measurement error and maximize measurement accuracy, display the waveform properly before taking a snapshot. Snapshot does not warn you if a waveform is improperly scaled (clipped, low signal amplitude, low resolution, and so on).
- To vary the source for taking a snapshot, simply select another group (live or reference) and select a channel in that group. Then execute snapshot again.
- To update the snapshot measurements, take another snapshot. Keep in mind that the logic scope takes all its snapshot measurements *once* — on a single waveform acquisition (or acquisition sequence) — and displays the results. The measurements in the snapshot display are *not* continuously updated.
- To avoid measurement error on a noisy signal, be sure you are not measuring the noise. Switching to Average acquisition mode may help reduce the noise.
- To change the High-Low Setup (page 3–73), Reference Levels (page 3–73), or to make Gated Measurements (page 3–72) with snapshot, perform the procedures exactly as you would when you display individual measurements from the Select Measrmnt menu.

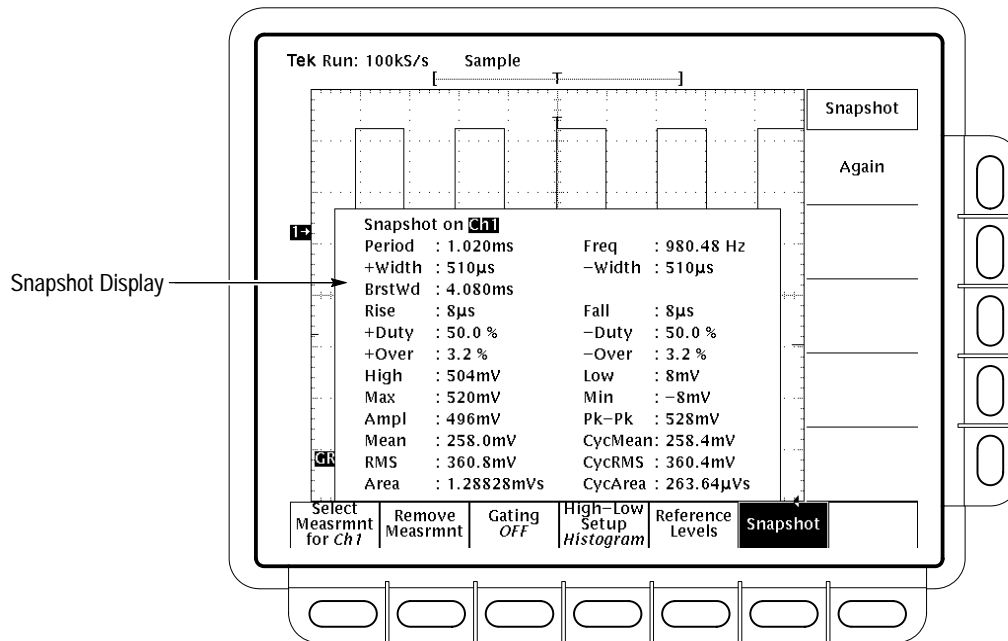

Figure 3-37: Snapshot Menu and Readout

- To take Delay, Phase, Hold, Setup, and Skew measurements, display them as individual measurements. The logic scope does not include measurements taken on more than one waveform in a snapshot.
- To display a snapshot of a channel saved in a reference group, select the reference group and channel before executing snapshot.
- To remove the snapshot display, press any button in the main menu (except Snapshot) or any front-panel button that displays a new menu.

## To Find More Information

See *Appendix B: Algorithms*.

See *Example 3: Automated Measurements*, on page 1–23.

See *Measurements*, on page 2–27.

See *Measuring Waveforms with Cursors*, on page 3–81.





# Measuring Waveforms with Cursors

The TLS 216 Logic Scope provides cursors to measure the difference (either in time or voltage) between any two points on one or more waveforms in a group. The logic scope can also display the binary value at a single point along the group record.

This article describes cursors — how they work, how to select them, to display them, and use them to take measurements.

For information on automatic and graticule measurements, see *Measuring Waveforms Automatically* on page 3–67 and *Measurements* on page 2–27.

## To Understand Cursors

Cursors are made up of two markers that you position with the general purpose knob. You move one cursor independently or both cursors in tandem, depending on the cursor mode. As you position the cursors, readouts on the display report measurement information. To help you effectively use cursors, read the following discussions of how their operation varies with type and mode.

### Cursor Types

There are three cursor types: *horizontal bar*, *vertical bar*, and *paired*. (See Figure 3-38.)

Horizontal bar cursors measure vertical parameters (typically volts).

Vertical bar cursors measure horizontal parameters (typically time or frequency). The cursor readout also displays the binary values for each group of waveforms displayed based on the amplitude of each waveform relative to high and low reference levels. (See *Binary Readout* on page 3–83 in this article.)

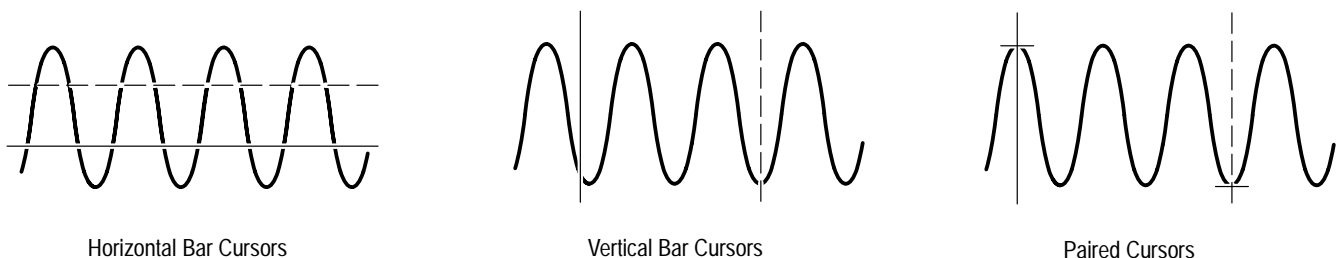
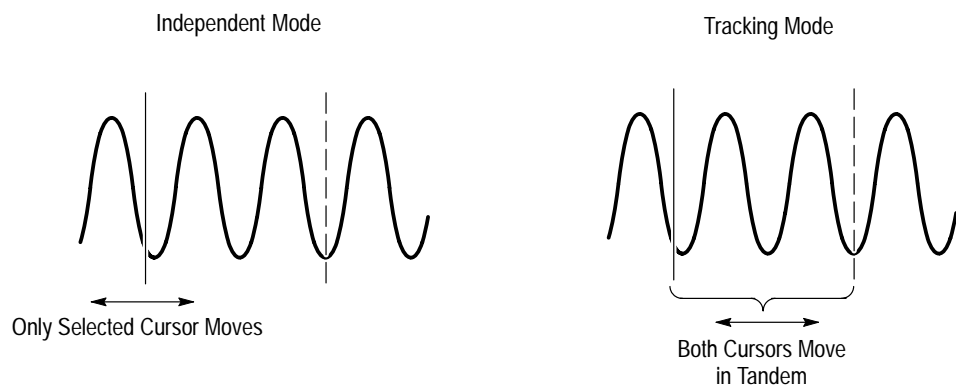

Figure 3-38: Cursor Types

Paired cursors measure both vertical parameters (typically volts) and horizontal parameters (typically time) at once.

Look at Figure 3-38. Note that each of the two paired cursors has a long vertical bar paired with a short horizontal bar. The short horizontal bars measure vertical parameters (typically volts). The long vertical bars measure horizontal parameters (typically time or frequency). (See *To Interpret Cursor Readouts* below for more information.)

**Cursor Modes** There are two cursor modes: *independent* and *tracking*. (See Figure 3-39.)



**Figure 3-39: Cursor Modes**

In independent mode you move only one cursor at a time using the general purpose knob. The active, or selected, cursor is a solid line. Press **SELECT** to change which cursor is selected.

In tracking mode, you normally move both cursors in tandem using the general purpose knob. The two cursors remain a fixed distance (time or voltage) from each other. Press **SELECT** to temporarily suspend cursor tracking. You can then use the general purpose knob to adjust the distance of the solid cursor relative to the dashed cursor. A second press toggles the cursors back to tracking.

## To Interpret Cursor Readouts

To become familiar with what the cursor readout displays and how it varies with the cursor type selected, H Bars, V Bars, or Paired, read the following descriptions.

**H Bars** The value after  $\Delta$  shows the voltage difference between the cursors. The value after @ shows the voltage of the selected cursor relative to ground.

**V Bars** The value after  $\Delta$  shows the time (or frequency) difference between the cursors. The value after @ shows the time (or frequency) of the selected cursor relative to the trigger point. The value before @ shows the binary value at the intersection of the selected cursor and the waveforms in all existing groups whether displayed or not. (See Figure 3-40.) (The binary readout is described in detail below.)

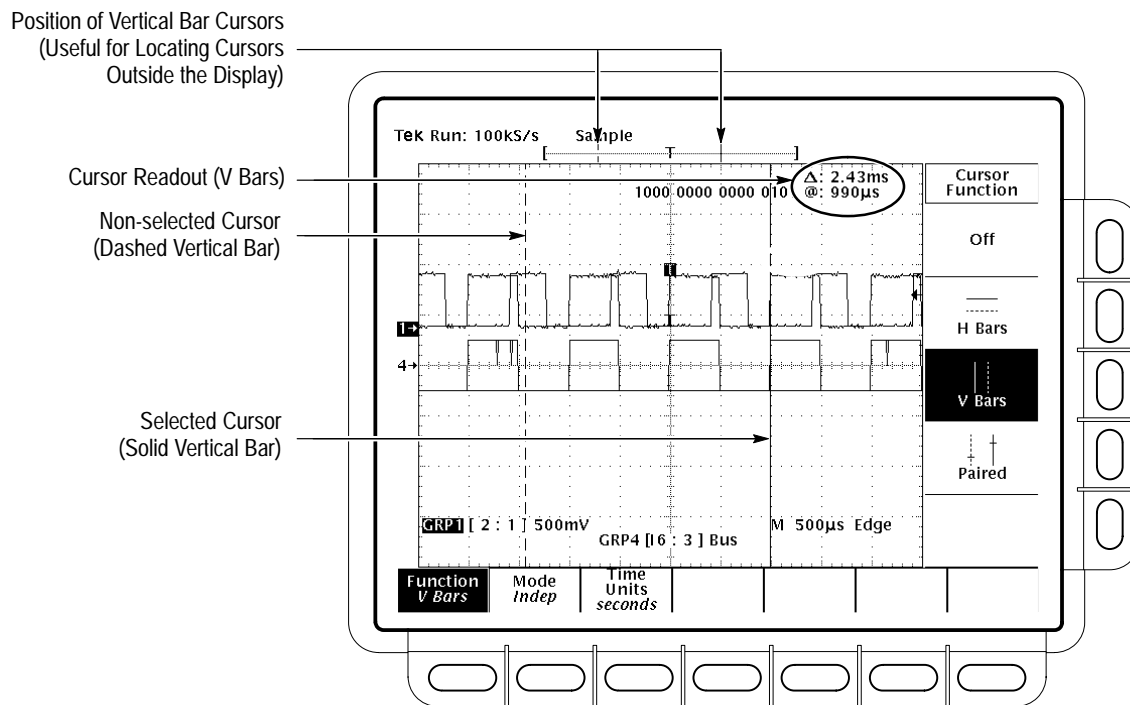

Figure 3-40: Vertical Bar Cursor Readout (With Binary Readout)

**Paired** The value appearing after the upper  $\Delta$  shows the voltage difference between the the two short horizontal bars; the value appearing after the lower  $\Delta$  shows the time (or frequency) difference between the two long vertical bars. The value after @ shows the voltage at the short horizontal bar of the selected cursor relative to ground. (See Figure 3-41.)

**Binary Readout** As indicated above, the V Bars cursor readout includes a readout of the binary value, up to 16-bits wide, for all channels currently assigned to groups 1 through 8. The binary readout:

- displays a 1 (logic HIGH) for waveform levels  $> V_{\text{High (min)}}$ .
- displays a 0 (logic LOW) for waveform levels  $< V_{\text{Low (max)}}$ .
- displays a ? (for undefined) for waveforms levels such that  $V_{\text{High (min)}} < \text{waveform level} < V_{\text{Low (max)}}$ .

- displays a ~ (for unknown) whenever the active V Bar cursor is positioned off screen.
- displays the binary value so that its most significant bit corresponds to the highest numbered channel. This bit order matches the channel input sequence on the front panel of the logic scope (Ch 16 through Ch 1, from left to right).
- displays each bit in the color that matches the group to which it belongs. Channels not belonging to a group are not displayed.
- displays for all grouped channels whether the group is displayed or not.

## To Take Cursor Measurements

To take cursor measurements, do the following procedures.

**Select a Function** To select the cursor function, press **CURSOR** → **Function** (main) → **H Bars**, **V Bars**, **Paired**, or **Off** (side). (See Figure 3-41.)

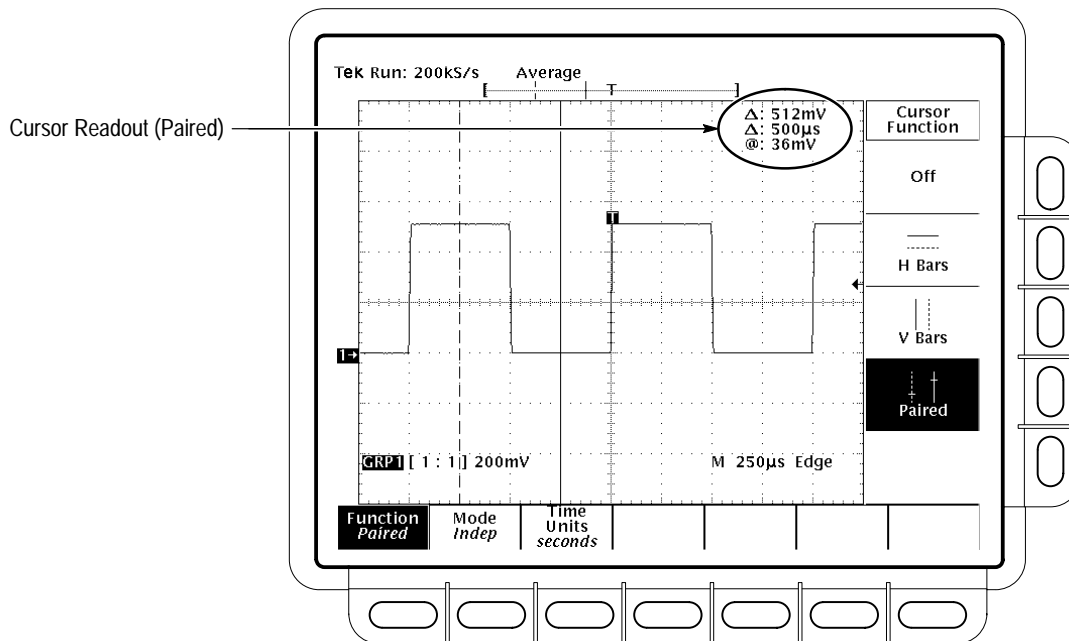

**Figure 3-41: Cursor Menu and Readouts — Paired Cursors Selected**

Paired cursors can only show voltage differences when they remain on screen. If the paired cursors are moved off screen horizontally, the word “Edge” will replace the voltage values in the cursor readout.

**Set the Mode**

To set the cursor mode, press **CURSOR → Mode** (main) → **Independent** or **Tracking** (side).

*Independent* makes each cursor positionable without regard to the position of the other cursor.

*Tracking* makes both cursors positionable in tandem; that is, both cursors move in unison and maintain a fixed horizontal or vertical distance between each other.

**Adjust the Cursors**

To adjust either cursor in Independent mode, use the general purpose knob to move the selected (active) cursor. A solid line indicates the adjustable cursor and a dashed line the fixed cursor. Press **Select** to toggle between selecting

To adjust both cursors in Tracking mode, use the general purpose knob to move both cursors.

To adjust the distance between cursors in Tracking mode, press **SELECT** to temporarily suspend cursor tracking. Then use the general purpose knob to adjust the distance of the solid cursor relative to the dashed cursor. Press **SELECT** again to resume tracking.

To speed up or slow down adjustment of a cursor, press **SHIFT** before turning the general purpose knob. The cursor moves faster when the SHIFT button is lighted and the display reads *Coarse Knobs* in the upper right corner.

**Selecting Time Units**

To choose to display vertical bar cursor results in units of time or frequency: press **CURSOR → Time Units** (main) → **seconds** or **1/seconds (Hz)** (side).

**To Find More Information**

See *Measurements*, on page 2–27.



# Printing a Hardcopy

The TLS 216 Logic Scope can provide you with hardcopies of its display. To obtain a hardcopy, you need to know how to configure the communication and hardcopy parameters of the logic scope, how to connect it to one of the many hardcopy devices it supports, and how to print the hardcopy. This article describes how to do these tasks and how to save a hardcopy to a floppy disk.

## Supported Formats

The logic scope prints hardcopies of its display in many formats, which allows you to choose from a wide variety of hardcopy devices. It also makes it easier for you to place logic scope screen copies into a desktop publishing system. The logic scope supports the following formats:

- HP Thinkjet inkjet printer
- HP Deskjet inkjet printer
- HP Laserjet laser printer
- Epson
- DPU-411/II portable thermal printer
- DPU-412 portable thermal printer
- PCX® (PC Paintbrush®)
- PCX Color (PC Paintbrush®)
- TIFF® (Tag Image File Format)
- BMP® Mono (Microsoft Windows file format)
- BMP® Color (Microsoft Windows file format)
- RLE Color (Microsoft Windows color image file format – compressed)
- EPS Mono Image (Encapsulated Postscript, mono-image)
- EPS Color Image (Encapsulated Postscript, color-image)
- EPS Mono Plot (Encapsulated Postscript, mono-plot)
- EPS Color Plot (Encapsulated Postscript, color-plot)
- Interleaf
- HPGL Color Plot



Depending on the output format selected, the logic scope creates either an image or a plot. Images are direct bit map representations of the logic scope display. Plots are vector (plotted) representations of the display.

Some formats, particularly Interleaf, EPS, TIFF, PCX, BMP, and HPGL, are compatible with various desktop publishing packages. Such compatibility means you can paste files created from the logic scope directly into a document on any of those desktop publishing systems.

EPS Mono and Color formats are compatible with Tektronix Phaser Color Printers, HPGL is compatible with the Tektronix HC100 Plotter, and Epson is compatible with the Tektronix HC200 Printer.

## To Set Up for Making Hardcopies

Before you make a hardcopy, you need to set up communications and hardcopy parameters. Do the following procedures to set up for making hardcopies.

### Set Communication Parameters

To set up the communication parameters for a printer attached directly to the logic scope GPIB, RS-232 or Centronics port:

Press **SHIFT** → **UTILITY** → **System** (main) → **I/O** (pop-up) → **Configure** (main) → **Hardcopy (Talk Only)** (side). (See Figure 3-42.)

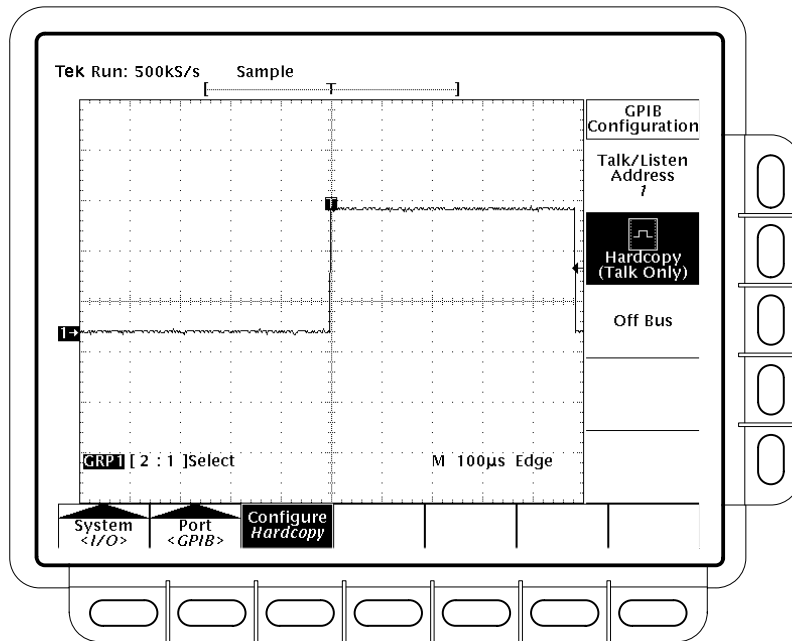
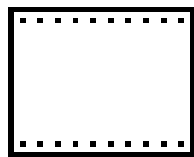

Figure 3-42: Utility Menu — System I/O

### Set Hardcopy Parameters

To specify the hardcopy format, layout, and type of port using the hardcopy menu, do the following steps:

1. Press **SHIFT** → **HARDCOPY MENU** to bring up the **Hardcopy** menu.
2. Press **Format (main)** → **Thinkjet, Deskjet, Laserjet, Epson, DPU-411, DPU-412, PCX, PCX Color, TIFF, PCX, BMP Mono, BMP Color, RLE Color, EPS Mono Img, EPS Color Image, EPS Mono Plt, EPS Color Plt, EPS Color, Interleaf, or HPGL (side)**. (Press **–more– (side)** to page through all of these format choices.)
3. Press **SHIFT** → **HARDCOPY MENU** → **Layout (main)** → **Landscape** or **Portrait (side)**. (See Figure 3-43.)



Landscape Format

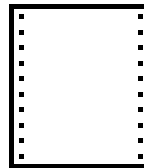

Portrait Format

Figure 3-43: Hardcopy Formats

4. Press **SHIFT** → **HARDCOPY MENU** → **Palette (main)** → **Hardcopy** or **Current (side)** to specify a hardcopy palette. **Current** uses the current palette settings to create the hardcopy, while **Hardcopy** sets the hardcopy palette to an optimal setting for hardcopy devices.
5. Press **SHIFT** → **HARDCOPY MENU** → **Port (main)** to specify the output channel to send your hardcopy through. The choices are **GPIOB, RS-232, Centronics, and File**.

The menu item File chooses the floppy disk drive as the destination for hardcopies. See *To Save to a Floppy Disk* on page 3-92.

### Date/Time Stamp the Hardcopy

You can display the current date and time on screen so that they appear on the hardcopies you print. To date and time stamp your hardcopy, do the following steps:

1. Press **DISPLAY** → **Settings (main)** → **Display (pop-up)** → **Readout Options (main)** → **Display Date and Time (side)** to toggle the setting to **On**.
2. If you want to set the date and time, skip steps 3 and 4 and continue with step 1 of *Set the Date and Time* below. Then redo this procedure.

3. Press **Clear Menu** to remove the menu from the display so the date and time can be displayed. (See Figure 3-44.) (The date and time are removed from the display when menus are displayed.)
4. Once the logic scope is connected to a hardcopy device, press **HARDCOPY** to print your date/time stamped hardcopy.

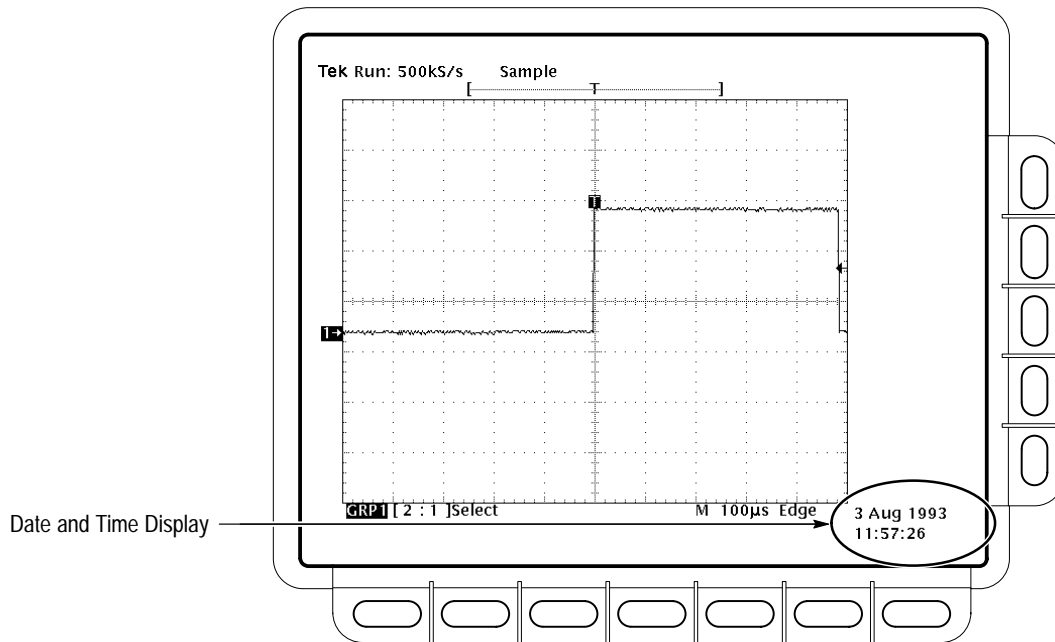

Figure 3-44: Date and Time Display

### Set the Date and Time

You might need to set the date and time of the logic scope. To set those parameters, do the following steps.

1. Press **SHIFT** → **UTILITY** → **Config** (pop-up) → **Set Date & Time** (main) → **Year**, **Day Month**, **Hour**, or **Minute** (side).
2. Use the general purpose knob or the keypad to set the parameter you have chosen to the value desired. (The format when using the keypad is day.month. For example, use 23.6 for the 23<sup>rd</sup> of June.)
3. Repeat steps 1 and 2 to set other parameters as desired.
4. Press **OK Enter Date/Time** (side) to put the new settings into effect. This sets the seconds to zero.

---

**NOTE.** When setting the clock, you can set to a time slightly later than the current time and wait for it to catch up. When current time catches up to the time you have set, pressing **Ok Enter Date/Time** (side) synchronizes the set time to the current time.

---

5. Press **CLEAR MENU** to see the date/time displayed with the new settings.

## To Print Directly to a Hardcopy Device

To make your hardcopies, use the procedures that follow.

### Connect to a Hardcopy Device

To connect the logic scope directly to a hardcopy device, determine which interface and cable the device uses, and connect accordingly. (See Figure 3-45.)

Some devices, such as the Tektronix HC100 Plotter, use the GPIB interface. Many printers, such as the Tektronix HC200, use Centronics interfaces. Many hardcopy devices, including the HC100 and HC200 with option 03, provide RS-232 support. (Check the documentation for your hardcopy device.)

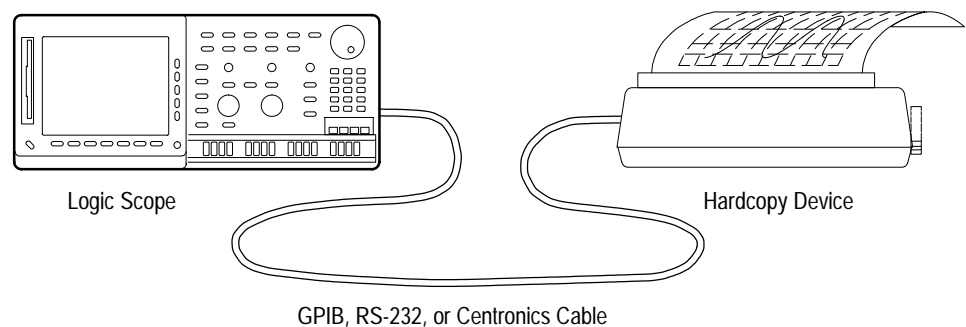

Figure 3-45: Connecting the Logic Scope Directly to the Hardcopy Device

**Print** To print a single hardcopy or send additional hardcopies to the logic scope spool (queue) while waiting for earlier hardcopies to finish printing, press **HARDCOPY**.

While the hardcopy is being sent to the printer, the logic scope will display the message “Hardcopy in process — Press **HARDCOPY** to abort.”

**Abort** To stop and discard the hardcopy being sent, press **HARDCOPY** again *while* the hardcopy in process message is still on screen.

**Add to Spool** To add additional hardcopies to the printer spool, press **HARDCOPY** again *after* the hardcopy in process message is removed from the screen.

You can add hardcopies to the spool until it is full. When adding a hardcopy fills the spool, the message “Hardcopy in Process—Press **HARDCOPY** to abort” remains displayed. You can abort only the *last* hardcopy sent by pressing the button while the message is still displayed. When the printer empties enough of the spool to finish adding the last hardcopy, it does so and then removes the message.

**Clear the Spool** To remove all hardcopies from the spool, press **SHIFT → HARDCOPY MENU → Clear Spool** (main) → **OK Confirm Clear Spool** (side).

The logic scope takes advantage of any unused RAM when spooling hardcopies to printers. The size of the spool is, therefore, variable. The number of hardcopies that can be spooled depends on three variables:

- the amount of unused RAM
- the hardcopy format chosen
- the complexity of the display

Although not guaranteed, usually about 2.5 hardcopies can be spooled before the logic scope must wait to send the rest of the third copy.

## To Save to a Floppy Disk

To send hardcopies to a floppy disk, do the following steps.

1. Set up the logic scope communication and hardware parameters as outlined in *To Set Up for Making Hardcopies* on page 3–88.
2. Insert a formatted 720 Kbyte or 1.44 Mbyte floppy disk into the slot at the left of the logic scope display.

---

**NOTE.** *To format disks, delete hardcopy files you save to disk, and otherwise manage the disk storage, see Managing the File System on page 3–61.*

---

3. Press **SHIFT → HARDCOPY MENU → Port** (main) → **File** (side) to specify that any hardcopy made be output to a file on the floppy drive. The file list and its scrollbar will appear.
4. Turn the general purpose knob to place the scroll bar over the file in which to store the hardcopy.

**NOTE.** Upon power on, the logic scope creates the “wild card” file TEK?????.FMT for storing hardcopies, where “.FMT” is replaced by the hardcopy format you select. Selecting this file and pressing Hardcopy stores a hardcopy in a uniquely named, sequentially numbered file. For instance, the logic scope saves the first hardcopy you save to the file TEK00001.FMT, the second to TEK00002.FMT, and so on.

5. Press **HARDCOPY** to print your hardcopy to the selected file.

Saving files to the floppy disk provides a convenient way to store hardcopies for later recall and display at a remote site. You can recall them using another logic scope at the remote sight. You might also load the into your desktop publishing software that runs on a PC compatible.

## To Print Using a Controller

To make your hardcopies, use the procedures that follow.

### Connect to a Hardcopy Device

To connect a controller with two ports between the logic scope and the hardcopy device, connect from the logic scope GPIB connector (rear panel) to the controller GPIB port and from the controller RS-232 or Centronics port to the hardcopy device. (See Figure 3-46.) Use the GPIB port to remotely request and receive a hardcopy from the logic scope. Use the RS-232 or the Centronics port on the controller to print output.

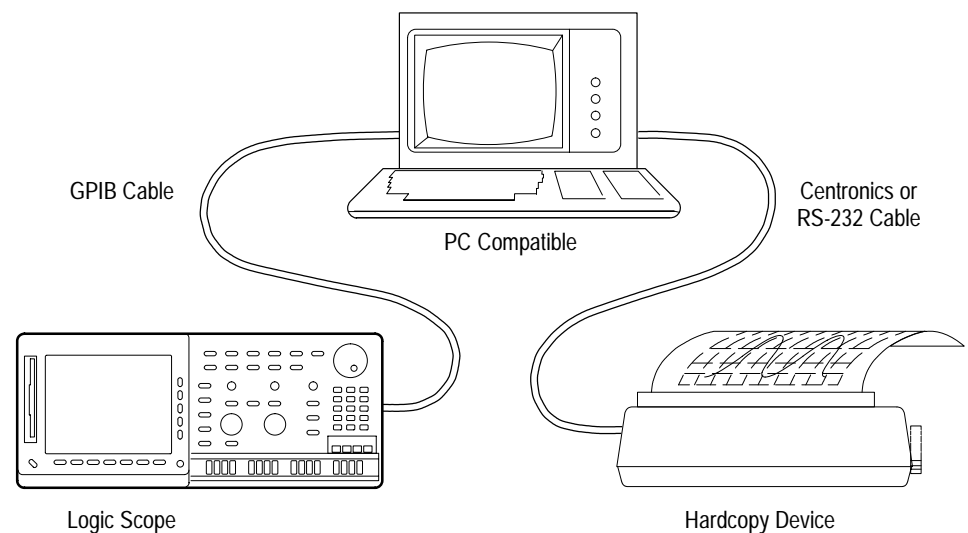

**Figure 3-46: Connecting the Logic Scope and Hardcopy Device Via a PC**

**Print** If your controller is PC-compatible and it uses the Tektronix GURU™ or S3FG210 (National Instruments GPIB-PCII/IIA) GPIB package, do the following steps to print a hardcopy:

1. Use the MS-DOS *cd* command to move to the directory that holds the software that came with your GPIB board. For example, if you installed the software in the GPIB-PC directory, type: **cd GPIB-PC**.
2. Run the IBIC program that came with your GPIB board. Type: **IBIC**.
3. Type: **IBFIND DEV1** where “DEV1” is the name for the logic scope you defined using the IBCONF.EXE program that came with the GPIB board.

---

*NOTE. If you defined another name, use it instead of “DEV1”. Also, remember that the device address of the logic scope as set with the IBCONF.EXE program should match the address set in the logic scope Utility menu (typically, use “1”).*

---

4. Type: **IBWRT “HARDCOPY START”**

---

*NOTE. Be sure the logic scope Utility menu is set to Talk/Listen and not Hardcopy (Talk Only) or you will get an error message at this step. Setting the logic scope Utility menu is described under Setting Communication Parameters on page 3–88.*

---

5. Type: **IBRDF <Filename>** where <Filename> is a valid DOS file name with which you want to label your hardcopy file. It should be ≤ 8 characters long and up to a 3 character extension. For example, you could type “*ibrdf screen1*”.
6. Exit the IBIC program by typing: **EXIT**
7. Copy the data from your file to your hardcopy device. Type: **COPY <Filename> <Output port> </B>** where:

<Filename> is the name you defined in step 5 and

<Output port> is the PC output port your hardcopy device is connected to (such as LPT1 or LPT2).

For example, to copy (print) a file called *screen1* to a printer attached to the *lpt1* parallel port, type “*copy screen1 lpt1: /B*”.

Your hardcopy device should now print a picture of the logic scope screen.

---

**NOTE.** *If you transmit hardcopy files across a computer network, use a binary (8-bit) data path.*

---

## To Find More Information

See *Communicating with Remote Instruments*, on page 3–31.





# Probing of Circuits

This article describes the P6240 FET probe that is shipped with the TLS 216 Logic Scope as a standard accessory. The P6240 probe, when matched with other accessories shipped with the logic scope, can be connected in a variety of configurations to couple signals to the logic scope. Read this article to learn:

- how to install the probe and connect it to circuits.
- how to install the accessories used with the probe and the purpose of those accessories.

The P6240 probe maintains high-input resistance (about 1 M $\Omega$ ) while offering low input capacitance (2.5 pF typical). These input characteristics make the P6240 well suited for taking accurate timing and phase measurements, while maintaining good amplitude accuracy. The P6240 has a dynamic range of  $-12$  to  $+15$  V.

## To Install the Logic Probe

The P6240 probe connects to two adjacent pins: one signal and one ground. The pins, if round pins, must be at least 0.020 inch (0.051 cm.) and, if square pins, can be as large as 0.025 inch (0.064 cm.). They must be spaced 0.100 inch (0.254 cm.) apart at their centers. To install the probe, do the following tasks:

1. Connect a probe base to any one of the **CH 1** through **CH 16** inputs. Simply push the probe into its front-panel receptacle. (See Figure 3-47.)
2. Connect the probe tip between the ground and signal pins. Simply plug the signal onto the two pins, observing the proper polarity. (See Figure 3-47.)



---

**CAUTION.** *Never connect more more than four probes with their probe tips side-by-side on 0.100 inch (0.254 cm.) centers. To do so increases the surface temperature beyond safe operating limits.*

---

3. To uninstall the probe from the logic scope, simply push the latch button on top of the base and unplug it from its input channel. To disconnect the probe tip, simply unplug it while observing the following CAUTION.



**CAUTION.** When disconnecting the probe tip from any circuit or from any probe accessory that may be installed, grasp the probe by the ribbed probe tip and unplug. **DO NOT** pull on the probe cable when disconnecting the probe. See Figure 3-47.

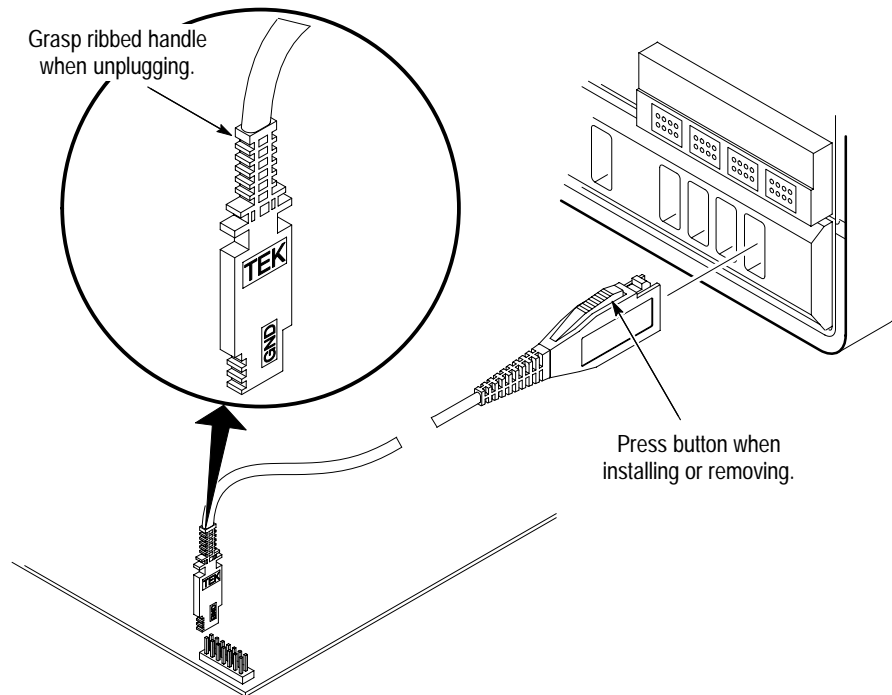

Figure 3-47: Basic Probe Connection

## To Use Accessories with the Probe

The logic scope provides a variety of accessories intended for use with the P6240 probe. To learn how to use these accessories, do the following tasks:

- To see what each accessory looks like and how it fits to the P6240 probe, examine Figure 3-48.
- To learn the purpose of and how to use each accessory, see Table 3-4.
- To consider some of the effects that certain accessories can introduce when taking higher frequency measurements, see *Consider Frequency Effects* on page 3-102.

To reorder any of these and other accessories, refer to Appendix A in this manual.

**At a Glance** The following figure shows the P6240 probe, the logic scope accessories that relate to the probe, and how those accessories fit to the probe and each other. All accessories not labeled optional are standard accessories. (See Table 3-4.)

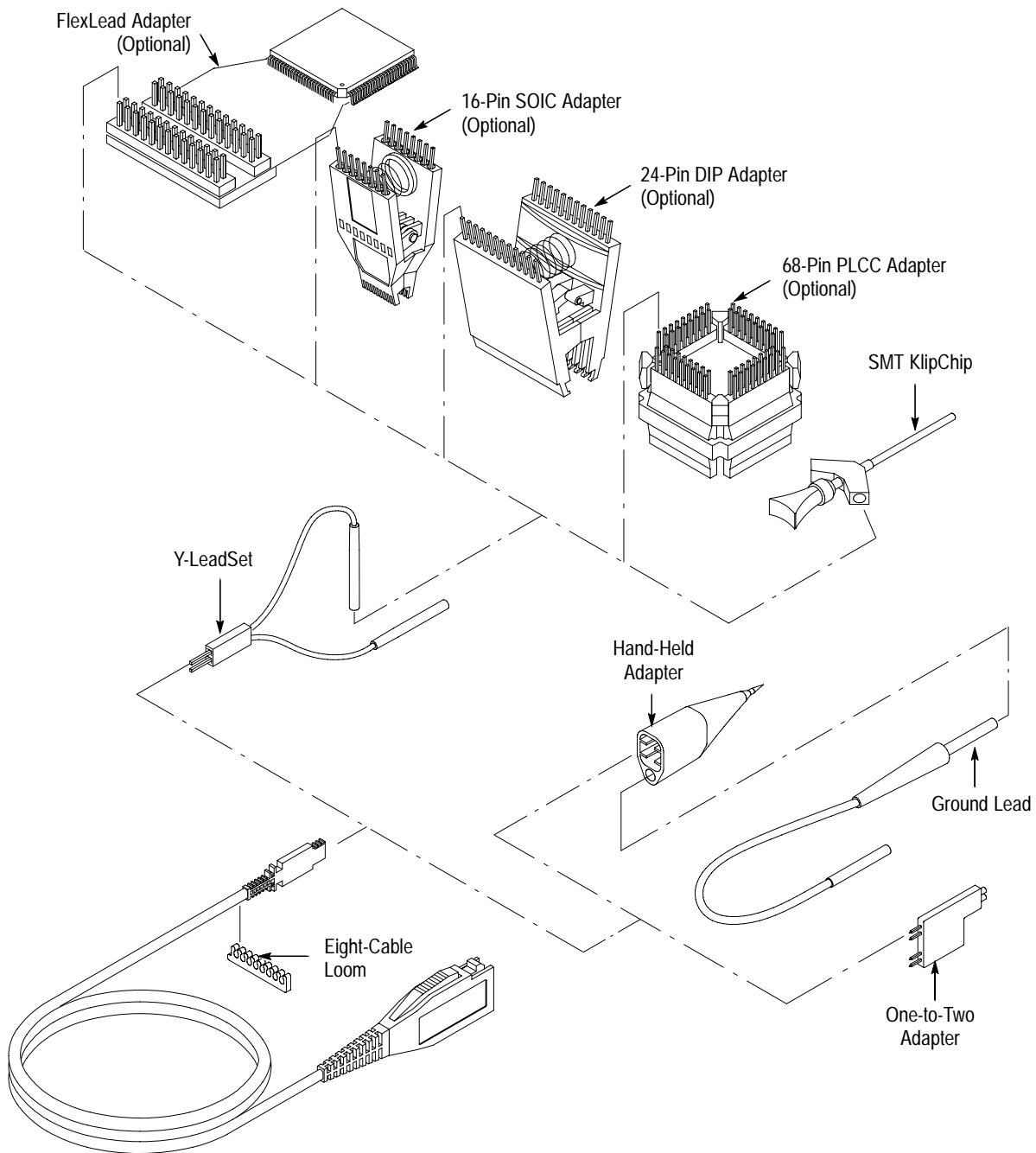

Figure 3-48: Installing Accessories — Standard and Optional

**In Detail** The following table shows how to use each accessory and describes its purpose. Consult Appendix A of this manual for order/reordering information on accessories listed in the table.

**Table 3-4: Probe-Related Accessories**

Accessory	Description
	<p><b>Y-LeadSet</b> — provides a convenient way to connect to two 0.025 diameter connector pins when the pins are not immediately adjacent to each other. These adapters can also be used with the SMT KlipChip to provide access to very small signal and ground test points.</p> <p>Because of the length of the signal lead, the Y-LeadSet configuration adds inductance that should be taken into account when probing frequencies over 30 MHz. Also, the length of the signal lead makes this configuration more susceptible to signal crosstalk than other connection configurations.</p>
	<p><b>SMT KlipChip</b> — provides hands-free attachment to a physically small signal or ground sources. Use two KlipChips with the Y-LeadSet to provide ground and signal attachments to surface-mounted devices.</p> <p>Because of the length of the signal lead, the Y-LeadSet configuration adds inductance that should be taken into account when probing frequencies over 30 MHz. Also, the length of the signal lead makes this configuration more susceptible to signal crosstalk than other connection configurations.</p>
	<p><b>One-to-Two Adapter</b> — converts a pair of adjacent 0.025 diameter connector pins to two pairs of 0.025 diameter pins. Use this adapter to attach two probes to monitor the same signal as follows:</p> <ol style="list-style-type: none"> <li>1. Connect this adapter to a pair of signal and ground square pins on a circuit board. Note the number on the adapter at the connection to the ground pin.</li> <li>2. Mount two probes, one to each of the two square pin pairs. Be sure to match the number of the pin that you connected ground in step 1 to the probe tip ground as you connect each probe tip to the adapter.</li> </ol> <p>Note that connecting two probes across the same points doubles the loading on the circuit under test.</p>
	<p><b>Hand-Held Adapter</b> — provides a convenient way to probe circuit components while holding the probe tip. The P6240 probe tip plugs into the back of the adapter. A ground lead also plugs into the back of this adapter.</p> <p><b>Ground Lead</b> — provides a ground for the hand-held adapter. Align the ground input of the probe with the ground lead connector.</p>

Table 3-4: Probe-Related Accessories (Cont.)

Accessory	Description
 <p data-bbox="219 688 381 716">FlexLead Adapter</p>	<p data-bbox="695 405 1437 495"><b>FlexLead Adapter</b> — provides a convenient way to connect several P6240 probes to several signal pins of an Quad Flat-Pack IC. To put it in use, do the following steps:</p> <ol data-bbox="695 516 1463 684" style="list-style-type: none"> <li data-bbox="695 516 1463 579">1. Solder the FlexLead adapter directly to the Quad Flat-Pack IC pins. <i>Follow the installation instructions accompanying the FlexLead carefully.</i></li> <li data-bbox="695 590 1463 684">2. Plug each P6240 probe directly across the signal and ground pin pairs. Be sure the ground connector on each probe tip connects to the ground pin on the adapter. See the figure at left.</li> </ol>
 <p data-bbox="235 1161 430 1188">16-Pin SOIC Adapter</p>	<p data-bbox="695 961 1463 1115"><b>16-Pin SOIC Adapter</b> — provides a convenient way to connect probes to a 16 pin IC. Use the Y-LeadSet to connect between the ground pin and any signal pin on the SOIC adapter. If you need to make room for additional connections to the SOIC adapter pin (such as the pin connected to ground), add a SMT KlipChip to the ground lead of the Y-LeadSet before connecting to the SOIC adapter pin.</p> <p data-bbox="695 1136 1377 1188">See Appendix A in this manual for information on ordering this optional accessory.</p>
 <p data-bbox="203 1497 381 1524">24-Pin DIP Adapter</p>	<p data-bbox="695 1308 1463 1461"><b>24-Pin DIP Adapter</b> — provides a convenient way to connect probes to a 24 pin IC. Use the Y-LeadSet to connect between the ground pin and any signal pin on the DIP adapter. If you need to make room for additional connections to the DIP adapter pin (such as the pin connected to ground), add a SMT KlipChip to the ground lead of the Y-LeadSet before connecting to the DIP adapter pin.</p> <p data-bbox="695 1482 1377 1535">See Appendix A in this manual for information on ordering this optional accessory.</p>

Table 3-4: Probe-Related Accessories (Cont.)

Accessory	Description
	<p><b>68-Pin PLCC Adapter</b> — provides a convenient way to connect probes to a 68 pin PLCC IC.</p> <p>See Appendix A in this manual for information on ordering this optional accessory.</p>
	<p><b>Eight-Cable Loom</b> — secures up to eight probes to help keep them from entangling with each other.</p>
	<p><b>Marker Tags</b> — provide a method for you to quickly identify the channel a probe is connected to. Just peel off the numbered tags that correspond to the channel on which the probe is installed. Press one of the sticky-back tags to the top of the probe cable where it enters the probe base; press the other to the probe cable at the point it enters the probe tip. See figure at left.</p>

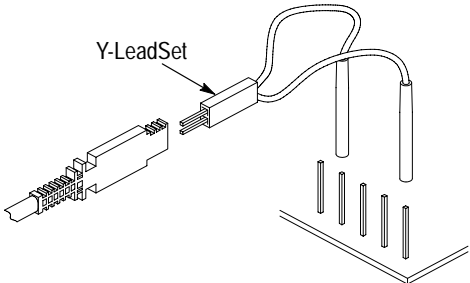
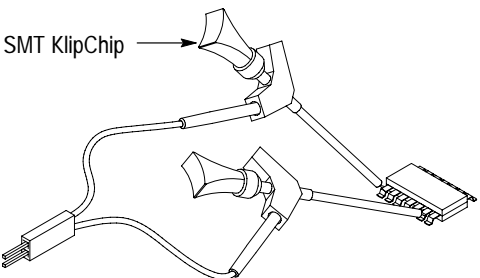
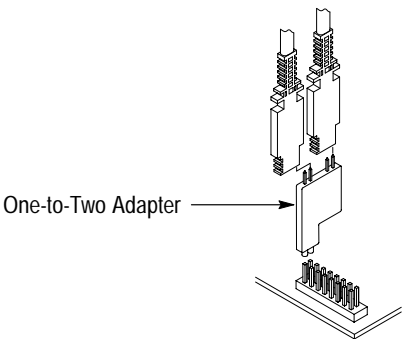
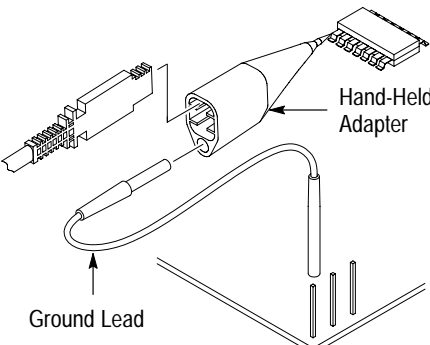
## Consider Frequency Effects

For most circuits, the 1 M $\Omega$ , 2.5 pF input impedance of a FET probe has a small or negligible effect on the signal. The series inductances represented by the probe and ground lead configurations of the following accessories, can degrade measurements at frequencies above 30 MHz:

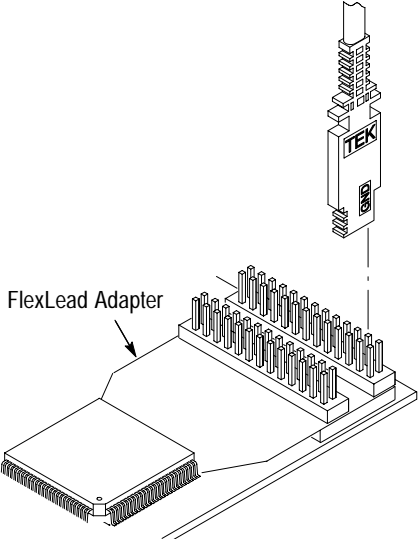
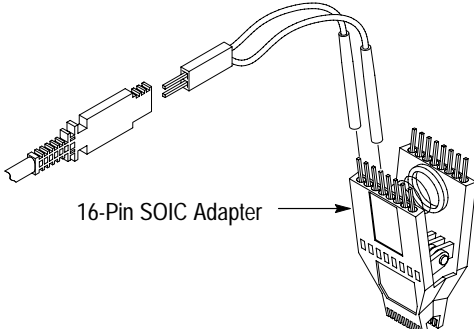
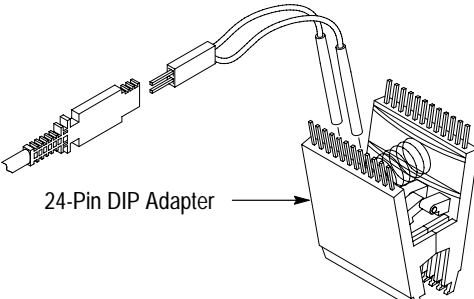
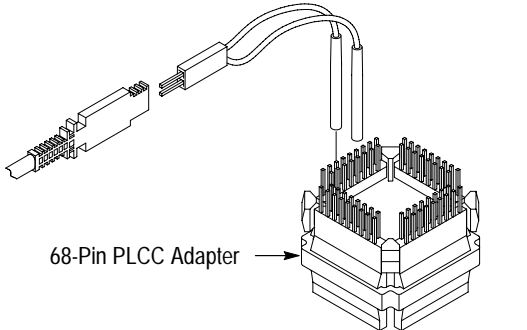
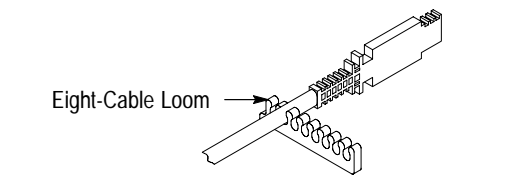
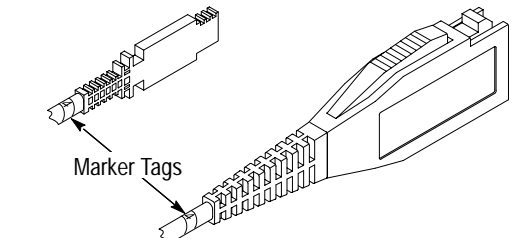
- Y-LeadSet
- SMT KlipChip™
- Hand-Held Adapter with optional ground lead

To consider what circuit elements a probe, when connected into a circuit, introduces, see Figure 3-49.

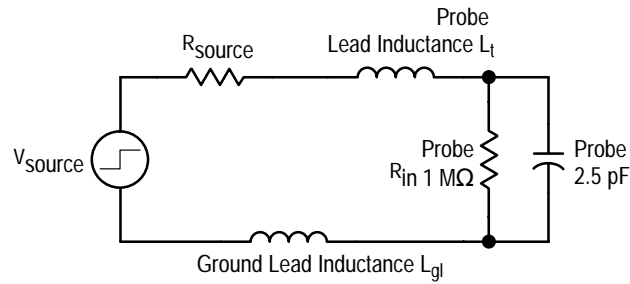

**Figure 3-49: A Probe Adds Resistance, Capacitance, and Inductance**

The series inductances represented by the probe lead and ground lead can result in a parasitic resonant circuit that may “ring” within the bandwidth of the logic scope. Figure 3-50 shows the effect of the same signal through the same probe with different ground leads.

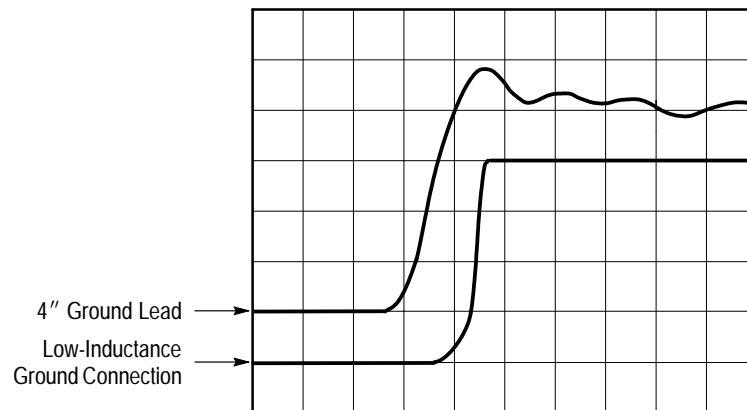

**Figure 3-50: Signal Variation Introduced by Probe Ground Lead (1 ns/division)**

Ringings and rise time degradation may be hidden if the frequency of the induced ringing is beyond the bandwidth of the logic scope. If you know the inductance ( $L$ ) and capacitance ( $C$ ) of your probe and ground leads, you can calculate the approximate resonant frequency ( $f_0$ ) at which that parasitic circuit will resonate:

$$f_0 = \frac{1}{2\pi \times \sqrt{LC}}$$

Reducing the ground lead inductance will raise the resonant frequency. Ideally, the inductance is low enough that the resulting frequency is above the frequency at which you want to take measurements. To minimize inductance, take your measurements directly with the probe tip on adjacent pins when possible.





# Saving and Recalling Setups

The TLS 216 Logic Scope can save and recall setups you might want to reuse later. For example, you might start with an initial setup to begin an experiment and, after making control changes as the experiment progresses, wish to return to it later. This article describes how to save and recall a setup.

## To Save a Setup

To save setups in either internal memory or on the file system floppy disk, do the following procedures.

### Store Internally

To save the current setup to any one of the 10 internal setup memories, do the following steps:

1. Press Save/Recall **SETUP** → **Save Current Setup** (main). (See Figure 3-51.)

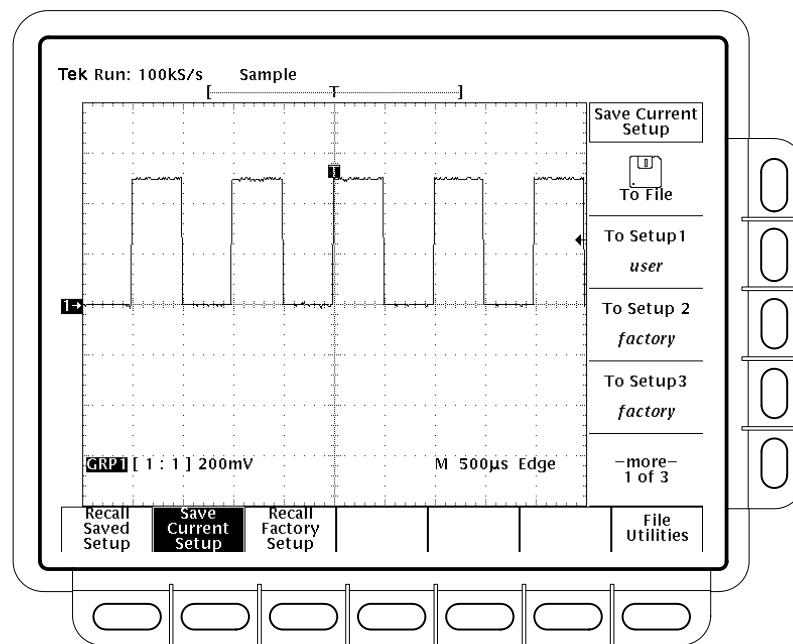

Figure 3-51: Save/Recall Setup Menu



---

**CAUTION.** Before doing step 2 that follows, note that if you choose a setup location labeled user, you will overwrite the user setup previously stored there. You can store setups in setup locations labeled factory without disturbing previously stored setups.

---

2. Press **To Setup 1, To Setup 2, ... To Setup 10, or To Setup 10** (side) to store the current selection in one of the ten internal storage locations available. (See Figure 3-51.) Press the button corresponding to your selection to store the current setup in that location.

### Store on Disk

To save the current setup to a file on the floppy disk, do the following steps:

1. Insert a formatted 720 Kbyte or 1.44 Mbyte floppy disk slot at the left of the logic scope display.

---

**NOTE.** To format disks, delete setup files you save to disk, and otherwise manage the disk storage, see *Managing the File System on page 3–61*. *Managing the File System* also describes how to create and change to different directories in which you might want to store setup files.

---

2. Press **Save/Recall SETUP → Save Current Setup** (main) → **To File** (side) to display the file list and its scrollable cursor.
3. Turn the general purpose knob to scroll the cursor over the file in which to store the setup.
4. Press **Save To Selected File** (side) to complete the operation.

To save to a unique, auto-numbered file, select the “wild card” file **TEK?????.SET** when doing step 3, above.

---

**NOTE.** Upon power on, the logic scope creates the special purpose file **TEK?????.SET** for storing setups. Selecting this file and pressing **Save To Selected File** stores the setup in a uniquely named file on the disk. For instance, the logic scope saves the first setup you save to the file **TEK00001.SET**, the second to **TEK00002.SET**, and so on.

---

To save a setup over an existing setup file, select the existing filename in step 3, above. The original contents of the existing file become lost.

You will not be able to overwrite the file if **Overwrite Lock** is turned on (error message will display). To turn overwrite lock off do the following steps:

1. Press **CLEAR MENU** if the overwrite lock message displayed. Press **File Utilities** in the **Save/Recall Setup** menu.

2. Press **Overwrite Lock** in the side menu to toggle it to **OFF**. (If Overwrite Lock does not appear in the side menu, press **–More–**.)
3. Press **Save Current Setup** (main) → **To File** (side) and select the name of an existing file.
4. Press **Save To Selected File** (side) to complete the operation.

See *Managing the File System* on page 3–61 for more information on file system operation.

## To Recall a Setup

To recall saved setups from either internal memories or on the file system floppy disk, do the following procedures.

### Recall Internal Setups

To recall a saved setup from any one of the 10 internal setup memories, press **SETUP → Recall Saved Setup** (main) → **Recall Setup 1, Recall Setup 2, ... Recall Setup 10** (side).

Recalling a setup will not change the menu that is currently displayed. If you recall a setup that is labeled *factory* in the side menu, you will recall the factory setup. (The conventional method for recalling the factory setup is described below.)

### Recall from Disk

To recall a stored setup from a file on the floppy disk, do the following steps:

1. Press **SETUP → Recall Saved Setup** (main) → **From File** (side).
2. Turn the general purpose knob to place the scroll bar over the file that contains the setup to be recalled. (Only files with .set extensions will be displayed).
3. Press **Recall From Selected File** (side) to complete the operation.

## To Recall the Factory Setup

To reset your logic scope to the factory defaults, press **SETUP → Recall Factory Setup** (main) → **OK Confirm Factory Init** (side).

See Appendix D, *Factory Initialization Settings*, for a list of the factory defaults.

## Deleting All Setups and Waveforms — Tek Secure®

You might use the logic scope to acquire waveforms that are confidential. If such is the case, you will want to remove all such waveforms and any setups used to acquire them before returning the logic scope to general use. To use Tek Secure to remove all reference setups and waveforms (does not affect floppy disk), do the following step:



---

**CAUTION.** Before doing the step that follows, be sure you want to remove all waveforms and setups because once they are removed you cannot retrieve them.

---

Press **SHIFT** → **UTILITY** → **System** (main) → **Config** (pop-up) → **Tek Secure Erase Memory** (main) → **OK Erase Ref & Panel Memory** (side).

Executing Tek Secure accomplishes the following tasks:

- Replaces all waveforms in reference memories with zero sample values.
- Replaces the current front panel setup and all setups stored in setup memory with the factory setup.
- Calculates the checksums of all waveform memory and setup memory locations to verify successful completion of setup and waveform erasure.
- Displays a warning message if the checksum calculation is unsuccessful; displays a confirmation message if the checksum calculation is successful.

## To Find More Information

See Appendix D, *Factory Initialization Settings*.

See *Example 4: Saving Setups*, on page 1–29.

See *Managing the File System*, on page 3–61.

# Saving and Recalling Waveforms

The TLS 216 Logic Scope can save and recall waveform groups into any of the four internal reference memories of the logic scope. (The logic scope retains the stored reference groups even if powered off or unplugged.) It can also save groups to and recall them from a 720 KByte or 1.44 MByte floppy disk inserted in the logic scope floppy drive. This article describes both storage in internal memory and to floppy disk.

## To Understand Reference Waveform Groups

To make best use of the save and recall waveform feature, first consider why you might use it. Then read about how the logic scope stores, recalls, and displays waveforms — using either internal or external (floppy disk) storage.

**Uses** Use Save/Recall waveform to save live waveform groups as reference waveform groups, so you can do following tasks.

- Clear live waveforms from the screen, creating display space for additional waveforms without losing the data from those waveforms.
- Save waveform data while the logic scope is powered off.
- Collect waveform data in a media (floppy disk) that, once stored, you can archive, transport, and otherwise use independent of the logic scope.

Each reference group you save to contains saved waveforms (when not empty) instead of live waveforms. This reference group of waveforms resembles a live waveform group except the waveforms are static (saved; not being newly acquired). Understanding how to define live waveform groups makes how to save those groups as reference groups easier to understand. See *Grouping Waveforms* on page 3–55 to learn about groups.

**Internal Storage** Internal storage operates as follows.

- The logic scope can store up to four reference groups of waveforms.
- The logic scope can store up to 16 waveforms internally. These waveforms can be allocated among the four reference groups in any combination. For example, the logic scope can store one group of 16 waveforms, or two groups with 5 and 11 waveforms each, and so on.
- The logic scope displays reference groups from reference memory using the MORE menu.

### External Storage

Floppy disk storage operates as follows:

- The logic scope can save a number of groups limited only by the number of floppy disks available. Each group can contain up to 16 waveforms.
- The logic scope does not display stored groups from the disk. It can, however, recall groups from disk to any of the four internal reference memories for display using the More menu.
- When recalling waveforms into reference memories, remember the logic scope can display 16 waveforms total in those four memories.

## To Save a Group

### Store Internally

To save a group to an internal reference memory, do the following steps.

1. Select the group that you want to save.



---

**CAUTION.** Before doing step 2 that follows, note that if you choose a reference memory location labeled **active** (see Figure 3-52), you will overwrite the waveform group previously stored there. You can store groups in reference locations labeled **empty** without disturbing previously stored waveforms.

---

2. Press Save/Recall **WAVEFORM** → **Save Group** (main) → **To Ref1, To Ref2, To Ref3, or To Ref4** (side).

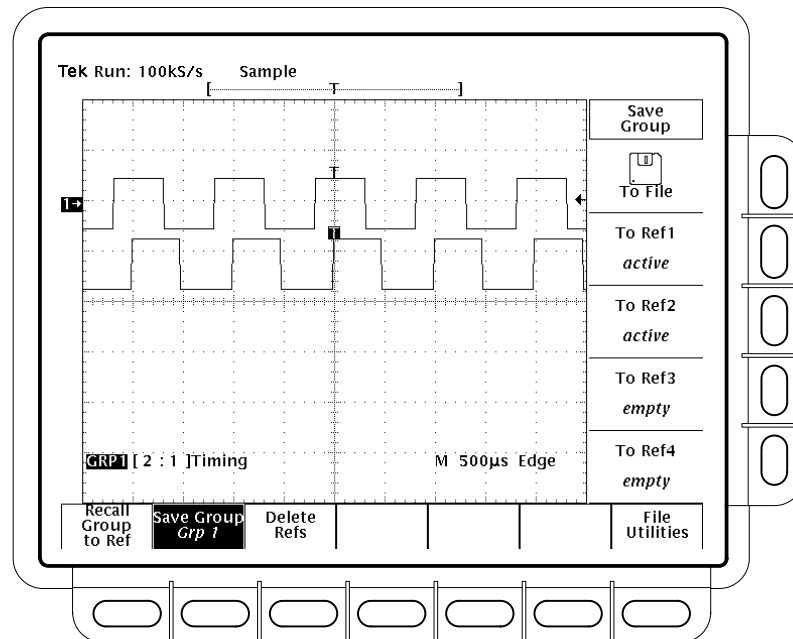

Figure 3-52: Save Group Menu

**Store on Disk** To save a group to the floppy disk, do the following steps:

1. Insert a formatted 720 Kbyte or 1.44 Mbyte floppy disk into the drive at the left front panel.

---

**NOTE.** To format disks, delete group files you save to disk, and otherwise manage the disk storage, see *Managing the File System* on page 3–61. It also describes how to create and change to different directories in which you might want to store group files.

---

2. Press Save/Recall **WAVEFORM** → **Save Group** (main) → **To File** (side).
3. Turn the general purpose knob to place the scroll bar over the file in which to store the group. (See Figure 3-53).



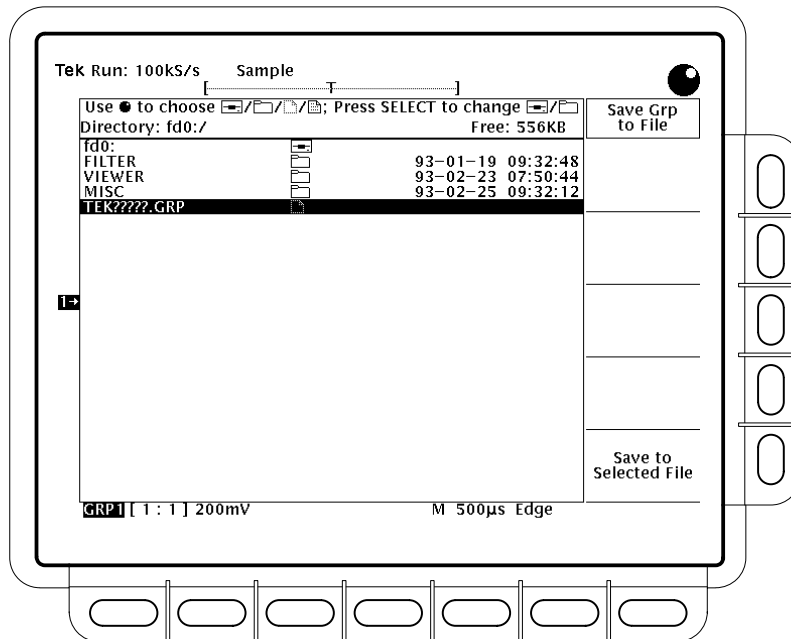

Figure 3-53: Save Group to File Menu

4. Press **Save To Selected File** (side) to complete the operation.

To save to a unique, auto-numbering file, select the “wild card” file *TEK?????.GRP* when doing step 3, above.

---

**NOTE.** Upon power on, the logic scope creates this special purpose file for storing groups. Selecting this file and pressing Save To Selected File stores the group in a uniquely named file on the disk. For instance, the logic scope saves the first group you save to the file *TEK00001.GRP*, the second to *TEK00002.GRP*, and so on.

---

To save a waveform group over an existing waveform file, select the existing filename in step 3, above. The original contents of the overwritten file become lost.

To save a group by overwriting an existing file, select the existing filename in step 3, above. The original contents of the existing file becomes lost.

You will not be able to overwrite the file if Overwrite Lock is turned on (error message will display). To turn overwrite lock off do the following steps:

1. Press **CLEAR MENU** if the overwrite lock message displayed. Press **File Utilities** in the Save/Recall Waveform menu.

2. Press **Overwrite Lock** in the side menu to toggle it to **OFF**. (If Overwrite Lock does not appear in the side menu, press **–More–**.)
3. Press **Save Group** (main) → **To File** (side) and select the name of an existing file.
4. Press **Save To Selected File** (side) to complete the operation.

See *Managing the File System* on page 3–61 for more information on file system operation.

## To Display a Stored Group

### Display From Ref1-Ref4

To display a waveform group stored in an internal reference memory, press **MORE** → **Reference Group** (main) → **Ref1, Ref2, Ref3, or Ref4** (side). See Figure 3-54.

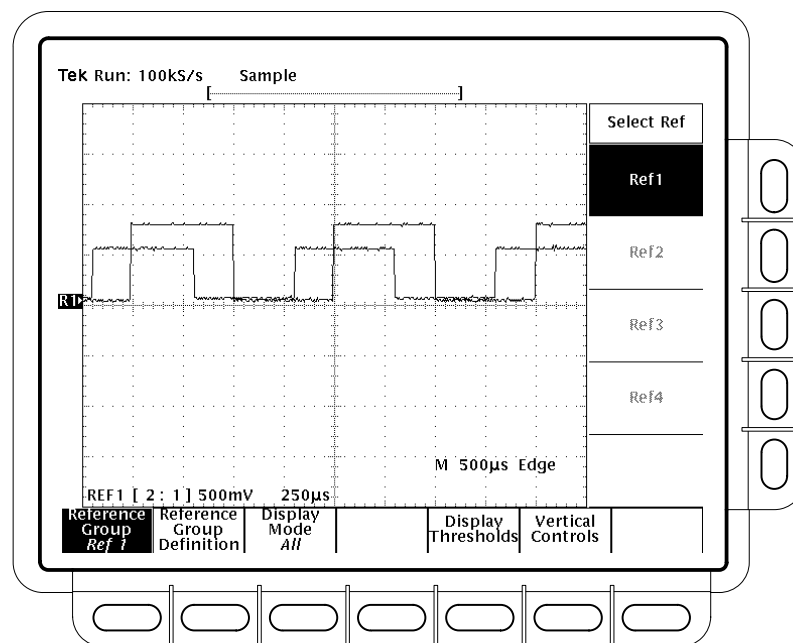

Figure 3-54: More Menu for Displaying Reference Groups

Note the following operating characteristics of a Reference waveform group:

- You can display any reference that is not empty. Names of empty references appear dimmed in the Select Ref menu. In Figure 3-54, the memory locations Ref2, Ref3, and Ref4 are empty. Ref1 is not empty.

- You can change the selected channel of any Ref group: press **Reference Group Definition** (main) → **Selected Channel** (side). Use the keypad to change the selected channel. First and last channel, though displayed in the menu, cannot be changed.
- You can change display mode of any Ref group: press **Display Mode** (main) → **OFF, Analog, BusForm, or Timing Diagram** (side).
- You can display all waveforms in an *Analog* Ref group or just the selected channel: press **Display Mode** (main) → **Analog** (side) to select Analog display mode. Press **Analog** (side) again to toggle it between **All** and **Selected**.
- You can also change reference group thresholds and group height in divisions if the group display mode is BusForm or Timing Diagram. See *To Define Group Thresholds and Height* on page 3–28 to set those parameters.

### Display From Floppy Disk

The logic scope does not display stored reference groups from the disk. Recall the reference group from disk to a reference memory as described below in *To Recall a Group from Disk*, and then display it from reference memory using the method just described.

## To Recall a Group from Disk

To recall a waveform group stored on disk to an internal reference memory, do the following steps.

1. Press Save/Recall **WAVEFORM** → **Recall Group To Ref** (main).
2. Use the general purpose knob to select the exact file from the resulting list. Only files with the extension .GRP are displayed.
3. Finally, press one of the selections **To Ref1, To Ref2, To Ref3, or To Ref4** (side) to complete the operation.

To display the group just recalled, display the appropriate reference memory as outlined above in *To Display a Stored Group*.

## To Delete Reference Groups

To delete reference groups you no longer need, press Save/Recall **WAVEFORM** → **Delete Refs** (main), and then press any of **Delete Ref1, Delete Ref2, Delete Ref3, Delete Ref4, or Delete All Refs** (side) to delete.

**Delete All Reference Waveforms and Setups** To delete all stored reference waveform groups and setups from internal memory (does not affect the floppy disk), use Tek Secure. See *Deleting All Setups and Waveforms* on page 3–108.

**Delete Groups from Disk** To delete waveform groups from the floppy disk, rename disk files, format disks, create directories, and otherwise manage the disk file system, see *Managing the File System* on page 3–61.

## To Find More Information

See *Managing the File System* on page 3–61.



# Selecting Groups and Channels

The TLS 216 Logic Scope applies the control changes you make, such as vertical bandwidth, offset, position, and scale, to the *selected group*. To make these changes to a group, or to define a group (choose the channels the group contains, its display mode, and so on), you must first select it.

The logic scope also applies a limited number of control changes based on the *selected channel* in the selected group. For example, Autoset, which automatically adjusts control settings based on the signals at its input channels, uses the selected channel to determine the logic scope control setup. Also Measure, the automatic measure feature, takes most automatic measurements on the selected channel.

This article describes how to select a group and a channel within a group. To read more articles that explain other key concepts about working with groups, see *To Find More Information* on page 3–120.

## To Check Which Group is Selected

To quickly determine which group is selected, always look at the *Vertical Readout*. It always displays the selected group, with its group label shown in reverse video. See Figure 3-55.

---

**NOTE.** *The vertical readout varies its display according several rules. Read the description To Check Group Settings on page 3–56 to become familiar with this readout.*

---

## To Select a Group

Use the group selection buttons, to the right of the display, to select from groups 1 through 8 and to display the Group More menu. (Pressing MORE displays a menu for selecting internally stored Ref waveform groups for display and manipulation.) Do the following procedures to select a live or reference group.

### Selecting Acquisition Groups

To select a live waveform group (one that can acquire waveforms as opposed to a reference waveform group that can only store and display them) do the following steps.

1. Press any of group selection buttons **GROUP 1** through **GROUP 4** on the right side of the display to select any one of groups 1 – 4.

2. Press **SHIFT** and repeat step 1 to select any one of groups 5 - 8. Note that the labels GROUP 5 through GROUP 8 are shifted functions of the GROUP 1 through GROUP 4 buttons.

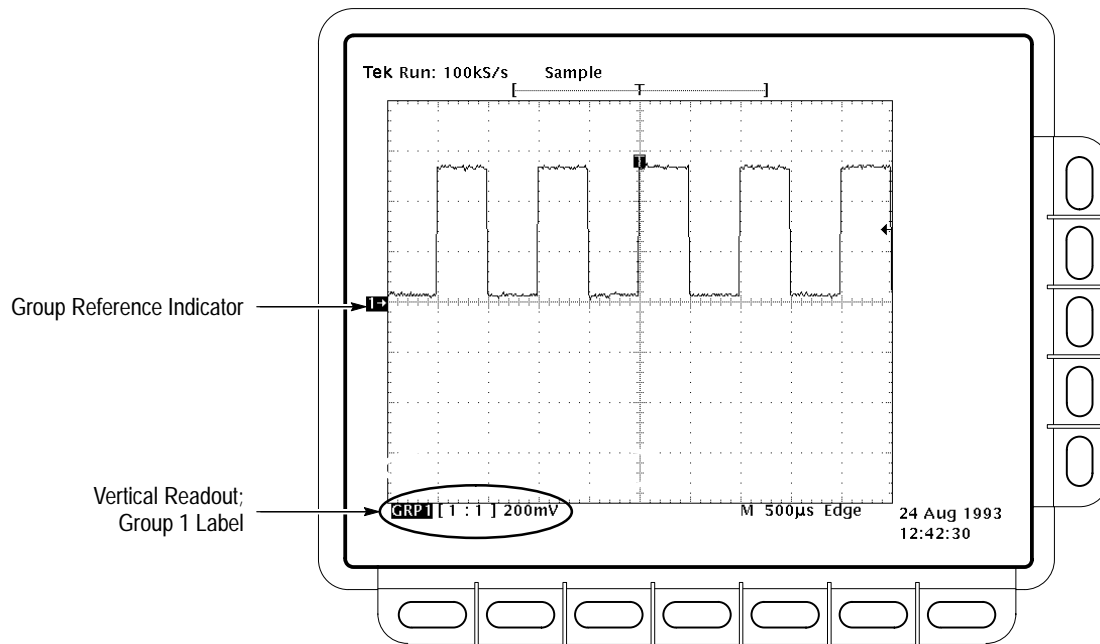

**Figure 3-55: The Vertical Readout**

When selecting groups, note the following operating characteristics:

- The logic scope highlights the selected group. It also displays its group reference indicator (left of the graticule) and its group readout label in reverse video. (See Figure 3-55.)
- The logic scope creates the group automatically if you select a group not yet defined. It creates it using the first channel not allocated to another group. It displays it using Analog display mode.
- The logic scope displays all groups except those undefined (deleted) or those which have their display mode set to Off. (See page 3-119 to learn how to remove and return a group from the display.)
- The logic scope ignores attempts to select undefined groups when the defined groups have used up all 16 channels.
- The logic scope lights the LED above the button you press. The LED lights regardless of whether you select a shifted group (1-4) or one that is not shifted (5-8). (See steps 1 and 2, above.) Therefore, if you are not sure

which group is selected, look at the group readout. It always indicates the selected group.

- The logic scope does not depend on the selected group to determine its trigger source. You define the trigger source independently in the Main Trigger menu or Delayed Trigger menu.

### Selecting Reference Groups

To select a reference waveform group (as opposed to a live waveform group), do the following steps.

1. Press the **MORE** group selection button. The More Group menu will appear.
2. Press **Reference Group** (main). Select from **Ref1** through **Ref4** (side).

---

***NOTE.** If references are empty (appear shaded in the Select Ref menu), you cannot display them. The article Saving and Recalling Waveforms, which begins on page 3–109, describes saving and recalling waveforms. In particular, To Display a Stored Group, on page 3–113, covers using reference groups.*

*If a reference group is turned off its Display Mode menu, selecting it switches its display mode to Analog, so it is automatically displayed.*

---

## To Select a Channel

To designate one channel as the selected channel within the selected group, perform the following steps.

1. Select a live or reference group as previously described.
2. Press **Group Definition (main) → Selected Channel** (side). Use the general purpose knob or key pad to designate the selected channel in the group.

## To Remove a Group from the Display

To remove a group from display, do the following steps.

1. Press the group selection button (**GROUP1** through **GROUP8**) to select the group you want to remove from the display.
2. Press the **GROUP OFF** button to remove the currently selected group.

To display a group that is turned off, turn it on in the group mode menu:

Press **GROUP MENU → Group Definition** (main) → **Analog, Bus, or Timing Diagram** (side).



---

**NOTE.** Turning a group off does not make its channels available for including in other groups. Turning off a group that includes a channel providing a trigger source does not turn that channel off as a trigger source. Turning off a group does remove any automated measurements of channels in that group.

---

When you turn off the selected waveform group using the GROUP OFF button, the logic scope automatically selects the nearest higher priority waveform group. For instance, turning of Group 6 selects Group 5, and so on. Table 3–5 lists in order how the logic scope prioritizes waveforms. (Turning the selected group off using the Group Display Mode menu does *not* cause a new group to be selected, rather the logic scope leaves the group you turned off selected.)

There are two orders of priority shown in Table 3–5. The one the logic scope uses depends on the type of group you turn off first. If you turn off a live group, pressing GROUP OFF again turns off the *live* group with the next highest priority as listed in Table 3–5. You can continue this process until all live groups are off.

Turning off a reference group first reverses this process. If you start by turning off a REF group, all the REF groups will be turned off before going to the live groups.

**Table 3–5: Group Selection Priority**

Priority Assigned	Live Groups	Reference Groups
1 (highest)	GROUP 1	REF 1
2	GROUP 2	REF 2
3	GROUP 3	REF 3
4	GROUP 4	REF 4
5	GROUP 5	
6	GROUP 6	
7	GROUP 7	
8	GROUP 8	

## To Find More Information

See *Adjusting the Vertical Setup*, on page 3–7.

See *Choosing a Group Display Mode*, on page 3–23.

See *Grouping Waveforms*, on page 3–55.

See *Saving and Recalling Waveforms*, on page 3–109.

# Triggering After Delay

The TLS 216 Logic Scope provides a main time base and a delayed time base. Both main and delay time bases have full-featured trigger systems that provide edge, pulse, pattern, state, and sequence triggers. This article describes how to set the logic scope to acquire after a delay expires. This delay, measured from the main trigger event, can be set in time, events, or both.

## To Understand Delayed Acquisitions

To learn how to take delayed acquisitions, read the following topics.

### Delay Modes

There are two different ways to delay the acquisition of waveforms: *delayed runs after main* and *delayed triggerable*. Only delayed triggerable mode uses the delayed trigger system.

*Delayed runs after main* looks for a main trigger, then waits a user-specified time, and then begins acquiring. (See Figure 3-56.)

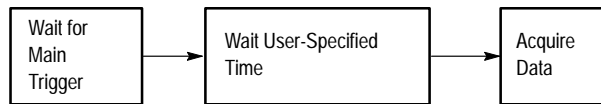

**Figure 3-56: Delayed Runs After Main**

*Delayed triggerable* looks for a main trigger and then, depending on the type of delayed trigger selected, makes one of the three types of triggered delayed acquisitions listed below. (See Figure 3-57.)

*Triggerable After Time* waits the user-specified time, then waits for the next delayed trigger event, and then acquires.

*Triggerable After Events* waits for the specified number of delayed trigger events and then acquires.

*Triggerable After Events/Time* waits for the specified number of delayed trigger events, then waits the user-specified time, and then acquires.

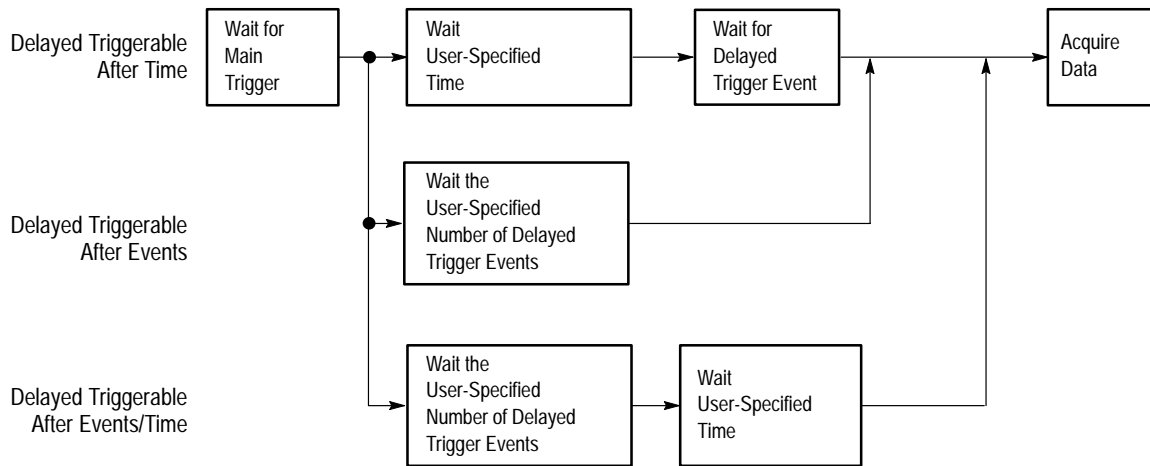

Figure 3-57: Delayed Triggerable

The logic scope is always acquiring samples to fill the pretrigger part of the waveform record. When and if delay criteria are met, it takes enough posttrigger samples to complete the delayed waveform record and then displays it. Refer to Figure 3-58 for a more detailed look at how delayed records are placed in time relative to the main trigger.

### Triggering Events

You must define a main trigger event to use delayed runs after main mode and define both a main and a delayed trigger event to use delayed triggerable mode. You define these events by setting one or both trigger systems to trigger using one of the five trigger types: edge, pulse, pattern, state, or sequence. That way, you can specify the trigger type(s) that is best suited for capturing the event to be delayed from or delayed to. Read the articles listed on page 3–126 to learn how to set up the main and delayed trigger systems for the five trigger types just referenced.

### Trigger Sources and Thresholds

You set both the main and delayed trigger sources and threshold when using delayed triggerable mode. Consider the following operating characteristics when setting these parameters.

- The logic scope sets trigger thresholds for each trigger source (Ch1, Ch2, and so on) for *both* trigger systems. For example, adjusting the Ch1 trigger threshold to 1 volt using the main trigger system controls and menus also sets the Ch1 threshold to 1 volt for the delayed trigger system. To trigger the main and delayed trigger systems at different thresholds, you must select a different source for each system.

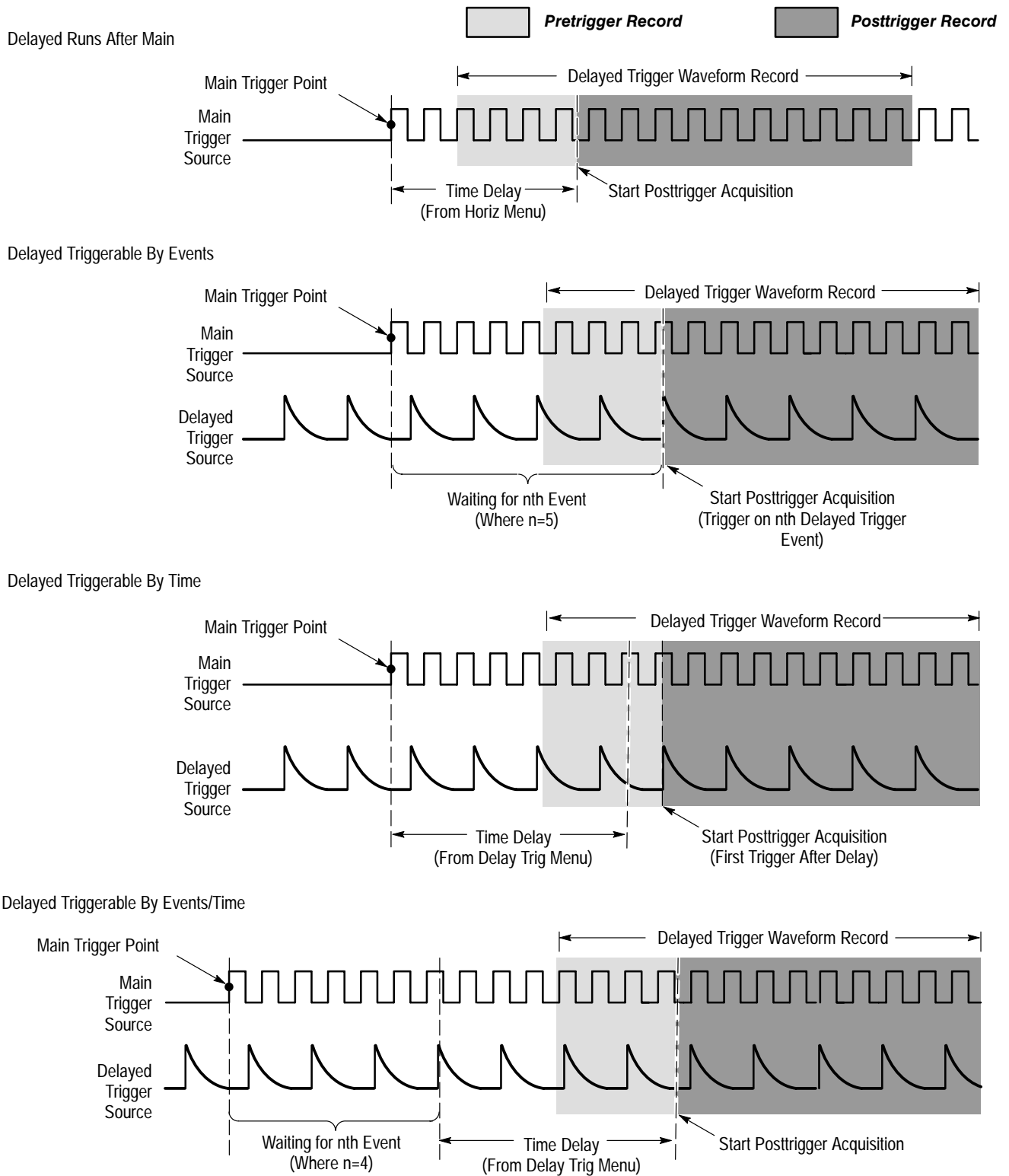

Figure 3-58: How the Delayed Triggers Work

- The logic scope only shares the trigger *thresholds* between the common sources available in the two trigger systems. You can, for example, set different slopes of edge trigger, different classes and polarities of pulse triggers, and different pattern definitions for pattern, state, and sequence triggers between the main and delayed trigger systems.

There may be times when you want to trigger on different thresholds for the same signal. For example, you may wish to delay from a positive-going pulse and trigger on the first negative-going glitch after delay expires. To do so, couple the signal to two channels (circuit loading will increase) and select one channel as the main trigger source and the other as the delayed trigger source. You can then set the trigger levels independently. (Use the one-to-two adapter standard accessory to attach the two probes. See page 3–100 for instructions.)

## To Acquire After Delay

To begin acquiring immediately after a time you set (from the main trigger event) expires, do the following steps.

1. Press **TRIGGER MENU** and use the main trigger menu to set up the main trigger system to trigger on the event from which you want to delay.

See *To Find More Information* on page 3–126 for a list of articles that describe how to set up the main trigger system for the various trigger types available.

2. Press **HORIZONTAL MENU** → **Time Base** (main) → **Delayed Only** (side) → **Delayed Runs After Main** (side).
3. Turn the general purpose knob or use the keypad to set the delay time.

---

**NOTE.** *If you press Intensified in the side menu, the logic scope displays an intensified zone on the main time base record. For Delayed Runs After Main mode, the start of the intensified zone corresponds to the start of the delayed time base record. The end of the zone corresponds to the end of the delayed record. Therefore, for Delays Runs After Main mode only, this zone shows where the delayed time base record occurs relative to the main trigger.*

---

## To Trigger After Delay

To acquire on the first delayed trigger event that occurs after a time you set expires, do the following steps.

1. Press **TRIGGER MENU** and use the main trigger menu to set up the main trigger system to trigger on the event from which you want to delay.

See *To Find More Information* on page 3–126 for a list of articles that describe how to set up the main trigger system for the various trigger types available.

2. Press **HORIZONTAL MENU** → **Time Base (main)** → **Delayed Only (side)** → **Delayed Triggerable (side)**.

**NOTE.** If you press *Intensified* in the side menu, the logic scope displays an intensified zone that shows where the delayed time base record might occur (the logic scope must receive a valid delay trigger event) relative to the main trigger on the main time base. For *Delayed Triggerable After Main* mode, the start of the intensified zone corresponds to the possible start point of the delayed time base record. The end of the zone continues to the end of main time base, since a delayed time base record may be triggered at any point after the delay time elapses.

3. Press **SHIFT** → **DELAYED TRIG** → **Delay by (main)** → **Triggerable After Time, Events, or Events/Time (side)**. (See Figure 3-59.)

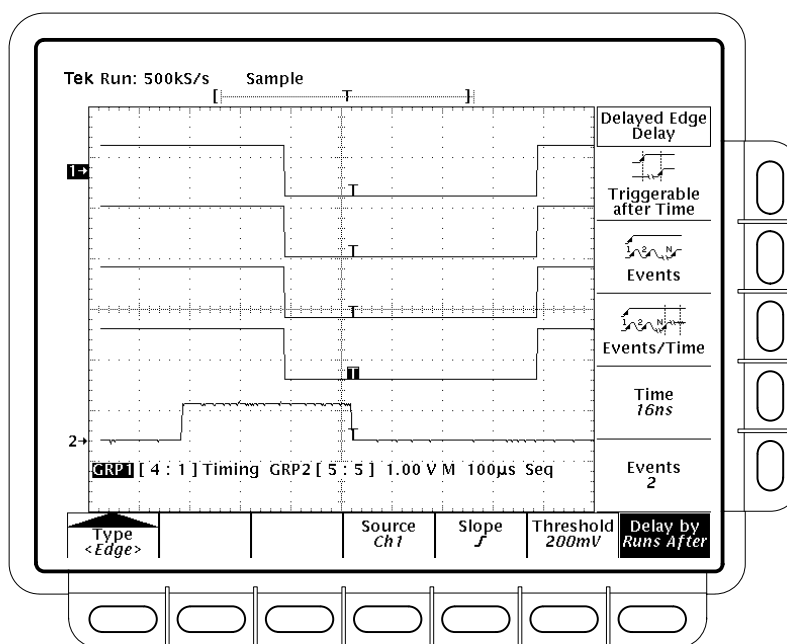

Figure 3-59: Delayed Trigger Menu

4. Enter the delay time or events using the general purpose knob or the keypad. If you selected **Events/Time**, press **Time** (side) and **Events** (side) to switch between setting the time and the number of events.
5. Use the Delayed Trigger menu to select a trigger type, threshold, and otherwise set up to trigger on the event you choose.

See *To Find More Information* below for a list of articles that describe how to set up the delayed (and main) trigger system for the various trigger types available. See *Trigger Sources and Thresholds* on page 3–122 for special considerations when sharing trigger sources between trigger systems.

---

**NOTE.** *When using Delayed Triggerable mode with edge or pulse trigger types to acquire waveforms, two trigger bars are displayed. One trigger bar indicates the threshold level set by the main trigger system; the other indicates the threshold level set by the delayed trigger system.*

---

## To Find More Information

See *Triggering*, on page 2–13.

See *Triggering on Edges*, on page 3–127.

See *Triggering on Patterns*, on page 3–131.

See *Triggering on Pulses*, on page 3–141.

See *Triggering on a Sequence*, on page 3–147.

See *Triggering on Signals*, on page 3–159.

See *Triggering on States*, on page 3–165.

# Triggering on Edges

The TLS 216 Logic Scope can trigger on the rising or falling edge of a waveform. The logic scope monitors the amplitude level of the trigger source you specify, and when the level passes through the threshold level you set, it triggers.

This article describes how to set the edge source, slope, threshold level, and mode (auto or normal) in the main trigger system. Setting up for edge triggering using the delayed trigger system is identical except where noted. Refer to *Triggering After Delay*, on page 3–121, to learn about using the delayed trigger system.

## To Understand Edge Triggering

To understand edge triggering, consider the process used by the logic scope to trigger on a waveform edge (edges are rising or falling transitions):

1. After hold off ends, the logic scope continuously monitors the instantaneous amplitude of the input you select as a trigger source: Ch 1 through Ch 16, the Auxiliary Trigger input, or the AC Line frequency.
2. The logic scope compares this amplitude with the threshold level you set for triggering.
3. If the trigger source amplitude transitions through the threshold level *and* the transition is in the direction you specify for edge slope (rising or falling edge), the logic scope triggers at the point it crosses the threshold.

Since edge type triggers on waveform transitions, you can trigger on almost any type of signal. Use edge triggering as your general-purpose trigger.

## To Check Trigger Status

To tell if the currently selected trigger type is edge, check the trigger readout displayed in the lower right corner of the display.

To quickly check the threshold level relative to the waveform display, check the trigger bar indicator at the right edge of the display.

To quickly check the currently defined source, slope, and threshold level, push **TRIGGER MENU** → **Edge** (pop-up). (See Figure 3-61 on page 3–129.)

To determine the overall setup for the edge trigger, press **SHIFT** → **STATUS** → **Trigger** (main). Select from the **Thresholds**, **Main**, and **Delay** (side) status selections. (See Figure 3-60.)



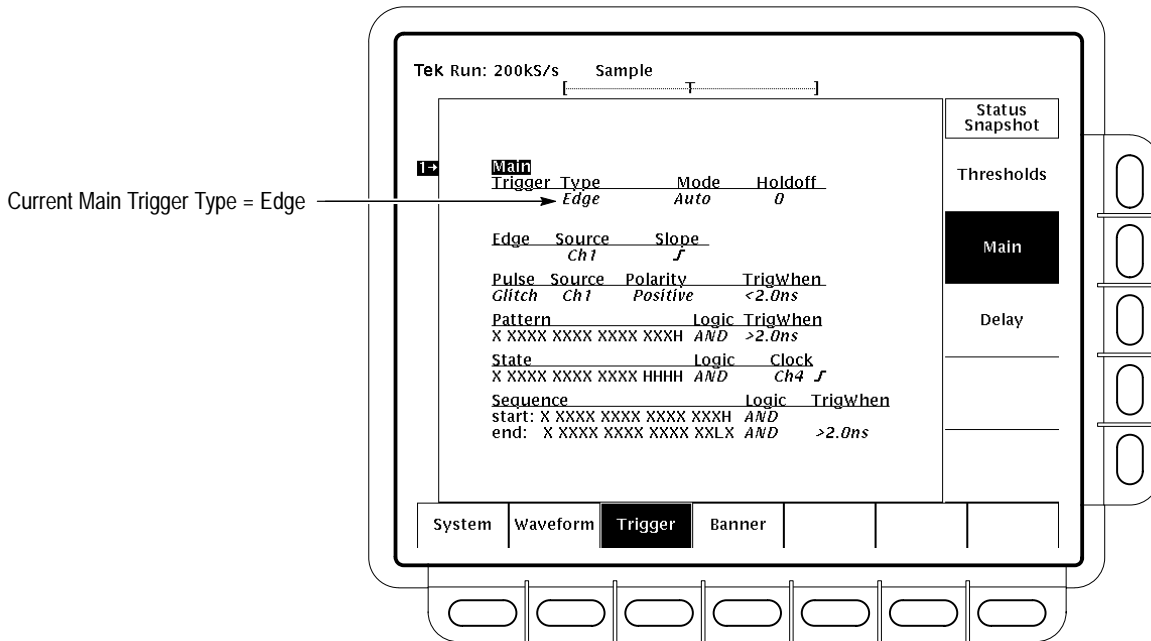

Figure 3-60: Snapshot of Trigger Status

## To Trigger on an Edge of a Signal

To trigger on the edge of an input signal, you must set the source, slope, trigger threshold level, mode, and holdoff to trigger that signal.

### Select Edge Triggers

To bring up the Edge Trigger menu, press **TRIGGER MENU** → **Type** (main) → **Edge** (pop-up). (See Figure 3-61.)

### Select the Source

To select which source you want for the trigger, press **TRIGGER MENU** → **Type** (main) → **Edge** (pop-up) → **Source** (main) → **Channel**, **AC Line**, or **Auxiliary** (side). If specifying a channel as the trigger source, use the general purpose knob or keypad to select from channel 1 through 16.

### Select the Slope

To select the slope that the edge trigger will occur on, do the following steps.

1. Press the **TRIGGER MENU** → **Type** (main) → **Edge** (pop-up) → **Slope** (main) to select the slope that the edge trigger will have.



2. Select the rising or falling edge from the side menu.

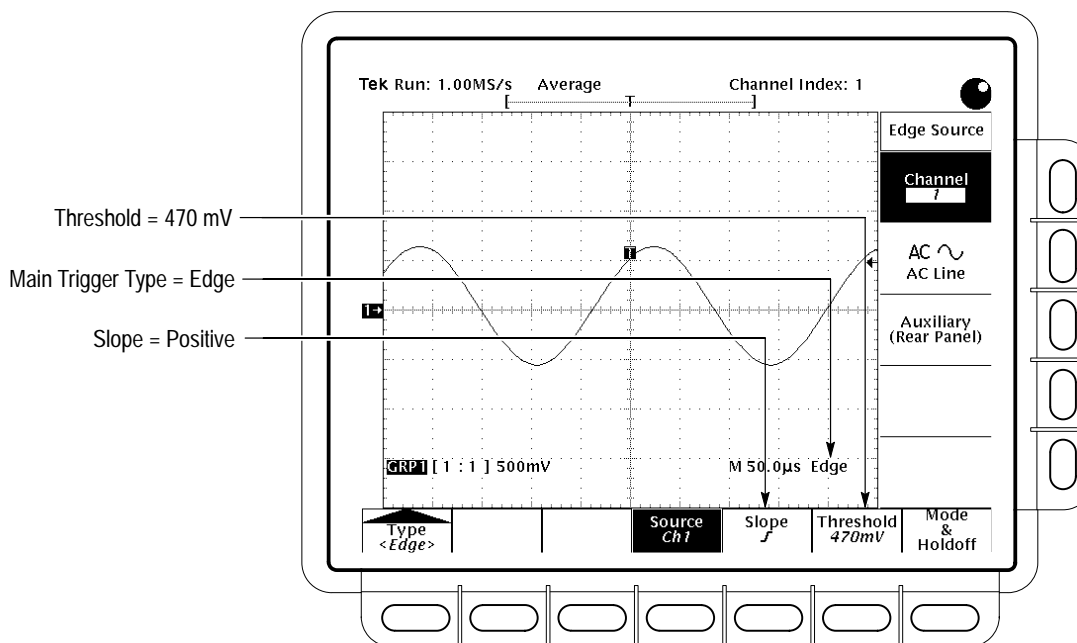

Figure 3-61: Main Trigger Menu — Edge Type

### Set the Trigger Threshold

To quickly set the edge-trigger threshold level, press the **SET LEVEL TO 50%** button.

To quickly set the edge-trigger threshold to a level on the waveform, use the **THRESHOLD** knob while watching the trigger bar at the right side of the display. (You can turn the trigger bar on or off from the Display Settings menu.)

To set a trigger threshold and quickly copy it to a group of input channels or to all input channels, refer to the general procedure *To Set Trigger Thresholds* on page 3–162.

---

**NOTE.** See Trigger Sources and Thresholds on page 3–122 for special considerations when setting trigger thresholds for the delayed trigger system.

---

### Set Mode & Holdoff

To change the holdoff time and select the trigger mode (main trigger system only), do the following steps.

1. Press **TRIGGER MENU** → **Mode & Holdoff** (main) → **Auto** or **Normal** (side).

- In Auto mode the logic scope acquires a waveform after a specific time has elapsed even if a trigger does not occur. The amount of time that the logic scope waits depends on the time base setting.
  - In Normal mode the logic scope acquires a waveform only if there is a valid trigger.
2. To change the holdoff time, press **Holdoff** (side). Enter the value (in percent) using the general purpose knob or the keypad.

To make large changes to the holdoff setting using the general purpose knob, press the **SHIFT** button before turning the knob. The indicator *Coarse Knobs* appears in the upper right corner to indicate that the general purpose knob will make larger changes to settings when turned.

You can set holdoff from 0% (minimum holdoff available) to 100% (maximum available). See *Holdoff, Variable, Main Trigger* in the *Performance Verification and Specification* manual shipped with your logic scope for the typical minimum and maximum values.

The logic scope automatically resets holdoff to 0% when you change the time/division setting of the main time base. However, it does not reset holdoff if you change the delayed time base time/division (that is, when the time base setting in the Horizontal menu is Intensified or Delayed Only).

## To Find More Information

See *Triggering*, on page 2–13.

See *Triggering on Signals*, on page 3–159.

# Triggering on Patterns

The TLS 216 Logic Scope can trigger on logic or binary patterns. It compares the trigger source inputs with the logic pattern you define and triggers when the comparison meets conditions that you specify.

This article describes how to define and time-qualify a pattern trigger. Setting up for pattern triggering using the delayed trigger system is identical except where noted. Refer to *Triggering After Delay* on page 3–121 to learn about using the delayed trigger system.

## To Understand Pattern Triggers





To effectively use the pattern trigger, consider the process used by the logic scope to trigger on a pattern and how time qualification affects the actual point at which triggering occurs.

### The Pattern Triggering Process

The logic scope executes the following steps when pattern triggering.





1. After holdoff ends, the logic scope monitors its inputs: Ch 1 through Ch 16 and Aux(iliary) Trigger, input from the rear panel.
2. As it monitors, it compares (ANDs, NANDs, ORs, or NORs, as you specify) its inputs with the pattern of logic levels, HIGH (H), LOW (L), or Don't Care (X), that you define. (It ignores inputs set to Don't Care.)
3. If the comparison indicates the input pattern is TRUE (meets the Boolean requirement for the logic selected), the logic scope immediately starts a timer. Table 3–6 lists the four logic functions and their corresponding Boolean requirements that can start the timer.

**Table 3–6: Logic Qualifiers**

Logic	Boolean Requirement for a TRUE Input Pattern
AND 	All the inputs must match their logic level as they appear in the pattern definition — HIGH (H), LOW (L), or Don't Care (X).
NAND 	At least one of the inputs must cease to match its logic level as it appears in the pattern definition.
OR 	At least one of the inputs must match its logic levels as it appears in the pattern definition.
NOR 	All the inputs must cease to match their logic levels as they appear in the pattern definition.

4. The logic scope keeps time to make sure the pattern remains TRUE for a time you specify.
5. When the pattern satisfies the time qualification, the logic scope triggers. Table 3–7 lists each time qualifier versus the trigger event it qualifies.

**Table 3–7: Time Qualifiers**

Trig When	Time Qualifiers versus Trigger Event
< Time 	The inputs must be TRUE <sup>1,2</sup> for a period that ends <i>before</i> a user-specified time expires. The logic scope triggers <i>at the point that the inputs go FALSE</i> .
> Time 	The inputs must be TRUE for a period that ends <i>after</i> a user-specified time expires. The logic scope triggers <i>at the point that inputs go FALSE</i> .
Time Out 	The inputs must stay TRUE for a period that continues <i>after</i> a user-specified time expires. The logic scope triggers <i>at the point that time expires</i> .
In Range 	The inputs must stay TRUE for a period that ends <i>after</i> a user-specified minimum time but <i>before</i> a user-specified maximum time expires. The logic scope triggers <i>at the point that the inputs go FALSE</i> .
Out of Range 	The inputs must stay TRUE for a period that ends <i>before</i> a user-specified minimum time or <i>after</i> a user-specified maximum time expires. The logic scope triggers <i>at the point that the inputs go FALSE</i> .

<sup>1</sup> Inputs are TRUE when they meet the Boolean requirement for the logic function selected; otherwise they are FALSE. See Table 3–6.

<sup>2</sup> The logic scope starts timing the period at the point when the inputs become TRUE. (See footnote 1.)

### How Time Qualification Affects the Trigger Point

As Table 3–7 indicates, the time qualifier you choose determines the trigger point. Depending on the time qualifier you choose, you can:

- trigger as soon as possible after the logic scope recognizes your pattern.
- trigger after the logic scope recognizes your pattern for a time you specify.

The two ways of triggering just listed reflect the following key concepts governing pattern triggering with the logic scope.

- The trigger event does not occur when the inputs first meet Boolean requirements (input pattern compares TRUE). Rather, the logic scope starts a timer it uses to determine if the pattern satisfies the time qualification set.

- With all time qualifiers except the Time Out qualifier, the logic scope *waits until the input pattern compares FALSE before triggering*.
- If, at the time the input pattern compares FALSE, time requirements are satisfied, the logic scope triggers.
- The Time Out qualifier is the exception — it triggers the instant that the time the pattern is TRUE exceeds the time limit specified.

Read the procedures listed below to learn more about how your choices for time qualification affect the point at which triggering occurs.

*To Trigger on a Pattern*, which begins on page 3–134, lists the basic steps needed to set up the logic scope to pattern trigger.

*To Trigger Immediately on a Pattern*, which begins on page 3–137, demonstrates how to use the time-limit qualifier Time Out to provide triggering on a TRUE pattern. Figure 3-64 on page 3–137 locates the trigger point for this type of time-qualified pattern trigger.

*To Trigger on a Time-Limit Qualified Pattern*, which begins on page 3–138, demonstrates how to use the time qualifiers > Time and < Time. Figure 3-65 on page 3–138 locates the trigger point for an example of these types of pattern triggers.

*To Trigger on a Range Qualified Pattern*, which begins on page 3–139, demonstrates how to use the time qualifiers In Range and Out of Range.

## To Check Trigger Status

To tell if the currently selected trigger type is *Pattern*, check the trigger readout displayed in the lower right corner of the display.

To quickly check the currently defined pattern, press **TRIGGER MENU** → **Pattern** (pop-up) → **Define Pattern** (main) to pop up a display of the currently defined pattern. (See Figure 3-63 on page 3–135.)

To determine the overall setup for the pattern trigger, press **SHIFT** → **STATUS** → **Trigger** (main). Choose from **Thresholds**, **Main**, and **Delay** in the side menu. (See Figure 3-62.)

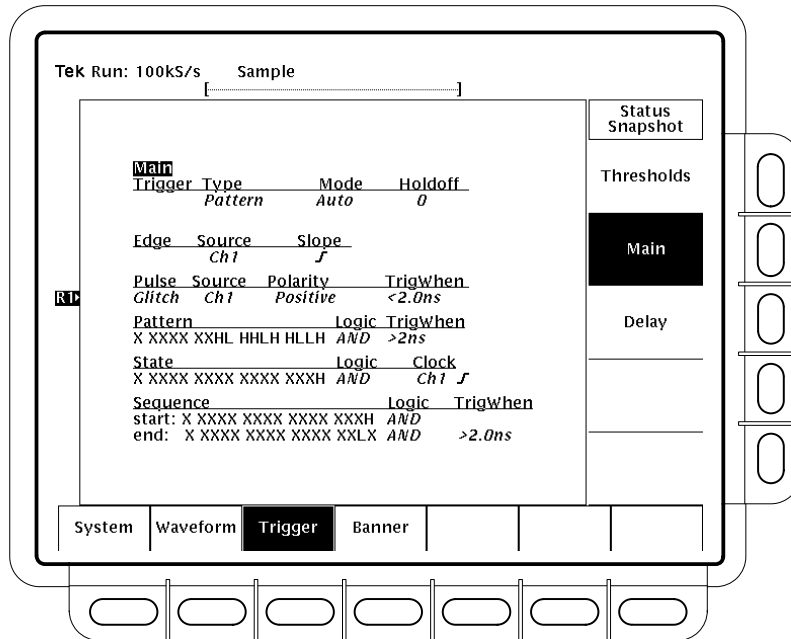

Figure 3-62: Snapshot of Trigger Status

## To Trigger on a Pattern

If you want to trigger on a pattern that goes TRUE (as defined by the logic selected), you must do the following tasks.

*Define the Pattern* by specifying the logic levels against which the inputs are compared. Each “bit” in the pattern is a logic HIGH (H), LOW (L), or Don’t Care (X) that corresponds to one logic scope input. (The inputs are channels 1 through 16 and the Auxiliary trigger.)

*Define the Boolean Requirement* by specifying that the comparison logic be AND, NAND, OR, or NOR. (See Table 3–6 on page 3–131 for the Boolean requirement associated with each logic function.)

*Time Qualify the Pattern Trigger* by specifying the time or range of time that the inputs must meet the Boolean requirement.

### Select Pattern Triggering

To begin specifying your pattern trigger, press **TRIGGER MENU** → **Type** (main) → **Pattern** (pop-up). (See Figure 3-63.)

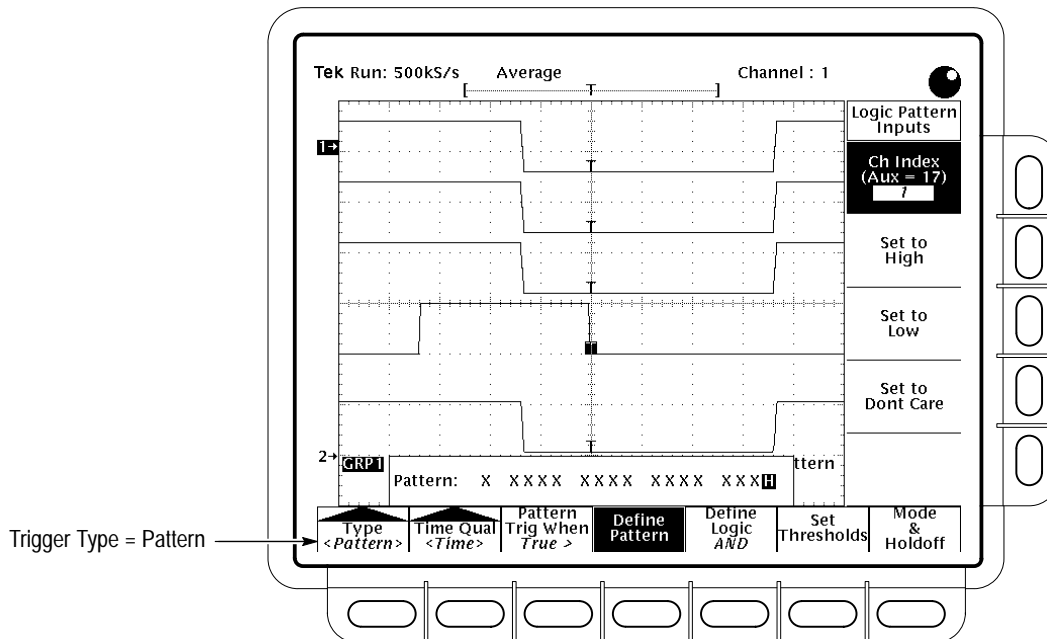

Figure 3-63: Pattern Trigger Menu

**Define the Pattern**

To select the logic level required for each input of the pattern, do the following steps.

1. Press **TRIGGER MENU** → **Type** (main) → **Pattern** (pop-up) → **Define Pattern** (main).
2. Press **Ch Index** (side). Use the general purpose knob or keypad (or repeatedly press **Ch Index**) to enter the channel you want to set. The number for the channel selected appears in the Ch Index item in the side menu.
3. Use the side buttons to set the logic level expected for the channel just selected. Choose from **Set to High**, **Set to Low**, and **Set to Don't Care**. Note that setting the logic level of a channel decrements the channel index to automatically select the next channel.
4. Repeat step 3 to set all inputs to the levels you require. You can skip over channels already properly defined (or return to a channel to redefine it) using the general purpose knob, key pad, or the Ch Index button.

**NOTE.** The logic scope will not trigger if all pattern inputs are set to Don't Care. The logic scope only recognizes patterns that have at least one input set to HIGH or LOW.



**Define the Pattern Logic** To define the Boolean requirement for a TRUE pattern, select the logic function (AND, NAND, OR, or NOR). Press **TRIGGER MENU** → **Type** (main) → **Pattern** (pop-up) → **Define Logic** (main) → **AND, OR, NAND, or NOR** (side).

**Set Mode & Holdoff** To change the holdoff time and select the trigger mode, do the following steps.

1. Press **TRIGGER MENU** → **Mode & Holdoff** (main) → **Auto** or **Normal** (side).

In Auto mode, the logic scope triggers an acquisition after a specific time has elapsed even if a trigger event does not occur. The amount of time the logic scope waits depends on the time base setting.

In Normal mode, the logic scope acquires only if there is a valid trigger.

2. Press **Holdoff** (side). Enter the value (in percent) using the general purpose knob or the keypad.

**Set the Trigger Thresholds** You can set the trigger threshold of each input individually (to the same or different levels). Also, you can set the trigger threshold of one input and copy it to a group of inputs or to all inputs with one operation. To set the thresholds, refer the general procedure *To Set Trigger Thresholds* on page 3–162.

---

**NOTE.** See *Trigger Sources and Thresholds* on page 3–122 for special considerations when setting trigger thresholds for the delayed trigger system.

---

**Qualify the Trigger** To control how long the pattern must be TRUE before a trigger occurs, you must time qualify it. To do so, perform one of the following procedures.

- To trigger immediately (within the minimum settling time settable by the logic scope) when a pattern becomes TRUE, perform *To Trigger Immediately on a Pattern*, below.
- To trigger when a pattern becomes TRUE and then stays TRUE for a period less than or greater than a time *limit* that you specify, perform *To Trigger on a Time-Limit Qualified Pattern* on page 3–138.
- To trigger when a pattern becomes TRUE and then stays TRUE for a period that falls inside or outside a time *range* (window) that you specify, perform *To Trigger on a Time-Range Qualified Pattern* on page 3–139.

## To Trigger Immediately on a Pattern

If you want to trigger as soon as possible after a pattern goes TRUE (as defined by the logic selected), you must set the minimum time qualification possible by doing the following steps.

1. Define the pattern, Boolean requirements, thresholds, mode and holdoff using the methods outlined in *To Trigger on a Pattern* on page 3–134.
2. Press **TRIGGER MENU** → **Type** (main) → **Pattern** (pop-up) → **Time Qual** (main) → **Limit** (pop-up).
3. Press **Pattern Trig When** (main) → **Time Out** (side). Press **Time** (side). Use the general purpose knob or the keypad to set the time limit to *its minimum value*.

---

**NOTE.** The minimum time qualification of 2 ns is a value the logic scope can typically achieve. For warranted values, consult the *TLS 216 Performance Verification and Specifications manual* shipped with the logic scope.

---

Triggering will occur when the inputs compare TRUE and the minimum time limit expires. Figure 3-64 shows a pattern comprising four inputs that is time qualified to trigger as soon as possible after the pattern is recognized. (Compare with Figure 3-65 on page 3–138 which shows >Time time qualification.)

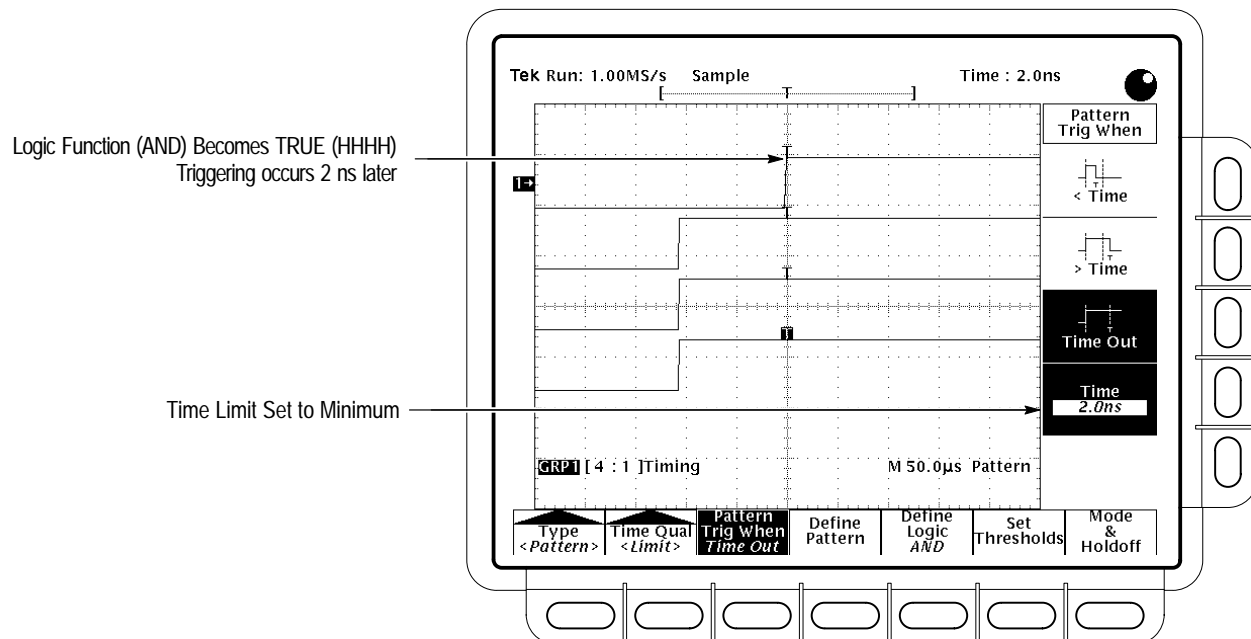

Figure 3-64: Triggering on a Pattern: *Time Out* Qualified

## To Trigger on a Time-Limit Qualified Pattern

To trigger on a pattern that becomes TRUE (as defined by the logic selected) and stays TRUE for a time that ends before or extends beyond a time limit you specify, do the following steps.

1. Define the pattern, Boolean requirements, thresholds, mode, and holdoff using the methods outlined in *To Trigger on a Pattern* on page 3–134.
2. Press **TRIGGER MENU** → **Type** (main) → **Pattern** (pop-up) → **Time Qual** (main) → **Limit** (pop-up).
3. Press **Pattern Trig When** (main) → **Time** (side).
4. Use the general purpose knob or the keypad to set the time limit *from when the pattern becomes TRUE* in the side menu.
5. Press **< Time**, **> Time**, or **Time Out** (side). See Table 3–7 on page 3–132 to select the time qualifier that is appropriate to your application. Also, read the example that follows.

Figure 3-65 shows an example of **> Time** qualification. In this case, the Boolean requirement for the three-input pattern is defined by the AND logic chosen. The inputs shown, Ch 1 – Ch 3, must match their defined, all HIGH (HHH), a period exceeding the time limit set, 200  $\mu$ s.

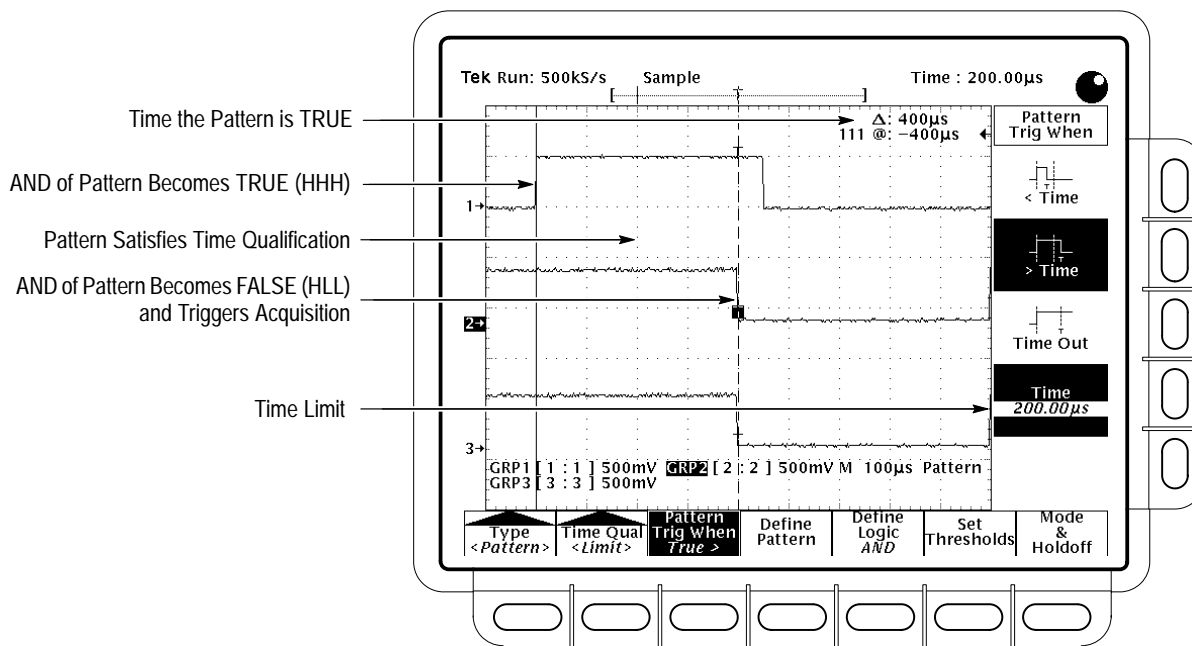

Figure 3-65: Time-Qualified Pattern Triggering: **> Time**

Figure 3-65 illustrates the principle that all time qualifiers, except Time Out, wait until *after the pattern comparison fails (becomes FALSE)* to trigger. (Compare to Figure 3-64 on page 3–137, which shows Time Out qualification.) Examine Figure 3-65 and note the following points.

- Time qualification starts (the logic scope starts an internal timer) when the input pattern becomes TRUE. (See Table 3–6 on page 3–131.)
- The delay between the vertical bar cursors indicates the time that the inputs continue to stay TRUE.
- Timing continued until the triggered inputs fail the Boolean comparison. Since the elapsed time (400  $\mu$ s) was more than the time limit specified (200  $\mu$ s), the logic scope triggered *at the point comparison failed*.

## To Trigger on a Time-Range Qualified Pattern

To trigger on a pattern that becomes TRUE (as defined by the logic selected) and stays TRUE for a time that falls inside or outside a time range (window) that you specify, do the following steps.

1. Define the pattern, Boolean requirements, thresholds, mode, and holdoff using the methods outlined in *To Trigger on a Pattern* on page 3–134.
2. Press **TRIGGER MENU** → **Type** (main) → **Pattern** (pop-up) → **Time Qual** (main) → **Range** (pop-up).
3. Press **Pattern Trig When** (main) → **Lower Limit** (side).
4. Use the general purpose knob or keypad to set the lower time limit *from when the pattern becomes TRUE* in the side menu.
5. Press **Upper Limit** (side).
6. Use the general purpose knob or keypad to set the upper time limit *from when the pattern becomes TRUE* in the side menu.
7. Press **In Range** or **Out of Range** (side). See Table 3–7 on page 3–132 to select the time qualifier that is appropriate to your application.

## To Find More Information

See *Triggering*, on page 2–13.

See *Triggering on Signals*, on page 3–159.



# Triggering on Pulses

The TLS 216 Logic Scope can trigger on glitches or pulses based on their width. It compares the trigger source input with the glitch or pulse width limit (or range) you specify and triggers when the comparison meets your specification.

This article describes how to select glitch or pulse triggering and how to time qualify the glitch or pulse width to trigger on. Setting up for pulse triggering using the delayed trigger system is identical except where noted. Refer to *Triggering After Delay*, on page 3–121, to learn about using the delayed trigger system.

## To Understand Pulse Triggers

To discover how Pulse triggering occurs, read the following topics.

### Classes of Pulse Triggers

There are two classes of pulse triggering — glitch and width.

A *glitch* trigger occurs when the trigger source detects a pulse narrower or, optionally, wider than some specified time. The logic scope can trigger on positive or negative glitches.





A *width* trigger occurs when the trigger source detects a pulse that is inside or, optionally, outside some specified time range (defined by the upper limit and lower limit). The logic scope can trigger on positive or negative pulses.

### The Pulse Triggering Process

To effectively use the pulse triggering, consider the process used by the logic scope trigger on a pulse.

1. After holdoff ends, the logic scope monitors the input you select as the trigger source for threshold crossings that define a pulse (and its width) of the polarity you select.
2. As the logic scope locates pulses, it compares their width with the time qualification you set in the Trig When menu.
3. If the pulse width satisfies the time qualification, the logic scope triggers. Table 3–8 lists the four definitions available for pulse triggering.

Table 3-8: Pulse Trigger Definitions

Name	Definition
 <b>Glitch positive</b>	Triggering occurs if the logic scope detects positive spike widths less than or, optionally, greater than the specified glitch time.
 <b>Glitch negative</b>	Triggering occurs if the logic scope detects negative spike widths less than or, optionally, greater than the specified glitch time.
 <b>Width positive</b>	Triggering occurs if the logic scope finds a positive pulse with a width between or, optionally, outside the user-specified lower and upper time limits.
 <b>Width negative</b>	Triggering occurs if the logic scope finds a negative pulse with a width between or, optionally, outside the user-specified lower and upper time limits.

## To Check Trigger Status

To tell if the currently selected trigger type is *Pulse*, check the trigger readout displayed in the lower right corner of the display. (See Figure 3-66.)

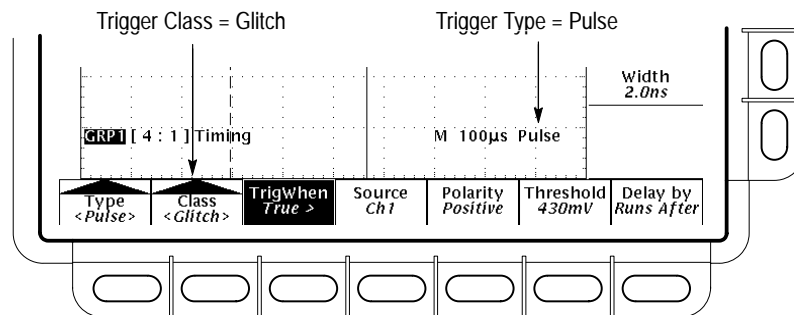

Figure 3-66: Pulse Trigger Readouts

To determine the overall setup for the pulse trigger, press **SHIFT** → **STATUS** → **Trigger** (main) → **Thresholds, Main**, or **Delay** (side).

## To Setup for Pulse Triggering

To define the pulse source, select the mode (auto or normal), and adjust the holdoff, do the following procedures.

**Select Pulse Triggering** Press **TRIGGER MENU** → **Type** (main) → **Pulse** (pop-up). (See Figure 3-67.)

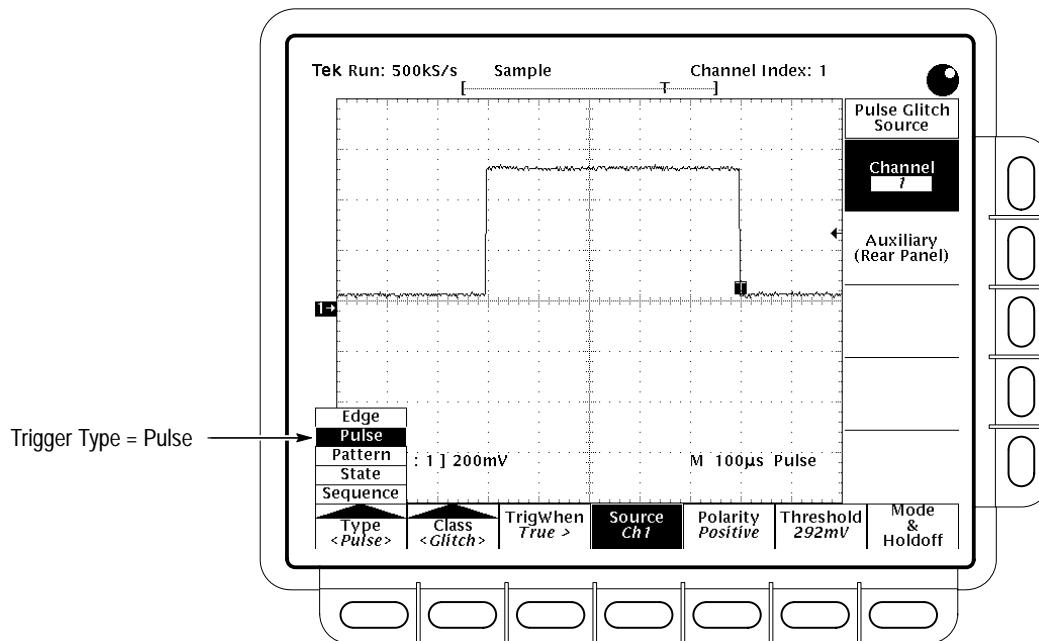

Figure 3-67: Pulse Trigger Menu

**Select a Trigger Source** To specify which channel becomes the pulse trigger source, do the following steps.

1. Press **TRIGGER MENU** → **Type** (main) → **Pulse** (pop-up) → **Source** (main).
2. Press **Channel** or **Auxiliary** (side). If specifying a channel as a trigger source, use the general purpose knob or keypad to select from channel 1 through 16.

**Set Mode & Holdoff** To change the holdoff time and select the trigger mode, do the following steps.

1. Press **TRIGGER MENU** → **Mode & Holdoff** (main) → **Auto** or **Normal** (side).



In Auto mode the logic scope triggers an acquisition after a specific time has elapsed even if a trigger event does not occur. The amount of time the logic scope waits depends on the time base setting.

In Normal mode the logic scope acquires only if there is a valid trigger.

2. Press **Holdoff** (side). Enter the value (in percent) using the general purpose knob or the keypad.

## Set the Trigger Threshold

To set the trigger threshold of the currently selected source, do the following steps.

1. Press **TRIGGER MENU** → **Type** (main) → **Pulse** (pop-up) → **Threshold** (main) → **Threshold** (side).
2. Turn the general purpose knob or use the keypad to enter the voltage threshold you want.

To set the trigger threshold for pulse triggers without accessing the trigger menus, turn the **TRIGGER THRESHOLD** knob. (Main trigger system only.)

To turn on or off a trigger bar that moves vertically on screen to indicate the threshold level you set, press **DISPLAY** → **SETTINGS** (main) → **DISPLAY** (pop-up) → **READOUT OPTION** (main). Repeatedly press **Trigger Bar Style** (side) to cycle among the **Long**, **Short**, and **OFF** settings.

To set the trigger threshold to a preset level appropriate for use with certain logic families, press **TRIGGER MENU** → **Type** (main) → **Pulse** (pop-up) → **Threshold** (main) → **Preset to Logic Families** (side) → **Set to TTL**, **Set to +ECL**, **Set to -ECL**, or **Set to CMOS** (side).

To copy the threshold you set to a group of inputs or to all the inputs, refer to the general procedure *To Set Trigger Thresholds* on page 3–162.

## To Trigger on a Glitch

To trigger on a glitch with a width narrower (or wider) than a time you specify, do the following procedures.

### Select Glitch Triggering and Glitch Polarity

To select glitch triggering and polarity, do the following steps.

1. Press **TRIGGER MENU** → **Type** (main) → **Pulse** (pop-up) → **Class** (main) → **Glitch** (side).
2. Press **Polarity** (main) → **Positive** or **Negative** (side).



Glitch Positive looks at positive-going pulses.



Glitch Negative looks at negative-going pulses.

### Time Qualify the Glitch

You can specify whether to trigger on glitches or filter out (ignore) glitches by specifying the glitch width and setting a time qualifier. To *ignore* glitches shorter than a time you specify:

1. Press **TRIGGER MENU** → **Type** (main) → **Pulse** (pop-up) → **Trig When** (main) → **Width** (side).
2. Turn the general purpose knob or use the keypad to enter a width for glitches that are to be ignored.
3. Press > **Time**. Glitches will have to be wider than the time set in step 2 to cause the logic scope to trigger. Any glitch wide enough to trigger the logic scope triggers it at the trailing edge of the glitch.
4. Readjust the trigger threshold as needed. (See procedure on page 3–144.)

To trigger on, rather than ignore, glitches that are *narrower* than a time you specify, press < **Time** instead of > **Time** in step 3, above. Any glitch narrow enough to trigger the logic scope triggers it at the trailing edge of the glitch.

To trigger on a glitch at the *point it exceeds* a width you specify, press **Time Out** instead of > **Time** in step 3, above. Any glitch wide enough to trigger the logic scope triggers it at the point the glitch width exceeds the time you set.

## To Trigger Based on Pulse Width

To trigger on a pulse narrower (or wider) than some specified *range* of pulse widths (defined by the upper limit and lower limit), do the following procedures.

### Select Pulse Triggering and Pulse Polarity

To select pulse width triggering, do the following steps.

1. Press **TRIGGER MENU** → **Type** (main) → **Pulse** (pop-up) → **Class** (main) → **Width** (side).
2. Press **Polarity** (main) → **Positive** or **Negative** (side).



Pulse Width Positive looks at positive-going pulses.



Pulse Width Negative looks at negative-going pulses.

### Time Qualify the Pulse

You can specify whether to trigger on pulses within a certain range of pulse widths or filter out (ignore) pulses within that range. To ignore pulses outside the width range you specify, do the following steps.

1. Press **TRIGGER MENU** → **Type** (main) → **Pulse** (pop-up) → **Class** (main) → **Width** (pop-up) → **Trig When** (main).
2. Press **Lower Limit** (side). Turn the general purpose knob or use the keypad to enter the lower limit for the range of pulses to be ignored. The logic scope will always force the **Lower Limit** to be less than or equal to the **Upper Limit**.
3. Press **Upper Limit** (side). Turn the general purpose knob or use the keypad to enter the upper limit for the range of pulses to be ignored.
4. Press **Out of Limits** (side). Pulses must have pulse widths that are less than the lower limit set in step 2 or that exceed the upper limit set in step 3 to cause the logic scope to trigger. Any pulse meeting those requirements triggers the logic scope at the trailing edge of the pulse.
5. Readjust the trigger threshold as needed. (See procedure on page 3–144.)

To trigger on, instead of ignore, pulses that fall inside the upper and lower limits (inclusive) that you specify, press **Within Limits** instead of **Out of Limits** in step 4, above. Any pulse within the range specified triggers logic scope it at the trailing edge of the pulse.

### To Find More Information

See *Triggering*, on page 2–13.

See *Triggering on Signals*, on page 3–159.

# Triggering on a Sequence

The TLS 216 Logic Scope can trigger on a sequence of two logic or binary patterns. It compares the trigger source inputs with the first logic pattern you define and recognizes that pattern when the comparison meets certain conditions that you specify. It then compares the same trigger inputs with a second pattern you define and triggers when the comparison meets the conditions you specify.

This article describes how to define and time qualify a sequence trigger using the main trigger system. Setting up for sequence triggering using the delayed trigger system is identical except where noted. Refer to *Triggering After Delay*, on page 3–121, to learn about using the delayed trigger system.

## To Understand Sequence Triggers





To more effectively use the sequence trigger, consider the process used by the logic scope to trigger on a sequence of two patterns and how time qualification affects the actual point at which triggering occurs.

### The Sequence Triggering Process





The logic scope executes the following steps when sequence triggering.

1. After hold off ends, the logic scope monitors its inputs — Ch 1 through Ch 16 and the Auxiliary Trigger.
2. As it monitors, it compares (ANDs, NANDs, ORs, or NORs, as you specify) its inputs with the pattern of logic levels, HIGH (H), LOW (L), or Don't Care (X), that you define as the *start*, or beginning, pattern. (It ignores inputs set to Don't Care.)
3. If the comparison indicates the start pattern is TRUE (meets the Boolean requirement for the logic selected), the logic scope immediately starts a timer. Table 3–9 lists the four logic functions and their corresponding Boolean requirements that can start the timer.
4. The logic scope monitors the trigger inputs as just explained in step 2 except it compares them with the *end* pattern that you define.
5. The logic scope recognizes the end pattern when it compares TRUE. It simultaneously stops the timer.
6. If the time qualification is met, the logic scope triggers. Table 3–10 lists each time qualifier versus the trigger event it qualifies.

**Table 3–9: Logic Functions**

Logic	Boolean Requirement for a TRUE Input Pattern (Start or End)
AND 	All the inputs must match their logic level as they appear in the pattern definition: HIGH (H), LOW (L), or Don't Care (X).
NAND 	At least one of the inputs must cease to match its logic level as it appears in the pattern definition.
OR 	At least one of the inputs must match its logic levels as it appears in the pattern definition.
NOR 	All the inputs must cease to match their logic levels as they appear in the pattern definition.

**Table 3–10: Time Qualifiers**

Trig When	Time Qualifiers versus Trigger Event
< Time 	The inputs must first compare TRUE <sup>1,2</sup> with the start pattern. The inputs must then compare TRUE with the end pattern <i>before</i> a user-specified time expires. The logic scope triggers <i>at the point the end pattern becomes TRUE.</i>
> Time 	The inputs must first compare TRUE <sup>1,2</sup> with the start pattern. The inputs must then compare TRUE with the end pattern <i>after</i> a user-specified time expires. The logic scope triggers <i>at the point the end pattern becomes TRUE.</i>
Time Out 	The inputs must first compare TRUE <sup>1,2</sup> with the start pattern. The inputs must then not compare TRUE with the end pattern <i>before</i> a user-specified time expires. The logic scope triggers <i>at the point that time expires.</i>
In Range 	The inputs must first compare TRUE <sup>1,2</sup> with the start pattern. The inputs must then compare TRUE with the end pattern <i>after</i> a user-specified minimum time expires but <i>before</i> a user-specified maximum time expires. The logic scope triggers <i>at the point that the end pattern becomes TRUE.</i>
Out of Range 	The inputs must first compare TRUE <sup>1,2</sup> with the start pattern. The inputs must then compare TRUE with the end pattern <i>before</i> a user-specified minimum time expires or <i>after</i> a user-specified maximum time expires. The logic scope triggers <i>at the point that the end pattern becomes TRUE.</i>

<sup>1</sup> Inputs are TRUE when they meet the Boolean requirement for the logic function selected; otherwise they are FALSE. See Table 3–9.

<sup>2</sup> The logic scope starts timing the period at the point when the inputs become TRUE (see footnote 1).

## How Time Qualification Affects the Trigger Point

As Table 3–10 indicates, the time qualifier you choose determines the trigger point. Depending on the time qualifier you choose, you can:

- trigger as soon as possible after the logic scope recognizes the specified sequence.
- trigger after the logic scope recognizes the sequence relative to a time you specify.

The two ways of triggering just listed reflect the following key concepts governing sequence triggering with the logic scope.

- The logic scope starts a timer when the start pattern compares TRUE. The logic scope ignores the start pattern definition after starting the timer.
- With all time qualifiers except the Time Out qualifier, the logic scope *triggers at the point the end pattern compares TRUE*.
- The Time Out qualifier is the exception; it triggers *at the instant the timer expires* without the end pattern becoming TRUE.

To learn more about how your choices for time qualification affect the point at which triggering occurs, read the procedures in the following list.

*To Trigger on a Sequence*, which begins on page 3–150, lists the basic procedure to set up the logic scope to do a sequence trigger.

*To Trigger Immediately on a Sequence*, which begins on page 3–154, lists the specialized procedure for using the time-limit qualifier > Time with minimum time qualification to trigger as soon as possible on a sequence of two patterns. Figure 3-70 on page 3–155 locates the trigger point for this type of time-qualified sequence trigger.

*To Trigger on a Time-Limit Qualified Sequence*, which begins on page 3–155, lists the more general procedure for using all three time-limit qualifiers — < Time, > Time, and Time Out. It includes an example (Figure 3-71 on page 3–156) that locates the trigger point for the Time Out qualified sequence trigger and contrasts it with the trigger point established for other types of time qualification follows the procedure.

*To Trigger on a Time-Range Qualified sequence*, which begins on page 3–157, lists the general procedure for using both types of the time-range qualifiers, In Range and Out of Range.

## To Check Trigger Status

To tell if the currently selected trigger type is *Sequence*, check the trigger readout displayed in the lower right corner of the display.

To quickly check the currently defined start or end pattern, press **TRIGGER MENU** → **Type** (main) → **Sequence** (pop-up) → **Define Start Pattern** or **Define End Pattern** (main) to pop up a display of the pattern. (See Figure 3-68.)

To determine the overall setup for the sequence trigger, press **SHIFT** → **STATUS** → **Trigger** (main). Choose from **Thresholds**, **Main**, and **Delay** in the side menu.

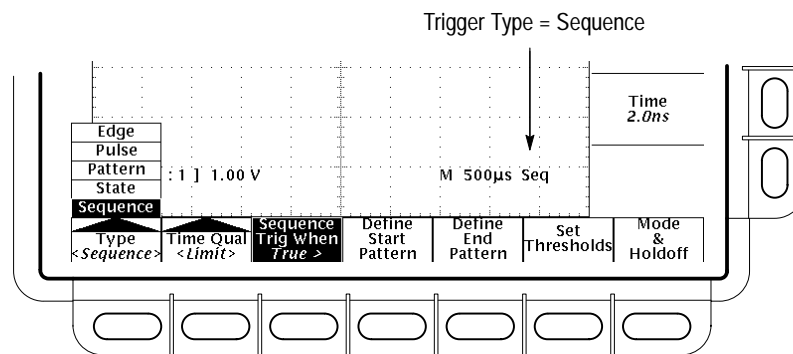

Figure 3-68: Trigger Readout

## To Trigger on a Sequence

If you want to trigger on a sequence of two TRUE (as defined by the logic selected) patterns, you must do the following tasks.

*Define the Start and End Patterns* by specifying the logic levels of the start and the end pattern definitions with which the inputs are compared. Each “bit” in the pattern is a logic HIGH (H), LOW (L), or Don’t Care (X) that corresponds to one logic scope input. (The inputs are channels 1 through 16 and the Auxiliary trigger.)

*Define the Boolean Requirement for both Patterns* by specifying that the comparison logic be AND, NAND, OR, or NOR. (See Table 3–9 on page 3–148 for the Boolean requirement associated with each comparison logic function.)

*Time Qualify the Sequence Trigger* by specifying the time or range of time that the inputs must meet the Boolean requirement.

**Select Sequence Triggering**

To begin specifying your sequence trigger, press **TRIGGER MENU** → **Type** (main) → **Sequence** (pop-up). (See Figure 3-69.)

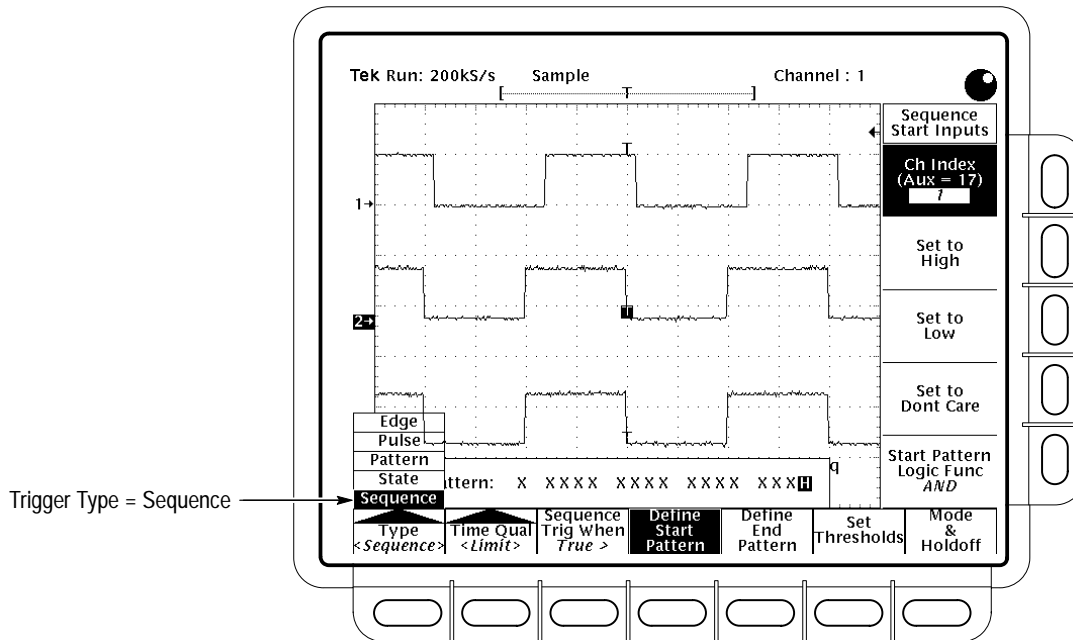

**Figure 3-69: Sequence Trigger Menu**

**Define the Start Pattern**

To select the logic level required for each input of the start pattern, do the following steps.

1. Press **TRIGGER MENU** → **Type** (main) → **Sequence** (pop-up) → **Define Start Pattern** (main).
2. Press **Ch Index** (side). Use the general purpose knob or keypad (or repeatedly press **Ch Index**) to enter the channel you want to set. The channel selected appears in the Source menu item.
3. Press **Set to High**, **Set to Low**, and **Set to Don't Care** (side) to set the logic level you want applied to the channel just selected. Note that setting the logic level of a channel decrements the channel index to automatically select the next channel.
4. Repeat step 3 to set all inputs to the levels you require. You can skip over channels already properly defined (or return to a channel to redefine it) using the general purpose knob, keypad, or **Ch Index** button.



---

**NOTE.** *The logic scope will not trigger if all pattern inputs are set to Don't Care. The logic scope only recognizes patterns that have at least one input set to HIGH or LOW.*

---

### Define the Start Pattern Logic

To define the Boolean requirement for a TRUE start pattern, select the logic function (AND, NAND, OR, or NOR), do the following steps.

1. Press **TRIGGER MENU** → **Type** (main) → **Sequence** (pop-up) → **Define Start Pattern** (main) → **Start Pattern Logic Func** (side).
2. Repeatedly press **Start Pattern Logic Func** (side) to select among **AND**, **NAND**, **OR**, or **NOR** (side).

See Table 3–9 on page 3–148 to select the logic function appropriate for your application.

### Define the End Pattern

To select the logic level required for each input of the end pattern:

1. Press **TRIGGER MENU** → **Type** (main) → **Sequence** (pop-up) → **Define End Pattern** (main).
2. Press **Ch Index** (side). Use the general purpose knob or keypad (or repeatedly press **Ch Index**) to enter the channel you want to set. The channel selected appears in the Source menu item.
3. Press **Set to High**, **Set to Low**, and **Set to Don't Care** (side) to set the logic level you want applied to the channel just selected. Note that setting the logic level of a channel decrements the channel index to automatically select the next channel.
4. Repeat step 3 to set all inputs to the levels you require. You can skip over channels already properly defined (or return to a channel to redefine it) using the general purpose knob, key pad, or the Ch Index button.

### Define the End Pattern Logic

To define the Boolean requirement for a TRUE end pattern, select the logic function (AND, NAND, OR, or NOR):

1. Press **TRIGGER MENU** → **Type** (main) → **Sequence** (pop-up) → **Define End Pattern** (main) → **End Pattern Logic Func** (side).
2. Repeatedly press **End Pattern Logic Func** (side) to select among **AND**, **NAND**, **OR**, or **NOR** (side).

The end pattern logic you select does not have to match that selected for the start pattern. See Table 3–9 on page 3–148 to select the logic function appropriate for your application.

**Set Mode & Holdoff**

To change the holdoff time and select the trigger mode:

1. Press **TRIGGER MENU** → **Mode & Holdoff** (main) → **Auto** or **Normal** (side).

In Auto mode the logic scope triggers an acquisition after a specific time has elapsed even if a trigger event does not occur. The amount of time the logic scope waits depends on the time base setting.

In Normal mode the logic scope acquires only if there is a valid trigger.

2. Press **Holdoff** (side). Enter the value in percent using the general purpose knob or the keypad.

**Set the Trigger Thresholds**

You can set the trigger threshold of each input individually to the same or different levels. Also, you can set the trigger threshold of one input and copy it to a group of inputs or to all inputs with one operation. To set the thresholds, refer the general procedure *To Set Trigger Thresholds* on page 3–162.

---

**NOTE.** Although you can set the pattern logic levels (*HIGH, LOW, and Don't Care*) and pattern logic (*AND, NAND, OR, and NOR*) independently for the start and end patterns, they must share the same trigger threshold levels. For example, the threshold level you set for *Ch1* is used for both patterns.

Also, when using sequence triggering with delayed acquisitions, see *Trigger Sources and Thresholds* on page 3–122 for special considerations for setting trigger thresholds.

---

**Qualify the Trigger**

To control how much time that a TRUE end pattern must trail a TRUE start pattern in order for a trigger to occur, you must time qualify it. To do so, perform one of the following procedures.

- To trigger immediately when a TRUE end pattern follows a TRUE start pattern, perform *To Trigger Immediately on a Sequence* below.
- To trigger when a TRUE end pattern follows a TRUE start pattern within a time less than or greater than a time *limit* that you specify, perform *To Trigger on a Time-Limit Qualified Sequence* on page 3–155.
- To trigger when a TRUE end pattern follows a TRUE start pattern within a time that falls inside or outside a time *range* (window) that you specify, perform *To Trigger on a Time-Range Qualified Sequence* on page 3–157.

## To Trigger Immediately on a Sequence

If you want to trigger as soon as possible after the end pattern goes TRUE (as defined by the logic selected), you must set the minimum time qualification possible by doing the following steps.

1. Define the pattern, Boolean requirements, thresholds, mode, and holdoff using the methods outlined in *To Trigger on a Sequence* on page 3–150.
2. Press **TRIGGER MENU** → **Type** (main) → **Sequence** (pop-up) → **Time Qual** (main) → **Limit** (pop-up).
3. Press **Sequence Trigger When** (main) → > **Time** (side).
4. Press **Time** (side). Use the general purpose knob or the keypad to set the time limit *to its minimum value*.

---

**NOTE.** *The minimum time qualification of 2 ns is a value the logic scope can typically achieve. For warranted values, consult the TLS 216 Performance Verification and Specifications manual shipped with the logic scope.*

---

Figure 3-70 shows triggering on a sequence of two patterns, time-qualified to trigger as soon as possible after the second pattern is recognized. (The first pattern must be recognized first.) Compare with Figure 3-71 on page 3–156 that shows Time Out time qualification.

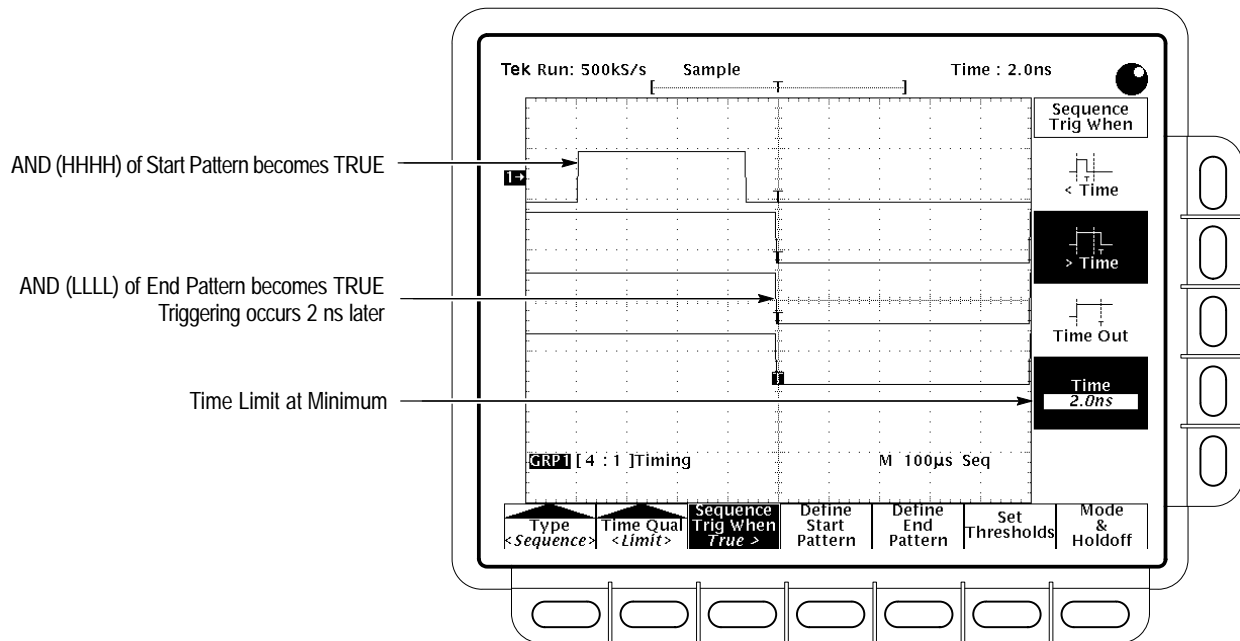

Figure 3-70: Triggering on a Sequence: > Time, Minimum Time Qualification

## To Trigger on a Time-Limit Qualified Sequence

To trigger on a sequence of two TRUE patterns where the second (end) pattern becomes TRUE (relative to the first pattern) at a time that ends before or extends beyond a time limit you specify, do the following steps.

1. Define the start and end pattern levels, logic functions, thresholds, and the trigger mode and holdoff using the methods outlined in *To Trigger on a Sequence* on page 3–150.
2. Press **TRIGGER MENU** → **Type** (main) → **Sequence** (pop-up) → **Time Qual** (main) → **Limit** (pop-up).
3. Press **Sequence Trigger When** (main) → **Time** (side).
4. Use the general purpose knob or the keypad to set the time limit *from when the start pattern becomes TRUE* in the side menu.
5. Press **< Time**, **> Time**, or **Time Out** (side). See Table 3–10 on page 3–148 to select the time qualifier that is appropriate to your application. Also, read the example that follows.

Figure 3-71 shows an example of Time Out qualification. In this case, the Boolean requirements for the three-input start and end patterns are defined by the AND logic chosen. The inputs shown (Ch 1 – Ch 3) must match their defined

levels, all HIGH (HHH) for the start and all LOW (LLL) for the end pattern. The time limit is set for 400  $\mu$ s.

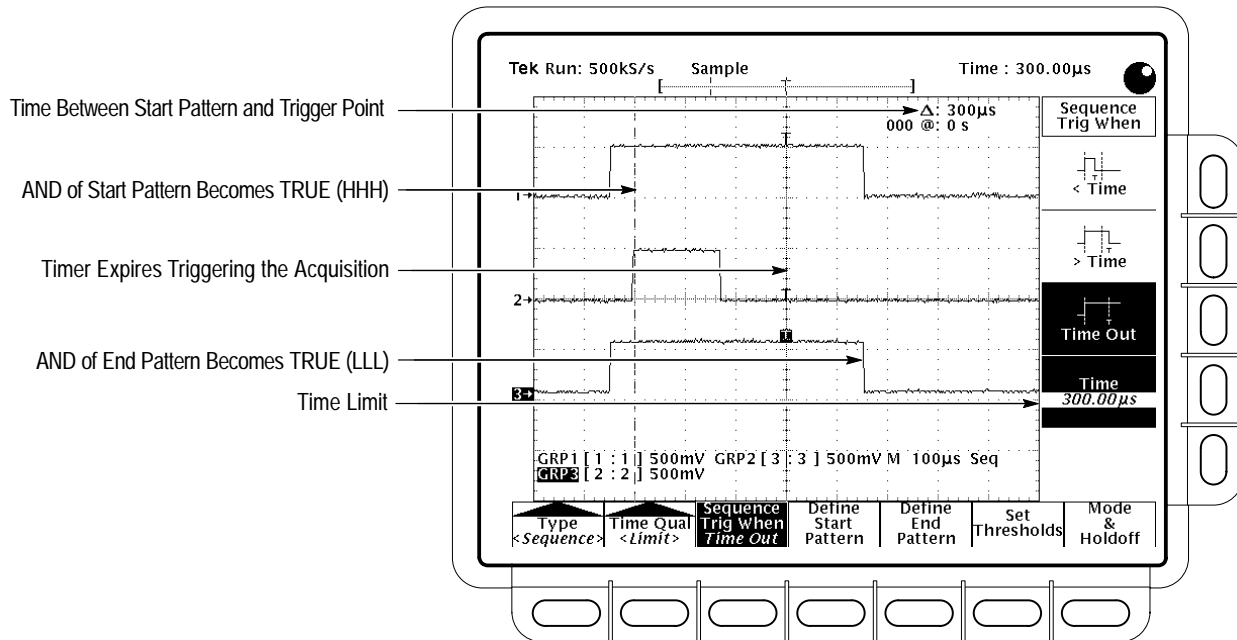

Figure 3-71: Time-Qualified Pattern Triggering: *Time Out*

You can use Figure 3-71 to explore two key concepts for using sequence triggers.

- *If using the time out qualification*, the trigger event occurs when the time specified expires.
- *If using any other time limit or range qualification*, the trigger event occurs at the time the end pattern becomes TRUE.

Reference Figure 3-71, which show Time Out selected, as you consider the following points:

- The logic scope monitors its inputs against the start pattern.
- The start pattern becomes TRUE, so the logic scope starts an internal timer. The left-most vertical bar cursor marks the transition to TRUE in Figure 3-71.
- The logic scope waits for a TRUE end pattern while the timer runs.
- The timer runs out (the 400  $\mu$ s set in the side menu elapses), so the logic scope triggers at the point the timer elapses.

- The end pattern becomes TRUE. (Had the end pattern become TRUE *before* the timer had expired, the logic scope would have rearmed its trigger system and waited for a new *start* pattern to occur.)

In contrast to Time Out, all other trigger qualifiers (> Time, < Time, In Range, and Out of Range) would trigger at the time *the second pattern compares TRUE*. For instance in the example above, switching time qualification to:

- > Time would cause the trigger point to occur at the point the end pattern becomes TRUE in Figure 3-71, since the 500  $\mu$ s between start and end patterns is greater than the 400  $\mu$ s set.
- < Time would also cause the trigger point to occur at the point the end pattern becomes TRUE, *if* you increase the time limit set in side menu so the 500  $\mu$ s between start and end patterns is less than the time qualification.

## To Trigger on a Time-Range Qualified Sequence

To trigger on a sequence of two TRUE patterns where the second (end) pattern becomes TRUE (relative to the first pattern) at a time that falls inside or outside a time range (window) you specify, do the following steps:

1. Define the start and end pattern levels, logic functions, and thresholds, and the trigger mode and holdoff using the methods outlined in *To Trigger on a Sequence* on page 3–150.
2. Press **TRIGGER MENU** → **Type** (main) → **Sequence** (pop-up) → **Time Qual** (main) → **Range** (pop-up)
3. Press **Sequence Trigger When** (main) → **Lower Limit** (side).
4. Use the general purpose knob or keypad to set the lower time limit *from when the pattern becomes TRUE* in the side menu.
5. Press **Upper Limit** (side).
6. Use the general purpose knob or keypad to set the upper time limit *from when the pattern becomes TRUE* in the side menu.
7. Press **In Range** or **Out of Range** (side). See Table 3–10 on page 3–148 to select the time qualifier that is appropriate to your application.

Triggering occurs at the point the end pattern becomes TRUE at a time that meets the In Range or Out of Range time constraint. See the discussion immediately preceding this procedure for more information.

## To Find More Information

See *Triggering*, on page 2–13.

See *Triggering on Signals*, on page 3–159.

# Triggering on Signals

Triggers determine when the logic scope starts acquiring and displaying a waveform group. The TLS 216 has five types of trigger: *edge*, *pulse*, *pattern*, *state*, and *sequence*. This article discusses some of the trigger controls and features that are common to several or all of these trigger types.

To learn about the general concept of triggering, see *Triggering* in the section *Operating Basics*. To learn more about using specific trigger types and using the delayed trigger system, see *To Find More Information* on page 3-164.

## To Trigger from the Front Panel

Several trigger functions can be operated from the front panel without accessing the trigger menu. To use those controls, do the following procedures.

### Set the Trigger Threshold

To manually adjust the trigger threshold level when edge or pulse triggering (only), turn the Trigger **THRESHOLD** knob. (See Figure 3-72.)

To set the trigger level to the halfway point between trigger signal peaks when edge or pulse triggering, press the **SET LEVEL TO 50%** button. (See Figure 3-72.)

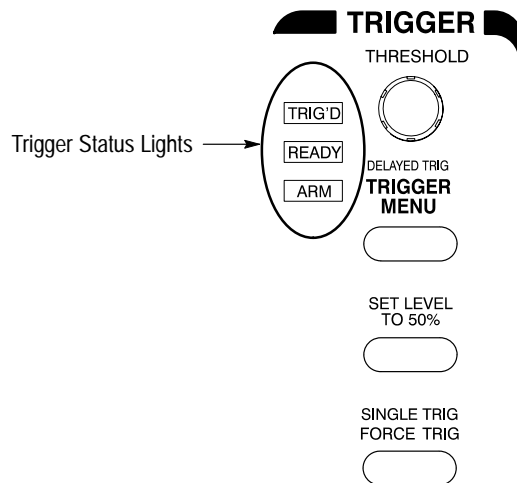

Figure 3-72: TRIGGER Controls and Status Lights

For general purpose work, choose edge triggering and use the THRESHOLD knob or the SET LEVEL TO 50% button as was just described to quickly set the



threshold level to trigger on a waveform edge. As previously stated, these two controls also work with pulse triggering.

### Force a Trigger

To force the logic scope to immediately start acquiring a waveform, even without a trigger event occurring, press the **FORCE TRIG** front-panel button. (See Figure 3-72.) Use **FORCE TRIG** with any of the five trigger types.

When in Normal trigger mode, use **FORCE TRIG** to quickly determine if there is a signal present for the logic scope to acquire. Once signal presence is established, you can determine how to trigger on it (press **SET LEVEL TO 50%**, check trigger source setting, and so on).

The logic scope forces acquisition even when you press **FORCE TRIG** before the end of pretrigger holdoff. However, pressing **FORCE TRIG** does not restart the acquisition system when stopped (for instance, by pressing the **RUN/STOP** button).

### Trigger a Single Sequence

To trigger on the next valid trigger event and then stop, press **SHIFT → SINGLE TRIG**. Now press the **RUN/STOP** button each time you want to initiate a single sequence of acquisitions. Use **SINGLE TRIG** with any of the five trigger types.

To leave Single Trig mode, press **SHIFT → ACQUIRE MENU → Stop After (main) → RUN/STOP Button Only (side)**.

Read the description under *Set Stop After Mode* on page 3–20 for further information on single sequence acquisitions.

## To Determine Trigger Status

To quickly determine partial trigger status (for instance, if the logic scope is triggered, its trigger type, and the type of trigger selected), use the trigger status lights and the trigger readout.

### Monitor the Trigger Status Lights

To determine the state of the trigger circuitry, watch the three status lights in the Trigger control area. (See Figure 3-72.) The lights are labeled **TRIG'D**, **READY**, and **ARM**. Use the trigger status lights with any of the five trigger types.

When **TRIG'D** lights, it means the logic scope has recognized a valid trigger and is filling the posttrigger portion of the waveform.

When **READY** lights, it means the logic scope can accept a valid trigger event and it is waiting for that event to occur.

When **ARM** lights, it means the trigger circuitry is filling the pretrigger portion of the waveform record.

When both TRIG'D and READY light, it means the logic scope has recognized a valid main trigger and is waiting for a delayed trigger. When it recognizes a delayed trigger, it will fill in the posttrigger portion of the delayed waveform.

**Determine the Trigger Type, Position, and Level**

To determine the trigger *type*, check the lower-right corner of the display. The trigger type readout appears for all trigger types. (See Figure 3-73.)

To determine the trigger *threshold level*, relative to a trigger source displayed on screen, check the long or short-style trigger level bar. (See Figure 3-73.)

The trigger bar appears for Edge and Pulse triggers only and must be turned on in the Display menu to appear at all. The trigger level bar shows only the trigger level, and it remains on screen regardless of the horizontal position as long as the channel providing the trigger source is displayed.

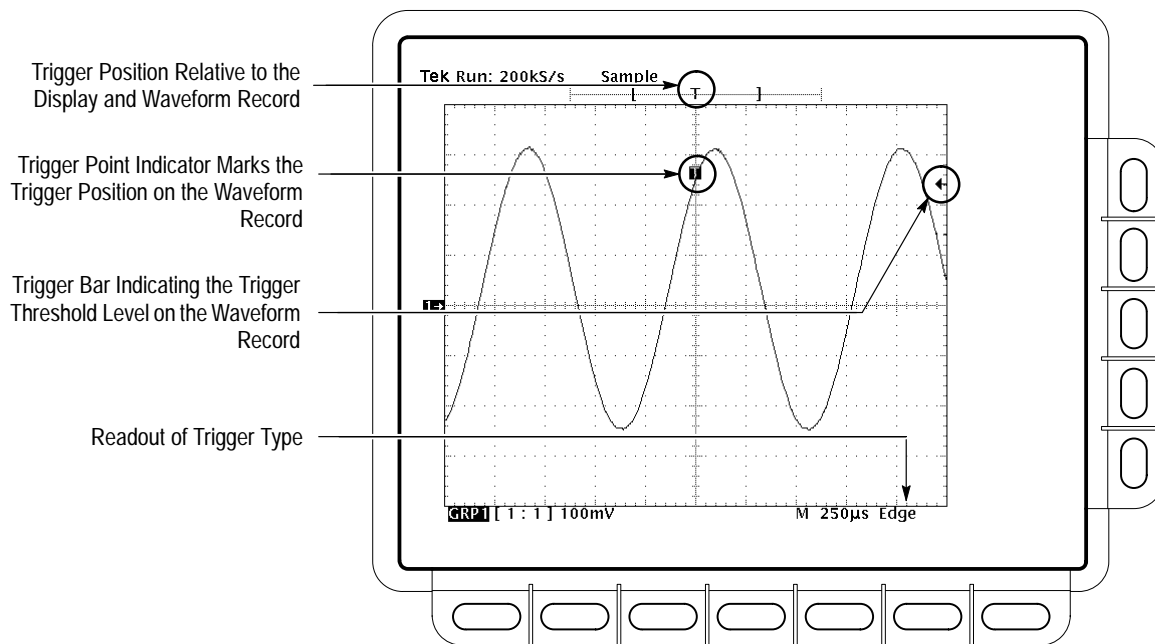

**Figure 3-73: Trigger Type, Record View, Trigger Position, and Trigger Level Bar Readouts**

To determine the *trigger position* of the waveform group, check the trigger point indicator (T) on the waveform. (See Figure 3-73.)

The trigger position indicator appears for all five trigger types if it is turned on in the Display menu. It can be horizontally positioned off screen with long record lengths.

To quickly determine the *trigger position relative to the display window*, check the record view at the top of the display. (See Figure 3-73.)

The record view shows the location of the trigger signal in the waveform record with respect to the display, so you can tell if it is to the left or right off screen. The trigger record view appears for all trigger types. It cannot be turned off and does not appear in the Display menu.

Both the trigger point indicator and level bar are turned on from the Display menu. See *Display Readout* on page 3–37 for more information.

## To Access the Trigger Menu

To select the trigger type, press **TRIGGER MENU** → **Type** (main) → **Edge**, **Pulse**, **Pattern**, **State**, or **Sequence** (pop-up).

To read about each trigger type, see the articles listed in *To Find More Information* on page 3–164.

## To Set Trigger Thresholds

Examine the following procedures to see the four different methods you can use to set up your trigger thresholds. These procedures cover all five trigger types.

### Set Thresholds Independently

To set the trigger threshold for *each* trigger input individually, do the following steps (Edge and Pulse triggers only.)

1. Press **TRIGGER MENU** → **Type** (main) → **Edge** or **Pulse** (pop-up) → **Source** (main) → **Channel** (side).
2. Use the general purpose knob or the key pad to select the channel.
3. Press **Threshold** (side). Use the general purpose knob or the keypad to set the level for the channel just selected.
4. Repeat steps 2 and 3 to set the trigger threshold for as many channels as you want.

To set the trigger threshold for *each* trigger input individually when selecting pattern, state, or sequence triggers, do the following steps.

1. Press **TRIGGER MENU** → **Type** (main) → **Pattern**, **State** or **Sequence** (pop-up) → **Set Thresholds** (main) → **Ch Index** (side).
2. Use the general purpose knob or the key pad to select the channel. (The selection 17 selects the Auxiliary input at the rear panel.)

3. Press **Threshold** (side). Use the general purpose knob or the keypad to set the level for the channel just selected.
4. Repeat steps 2 and 3 to set the trigger threshold for as many channels as you want.

---

**NOTE.** You can select the auxiliary input (rear panel) as a source, but you cannot set its threshold. The threshold voltage for the auxiliary input is fixed at 1.5 V.

When using the delayed trigger system, you need to be aware that adjusting the threshold for a trigger source in the main or delayed trigger system adjusts it for both systems. See *Trigger Sources and Thresholds on page 3–122 of the article Triggering After Delay.*

---

### Copy a Threshold to a Group

To set the logic threshold for *all* trigger inputs in a group to the same level, do the following steps.

1. Select a trigger source in the group that you want to share the same threshold voltage and set its threshold using the appropriate procedure as described in *Set Thresholds Independently* on page 3–162.
2. Press **Copy to Group** (side). The logic scope sets the trigger threshold voltage of all channels common to the group containing the trigger source to the level set for step 1.

### Copy a Threshold to all Trigger Inputs

To set the logic threshold for *all* trigger inputs of the logic scope to the same level, press **Copy to All** (side) instead of **Copy to Group** (side) using the process just described.

### Preset a Threshold Based on a Logic Family

To set the logic level to a threshold appropriate for a certain logic family, do the following steps.

1. Press **TRIGGER MENU** → **Type** (main) → **Set Thresholds** (main) → **Preset to Logic Family** (side).
2. Press any of the following choices in the Thresholds Presets side menu displayed.

**Set to TTL** fixes the trigger level at +1.4 V.

**Set to +ECL** fixes the trigger level at +3.7 V.

**Set to –ECL** fixes the trigger level at –1.3 V.

**Set to CMOS** fixes the trigger level at +2.5 V.

---

**NOTE.** When you set the volts/div smaller than 200 mV, the logic scope reduces the Set to TTL or Set to ECL trigger levels below standard TTL and ECL levels. That happens because the trigger level range is fixed at  $\pm 12$  divisions from the center screen. At 100 mV (the next smaller setting after 200 mV) the trigger range is  $\pm 1.2$  V, which is smaller than the typical TTL (+1.4 V) or ECL (-1.3 V) level.

---

## To Find More Information

See *Triggering After Delay*, on page 3–121.

See *Triggering on Edges*, on page 3–127.

See *Triggering on Patterns*, on page 3–131.

See *Triggering on Pulses*, on page 3–141.

See *Triggering on a Sequence*, on page 3–141.

See *Triggering*, on page 2–13.

# Triggering on States

The TLS 216 Logic Scope can trigger on the state of a logic or binary pattern at the time it is clocked. The logic scope compares the trigger inputs against the digital pattern you define and triggers when the comparison meets the conditions you specify *at the time its clock input changes state*.

This article describes how to define and time qualify a state trigger. Setting up for state triggering using the delayed trigger system is identical except where noted. Refer to *Triggering After Delay*, on page 3–121, to learn about using the delayed trigger system.

## To Understand State Triggers

To effectively use the state trigger, consider the process used by the logic scope to trigger on a state:

1. After hold off ends, the logic scope waits until the edge of the clock input you define changes state in the direction you define.
2. At the clock transition, it compares (ANDs, NANDs, ORs, or NORs, as you specify) its inputs with the pattern of logic levels, HIGH (H), LOW (L), or Don't Care (X), that you define. (It ignores inputs set to Don't Care.) The inputs compared are Ch 1 through Ch 16 and the Auxiliary Trigger.
3. If the comparison indicates the input pattern is TRUE (meets the Boolean requirement for the logic selected), the logic scope immediately triggers. Table 3–11 lists the four logic functions and their corresponding Boolean requirements for a trigger at the clock.

Table 3–11: State Triggers





Logic		Boolean Requirements for a Trigger Event
Clocked AND		All the inputs must match their logic level (as they appear in the pattern definition — HIGH (H), LOW (L), or Don't Care (X)) at the time the clock changes state.
Clocked NAND		At least one of the inputs must <i>not</i> match its logic level (as it appears in the pattern definition) at the time the clock changes state.

Table 3-11: State Triggers (Cont.)

Logic		Boolean Requirements for a Trigger Event
Clocked OR		At least one of the inputs must match its logic level (as it appears in the pattern definition) at the time the clock changes state.
Clocked NOR		All the pattern inputs must not match the pattern definition (as they appear in the pattern definition) at the time the clock changes state.

## To Check Trigger Status

To tell if the currently selected trigger type is set to State, check the trigger readout displayed in the lower left corner of the display.

To quickly check the currently defined pattern, push **TRIGGER MENU** → **State** (side) to pop up a display of the currently defined pattern. (See Figure 3-75 on page 3-167.)

To determine overall setup for the pattern trigger, press **SHIFT** → **STATUS** → **Trigger** (main). (See Figure 3-74.)

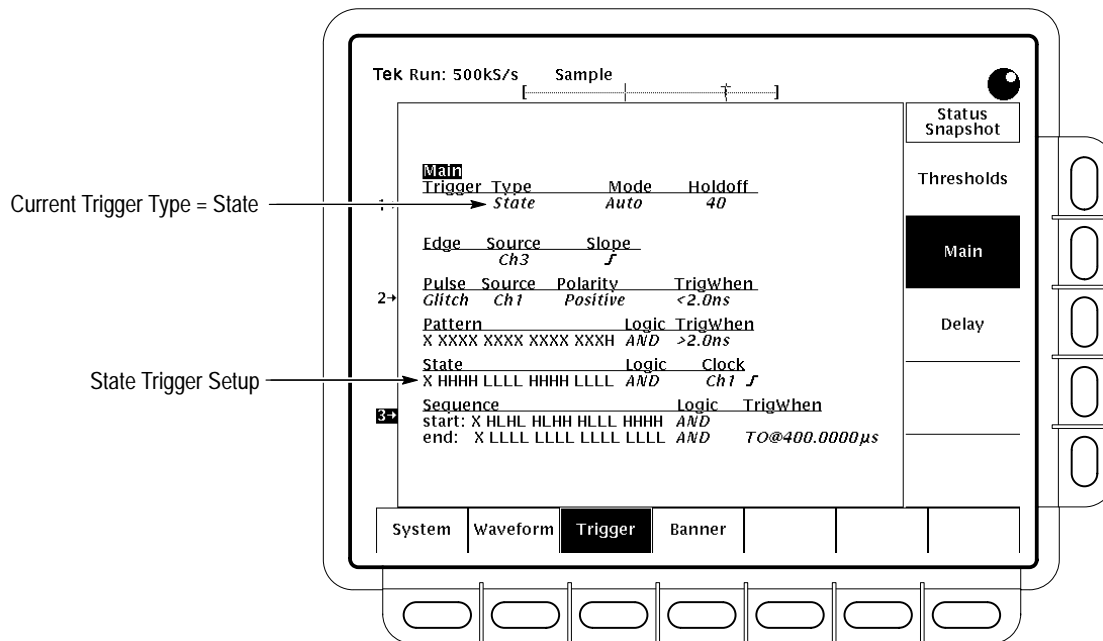

Figure 3-74: Snapshot of Trigger Status

## To Trigger on a State

To trigger at the point a state change clocks a pattern that is TRUE (as defined by Table 3–11 on page 3–165, you must do the following tasks.

*Define the Pattern* by specifying the logic levels against which the inputs are compared. Each “bit” in the pattern is a logic HIGH (H), LOW (L), or Don’t Care (X) that corresponds to one logic scope input. (The inputs are channels 1 through 16 and the Auxiliary trigger.)

*Define the Boolean Requirement* by specifying that the comparison logic be AND, NAND, OR, or NOR. (See Table 3–11 on page 3–165 for the Boolean requirement associated with each comparison logic function.)

*Define the Clock* by specifying its source, the direction its clocking edge must transition, and its threshold.

### Select State Trigger

To begin specifying your pattern trigger, select the state trigger menu (Figure 3-75), press **TRIGGER MENU** → **Type (main)** → **State** (pop-up).

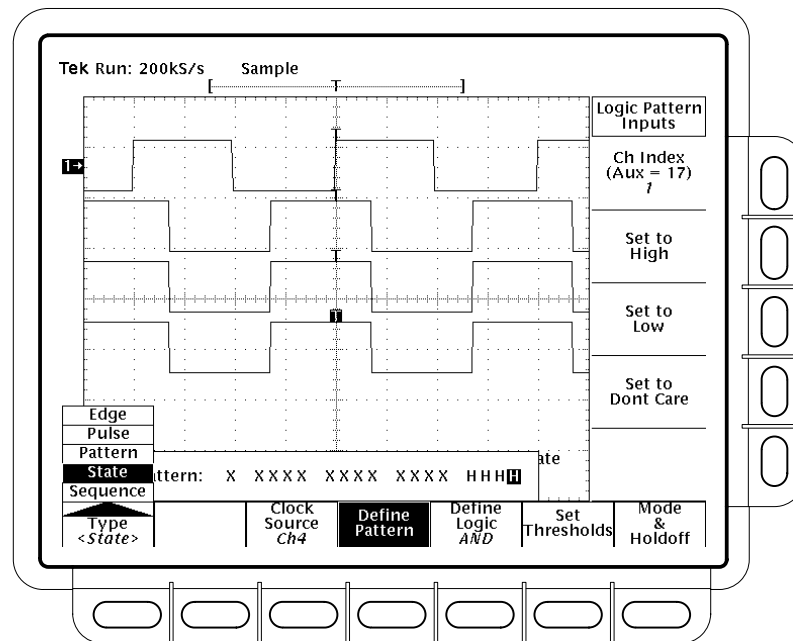

Figure 3-75: State Trigger Menu



### Define the Pattern

To quickly set the logic level for each of the input channels (Ch1 – Ch16 and Aux), do the following steps.

1. Press **TRIGGER MENU** → **Type (main)** → **State** (pop-up) → **Define Pattern** (main).
2. Press **Ch Index** (side). Use the general purpose knob or keypad (or repeatedly press **Ch Index**) to enter the channel you want to set. The channel selected appears in the Source menu item.
3. Press **Set to High**, **Set to Low**, and **Set to Don't Care** (side) to set the logic level you want applied to the channel just selected. Note that setting the logic level of a channel decrements the channel index to automatically select the next channel.
4. Repeat step 3 to set all inputs to the levels you require. You can skip over channels already properly defined (or return to a channel to redefine it) using the general purpose knob, keypad, or Ch Index button.

---

**NOTE.** *The logic scope will not trigger if all pattern inputs are set to Don't Care. The logic scope only recognizes patterns that have at least one input set to HIGH or LOW.*

---

### Define the Pattern Logic

To define the Boolean requirement for a TRUE pattern, select the logic function (AND, NAND, OR, or NOR), press **TRIGGER MENU** → **Type** (main) → **STATE** (pop-up) → **Define Logic** (main) → **AND, OR, NAND, or NOR** (side). (See Table 3–11 on page 3–165.)

### Set the Thresholds

You can set the threshold of each trigger input individually to the same or different levels. Also, you can set the threshold of one trigger input and copy it to a group of trigger inputs or to all trigger inputs with one operation. To set the thresholds, refer the general procedure *To Set Trigger Thresholds* on page 3–162.

---

**NOTE.** *See Trigger Sources and Thresholds on page 3–122 for special considerations when setting trigger thresholds for the delayed trigger system.*

---

### Define the Clock (State)

To define the source, polarity (edge), and threshold of the signal used to clock the state trigger, do the following steps.

1. Press **TRIGGER MENU** → **Type** (main) → **State** (pop-up) → **Clock Source** (main) → **Channel** or **Auxiliary** (side). When selecting a channel as

the source, use the general purpose knob or keypad to select from channels 1 through 16. The channel selected appears in the Source menu item.

2. Press **Polarity** (side). Press again to toggle between rising-edge and falling-edge polarity.
3. Press **Threshold** (side). Use the general purpose knob or the keypad to set the threshold level for the clock input.

---

**NOTE.** No matter how you set the clock source in the Define Pattern menu (to HIGH, LOW, or Don't Care), the logic scope ignores the clock source when evaluating whether a pattern is TRUE. The clock source only determines when the logic scope evaluates the pattern.

---

Figure 3-75 on page 3-167 shows state triggering on a three waveform pattern (bottom three waveforms) at the time the clock changes state going positive (top waveform).

### Set Mode & Holdoff

To change trigger mode or holdoff time (main trigger system only), do the following steps.

1. Press **TRIGGER MENU** → **Type** (main) → **State** (pop-up) → **Mode & Holdoff** (main) → **Auto** or **Normal** (side).

In Auto mode the logic scope acquires a waveform after a specific time has elapsed even if a trigger does not occur. The amount of time the logic scope waits depends on the time base setting.

In Normal mode the logic scope acquires a waveform only if there is a valid trigger.

2. Press **Holdoff** (side). Enter the value in percent using the general purpose knob or the keypad.

## To Find More Information

See *Triggering*, on page 2-13.

See *Triggering on Signals*, on page 3-159.



# Viewing Help

The TLS 216 Logic Scope includes an on-line help system to provide brief information about each of the logic scope controls. This article describes how to display help on screen.

## To Access On Line Help

To enter help mode, press **HELP**. (See Figure 3-76.)

While in help mode, pressing any button (except **HELP** or **SHIFT**) or turning any knob (or pressing any menu item if a menu is on screen) displays help text that discusses that control.

To exit help mode, press **HELP** again.

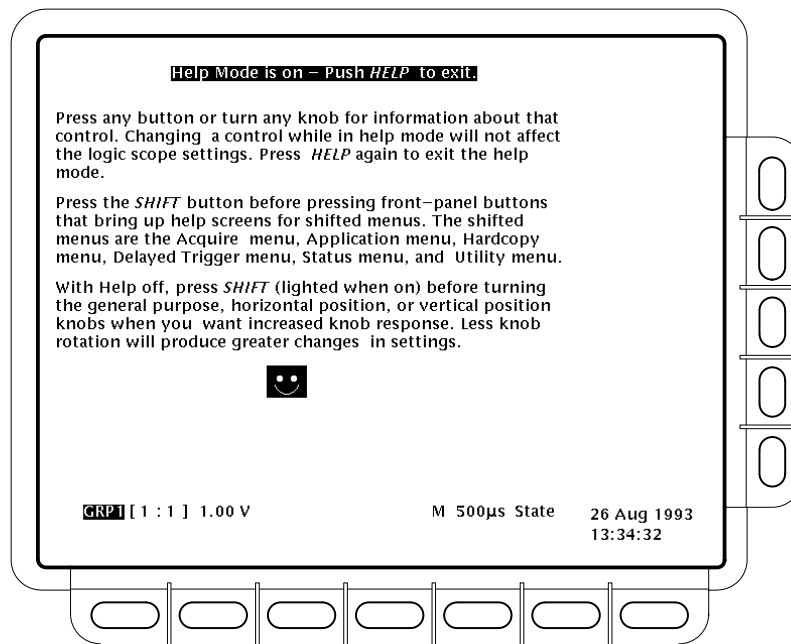

Figure 3-76: Initial Help Screen

## To Display Help on Menu Items

To display help text on a menu item, display the menu that includes the item before you enter help mode.

In help mode, you may press a menu button that displays help text referring to a menu it displays when pressed with help off. To see help text on the undisplayed menu, do the following steps.

1. Press **HELP** to exit help mode. Note the menu is still displayed.
2. Press the menu button that referred to the undisplayed menu. The logic scope will display the referenced menu items.
3. Press **HELP** to reenter help mode. Press any of the menu items (which now appear in the menu) to display help on that item.

# Viewing Status

The TLS 216 Logic Scope provides a status menu for displaying information about the logic scope state.

## To Display Status

To operate the Status menu, press **SHIFT** → **STATUS** → **System**, **Waveform**, **Trigger**, or **Banner** (main).

*System* displays information about the Display, I/O, Horizontal, Zoom, Acquisition, Measure, and Hardcopy systems (Figure 3-77). This display also tells you the firmware version.

*Waveform* displays information about the various waveforms, including live, math, and reference.

*Trigger* displays parameter information about the triggers.

*Banner* displays the instrument name and firmware date.

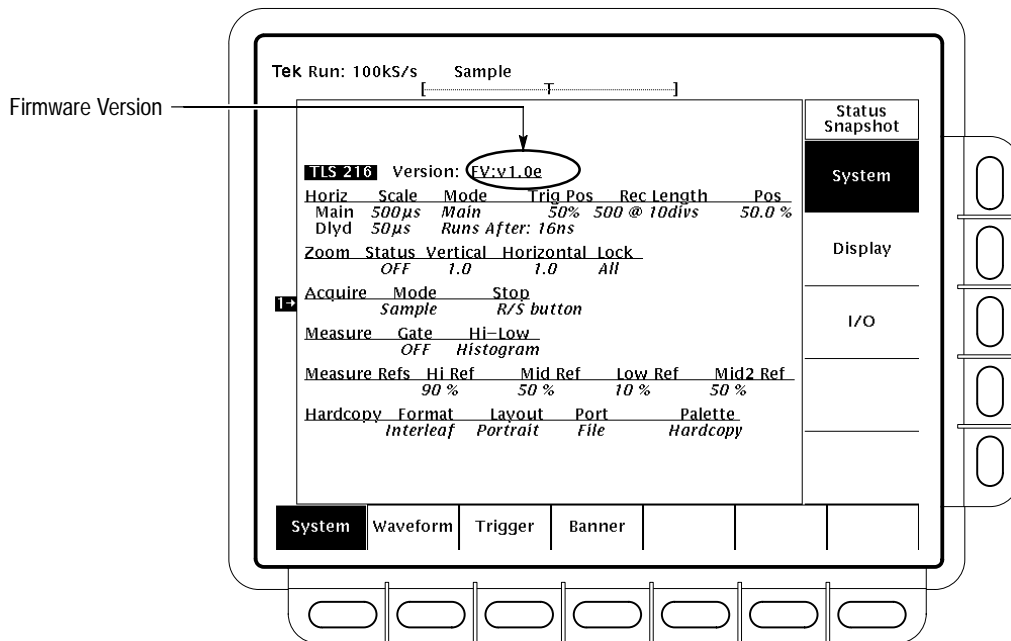

Figure 3-77: Status Menu — System



# Zooming on Waveforms

The TLS 216 Logic Scope can expand or compress (zoom in or out) on a waveform group without changing the acquisition parameters (sample rate, record length, and so on). This article describes how to use zoom and how it interacts with the selected waveform group. It also describes how interpolation can affect zoom.

## To Understand Zoom

To help you use zoom effectively, consider how it operates on groups and how it is affected by interpolation.

### Using with Groups

When zooming vertically, the logic scope expands or contracts the *selected* group only. You must set the group display mode to Analog in the Group Menu to see the selected group zoomed on screen. If in BusForm or Timing Diagram display mode, the vertical zoom factor will change if adjusted, but the group amplitude will not change size on screen until you switch to Analog mode.

When zooming horizontally, zoom expands either the selected group, all live groups, or all live and reference groups depending on the setting for Horizontal Lock in the Zoom menu. Zoom expands on screen for all three group display modes.

When zooming horizontally or vertically, zoom expands or contracts the group by the zoom factor in 1X, 2X, and 5X steps.

### Interpolation and Zoom

When you zoom on a group, you expand a portion of it. If the expansion requires the logic scope to show more points for that portion than it has acquired, it interpolates.

The method the logic scope uses to interpolate, linear or  $\sin(x)/x$ , can affect the way zoom displays your waveform. If you selected  $\sin(x)/x$  (the default), it may introduce some overshoot or undershoot to the waveform edges. If that happens, change the interpolation method to linear, following the instructions on page 3–177.

To read about the two interpolation methods, see *Interpolation* on page 2–20. To differentiate between the real and interpolated samples, set the display style to **Intensified Samples**. (See *To Choose a Display Style* on page 3–38.)



## To Determine the Zoom Factors

To quickly determine the zoom factor of a zoomed group, select it and check the zoom readout. It shows the selected group by number, along with the horizontal and vertical expansion factors.

The zoom readout appears at the top of the display when zoom is on. See Figure 3-78 on page 3-177.

## To Zoom on Waveforms

To use Zoom, select a waveform group, turn zoom on, and magnify it using the vertical and horizontal scale knobs.

1. Press any of group selection buttons **GROUP 1** through **GROUP 4** on the right side of the display. (Press **SHIFT** first when selecting any of **GROUP 5** through **GROUP 8**).
2. Press **GROUP MENU** → **Display** (main) → **Analog** (side) if you wish to zoom the selected group vertically.
3. Press **ZOOM**.
4. Press **ON** (side) in the zoom menu. The **ZOOM** front-panel button should light up.
5. Adjust the vertical zoom factor using the vertical **SCALE** knob. Adjust the vertical position of the zoomed group using the vertical **POSITION** knob.
6. Adjust the horizontal zoom factor using the horizontal **SCALE** knob. Adjust the vertical position of the zoomed group using the vertical **POSITION** knob.

Depending on the selection for Horizontal Lock in the side menu, zoom affects the displayed groups as follows:

*Group* — only the group currently selected can be magnified and positioned horizontally (Figure 3-78).

*Live* — all “live” (as opposed to reference) groups can be magnified and positioned horizontally at the same time. (Groups of input channels are defined as live; saved reference groups are not live.) If a *reference* group is selected and Horizontal Lock set to Live, only the selected reference group is magnified and positioned.

*All* — all groups displayed (live and reference) can be magnified and positioned horizontally at the same time.

7. Press **Horizontal Lock** (side) to choose which waveform groups to zoom horizontally. Repeated press **Horizontal Lock** (side) to cycle through the three choices.

**NOTE.** Although zoom must be turned on to control which waveforms zoom affects, the setting for *Horizontal Lock* affects which waveforms the horizontal control positions whether zoom is on or off. The rules for the three settings are as is listed in step 6.

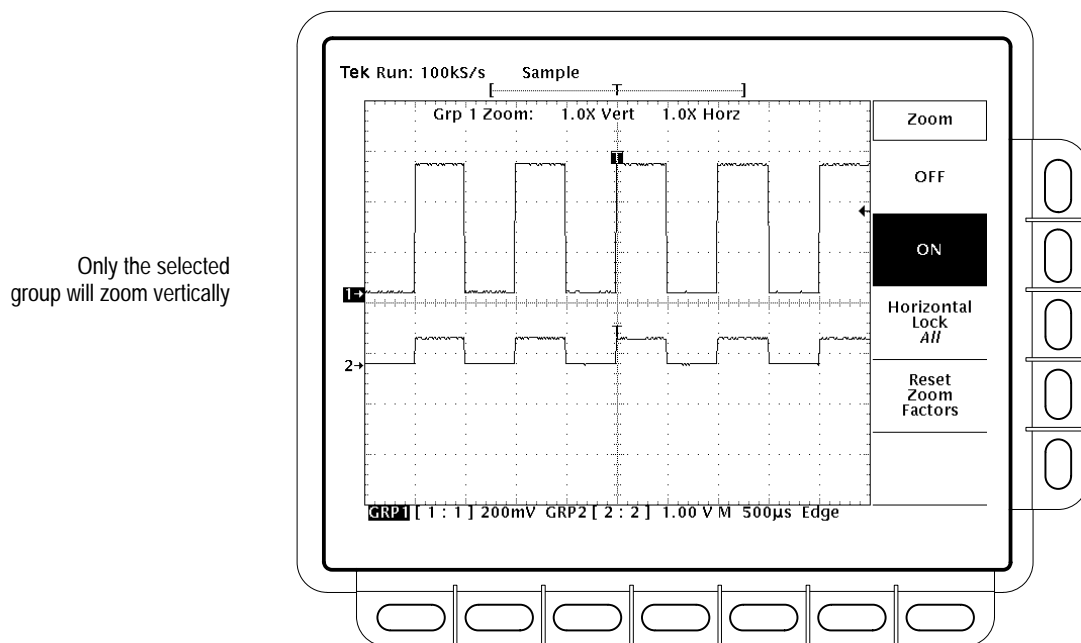

Figure 3-78: Zoom Mode with Horizontal Lock Set to *All*

## To Set the Interpolation Method

To change the interpolation method used, press **DISPLAY** → **Filter** (main) → **Sin(x)/x Interpolation** or **Linear Interpolation** (side).

The interpolation method set is used for all acquisition displays, whether zoomed or not.

## To Reset Zoom

To reset all zoom factors to their defaults (Table 3–12), press **ZOOM → Reset Zoom Factors** (side).

**Table 3–12: Zoom Defaults**

Parameter	Setting
Zoom Vertical Position	0
Zoom Vertical Gain	1X
Zoom Horizontal Position	Tracking Horizontal Position
Zoom Horizontal Gain	1X

To return to normal (non-zoom operation, press **ZOOM → Off** (side).

## To Find More Information

See *Acquisition*, on page 2–19.

See *Choosing a Group Display Mode*, on page 3–35.



# Appendix A: Options and Accessories

This section describes the various options as well as the standard and optional accessories that are available for the TLS Logic Scope.

## Options

The following options are available:

### Options A1–A5: International Power Cords

Besides the standard North American, 110 V, 60 Hz power cord, Tektronix ships any of five alternate power cord configurations with the logic scope when ordered by the customer.

**Table A-1: International Power Cords**

Option	Power Cord
A1	Universal European — 220 V, 50 Hz
A2	UK — 240 V, 50 Hz
A3	Australian — 240 V, 50 Hz
A4	North American — 240 V, 60 Hz
A5	Switzerland — 220 V, 50 Hz

### Option B1: Service Manual

When Option B1 is ordered, Tektronix ships a service manual with the logic scope.

### Option 1B: Coaxial Adapter Set

With this option, Tektronix ships a set of 16 coaxial adapters. These adapters provide a 50  $\Omega$  SMA connection to the instrument.

### Option 1S: Substitute Coaxial Adapter Set

With this option, Tektronix ships a set of 16 coaxial adapters in place of the 16 standard probes. These adapters provide a 50  $\Omega$  SMA connection to the instrument.

### Option 1K: K420 Instrument Cart

With this option, Tektronix ships the K420 Instrument Cart. The cart can help you transport the logic scope around many lab environments.

### Option 24

With this option, Tektronix ships four additional P6240 probes.

**Warranty-Plus Service Options**

The following options add to the services available with the standard warranty. (The standard warranty appears following the title page in this manual.)

- Option M2. When Option M2 is ordered, Tektronix adds two years of repair service to the standard warranty.
- Option M3. When Option M3 is ordered, Tektronix adds four logic scope calibrations (one per year in the second through fifth years of service) to the Option M2 service.
- Option M8. When Option M8 is ordered, Tektronix adds four logic scope calibrations (one per year in the second through fifth years of service) to the standard warranty.

**Option 1R: Rackmounted Logic Scope**

Tektronix ships the Logic Scope, when ordered with Option 1R, configured for installation in a 19 inch wide instrument rack. Customers with instruments not configured for rackmounting can order a rackmount kit (016-1236-00 for field conversions).

Instructions for rackmounting the Logic Scope are shipped with the option 1R.

**Option 3I or 3P: Phaser 140 Color Printer**

With this option, Tektronix ships a Tektronix Phaser 140, 360 dpi, inkjet, color printer. Order option 3I for 220V use or option 3P for 110 V use.

**Option 95**

With this option, Tektronix ships a Calibration Data Report with the product.

**Option 96**

With this option, Tektronix ships a Certificate of Calibration. This certificate states that this instrument meets or exceeds all warranted specifications. It further states that this instrument has been calibrated using standards and instruments whose accuracies are traceable to the National Institute of Standards and Technology, an accepted value of a natural physical constant, or a ratio calibration technique. The calibration is in compliance with US MIL-STD-45662A. This option includes a test data report for the oscilloscope.

**Standard Accessories**

The following standard accessories are included with the logic scope:

**Table A-2: Standard Accessories**

Accessory	Part Number
User Manual	070-8834-XX
Programmer Manual	070-8835-XX

**Table A-2: Standard Accessories (Cont.)**

<b>Accessory</b>	<b>Part Number</b>
Reference	070-8833-XX
Performance Verification and Specifications Technical Reference	070-8832-XX
Front Cover	200-3696-00
U.S. Power Cord	161-0230-01
Accessory Pouch	016-1268-00
Probes, 2.5 pf FET (Qty. 16)	P6240 (single unit)
Y-Leadset (Qty. 2 pkgs. of 10) (Used with probe)	020-2008-00
SMT KlipChip (Qty. 3 pkgs. of 12) (Used with probe)	020-1386-01
One-to-Two Adapter (Qty. 2) (Used with probe)	013-0280-00
Hand-Held Adapter (Qty. 2) (Used with probe)	013-0281-00
Marker Tags (Qty. 3) (Used with probe)	334-8632-00
Eight-Cable Loom (Qty. 6) (Used with probe)	352-1039-01
Logic Scope to Coax Adapter (Qty. 2)	013-0282-00

## Optional Accessories

You can also order the following optional accessories:

**Table A-3: Optional Accessories**

<b>Accessory</b>	<b>Part Number</b>
TLS Service Manual	070-8831-XX
Plotter (GPIB and Centronics Standard)	HC100
Instrument Cart	K420
Rack Mount Kit (for field conversion)	016-1236-00
Oscilloscope Camera	C9
Oscilloscope Camera Adapter	016-1154-00
Soft-Sided Carrying Case	016-0909-01
Transit Case	016-1135-00
GPIB Cable (1 meter)	012-0991-01
GPIB Cable (2 meter)	012-0991-00
Logic Scope to Coax Adapter	013-0282-00
FlexLead Adapter (Used with probe)	PJ25x25
16-Pin SOIC Adapter (Used with probe)	013-0242-00

**Table A-3: Optional Accessories (Cont.)**

Accessory	Part Number
24-Pin DIP Adapter (Used with probe)	003-0823-00
68-Pin PLCC Adapter (Used with probe)	013-0250-00

**Accessory Software**

The following optional accessories are Tektronix software products recommended for use with your logic scope:

**Table A-4: Accessory Software**

Software	Part Number
EZ-Test Program Generator	S45F030
Wavewriter: AWG and waveform creation	S3FT400
TekTMS: Test management system	S3FT001
LabWindows	S3FG910

**Warranty Information**

Check for the full warranty statements for this product, the probes, and the products listed above on the page or pages immediately following the title and copyright pages in the manual for each product.



# Appendix B: Algorithms

The TLS 216 Logic Scope can take 28 automatic measurements. By knowing how the instrument makes these calculations, you may better understand how to use your instrument and how to interpret your results.

## Measurement Variables

The logic scope uses a variety of variables in its calculations. These include:

**High, Low** *High* is the value used as the 100% level in measurements such as fall time and rise time. For example, if you request the 10% to 90% rise time, then the logic scope will calculate 10% and 90% as percentages with *High* representing 100%.

*Low* is the value used as the 0% level in measurements such as fall time and rise time.

The exact meaning of *High* and *Low* depends on which of two calculation methods you choose from the Measure menu's **High-Low Setup** item. These are *Min-max* and *Histogram*.

**Min-Max Method** defines the 0% and the 100% waveform levels as the lowest amplitude (most negative) and the highest amplitude (most positive) samples. The min-max method is useful for measuring frequency, width, and period for many types of signals. Min-max is sensitive to waveform ringing and spikes, however, and does not always measure accurately rise time, fall time, overshoot, and undershoot.

The min-max method calculates the High and Low values as follows:

$$High = Max \quad \text{and} \quad Low = Min$$

**Histogram Method** attempts to find the highest density of points above and below the waveform midpoint. It attempts to ignore ringing and spikes when determining the 0% and 100% levels. This method works well when measuring square waves and pulse waveforms.

The logic scope calculates the histogram-based *High* and *Low* values as follows:

1. It makes a histogram of the record with one bin for each digitizing level (256 total).
2. It splits the histogram into two sections at the halfway point between *Min* and *Max* (also called *Mid*).

3. The level with the most points in the upper histogram is the *High* value, and the level with the most points in the lower histogram is the *Low* value. (Choose the levels where the histograms peak for *High* and *Low*.)

If *Mid* gives the largest peak value within the upper or lower histogram, then return the *Mid* value for both *High* and *Low* (this is probably a very low amplitude waveform).

If more than one histogram level (bin) has the maximum value, choose the bin farthest from *Mid*.

This algorithm does not work well for two-level waveforms with greater than about 100% overshoot.

#### HighRef, MidRef, LowRef, Mid2Ref

The user sets the various reference levels, through the **Reference Level** selection of the Measure menu. They include:

**HighRef** defines the waveform high reference level. Used in fall time and rise time calculations. Typically set to 90%. You can set it from 0% to 100%.

**MidRef** defines the waveform middle reference level. Typically set to 50%. You can set it from 0% to 100%.

**LowRef** defines the waveform low reference level. Used in fall and rise time calculations. Typically set to 10%. You can set it from 0% to 100%.

**Mid2Ref** defines the middle reference level for a second waveform (or the second middle reference of the same waveform). Used in delay time calculations. Typically set to 50%. You can set it from 0% to 100%.

#### Other Variables

The logic scope also measures several values itself that it uses to help calculate measurements.

**RecordLength** is the number of data points in the time base. You set it with the Horizontal menu **Record Length** item.

**Start** is the location of the start of the measurement zone (X-value). It is 0.0 samples unless you are making a gated measurement. When you use gated measurements, it is the location of the left vertical cursor.

**End** is the location of the end of the measurement zone (X-value). It is (*RecordLength* – 1.0) samples unless you are making a gated measurement. When you use gated measurements, it is the location of the right vertical cursor.

**Hysteresis** is a band comprising 10% of the waveform amplitude. It is used in *MCross1*, *MCross2*, and *MCross3* calculations.

For example, once a crossing has been measured in a negative direction, the waveform data must fall below 10% of the amplitude from the *MidRef* point before the measurement system is armed and ready for a positive crossing. Similarly, after a positive *MidRef* crossing, waveform data must go above 10% of the amplitude before a negative crossing can be measured. Hysteresis is useful when you are measuring noisy signals, because it allows the logic scope to ignore minor fluctuations in the signal.

## MCross Calculations

**MCross1, MCross2, and MCross3** refer to the first, second, and third *MidRef* cross times, respectively. See Figure B-1.

The polarity of the crossings does not matter for these variables, but the crossings alternate in polarity; that is, *MCross1* could be a positive or negative crossing, but if *MCross1* is a positive crossing, *MCross2* will be a negative crossing.

The logic scope calculates these values as follows:

1. Find the first *MidRefCrossing* in the waveform record or the gated region. This is *MCross1*.
2. Continuing from *MCross1*, find the next *MidRefCrossing* in the waveform record (or the gated region) of the opposite polarity of *MCross1*. This is *MCross2*.
3. Continuing from *MCross2*, find the next *MidRefCrossing* in the waveform record (or the gated region) of the same polarity as *MCross1*. This is *MCross3*.

**MCross1Polarity** is the polarity of first crossing (no default). It can be rising or falling.

**StartCycle** is the starting time for cycle measurements. It is a floating-point number with values between 0.0 and (*RecordLength* – 1.0), inclusive.

$$\text{StartCycle} = \text{MCross1}$$

**EndCycle** is the ending time for cycle measurements. It is a floating-point number with values between 0.0 and (*RecordLength* – 1.0), inclusive.

$$\text{EndCycle} = \text{MCross3}$$

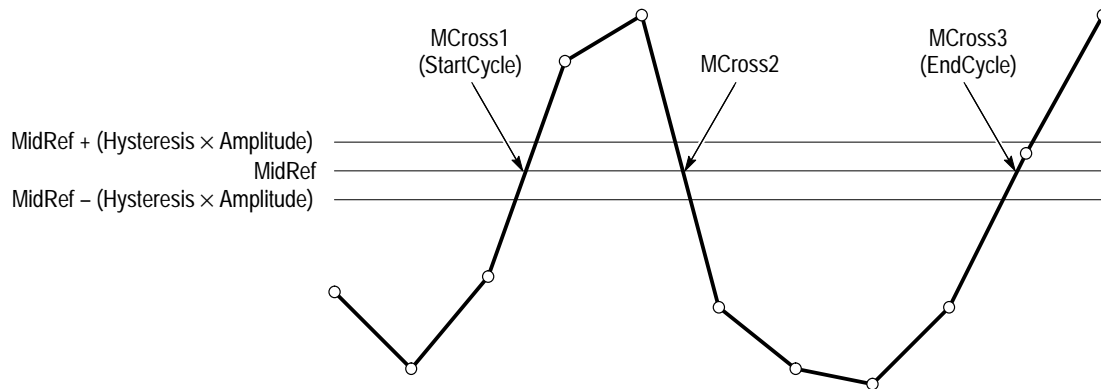

Figure B-1: MCross Calculations

Waveform[<0.0 ... RecordLength-1.0>] holds the acquired data.

**TPOS** is the location of the sample just before the trigger point (the time reference zero sample). In other terms, it contains the domain reference location. This location is where time = 0.

**TSOFF** is the offset between *TPOS* and the actual trigger point. In other words, it is the trigger sample offset. Values range between 0.0 and 1.0 samples. This value is determined by the instrument when it receives a trigger. The actual zero reference (trigger) location in the measurement record is at (*TPOS*+*TSOFF*).

## Measurement Algorithms

The automated measurements are defined and calculated as follows.

### Amplitude

The difference between the high level and low level of a waveform. The logic scope determines the high and low levels using the method set in the Measure menu: **Min-Max** or **Histogram**.



$$Amplitude = High - Low$$

### Area

The arithmetic area for one waveform. Remember that one waveform is not necessarily equal to one cycle. For cyclical data you may prefer to use the cycle area rather than the arithmetic area.



if *Start* = *End* then return the (interpolated) value at *Start*.

Otherwise,

$$Area = \int_{Start}^{End} Waveform(t) dt$$

For details of the integration algorithm, see page B-12.

### Cycle Area

Amplitude (voltage) measurement. The area over one waveform cycle. For non-cyclical data, you might prefer to use the Area measurement.



If  $StartCycle = EndCycle$  then return the (interpolated) value at  $StartCycle$ .

$$CycleMean = \int_{StartCycle}^{EndCycle} Waveform(t) dt$$

For details of the integration algorithm, see page B-12.

### Burst Width

Timing measurement. The duration of a burst.



1. Find  $MCross1$  on the waveform. This is  $MCrossStart$ .
2. Find the last  $MCross$  (begin the search at  $EndCycle$  and search toward  $StartCycle$ ). This crossing is  $MCrossStop$ .  $MCrossStop$  could be a different value from  $MCross1$ .
3. Compute  $BurstWidth = MCrossStop - MCrossStart$

### Cycle Mean

Amplitude (voltage) measurement. The mean over one waveform cycle. For non-cyclical data, you might prefer to use the Mean measurement.



If  $StartCycle = EndCycle$  then return the (interpolated) value at  $StartCycle$ .

$$CycleMean = \frac{\int_{StartCycle}^{EndCycle} Waveform(t) dt}{(EndCycle - StartCycle) \times SampleInterval}$$

For details of the integration algorithm, see page B-12.

### Cycle RMS

The true Root Mean Square voltage over one cycle.



If  $StartCycle = EndCycle$  then  $CycleRMS = Waveform[Start]$ .

Otherwise,

$$CycleRMS = \sqrt{\frac{\int_{StartCycle}^{EndCycle} (Waveform(t))^2 dt}{(EndCycle - StartCycle) \times SampleInterval}}$$

For details of the integration algorithm, see page B–12.

**Delay** Timing measurement. The amount of time between the *MidRef* and *Mid2Ref* crossings of two different traces, or two different places on the same trace.



Delay measurements are actually a group of measurements. To get a specific delay measurement, you must specify the target and reference crossing polarities, and the reference search direction.

*Delay* = the time from one *MidRef* crossing on the source waveform to the *Mid2Ref* crossing on the second waveform.

Delay is not available in the Snapshot display.

**Fall Time** Timing measurement. The time taken for the falling edge of a pulse to drop from a *HighRef* value (default = 90%) to a *LowRef* value (default = 10%).



Figure B–2 shows a falling edge with the two crossings necessary to calculate a Fall measurement.

1. Searching from *Start* to *End*, find the first sample in the measurement zone greater than *HighRef*.
2. From this sample, continue the search to find the first (negative) crossing of *HighRef*. The time of this crossing is *THF*. (Use linear interpolation if necessary.)
3. From *THF*, continue the search, looking for a crossing of *LowRef*. Update *THF* if subsequent *HighRef* crossings are found. When a *LowRef* crossing is found, it becomes *TLF*. (Use linear interpolation if necessary.)
4.  $FallTime = TLF - THF$

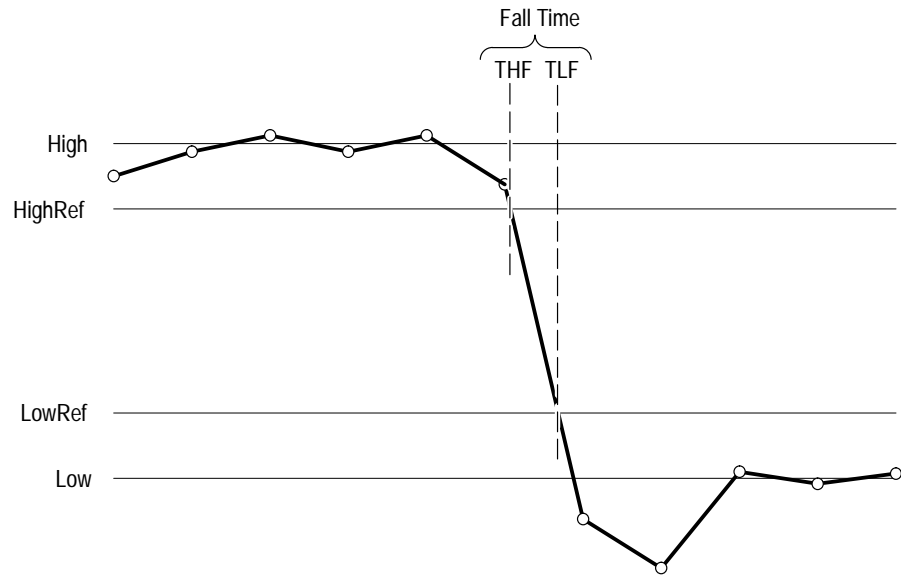

Figure B-2: Fall Time

**Frequency**

Timing measurement. The reciprocal of the period. Measured in Hertz (Hz) where 1 Hz = 1 cycle per second.



If *Period* = 0 or is otherwise bad, return an error.

$$\text{Frequency} = 1/\text{Period}$$

**High**

100% (highest) voltage reference value. (See “High, Low” earlier in this section)



Using the min-max measurement technique:

$$\text{High} = \text{Max}$$

**Hold**

Timing measurement. The time between the first transition to an illegal state for all waveforms in a group (except the clock) and the clocking edge of the waveform in the channel specified as the clock. The clock can be any channel. It does not have to be included in the measured group. Hold measurements define “illegal state” as any level between the low reference level and the high reference level set in the Measure menu.

Setup is determined in the following manner (see Figure B-3):

1. The logic scope finds the first *LowRef* crossing and the first *HighRef* crossing for each waveform in the selected group.

2. The logic scope determines which crossing out of all the first crossings found in step 1 occurred first for the waveform group. The crossing is called *CrossFirst* and might be either a *LowRef* or a *HighRef* crossing.
3. The logic scope determines the first *MidRef* crossing for the selected clock edge. This crossing is called *MCrossClock*
4. The logic scope calculates the hold time according to the following equation:

$$Hold = CrossFirst - MCrossClock$$

Positive hold times indicate that the clock edge occurred *before* the first transition in the waveform group. Negative hold times indicate that the clock edge occurred *after* the first transition.

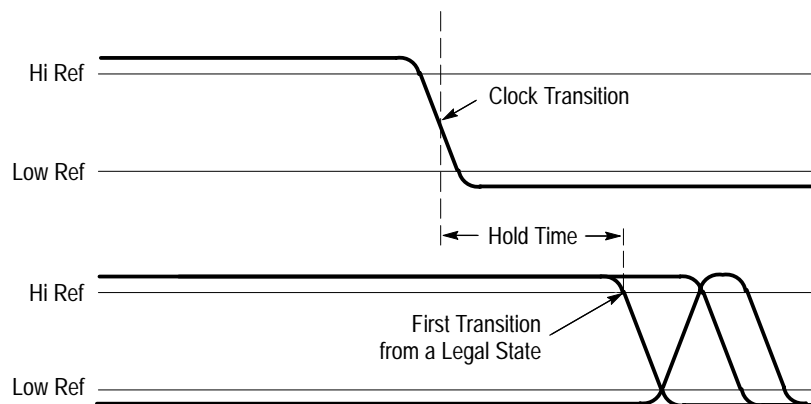

**Figure B-3: Hold Time**

**Low** 0% (lowest) voltage reference value calculated. (See “High, Low” earlier in this section)



Using the min-max measurement technique:

$$Low = Min$$

**Maximum** Amplitude (voltage) measurement. The maximum voltage. Typically the most positive peak voltage.



Examine all *Waveform[ ]* samples from *Start* to *End* inclusive and set *Max* equal to the greatest magnitude *Waveform[ ]* value found.



 **Mean** The arithmetic mean for one waveform. Remember that one waveform is not necessarily equal to one cycle. For cyclical data you may prefer to use the cycle mean rather than the arithmetic mean.

if  $Start = End$  then return the (interpolated) value at  $Start$ .

Otherwise,

$$Mean = \frac{\int_{Start}^{End} Waveform(t) dt}{(End - Start) \times SampleInterval}$$

For details of the integration algorithm, see page B-12.

 **Minimum** Amplitude (voltage) measurement. The minimum amplitude. Typically the most negative peak voltage.

Examine all  $Waveform[ ]$  samples from  $Start$  to  $End$  inclusive and set  $Min$  equal to the smallest magnitude  $Waveform[ ]$  value found.

**Negative Duty Cycle** Timing measurement. The ratio of the negative pulse width to the signal period expressed as a percentage.



$NegativeWidth$  is defined in **Negative Width**, below.

If  $Period = 0$  or undefined then return an error.

$$NegativeDutyCycle = \frac{NegativeWidth}{Period} \times 100\%$$

**Negative Overshoot** Amplitude (voltage) measurement.



$$NegativeOvershoot = \frac{Low - Min}{Amplitude} \times 100\%$$

Note that this value should never be negative (unless High or Low are set out-of-range).

**Negative Width** Timing measurement. The distance (time) between  $MidRef$  (default = 50%) amplitude points of a negative pulse.



If  $MCross1Polarity = '-'$

then

$$NegativeWidth = (MCross2 - MCross1)$$

else

$$\text{NegativeWidth} = (\text{MCross3} - \text{MCross2})$$

**Peak to Peak**

Amplitude measurement. The absolute difference between the maximum and minimum amplitude.



$$\text{PeaktoPeak} = \text{Max} - \text{Min}$$

**Period**

Timing measurement. Time taken for one complete signal cycle. The reciprocal of frequency. Measured in seconds.



$$\text{Period} = \text{MCross3} - \text{MCross1}$$

**Phase**



Timing measurement. The amount of phase shift, expressed in degrees of the target waveform cycle, between the *MidRef* crossings of two different waveforms. Waveforms measured should be of the same frequency or one waveform should be a harmonic of the other.

Phase is a dual waveform measurement; that is, it is measured from a target waveform to a reference waveform. To get a specific phase measurement, you must specify the target and reference sources.

Phase is determined in the following manner:

1. The first *MidRefCrossing* (*MCross1Target*) and third (*MCross3*) in the source (target) waveform are found.
2. The period of the target waveform is calculated (see “Period” above).
3. The first *MidRefCrossing* (*MCross1Ref*) in the reference waveform crossing in the same direction (polarity) as that found *MCross1Target* for the target waveform is found.
4. The phase is determined by the following:

$$\text{Phase} = \frac{\text{MCross1Ref} - \text{MCross1Target}}{\text{Period}} \times 360$$

If the target waveform leads the reference waveform, phase is positive; if it lags, negative.

Phase is not available in the Snapshot display.

**Positive Duty Cycle**

Timing measurement. The ratio of the positive pulse width to the signal period, expressed as a percentage.



*PositiveWidth* is defined in **Positive Width**, following.

If *Period* = 0 or undefined then return an error.

$$PositiveDutyCycle = \frac{PositiveWidth}{Period} \times 100\%$$

### Positive Overshoot



Amplitude (voltage) measurement.

$$PositiveOvershoot = \frac{Max - High}{Amplitude} \times 100\%$$

Note that this value should never be negative.

### Positive Width



Timing measurement. The distance (time) between *MidRef* (default = 50%) amplitude points of a positive pulse.

If *MCross1Polarity* = '+'

then

$$PositiveWidth = (MCross2 - MCross1)$$

else

$$PositiveWidth = (MCross3 - MCross2)$$

### Rise Time



Timing measurement. Time taken for the leading edge of a pulse to rise from a *LowRef* value (default = 10%) to a *HighRef* value (default = 90%).

Figure B-4 shows a rising edge with the two crossings necessary to calculate a Rise Time measurement.

1. Searching from *Start* to *End*, find the first sample in the measurement zone less than *LowRef*.
2. From this sample, continue the search to find the first (positive) crossing of *LowRef*. The time of this crossing is the low rise time or *TLR*. (Use linear interpolation if necessary.)
3. From *TLR*, continue the search, looking for a crossing of *HighRef*. Update *TLR* if subsequent *LowRef* crossings are found. If a *HighRef* crossing is found, it becomes the high rise time or *THR*. (Use linear interpolation if necessary.)
4.  $RiseTime = THR - TLR$

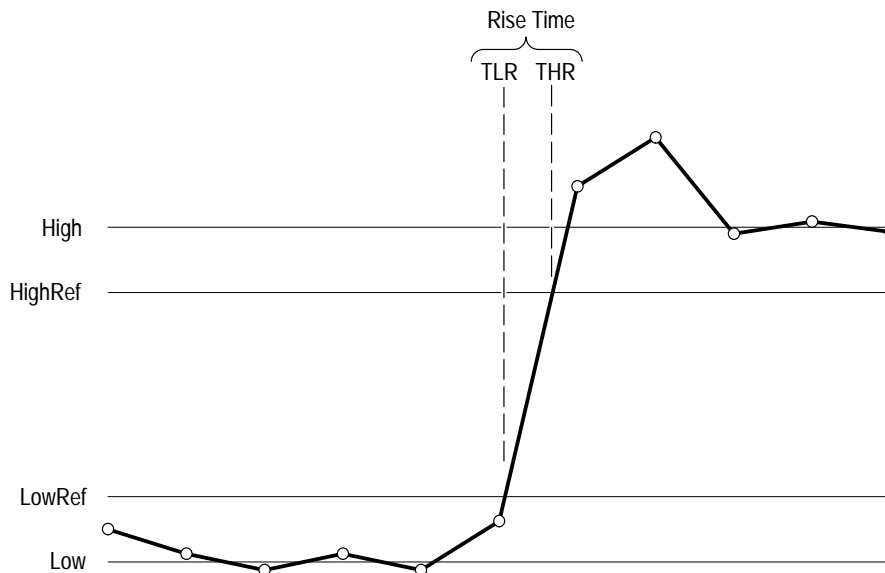

Figure B-4: Rise Time

**RMS:** Amplitude (voltage) measurement. The true Root Mean Square voltage.



If  $Start = End$  then  $RMS =$  the (interpolated) value at  $Waveform[Start]$ .

Otherwise,

$$RMS = \sqrt{\frac{\int_{Start}^{End} (Waveform(t))^2 dt}{(End - Start) \times SampleInterval}}$$

For details of the integration algorithm, see below:

**Integration Algorithm**

The integration algorithm used by the logic scope is as follows:

$$\int_A^B W(t)dt \text{ is approximated by } \int_A^B \hat{W}(t)dt \text{ where:}$$

$W(t)$  is the sampled waveform

$\hat{W}(t)$  is the continuous function obtained by linear interpolation of  $W(t)$

$A$  and  $B$  are numbers between 0.0 and  $RecordLength-1.0$

If  $A$  and  $B$  are integers, then:

$$\int_A^B \hat{W}(t) dt = s \times \sum_{i=A}^{B-1} \frac{W(i) + W(i+1)}{2}$$

where  $s$  is the sample interval.

Similarly,

$$\int_A^B (W(t))^2 dt \text{ is approximated by } \int_A^B (\hat{W}(t))^2 dt \text{ where:}$$

$W(t)$  is the sampled waveform

$\hat{W}(t)$  is the continuous function obtained by linear interpolation of  $W(t)$

$A$  and  $B$  are numbers between 0.0 and  $RecordLength-1.0$

If  $A$  and  $B$  are integers, then:

$$\int_A^B (\hat{W}(t))^2 dt = s \times \sum_{i=A}^{B-1} \frac{(W(i))^2 + W(i) \times W(i+1) + (W(i+1))^2}{3}$$

where  $s$  is the sample interval.

**Setup** Timing measurement. The time between the last transition to a legal state for all waveforms in a group (except the clock) and the clocking edge of the waveform specified as the clock. The clock can be any channel. It does not have to be included in the measured group. Setup measurements define “legal state” as a level either below the low reference level or above the high reference level that is set in the Measure menu.

Setup is determined in the following manner (see Figure B-5):

1. The logic scope finds the last *LowRef* crossing and the last *HighRef* crossing for each waveform in the selected group.
2. The logic scope determines which crossing out of all the last crossings found in step 1 occurred last for the waveform group. The crossing is called *CrossLast* and might be either a *LowRef* or a *HighRef* crossing.
3. The logic scope determines the first *MidRef* crossing for the selected clock edge. This crossing is called *MCrossClock*.

- The logic scope calculates the hold time according to the following equation:

$$\text{Setup} = \text{CrossLast} - \text{MCrossClock}$$

Positive setup times indicate that the clock edge occurred *after* the last transition of the waveform group. Negative setup times indicate that the clock edge occurred *before* the last transition.

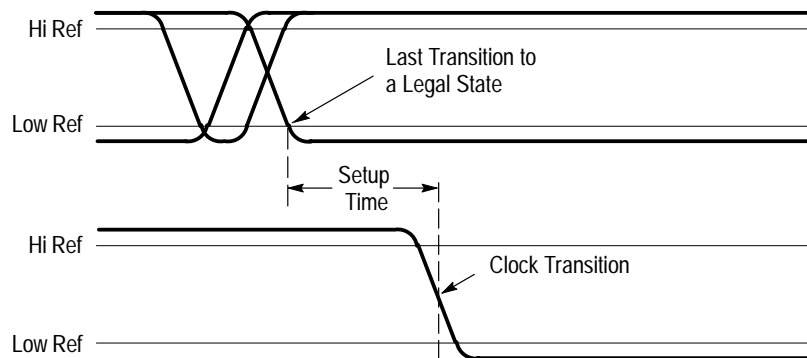

**Figure B-5: Setup Time**

**Skew** Timing measurement. The time between the first transition to an illegal state for all waveforms in a group and last transition to a legal state for the same waveforms. Skew measurements define “legal state” as a level either below the low reference level or above the high reference level that is set in the Measure menu. They define an “illegal state” as a level between the the low and high reference levels.

Setup is determined in the following manner (see Figure B-6):

- The logic scope finds the first *LowRef* crossing and the first *HighRef* crossing for each waveform in the selected group.
- The logic scope finds the last *LowRef* crossing and the last *HighRef* crossing for each waveform in the selected group.
- The logic scope determines which crossing out of all the first crossings found in step 1 occurred first for the waveform group. The crossing is called *CrossFirst* and might be either a *LowRef* or a *HighRef* crossing.
- The logic scope determines which crossing out of all the last crossings found in step 2 occurred last for the waveform group. The crossing is called *CrossLast* and might be either a *LowRef* or a *HighRef* crossing.

5. The logic scope calculates the skew time according to the following equation:

$$\text{Skew} = \text{CrossLast} - \text{CrossFirst}$$

Skew times are positive since a last crossing always occurs after a first crossing by definition.

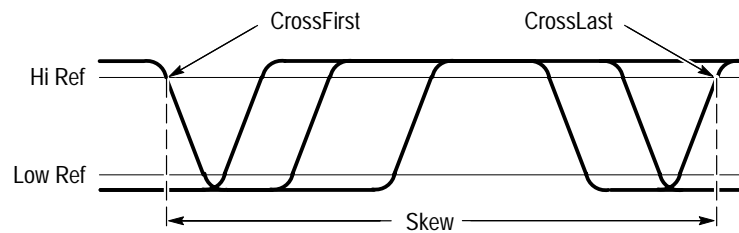

Figure B-6: Skew Time

## Measurements on Envelope Waveforms

Time measurements on envelope waveforms must be treated differently from time measurements on other waveforms, because envelope waveforms contain so many apparent crossings. Unless otherwise noted, envelope waveforms use either the minima or the maxima (but not both), determined in the following manner:

1. Step through the waveform from *Start* to *End* until the sample min and max pair *DO NOT* straddle *MidRef*.
2. If the pair > *MidRef*, use the minima, else use maxima.

If all pairs straddle *MidRef*, use maxima. See Figure B-7.

The Burst Width measurement always uses both maxima and minima to determine crossings.

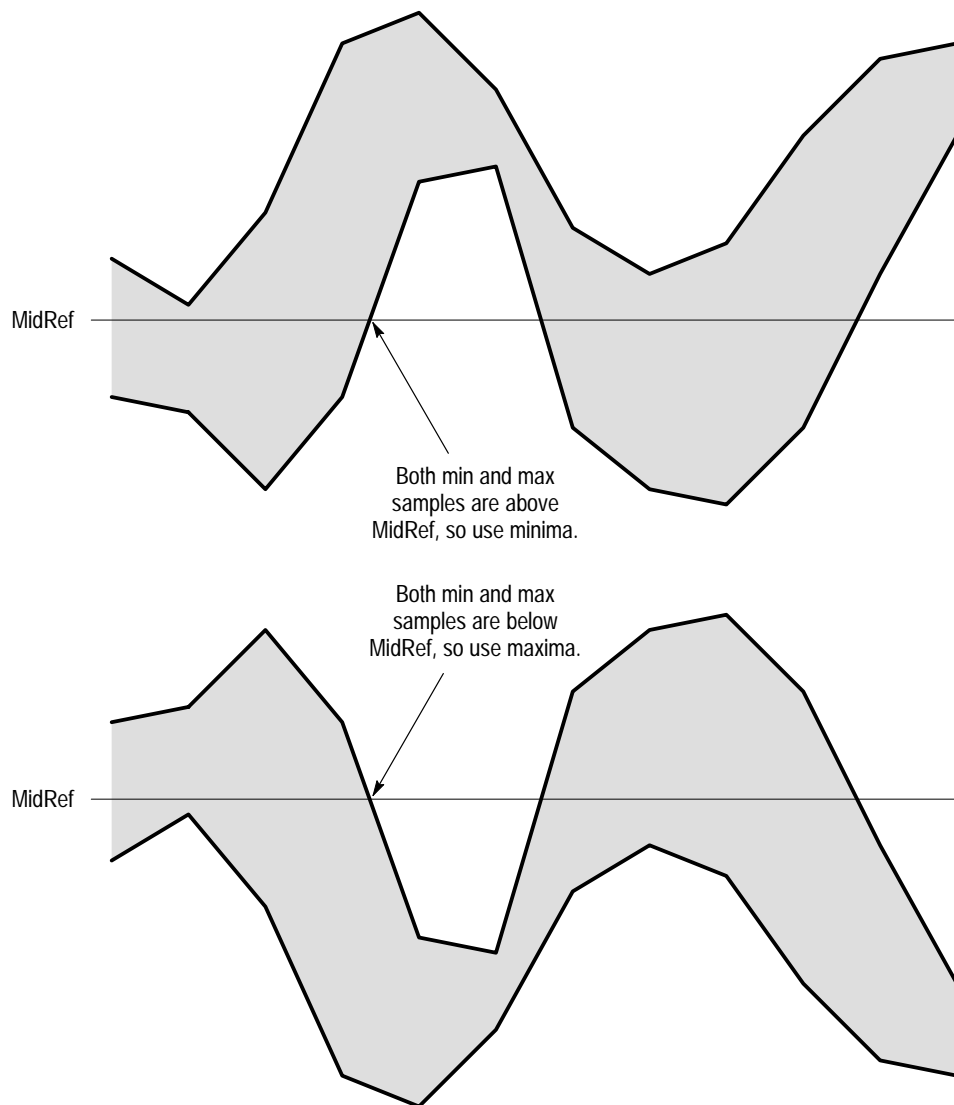

Figure B-7: Choosing Minima or Maxima to Use for Envelope Measurements

## Missing or Out-of-Range Samples

If some samples in the waveform are missing or off-scale, the measurements will linearly interpolate between known samples to make an “appropriate” guess as to the sample value. Missing samples at the ends of the measurement record will be assumed to have the value of the nearest known sample.

When samples are out of range, the measurement will give a warning to that effect (for example, “CLIPPING”) if the measurement could change by extending the measurement range slightly. The algorithms assume the samples recover from an overdrive condition instantaneously.



For example, if *MidRef* is set directly, then *MidRef* would not change even if samples were out of range. However, if *MidRef* was chosen using the % choice from the **Set Levels in % Units** selection of the Measure menu, then *MidRef* could give a “CLIPPING” warning.

---

**NOTE.** *When measurements are displayed using Snapshot, out of range warnings are NOT available. However, if you question the validity of any measurement in the snapshot display, you can select and display the measurement individually and then check for a warning message.*

---



## Appendix C: Packaging for Shipment

If you ship the logic scope, pack it in the original shipping carton and packing material. If the original packing material is not available, package the instrument as follows:

1. Obtain a corrugated cardboard shipping carton with inside dimensions at least 15 cm (6 in) taller, wider, and deeper than the logic scope. The shipping carton must be constructed of cardboard with 170 kg (375 pound) test strength.
2. If you are shipping the logic scope to a Tektronix field office for repair, attach a tag to the logic scope showing the instrument owner and address, the name of the person to contact about the instrument, the instrument type, and the serial number.
3. Wrap the logic scope with polyethylene sheeting or equivalent material to protect the finish.
4. Cushion the logic scope in the shipping carton by tightly packing dunnage or urethane foam on all sides between the carton and the logic scope. Allow 7.5 cm (3 in) on all sides, top, and bottom.
5. Seal the shipping carton with shipping tape or an industrial stapler.

---

**NOTE.** Do not ship the logic scope with a disk inside the disk drive. When the disk is inside the drive, the disk release button sticks out. The button becomes more exposed to possible damage during shipment when it sticks out.

---



# Appendix D: Factory Initialization Settings

Recalling the factory setup establishes the initialization settings shown in Table D–1 to provide you with a known default setup for the logic scope.

**Table D–1: Factory Initialization Defaults**

Control	Changed by Factory Init to
Acquire mode	Sample
Acquire stop after	RUN/STOP button only
Acquire # of averages	16
Acquire # of envelopes	10
Cursor H Bar 1 position	10% of graticule height (–3.2 divs from the center)
Cursor H Bar 2 position	90% of the graticule height (+3.2 divs from the center)
Cursor V Bar 1 position	10% of the record length
Cursor V Bar 2 position	90% of the record length
Cursor mode	Independent
Cursor function	Off
Cursor time units	Seconds
Delayed edge trigger level	0 V
Delayed edge trigger slope	Rising
Delayed edge trigger source	Channel 1
Delay trigger type	Edge
Delay time	16 ns
Delay events, triggerable after main	2
Delayed, delay by ...	Delay by Time
Delayed, time base mode	Delayed Runs After Main
Display clock	No Change
Display color – collision contrast	Off
Display color – map group colors	Reset to Factory Default Colors
Display color – map reference colors	Reset to Factory Default Colors
Display color – palette	Normal
Display color – palette colors	The colors of each palette are reset to factory hue, saturation, and lightness (HLS) values

**Table D-1: Factory Initialization Defaults (Cont.)**

<b>Control</b>	<b>Changed by Factory Init to</b>
Display color – persistence palette	Temperature
Display format	YT
Display graticule type	Full
Display intensity – text/graticule	60% (100%)
Display intensity – waveform	80% (100%)
Display interpolation filter	Sin(x)/x
Display style	Vectors
Display trigger bar style	Short
Display trigger “T”	On
Display variable persistence	500 ms
Edge trigger threshold (Main and Delayed)	0.0 V
Edge trigger slope (Main and Delayed)	Rising
Edge trigger source (Main and Delayed)	Channel 1
Group definition	First, last, and selected channel = Channel 1
Group selection	Group 1, containing Channel 1 only, is on; all other groups off
Group display mode	Analog
Group display thresholds	V <sub>high</sub> min = 2.00 V; V <sub>low</sub> , max = 800 mV
Group display height	1.0 Divs
Horizontal – delay trigger position	50%
Horizontal – delay trigger record length	500 points (10 divs)
Horizontal – delay time/division	50 $\mu$ s
Horizontal – main trigger position	50%
Horizontal – main trigger record length	500 points (10 divs)
Horizontal – main time/division	500 $\mu$ s
Horizontal – time base	Main only
Main trigger holdoff	0%
Main trigger mode	Auto
Main trigger type	Edge
Measure Delay to	Channel 1 (Ch1)
Measure Delay edges	Both rising and forward searching
Measure High-Low Setup	Histogram
Measure High Ref	90% and 0 V (units)

Table D-1: Factory Initialization Defaults (Cont.)

Control	Changed by Factory Init to
Measure Low Ref	10% and 0 V (units)
Measure Mid Ref	50% and 0 V (units)
Measure Mid2 Ref	50% and 0 V (units)
Measure Setup or Hold Clock Source	Channel 1 (Ch1)
Measure Setup or Hold Clock Edge	Rising and forward searching
Pattern, Sequence, and State trigger patterns (Main and Delayed)	Ch 1 = H (HIGH); all others = X (don't care)
Pattern and Sequence trigger time qualification type (Main and Delayed)	Time Limit
Pattern and Sequence trigger qualifier, time-limit qualified (Main and Delayed)	TRUE for > Time
Pattern and Sequence trigger time setting, time-limit qualified (Main and Delayed)	2.0 ns
Pattern and Sequence trigger upper limit time, time-range qualified (Main and Delayed)	2.0 ns
Pattern and Sequence trigger lower limit time, time-range qualified (Main and Delayed)	2.0 ns
Pattern and Sequence trigger qualifier, time range qualified (Main and Delayed)	In Range
Pattern, Sequence, and State trigger logic definition	AND
Pattern, Sequence, and State trigger thresholds (Main and Delayed)	Channels 1-16 = 0V; AUX = 1.5 V
Pulse glitch trigger polarity (Main and Delayed)	Positive
Pulse glitch trigger when qualifier (Main and Delayed)	True < Time
Pulse trigger class (Main and Delayed)	Glitch
Pulse trigger glitch width (Main and Delayed)	2.0 ns
Pulse trigger glitch width (Main and Delayed)	Upper limit = 2.0 ns
Pulse trigger threshold (Main and Delayed)	0.0 V
Pulse trigger source — Glitch and width (Main and Delayed)	Channel 1 (Ch1)
Pulse width trigger when qualifier (Main and Delayed)	Within limits
Pulse width upper limit (Main and Delayed)	2.0 ns
Pulse width lower limit (Main and Delayed)	2.0 ns
Pulse width trigger polarity (Main and Delayed)	Positive

**Table D-1: Factory Initialization Defaults (Cont.)**

<b>Control</b>	<b>Changed by Factory Init to</b>
Saved setups	No change
Saved waveforms	No change
Vertical bandwidth (all groups)	Full
Vertical offset (all groups)	0 V
Vertical position (all groups)	0 divs.
Vertical volts/div. (all groups)	100 mV/div.
Zoom horizontal (all groups)	1.0X
Zoom horizontal lock	All
Zoom horizontal position (all groups)	50% = 0.5 (the middle of the display)
Zoom state	Off
Zoom vertical (all groups)	1.0X
Zoom vertical position (all groups)	0 divs.





# Glossary

## Accuracy

The closeness of the indicated value to the true value.

## Acquisition

The process of sampling signals from input channels, digitizing the samples into data points, and assembling the data points into a waveform record. The waveform record is stored in memory. The trigger marks time zero in that process.

## Acquisition interval

The time duration of the waveform record divided by the record length. The logic scope displays one data point for every acquisition interval.

## Active cursor

The cursor that moves when you turn the general purpose knob. It is represented in the display by a solid line. The @ readout on the display shows the absolute value of the active cursor.

## Aliasing

A false representation of a signal due to insufficient sampling of high frequencies or fast transitions. A condition that occurs when a logic scope digitizes at an effective sampling rate that is too slow to reproduce the input signal. The waveform displayed on the logic scope may have a lower frequency than the actual input signal.



## Amplitude

The High waveform value less the Low waveform value.

## Analog Mode

A logic scope display mode that presents each waveform in a waveform group as the analog of its input signal. Use Analog mode to measure the actual response of a group of waveforms. Analog mode is the only group display mode that can be switched between a display of all the channels in a group (Analog All) and display of a single channel in a group (Analog Selected). (Also see *BusForm Mode*, *Timing Diagram Mode*, and *OFF Mode*.)



## AND

A logic (Boolean) function in which the output is true when and only when all the inputs are true. On the logic scope, that is a trigger logic pattern and state function.



## Area

Measurement of the waveform area taken over the entire waveform or the

gated region. Expressed in volt-seconds. Area above ground is positive; area below ground is negative.

**Automatic trigger mode**

A trigger mode that causes the logic scope to automatically acquire if triggerable events are not detected within a specified time period.

**Autoset**

A function of the logic scope that automatically produces a stable waveform of usable size. Autoset sets up front-panel controls based on the characteristics of the active waveform. A successful autoset will set the volts/div, time/div, and trigger level to produce a coherent and stable waveform display.

**Average acquisition mode**

In this mode, the logic scope acquires and displays a waveform that is the averaged result of several acquisitions. That reduces the apparent noise. The logic scope acquires data as in the sample mode and then averages it according to a specified number of averages.

**Bandwidth**

The highest frequency signal the logic scope can acquire with no more than 3 dB ( $\times .707$ ) attenuation of the original (reference) signal.

**Burst width**

A timing measurement of the duration of a burst.

**BusForm Mode**

A logic scope display mode that displays each waveform in the group as one or more of three digital logic levels defined as HIGH, LOW, or indefinite (between HIGH and LOW). The levels displayed depend on comparisons against two display threshold levels that you define. Use BusForm mode to measure the idealized response of waveforms with respect to defined thresholds. (See *Analog Mode*, *Timing Diagram Mode*, and *OFF Mode*.)

**Channel**

Input used for signal acquisition. The logic scope has 16 channels that it can display in up to eight groups. To be displayed, channels must be part of a waveform group. (See *Group*.)

**Group Reference Indicator**

In Analog display mode, the indicator on the left side of the display that points to the position around which the waveform contracts or expands when vertical scale is changed. This position is ground when offset is set to 0 V; otherwise, it is ground plus offset.

In BusForm display mode, the indicator points to the midpoint between the HIGH and LOW logic levels for all waveforms in the group.

In Timing-Diagram mode, the indicator points to the midpoint between the HIGH and LOW logic levels for the highest-numbered channel included in the group.

### **Coupling**

The association of two or more circuits or systems in such a way that power or information can be transferred from one to the other. The logic scope uses DC coupling only.

### **Cursors**

Paired markers that you can use to make measurements between two waveform locations. The logic scope displays the values (expressed in volts or time) of the position of the active cursor and the distance between the two cursors.



### **Cycle area**

A measurement of waveform area taken over one cycle. Expressed in volt-seconds. Area above ground is positive; area below ground is negative.



### **Cycle mean**

An amplitude (voltage) measurement of the arithmetic mean over one cycle.



### **Cycle RMS**

The true Root Mean Square voltage over one cycle.

### **DC coupling**

The coupling mode used by the logic scope to couple both AC and DC signal components to both the trigger system and the vertical system.



### **Delay measurement**

A measurement of the time between the middle reference crossings of two different waveforms.

### **Delay time**

The time between the trigger event and the acquisition of data.

### **Digitizing**

The process of converting a continuous analog signal such as a waveform to a set of discrete numbers representing the amplitude of the signal at specific points in time. Digitizing is composed of two steps: sampling and quantizing.

### **Display system**

The part of the logic scope that shows waveform groups, measurements, menu items, status, and other parameters.

### **Edge Trigger**

Triggering occurs when the logic scope detects the source passing through a specified voltage level in a specified direction (the trigger slope).

**Envelope acquisition mode**

A mode in which the logic scope acquires and displays a waveform that shows the variation extremes of several acquisitions.

**Fall time**

A measurement of the time it takes for trailing edge of a pulse to fall from a HighRef value (typically 90%) to a LowRef value (typically 10%) of its amplitude.

**Frequency**

A timing measurement that is the reciprocal of the period. Measured in Hertz (Hz) where 1 Hz = 1 cycle per second.

**Gated Measurements**

A feature that lets you limit automated measurements to a specified portion of the waveform. You define the area of interest using the vertical cursors.

**General purpose knob**

The large front-panel knob with an indentation. You can use it to change the value of the assigned parameter.

**Glitch positive trigger**

Triggering occurs if the logic scope detects positive spike widths less than the specified glitch time.

**Glitch negative trigger**

Triggering occurs if the logic scope detects negative spike widths less than the specified glitch time.

**GPIB (General Purpose Interface Bus)**

An interconnection bus and protocol that allows you to connect multiple instruments in a network under the control of a controller. Also known as IEEE 488 bus. It transfers data with eight parallel data lines, five control lines, and three handshake lines.

**Graticule**

A grid on the display screen that creates the horizontal and vertical axes. You can use it to visually measure waveform parameters.

**Group**

Also called a waveform group. A collection of channels that can be displayed a group of waveforms, a bus (called a BusForm) of waveforms, or a timing diagram of waveforms. The logic scope provides up to eight groups of up to 16 channels. Channels must be defined to be part of a group to be displayed.

**Hardcopy**

An electronic copy of the display in a format useable by a printer or plotter.

**High**

The value used as 100% in automated measurements (whenever high ref, mid ref, and low ref values are needed as in fall time and rise time measurements). May be calculated using either the min/max or the histogram method. With the min/max method (most useful for general waveforms), it is the maximum value found. With the histogram method (most useful for pulses), it refers to the most common value found above the mid point. See *Appendix B: Algorithms* for details.

**Hold**

The time between the first transition to an illegal state for a waveform bus relative to the clocking edge of a clock.

**Holdoff, trigger**

A specified amount of time after a trigger signal that elapses before the trigger circuit will accept another trigger signal. That helps ensure a stable display.

**Horizontal bar cursors**

The two horizontal bars that you position to measure the voltage parameters of a waveform. The logic scope displays the value of the active (moveable) cursor with respect to ground and the voltage value between the bars.

**Interpolation**

The way the logic scope calculates values for record points when the logic scope cannot acquire all the points for a complete record with a single trigger event. That condition occurs when the logic scope is limited to real time sampling and the time base is set to a value that exceeds the effective sample rate of the logic scope. The logic scope has two interpolation options: *linear* or *sin(x)/x interpolation*.

Linear interpolation calculates record points in a straight-line fit between the actual values acquired. Sin(x)/x computes record points in a curve fit between the actual values acquired. It assumes all the interpolated points fall in their appropriate point in time on that curve.

**Intensity**

Display brightness.

**Knob**

A rotary control.

**Logic Scope**

An instrument that graphs voltage versus time like an oscilloscope, but provides digital display modes and logic triggering capabilities. The logic scope finds use in the analyzing and debugging of digital circuits.

**Low**

The value used as 0% in automated measurements (whenever high ref, mid ref, and low ref values are needed as in fall time and rise time measure-

ments). May be calculated using either the min/max or the histogram method. With the min/max method (most useful for general waveforms), it is the minimum value found. With the histogram method (most useful for pulses), it refers to the most common value found below the mid point. See *Appendix B: Algorithms* for details.

**Main menu**

A group of related controls for a major logic scope function that the logic scope displays across the bottom of the screen.

**Main menu buttons**

Bezel buttons under the main menu display. They allow you to select items in the main menu.

**Maximum**

Amplitude (voltage) measurement of the maximum amplitude. Typically the most positive peak voltage.

**Mean**

Amplitude (voltage) measurement of the arithmetic mean over the entire waveform.

**Minimum**

Amplitude (voltage) measurement of the minimum amplitude. Typically the most negative peak voltage.

**NAND**

A logic (Boolean) function in which the output of the AND function is complemented (true becomes false, and false becomes true). On the logic scope, that is a trigger logic pattern and state function.

**Negative duty cycle**

A timing measurement representing the ratio of the negative pulse width to the signal period, expressed as a percentage.

**Negative overshoot measurement**

Amplitude (voltage) measurement.

$$\text{NegativeOvershoot} = \frac{\text{Low} - \text{Min}}{\text{Amplitude}} \times 100\%$$

**Negative width**

A timing measurement of the distance (time) between two amplitude points—falling-edge *MidRef* (default 50%) and rising-edge *MidRef* (default 50%)—on a negative pulse.

**Normal trigger mode**

A mode on which the logic scope does not acquire a waveform record unless a valid trigger event occurs. It waits for a valid trigger event before acquiring waveform data.

**NOR**

A logic (Boolean) function in which the output of the OR function is complemented (true becomes false, and false becomes true). On the logic scope, that is a trigger logic pattern and state function.

**Off Mode**

A logic scope display mode that displays that, when selected, removes the display of all waveforms in the group. Only the waveforms are removed, the group ground reference, trigger position, and trigger bar indicators remain on screen. Use Off mode to make room for other groups on screen without deleting the group turned off.

**OR**

A logic (Boolean) function in which the output is true if any of the inputs are true. Otherwise the output is false. On the logic scope, that is a trigger logic pattern and state function.

**Pattern trigger**

The logic scope compares (using combinational logic) the trigger source inputs with a user-defined logic pattern and triggers when the comparison meets conditions. The combination logic functions are AND, OR, NAND, NOR; the conditions are time limit and time range. The inputs compared are channels 1 through 16 and the auxiliary input.

**Peak-to-Peak**

Amplitude (voltage) measurement of the absolute difference between the maximum and minimum amplitude.

**Period**

A timing measurement of the time covered by one complete signal cycle. It is the reciprocal of frequency and is measured in seconds.

**Phase**

A timing measurement between two waveforms of the amount one leads or lags the other in time. Phase is expressed in degrees, where 360 degrees comprise one complete cycle of one of the waveforms. Waveforms measured should be of the same frequency or one waveform should be a harmonic of the other.

**Pixel**

A visible point on the display. The logic scope display is 640 pixels wide by 480 pixels high.

**Pop-up Menu**

A sub-menu of a main menu. Pop-up menus temporarily occupy part of the waveform display area and are used to present additional choices associated with the main menu selection. You can cycle through the options in a pop-up menu by repeatedly pressing the main menu button underneath the pop-up.



**Positive duty cycle**

A timing measurement of the ratio of the positive pulse width to the signal period, expressed as a percentage.

**Positive overshoot**

Amplitude (voltage) measurement.

$$PositiveOvershoot = \frac{Max - High}{Amplitude} \times 100\%$$

**Positive width**

A timing measurement of the distance (time) between two amplitude points—rising-edge *MidRef* (default 50%) and falling-edge *MidRef* (default 50%)—on a positive pulse.

**Posttrigger**

The specified portion of the waveform record that contains data acquired after the trigger event.

**Pretrigger**

The specified portion of the waveform record that contains data acquired before the trigger event.

**Probe**

An logic scope input device.

**Quantizing**

The process of converting an analog input that has been sampled, such as a voltage, to a digital value.

**Probe Calibration**

A logic scope routine you can run to optimize a probe for the channel it is connected to.

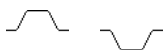
**Pulse trigger**

A trigger mode in which triggering occurs if the logic scope finds a pulse, of the specified polarity, with a width between, or optionally outside, the user-specified lower and upper time limits.

**Real-time sampling**

A sampling mode where the logic scope samples fast enough to completely fill a waveform record from a single trigger event. Use real-time sampling to capture single-shot or transient events. (The logic scope uses real time sampling at all acquisition rates.)

**Record length**

The specified number of samples in a waveform.

**Reference memory**

Memory in a logic scope used to store waveform groups or logic scope control setups. You can later use the waveform data stored for processing.

The logic scope saves the waveform and setup data even when the logic scope is turned off or unplugged.



### Rise time

The time it takes for a leading edge of a pulse to rise from a *LowRef* value (typically 10%) to a *HighRef* value (typically 90%) of its amplitude.



### RMS

Amplitude (voltage) measurement of the true Root Mean Square voltage.



### Sample acquisition mode

The logic scope creates a record point by saving the first sample during each acquisition interval. That is the default mode of the acquisition.

### Sample interval

The time interval between successive samples in a time base. For real-time digitizers, the sample interval is the reciprocal of the sample rate. For equivalent-time digitizers, the time interval between successive samples represents equivalent time, not real time.

### Sampling

The process of capturing an analog input, such as a voltage, at a discrete point in time and holding it constant so that it can be quantized.

### Selected group

The group to which the logic scope applies changes to the vertical controls, such as vertical position and scale adjustments. The group reference indicator for the selected group appears in reverse video at the left side of the screen.

### Selected waveform

The waveform on which all measurements are performed, and which is affected by vertical position and scale adjustments. The light over one of the channel selector buttons indicates the current selected waveform.



### Sequence trigger

The logic scope compares (using combinational logic) the trigger source inputs with a user-defined logic start pattern and a user-defined end pattern. It triggers when the sequence of start and end patterns meets conditions. The combination logic functions are AND, OR, NAND, NOR; the conditions are time limit and time range. The inputs compared are channels 1 through 16 and the auxiliary input.



### Setup

The time between the last transition to a legal state for a waveform bus relative to the clocking edge of the waveform specified as the clock. The clock can be any channel. It does not have to be included in the measured group.

**Side menu**

Menu that appears to the right of the display. These selections expand on main menu selections.

**Side menu buttons**

Bezel buttons to the right of the side menu display. They allow you to select items in the side menu.

**Skew**

The time between the first transition to an illegal state a waveform bus and the last transition to a legal state for the same waveform bus.

**Slope**

The direction at a point on a waveform. You can calculate the direction by computing the sign of the ratio of change in the vertical quantity (Y) to the change in the horizontal quantity. The two values are rising and falling.

**State trigger**

The logic scope compares (using combinational logic) the trigger source inputs with a user-defined logic pattern. It makes the comparison at the transition of the active edge of a user-specified clock. The combination logic functions are AND, OR, NAND, NOR; the conditions are time limit and time range. The inputs compared are channels 1 through 16 and the auxiliary input.

**Tek Secure**

This feature erases all waveform and setup memory locations (setup memories are replaced with the factory setup). Then it checks each location to verify erasure. This feature finds use where this *logic scope* is used to gather security sensitive data, such as is done for research or development projects.

**Time base**

The set of parameters that let you define the time and horizontal axis attributes of a waveform record. The time base determines when and how long to acquire record points.

**Timing Diagram Mode**

A logic scope display mode that displays each waveform in the group as one or more of three digital logic levels (like BusForm). However, unlike BusForm, the logic scope vertically offsets the ground reference of each waveform, so that the waveforms are separated vertically on screen. Use Timing Diagram mode to measure timing relationships between the waveforms included in the group. (Also see *Analog Mode*, *Timing Diagram Mode*, and *OFF Mode*.)

**Toggle button**

A button that changes which of the two cursors is active.

**Trigger**

An event that marks time zero in the waveform record. It results in acquisition and display of the waveform.

**Trigger level**

The vertical level the trigger signal must cross to generate a trigger (on edge mode).

**Vertical bar cursors**

The two vertical bars you position to measure the time parameter of a waveform record. The logic scope displays the value of the active (moveable) cursor with respect to trigger and the time value between the bars.

**Waveform**

The shape or form (visible representation) of a signal.

**Waveform interval**

The time interval between record points as displayed.

**YT format**

The conventional logic scope display format. It shows the voltage of a waveform record (on the vertical axis) as it varies over time (on the horizontal axis).





# Index

## Symbols

+ECL, Group menu, 3–28  
–ECL, Group menu, 3–28

## Numbers

1/seconds (Hz), Cursor menu, 3–85  
20 MHz, Group menu, 3–9

## A

AC line voltage, trigger input, 2–14  
Accessories, A–1–A–4  
    Optional, A–3  
    Software, A–4  
    Standard, A–2–A–4  
Accuracy, Glossary–1  
Acquire menu, 3–19  
    **Average**, 3–19  
    **Envelope**, 3–19  
    **Mode**, 3–19  
    **RUN/STOP**, 3–20  
    **RUN/STOP button only**, 3–20  
    **Sample**, 3–19  
    **Single Acquisition Sequence**, 3–20  
    **Stop After**, 3–20  
**ACQUIRE MENU** button, 3–19  
Acquisition, 2–19–2–22, Glossary–1  
    Interval, Glossary–1  
    Procedure for starting and stopping, 3–20  
    Readout, 3–19  
Acquisition mode  
    Average, 3–18  
    *Choosing an Acquisition Mode*, 3–17  
    Envelope, 3–17  
    How to choose, 3–17, 3–19  
    Sample, 3–17  
Acquisition Status, How to check, 3–19  
Active cursor, Glossary–1  
**active**, Saved waveform status, 3–110  
*Adjusting the Horizontal Setup*, Reference Article, 3–3  
*Adjusting the Vertical Setup*, Reference Article, 3–7  
Algorithms, B–1–B–18  
    Amplitude, B–4  
    Area, B–4  
    Burst Width, B–5  
    Cycle Area, B–5  
    Cycle Mean, B–5  
    Cycle RMS, B–5  
    Delay, B–6  
    Fall Time, B–6  
    Frequency, B–7  
    High, B–7  
    Hold, B–7  
    Integration, B–12  
    Low, B–8  
    Maximum, B–8  
    Mean, B–9  
    Minimum, B–9  
    Negative Duty Cycle, B–9  
    Negative Overshoot, B–9  
    Negative Width, B–9  
    Peak to Peak, B–10  
    Period, B–10  
    Phase, B–10  
    Positive Duty Cycle, B–10  
    Positive Overshoot, B–11  
    Positive Width, B–11  
    Rise Time, B–11  
    RMS, B–12  
    Setup, B–13  
    Skew, B–14  
    Variables used in, B–1  
Aliasing, 2–25, Glossary–1  
**All**, Group menu, 3–27  
Amplitude, 3–68, Glossary–1  
    Measurement algorithm, B–4  
Analog display mode  
    All, 3–27  
    Defined, 3–23, Glossary–1  
    Select, 3–27  
    To display a single channel, 3–27  
Analog Group Mode, Timing Diagram, Glossary–7,  
    Glossary–10  
**Analog**, Group menu, 3–26  
AND, Glossary–1  
**AND**, Main Trigger menu, 3–136, 3–152, 3–168  
Area, 3–68, Glossary–1  
    Measurement algorithm, B–4  
**Auto**, Main Trigger menu, 3–129, 3–136, 3–143,  
    3–153, 3–169  
Automated measurements, 1–23, 2–29  
    Snapshot of, 1–27  
Automatic trigger mode, 2–15, Glossary–2  
Autoset, 1–14, 2–26, 3–13, Glossary–2  
    *Autosetting the Logic Scope*, 3–13  
    Clipping with, 3–14–3–16  
    Defaults after executing, 3–15

- Description, 3-13
- Display thresholds, 3-14
- Procedure to execute, 3-14

**AUTOSET** button, 1-15, 3-14

Auxiliary trigger, 2-14

Average acquisition mode, 3-18, Glossary-2

**Average**, Acquire menu, 3-19

## B

Bandwidth, 1-1, 2-21, Glossary-2

**Bandwidth**, Group menu, 3-9

**Banner**, Status menu, 3-173

Binary Readout, 2-28

BMP, 3-87

**BMP Color**, Hardcopy menu, 3-89

**BMP Mono**, Hardcopy menu, 3-89

**Bold**, Color menu, 3-42

Burst width, 3-68

- Measurement algorithm, B-5

BusForm Display mode, clipping with, 3-28

BusForm display mode, 3-23

- To set vertical height, 3-28

BusForm mode, Glossary-2

**BusForm**, Group menu, 3-26

Button

- ACQUIRE MENU**, 3-19
- AUTOSET**, 1-15, 2-25, 3-14
- Channel selection, 1-11
- CLEAR MENU**, 1-10, 1-24, 1-25, 2-3, 2-8, 3-76, 3-77
- CURSOR**, 2-28, 3-84
- DELAYED TRIG**, 2-17, 3-125
- DISPLAY**, 3-35, 3-41
- FORCE TRIG**, 3-160
- GROUP 1, GROUP 2 ...**, 3-26, 3-58, 3-117
- GROUP OFF**, 3-29, 3-119
- Group selection, 3-26, 3-58, 3-117
- HARDCOPY**, 3-33, 3-62, 3-89
- HELP**, 3-171
- HORIZONTAL MENU**, 2-17, 3-124
- Main menu, 2-3
- MEASURE**, 3-70
- MORE**, 3-26, 3-58, 3-113, 3-117, 3-119
- ON/STBY**, 1-4, 2-3
- Save/Recall **SETUP**, 1-8, 3-62, 3-105
- Save/Recall **WAVEFORM**, 3-62, 3-106, 3-107, 3-110, 3-111
- Select**, 3-85
- SET LEVEL TO 50%**, 3-159
- SHIFT**, 3-8
- Side menu, 2-3

**SINGLE TRIG**, 3-21, 3-160

**STATUS**, 3-173

**TOGGLE**, 2-28, Glossary-10

**TRIGGER MENU**, 3-128, 3-134, 3-143, 3-151, 3-162, 3-167

**UTILITY**, 3-33, 3-88

**WAVEFORM OFF**, 1-16

**ZOOM**, 2-26, 3-176

## C

Cables, 3-32

**Cal Probe**, Vertical menu, 3-50

Calibration Certificate

- Option 95, A-2
- Option 96, A-2

Cart, Oscilloscope, A-1

**CAUTION**

- Statement in manuals, ix
- statement on equipment, ix

Centronics, **Port**, 3-31, 3-89

**Ch1, Ch2 ...**, Main Trigger menu, 3-128, 3-135, 3-143, 3-151, 3-152, 3-162, 3-163, 3-168

**Change Colors**, Color menu, 3-43

Channel, Glossary-2

- How to include in a group, 3-55
- How to select, 3-119
- Readout, 2-6, 3-117, 3-176
- Reference Indicator, 2-6
- Selected, Significance of, 3-117-3-120
- Selection buttons, 1-11
- Trigger input, 2-14-2-18

Channel readout, 2-6

*Choosing a Group Display Mode*, Reference Article, 3-23

*Choosing an Acquisition Mode*, Reference Article, 3-17

Circuit loading, Glossary-3

**Class**, Main Trigger menu, 3-143

**CLEAR MENU** button, 1-10, 1-24, 1-25, 2-3, 2-8, 3-76, 3-77

**Clear Spool**, Hardcopy menu, 3-92

Clipping, after Autoset, 3-14

**CMOS**, Group menu, 3-28

Coaxial Adapter Set, A-1

**Collision Contrast**, Color menu, 3-46

Color, 3-41-3-48

- How to access, 3-41
- How to change in a palette, 3-43
- How to change the color of a group, 3-44, 3-45
- How to highlight waveform overlaps, 3-46
- How to restore defaults, 3-46



- How to select a palette of, 3–42
  - Color menu
    - Bold**, 3–42
    - Change Colors**, 3–43
    - Collision Contrast**, 3–46
    - Color**, 3–43, 3–44, 3–45
    - Group**, 3–44
    - Hardcopy**, 3–42
    - Hue**, 3–43
    - Lightness**, 3–43
    - Map Group Colors**, 3–44
    - Map Reference**, 3–45
    - Monochrome**, 3–42
    - Normal**, 3–42
    - Options**, 3–46
    - Palette**, 3–42
    - Persistence Palette**, 3–42
    - Ref**, 3–45
    - Reset All Mappings To Factory**, 3–46
    - Reset All Palettes To Factory**, 3–46
    - Reset Current Palette To Factory**, 3–46
    - Reset to Factory Color**, 3–43
    - Restore Colors**, 3–46
    - Saturation**, 3–44
    - Spectral**, 3–42
    - Temperature**, 3–42
    - View Palette**, 3–42
  - Color**, Color menu, 3–43, 3–44, 3–45
  - Communicating with Remote Instruments*, Reference Article, 3–31
  - Configure**, Utility menu, 3–33, 3–88
  - Confirm Delete**, File Utilities menu, 3–65
  - Connector, GPIB, 2–5, 3–32
  - Contrast**, Display menu, 3–37
  - Controls
    - Horizontal, 3–3
    - How to save a setup, 3–105
    - How to set automatically, 3–13
    - How to store setups, 1–7, 1–29
    - Vertical, 3–7
  - Conventions, xi
    - For naming files, 3–61
    - In reference articles, 3–2
  - Copy**, File Utilities menu, 3–64
  - Coupling, Input Signal, 2–21
  - Create Directory**, File Utilities menu, 3–65
  - Create Measrmt**, Measure Delay menu, 3–76, 3–77
  - Cross Hair**, Display settings menu, 3–39
  - Cursor, 2–28, 3–81–3–86, Glossary–3
    - Binary readout with, 3–83
    - Description of, 3–81
    - Faster positioning, 3–85
    - Horizontal bar, 2–28, 3–81
    - Measurements, 2–28
    - Measuring Waveforms with Cursors*, 3–81
    - Mode, 2–28–2–29
      - Independent, 2–29
      - Tracking, 2–29
    - Paired, 2–28, 3–82
    - Readouts, 3–82
    - Vertical bar, 2–28, 3–81
  - CURSOR** button, 3–84
  - Cursor menu, 3–84
    - 1/seconds (Hz)**, 3–85
    - Function**, 3–84, 3–85
    - H Bars**, 3–84, 3–85
    - Independent**, 3–85
    - seconds**, 3–85
    - Time Units**, 3–85
    - Tracking**, 3–85
  - Customizing the Display*, Reference Article, 3–35
  - Customizing the Display Colors*, Reference Article, 3–41
  - Cycle area, 3–68, Glossary–3
    - Measurement algorithm, B–5
  - Cycle mean, 3–68, Glossary–3
    - Measurement algorithm, B–5
  - Cycle RMS, 3–68, Glossary–3
    - Measurement algorithm, B–5
- ## D
- DANGER, statement on equipment, ix
  - Date/Time
    - On hardcopies, 3–89
    - To set, 3–90
  - DC coupling, Glossary–3
  - Define Logic**, Main Trigger menu, 3–136, 3–168
  - Define Pattern**, Main Trigger menu, 3–135, 3–151, 3–152, 3–168
  - Delay
    - Acquiring after, 3–121
    - Measurement algorithm, B–6
    - Triggering After*, 3–121
  - Delay by Events**, Delayed Trigger menu, 3–125
  - Delay by Time**, Delayed Trigger menu, 3–125
  - Delay by**, Delayed Trigger menu, 3–125
  - Delay measurement, 3–75, Glossary–3
  - Delay modes, 3–121
  - Delay time, Glossary–3
  - Delay To**, Measure Delay menu, 3–75, 3–77
  - Delayed Only**, Horizontal menu, 3–5, 3–124
  - Delayed runs after main, 2–17–2–18
    - Delay mode, 3–121

**Delayed Runs After Main**, Horizontal menu, 3–5, 3–124

**Delayed Scale**, Horizontal menu, 3–5

**DELAYED TRIG** button, 2–17, 3–125

Delayed trigger, 2–17–2–18, 3–121–3–126

Delayed Trigger menu, 3–125–3–126

- Delay by**, 3–125
- Delay by Events**, 3–125
- Delay by Time**, 3–125
- Source**, 3–126

Delayed triggerable, 2–17–2–18

- Delay mode, 3–121

**Delayed Triggerable**, Horizontal menu, 3–5, 3–125

**Delete Refs**, Save/Recall Waveform menu, 3–114

**Delete**, File Utilities menu, 3–63

Description, product, 1–1

Deskjet, 3–87

**Deskjet**, Hardcopy menu, 3–89

Digitizing, Glossary–3

Directory

- To change to, 3–65
- To copy, 3–64
- To create, 3–65
- To delete, 3–63
- To rename, 3–63

Disk

- Floppy, 3–61
- How to save a hardcopy to, 3–92

Disk drive, 3–61–3–66

**Display**, Group menu, 3–176

Display, 2–6

- Customizing the Display*, 3–35
- Customizing the Display Colors*, 3–41
- Filter, How to select, 3–38
- Graticule, How to select, 3–39
- Hardcopy of, 3–87
- How to Adjust, 3–35
- How to set readout options, 3–37
- Intensity, How to set, 3–37
- Options, 3–35–3–40
- Procedure to set style, 3–36
- Record View, 3–161
- System, Glossary–3

**Display ‘T’ @ Trigger Point**, Display menu, 3–37

**DISPLAY** button, 3–35, 3–41

Display Color Menu, 3–41

Display Colors, How to Adjust, 3–41

Display menu, 3–35

- Contrast**, 3–37
- Display**, 3–35
- Display ‘T’ @ Trigger Point**, 3–37
- Intensity**, 3–37–3–40
- Overall**, 3–37

- Procedure to access, 3–35
- Readout**, 3–37
- Settings**, 3–35
- Text/Grat**, 3–37
- Trigger Bar**, 3–37
- Waveform**, 3–37

Display modes, 1–1

Display settings menu

- Cross Hair**, 3–39
- Dots**, 3–36
- Filter**, 3–38, 3–39
- Frame**, 3–39
- Full**, 3–39
- Graticule**, 3–39–3–40
- Grid**, 3–39
- Infinite Persistence**, 3–37
- Intensified Samples**, 3–36
- Linear interpolation**, 3–38
- Sin(x)/x interpolation**, 3–38
- Style**, 3–36
- Variable Persistence**, 3–37
- Vectors**, 3–36

Display status, How to check, 3–35, 3–41

Display thresholds, after Autoset, 3–14–3–16

**Display Thresholds**, Group menu, 3–28

**Display**, Display menu, 3–35

**Display**, Group menu, 3–26

**Display**, Status menu, 3–173

*Displaying Waveforms*, Tutorial Example, 1–11

*Doing a Probe Cal*, Reference Article, 3–49

*Doing a Signal Path Compensation*, Reference Article, 3–53

Dots, 3–36

- Dots**, Display settings menu, 3–36
- DPU411–II**, Hardcopy menu, 3–89
- DPU412**, Hardcopy menu, 3–89
- Dual-lead adapter, 3–101, 3–102
- Duty cycle, 1–24, Glossary–6, Glossary–8

## E

Edge trigger, 2–14, 3–127, Glossary–3

- Determining Setup, 3–127
- Readout, 3–127

**Edge**, Main Trigger menu, 3–128, 3–162

**Edges**, Measure Delay menu, 3–76, 3–77

Eight-wire loom, 3–102

**Either**, Main Trigger menu, 3–144, 3–145

**empty**, Saved waveform status, 3–110

Encapsulated Postscript, 3–87

End, Measurement variable, B–2

**End Pattern Logic Func**, Main Trigger menu, 3–152

**Enter Char**, Labelling menu, 3–63, 3–65  
Envelope acquisition mode, 3–17, Glossary–4  
    And automated measurements, B–15  
**Envelope**, Acquire menu, 3–19  
**EPS Color Img**, Hardcopy menu, 3–89  
**EPS Color Plt**, Hardcopy menu, 3–89  
**EPS Mono Img**, Hardcopy menu, 3–89  
**EPS Mono Plt**, Hardcopy menu, 3–89  
Epson, 3–87  
**Epson**, Hardcopy menu, 3–89  
Events, Trigger, 3–122

## F

Factory initialization settings, D–1–D–4  
Factory Setup, 3–107  
**factory**, Saved setup status, 3–106  
Fall time, 3–68, Glossary–4  
    Measurement algorithm, B–6  
Falling edge, Main Trigger menu, 3–128  
File  
    To copy, 3–64  
    To delete, 3–63  
    To print, 3–64  
    To rename, 3–63  
File System, 3–61–3–66  
    Description of, 3–61  
    *Managing the File System*, 3–61  
File utilities  
    Format disk, 3–65  
    To access, 3–62  
    To set Confirm Delete, 3–65  
    To set Overwrite Lock, 3–65  
    To use, 3–62  
File Utilities menu, 3–62  
    **Confirm Delete**, 3–65  
    **Copy**, 3–64  
    **Create Directory**, 3–65  
    **Delete**, 3–63  
    **File Utilities**, 3–62  
    **Format**, 3–65  
    **Overwrite Lock**, 3–65  
    **Print**, 3–64  
    **Rename**, 3–63  
**File Utilities**, File Utilities menu, 3–62  
**File Utilities**, Save/Recall Waveform menu, 3–115  
Filenames  
    Default, 3–61  
    Wild cards, 3–61  
**Filter**, Display settings menu, 3–38, 3–39  
Firmware version, 3–173  
**Fit to screen**, Horizontal menu, 3–5

Flex adapter, 3–101  
**FORCE TRIG** button, 3–160  
Format, Floppy disk, 3–65  
**Format**, File Utilities menu, 3–65  
**Format**, Hardcopy menu, 3–89  
**Frame**, Display settings menu, 3–39  
Frequency, 1–23, 3–69, Glossary–4  
    Measurement algorithm, B–7  
Front Cover removal, 1–4  
Front panel, 2–4  
**Full**, Display settings menu, 3–39  
**Full**, Group menu, 3–9  
**Function**, Cursor menu, 3–84, 3–85  
Fuse, 1–3, 2–5

## G

Gated Measurements, 3–72, Glossary–4  
**Gating**, Measure menu, 3–72  
General purpose knob, 1–26, 2–7, Glossary–4  
Glitch trigger, 3–141, 3–142, Glossary–4  
**Glitch**, Main Trigger menu, 3–143  
Glitches, Triggering on, 3–141  
GPIB, 2–5, 3–31–3–34, Glossary–4  
    Connecting to, 3–33  
    Interconnect cabling, 3–32  
    Interface requirements, 3–31  
    Procedures for using, 3–33  
    Protocols, 3–31  
    Selecting and configuring the port, 3–33  
    Typical configuration, 3–32  
**GPIB**, Hardcopy menu, 3–89  
**GPIB**, Utility menu, 3–33  
Graticule, Glossary–4  
    Display, How to select, 3–39  
    Measurements, 2–27  
**Graticule**, Display settings menu, 3–39–3–40  
**Grid**, Display settings menu, 3–39  
Ground lead, 3–100  
Ground lead inductance, 3–102  
Group, Glossary–4  
    Attempting invalid definitions of, 3–59  
    Composition of, 3–55  
    Description of, 3–55  
    *Grouping Waveforms*, 3–55  
    How to change the color of, 3–44  
    How to create and define, 3–58  
    How to delete, 3–59  
    How to remove from display, 3–119  
    How to select, 3–117  
    Multiple channel operation, 1–17  
    readout, 3–57

- Saving and Recalling Waveforms*, 3–109
- Selected, Significance of, 3–117–3–120
- Selecting Groups and Channels*, 3–117
- Selection buttons, 3–26, 3–58, 3–117
- Single channel operation, 1–11
- Single channels in, 3–55
- To check setup, 3–56
- To Define Thresholds of, 3–28
- To remove from display, 3–29
- Valid and invalid, illustrated, 3–56
- Why used, 3–55
- GROUP 1, GROUP 2 ...** buttons, 3–26, 3–58, 3–117, 3–176
- Group Definition**, Group menu, 3–14
- Group display mode
  - Analog, 3–23, Glossary–1
  - BusForm, 3–23, Glossary–2
  - Choosing a Group Display Mode*, 3–23
  - OFF, 3–24
  - Timing Diagram, 3–23
  - To check, 3–25
  - To select, 3–26
- Group menu
  - +ECL, 3–28
  - ECL, 3–28
  - 20 MHz, 3–9
  - All, 3–27
  - Analog, 3–26
  - Bandwidth, 3–9
  - BusForm, 3–26
  - CMOS, 3–28
  - Display, 3–26, 3–176
  - Display Thresholds, 3–28
  - Full, 3–9
  - Group Definition, 3–14
  - Height in Divs, 3–28
  - Logic Family Presets, 3–28
  - OFF, 3–26
  - Select, 3–27
  - Selected Channel, 3–14
  - Set Offset to 0 divs, 3–10
  - Set Position to 0 divs, 3–9
  - Store User1 Preset, 3–29
  - Store User2 Preset, 3–29
  - Timing Diagram, 3–26
  - TTL, 3–28
  - Vertical Controls, 3–9
  - Vhigh, min, 3–28
  - Vlow, max, 3–28
- Group mode, OFF, 3–29
- Group Modes, Description of, 3–23
- GROUP OFF** button, 3–29, 3–119

- Group reference indicator, Glossary–2
  - Analog display mode, 3–23
  - BusForm display mode, 3–23
  - Illustrated, 3–24
  - Timing diagram display mode, 3–23
- Group**, Color menu, 3–44
- Grouping Waveforms*
  - Reference Article, 3–55
  - Tutorial Example, 1–17
- Groups, and zoom, 3–175

## H

- H Bars**, Cursor menu, 3–84, 3–85
- Hand-held adapter, 3–100
- Hardcopy, 3–87–3–96, Glossary–4
  - How to print (controller), 3–93
  - How to print (no controller), 3–91
  - How to save to disk, 3–92
  - How to set up for, 3–88
  - Phaser 140, A–2
  - Printing a hardcopy*, 3–87
  - Spool, 3–92
- Hardcopy (Talk Only)**, Utility menu, 3–88
- HARDCOPY** button, 3–33, 3–62, 3–89
- Hardcopy menu
  - BMP Color**, 3–89
  - BMP Mono**, 3–89
  - Clear Spool**, 3–89, 3–92
  - Deskjet**, 3–89
  - DPU411–II**, 3–89
  - DPU412**, 3–89
  - EPS Color Img**, 3–89
  - EPS Color Plt**, 3–89
  - EPS Mono Img**, 3–89
  - EPS Mono Plt**, 3–89
  - Epson**, 3–89
  - Format**, 3–89
  - GPIB**, 3–89
  - HPGL**, 3–89
  - Interleaf**, 3–89
  - Landscape**, 3–89
  - Laserjet**, 3–89
  - Layout**, 3–89
  - OK Confirm Clear Spool**, 3–92
  - Palette**, 3–89
  - PCX**, 3–89
  - PCX Color**, 3–89
  - Port**, 3–89
  - Portrait**, 3–89
  - RLE Color**, 3–89

- Thinkjet**, 3–89
  - TIFF**, 3–89
  - Hardcopy**, Color menu, 3–42
  - Hardcopy**, Utility menu, 3–33
  - Height in Divs**, Group menu, 3–28
  - HELP** button, 3–171
  - Help system, 3–171
  - High, 3–69, Glossary–5
    - Measurement algorithm, B–7
    - Measurement variable, B–1
  - High Ref**, Measure menu, 3–74
  - High-Low Setup**, Measure menu, 3–73
  - High-Low Setup**, Measure menu, B–1
  - HighRef, Measurement variable, B–2
  - Histogram method, B–1
  - Histogram**, Measure menu, 3–73
  - Hold, 3–69, Glossary–5
    - Measurement algorithm, B–7
  - Holdoff**, Main Trigger menu, 3–136, 3–143, 3–153, 3–169
  - Holdoff, trigger, 2–15, Glossary–5
  - Horiz Pos**, Horizontal menu, 3–6
  - Horiz Scale**, Horizontal menu, 3–5
  - Horizontal
    - Adjustment of setup, 3–3–3–6
    - Bar cursors, 2–28, 3–81, Glossary–5
    - Checking Status, 3–4, 3–9
    - Menu, 2–17
    - Position, 3–3
    - POSITION** knob, 2–24
    - Readouts, 3–4
    - Scale, 3–3
    - SCALE** knob, 1–13, 2–24
    - System, 1–13, 2–24
  - Horizontal Lock**, Zoom menu, 3–177
  - Horizontal Lock, 3–6
  - Horizontal menu, 3–124
    - Delayed Only**, 3–124
    - Delayed Runs After Main**, 3–5, 3–124
    - Delayed Scale**, 3–5
    - Delayed Triggerable**, 3–5, 3–125
    - Fit to screen**, 3–5
    - Horiz Pos**, 3–6
    - Horiz Scale**, 3–5
    - Intensified**, 3–5, 3–124, 3–125
    - Main Scale**, 3–5
    - Record Length**, 3–5
    - Set to 10%**, 3–6
    - Set to 20%**, 3–5
    - Set to 50%**, 3–5, 3–6
    - Set to 80%**, 3–5
    - Set to 90%**, 3–6
    - Time Base**, 3–5, 3–124
  - Trigger Position**, 3–5
  - HORIZONTAL MENU** button, 2–17, 3–124
  - Horizontal **POSITION** knob, 3–3, 3–176
  - Horizontal Readouts, 3–4
  - Horizontal **SCALE** knob, 3–3, 3–176
  - Horizontal Setup
    - Adjusting Position, 3–6
    - Adjusting position, 3–3
    - Adjusting scale, 3–3, 3–5
    - Adjusting the Horizontal Setup*, 3–3
    - Adjusting the record length, 3–5
    - Adjusting the trigger position, 3–5
    - Fitting the waveform on screen, 3–5
    - How to Adjust, 3–3
    - How to check, 3–4
    - Positioning and horizontal lock, 3–6
    - Selecting a time base, 3–5
  - HPGL, 3–87
  - HPGL**, Hardcopy menu, 3–89
  - Hue**, Color menu, 3–43
  - Hysteresis, Measurement variable, B–3
- I**
- I/O**, Utility menu, 3–88
  - Icons, 1–1
  - Independent Mode, Cursor, 2–29
  - Independent**, Cursor menu, 3–85
  - Infinite Persistence**, Display settings menu, 3–37
  - Installation, 1–3
    - Probe to logic scope, 3–97
  - Integration, Algorithm, B–12
  - Intensified Samples**, Display settings menu, 3–36
  - Intensified**, Horizontal menu, 3–124, 3–125
  - Intensity, Glossary–5
    - Display, How to set, 3–37
  - Intensity**, Display menu, 3–37–3–40
  - Interleaf, 3–87
  - Interleaf**, Hardcopy menu, 3–89
  - Interleaving, 2–20
  - Interpolation, 2–20, 3–20, Glossary–5
    - And zoom, 3–175
    - How to set, 3–38
    - Methods, 3–177
- K**
- Keypad, 1–27, 2–7
  - Knob, Glossary–5
    - General purpose, 1–26, 2–7, Glossary–4
    - Horizontal **POSITION**, 1–13, 2–24, 3–3
    - Horizontal **SCALE**, 1–13, 2–24, 3–3

- MEASURE**, 2–29  
 Trigger **MAIN LEVEL**, 1–14, 2–17  
 Vertical **POSITION**, 1–13, 2–24, 3–8  
 Vertical **SCALE**, 1–13, 2–24, 3–8
- L**
- Labelling menu, **Enter Char**, 3–63, 3–65  
**Landscape**, Hardcopy menu, 3–89  
 Laserjet, 3–87  
**Laserjet**, Hardcopy menu, 3–89  
**Layout**, Hardcopy menu, 3–89  
**Level**, Main Trigger menu, 3–144, 3–162, 3–163  
 Level, Trigger, 2–17  
**Lightness**, Color menu, 3–43  
 Linear interpolation, 2–20, Glossary–5  
   How to set, 3–38  
**Linear interpolation**, Display settings menu, 3–38  
**Logic Family Presets**, Group menu, 3–28  
 Logic scope, Glossary–5  
 Logic trigger, 2–14  
   Pattern, Glossary–7, Glossary–9  
   State, Glossary–10  
**Logic**, Main Trigger menu, 3–162  
 Low, 3–69, Glossary–5  
   Measurement algorithm, B–8  
   Measurement variable, B–1  
**Low Ref**, Measure menu, 3–74  
 LowRef, Measurement variable, B–2
- M**
- Main menu, Glossary–6  
 Main menu buttons, 2–3, Glossary–6  
**Main Only**, Horizontal menu, 3–5  
**Main Scale**, Horizontal menu, 3–5  
 Main Trigger Menu  
   Falling edge, 3–128  
   Rising edge, 3–128  
 Main Trigger menu, 2–11, 3–128, 3–134, 3–143,  
   3–151, 3–162, 3–167  
**AND**, 3–136, 3–152, 3–168  
**Auto**, 3–129, 3–136, 3–143, 3–153, 3–169  
**Ch1, Ch2 ...**, 3–128, 3–135, 3–143, 3–151, 3–152,  
   3–162, 3–163, 3–168  
**Class**, 3–143  
**Define Logic**, 3–136, 3–168  
**Define Pattern**, 3–135, 3–151, 3–152, 3–168  
**Edge**, 3–128, 3–162  
**Either**, 3–144, 3–145  
**End Pattern Logic Func**, 3–152  
**Glitch**, 3–143  
**Holdoff**, 3–136, 3–143, 3–153, 3–169  
**Level**, 3–144, 3–162, 3–163  
**Mode & Holdoff**, 3–129, 3–136, 3–143, 3–153,  
   3–169  
**NAND**, 3–136, 3–152, 3–168  
**Negative**, 3–144, 3–145  
**NOR**, 3–136, 3–152, 3–168  
**Normal**, 3–129, 3–136, 3–143, 3–153, 3–169  
**OR**, 3–136, 3–152, 3–168  
**Pattern**, 3–134, 3–151  
**Polarity and Width**, 3–144, 3–145  
**Positive**, 3–144, 3–145  
**Pulse**, 3–143, 3–162  
**Set to 50%**, 3–159  
**Set to ECL**, 3–163  
**Set to TTL**, 3–163  
**Slope**, 3–128  
**Source**, 3–128, 3–143  
**Start Pattern Logic Func**, 3–152  
**State**, 3–167  
**Trigger When**, 3–137, 3–138, 3–139, 3–154, 3–155,  
   3–157, 3–168, 3–169  
**Type**, 3–128, 3–143, 3–162  
**Width**, 3–145  
*Managing the File System*, Reference Article, 3–61  
**Map Group Colors**, Color menu, 3–44  
**Map Reference**, Color menu, 3–45  
 Marker tabs, 3–102  
 Maximum, 3–69, Glossary–6  
   Measurement algorithm, B–8  
 MCross calculations, B–3  
 Mean, 3–69, Glossary–6  
   Measurement algorithm, B–9  
**MEASURE** button, 3–70  
 Measure Delay menu  
   **Create Measrmnt**, 3–76, 3–77  
   **Delay To**, 3–75, 3–77  
   **Edges**, 3–76, 3–77  
   **Measure Delay To**, 3–75, 3–77  
   **OK Create Measurement**, 3–76, 3–77  
**Measure Delay To**, Measure Delay menu, 3–75, 3–77  
 Measure menu, 2–11, 3–70, 3–78  
   **Gating**, 3–72  
   **High Ref**, 3–74  
   **High-Low Setup**, 3–73  
   **High-Low Setup**, B–1  
   **Histogram**, 3–73  
   **Low Ref**, 3–74  
   **Mid Ref**, 3–74  
   **Mid2 Ref**, 3–74  
   **Min-Max**, 3–73  
   **Reference Level**, B–2  
   **Reference Levels**, 3–73

- Remove Measrmnt**, 3–71, 3–78
- Select Measrmnt**, 3–70, 3–75, 3–76
- Set Levels in % units**, 3–73
- Snapshot**, 3–78
- Measurements, 2–27–2–30
  - Algorithms, B–1–B–18
  - Amplitude, 3–68, Glossary–1
  - And envelope mode, B–15
  - Area, 3–68, Glossary–1
  - Automated, 2–29
  - Automatic
    - Definitions of, 3–68
    - Description of, 3–67
    - How to take, 3–70, 3–75
  - Burst width, 3–68, Glossary–2
  - Cursor, 2–28
  - Cycle area, 3–68, Glossary–3
  - Cycle mean, 3–68, Glossary–3
  - Cycle RMS, 3–68, Glossary–3
  - Delay, 3–75, Glossary–3
  - Duty cycle, 1–24, Glossary–6, Glossary–8
  - Fall time, 3–68
  - Frequency, 1–23, 3–69, Glossary–4
  - Gated, 3–72, Glossary–4
  - Graticule, 2–27
  - High, 3–69, Glossary–5
  - Histogram method, B–1
  - Hold, 3–69
  - How to take automatically, 1–23
  - How to take snapshot of, 3–78
  - Low, 3–69, Glossary–5
  - Maximum, 3–69, Glossary–6
  - Mean, 3–69, Glossary–6
  - Measuring Waveforms Automatically*, 3–67
  - Measuring Waveforms with Cursors*, 3–81
  - Min-Max method, B–1
  - Minimum, 3–69, Glossary–6
  - Negative duty cycle, 3–69
  - Negative overshoot, 3–69
  - Negative width, 3–69
  - Overshoot, Glossary–8
  - Peak to peak, 3–69, Glossary–7
  - Period, 3–69, Glossary–7
  - Phase, 3–69, Glossary–7
  - Positive duty cycle, 3–69
  - Positive overshoot, 3–69
  - Positive width, 3–70
  - Propagation delay, 3–68
  - Readout, 3–67, 3–71
  - Reference levels, 1–25
  - Rise time, 1–24, 3–70, Glossary–9
  - RMS, 3–70, Glossary–9
  - Setup, 3–70
  - Skew, 3–70
  - Undershoot, Glossary–6
  - Width, 1–24, Glossary–6, Glossary–8
- Measurement Accuracy, Ensuring maximum, 3–49–3–52, 3–53–3–54
- Measuring Waveforms Automatically*, Reference Article, 3–67
- Measuring Waveforms with Cursors*, Reference Article, 3–81
- Memory, Waveform, 3–114
- Menu
  - Acquire, 3–19
  - Cursor, 3–84
  - Delayed Trigger, 3–125–3–126
  - Display, 3–35
  - Display Color, 3–41
  - File Utilities, 3–62
  - Horizontal, 2–17, 3–124
  - Main, 2–6
  - Main Trigger, 2–11, 3–128, 3–134, 3–143, 3–151, 3–162, 3–167
  - Measure, 2–11, 3–70, 3–78
  - More, 2–11, 3–113
  - Operation, 2–7
  - Pop-up, 2–8, Glossary–7
  - Pulse trigger, 2–10
  - Save/Recall, 3–105
  - Save/Recall Setup, 2–11
  - Save/Recall Waveform, 2–11, 3–106, 3–107, 3–110, 3–111
  - Setup, 1–8
  - Status, 2–11, 3–173–3–174
  - Utility, 2–12, 3–88
- Mid Ref**, Measure menu, 3–74
- Mid2 Ref**, Measure menu, 3–74
- Mid2Ref, Measurement variable, B–2
- MidRef, Measurement variable, B–2
- Min-Max Method, B–1
- Min-Max**, Measure menu, 3–73
- Minimum, 3–69, Glossary–6
  - Measurement algorithm, B–9
- Mode, Cursor, 2–28–2–29
- Mode & Holdoff**, Main Trigger menu, 3–129, 3–136, 3–143, 3–153, 3–169
- Mode**, Acquire menu, 3–19
- Model number location, 2–3
- Monochrome**, Color menu, 3–42
- MORE** button, 3–26, 3–58, 3–113, 3–117, 3–119
- More menu, 2–11, 3–113
  - Reference waveform status, 3–113

**N**

NAND, Glossary–6  
**NAND**, Main Trigger menu, 3–136, 3–152, 3–168  
Negative duty cycle, 3–69  
    Measurement algorithm, B–9  
Negative overshoot, 3–69  
    Measurement algorithm, B–9  
Negative width, 3–69  
    Measurement algorithm, B–9  
**Negative**, Main Trigger menu, 3–144, 3–145  
NOR, Glossary–7  
**NOR**, Main Trigger menu, 3–136, 3–152, 3–168  
Normal trigger mode, 2–15, Glossary–6  
**Normal**, Color menu, 3–42  
**Normal**, Main Trigger menu, 3–129, 3–136, 3–143, 3–153, 3–169

**O**

**Off Bus**, Utility menu, 3–33  
OFF display mode, 3–24  
**OFF**, Group menu, 3–26  
Offset, Vertical, 2–24, 3–10  
**OK Compensate Probes**, Vertical menu, 3–50  
**OK Confirm Clear Spool**, Hardcopy menu, 3–92  
**OK Create Measurement**, Measure Delay menu, 3–76, 3–77  
**OK Erase Ref & Panel Memory**, Utility menu, 3–108  
**OK Initialize Probes**, Vertical menu, 3–51  
ON/STBY button, 1–4, 2–3  
One-to-two adapter, 3–100  
Operating Tasks, List of, 3–1  
Options, A–1–A–4  
**Options**, Color menu, 3–46  
OR, Glossary–7  
**OR**, Main Trigger menu, 3–136, 3–152, 3–168  
**Overall**, Display menu, 3–37  
Overshoot, Glossary–8  
Overwrite Lock, 3–65  
**Overwrite Lock**, File Utilities menu, 3–65

**P**

Packaging, C–1  
Paired cursor, 2–28, 3–82  
**Palette**, Color menu, 3–42  
**Palette**, Hardcopy menu, 3–89  
**Pattern**, Main Trigger menu, 3–133  
Pattern, Triggering on, 3–131  
Pattern trigger, 3–131–3–140, 3–147–3–158  
    Definitions, 3–131, 3–132

    Determining Setup, 3–133, 3–142, 3–150  
**Pattern**, Main Trigger menu, 3–134, 3–151  
Patterns, Triggering on a Sequence of, 3–147  
PCX, 3–87  
**PCX Color**, Hardcopy menu, 3–89  
**PCX**, Hardcopy menu, 3–89  
Peak to peak, 3–69, Glossary–7  
    Measurement algorithm, B–10  
Period, 3–69, Glossary–7  
    Measurement algorithm, B–10  
Persistence, 3–37  
**Persistence Palette**, Color menu, 3–42  
**Persistence Palettes**, Color menu, 3–42  
Phase, 3–69, Glossary–7  
    Measurement algorithm, B–10  
Phaser Color Printer, 140, A–2  
Pixel, Glossary–7  
**Polarity and Width**, Main Trigger menu, 3–144, 3–145  
Pop-up menu, 2–8, Glossary–7  
**Port**, Hardcopy menu, 3–89  
**Port**, Utility menu, 3–33  
**Portrait**, Hardcopy menu, 3–89  
Position, Vertical, 2–24, 3–9  
Positive duty cycle, 3–69  
    Measurement algorithm, B–10  
Positive overshoot, 3–69  
    Measurement algorithm, B–11  
Positive width, 3–70  
    Measurement algorithm, B–11  
**Positive**, Main Trigger menu, 3–144, 3–145  
Postscript, 3–87  
Posttrigger, Glossary–8  
Power connector, 1–4  
Power cords, A–1  
Power off, 1–5  
Power on, 1–4  
Pretrigger, Glossary–8  
Principal power switch, 1–4, 2–5  
**Print**, File Utilities menu, 3–64  
Printer, Phaser 140, A–2  
*Printing a Hardcopy*, Reference Article, 3–87  
Probe  
    *Doing a Probe Cal*, 3–49  
    How to connect to circuit (basic), 3–97  
    How to install, 3–97  
    *Probing of Circuits*, 3–97  
    To avoid damage to, 3–98  
Probe accessories  
    Dual-lead adapter, 3–101, 3–102  
    Eight-wire loom, 3–102  
    Flex adapter, 3–101  
    Ground lead, 3–100



- Hand-held adapter, 3–100
- Marker tags, 3–102
- One-to-two adapter, 3–100
- SMT KlipChip, 3–100
- Y-lead adapter, 3–100
- Probe Cal, 3–49–3–52
  - How to erase, 3–51
  - How to run, 3–49
  - When you change probes, 3–51
- Probes
  - Accessories with, 3–98–3–104
  - Calibration, Glossary–8
  - Connection, 1–7
  - Definition, Glossary–8
  - description, 3–97–3–104
  - Option 24 to add, A–1
- Probing of Circuits*, Reference Article, 3–97
- Product description, 1–1
- Product Specification, 1–2
- Propagation delay, 3–68
- Pulse trigger, 2–14, 3–141
- Pulse Trigger menu, 2–10
- Pulse**, Main Trigger menu, 3–143, 3–162
- Pulses, Triggering on, 3–141

## Q

- Quantizing, Glossary–8

## R

- Rack mounting, A–2
- Readout
  - Acquisition, 3–19
  - Channel, 2–6, 3–117, 3–176
  - Cursor, 3–82
  - Cursors, 2–6
  - Edge trigger, 3–127
  - General purpose knob, 2–6
  - Horizontal, 3–4
  - Measurement, 2–29, 3–67, 3–71
  - of Automatic measurements, 3–68
  - Record view, 2–6
  - Snapshot, 3–78
  - Time Base, 3–4
  - Time base, 2–6
  - Trigger, 2–6, 3–161
  - Trigger Level Bar, 3–37
  - Trigger Point, 3–37
  - Vertical, 3–9, 3–25
  - vertical, 3–56
- Readout options, How to set, 3–37
- Readout**, Display menu, 3–37
- Real-time sampling, Glossary–8
- Rear panel, 2–5
- Recall, Setups, 3–105–3–108
- Recall Factory Setup**, Save/Recall Setup menu, 3–107
- Recall Saved Setup**, Save/Recall Setup menu, 3–107
- Recalling, Waveforms, 3–109
- Record length, 1–1, 2–19, 3–5, Glossary–8
- Record Length**, Horizontal menu, 3–5
- Record View, 2–6, 2–23, 3–4, 3–9, 3–161
- RecordLength, Measurement variable, B–2
- Ref**, Color menu, 3–45
- Ref1, Ref2, Ref3, Ref4, File**, Save/Recall Waveform menu, 3–113
- Ref1, Ref2, Ref3, Ref4**, Reference waveform status, 3–113
- Reference Groups
  - Description of, 3–109
  - How to change to color of, 3–45
  - How to delete, 3–114, 3–115
  - How to display, 3–113
  - How to recall from disk, 3–114
  - How to store to a floppy disk, 3–111
  - How to store to memory, 3–110
  - Saving and Recalling Waveforms*, 3–109
  - Why use, 3–109
- Reference Levels**, Measure menu, B–2
- Reference levels, 1–25, 3–73
- Reference Levels**, Measure menu, 3–73
- Reference memory, Glossary–8
- Remote communication, 3–31–3–34
- Remote operation
  - Communicating with Remote Instruments*, 3–31
  - Connecting to the GPIB, 3–33
  - GPIB interface requirements, 3–31
  - GPIB Protocols, 3–31
  - Interconnect cabling, 3–32
  - Preparation for, 3–31
  - Procedures for, 3–33
  - Selecting and configuring the port, 3–33
- Remove Measrmt**, Measure menu, 3–71, 3–78
- Rename**, File Utilities menu, 3–63
- Reset All Mappings To Factory**, Color menu, 3–46
- Reset All Palettes To Factory**, Color menu, 3–46
- Reset Current Palette To Factory**, Color menu, 3–46
- Reset to Factory Color**, Color menu, 3–43
- Reset Zoom Factors**, Zoom menu, 3–178
- Restore Colors**, Color menu, 3–46
- Rise time, 1–24, 3–70, Glossary–9
  - Measurement algorithm, B–11
- Rising edge, Main Trigger menu, 3–128
- RLE Color**, Hardcopy menu, 3–89

- RMS, 3–70, Glossary–9
  - Measurement algorithm, B–12
- RS-232, **Port**, 3–31
- RS-232, **Port**, 3–89
- RUN/STOP button only**, Acquire menu, 3–20
- RUN/STOP**, Acquire menu, 3–20
  
- S**
- Safety, ix
  - Symbols, ix
- Sample acquisition mode, 3–17, Glossary–9
- Sample interval, Glossary–9
- Sample rate, 1–1
- Sample**, Acquire menu, 3–19
- Sampling, 2–20, Glossary–9
- Saturation**, Color menu, 3–44
- Save, Setups, 3–105–3–108
- Save Current Setup**, Save/Recall Setup menu, 3–105
- Save Group**, Save/Recall Waveform menu, 3–110
- Save/Recall **SETUP** button, 1–8, 3–62
- Save/recall **SETUP** button, 3–105
- Save/Recall Setup menu, 2–11, 3–105
  - factory** status, 3–106
  - Recall Factory Setup**, 3–107
  - Recall Saved Setup**, 3–107
  - Save Current Setup**, 3–105
  - user** status, 3–106
- Save/Recall **WAVEFORM** button, 3–62, 3–106, 3–107, 3–110, 3–111
- Save/Recall Waveform menu, 2–11, 3–106, 3–107, 3–110, 3–111
  - active** status, 3–110
  - Delete Refs**, 3–114
  - empty** status, 3–110
  - File Utilities**, 3–115
  - Ref1, Ref2, Ref3, Ref4, File**, 3–113
  - Save Group**, 3–110
  - To Ref1, To Ref2, To Ref3, To Ref4, File**, 3–110
- Saving and recalling setups, 1–29, 3–105
- Saving and recalling waveforms, 3–109
- Saving Setups*, Tutorial Example, 1–29
- seconds**, Cursor menu, 3–85
- Security bracket, 2–5
- Select** button, 3–85
- Select Measrmt**, Measure menu, 3–70, 3–75, 3–76
- Select**, Group menu, 3–27
- Selected Channel, Significance of, 3–117
- Selected Channel**, Group menu, 3–14
- Selected Group, Significance of, 3–117
- Selected group, Glossary–9
  - How to check for, 3–117
  - How to select, 3–119
- Selected waveform, Glossary–9
- Selecting Groups and Channels*, Reference Article, 3–117
- Self test, 1–5
- Sequence, Triggering on, 3–147
- Sequence trigger
  - Logic Functions, 3–148
  - Time qualifiers vs. trigger events, 3–148
- SET LEVEL TO 50%** button, 3–129, 3–159
- Set Levels in % units**, Measure menu, 3–73
- Set Offset to 0 divs**, Group menu, 3–10
- Set Position to 0 divs**, Group menu, 3–9
- Set to 10%**, Horizontal menu, 3–6
- Set to 20%**, Horizontal menu, 3–5
- Set to 50%**, Horizontal menu, 3–5, 3–6
- Set to 50%**, Main Trigger menu, 3–159
- Set to 80%**, Horizontal menu, 3–5
- Set to 90%**, Horizontal menu, 3–6
- Set to ECL**, Main Trigger menu, 3–163
- Set to TTL**, Main Trigger menu, 3–163
- Setting Up for Examples*, Tutorial preparation, 1–7
- Settings**, Display menu, 3–35
- Setup, 3–70, Glossary–9
  - Measurement Algorithm, B–13
  - Save and recall, 3–105–3–108
  - Saving and Recalling Setups*, 3–105
  - To recall from floppy disk, 3–107
  - To recall from memory, 3–107
  - To recall the default, 3–107
  - To store in memory, 3–105
  - To store on a floppy disk, 3–106
- Setup menu, 1–8
- SHIFT** button, 3–8
- Shipping, C–1
- Side menu, Glossary–10
- Side menu buttons, 2–3, Glossary–10
- Signal Path Compensation, 1–3–1–6, 3–53–3–54
  - How to run, 3–53
- Signals, Triggering on, 3–159
- Sin(x)/x interpolation, 2–20, Glossary–5
  - How to set, 3–38
- Sin(x)/x interpolation**, Display settings menu, 3–38
- Single Acquisition Sequence**, Acquire menu, 3–20
- SINGLE TRIG** button, 3–21, 3–160
- Skew, 3–70, Glossary–10
  - Measurement Algorithm, B–14
- Slope, Glossary–10
- Slope**, Main Trigger menu, 3–128
- Slope, Trigger, 2–17
- SMT KlipChip, 3–100
- Snapshot, Readout, 3–78

- Snapshot of Measurements, 1–27, 3–78
    - Operating hints, 3–78
  - Snapshot**, Measure menu, 3–78
  - Software, 1–1
  - Software version, 3–173
  - Source**, Delayed Trigger menu, 3–126
  - Source**, Main Trigger menu, 3–128, 3–143
  - SPC
    - Doing a Signal Path Compensation*, 3–53
    - How to run, 3–53
  - Specification, 1–2
  - Spectral**, Color menu, 3–42
  - Spooler, Hardcopy, 3–92
  - Start, Measurement Variable, B–2
  - Start Pattern Logic Func**, Main Trigger menu, 3–152
  - Start up, 1–3
  - State Trigger, 3–165–3–170
  - State trigger, 3–165–3–170
    - Definitions, 3–165
    - Determining Status of, 3–166
  - State**, Main Trigger menu, 3–167
  - Status, *Viewing Status*, 3–173
  - STATUS** button, 3–173
  - Status menu, 2–11, 3–173–3–174
    - Banner**, 3–173
    - Display**, 3–173
    - Firmware version, 3–173
    - System**, 3–173
      - To check display colors setup with, 3–41
      - To check display setup with, 3–35
      - To check group definition with, 3–25
      - To check horizontal setup with, 3–5
      - To check vertical setup with, 3–9
    - Trigger**, 3–142, 3–173
    - Waveforms**, 3–173
  - Stop After**, Acquire menu, 3–20
  - Store User1 Preset**, Group menu, 3–29
  - Store User2 Preset**, Group menu, 3–29
  - Style, Display, 3–36
  - Style**, Display settings menu, 3–36
  - Switch, principal power, 1–4, 2–5
  - System**, Status menu, 3–173
  - System**, Utility menu, 3–88
- T**
- Taking Measurements Automatically*, Tutorial Example, 1–23
  - Talk/Listen Address**, Utility menu, 3–33
  - Tek Secure, 3–108, Glossary–10
  - Tek Secure Erase Memory**, Utility menu, 3–108
  - Temperature compensation, 3–53–3–54
  - Temperature**, Color menu, 3–42
  - Text/Grat**, Display menu, 3–37
  - Thinkjet, 3–87
  - Thinkjet**, Hardcopy menu, 3–89
  - Threshold, Trigger, 3–122
  - THRESHOLD** knob, 3–129, 3–159
  - TIFF, 3–87
  - TIFF**, Hardcopy menu, 3–89
  - Time base, Glossary–10
  - Time Base Readout, 3–4
  - Time Base**, Horizontal menu, 3–5, 3–124
  - Time qualification, And triggering, 3–132
  - Time Units**, Cursor menu, 3–85
  - Timing Diagram display mode
    - clipping with, 3–28
    - To set vertical height, 3–28
  - Timing diagram display mode, 3–23
  - Timing diagram mode, Glossary–7, Glossary–10
  - Timing Diagram**, Group menu, 3–26
  - To Ref1, To Ref2, To Ref3, To Ref4, To File**, Save/Recall Waveform menu, 3–110
  - TOGGLE** button, 2–28, Glossary–10
  - Tracking Mode, Cursor, 2–29
  - Tracking**, Cursor menu, 3–85
  - Trigger**, Status menu, 3–142
  - Trigger, 2–13–2–18, Glossary–11
    - AC Line Voltage, 2–14
    - After Delay, 3–121
    - And time qualification, 3–132
    - Auxiliary, 2–14
    - Delay, 2–17
    - Delayed, 3–121–3–126
    - Edge, 2–14, 3–127, Glossary–3
    - Events, 3–122
    - General control usage, 3–159
    - Glitch, 3–141, 3–142, Glossary–4
    - Holdoff, 2–15
    - Level, 2–17, Glossary–11
    - Logic, 2–14
    - Mode, 2–15
    - Pattern, 3–131–3–140, 3–147–3–158
    - Position, 2–16, 3–5
    - Pulse, 2–14, 3–141
    - Readout, 3–161
    - Slope, 2–13, 2–17
    - Source, 2–13
    - Sources and Thresholds, 3–122
    - State, 3–165–3–170
    - Status Lights, 3–160
    - Types, 3–162–3–164
    - Width, 3–141, 3–145
  - Trigger Bar, 2–6

**Trigger Bar Style**, Display menu, 3–37  
Trigger Level Bar, Readout, 3–37  
Trigger **MAIN LEVEL** knob, 1–14, 2–17  
Trigger menu, **Pattern**, 3–133  
**TRIGGER MENU** button, 3–124, 3–128, 3–134,  
3–143, 3–151, 3–162, 3–167  
Trigger Point, Readout, 3–37  
**Trigger Position**, Horizontal menu, 3–5  
Trigger Status Lights, 3–160  
**Trigger When**, Main Trigger menu, 3–137, 3–138,  
3–139, 3–154, 3–155, 3–157, 3–168, 3–169  
**Trigger**, Status menu, 3–173  
Triggerable After Events, Delay mode, 3–121  
Triggerable After Events/Time, Delay mode, 3–121  
Triggerable After Time, Delay mode, 3–121  
*Triggering After Delay*, Reference Article, 3–121  
*Triggering on a Sequence*, Reference Article, 3–147  
*Triggering on a Signals*, Reference Article, 3–159  
*Triggering on Edges*, Reference Article, 3–127  
*Triggering on Patterns*, Reference Article, 3–131  
*Triggering on Pulses*, Reference Article, 3–141  
*Triggering on States*, Reference Article, 3–165  
**TTL**, Group menu, 3–28  
Tutorial  
    *Displaying Waveforms*, 1–11  
    *Grouping Waveforms*, 1–17  
    *Saving Setups*, 1–29  
    *Setting Up for Examples*, 1–7  
    *Taking Measurements Automatically*, 1–23  
**Type**, Main Trigger menu, 3–128, 3–143, 3–162

## U

Undershoot, Glossary–6  
**user**, Saved setup status, 3–106  
**UTILITY** button, 3–33, 3–88  
Utility menu, 2–12, 3–88  
    **Configure**, 3–33, 3–88  
    **GPIB**, 3–33  
    **Hardcopy**, 3–33  
    **Hardcopy (Talk Only)**, 3–88  
    **I/O**, 3–88  
    **Off Bus**, 3–33  
    **OK Erase Ref & Panel Memory**, 3–108  
    **Port**, 3–33  
    **System**, 3–88  
    **Talk/Listen Address**, 3–33  
    **Tek Secure Erase Memory**, 3–108

## V

**Variable Persistence**, Display settings menu, 3–37

Variables, Used in measurement algorithms, B–1  
Vectors, 3–36

**Vectors**, Display settings menu, 3–36

Vertical

    Bar cursors, 2–28, 3–81, Glossary–11

    Control, 3–7–3–12

    Offset, 2–24, 3–10

    Position, 2–24, 3–9

**POSITION** knob, 2–24

    Readout, 3–9, 3–25

    readout, 3–56

    Scale, 3–8

**SCALE** knob, 1–13, 2–24

    System, 1–13, 2–24

Vertical Controls

    Avoiding clipping, 3–7

    Description, 3–7

    Scaling with digital display modes, 3–7

**Vertical Controls**, Group menu, 3–9

Vertical cursors, Binary Readout, 2–28

Vertical Menu

**Cal Probe**, 3–50

**OK Compensate Probes**, 3–50

**OK Initialize Probes**, 3–51

Vertical offset, Uses for, 3–10

Vertical **POSITION** knob, 3–8, 3–176

Vertical readout, Illustrated, 3–57

Vertical **SCALE** knob, 3–8, 3–176

Vertical Setup

    Adjusting bandwidth, 3–9

    Adjusting offset, 3–10

    Adjusting position, 3–8, 3–9

    Adjusting scale, 3–8

*Adjusting the Vertical Setup*, 3–7

    How to Adjust, 3–7

    How to check, 3–9

**Vhigh, min**, Group menu, 3–28

**View Palette**, Color menu, 3–42

*Viewing Help*, Reference Article, 3–171

*Viewing Status*, Reference Article, 3–173

**Vlow, max**, Group menu, 3–28

## W

WARNING, Statement in manual, ix

Waveform, Glossary–11

    Edge triggering on, 3–127

    Interval, Glossary–11

    Off priority, 3–120

Waveform group, 3–55

    see Group, Glossary–4

Waveform memory, 3–114

**WAVEFORM OFF** button, 1–16  
**Waveform**, Display menu, 3–37  
Waveforms  
    Automatic measurements of, 3–67  
    Cursor measurements of, 3–81  
    How to include in a group, 3–55  
**Waveforms**, Status menu, 3–173  
Width, 1–24, Glossary–6, Glossary–8  
Width trigger, 3–141, 3–145  
**Width**, Main Trigger menu, 3–145

## Y

Y-lead adapter, 3–100  
YT format, Glossary–11

## Z

Zoom, 3–175–3–178  
    And groups, 3–175  
    And interpolation, 3–175  
    Description, 3–175  
    Horizontal lock, 3–177  
    *Zooming on Waveforms*, 3–175  
**ZOOM** button, 3–176  
Zoom feature, 2–26  
Zoom menu  
    **Horizontal Lock**, 3–177  
    **Reset Zoom Factors**, 3–178  
    **Zoom Off**, 3–178  
*Zooming on Waveforms*, Reference Article, 3–175





