



Advanced Test Equipment Rentals
www.atecorp.com 800-404-ATEC (2832)

User's Reference

Publication number 01660-97034
Second edition, January 2000

For Safety information, Warranties, and Regulatory information, see the pages behind the index

© Copyright Agilent Technologies 1991 - 2000
All Rights Reserved

Agilent Technologies 1660A Series 50/100-MHz State, 500-MHz Timing Logic Analyzers

In This Book

The User's Reference manual contains field and feature definitions which explain the details of the instrument operation. Use this part of the manual set for information on what the menu fields do and what they are used for. This manual covers all 1660A Series analyzers.

The User's Reference is divided into two parts. The first part covers general product information such as, probing, using the front panel interface, using the keyboard and mouse, connecting a printer, disk drive operation, the RS-232/GPIB/Centronix interface, and the utilities menu. The second part covers the state and timing analyzers. It explains the analyzer menus and what they are used for. There are separately tabbed chapters for each analyzer menu, a chapter for error messages, and a chapter for instrument specifications. The common menu fields which are found in the majority of menus have been placed in a separate chapter. You will be referenced back to the "Common Menu Fields" chapter when these fields are encountered.

1	Introduction	
2	Probing	
3	Using the Front Panel Interface	
4	Using the Optional Keyboard and Mouse	
5	Connecting a Printer	
6	Disk Drive Operations	
7	The RS-232/GPIB Interface	
8	The Utilities Menu	
9	The Common Menu Fields	
10	The Configuration Menu	
11	The Format Menu	
12	The Trigger Menu	
13	The Listing Menu	
14	The Waveform Menu	
15	The Mixed Display Menu	

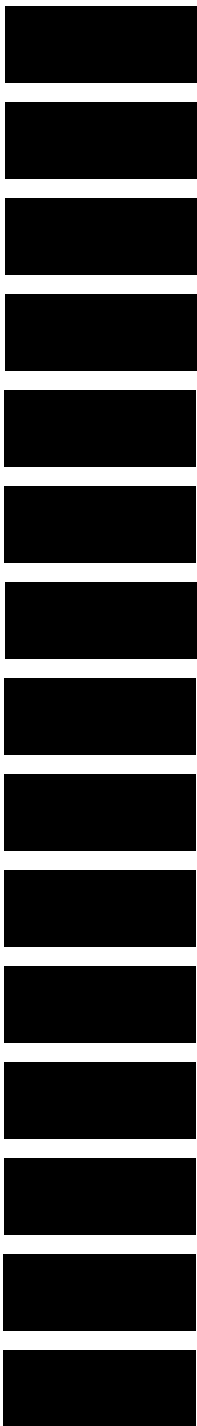

Analyzer type considerations

In the Configuration menu you have the choice of configuring an analyzer machine as either a State analyzer or a Timing analyzer. Some menus in the analyzer will change depending on the analyzer type you choose. For example, since a Timing analyzer does not use external clocks, the clock assignment fields in the Format menu will not be available.

If a menu field is only available to a particular analyzer type, the field is designated (Timing only) or (State only) after the field name. If no designation is shown, the field is available for both types.

16	The Chart Menu	
17	The Compare Menu	
18	Error Messages	
19	Specifications and Characteristics	
20	Operator's Service	
	Index	

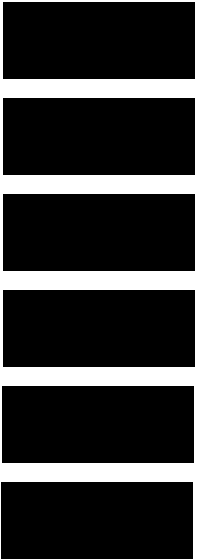

Contents

1 Introduction

- User Interface 1-4
- Configuration Capabilities 1-5
- Key Features 1-7
- Accessories Supplied 1-8
- Accessories Available 1-9

2 Probing

- General-Purpose Probing System Description 2-5
- Assembling the Probing System 2-8

3 Using the Front-Panel Interface

- Front-Panel Controls 3-3
- Rear-Panel Controls and Connectors 3-8
- How to Power-up The Analyzer 3-10
- How to Select Menus 3-11
- How to Select the System Menus 3-13
- How to Select Fields 3-15
- How to Configure Options 3-18
- How to Enter Numeric Data 3-19
- How to Enter Alpha Data 3-21
- How to Roll Offscreen Data 3-23
- How to Use Assignment/Specification Menus 3-25

4 Using the Mouse and the Optional Keyboard

- Moving the Cursor 4-3
- Entering Data into a Menu 4-4
- Using the Keyboard Overlays 4-5
- Defining Units of Measure 4-7
- Assigning Edge Triggers 4-8
- Closing a Menu 4-8

5 Connecting a Printer

- GPIB Printers 5-3
- RS-232C Printers 5-8
- Parallel Printers (1664A Only) 5-13
- Connecting to Other Hewlett-Packard Printers 5-15
- Printing the Display 5-17

6 Disk Drive Operations

- How to Access the Disk Menu 6-5
- How to Install a Disk 6-6
- How to Select a Disk Operation 6-7
- How to Load a File 6-8
- How to Format a Disk 6-10
- How to Store Files on a Disk 6-12
- How to Rename a File 6-15
- How to Autoload a File 6-17
- How to Purge a File 6-19
- How to Copy a File 6-20
- How to Pack a Disk 6-22
- How to Duplicate a Disk 6-23
- How to Make a Directory 6-25

7 The RS-232C, GPIB, and Centronix Interface

- The GPIB Interface 7-8
- The RS-232C Interface 7-10
- The Centronix Interface (1664A Only) 7-13
- Configuring the Interface for a Controller or a Printer (1660A through 1663A Only) 7-14

8 The System Utilities

- Real Time Clock Adjustments (1660A Through 1663A Only) 8-4
- Update FLASH ROM (1660A Through 1663A Only) 8-5
- Display Grey Shade Adjustments 8-5
- Sound On / Off 8-5

9 The Common Menu Fields

System/Analyzer Field 9-4
Menu Field 9-5
Print Field 9-6
Run/Stop Field 9-9
Base Field 9-10
Label Field 9-11
Label / Base Roll Field 9-13

10 The Configuration Menu

Name Field 10-3
Type Field 10-4
Unassigned Pods List 10-5
Activity Indicators 10-7
System / Analyzer Field 10-8
Menu Field 10-8
Print Field 10-8
Run Field 10-8

11 The Format Menu

State Acquisition Mode Field (State only) 11-4
Timing Acquisition Mode Field (Timing only) 11-5
Clock Inputs Display 11-13
Pod Field 11-14
Pod Clock Field (State only) 11-15
Pod Threshold Field 11-19
Master and Slave Clock Field (State only) 11-21
Setup/Hold Field (State only) 11-23
Symbols Field 11-25
Label and Pod Rolling Fields 11-29
Label Assignment Fields 11-30
Label Polarity Fields 11-32
Bit Assignment Fields 11-33
System / Analyzer Field 11-35
Menu Field 11-35

Print Field 11-35

Run Field 11-35

12 The Trigger Menu

Trigger Sequence Levels 12-6

Modify Trigger Field 12-8

Pre-defined Trigger Macros 12-11

Using Macros to Create a Trigger Specification 12-13

Timing Trigger Macro Library 12-14

State Trigger Macro Library 12-16

Modifying the User-level Macro 12-19

Resource Terms 12-26

Assigning Resource Term Names and Values 12-28

Label and Base Fields 12-32

Arming Control Field 12-33

Acquisition Control 12-36

Trigger Position Field 12-37

Sample Period Field 12-38

Branches Taken Stored / Not Stored Field 12-38

Count Field (State only) 12-39

13 The Listing Menu

Markers Field 13-4

Pattern Markers 13-5

Find X-pattern / O-pattern Field 13-6

Pattern Occurrence Fields 13-7

From Trigger / Start / X Marker Field 13-8

Specify Patterns Field 13-9

Stop Measurement Field 13-13
 Clear Pattern Field 13-16

Time Markers 13-17
 Trig to X / Trig to O Fields 13-18

Statistics Markers 13-19

States Markers (State only) 13-21
 Trig to X / Trig to O Fields 13-22
 Data Roll Field 13-23
 Label and Base Fields 13-24
 Label / Base Roll Field 13-24
 System / Analyzer Field 13-25
 Menu Field 13-25
 Print Field 13-25
 Run Field 13-25

14 The Waveform Menu

Acquisition Control Field 14-5
 Accumulate Field 14-6
 States Per Division Field (State only) 14-7
 Seconds Per Division Field (Timing only) 14-8
 Delay Field 14-9
 Sample Period Display (Timing only) 14-10
 Markers Field 14-12

Pattern Markers 14-13
 X-pat / O-pat Occurrence Fields 14-14
 From Trigger / Start / X Marker Field 14-15
 X to O Display Field (Timing only) 14-16
 Center Screen Field 14-17
 Specify Patterns Field 14-18
 Stop Measurement Field 14-22
 Clear Pattern Field 14-25

Contents

Time Markers 14-26
Trig to X / Trig to O Fields 14-27
Marker Label / Base and Display 14-28

Statistics Markers 14-29

States Markers (State only) 14-31
Trig to X / Trig to O Fields 14-32
Marker Label / Base and Display 14-33

Waveform Display 14-34
Waveform Label Field 14-36
System / Analyzer Field 14-39
Menu Field 14-39
Print Field 14-39
Run Field 14-39

15 The Mixed Display Menu

Inserting Waveforms 15-3
Interleaving State Listings 15-3
Time-Related Displays 15-4
Markers 15-5

16 The Chart Menu

Selecting the Axes for the Chart 16-6
Y-axis Label Value Field 16-7
X-axis Label / State Type Field 16-8

Scaling the Axes 16-9
Min and Max Scaling Fields 16-10
Markers / Range Field 16-11

Pattern Markers 16-12
Find X-pattern / O-pattern Field 16-13
Pattern Occurrence Fields 16-14
From Trigger / Start / X-Marker Fields 16-15
Specify Patterns Field 16-16
Stop Measurement Field 16-19
Clear Pattern Field 16-22

Time Markers 16-23
Trig to X / Trig to O Fields 16-24

Statistics Markers 16-25

States Markers 16-27
Trig to X / Trig to O Fields 16-28
System / Analyzer Field 16-29
Menu Field 16-29
Print Field 16-29
Run Field 16-29

17 The Compare Menu

Reference Listing Field 17-5
Difference Listing Field 17-6
Copy Listing to Reference Field 17-8
Find Error Field 17-9
Compare Full / Compare Partial Field 17-10
Mask Field 17-11
Specify Stop Measurement Field 17-12
Data Roll Field 17-15
Bit Editing Field 17-16
Label and Base Fields 17-17
Label / Base Roll Field 17-17
System / Analyzer Field 17-18
Menu Field 17-18

Contents

Print Field 17-18

Run Field 17-18

18 Error Messages

Error Messages 18-3

Warning Messages 18-5

Advisory Messages 18-8

19 Specifications and Characteristics

Specifications 19-3

Specifications and Characteristics 19-4

20 Operator's Service

Preparing For Use 20-3

To inspect the logic analyzer 20-4

Ferrites (1664A Only) 20-4

To apply power 20-6

To operate the user interface 20-6

To set the line voltage 20-7

To degauss the display 20-8

To clean the logic analyzer 20-8

To test the logic analyzer 20-8

Troubleshooting 20-9

To use the flowcharts 20-9

To check the power-up tests 20-12

To run the self-tests (1660A through 1663A) 20-13

To run the self-tests (1664A) 20-19

To test the auxiliary power 20-26



Introduction

Logic Analyzer Description

The Agilent Technologies 1660A Series Logic Analyzers are part of a new generation of general-purpose logic analyzers. The 1660A Series consists of five different models ranging in channel width from 34 channels to 136 channels. State speed is either 50-MHz or 100-MHz (depending on the model), and all models have 500-MHz timing speeds. The 1660A series logic analyzers are designed as full-featured stand-alone instruments for use by digital and microprocessor hardware and software designers. All models have GPIB, RS-232C, and/or Centronix interfaces for hard copy printouts and control by a host computer.

- The 1660A has 100-MHz state speed, 130 data channels, six data/clock channels, and both GPIB/RS-232C interfaces.
- The 1661A has 100-MHz state speed, 96 data channels, six data/clock channels, and both GPIB/RS-232C interfaces.
- The 1662A has 100-MHz state speed, 64 data channels and four data/clock channels, and both GPIB/RS-232C interfaces.
- The 1663A has 100-MHz state speed, 32 data channels, two data/clock channels, and both GPIB/RS-232C interfaces.
- The 1664A has 50-MHz state speed, 32 data channels, two data/clock channels, and a Centronix interface (GPIB/RS-232C available as options).

Memory depth is 4 Kbytes per channel in all pod pair groupings, or 8 Kbytes per channel on one pod of a pod pair (half channel mode).

Measurement data is displayed as data listings and waveforms, and can also be plotted on a chart or compared to a reference image.

The 50/100-MHz state analyzer has master, master/slave, and demultiplexed clocking modes available. Measurement data can be stamped with state or time tags. For triggering and data storage, the state analyzer uses 12 sequence levels with two-way branching, 10 pattern resource terms, 2 range terms, and 2 timers.



The 500-MHz timing analyzer has conventional, transitional, and glitch timing modes with variable width, depth, and speed selections. Sequential triggering uses 10 sequence levels with two-way branching, 10 pattern resource terms, 2 range terms, 2 edge terms and 2 timers.

User Interface

The 1660 Series analyzers have several easy-to-use user interface devices: the knob, the front panel arrow keys and keypad, the mouse, and the optional keyboard.

Front panel arrow keys move the highlighter to identify the desired field, then a front panel Select key is pressed to activate the field. The knob quickly moves the highlighter (cursor) in certain menus to highlight options to select and to quickly change numeric assignment fields.

The keypad on the front panel is used to enter alpha and numeric data into assignment fields. A mouse and an optional full size keyboard are also available.

To select a field with the mouse, position the cursor (+) of the mouse over the desired field and press the button on the upper-left corner of the mouse. The optional keyboard can control all instrument functions by using special function keys, the arrow keys, and the Enter key. Alpha and numeric entry is simply typed in.

See Also

"Using the Mouse and the Optional Keyboard" found later in this manual for more information.

"Using the Front-Panel Interface" found later in this manual for more details on using the standard interface devices.

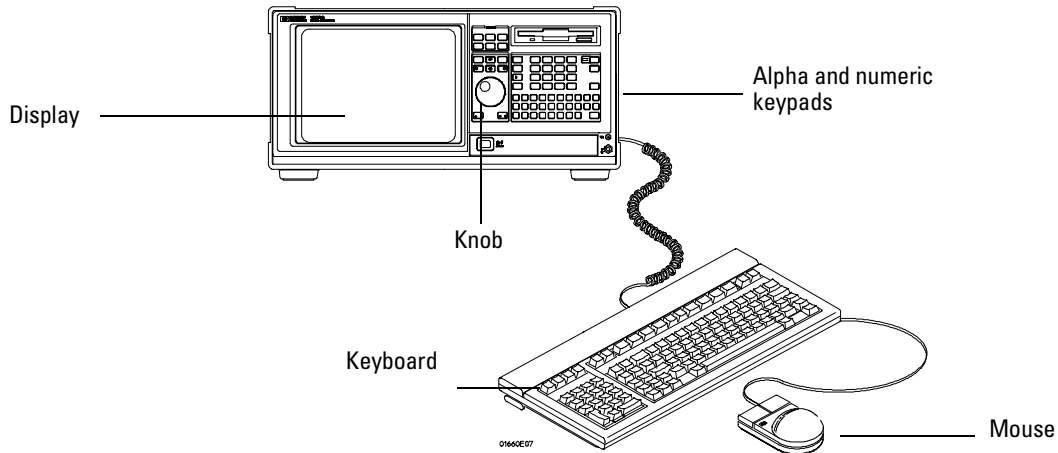

Front-Panel Interface Devices



Configuration Capabilities

The five analyzer models in the 1660 Series offer a wide variety of channel widths and memory depth combinations. The number of data channels range from 34 channels with the 1664A, up to 136 channels with the 1660A. In addition, a half channel acquisition mode is available which doubles memory depth from 4 Kbytes to 8 Kbytes per channel while reducing channel width by half.

The configuration guide below illustrates the memory depth/channel width combinations in all acquisition modes with all analyzer models.

State Analyzer Configurations

	1660A	1661A	1662A	1663A	1664A
Half channel 50/100 MHz	8K-deep / 68 chan. 65 data + 3 data or clock	8K-deep / 51 chan. 48 data + 3 data or clock	8K-deep / 34 chan. 32 data + 2 data or clock	8K-deep / 17 chan. 16 data + 1 data or clock	8K-deep / 17 chan. 16 data + 1 data or clock
Full channel 50/100 MHz	4K-deep / 136 chan. 130 data + 6 data or clock	4K-deep / 102 chan. 96 data + 6 data or clock	4K-deep / 68 chan. 64 data + 4 data or clock	4K-deep / 34 chan. 32 data + 2 data or clock	4K-deep / 34 chan. 32 data + 2 data or clock

State Analyzer Configuration Considerations

- Unused clock channels can be used as data channels.
- With Time or State tags turned on, memory depth is reduced by half. However, full depth is retained if you leave one pod pair unassigned.
- Maximum of 6 clocks in the 1660A model.

Timing Analyzer Configurations

	1660A	1661A	1662A	1663A	1664A
Conventional half channel 500 MHz	8K-deep / 68 chan. 65 data + 3 data or clock	8K-deep / 51 chan. 48 data + 3 data or clock	8K-deep / 34 chan. 32 data + 2 data or clock	8K-deep / 17 chan. 16 data + 1 data or clock	8K-deep / 17 chan. 16 data + 1 data or clock
Conventional full channel 250 MHz	4K-deep / 136 chan. 130 data + 6 data or clock	4K-deep / 102 chan. 96 data + 6 data or clock	4K-deep / 68 chan. 64 data + 4 data or clock	4K-deep / 34 chan. 32 data + 2 data or clock	4K-deep / 34 chan. 32 data + 2 data or clock
Transitional half channel 250 MHz	8K-deep / 68 chan. 65 data + 3 data or clock	8K-deep / 51 chan. 48 data + 3 data or clock	8K-deep / 34 chan. 32 data + 2 data or clock	8K-deep / 17 chan. 16 data + 1 data or clock	8K-deep / 17 chan. 16 data + 1 data or clock
Transitional full channel 125 MHz	4K-deep / 136 chan. 130 data + 6 data or clock	4K-deep / 102 chan. 96 data + 6 data or clock	4K-deep / 68 chan. 64 data + 4 data or clock	4K-deep / 34 chan. 32 data + 2 data or clock	4K-deep / 34 chan. 32 data + 2 data or clock
Glitch half channel 125 MHz	4K-deep / 68 chan. 65 data + 3 data or clock	4K-deep / 51 chan. 48 data + 3 data or clock	4K-deep / 34 chan. 32 data + 2 data or clock	4K-deep / 17 chan. 16 data + 1 data or clock	4K-deep / 17 chan. 16 data + 1 data or clock

Timing Analyzer Configuration Considerations

- Unused clock channels can be used as data channels
- In Glitch half channel mode, memory is split between data and glitches.



Key Features

Key features of the 1660A Series are listed below:

Analyzers

- 50-MHz (1664A) or 100-MHz state (1660A through 1663A), and 500-MHz timing acquisition speed.
- Variety of channel widths ranging from 34 channels with the 1664A, up to 136 channels with the 1660A.
- Lightweight, passive probes for easy hookup and compatibility with previous Agilent logic analyzers and preprocessors.
- GPIB and RS-232C interfaces (1660A through 1663A) or Centronix interface (1664A) for programming and hard copy printouts (GPIB and RS-232C interfaces are optional on the 1664A).
- Variable setup/hold time in the State analyzer.
- External triggering to/from other instruments through rear-panel BNCs.
- 4 Kbytes-deep memory on all channels with 8 Kbytes-deep in half channel modes.
- Marker measurements.
- Pre-configured trigger macros. 12 levels of trigger sequencing for state and 10 levels of sequential triggering for Timing.
- Both state and timing analyzers can use 10 pattern resource terms, 2 range terms, and 2 timer/counters to qualify and trigger on data. In addition, the timing analyzer has 2 edge terms.
- 50-MHz (1664A) or 100-MHz (1660A through 1663A) time and number-of-states tagging.
- Full programmability.
- State/State and mixed State/Timing displays.
- Compare, Chart, and Waveform displays.

Accessories Supplied

The table below lists the accessories supplied with your logic analyzer. If any of these accessories are missing, contact your nearest Agilent Technologies sales office.

Accessories	Quantity
Probe tip assemblies	Note 1
Quick Start Training Kit	1*
Programming Reference	1*
Probe cables	Note 2
Grabbers (20 per pack)	Note 1
Extra probe leads (5 per pack)	Note 3
Operating system disks	1 (Note 4)
User's Reference	1
Accessories pouch	1
Mouse	1

Note 1 Quantities : 8 - 1660A
6 - 1661A
4 - 1662A
2 - 1663A and 1664A

Note 2 Quantities : 4 - 1660A
3 - 1661A
2 - 1662A
1 - 1663A and 1664A

Note 3 Quantities : 8 - 1660A
6 - 1661A
4 - 1662A
2 - 1663A
0 - 1664A

Note 4 The 1664A requires an Operating System disk for turn-on and boot-up.
Operation of the analyzer is not possible without this disk.

* Standard equipment (or supplied accessory) for all models except the 1664A. Items can be ordered as an option for the 1664A.

See Also

Accessories for Agilent Logic Analyzers if you need additional accessories.



Accessories Available

There are a number of accessories available that will make your measurement tasks easier and more accurate. You will find these listed in *Accessories for Agilent Logic Analyzers*. The table below lists additional documentation that is available from your nearest Agilent Technologies sales office for use with your logic analyzer.

Accessories Available	Quantity
Quick Start Training Kit	1*
Programming Reference	1*
Service Guide	1

* Standard equipment for all models except the 1664A. Items can be ordered as an option for the 1664A.

Preprocessor Modules

The preprocessor module accessories enable you to quickly and easily connect the logic analyzer to your microprocessor under test.

Included with each preprocessor module is a 3.5-inch disk which contains a configuration file and an inverse assembler file. When you load the configuration file, it configures the logic analyzer for making state measurements on the microprocessor for which the preprocessor is designed.

Configuration files from other analyzers can also be loaded. For information on translating other configuration files into the analyzer, refer to the applicable preprocessor manual.

The inverse assembler file is a software routine that will display captured information in a specific microprocessor's mnemonics. The DATA field in the State Listing is replaced with an inverse assembly field. The inverse assembler software is designed to provide a display that closely resembles the original assembly language listing of the microprocessor's software. It also identifies the microprocessor bus cycles captured, such as Memory Read, Interrupt Acknowledge, or I/O Write.

Many of the preprocessor modules require the Agilent Technologies 10269C General-Purpose Probe Interface. The probe interface accepts the specific preprocessor PC board and connects it to five connectors on the general-purpose interface to which the logic analyzer probe cables connect.



See Also

Accessories for Logic Analyzers for a list of preprocessor modules and their descriptions.



Probing

Probing

This chapter contains a description of the probing system for the logic analyzer. It also contains the information you need for connecting the probe system components to each other, to the logic analyzer, and to the system under test.

Probing Options

You can connect the logic analyzer to your system under test in one of the following ways:

- Agilent Technologies 10320C User-Definable Interface (optional).
- Microprocessor and bus specific interfaces (optional).
- Standard general-purpose probing (provided).
- Direct connection to a 20-pin, 3M-Series type header connector using the optional termination adapter.

The 10320C User-Definable Interface

The optional 10320C User-Definable Interface module combined with the optional Agilent Technologies 10269C General Purpose Probe Interface allows you to connect the logic analyzer to the microprocessor in your target system. The 10320C includes a breadboard that you custom wire for your system.

Another option for use with the interface module is the Agilent Technologies 10321A Microprocessor Interface Kit. This kit includes sockets, bypass capacitors, and a fuse for power distribution. Also included are wire-wrap headers to simplify wiring of your interface when you need active devices to support the connection requirements of your system.

See Also

Accessories for Agilent Logic Analyzers for additional information about the interface module and the microprocessor interface kits.

Microprocessor and Bus Specific Interfaces

There are a number of microprocessor and bus specific interfaces available as optional accessories that are listed in the *Accessories for Agilent Logic Analyzers*. Microprocessors are supported by Universal Interfaces or Preprocessor Interfaces, or in some cases, both.

Universal Interfaces are aimed at initial hardware turn-on, and will provide fast, reliable, and convenient connections to the microprocessor system.

Preprocessor interfaces are aimed at hardware turn-on and hardware/software integration, and will provide the following:

- All clocking and demultiplexing circuits needed to capture the system's operation.
- Additional status lines to further decode the operation of the CPU.
- Inverse assembly software to translate logic levels captured by the logic analyzer into microprocessor mnemonics.

Bus interfaces will support bus analysis for the following:

- Bus support for GPIB, RS-232C, RS-449, SCSI, VME, and VXI.

General-Purpose Probing

General-purpose probing involves connecting the logic analyzer probes directly to your target system without using any interface. General-purpose probing does not limit you to specific hookup schemes, for an example, as the probe interface does.

General-purpose probing uses grabbers that connect to both through hole and surface mount components. General-purpose probing comes as the standard probing option. You will find a full description of its components and use later in this chapter.

The Termination Adapter

The optional termination adapter allows you to connect the logic analyzer probe cables directly to test ports on your target system without the probes.

The termination adapter is designed to connect to a 20 (2x10) position, 4-wall, low-profile, header connector which is a 3M-Series 3592 or equivalent.

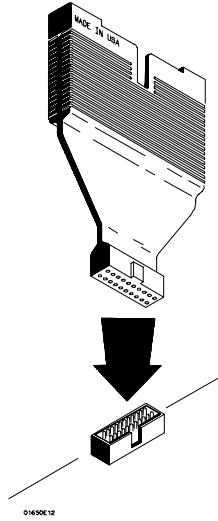

Termination Adapter

General-Purpose Probing System Description

The standard probing system provided with the logic analyzer consists of a probe tip assembly, probe cable, and grabbers. Because of the passive design of the probes, there are no active circuits at the outer end of the cable. The rest of this chapter is dedicated to general-purpose probing.

The passive probing system is similar to the probing system used with high-frequency oscilloscopes. It consists of a series RC network (90 k Ω in parallel with 8 pF) at the probe tip, and a shielded, resistive transmission line. The advantages of this system include the following:

- 250 Ω in series with 8-pF input capacitance at the probe tip for minimal loading.
- Signal ground at the probe tip for high-speed timing signals.
- Inexpensive, removable probe tip assemblies.

Probe Tip Assemblies

Probe tip assemblies allow you to connect the logic analyzer directly to the target system. This general-purpose probing is useful for discrete digital circuits. Each probe tip assembly contains 16 probe leads (data channels), 1 clock lead, a pod ground lead, and a ground tap for each of the 16 probe leads.

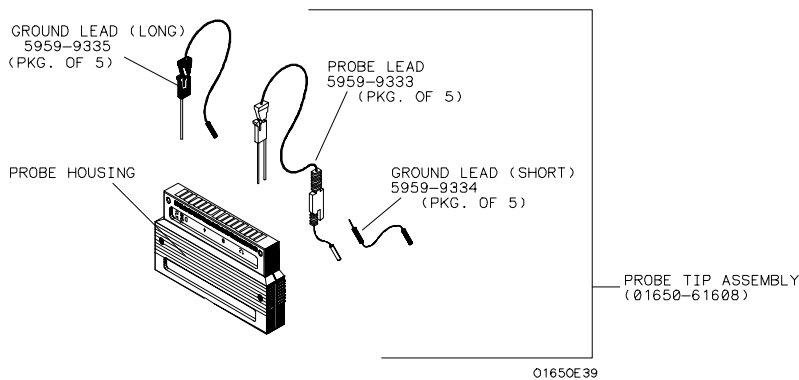

Probe Tip Assembly

Probe and Pod Grounding

Each pod is grounded by a long, black, pod ground lead. You can connect the ground lead directly to a ground pin on your target system or use a grabber. To connect the ground lead to grounded pins on your target system, you must use 0.63-mm (0.025-in) square pins, or use round pins with a diameter of 0.66 mm (0.026 in) to 0.84 mm (0.033 in). The pod ground lead must always be used.

Each probe can be individually grounded with a short black extension lead that connects to the probe tip socket. You can then use a grabber or the grounded pins on your target system in the same way you connect the data lines.

When probing signals with rise and fall times of ≤ 1 ns, grounding each probe lead with the 2-inch ground lead is recommended. In addition, always use the probe ground on a clock probe.

Probe Leads

The probe leads consists of one 12-inch, twisted-pair cable; one ground tap; and one grabber. The probe lead, which connects to the target system, has an integrated RC network with an input impedance of $100\text{ k}\Omega$ in parallel with approximately 8 pF , and all in series with $250\ \Omega$. The probe lead has a two-pin connector on one end that snaps into the probe housing.

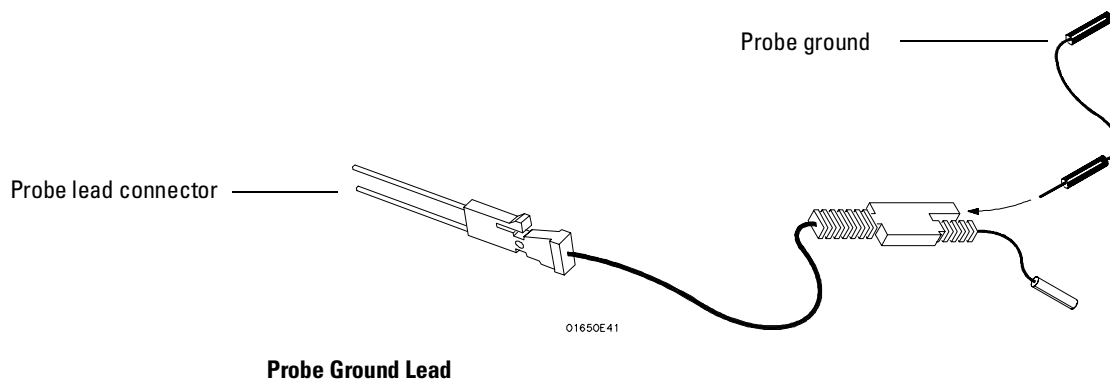



Grabbers

The grabbers have a small hook that fits around the IC pins and component leads. The grabbers have been designed to fit on adjacent IC pins on either through hole or surface mount components with lead spacing greater than or equal to 0.050 inches.

Probe Cable

The probe cable contains 18 signal lines, 17 chassis ground lines and two power lines for preprocessor use. The cables are woven together into a flat ribbon that is 4.5 feet long. The probe cable connects the logic analyzer to the pods, termination adapter, Agilent Technologies 10269C General-Purpose Probe Interface, or preprocessor. Each cable is capable of carrying 0.33 amps for preprocessor power.

CAUTION

DO NOT exceed this 0.33 amps per cable or the cable will be damaged.

Preprocessor power is protected by a current limiting circuit. If the current limiting circuit is activated, the fault condition must be removed. After the fault condition is removed, the circuit will reset in one minute.

NOTE

1663A and 1664A analyzers use the same pod labels.

Minimum Signal Amplitude

Any signal line you intend to probe with the logic analyzer probes must supply a minimum voltage swing of 500 mV to the probe tip. If you measure signal lines with a voltage swing of less than 500 mV, you may not obtain a reliable measurement.

Maximum Probe Input Voltage

The maximum input voltage of each logic analyzer probe is ± 40 volts peak.

Pod Thresholds

Logic analyzer pods have two preset thresholds and a user-definable pod threshold. The two preset thresholds are ECL (-1.3 V) and TTL ($+1.5$ V). The user-definable threshold can be set anywhere between -6.0 volts and $+6.0$ volts in 0.05 volt increments.

All pod thresholds are set independently.

Assembling the Probing System

The general-purpose probing system components are assembled as shown to make a connection between the measured signal line and the pods displayed in the Format menu.

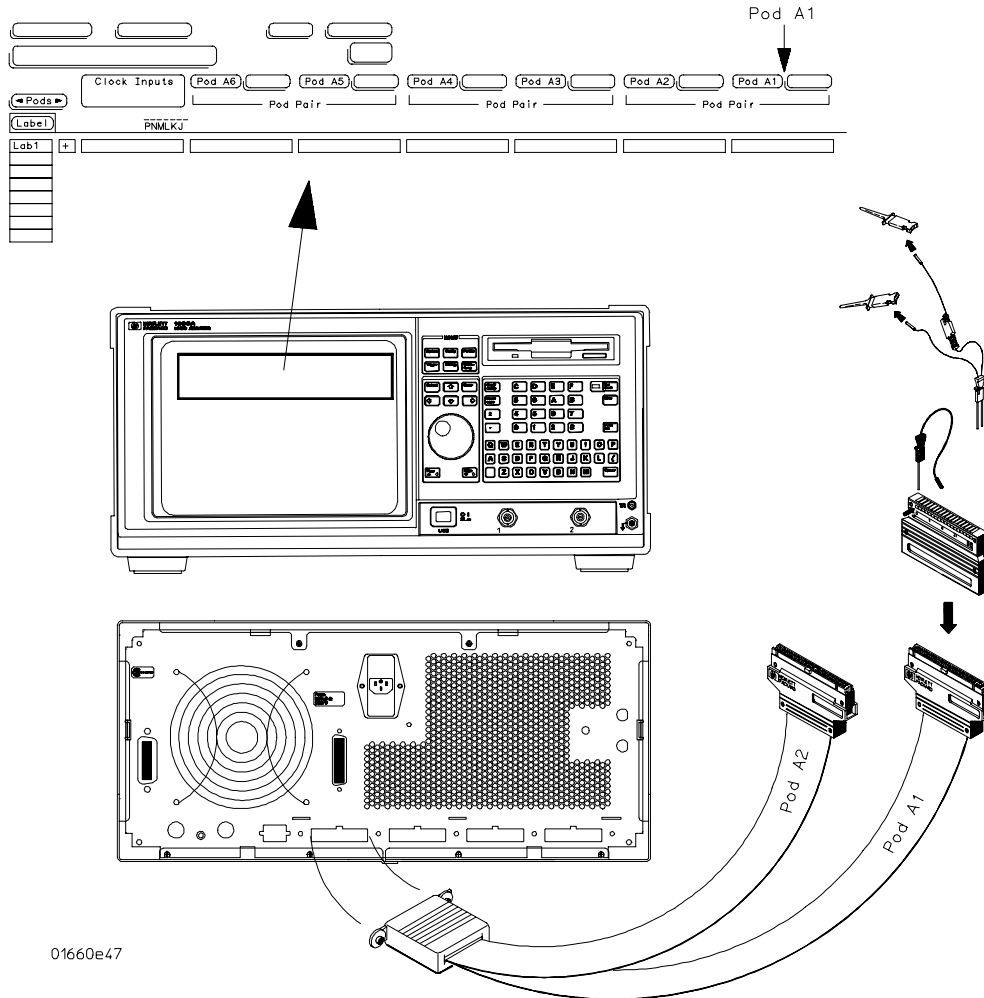

01660e47

Connecting Probe Cables to the Logic Analyzer



Connecting Probe Cables to the Logic Analyzer

All probe cables are installed at the factory. If you need to replace a probe cable, refer to the Service Guide that is supplied with the logic analyzer.

Connecting the Probe Tip Assembly to the Probe Cable

To connect a probe tip assembly to a cable, align the key on the cable connector with the slot on the probe housing and press them together.

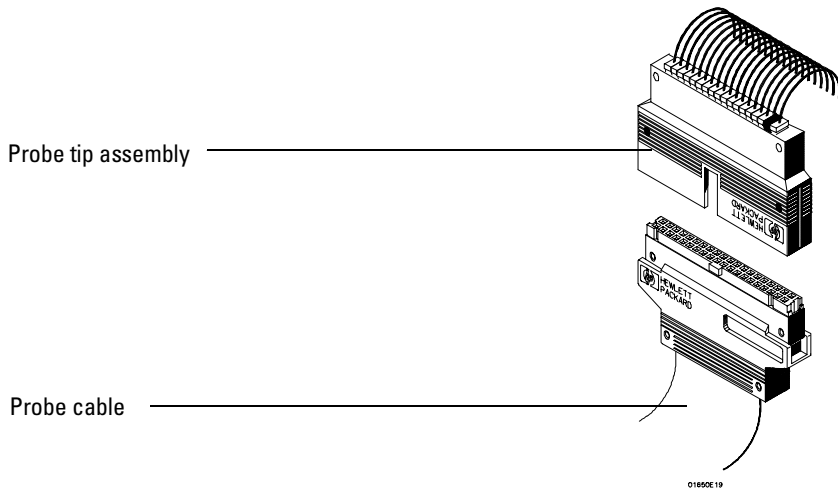

Connecting Probe Tip Assembly

Disconnecting Probe Leads from Probe Tip Assemblies

When you receive the logic analyzer, the probe leads are already installed in the probe tip assemblies. To keep unused probe leads out of your way during a measurement, you can disconnect them from the pod.

To disconnect a probe, insert the tip of a ball-point pen into the latch opening. Push on the latch while gently pulling the probe out of the pod connector as shown in the figure.

To connect the probes into the pods, insert the double pin end of the probe into the probe housing. Both the double pin end of the probe and the probe housing are keyed so they will fit together only one way.

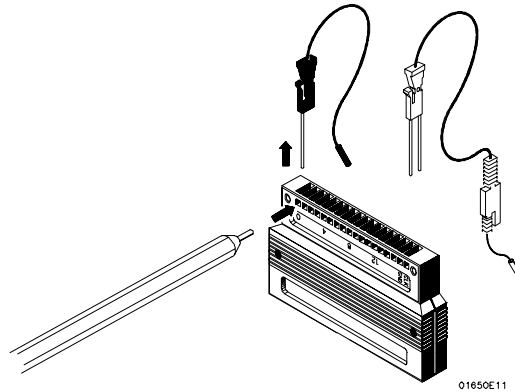

Installing Probe Leads



Connecting the Grabbers to the Probes

Connect the grabbers to the probe leads by slipping the connector at the end of the probe onto the recessed pin located in the side of the grabber. If you need to use grabbers for either the pod or the probe grounds, connect the grabbers to the ground leads in the same manner.

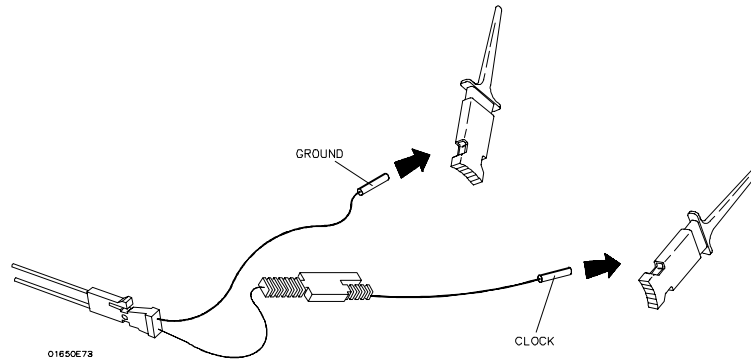

Connecting Grabbers to Probes

Connecting the Grabbers to the Test Points

The grabbers have a hook that fits around the IC pins and component leads. Connect the grabber to the test point by pushing the rear of the grabber to expose the hook. Hook the lead and release your thumb as shown.

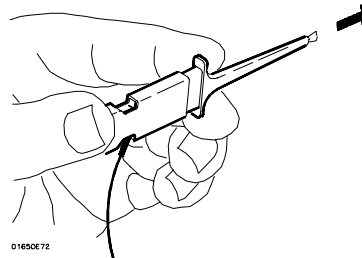

Connecting Grabbers to Test Points





Using the Front-Panel Interface

The Front-Panel Interface



This chapter explains how to use the front-panel user interface. The front and rear-panel controls and connectors are explained in the first part of this chapter followed by a series of "How to Use" examples.

The front-panel interface consists of front-panel keys, a knob, and a display. The interface allows you to configure the instrument by moving between menus and setting parameters within the menus. The interface then displays the measurement results. In general, using the front-panel interface involves the following processes:

- Selecting the desired menu with the MENU keys.
- Placing the cursor on the desired field by using the arrow keys and by rotating the knob.
- Selecting and displaying the field options or current data by pressing the Select key.
- If necessary, selecting lower level options or entering new data by using the knob, arrow keys, or the keypad.
- Starting and stopping data acquisition by using the Run and Stop keys.

If you want to step through the examples on using the interface, simply turn the power Off, then back On. Start with the section, "How to Select Menus."

Front-Panel Controls

In order to apply the user interface quickly, you should know what the following front-panel controls do.

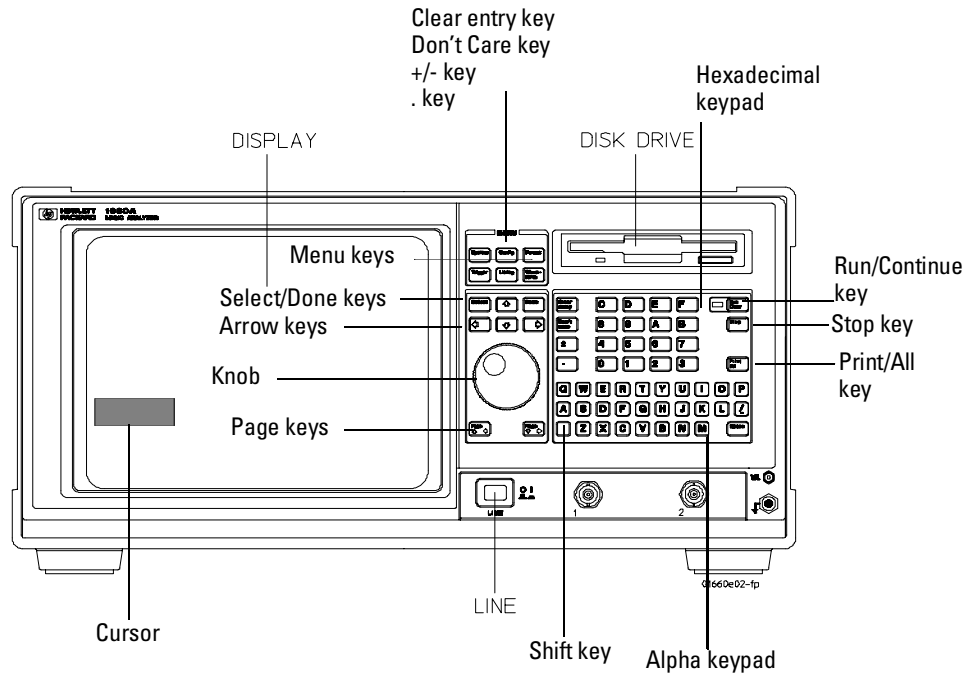

Front-Panel Layout

The Cursor

The cursor (inverse video field) highlights interactive fields within the menus that you want to use. Interactive fields are enclosed in boxes in each menu. When you press the arrow keys, the cursor moves from one field to another.

MENU Keys

The menu keys allow you to quickly select the main menus in the logic analyzer. These keys are System, Config, Format, Trigger, List, and Waveform. The System key accesses the system menu. The Config, Format, Trigger, List, and Waveform keys will display the menus of either analyzer (machine) 1 or 2 respectively depending on what menu was last displayed.

System Menu Key The System key allows you to access the System subset menus. The subset menus are the Disk, RS-232 / GPIB (Printer/Controller for 1664A), Utilities, and Test menus.

Config Menu Key The Config menu key allows you to access either the Timing or State Configuration menu. You exit the Config menu by pressing another menu key.

Format Menu Key The Format menu key allows you to access either the Timing or State Format menu. You exit the Format/Display menu by pressing another menu key.

Trigger Menu Key The Trigger menu key allows you to access either the Timing or State Trigger menu. You exit the Trigger menu by pressing another menu key.

List Menu Key The List menu key allows you to access either the Timing or State Listing menu. In addition, if the List key is pressed a second time, the Compare menu becomes available. The available menus depend on the type of analyzers turned on and what analyzer was accessed last. You exit the List menu by pressing another menu key.

Waveform Menu Key The Waveform menu key allows you to access either the Timing or State Waveform menu. In addition, if the Waveform key is pressed a second time, the Chart menu becomes available. The available menus depends on the type of analyzers turned on and what analyzer was accessed last. You exit the Waveform menu by pressing another menu key.

Select Key

The Select key initiates an interface action that is dictated by the field currently highlighted. The highlighted field could be an option field within a pop-up, a toggle field, an assignment field, or a Done field. For example, if the field is a Done field, you just press the Select key to finish that task.

When option fields are selected, they either save the highlighted selection into the configuration, or they access other pop-ups requiring another selection or assignment. When you select an option, the pop-up either closes automatically with the Select key or it closes when you select the Done field.

When toggle fields are selected, the field will automatically switch to the other choice.

When you select an assignment field, it opens. When the Select key is pressed in an opened assignment field, either a highlighted option is assigned, or keypad entries are assigned. Then the assignment field closes.

Done Key

The Done key stops any field selection and assignment actions by saving the current selections and closing the opened pop-up. In some fields, its action is the same as the Select key.

Arrow Keys

The arrow keys move the cursor around the menu in a horizontal and vertical direction, according to the direction of the arrow.

Knob

The knob has four major functions, depending on what field or pop-up menu you are in. The knob allows you to do the following:

- Increment/decrement numeric values in numeric pop-up menus.
- Roll the offscreen display containing such things as data listings, waveforms, the resource term list, sequence level list, or labels. Depending on what display is rolled, the direction can be left, right, up, or down.
- Move the cursor from option to option within a selection list.
- Move the cursor from field to field within an assignment field.

Page Keys

The Page keys roll offscreen display data such as pods, labels, resource terms, data listings, and waveforms one screen at a time. To roll data in an up and down direction, press the up or down Page keys. To roll data in a left to right direction, press the blue shift key prior to the left or right Page key. When the blue shift key is pressed followed by a left or right arrow key, only one page roll occurs. For multiple left or right paging, you must repeat the two-key process.

If there are multiple items in a menu that need paging, the field containing the item name turns dark indicating it is rollable. The Page keys work independent of the knob. If there are up and down rollable data, simply press the up or down front-panel Page keys. If there are left and right rollable data, press the blue shift key, then the left or right Page key (Shift+Page). This two-key sequence is repeated for each paged screen.

Run/Rep Key

The Run key starts a data acquisition in any run mode you specify. After the acquisition, the analyzer (state or timing) is automatically forced into the last display menu accessed.

To start a single run, press the Run/Rep key. To start a Repetitive run, press the blue shift key, then press the Run/Rep key.

Stop key

The Stop key allows you to stop data acquisition or printing. After the acquisition is stopped, the data displayed onscreen depends on which run mode (single or repetitive) was used to acquire the data. In the repetitive mode, Stop halts acquisition after the last completed single acquisition cycle. In single mode, Stop causes the single data acquisition to be aborted and partial data is displayed. If you print a hard copy, the Stop key stops the print.

Print/All Key

The Print/All key starts a hard copy print of the screen and any data that appears on that screen. To print all data that is offscreen, press the blue shift key prior to pressing the Print/All key.

Don't Care Key

The Don't Care key allows you to enter don't cares (Xs) in binary, octal, and hexadecimal pattern assignment fields. In Alpha Entry fields, this key enters a space and moves the underscore marker to the next space.

Clear Entry Key

The Clear entry key allows you to clear assignment fields of alpha entries, channel assignments, and numeric entries. When you press the Clear entry key in an alpha assignment field, a cursor appears that indicates the start point for new alpha entry.

± Key

The ± key allows you to change the sign (±) of numeric variables.

. (period) Key

The period key allows you to enter a period in a numeric entry, turn off a channel assignment, or enter a period in an alpha assignment.

Hexadecimal Keypad

The hexadecimal keypad allows you to enter numeric values in numeric entry fields. You enter values in the four number bases Binary, Octal, Decimal, and Hexadecimal. The A through F keys are used for both hexadecimal and alpha character entries.

Alpha Keypad

The alpha keypad allows you to enter letters in alpha entry fields. You enter letters in fields where a custom name is desired.

Disk Drive

The disk drive is a 3.5 inch, double-sided, double density drive. Besides loading the operating system, it allows you to store and load logic analyzer configurations and inverse assembler files. There is a disk eject button located on the right side. Press this button to eject a flexible disk from the disk drive. The disk drive also has an indicator light. This light is illuminated when the disk drive is operating. Wait until this light is out before removing or inserting disks.

On 1664A analyzers, the operating system is not contained on ROM inside of the unit, and **MUST** be loaded from disk when the 1664A is powered up. Simply insert the operating system disk into the disk drive, then set the LINE switch to ON.

Rear-Panel Controls and Connectors

In order to apply the user interface quickly, you should know what the following rear-panel controls do:

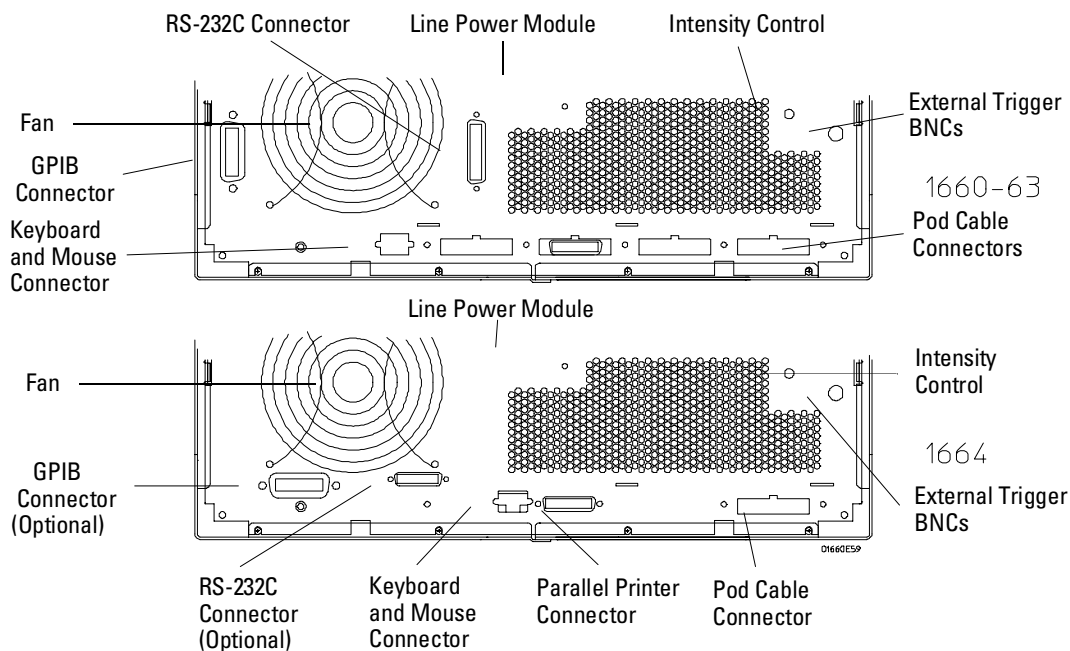

Rear Panel Layout

Line Power Module

Permits selection of 110-120 or 220-240 Vac and contains the fuses for each of these voltage ranges.

External Trigger BNCs

The External Trigger BNCs provide arm out and arm in connections. When the Arming Control is configured in the Trigger menu, the Arm In signal enters through the External Trigger In BNC and the Arm Out signal generated by the analyzer leaves through the External Trigger Out BNC.

Intensity Control

Allows you to set the display brightness to a comfortable level.

Pod Cable Connectors

These are keyed connectors for connecting the pod cables. Depending on the analyzer model, you will see a different number of pod cables.

RS-232C Connector

Standard DB-25 type connector for connecting an RS-232C printer or controller. This interface is standard on the 1660A through 1663A, and optional on the 1664A.

GPIB Connector

Standard GPIB connector for connecting an GPIB printer or controller. This interface is standard on the 1660A through 1663A, and optional on the 1664A.

Parallel Printer Port Connector

Standard DB-25 type connector for connecting a Centronix printer to the 1664A. This interface is not available on the 1660A through 1663A.

Keyboard and Mouse Connector

Standard keyboard/mouse connector for connecting an optional keyboard and/or mouse.

Fan

Provides cooling for the logic analyzer. Make sure air is not restricted from the fan and rear-panel openings.



How to Power-up The Analyzer

The method for powering up the analyzer is dependent on the model.
For the 1660A through 1663A, simply set the front panel LINE switch to ON.

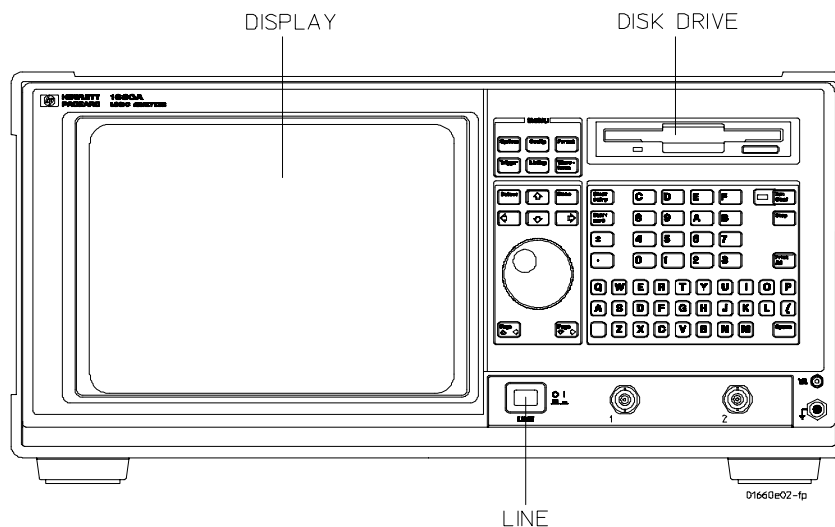

Power On Procedure

For the 1664A, proceed as follows:

- 1 Insert the Operating System disk into the disk drive.
- 2 Set the front panel LINE switch to ON.
- 3 Verify "Loading System File" is displayed. If "System Disk Not Found" is displayed, repeat procedure using the correct Operating System disk.

NOTE

It is recommended that a working copy of the master Operating System disk be made (using the "Duplicate Disk" function in the System Menu) and used for normal operation. Place the master Operating System disk in a safe location, for use when the working copy is damaged or lost.

How to Select Menus

There are two ways of selecting menus.

- 1 Press any one of the five front-panel MENU keys.

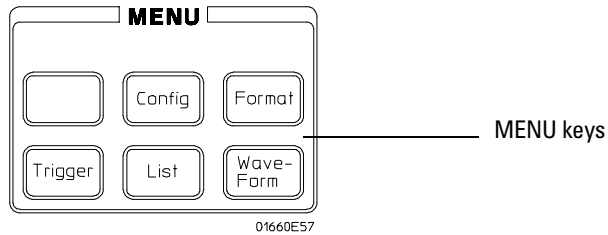

- 2 Or, press the front-panel **arrow** keys and move the cursor to the menu Name field as shown below, then press the **Select** key.

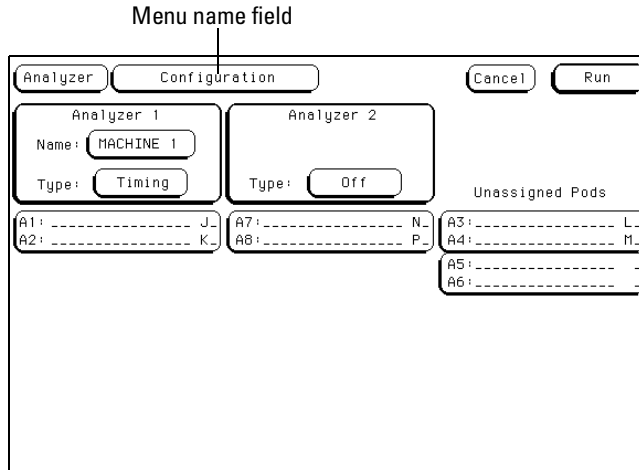

Menu Name Field

If more than one analyzer is on, you see the selected menu of analyzer 1 or analyzer 2 depending on what type menu was last displayed. To switch from the machine 1 menu set to machine 2 menu set, highlight the Menu name field, then press the Select key. Now, select analyzer 2 and the menu you want from the pop-up menu.

Using the Front-Panel Interface
How to Select Menus

3. Press the **Up/Down arrow** keys or turn the knob to highlight the desired menu name as shown below, then press the **Select** key.

In many applications, both analyzers are turned on. In these cases, if a front-panel MENU key is pressed twice, all corresponding menus for that MENU key become available.



Menu selection list
(not shown on the
1664A)

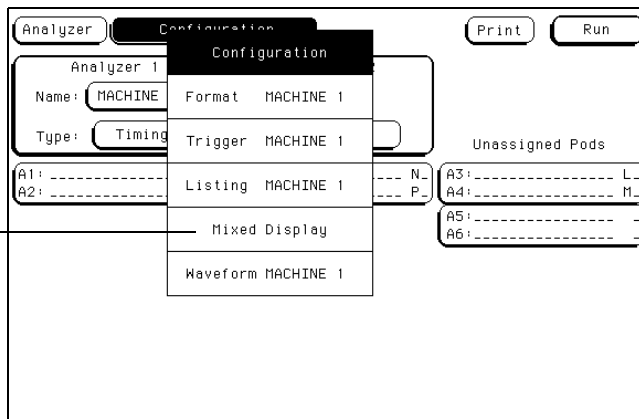

Complete Menu Selection List

How to Select the System Menus

One of the six MENU keys is the System key. You use the System key to access a set of menus that are used to configure system level parameters for the I/O bus, clock, display, and the disk drive operations. To access the menus under the System key, perform the following steps:

- 1 Press the **System** MENU key.

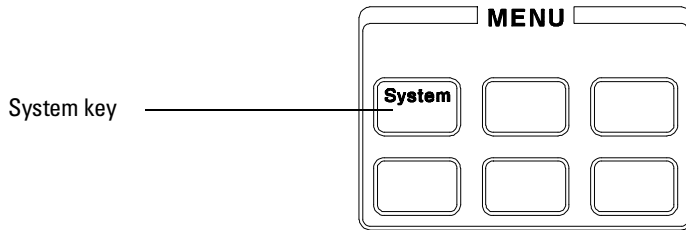

- 2 Press the **arrow** keys to highlight the menu Name field, then press the **Select** key.
- 3 Press the **Up/Down arrow** keys or turn the knob to highlight the desired System menu name as shown below, then press the **Select** key.

1660A through 1663A shown. 1664A displays "Printer/Controller"

Menu name field

System menu Selection List

Filename	File	Test	Description
ROM1	166X_system_0	117248	HP166X ROM Software V05.01
SYSTEM1	166X_system_1	214784	HP166X System Software V11.11
SYST_032	166X_020_syst	430848	100MHz State/500MHz Time V05.1C

Disk Space(blocks) - Total: 6077 Free: 3097 Largest: 3097

System Menus Selection List

Using the Front-Panel Interface How to Select the System Menus

To return to one of the analyzer menus, do the following:

4 Press any of the five MENU keys.

Another way to look at the System menu set and the analyzer menu set is shown.

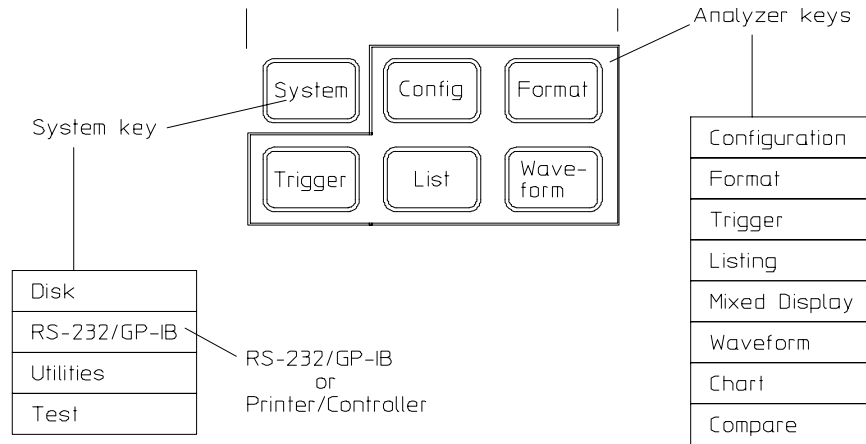

System and Analyzer Menu Sets

How to Select Fields

The process of selecting individual fields within the main menu is simply to highlight the desired field and then press the Select key. However, depending on what type of field you select, you will either see a pop-up menu appear, or will see an immediate assignment in a toggle type field.

Pop-up Menus

The pop-up menu is the most common type of menu you see when you select a field. When a pop-up appears, you see a list of two or more options. The pop-up closes after at least one of the options are selected. The following example guides you through field selection within a pop-up menu.

- 1 Press the front panel analyzer **Trigger MENU** key.
- 2 Press the **arrow** keys to highlight the sequence level 1 field as shown, then press the **Select** key.

Timing sequence level
number 1 field

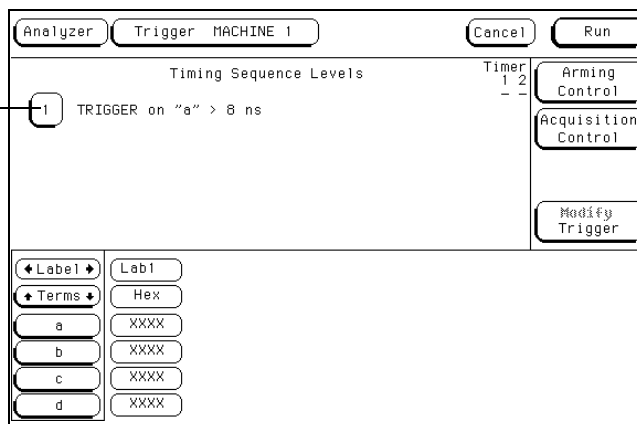

Sequence Level 1

- 3 Press the **arrow** keys to highlight the "Trigger on" field as shown, then press the **Select** key.

A second pop-up appears with all the variable choices for the "Trigger on" field.

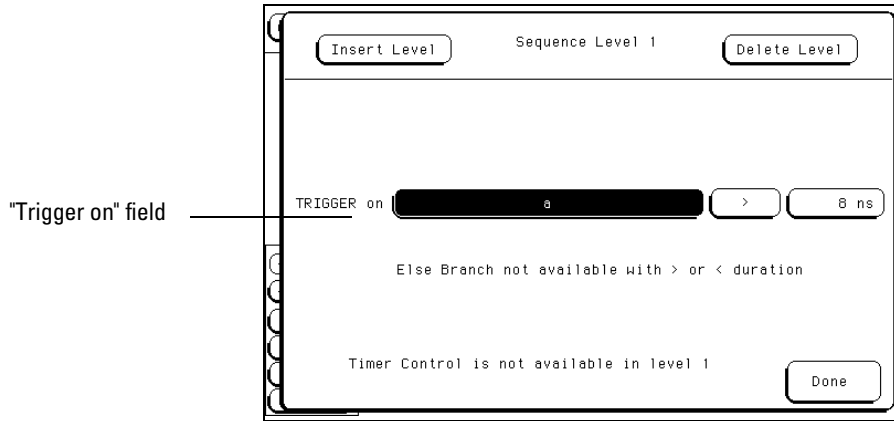

"Trigger on" Field

- 4 Press the **arrow** keys or turn the knob to highlight any variable field, then press either the front panel **Done** or **Select** keys.

Pop-up menus of this type do not contain a Done field. They close automatically when you press either the Select key or the Done key, but do not close the original pop-up.

- 5 To Close the original pop-up press the **Done** key.

You can also close the original pop-up by moving the cursor to the Done field within the pop-up and pressing the Select key.

Toggle Fields

Some fields will simply toggle between two options (like, On/Off). The following example illustrates a toggle field in the Format menu.

- 1 Press the **Format MENU** key.
- 2 Press the **arrow** keys to highlight the Polarity field as shown below, then press the **Select** key.

The Polarity field toggles between positive (+) and negative (-) each time you press the Select key. You can also toggle this particular field with the front-panel \pm key.

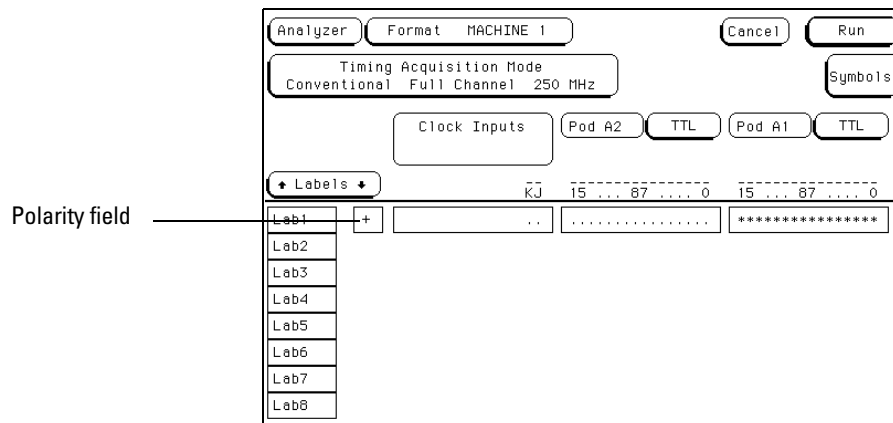

Polarity Toggle Field

How to Configure Options

With one exception, the process of selecting an option within a pop-up menu is the same as selecting any typical field in a main menu. When an option is selected, it may be necessary to access several pop-up menus before all the parameters of an option are configured. An example of selecting options is illustrated in the analyzer Trigger menu.

- 1 Press the analyzer **Trigger MENU** key.
- 2 Press the **arrow** keys to highlight the Acquisition Control field as shown, then press the **Select** key.

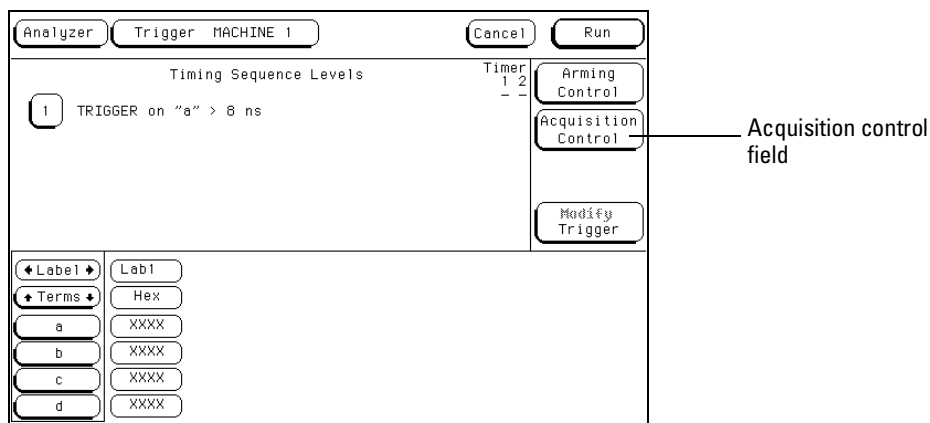

Acquisition Control Field

- 3 With the Acquisition Mode Automatic field highlighted, press the **Select** key.
By selecting the Acquisition Mode Automatic field, you toggle the field to manual operation where you can configure features like the trigger position and sample rate.
- 4 Press the **arrow** keys to highlight the Trigger Position Field, then press the **Select** key.
- 5 Press the **Up/Down arrow** keys or turn the knob to highlight a trigger position setting. Then, press the **Select** key.
- 6 To close the Acquisition Control pop-up, press the **Done** key.

How to Enter Numeric Data

There are a number of pop-up menus in which you enter numeric data. The two major types are as follows:

- Numeric entry with fixed units.
- Numeric entry with variable units (for example, ms and μ s).

An example of a numeric entry menu in which you enter both the value and the units is the pod threshold pop-up menu.

- 1 Press the analyzer **Format MENU** key.
- 2 Press the **arrow** keys to highlight the pod threshold field as shown below, then press the **Select** key.

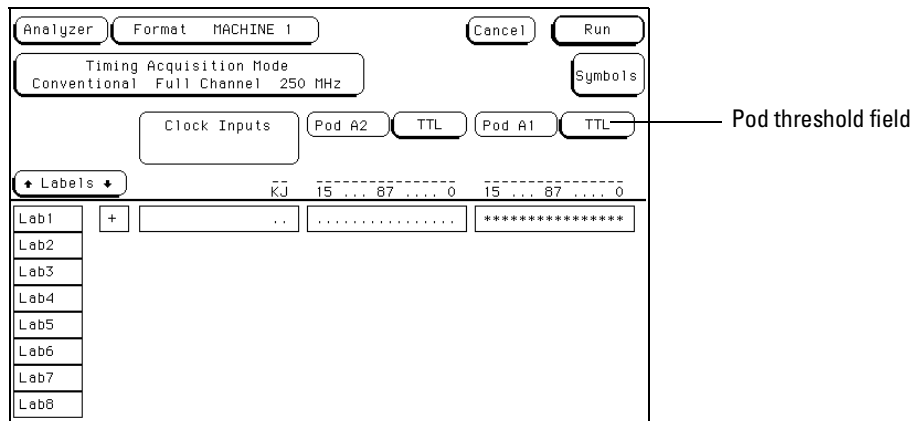

Pod Threshold Field

Using the Front-Panel Interface
How to Enter Numeric Data

- 3 Press the **Up/Down arrow** keys or turn the knob to highlight the User field, then press the **Select** key.
- 4 Press the **arrow** keys or turn the knob to set the units assignment field to V or mV as shown below.

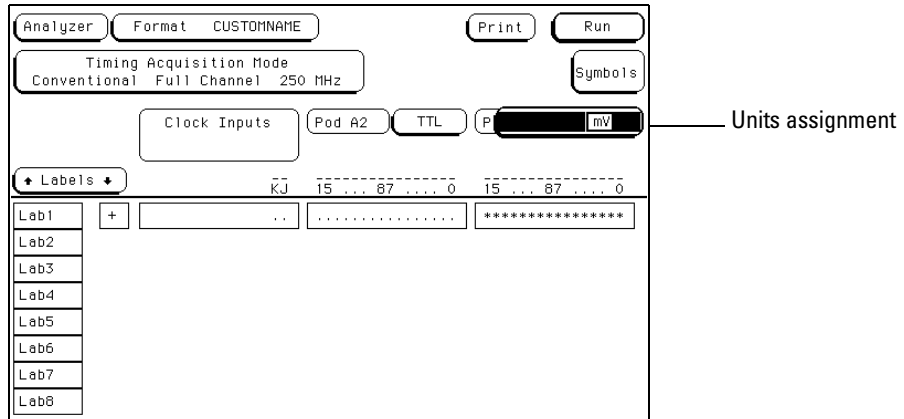

Units Assignment field

- 5 Enter a value using the Hex keypad. If you want a negative threshold voltage, press the \pm key on the front panel.
- 6 To close the numeric assignment field, press the **Select** or **Done** keys.

How to Enter Alpha Data

You can customize your analyzer configuration by giving names to several items:

- The name of each analyzer.
- Labels.
- Symbols.
- Filenames.
- File descriptions.

- 1 Press the analyzer **Config** MENU key.
- 2 Press the **arrow** keys to move the cursor to the Analyzer 1 "Name" field as shown.

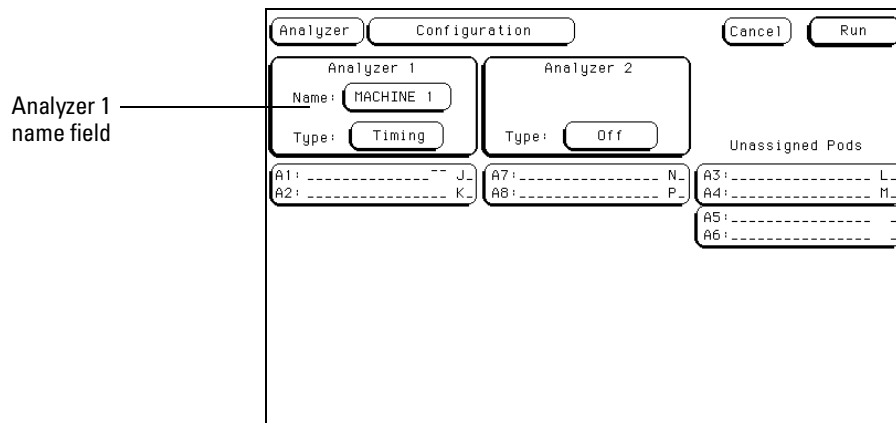

Analyzer Name Field

3 Using the alpha keypad, enter a custom name as shown below.

A custom name can contain up to 10 letters. As you type the new name, the old name is overwritten.



Name field

Alpha Entry

4 When you are finished entering a custom name, press the **Done** or **Select** keys.

Changing Alpha Entries If you want to make changes or corrections in the alpha entry field, use the arrow keys or the knob to position the underscore marker under the character you want to change and type the new letters. To quickly clear the Name field, you can press the Clear entry key.

How to Roll Offscreen Data

If there is offscreen data, it must be rolled back onscreen before it can be viewed or acted upon. The types of data you typically find located offscreen are Labels, Pods, Terms, Sequence Levels, and data listings. Each of the data types have a roll field. These roll fields indicate offscreen data by becoming a dark selectable field with small arrows showing the direction the data is rolled. In addition, a roll indicator appears that indicates which rollable field is currently active.

There are two ways to roll data. One is with the knob, the other is with the Page keys. The following exercise demonstrates both ways by first having you assign enough data to create offscreen data, then rolling the data.

Using the Knob

- 1 Press the analyzer **Config MENU** key.
- 2 Press the **arrow** keys to move the cursor to the A3/A4 pod pair field in the Unassigned Pods list, then press the **Select** key.
- 3 Press the **Up/Down arrow** keys or rotate the knob to move the cursor to the custom name for Analyzer 1 as shown below, then press the **Select** key.

You should now have pod pairs A1/A2 and A3/A4 assigned to Analyzer 1.

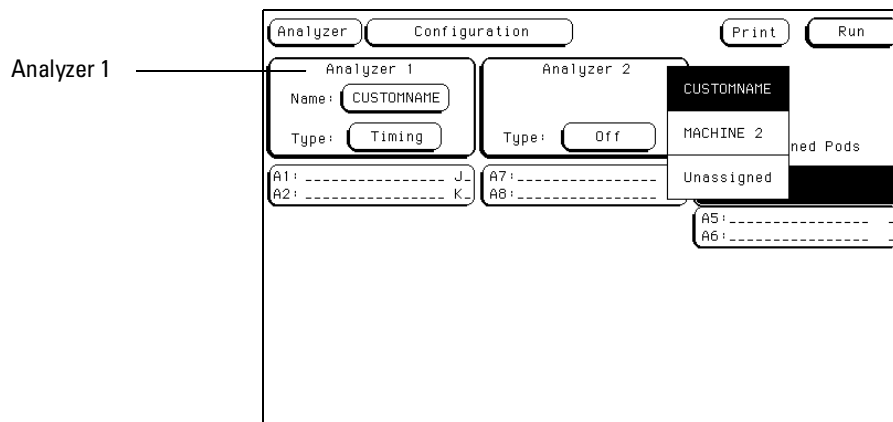

Configuration menu

- 4 Press the analyzer **Format MENU** key.
- 5 Notice the roll indicator in the Pods roll field as shown. Rotate the knob and notice how pods A1 through A4 are rolled left and right.

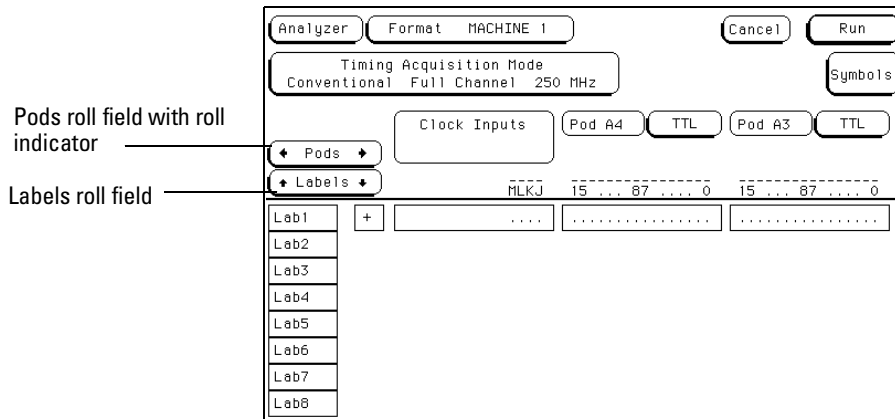

Pods and Labels Roll Field

- 6 Press the **Down arrow** key to move the cursor to the **Labels** roll field directly below the Pods roll field, then press the **Select** key or just turn the knob.
- 7 Notice the roll indicator now switches to the Labels roll field. Rotate the knob and notice how the column of labels roll up and down.

Using the Page Keys

- 8 Press the **Up/Down Page** keys and notice how the column of labels page up and down.
- 9 Press the **Up arrow** key to move the cursor back to the Pods roll field, then press the **Select** key.
- 10 Press the **blue shift** key, then press a **Page** key.

The left and right page keys must be preceded by the blue shift key each time. Repeat this two key sequence to page the Pods left and right.

How to Use Assignment/Specification Menus

There are a number of assignment fields which you must assign or specify what you want the instrument to do. Menus of this type are as follows:

- Assigning pod channels and clock channels to labels.
- Specifying patterns.
- Specifying edges.

Assigning Pod and Clock Channels

The channel assignment fields in both state and timing analyzers appear in the Format menus and work identically. It should be noted that if you don't see any channel assignment fields, it merely means you do not have any pods assigned to this analyzer or any labels turned on. The convention for channel assignments is as follows:

- * (asterisk) indicates assigned channels
- . (period) indicates un-assigned channels

To assign channels to an analyzer, do the following exercise:

- 1 Press the analyzer **Format MENU** key.
- 2 Press the **arrow** keys to move the cursor to the channel assignment field as shown below, then press the **Select** key.

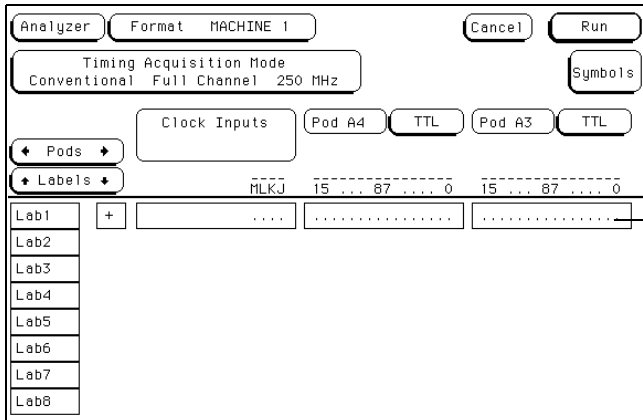

Channel assignment

Channel Assignment Field

Using the Front-Panel Interface How to Use Assignment/Specification Menus

When the channel assignment field is selected, an assignment pop-up appears showing you the bit or channel to be assigned, and the two choices directly above it.

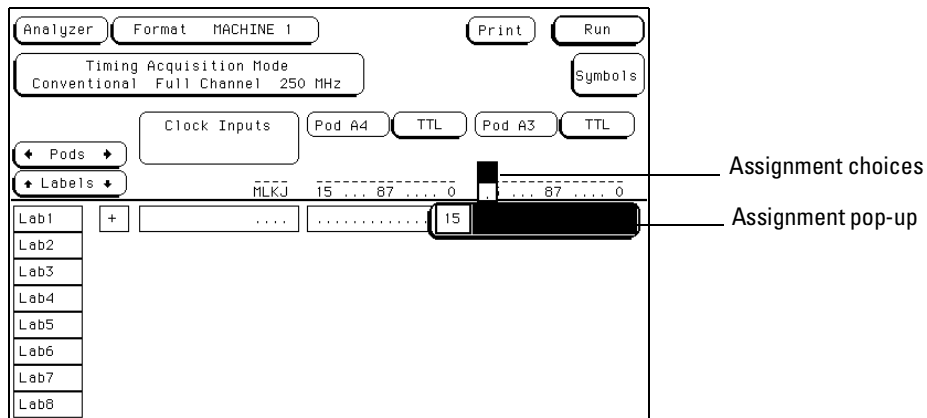

Channel Assignment Pop-up

- 3 Turn all channels on (assign an asterisk) by either pressing the **Select** key or by pressing the **Up arrow** key.

Individual bits or channels are highlighted by moving the cursor side to side with the left/right arrow keys or by rotating the knob. The Select key toggles the current choice. The up arrow assigns a channel, and the down arrow unassigns a channel. In addition, the entire bank of channels are assigned or cleared by pressing the Clear entry key.

- 4 When you are finished assigning channels, press the **Done** key.

Specifying Patterns

Certain assignment fields require bit patterns to be specified. Patterns can be specified in any one of the available number bases, except ASCII. A pattern can contain a value or a "Don't care."

The convention for "Don't cares" in these menus is an "X" except in the decimal base. If the base is set to decimal after a "don't care" is specified, a \$ character is displayed.

To specify a pattern, perform the following exercise:

- 1 Press the analyzer **Trigger MENU** key.
- 2 Press the **arrow** keys to move the cursor to the assignment field for the "a" resource term as shown.

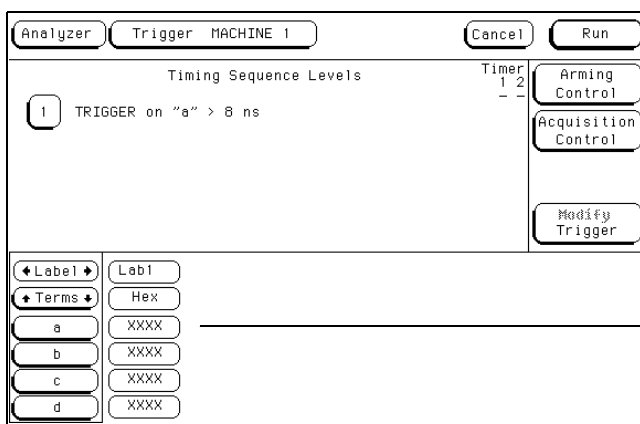

Resource Term Assignment Field

- 3 Using the Hexadecimal keypad, enter a pattern, then press the **Select** key.

In addition to using the numeric keypad, you can enter "Don't cares" into the entire assignment field by pressing the Clear entry key.

Specifying Edges

Certain assignment fields require edge assignments to be specified. An edge can be specified in any one of the available number bases.

You can select positive-going (\uparrow), negative-going (\downarrow), either edge (\updownarrow) or no edge (\cdot).

To specify an edge, perform the following exercise:

- 1 Press the analyzer **Trigger** MENU key.
- 2 Press the **arrow** keys to move the cursor to the Edge 1 assignment field as shown, then press the **Select** key.

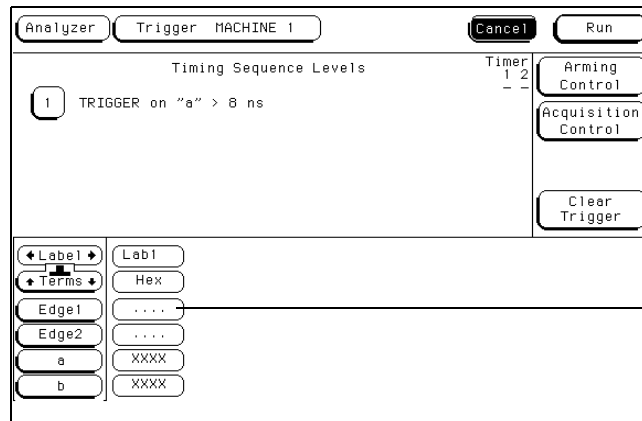

Edge assignment field

Edge and Glitch Assignment Field

When the Edge and Glitch assignment field is selected, an assignment pop-up appears showing you the bit or channel to be assigned, and the five choices directly above it.

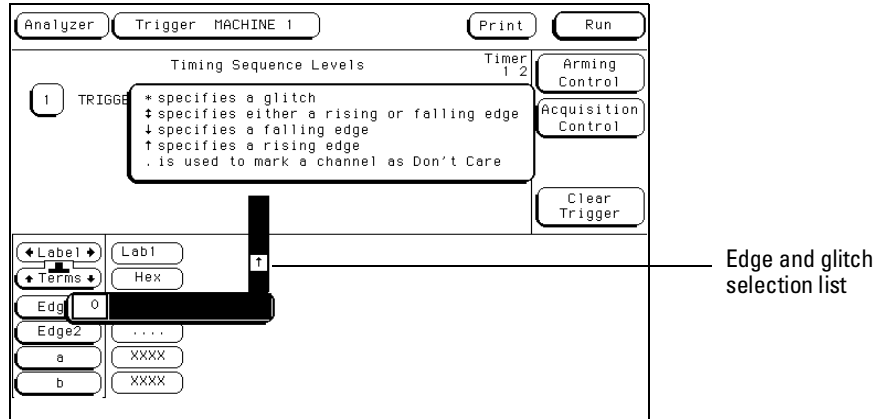

Edge and Glitch Selection List

- 3 Press the **Up/Down arrow** keys to move the cursor to the desired edge assignment, then press the **left/right arrow** key or turn the knob to move the cursor to the next channel. Repeat step 3 until all of the desired channels are assigned.
- 4 To close the assignment field, press the **Done** key.

Individual bits or channels are cleared by pressing the front-panel (.) period key. The entire bank of channels are cleared by pressing the Clear entry key.

It should be noted that when you close the pop-up after specifying edges, you see dollar signs (\$ \$...) in the assignment field. This simply indicates the logic analyzer can't display the assignment correctly in the current number base selected.





Using the Mouse and the Optional Keyboard

The Mouse and the Optional Keyboard



This chapter explains how to use the mouse and the optional keyboard interface (Agilent Technologies E2427A Keyboard Kit). The keyboard and mouse can be used interchangeably with the knob and front-panel keypad for all menu applications. The keyboard and mouse functions fall into the two basic categories of cursor movement and data entry.

Both the keyboard or mouse can be connected to the keyboard/mouse connector on the rear panel of the logic analyzer. If both are connected at the same time, the keyboard is connected to the analyzer and the mouse is connected to the keyboard.

When the keyboard and/or mouse is connected, a graphic is included in the RS-232 / GPIB (or Printer/Controller) menu to represent the interface options being used.

See Also

The documentation that comes with each interface device for complete details on connecting them to each other or, to the logic analyzer.

Moving the Cursor

The keyboard cursor is the location on the screen highlighted in inverse video. To move the cursor, follow one of the methods described below.

Keyboard Cursor Movement

There are four cursor keys marked with arrows on the keyboard. These keys perform the following movements:

- Up-pointing arrow moves the cursor up.
- Down-pointing arrow moves the cursor down.
- Right-pointing arrow moves the cursor to the right.
- Left-pointing arrow moves the cursor to the left.

The cursor keys do not wrap. This means that pressing the right-pointing arrow when the cursor is already at the rightmost point in a menu will have no effect. The cursor keys do repeat, so holding the key down is the fastest way to continue keyboard cursor movement in a given direction.

Home Key (or corner arrow) If you want to move the cursor to the first item in a menu, press the Home key. If you want to move the cursor to the last item in a menu, press the Home and Shift keys simultaneously.

Next and Previous Keys The Next and Previous keys are used for paging through listings. The Next key will display the next page of data, if one exists. The Previous key will display the previous page of data, if one exists.

Selecting a Menu Item

To select a menu item using the optional keyboard, position the cursor (the location highlighted in inverse video) on the desired menu item using one of the methods described in the section “Moving the Cursor” and press either the Return or the Select key.

Mouse Cursor Movement

The mouse pointer (+) is positioned around the screen by moving the mouse about on top of a desktop or other even surface.

Selecting a Menu Item To select a menu field, simply move the pointer on top of the desired field and press the upper-left button.

To duplicate the front-panel knob, hold down the upper-right button while moving the mouse around the desktop. Moving the mouse up or to the right duplicates turning the knob clockwise. Moving the mouse down or to the left duplicates turning the knob counterclockwise.

Entering Data into a Menu

Keyboard Data Entry

When an assignment field is selected, the cursor is displayed under the leftmost digit in the particular field. When you type in a number or letter, it is displayed in the cursor position, and the cursor is advanced. Cursor keys move the cursor within the assignment field. Pressing either the Return key or the Enter key will terminate data entry for that item.

If you want to erase the data entry, press the Clear Line key, the Clear Display key, or the Delete Line key.

Mouse Data Entry

When an assignment field is selected, a pop-up keypad or assignment menu appears. Use the pop-up menus to assign letters, numbers, symbols, or unit of measure. When the Done field is selected, the pop-up closes and the selected values are entered into the assignment field.

Using the Keyboard Overlays

Two keyboard overlays are included in the E2427A Keyboard Kit. The overlays shown below redefine functions of the function keys and the numeric keypad.

Function Key Overlay

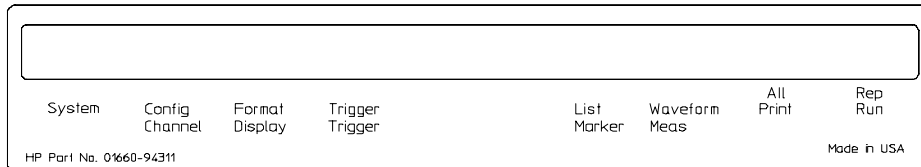

01660e48

Key	Function Performed
F1	Selects System subset menus
F2	Selects the Analyzer Configuration Menu (ignore Scope Channel Menu)
F3	Selects the Analyzer Format Menu (ignore Scope Display Menu)
F4	Selects the Analyzer Trigger Menu (ignore Scope Trigger Menu)
F5	Selects the Analyzer Listing Menu (ignore Scope Marker Menu)
F6	Selects the Analyzer Waveform Menu (ignore Scope Auto-Measure Menu)
F7	Selects the Print All function
F8	Selects the Run Repetitive function

Numeric Keypad Overlay

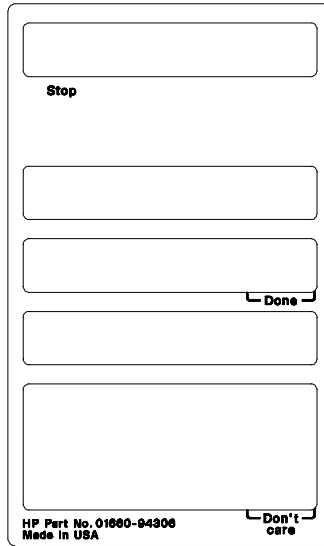

01660E11

Key	Function Performed
Tab	Don't care "X"
Enter	Done
Stop (unlabeled)	Stop

Defining Units of Measure

In addition to the function keys, other keys on the keyboard invoke the unit of measure selections.

Time Units

Key	Time Units
S	Selects the seconds units
M	Selects the milliseconds units
U	Selects the microseconds units
N	Selects the nanoseconds units

Voltage Units

Key	Voltage Units
V	Selects volts
M	Selects millivolts

Assigning Edge Triggers

Several keys invoke edge assignments.

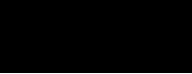

Key	Edge Trigger Assignment
U	Selects the up or rising edge.
D	Selects the down or falling edge.
R	Selects the rising edge.
F	Selects the falling edge.
B	Selects either the rising or falling edge.
* (asterisk)	Assigns a glitch.
. (period)	Assigns a Don't Care

Closing a Menu

To exit a menu, press either the Done or Enter key. The Enter key is mapped to the Done key, so pressing either key closes the menu.



Connecting a Printer

Connecting a Printer

The logic analyzer can output its screen display to various GPIB, RS-232C, and Centronix graphics printers (1664A only). Configured menus as well as waveforms, listings and other data, can be printed for complete measurement documentation.

GPIB Printers

The logic analyzer interfaces directly with HP PCL printers supporting the printer command language or with Epson printers supporting the Epson standard command set. These printers must also support GPIB and Listen Always. Printers currently available from Hewlett-Packard with these features include:

- HP ThinkJet
- HP LaserJet
- HP PaintJet
- HP DeskJet
- HP QuietJet

It should be noted that an GPIB printer must always be in Listen mode, and the analyzer's GPIB port does not respond to service requests (SRQ) when controlling a printer. The SRQ enable setting for the GPIB printer has no effect on 16600B printer operation.

GPIB Printer Setup

To set up the GPIB printer, perform the following steps:

- 1 Turn off the instrument and connect an GPIB cable from the printer to the GPIB connector on the rear panel of the instrument. Turn on the instrument.

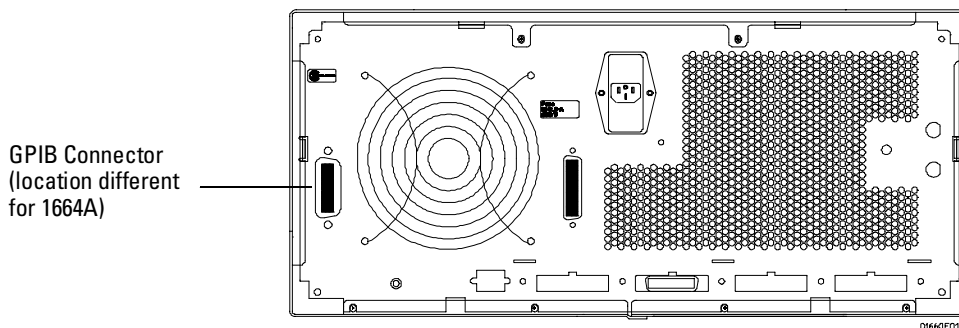

GPIB Connector

Connecting a Printer GPIB Printers

- 2 Make sure the printer is in **Listen Always** (or **Listen Only**). For example, the figure below shows the GPIB configuration switches for an GPIB ThinkJet printer. For the **Listen Always** mode, move the second switch from the left to the “1” position.

Since the instrument doesn't respond to SRQ EN (Service Request Enable), the position of the first switch doesn't matter.

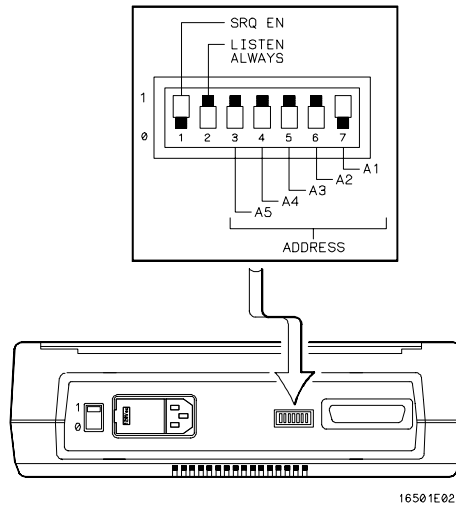

Listen Always Switch Setting

GPIB Configuration (1660A through 1663A)

From the RS-232 / GPIB menu, perform the following steps to configure the GPIB interface for printing:

- 1 Select the **GPIB** field.
- 2 When the pop-up appears, select "GPIB Connected to" field, and toggle to the **Printer** selection.
- 3 Select the field to the right of "Printer" and when the pop-up appears, select the printer that you're using (like, ThinkJet or QuietJet). If you're using an Epson graphics printer or an Epson-compatible printer, select **Alternate**.

See Also

"RS-232 / GPIB Interface" chapter for more information on selecting the GPIB Address to match the setup for the GPIB printer.

- 4 Select the "Print Width" field. The print width toggles between **80** and **132**. Select the width for your application or leave it at the default of 80.

Print width tells the printer that you are sending up to 80 or 132 characters per line (when you **Print All**) and is totally independent of the printer itself.

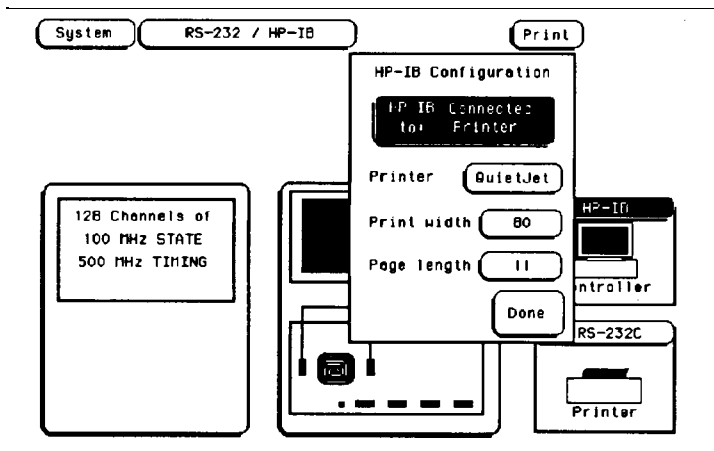

GPIB Configuration Menu (1660A through 1663A)

If you select 132 characters per line when using other than the QuietJet selection, the listings are printed in a compressed mode. Compressed mode uses smaller characters to allow the printer to print more characters within a given area.

If you select 132 characters per line for the QuietJet selection it can print a full 132 characters per line without going to compressed mode, but the printer must have wider paper.

If you select 80 characters per line for any printer, a maximum of 80 characters are printed per line.

- 5 Select the "Print Length" field. The print length toggles between **11** and **12**. Select the length for your application or leave it at the default of **11**.

Print length tells the printer the page length for the type of paper you are using.

- 6 Press the front-panel **Done** key.

Optional GPIB Configuration (1664A)

From the Printer/Controller menu, perform the following steps to configure the GPIB interface for printing:

- 1 Select the **Printer Setup** field.
- 2 When the pop-up appears, select "Printer Connected to **GPIB**" field, and toggle to the **Printer** selection.
- 3 Select the field to the right of "Printer" and when the pop-up appears, select the printer that you're using (like, ThinkJet or QuietJet). If you're using an Epson graphics printer or an Epson-compatible printer, select **Alternate**.

See Also

"RS-232 / GPIB Interface" chapter for more information on selecting the GPIB Address to match the setup for the GPIB printer.

- 4 Select the "Print Width" field. The print width toggles between **80** and **132**. Select the width for your application or leave it at the default of 80.

Print width tells the printer that you are sending up to 80 or 132 characters per line (when you **Print All**) and is totally independent of the printer itself.

If you select 132 characters per line when using other than the QuietJet selection, the listings are printed in a compressed mode. Compressed mode uses smaller characters to allow the printer to print more characters within a given area.

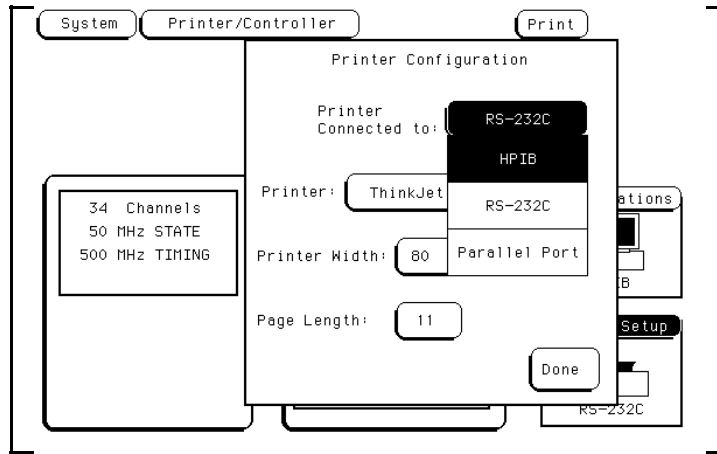

GPIB Configuration Menu (1664A)

If you select 132 characters per line for the QuietJet selection it can print a full 132 characters per line without going to compressed mode, but the printer must have wider paper.

If you select 80 characters per line for any printer, a maximum of 80 characters are printed per line.

RS-232C Printers

The instrument interfaces directly with RS-232C printers including the HP ThinkJet, HP QuietJet, HP LaserJet, HP PaintJet, and HP DeskJet printers.

RS-232C Printer Setup

To set up the RS-232C printer, perform the following steps:

- 1 Turn off the instrument and connect an RS-232C cable from the printer to the RS-232C connector on the rear panel of the instrument. Turn on the instrument.

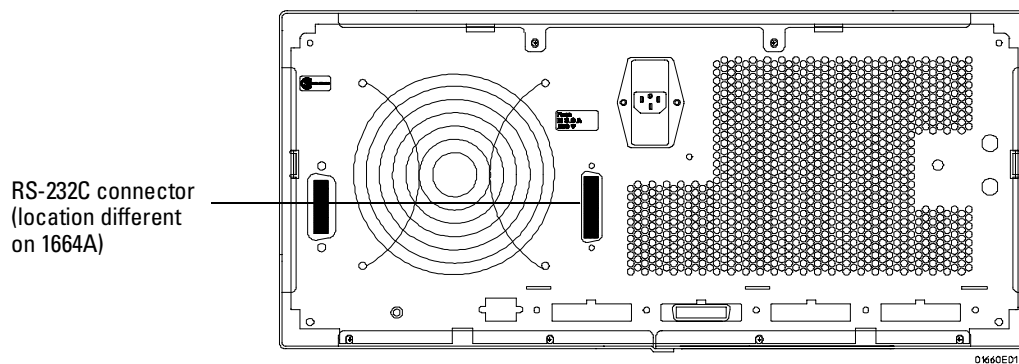

RS-232C Connector

2 Before turning on the printer, locate the mode configuration switches on the printer and configure them as follows:

- The HP QuietJet series printers have two banks of mode function switches inside the front cover. Push all the switches down to the “0” position as shown.

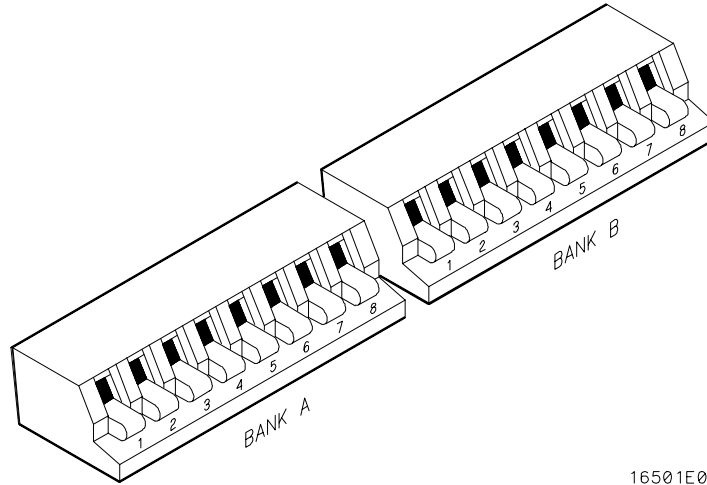

16501E03

- For the HP 2225D (RS-232 HP ThinkJet) printer, the mode switches are on the rear panel of the printer. Push all the switches down to the “0” position as shown .

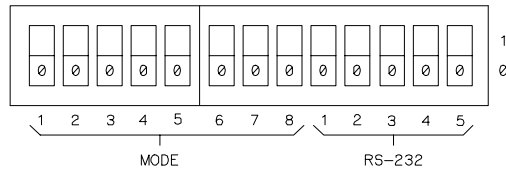

16500E17

- For the HP LaserJet printer, the switch settings can remain in the factory default settings.

RS-232C Configuration (1660A through 1663A)

From the RS-232 / GPIB menu, perform the following steps to configure the RS-232 interface for printing:

- 1 Select the **RS-232** field.
- 2 When the pop-up appears, select "RS-232 Connected to" field, and toggle to the **Printer** selection as shown below.
- 3 Set the baud rate, stop bits, parity, and protocol to match the setup for the RS-232C printer by selecting the appropriate fields.
- 4 Select the field to the right of "Printer" and when the pop-up appears, select the printer that you're using (like, ThinkJet or QuietJet). If you're using an Epson graphics printer or an Epson-compatible printer, select **Alternate**.

See Also

"RS-232 / GPIB Interface" chapter for more information.

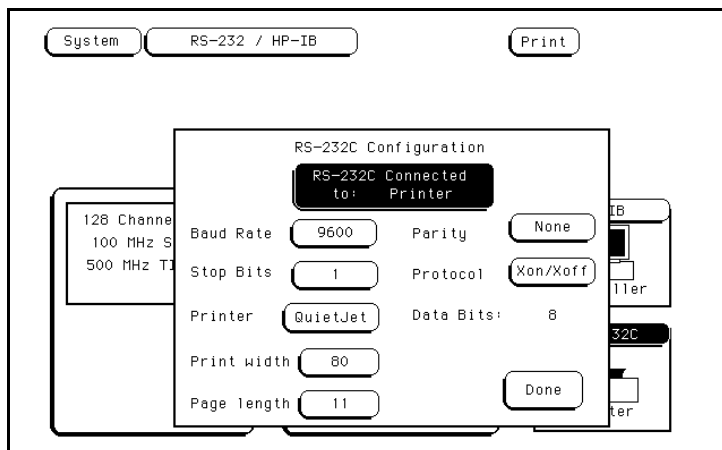

RS-232 Configuration Menu (1660A through 1663A)

- 5 Select the "Print Width" field. The print width toggles between **80** and **132**. Select the width for your application or leave it at the default of 80.

Print width tells the printer that you are sending up to 80 or 132 characters per line (when you **Print All**) and is totally independent of the printer itself.

- 6 Touch the "Print Length" field and print length toggles between **11** and **12**. Select the length for your application or leave it at the default of 11.

Print length tells the printer the page length for the type of paper you are using.

- 7 Press the front-panel **Done** key.

Optional RS-232C Configuration (1664A)

From the Printer/Controller menu, perform the following steps to configure the RS-232 interface for printing:

- 1 Select the **Printer Setup** field.
- 2 When the pop-up appears, select "Printer Connected to **RS-232**" field, and toggle to the **Printer** selection as shown below.
- 3 Select the field to the right of "Printer" and when the pop-up appears, select the printer that you're using (like, ThinkJet or QuietJet). If you're using an Epson graphics printer or an Epson-compatible printer, select **Alternate**.

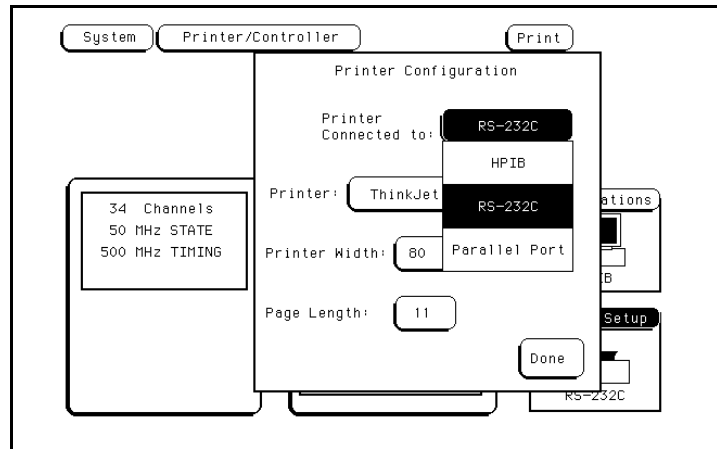

RS-232 Configuration Menu (1664A)

See Also

"RS-232 / GPIB Interface" chapter for more information on selecting the baud rate, stop bits, parity, and protocol to match the setup for the RS-232C printer.

- 4** Select the "Print Width" field. The print width toggles between **80** and **132**. Select the width for your application or leave it at the default of 80.

Print width tells the printer that you are sending up to 80 or 132 characters per line (when you **Print All**) and is totally independent of the printer itself.

- 5** Touch the "Print Length" field and print length toggles between **11** and **12**. Select the length for your application or leave it at the default of **11**.

Print length tells the printer the page length for the type of paper you are using.

- 6** Press the front-panel **Done** key.

Parallel Printers (1664A Only)

The 1664A interfaces directly with Centronix (parallel) printers including the HP ThinkJet, HP QuietJet, HP LaserJet, HP PaintJet, and HP DeskJet printers.

Parallel Printer Setup

To set up the parallel printer, perform the following steps:

- 1 Turn off the instrument and connect a parallel cable from the printer to the parallel printer port connector on the rear panel of the instrument. Turn on the instrument.

Parallel Printer Port
connector

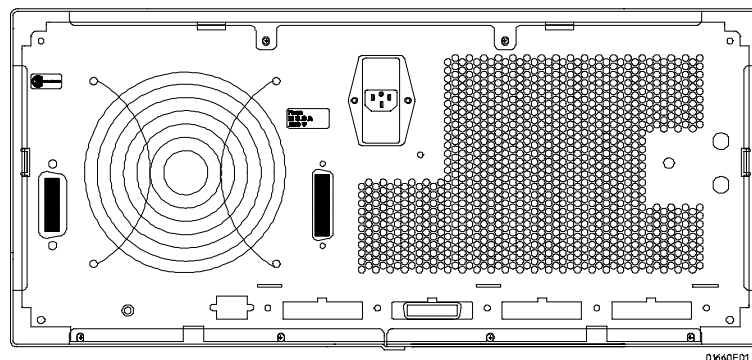

Parallel Printer Port Connector

- 2 Before turning on the printer, configure the printer (switches/menu) for parallel operation. Information for parallel operation is located in the *User's Guide* provided with the printer.

Parallel Configuration

From the Printer/Controller menu, perform the following steps to configure the Parallel interface for printing:

- 1 Select the **Printer Setup** field.

- 2 When the pop-up appears, select "Printer Connected to **Parallel Port**" field, and toggle to the **Printer** selection as shown below.
- 3 Select the field to the right of "Printer" and when the pop-up appears, select the printer that you're using (like, ThinkJet or QuietJet). If you're using an Epson graphics printer or an Epson-compatible printer, select **Alternate**.

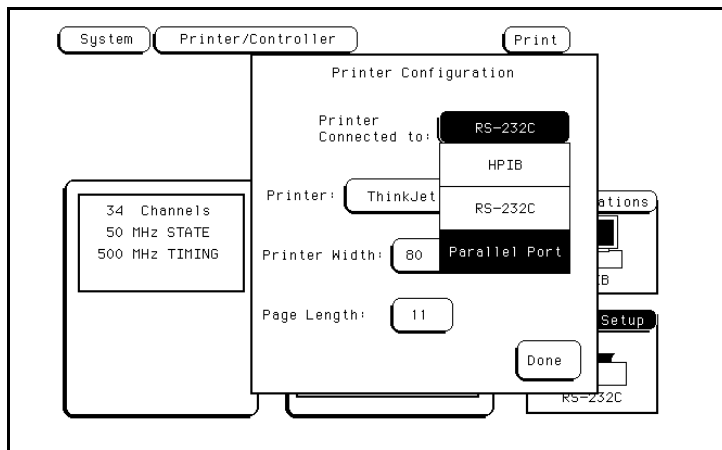

Parallel Port Configuration Menu

- 4 Select the "Print Width" field. The print width toggles between **80** and **132**. Select the width for your application or leave it at the default of 80.
Print width tells the printer that you are sending up to 80 or 132 characters per line (when you **Print All**) and is totally independent of the printer itself.
- 5 Touch the "Print Length" field and print length toggles between **11** and **12**. Select the length for your application or leave it at the default of 11.
Print length tells the printer the page length for the type of paper you are using.
- 6 Press the front-panel **Done** key.

Connecting to Other Hewlett-Packard Printers

The instrument can also be used with other Hewlett-Packard graphics printers. Simply connect the printer to the instrument using the appropriate cable (GPIB, RS-232C, or Centronix) and configure the instrument as shown below.

For this HP Printer	Select this Printer from the pop-up
HP 2631G	QuietJet
HP 2671G	ThinkJet
HP 2673A	ThinkJet
HP 9876A	ThinkJet
HP 2932/34 (option 046)	QuietJet

HP Printer Configuration Guide

Connecting a Printer Connecting to Other Hewlett-Packard Printers

GPIB printers must support Listen Always to work with the instrument. The HP 82906A graphics printer is not supported because it does not support Listen Always on GPIB.

The HP 2932A or HP 2934A option 046 printer is configured from the front panel of the printer, instead of with switches on the rear panel. The correct configuration for the analyzer is shown.

```
***** SETTINGS *****
***** LIST *****
PRINTER INTERFACE PRINTER INTERFACE
*****
***** LIST INTERFACE *****
GP-IB
SECONDARY COMMANDS LISTEN ALWAYS SERVICE REQUEST ADDRESS SET DEFAULTS
off on off 1
***** END OF SETTINGS *****
```

16501B01

Front Panel Configuration for the HP 2932A or 2934A Option 046

See Also

The Programming Reference Manual for information on setting up an external controller to activate the printer.

Printing the Display

After connecting the printer to the instrument and setting the printer and instrument configurations, apply power to the printer.

Each menu has a Print field in the upper-right corner. Select the Print field and a pop-up appears, displaying your choices.

- Cancel is used to stop the instrument from sending data.
- Print Screen prints everything shown on the screen.
- Print All (available only in certain menus) prints all of the information listed for that display, including any listings that do not appear on screen. These listings can be 80 or 132 characters wide, depending on the Print Width setting.
- Print Disk is used to print measurement data to a DOS[®] or LIF disk, which can then be copied into a computer file. The Print Disk function is the same as the Print All function except the data is printed to a disk.

To initiate a hard copy print, perform the following steps:

- 1** Using the **arrow** keys highlight the **Print** field, then press the **Select** key.
- 2** Select the **Print Screen** or **Print All** field, then press the **Select** key.

The instrument does not check the operation of the printer, so no error messages are displayed.

See Also

"Print field" in the Common Menu Fields chapter for more information on Print Disk.





Disk Drive Operations

Disk Drive Operations

The logic analyzer has a built in 3.5 inch, double-sided, high-density or double-density, flexible disk drive. The disk drive is compatible with both LIF (Logical Interchange Format) and DOS (Disk Operating System) formats.

This chapter describes the disk operations available in the logic analyzer and how to use them. It is organized into separate "How to" examples demonstrating the use of the Disk menu and all the disk operations.

The Disk Operations

Nine disk operations are available:

- Autoload

Designates a set of configuration files to be loaded automatically the next time the analyzer is turned on.

- Copy

Any file can be copied from one disk to another, from one directory to another, or to the same disk.

- Duplicate Disk

All volume labels, directories, and file positions from one disk are copied exactly to another disk. The new disk is formatted to match the source disk if it is required. All files on the destination disk will be destroyed with this operation.

- Format Disk

Any double-sided, double-density, 3.5-inch flexible disk can be formatted in either LIF or DOS format. The directory and all files on the disk will be destroyed with this operation.

- Load

Instrument system configurations, analyzer measurement setups, including measurement data, and inverse assembler files for the analyzer can be loaded from the disk drive.

- Make Directory

This function creates a new directory on a DOS disk. Files can be saved or copied to the new directory using the store and copy commands.

- Pack Disk

This function packs files on a LIF disk. Packing removes all empty or unused sectors between files on a disk so that more space is available for files at the end of the disk.

- Purge

Any file on a disk can be purged (deleted) from the disk.

- Rename

Any filename on a disk can be changed to another name.

- Store

Instrument system configurations and analyzer measurement setups including measurement data can be stored to the disk drive.

Disk Operation Safeguards

If there is a problem or additional information is needed to execute an operation, a pop-up appears near the center of the screen displaying the status of the operation (for example, it displays an error message or prompts you to swap disk).

If executing a disk operation could destroy or damage a file, a pop-up appears when you select Execute. If you don't want to complete the operation, select Cancel to cancel the operation. Otherwise, select Continue and the operation will be continued.

Menu Map

The figure below displays a menu map for the System Disk menu.

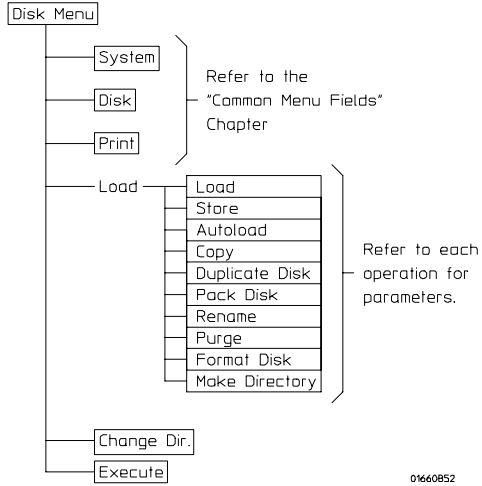

01660852

Disk Drive Menu Map

How to Access the Disk Menu

To access the System Disk menu, perform the following steps:

1 Press the **System MENU** key.

If you have just turned on the instrument, or if you have not accessed any System menus since powerup, the first menu displayed is the Disk menu.

If you are not in the Disk menu, continue with steps 2 and 3.

2 Press the **arrow** keys to move the cursor to the menu name field as shown below, then press the **Select** key.

3 Press the **arrow** keys or turn the knob to highlight the Disk field, then press the **Select** key.

If you have a disk installed when the Disk menu is accessed, the analyzer automatically reads and displays all files on the disk.

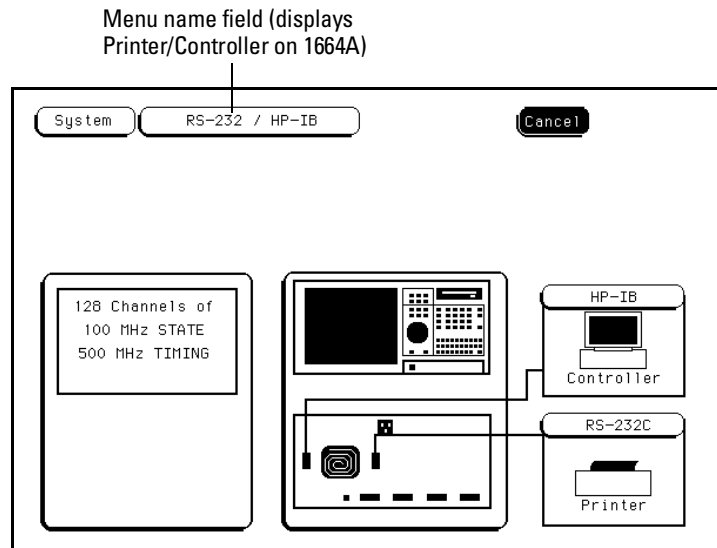

Menu Name Field

How to Install a Disk

To install a flexible disk into the disk drive, perform the following steps:

- 1** Hold the disk so the disk label is on top and the metal auto-shutter is away from you. See the figure below.
- 2** Push the disk gently, but firmly, into the disk drive until it clicks into place.

You can use double-sided, double-density and double-sided, high-density disks.

To display all files on any disk, insert the disk into the drive, then turn the knob.

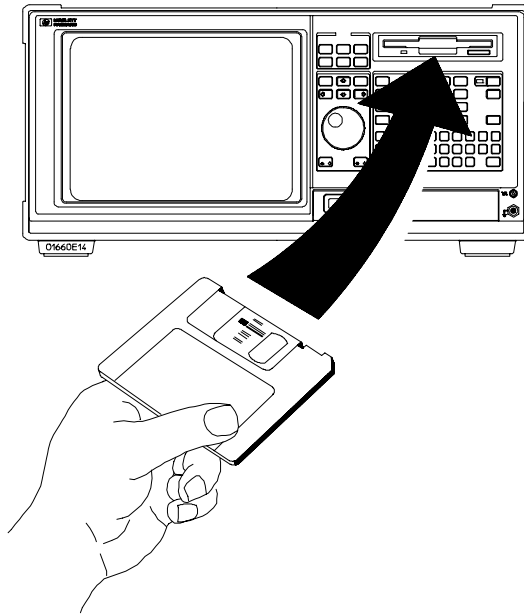

Installing a Disk

How to Select a Disk Operation

Although some default values are provided for disk operations, a disk operation may require additional information from the user. This information is entered in the appropriate fields within each disk operation.

To select a disk operation, perform the following steps:

- 1 Press the **arrow** keys to highlight the disk operation field shown in the figure below. Then press the **Select** key.

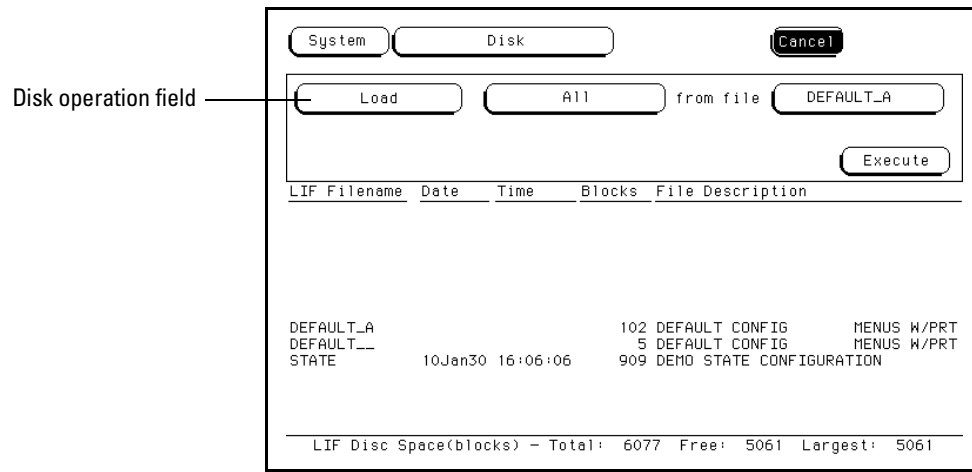

Disk Operation Field

- 2 Turn the knob to highlight the desired disk operation field, then press the **Done** or **Select** key.

How to Load a File

The Load operation allows you to load prestored configuration files. Use this operation when you want to quickly restore the analyzer to a configuration used in a previous measurement or condition.

When configurations are stored to the disk, you are given the option to store System only, Analyzer only, or All (System and Analyzer). So, when you load a file into the analyzer, you are given the same options.

To load a file from the disk, perform the following steps:

- 1 Insert the source disk into the disk drive.
- 2 Select the Load disk operation.

When the Load selection is made, the analyzer reads the disk directory and displays a list of all files on the disk.

- 3 Press the **arrow** keys to move the cursor to the file type field shown below, then press the **Select** key.

File type field

The screenshot shows a terminal-style interface for loading files. At the top, there are two buttons: 'System' and 'Disk'. To the right is a 'Cancel' button. Below these is a row of controls: a 'Load' button, a text field containing 'All', the text 'from file', and another text field containing 'DEFAULT_A'. An 'Execute' button is located at the bottom right of this control area. Below the controls is a table with columns: LIF Filename, Date, Time, Blocks, and File Description. The table lists three files: 'DEFAULT_A' (102 blocks), 'DEFAULT___' (5 blocks), and 'STATE' (909 blocks). At the bottom, a status line shows 'LIF Disc Space(blocks) - Total: 6077 Free: 5061 Largest: 5061'. A vertical line points from the 'File type field' label to the 'All' text field.

LIF Filename	Date	Time	Blocks	File Description
DEFAULT_A			102	DEFAULT CONFIG MENU W/PRT
DEFAULT___			5	DEFAULT CONFIG MENU W/PRT
STATE	10Jan30	16:06:06	909	DEMO STATE CONFIGURATION

LIF Disc Space(blocks) - Total: 6077 Free: 5061 Largest: 5061

File Type Parameter Field

- 4 Turn the knob to highlight the file type you want to load, then press the **Select** key.

The System choice loads things like Bus and display configurations.
The Analyzer choice loads analyzer menus and measurement data.

- 5 Turn the knob and notice the changing filenames in the filename field shown below, and how the cursor bar scrolls the list of available files.

Using the knob, scroll to the filename you want to load.

The two spaces(_ _) after the filename designates that this file is for the system. One space and a letter (for example, "_A") after the filename designates that the file is for the analyzer.

Filename Selection

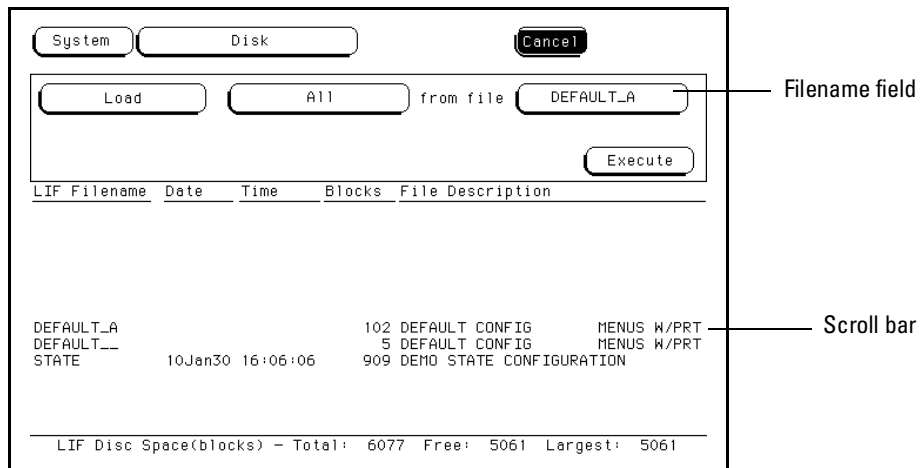

- 6 Press the **arrow** keys to highlight the Execute field, then press the **Select** key.

The disk drive indicator light illuminates as the file is being loaded.

How to Format a Disk

The Format operation allows you to initialize new disks for use in the logic analyzer. The analyzer will format double-sided, double density or high density disks in both LIF and DOS formats. The analyzer does not support any single-sided formats.

The logic analyzer does not support track sparing during formatting. If a bad track is found, the disk is considered bad. If a disk has been formatted elsewhere with track sparing, it will be read successfully.

To format a disk, perform the following steps:

- 1 Insert the disk to format into the disk drive.
- 2 Select the Format Disk operation.

When the Format Disk selection is made, the analyzer reads the disk directory and displays all files. The DISK ERROR message appears if the disk is a new un-formatted disk. This is normal, continue the format process.

- 3 Press the **arrow** keys to move the cursor to the format type field, then press the **Select** key.

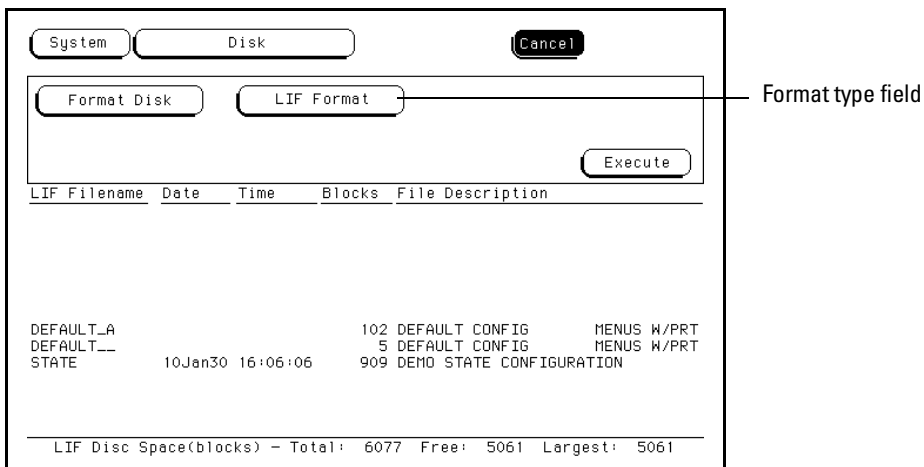

LIF or DOS Format Selection

- 4 Highlight the LIF or DOS format field, then press the **Select** key.**

The instrument will recognize a variety of sector sizes for LIF disks. When formatting LIF disks, the instrument creates 1024 byte sectors. DOS disks always have 512 byte sectors.

- 5 Press the **arrow** keys to move the cursor to the **Execute** field, then press the **Select** key.**

It should be noted that once Executed, the Format Disk operation permanently erases all existing information from the disk. After that, there is no way to retrieve the original information.

- 6 Highlight the **Continue** field, then press the **Select** key.**

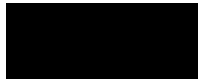

How to Store Files on a Disk

The Store operation allows you to store instrument configurations and measurement data. Use this operation when you want to save the present analyzer setup to recall at a later time.

When configurations are stored to the disk, you are given the option to store System only, Analyzer only, or All (System and Analyzer).

To store a file, perform the following steps:

- 1 Insert the destination disk into the disk drive.
- 2 Select the Store disk operation.

When the Store selection is made, the instrument reads the disk directory and displays a list of all files on the disk. If there are no files, NO FILES is displayed.

- 3 Press the **arrow** keys to move the cursor to the file type field, then press the **Select** key.

File type field

LIF Filename	Date	Time	Blocks	File Description
DEFAULT_A			102	DEFAULT CONFIG MENU W/PRT
DEFAULT_...			5	DEFAULT CONFIG MENU W/PRT
STATE	10Jan30	16:06:06	909	DEMO STATE CONFIGURATION

LIF Disc Space(blocks) - Total: 6077 Free: 5061 Largest: 5061

File Type Parameter Field

- Turn the knob to highlight the file type you want to store, then press the **Select** key.

The System choice stores things like Bus and display configurations.
 The Analyzer choice stores analyzer menus and measurement data.
 The All choice stores System and Analyzer types.

- Press the **arrow** keys to move the cursor to the file name field.

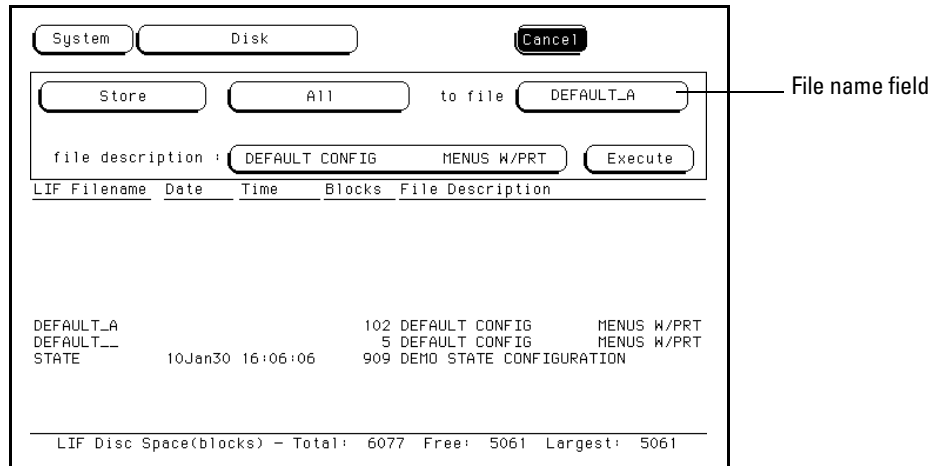

File Name Field

- Using the front-panel keypad, type in a filename to assign to the new file, then press the **Select** key.

The filename must start with a letter and may contain up to eight characters. It can be any combination of letters and numbers, but there can be no blank spaces between any of the characters.

If you want to select an existing filename, simply turn the knob to scroll existing filenames through the field. Also, notice how the cursor bar highlights the same name in the list of filenames.

The two spaces(_ _) after the filename designates that this file is for the system. One space and a letter (for example, "_A") after the filename designates that the file is for the analyzer.

7 Press the **arrow** keys to move the cursor to the file description field.

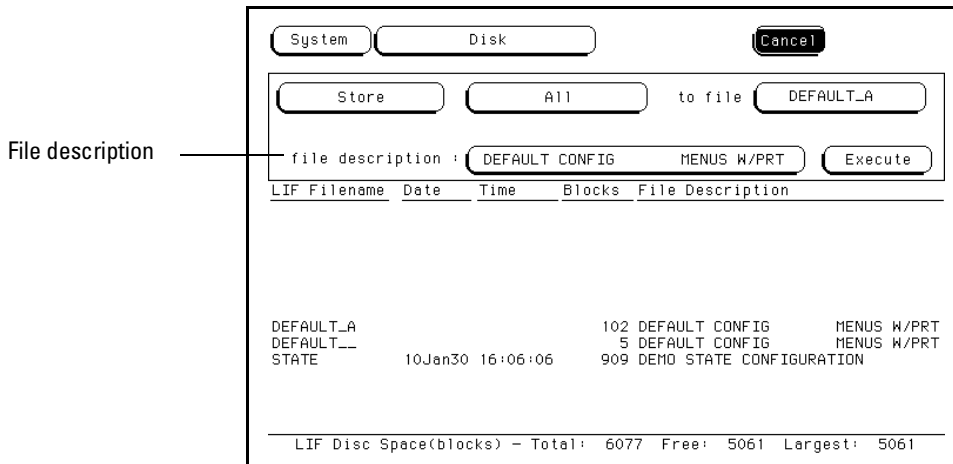

File Description Field

8 Using the front-panel keypad, type in a description of the file, then press the **Select** key.

A file description can contain up to 32 characters, but also can be left blank. This field is for your convenience to make it easier to identify the type of data in each file.

9 Press the **arrow** keys to move the cursor to the Execute field, then press the **Select** key.

10 Highlight the Continue field, then press the **Select** key.

How to Rename a File

The Rename operation allows you to give a new name to a previously stored file. The only restriction is that you cannot rename a file to an already existing filename.

To rename a file, perform the following steps:

- 1 Select the Rename disk operation.
- 2 Turn the knob until the filename you want to rename is scrolled into the file field.

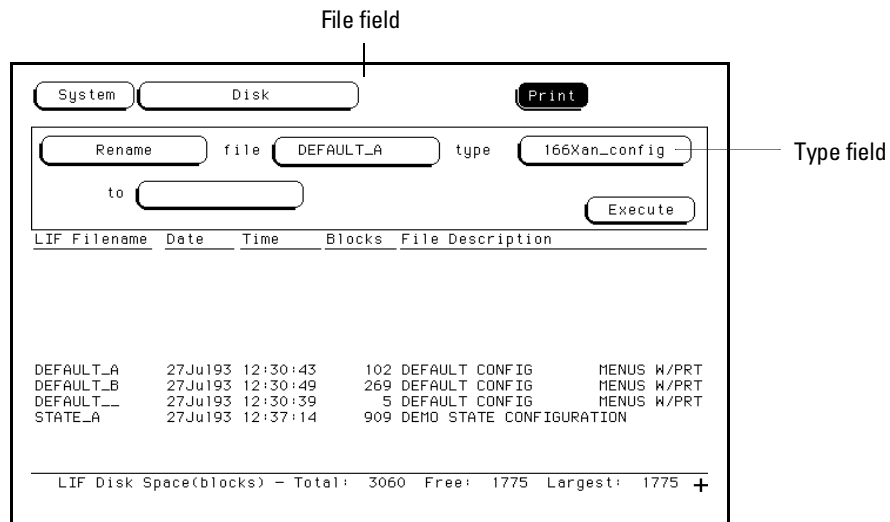

File Field

- 3 Press the **arrow** keys to move the cursor to the type field, then press the **Select** key.
- 4 Turn the knob to highlight the file type you want to rename, then press the **Select** key.

The All selection allows you to rename all of the system and analyzer types. The analyzer selection allows only the analyzer type to be renamed.

- 5 Press the **arrow** keys to move the cursor to the new filename field.

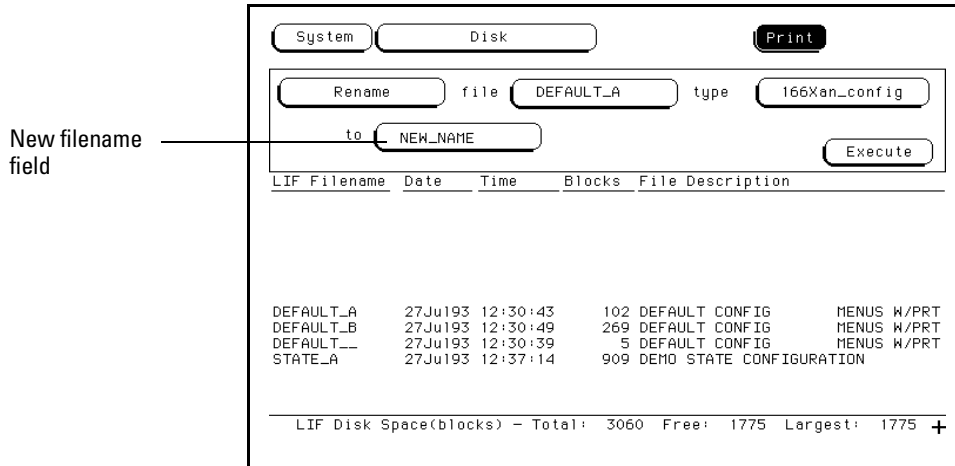

New Filename Field

- 6 Using the front-panel keypad, type in the new filename , then press the **Select** key.
- 7 Press the **arrow** keys to move the cursor to the Execute field, then press the **Select** key.

How to Autoload a File

The Autoload operation allows you to designate a set of configuration files to be loaded automatically the next time the instrument is turned on. This allows you to change the default configuration of certain menus to a configuration that better fits your needs.

To enable the Autoload operation, perform the following steps:

- 1 Select the Autoload disk operation.
- 2 Press the **arrow** keys to move the cursor to the Enable/Disable selection field, then press the **Select** key.
- 3 Highlight the Enable field, then press the **Select** key.
- 4 Press the **arrow** keys to move the cursor to the autoload filename field.

Enable/Disable field

System
Disk
Print

Autoload
Enable
File : DEFAULT_A

Current AUTOLOAD status : DISABLED
Execute

LIF Filename	Date	Time	Blocks	File Description
DEFAULT_A	27Jul93	12:30:43	102	DEFAULT CONFIG MENUS W/PRT
DEFAULT_B	27Jul93	12:30:49	269	DEFAULT CONFIG MENUS W/PRT
DEFAULT_	27Jul93	12:30:39	5	DEFAULT CONFIG MENUS W/PRT
STATE_A	27Jul93	12:37:14	909	DEMO STATE CONFIGURATION

LIF Disk Space(blocks) - Total: 3060 Free: 1775 Largest: 1775 +

Autoload filename field

Autoload Filename Parameter Field

- 5 Turn the knob until the filename you want to autoload is scrolled into the filename parameter field.
- 6 Press the **arrow** keys to move the cursor to the Execute field, then press the **Select** key.

An autoload file is created and placed at the top of the list of files. The file description contains the filename to be autoloaded and indicates whether or not the Autoload operation is enabled.

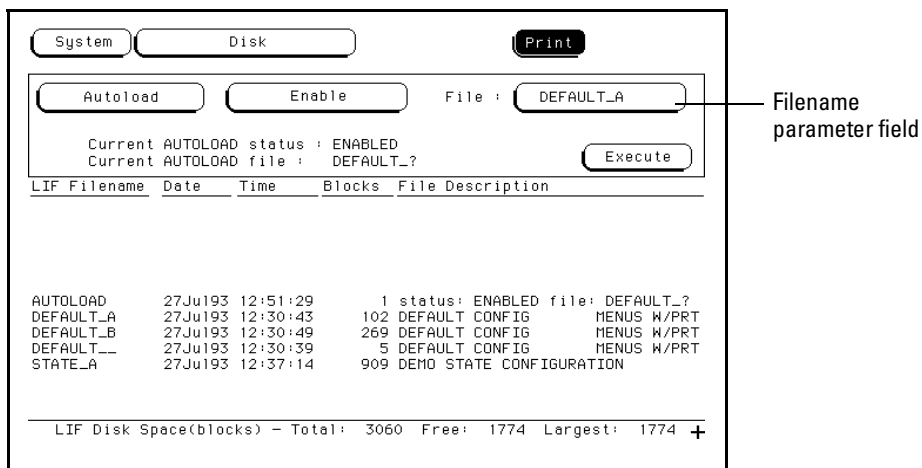

Autoload Filename Field

It should be noted that Autoload loads all of the files for a given filename. If you want to load only the file for a type, rename that file to separate it from the other files and enable it as the current Autoload file.

As long as Autoload is enabled before the instrument is shut off, Autoload will remain enabled when you powerup the instrument and load the configuration files.

How to Purge a File

The Purge operation allows you to delete a file from the list of filenames. The file type can be either the analyzer type or All types. To purge a file from the disk, perform the following steps:

- 1 Select the Purge disk operation.
- 2 Turn the knob to scroll the filename into the file field.

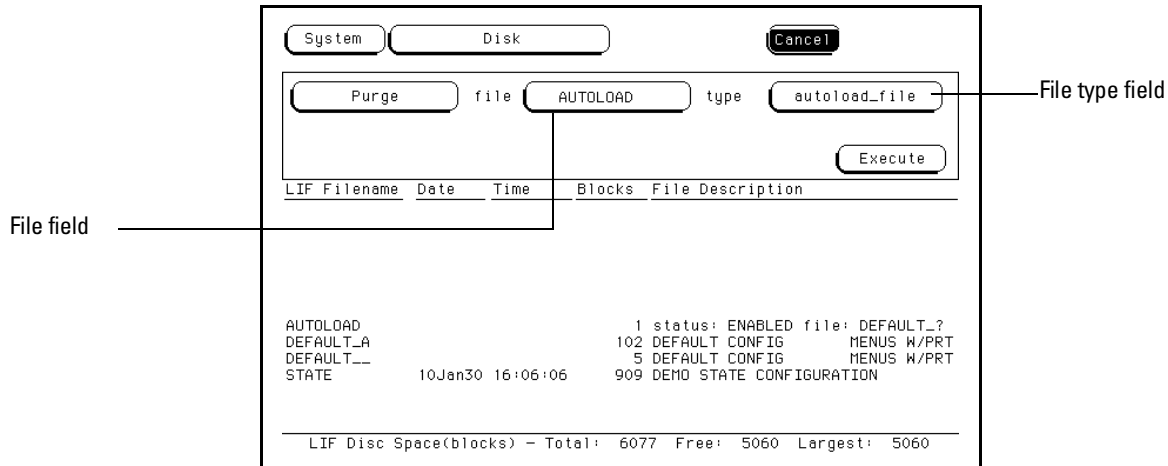

File Field

- 3 Press the **arrow** keys to move the cursor to the file type field, then press the **Select** key.
- 4 Highlight the file type to purge, then press the **Select** key.
 The All selection allows you to purge the system and analyzer types. The analyzer selection allows only the analyzer type to be purged.
- 5 Press the **arrow** keys to move the cursor to the Execute field, then press the **Select** key.
- 6 Highlight the Continue field, then press the **Select** key.

How to Copy a File

The Copy operation allows you to make a duplicate copy of an existing file on the same disk or a different disk. If you copy the file to the same disk, the only restriction is that you must give the copied file a new name. You can specify to copy All types or just the analyzer part of a file.

To make copies of a file, perform the following steps:

- 1 Select the Copy disk operation.
- 2 Turn the knob until the filename you want to copy is scrolled into the file field.

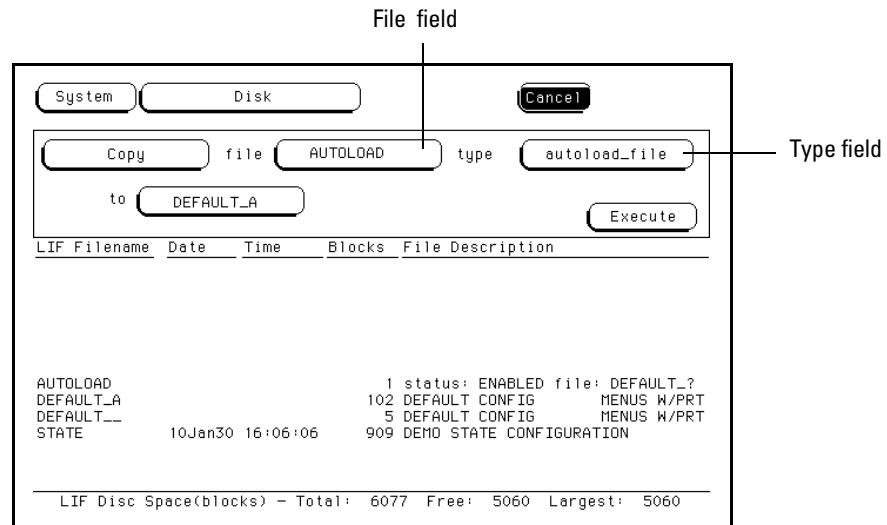

Copy Filename Parameter Field

- 3 Press the **arrow** keys to move the cursor to the type field, then press the **Select** key.

- 4 Highlight the file type to copy, then press the **Select** key.
The All selection allows you to copy the system and analyzer parts of a configuration file set. The analyzer selection allows only the analyzer part to be copied.
- 5 Press the **arrow** keys to move the cursor to the new filename field.

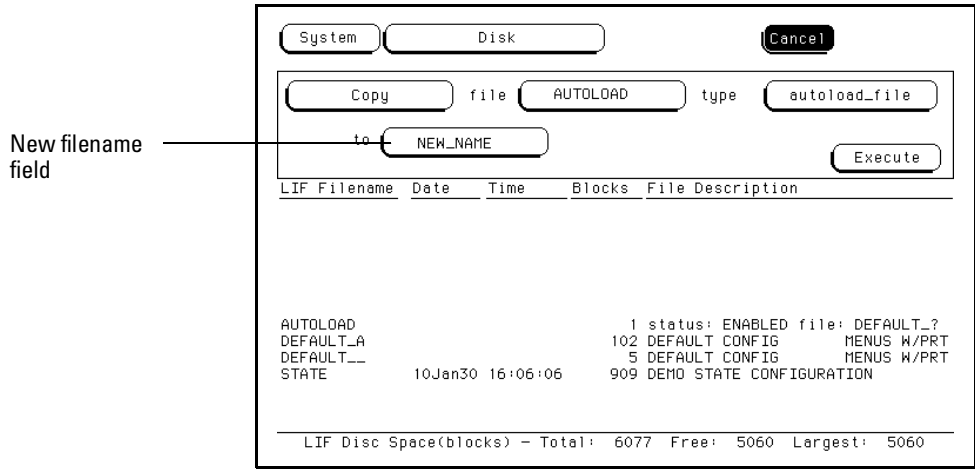

New filename Field

- 6 Using the front-panel keypad, type in the new filename, then press the **Select** key.
- 7 Press the **arrow** keys to move the cursor to the Execute field, then press the **Select** key.
- 8 Highlight the Continue field, then press the **Select** key.
It is highly recommended that you complete the Copy operation in its entirety. Selecting Cancel during a Copy operation may result in a corrupted file copy.

How to Pack a Disk

By purging files from the disk and adding other files, you may end up with blank areas on the disk (between files) that are too small for the new files you are creating. On LIF disks, the Pack Disk operation packs the current files together, removing unused areas from between the files so that more space is available for files at the end of the disk. On DOS disks, the Pack Disk operation is not displayed.

To pack the disk, perform the following steps:

- 1 Select the Pack Disk operation.
- 2 Press the **arrow** keys to move the cursor to the Execute field, then press the **Select** key.

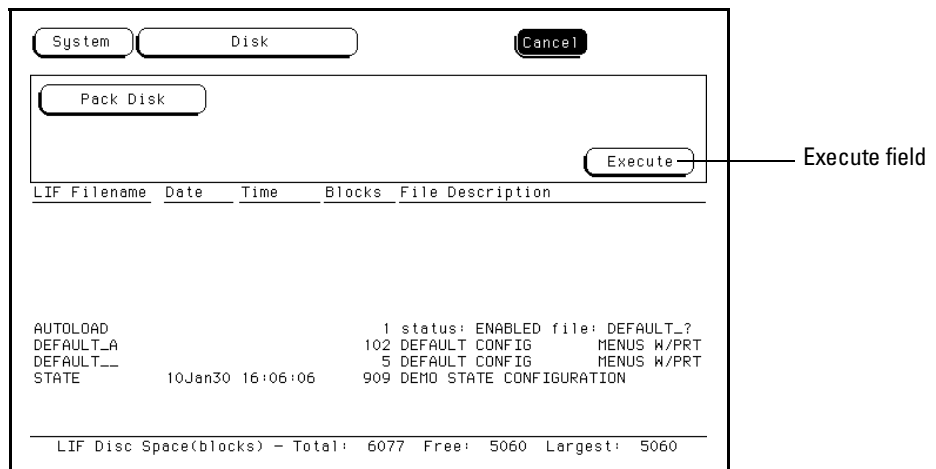

Pack Disk Operation

How to Duplicate a Disk

The Duplicate Disk operation copies the volume labels and directories from one disk to another. If necessary, the new disk is formatted to match the source disk. This operation allows you to make a back-up copy of your important disks so you won't lose important data in the event that a disk wears out, is damaged, or a file is accidentally deleted.

To duplicate the disk, perform the following steps:

- 1 Select the Duplicate Disk operation.
- 2 Press the **arrow** keys to move the cursor to the Execute field, then press the **Select** key.

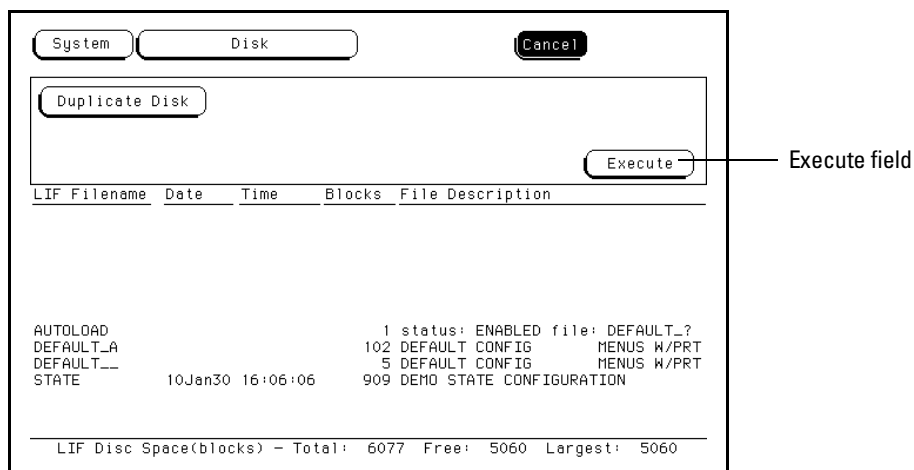

The Duplicate Disk Operation

3 Highlight the Continue field, then press the **Select key.**

When "Insert DESTINATION disk" appears, insert the destination disk into the disk drive, and when "Insert SOURCE disk" appears, remove the destination disk and reinstall the source disk. The number of times you need to change the disks depends on whether you have a double-density or high-density disk. Simply follow the instructions and select Continue to continue.

It should be noted that the original directory and files on the destination disk are destroyed by the Duplicate Disk operation.

How to Make a Directory

The Make a Directory operation is used to create a new, blank directory or sub-directory on a DOS disk. After a new directory is created, files can be copied and stored using the COPY and STORE functions. Note that only the selected directory's contents are shown (the selected directory is displayed in the lower left portion of the display). The Change Dir. selection is used to change directories. On LIF disks, the Make a Directory operation is not displayed.

To make a new directory on the DOS disk, perform the following steps:

- 1 Select the Make Directory operation.
- 2 Press the **arrow** keys to move the cursor to the New Directory Name field, then press the **Select** key.
- 3 Using the front-panel keypad, type in the new directory name, then press the **Select** key.

If you are currently in a directory, the Make a Directory selection will create a sub-directory within the current directory.

- 4 Press the **arrow** keys to move the cursor to the Execute field, then press the **Select** key.

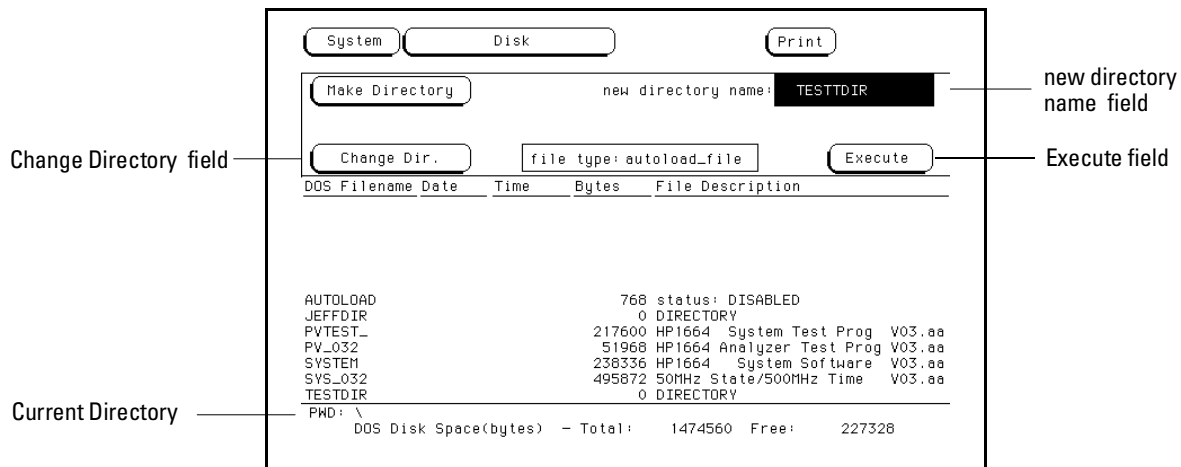

Make Directory Operation

- 5 To select the new directory, or display the contents of a different directory, press the **arrow** keys to move the cursor to the Change Dir. field, then press the **Select** key until "PWD: \" is displayed. Use the knob to choose the desired directory, then press the **Select** key to display the contents of the selected directory.



The RS-232C, GPIB, and Centronix Interface

The RS-232C, GPIB, and Centronix Interface

This chapter describes the controller and printer interfaces and their configuration. It defines the GPIB interface and describes how to select any one of the 31 different GPIB addresses available. It also defines the RS-232C interface and tells you how to select a baud rate, how to change the stop bits, how to set the parity and data bits, and how to change the protocol. The 1664A Centronix (parallel) interface (printer only) is also described.

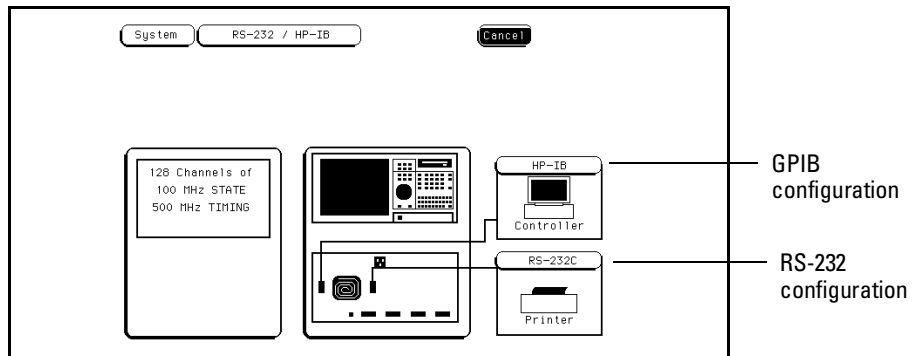

RS-232 / GPIB Interface Menu (1660A through 1663A)

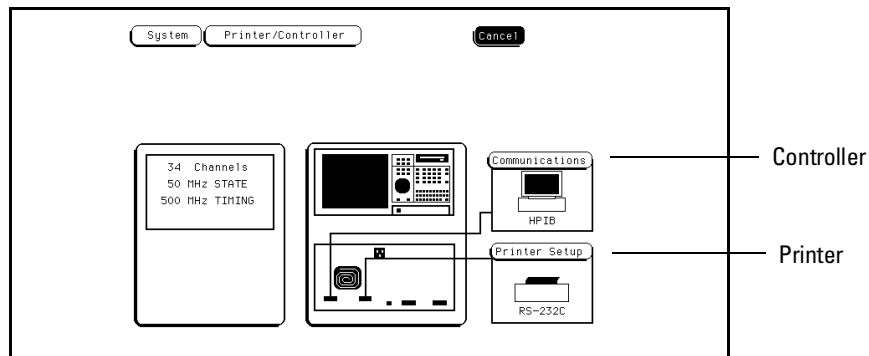

RS-232 / GPIB Interface Menu (1664A)

RS-232 / GPIB Menu Map (1660A through 1663A)

The following menu map illustrates all fields and the available options in the RS-232 / GPIB menu. The menu map will help you get an overview as well as provide you with a quick reference of what the RS-232 / GPIB menu contains.

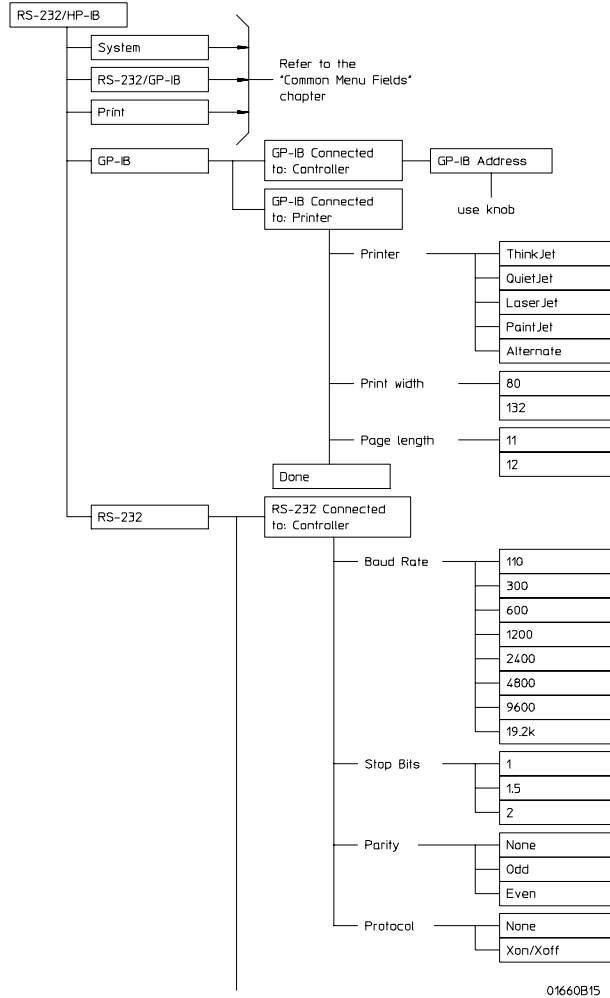

RS-232 / GPIB Menu Map

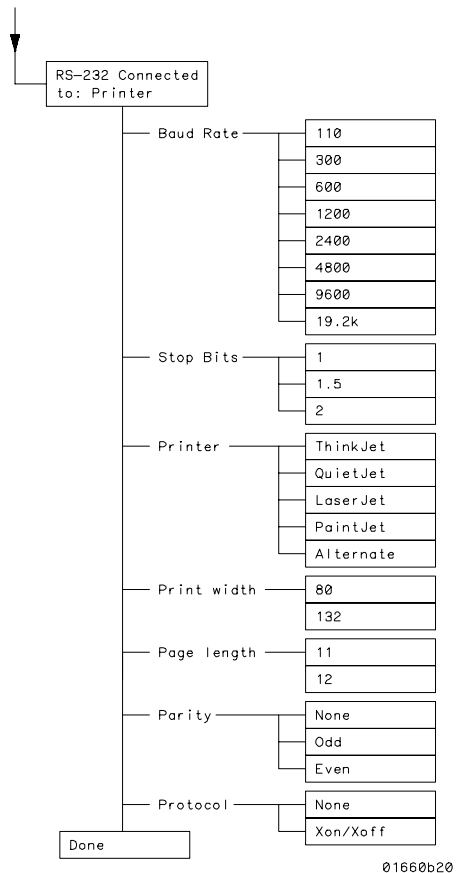

01660b20

RS-232 / GPIB Menu Map (Cont).

Printer/Controller Menu Map (1664A)

The following menu map illustrates all fields and the available options in the Printer/Controller menu. The menu map will help you get an overview as well as provide you with a quick reference of what the Printer/Controller menu contains.

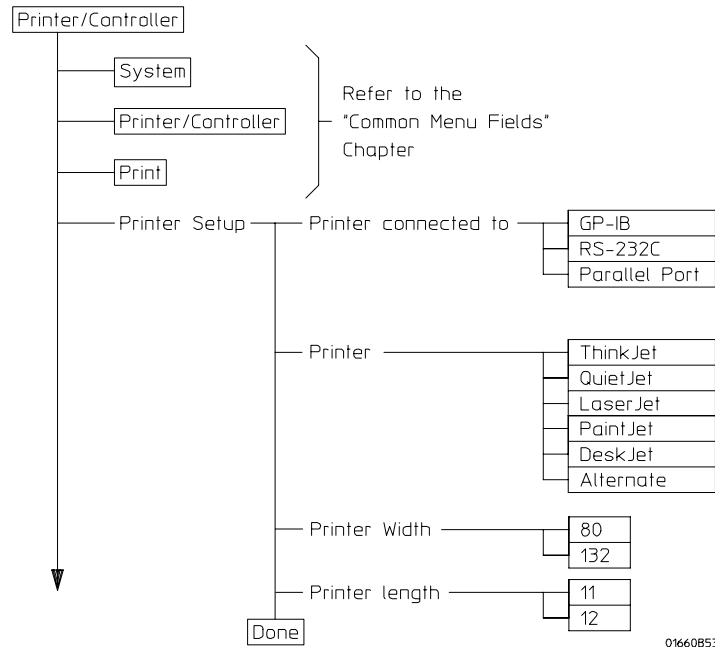

Printer/Controller Menu Map

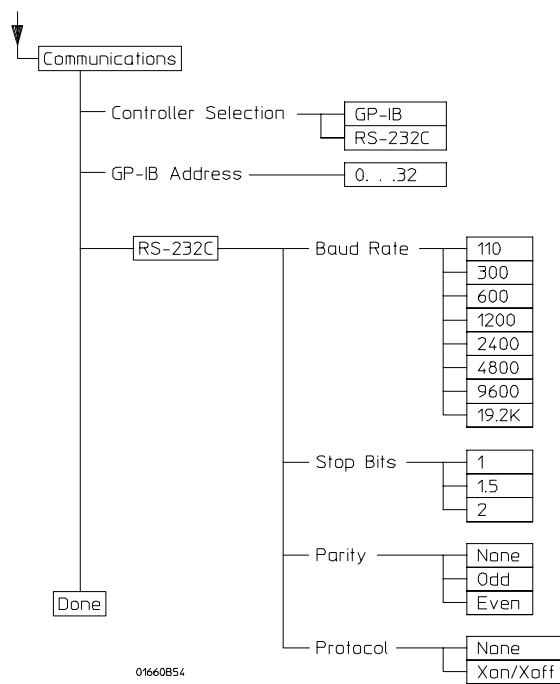

Printer/Controller Menu Map (Cont).

The Controller Interface

The instrument is equipped with a standard RS-232C interface and an GPIB interface that allow you to connect to a controller (GPIB and RS-232C optional on the 1664A). Either interface gives you remote access for running measurements, for up-loading and down-loading configurations and data, and more.

The Printer Interface

The instrument can output its screen display to various GPIB, RS-232C, and Centronix (1664A only) graphics printers. Configured menus as well as waveforms and other data can be printed for complete measurement documentation.

See Also

"Connecting a Printer" for more details.

Agilent Technologies 1660A Series Logic Analyzers Programming Manual for more information on the controller interface.

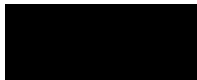

The GPIB Interface

The General Purpose Interface Bus (GPIB) is Agilent Technologies' implementation of IEEE Standard 488-1978, "Standard Digital Interface for Programmable Instrumentation." The GPIB is a carefully defined interface that simplifies the integration of various instruments and computers into systems.

The GPIB interface uses an addressing technique to ensure that each device on the bus (interconnected by GPIB cables) receives only the data intended for it. To accomplish this, each device is set to a different address and this address is used to communicate with other devices on the bus.

Selecting an Address (1660A through 1663A)

The GPIB address can be set to 31 different GPIB addresses, from 0 to 30. Simply choose a compatible address of your device and software.

To select an GPIB address perform the following steps:

- 1 From the RS-232 / GPIB menu, select the **GPIB** field.
- 2 Turn the front-panel knob to select the GPIB Address, then press the **Done** key.

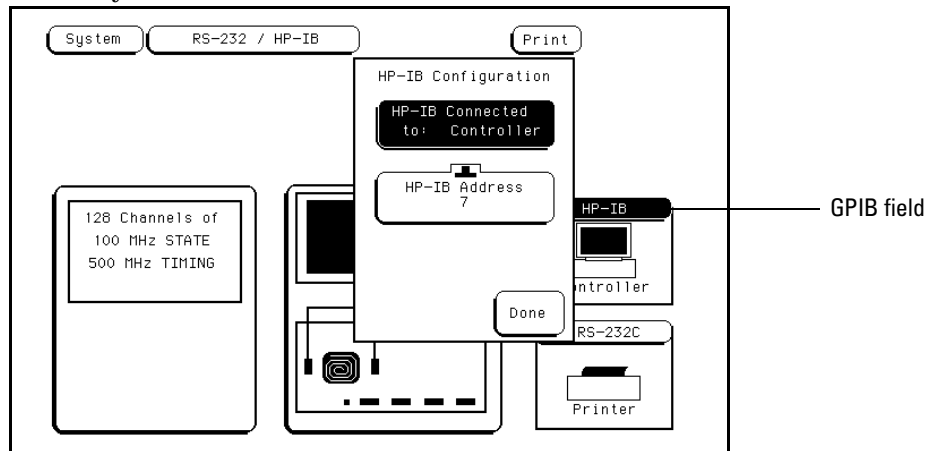

GPIB Configuration Pop-up Menu (1660A through 1663A)

Selecting an Address (1664A)

The GPIB address can be set to 31 different GPIB addresses, from 0 to 30. Simply choose a compatible address of your device and software.

To select an GPIB address perform the following steps:

- 1 From the Printer/Controller menu, select the **Communications** field.
- 2 When the pop-up menu appears, select "GPIB Address" field, then press the **Select** key.
- 3 Turn the front-panel knob to select the GPIB Address, then press the **Done** key.

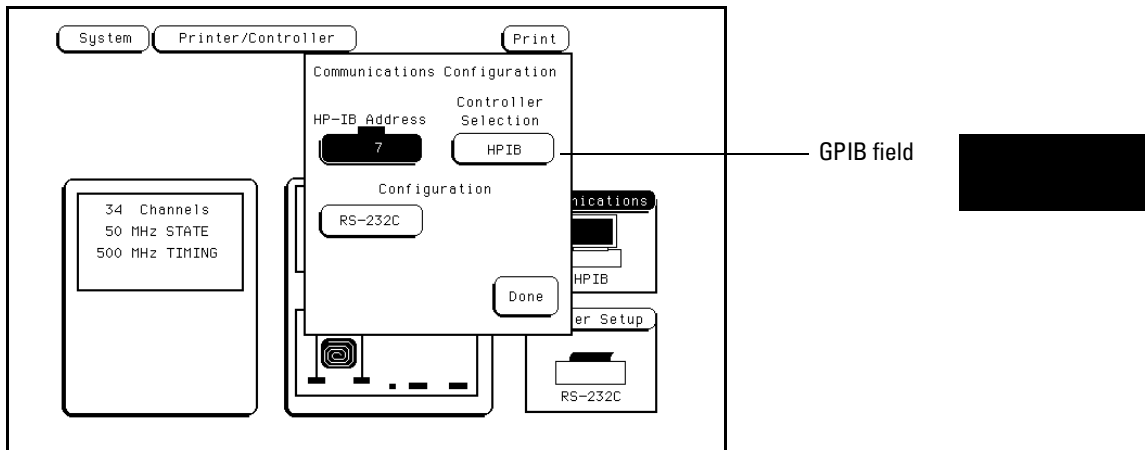

GPIB Configuration Pop-up Menu (1664A)

The RS-232C Interface

The RS-232C interface is Agilent Technologies' implementation of EIA Recommended Standard RS-232C, "Interface Between Data Terminal Equipment and Data Communications Equipment Employing Serial Binary Data Interchange."

With this interface, data is sent one bit at a time and characters are not synchronized with preceding or subsequent data characters. Each character is sent as a complete entity without relationship to other events.

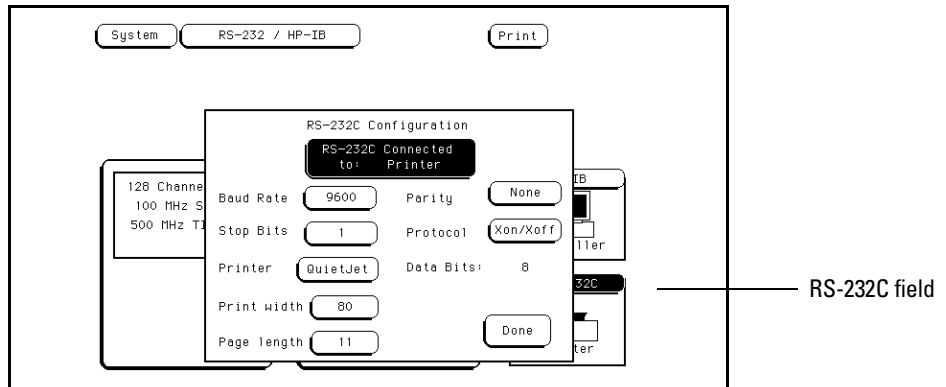

RS-232C Configuration Pop-up Menu (1660A through 1663A)

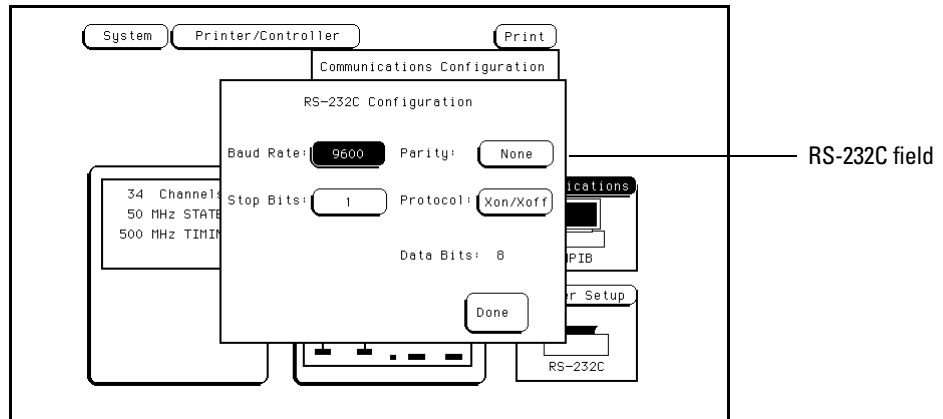

RS-232C Configuration Pop-up Menu (1664A)

Baud Rate

The baud rate is the rate at which bits are transferred between the interface and the peripheral. The baud rate must be set to transmit and receive at the same rate as the peripheral.

To set the baud rate, select the Baud Rate field. Then, select the desired rate from the pop-up selection list.

Stop Bits

Stop Bits are used to identify the end of a character. The number of Stop Bits must be the same for the controller as for the logic analyzer.

To change the Stop Bits, select the Stop Bits field, then select the desired stop bit from the pop-up selection list.

Parity

The parity bit detects errors as incoming characters are received. If the parity bit does not match the expected value, the character is assumed to be incorrectly received. The action taken when an error is detected depends on how the interface and the device program are configured.

Parity is determined by the requirements of the system. The parity bit may be included or omitted from each character by enabling or disabling the parity function.

To set the parity bit, select the Parity field, then select the desired Parity bit from the pop-up selection list.

Data Bits

Data bits are the number of bits sent and received per character that represent the binary code of that character. The 1660A Series supports the 8-bit binary code.



Protocol

Protocol governs the flow of data between the instrument and the external device.

To change the protocol, select the Protocol field, then select the desired the desired option from the pop-up selection list

With less than a 5-wire interface, selecting None does not allow the sending or receiving device to control how fast the data is being sent. No control over the data flow increases the possibility of missing data or transferring incomplete data.

With a full 5-wire interface, selecting None allows a hardware handshake to occur. With a hardware handshake, hardware signals control data flow. The 13242G cable allows the logic analyzer to support hardware handshake.

Xon/Xoff Xon/Xoff stands for Transmit On/Transmit Off. With this mode, the receiver controls the data flow and can request that the printer stop data flow at any time.

The Centronix Interface (1664A Only)

The Centronix interface is Agilent Technologies' implementation of the industry standard parallel printer interface. Note that the Centronix interface can only be used as a printer interface, and is not intended for use with a controller.

With this interface, 8-bits of data are sent in parallel (at the same time) to the printer, with seven additional lines used for handshaking, status, and timing.

See Also

"Connecting a Printer" chapter for more information on selecting the parallel printer port.



Configuring the Interface for a Controller or a Printer (1660A through 1663A Only)

To configure the GPIB or RS-232C interfaces for a controller or a printer, perform the following steps:

- 1 From the RS-232 / GPIB menu, highlight either the **GPIB** or **RS-232** field.
- 2 Highlight the "RS-232 Connected to" field and toggle it to either **Printer** or **Controller** as shown.

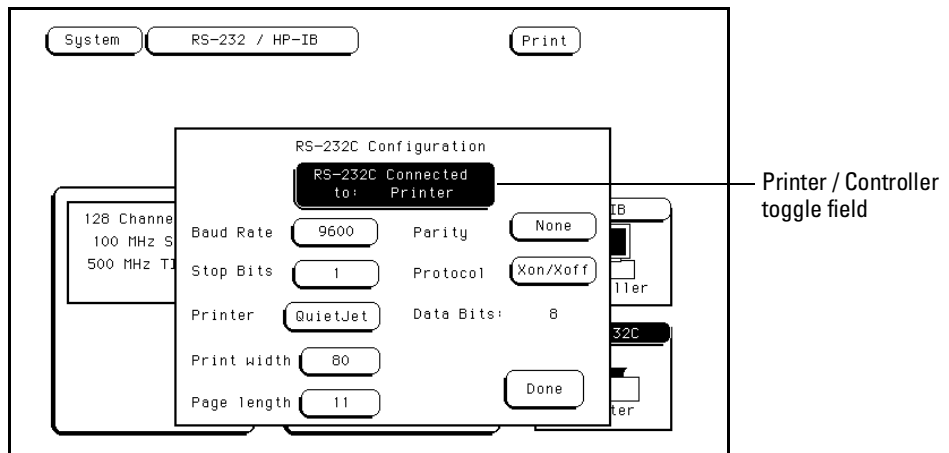

Printer Configuration for RS-232

Whenever you change the configuration for one interface, the other interface automatically changes to the opposite configuration.

The GPIB printer must be set to Listen Always for the GPIB interface. In this mode, no GPIB addressing is necessary, so the GPIB address field is not displayed.

When the configuration is set for Printer, three additional fields appear to allow you to select the printer type, character width, and page length.



The System Utilities

The System Utilities

The System Utilities menu is used for setting system level parameters such as the system clock, display intensity for each grey shade and turning the sound on and off. In this menu you can also reflash the "read only memory" chips (1660A through 1663A) with any new revisions of the operating system.

The Utilities menu is one of the System subset menus and is accessed through the System field in the upper left corner of the display.

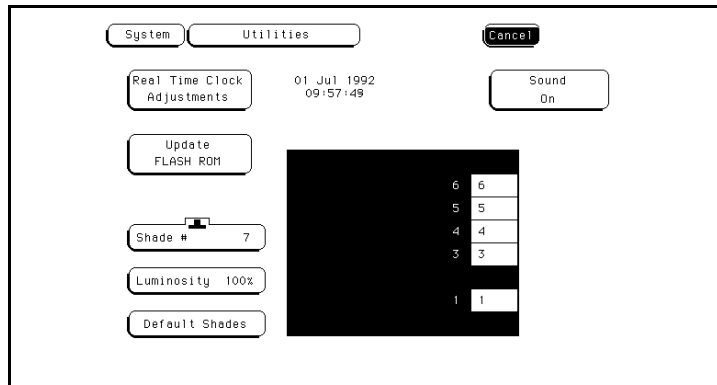

System Utilities Menu (1660A through 1663A)

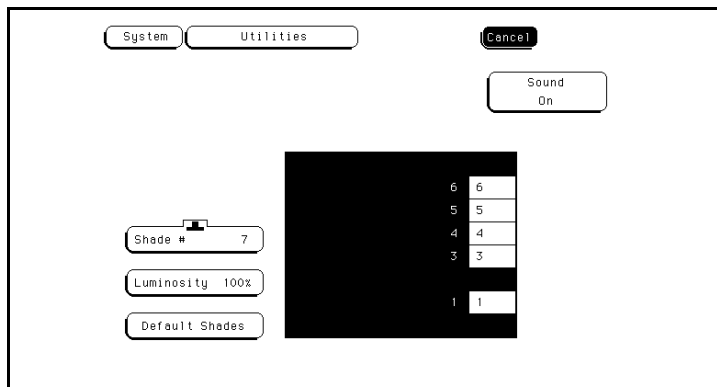

System Utilities Menu (1664A)

The Utilities Menu Map

The following menu map illustrates all fields and the available options in the Utilities menu. The menu map will help you get an overview as well as provide you with a quick reference of what the Utilities menu contains.

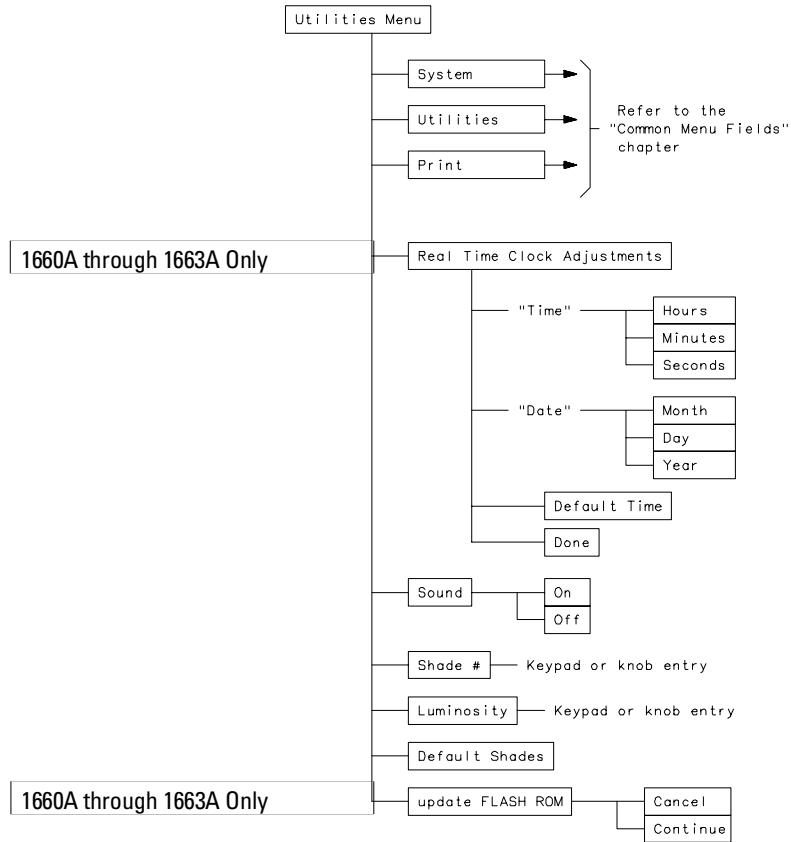

0166QB01

The Utilities Menu Map

Real Time Clock Adjustments (1660A Through 1663A Only)

A real time clock is displayed in the Waveform and Listing display menus. When you print a screen, the current clock and date appears on the hard copy.

To set the clock, select the Real Time Clock Adjustments field. A Real Time Clock menu appears with to set the time of day and the date. To set the Time (24 hour clock) highlight the hour, minute, and seconds fields and turn the knob.

To set the Date, select the day and year fields and turn the knob. Next, select the month field. A pop-up list appears with the appropriate choices of months. Select the correct month, then close the pop-up by selecting Done.

The screenshot shows a menu titled "Real Time Clock" with the following fields and buttons:

- System (button)
- Utilities (button)
- Print (button)
- Real Time Clock (title)
- Date: Day (15), Month (July), Year (1992)
- Time: Hours (14), Minutes (17), Seconds (19)
- Default Time (button)
- Done (button)

Real Time Clock Adjustment Menu

Update FLASH ROM (1660A Through 1663A Only)

For quick and easy updates to the operating system, the logic analyzer uses flash ROMs. To update the flash ROMs, simply insert the floppy disk containing the required update files into the disk drive, then select the Update FLASH ROM field. If you want to continue with the update process, select Continue. All current setups are lost after the update.

If you are not sure which files are required for the update procedure, a list will be provided onscreen when you select Continue.

Display Grey Shade Adjustments

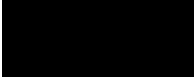
The shades of grey that are used to create the display, can be adjusted to different levels of intensity. The adjustment procedure involves two parts. First you select the shade number, then you adjust the luminosity of that shade. Both the shade and the luminosity fields are adjusted by highlighting the field, then turning the knob. 

Shade #

The Shade # field is used to select the shade number of which the luminosity adjustment effects. Shade numbers range from 1 to 7.

Luminosity

The Luminosity field is used to increase or decrease the intensity of the selected shade number. Luminosity ranges from 0 to 100 percent.

Default Shades

The Default Shades field is used to restore all shade intensity levels to the default factory settings.

Sound On / Off

Each time the cursor is moved or rolled from one field to another, an audible "click" is heard. The Sound field toggles the sound On or Off.



The Common Menu Fields

The Common Menu Fields

There are a number of fields that appear throughout the different menus that have similar operation. These common fields are listed below:

- System/Analyzer field
- Menu field
- Print field
- Run field
- Base field
- Label field
- Label and Base roll field

If there is any unique operation with any of these common fields in a particular menu, supplemental information is given in that menu. In all other cases of common operation, you are referred back to this section.

Common Menu Fields Menu Map

The Common Menu Fields menu map contains fields that appear in most, if not all, main menus. When these fields are discussed in other chapters, you will be referred back to this chapter and this menu map.

This menu map will help you get an overview as well as provide you with a quick reference of what the common menu fields are.

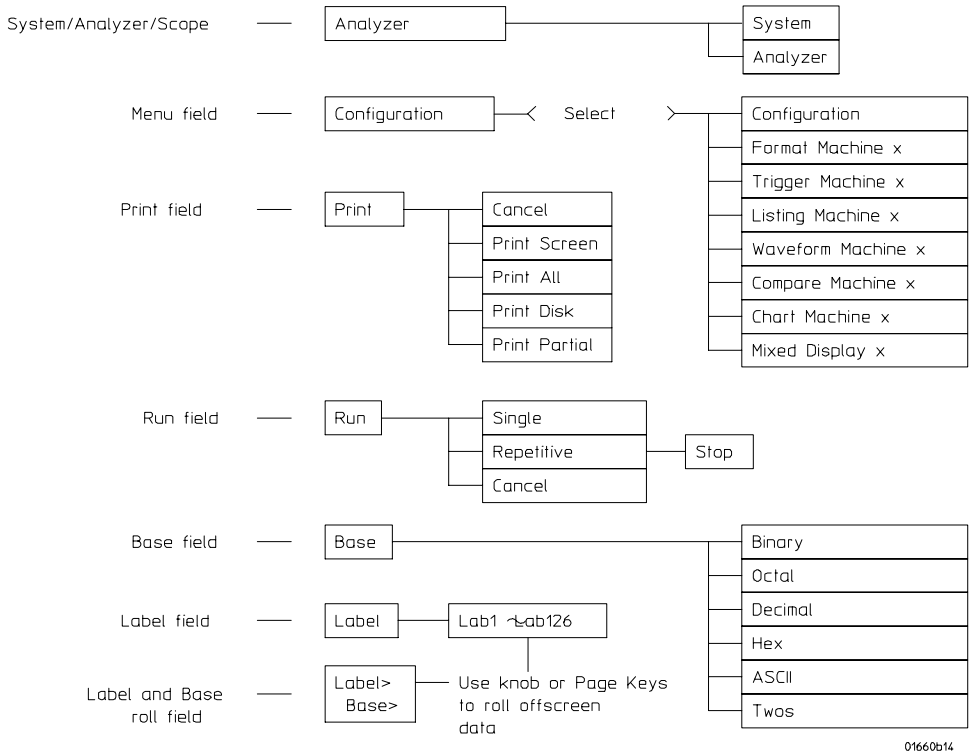

Common Menu Fields Menu Map

System/Analyzer Field

The System/Analyzer field is always located in the upper-left corner of all main menus. If you have accessed any of the System configuration menus, this field displays "System." If you have accessed any of the analyzers configuration menus, this field displays "Analyzer." The System/Analyzer field is used to access the following system level menus:

The System configuration menus

Disk
RS-232
Utilities
Test

The Analyzer configuration menus

Configuration
Format
Trigger
Listing
Waveform
Mixed Display
Compare
Chart

System/Analyzer field

System/Analyzer selection pop-up

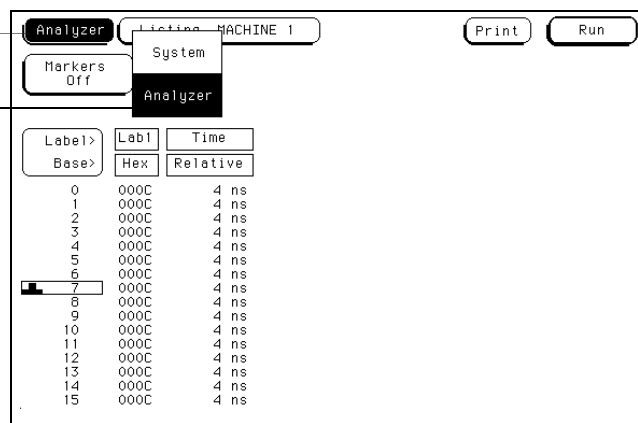

System / Analyzer Field

Menu Field

The Menu field is always the second field from the left, in the top row of fields. The Menu field identifies the System or Analyzer menu you are in, and you use it to access the other analyzer menus.

When a new menu is selected from the menu selection pop-up, the new menu appears and the name in the Menu field changes to the name of the new menu.

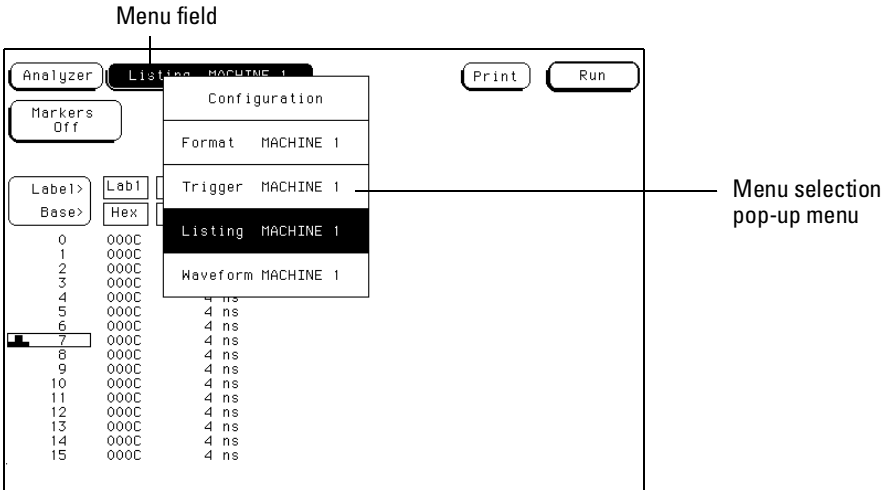

Menu Field

Print Field

The Print field allows you to print what is displayed on the screen at the time you initiate the printout. When you select the Print field, a print selection pop-up appears showing you one or more of the following options:

- Cancel
- Print Screen
- Print All
- Print Partial
- Print Disk

When you select one of the print options, the information in the display is frozen; then, the Print field changes to Cancel. While the printout is in process, the user interface is not active, with the exception of the Cancel field.

When the printout is complete, the advisory "Print Completed" is displayed and the user interface becomes active again.

Cancel

The Cancel field is used to terminate a printout before it is complete, or if you have changed your mind about printing after selecting the Print field.

If a print is canceled before completion, the message "Print Cancelled" appears.

Print Screen

The Print Screen option is used when a printout of just the current screen is desired.

Print All

The Print All option prints not only what data is displayed on the screen, but data that is below the screen in the Listing, Trace, and Compare menus.

When you select the Print All option, the message "Printing All" appears at the top of the display. This message will not appear in your printout.

When you select Print All, make sure the first line you wish to print is in the state location box at the center of the listing area. Lines above this box will not print.

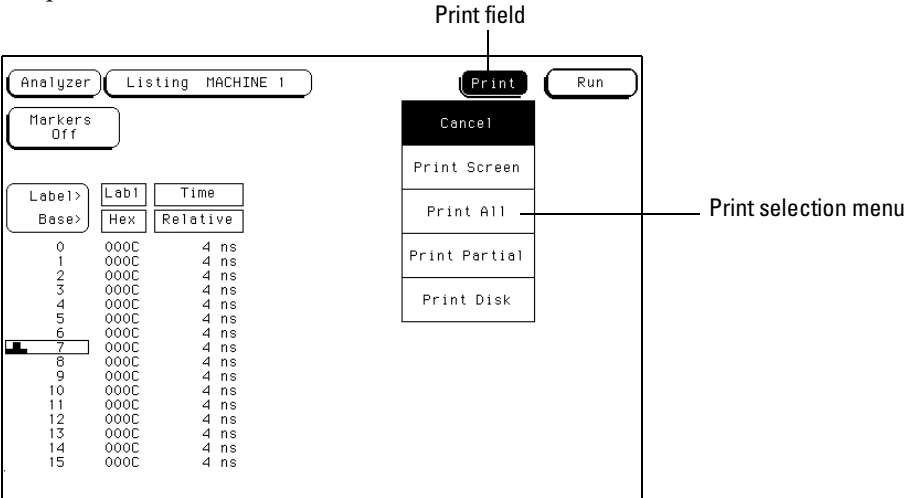

Print Field

Print Partial

The Print Partial option is identical to the print all option, except the start and end states are specified.

Print Field

Print Disk

The Print Disk option is very useful if you want to copy the measurement data in ASCII form to a DOS formatted disk in the disk drive. This operation is similar to the Print All option except the destination for the data is the disk instead of a graphics printer. Once the data is on a DOS disk, the data can be loaded into a computer.

When you select the Print Disk option, the messages "Calculating File Size" and "Writing byte xxx of xxx" appears at the top of the display.

When you select the Print Disk option, make sure the first line in the listing you wish to print is in the state location box at the center of the listing area. Lines above this box will not print.

When you select the Print Disk option from the pop-up, another pop-up appears. From this pop-up you can name the file you are writing to the disc, and also select the output format of that file. If print partial is selected, the start and end states are also specified. The output formats available are:

- ASCII
- B/W TIFF
- GRAY TIFF
- PCX
- EPS

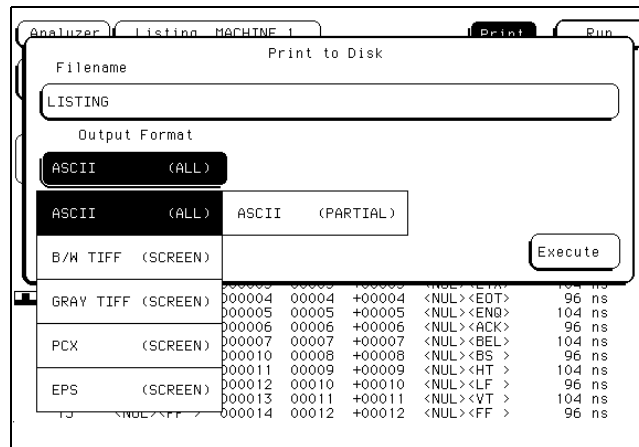

Format Output Pop-up

Run/Stop Field

The Run field starts the analyzer measurement. When Run is selected, the acquired data is displayed in the last measurement display menu accessed. If Stop is selected during a single run, the data acquisition is aborted. During a repetitive run, when Stop is selected after the first run cycle, the present single run cycle is completed before data is displayed.

Single

The Single option runs the data acquisition cycle one time.

Repetitive

The Repetitive option runs the single data acquisition cycle repeatedly until the Stop field is selected or until an assigned stop measurement condition is met.

Cancel

The Cancel option enables you to cancel the run without having to select either Single or Repetitive.

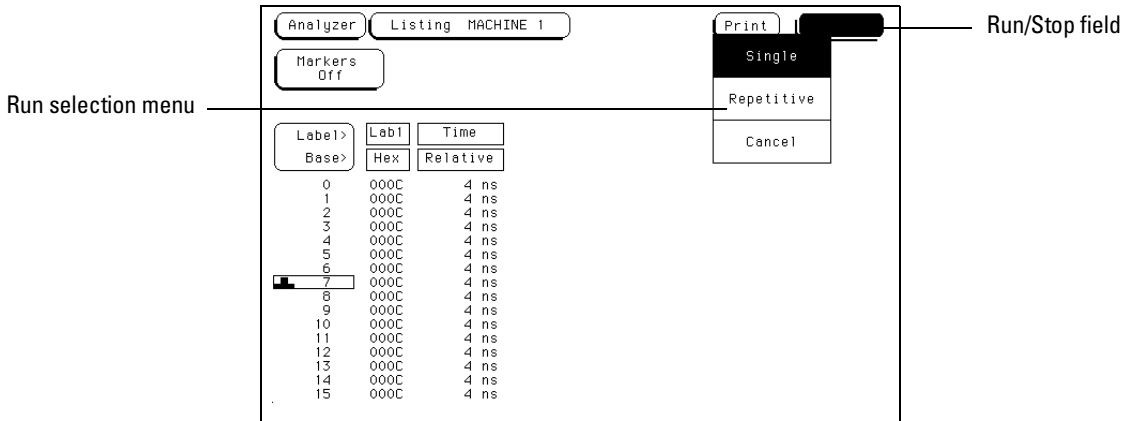

Run/Stop Field

Base Field

The numeric base for displayed data under each label is set by the Base field. All assigned labels will have a Base field assigned to it. If the numeric base is changed in a menu, the base in other menus may not change accordingly. As an example, the base assigned to symbols is unique, as is the base assigned in the Compare and Listing menus, so you would not want them to change.

The base is changed by selecting the Base field under the desired label, then selecting the new base from a pop-up selection list. The base choices are Binary, Octal, Decimal, Hex, ASCII, Symbol and Twos.

Base fields

The screenshot shows a menu interface with a 'Base selection list' open. The list contains the following options: Binary, Octal, Decimal, Hex, ASCII, Symbol, and Twos. The 'ASCII' option is highlighted. The background menu shows a table of data with columns for 'Label', 'Base', and various numerical values. The 'Base' column for label 5 is highlighted.

Label	Base	Hex	Octal	Decim	Twos	Bin
0	0064	000144	00100	+00100	00000000	
1	0065	000145	00101	+00101	00000000	
2	0066	000146	00102	+00102	00000000	
3	0067	000147	00103	+00103	00000000	
4	0068	000150	00104	+00104	00000000	
5	0069	000151	00105	+00105	00000000	
6	006A	000152	00106	+00106	00000000	
7	006B	000153	00107	+00107	00000000	
8	006C	000154	00108	+00108	00000000	
9	006D	000155	00109	+00109	00000000	
10	006E	000156	00110	+00110	00000000	
11	006F	000157	00111	+00111	0000000001101111	<NUL>
12	0070	000160	00112	+00112	0000000001110000	<NUL>
13	0071	000161	00113	+00113	0000000001110001	<NUL>

Base Field

Label Field

New label assignments and existing label name changes are done only in the Format menu. However, you can insert, delete, replace, or interleave labels in other menus where assigned labels appear. When you select a label field, a list of label actions appear.

Insert

The Insert option accesses a selection list of assigned labels. The label selected from this list is inserted to the right of the label used to start the label action.

Replace

The Replace option accesses a selection list of assigned labels. The label selected from this list replaces the label used to start the label action.

Delete

The Delete option deletes the label used to start the label action. The label is not deleted from the Format menu.

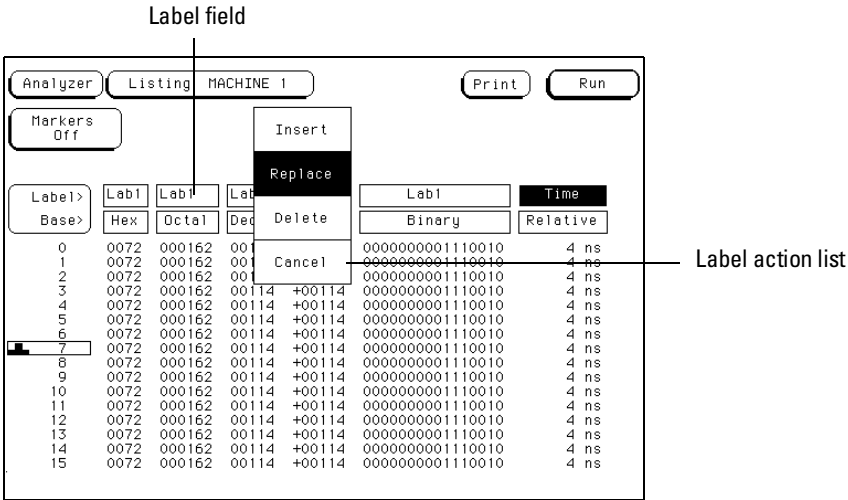

Label Field

The Common Menu Fields

Label Field

Interleave

With two state analyzers configured, and the Count fields in the respective Trigger menus set to Time, the Interleave option becomes available. The Interleave option allows you to interleave two labels and their data from the two different analyzers in the same column.

The interleaved label is placed directly above the selected label and all interleaved data is displayed in white. In addition, the state numbers of the interleaved data are indented to the right.

The list of available labels to interleave becomes available when the Interleave option is selected from the label action list shown on the previous page.

Interleaved label

Analyzer Listing MACHINE 1 [Cancel] [Run]

Markers Off

Lab1

Label>	Lab1	Lab1	Lab1	Lab1	Lab1	Time
Base>	ASCII	Octal	Decim	Twos	ASCII	Relative
0	<NUL> 3	000175	00125	+00125	<NUL> 3	
1	<NUL> ~	000176	00126	+00126	<NUL> ~	96 ns
2	<NUL> 𐀀	000177	00127	+00127	<NUL> 𐀀	104 ns
3	<NUL><NUL>	000000	00000	+00000	<NUL><NUL>	96 ns
4	<NUL><SDH>	000001	00001	+00001	<NUL><SDH>	104 ns
5	<NUL><STX>	000002	00002	+00002	<NUL><STX>	96 ns
6	<NUL><ETX>	000003	00003	+00003	<NUL><ETX>	104 ns
7	<NUL><EDT>	000004	00004	+00004	<NUL><EDT>	96 ns
8	<NUL><ENG>	000005	00005	+00005	<NUL><ENG>	104 ns
9	<NUL><ACK>	000006	00006	+00006	<NUL><ACK>	96 ns
10	<NUL><BEL>	000007	00007	+00007	<NUL><BEL>	104 ns
11	<NUL><BS >	000010	00008	+00008	<NUL><BS >	96 ns
12	<NUL><HT >	000011	00009	+00009	<NUL><HT >	104 ns
13	<NUL><LF >	000012	00010	+00010	<NUL><LF >	96 ns
14	<NUL><VT >	000013	00011	+00011	<NUL><VT >	104 ns
15	<NUL><FF >	000014	00012	+00012	<NUL><FF >	96 ns

Interleave Option

Label / Base Roll Field

When the number of assigned labels becomes greater than the total number of labels that can be displayed on screen, the analyzer will store them off screen. If there are offscreen labels, the Label/Base roll field turns dark.

To roll label and base fields onto the screen, activate the roll function by selecting the dark Label/Base roll field. When the Label/Base roll field is selected, it turns light and the roll indicator appears in the field as shown. Once the roll indicator appears, rolling is then done by turning the knob.

If there is more than one rollable field, the roll indicator remains with the last rollable field activated. For example, the Listing menu shown below has both the Label/Base field and the state location field, which are both rollable. However, the only field that rolls when turning the knob is the field with the roll indicator.

The Page keys roll data one screen at a time. The data type and direction is determined by which page key is pressed. Rolling data with the Page key works independent of the knob rolling function.

Analyzer Listing MACHINE 1 [Cancel] [Run]

Markers Off

Label >	Base >	ASCII	Octal	Decim	Twos	ASCII	Time
0	<NUL> 3		000175	00125	+00125	<NUL> 3	
1	<NUL> ~		000176	00126	+00126	<NUL> ~	96 ns
2	<NUL> █		000177	00127	+00127	<NUL> █	104 ns
3	<NUL><NUL>		000000	00000	+00000	<NUL><NUL>	96 ns
4	<NUL><SDH>		000001	00001	+00001	<NUL><SDH>	104 ns
5	<NUL><STX>		000002	00002	+00002	<NUL><STX>	96 ns
6	<NUL><ETX>		000003	00003	+00003	<NUL><ETX>	104 ns
7	<NUL><EDT>		000004	00004	+00004	<NUL><EDT>	96 ns
8	<NUL><END>		000005	00005	+00005	<NUL><END>	104 ns
9	<NUL><ACK>		000006	00006	+00006	<NUL><ACK>	96 ns
10	<NUL><BEL>		000007	00007	+00007	<NUL><BEL>	104 ns
11	<NUL><BS >		000010	00008	+00008	<NUL><BS >	96 ns
12	<NUL><HT >		000011	00009	+00009	<NUL><HT >	104 ns
13	<NUL><LF >		000012	00010	+00010	<NUL><LF >	96 ns
14	<NUL><VT >		000013	00011	+00011	<NUL><VT >	104 ns
15	<NUL><FF >		000014	00012	+00012	<NUL><FF >	96 ns

Label and base field

State location field with roll indicator

Label and Base Roll Field





The Configuration Menu

The Configuration Menu

The Configuration menu is one of the analyzer menus that allows you to set analyzer level parameters. For example, in the Configuration menu the pod pair assignments are made. In addition, the type of clocking is selected and a custom analyzer name can be assigned.

Configuration Menu Map

The following menu map illustrates all fields and the available options in the Configuration menu. The menu map will help you get an overview as well as provide you with a quick reference of what the Configuration menu contains.

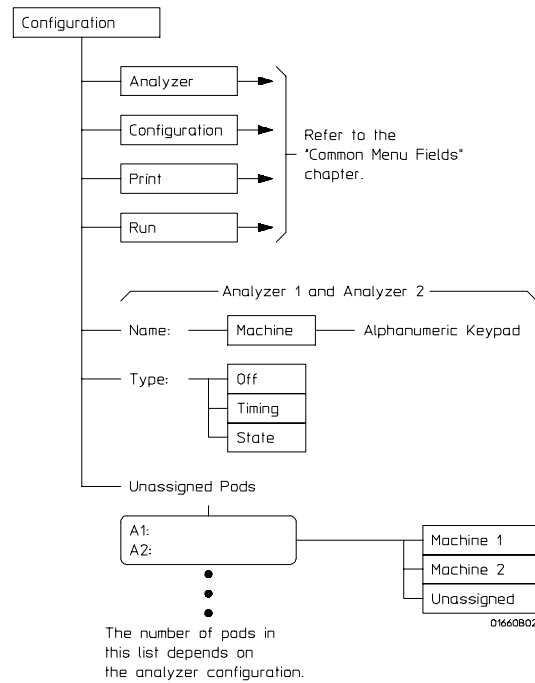

Configuration Menu Map

Name Field

The Name field allows you to assign a specific name to the analyzer. The name is entered by using the front-panel alpha keypad or the optional keyboard. Simply highlight the Name field and type the new name. When configurations are stored to disk and later reloaded, a specific name can help identify the measurement setup.

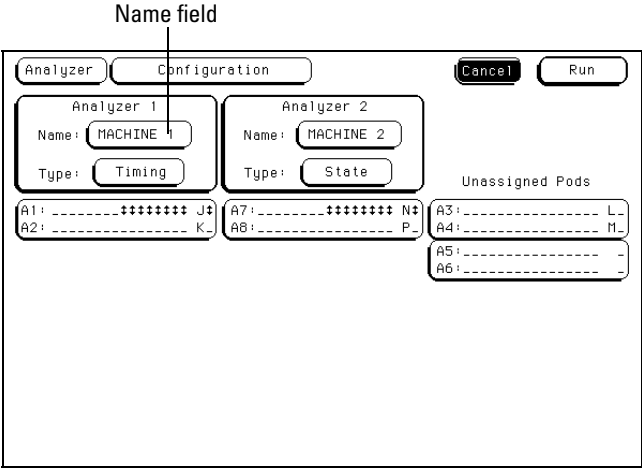

Name Field

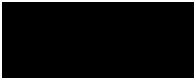

Type Field

The Type field allows you to configure the logic analyzer with either an external clock or an internal clock. When the Type field is selected, the following choices are available.

Timing

When Timing is selected, the analyzer uses its own internal clock to clock measurement data into the acquisition memory. This clock is asynchronous to the signals in the target system. When this option is selected, some fields specific to external clocks will not appear in the analyzer menus.

The analyzer can only be configured with one timing analyzer. If two are selected, the first will be turned off.

State

When State is selected, the analyzer uses a clock from the system under test to clock measurement data into acquisition memory. This clock is synchronous to the signals in the target system.

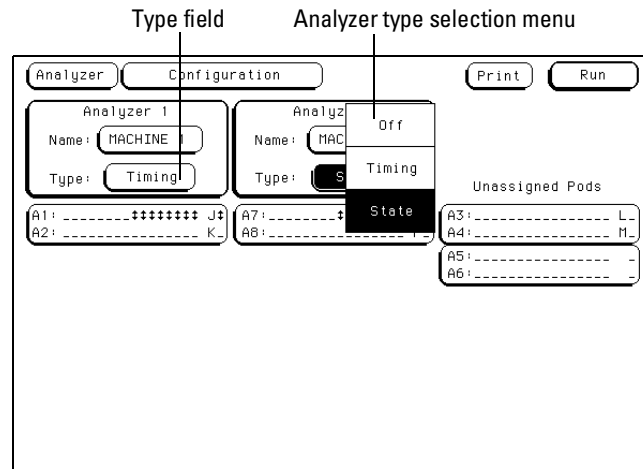

Type Field

Unassigned Pods List

The list of Unassigned Pods in the Configuration menu shows the available pods for the analyzer configuration. Pod grouping and assignment is by pod pairs. When a pod pair is selected from the Unassigned Pods list, an assignment menu appears. From the assignment menu, select a destination for the pod pair.

Within each pod pair, activity indicators show the integrity of the connected signals.

See Also "Activity Indicators" in this chapter.

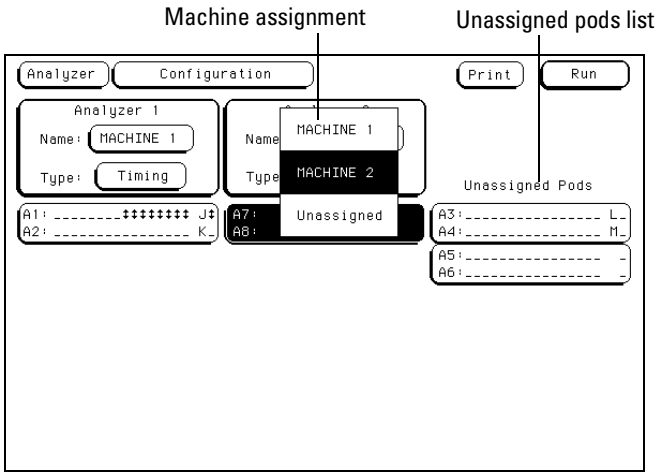

Unassigned Pods Display

The Configuration Menu

Unassigned Pods List

Illegal Configuration

When both analyzers are turned on, the first pod pair 1,2 and the last pod pair (5,6 in the 96 channel model or 7,8 in the 128 channel model) cannot be assigned to the same analyzer machine. If this configuration is set, the analyzer will display a reassignment menu. Use this reassignment menu to configure the pod assignment automatically to a legal configuration.

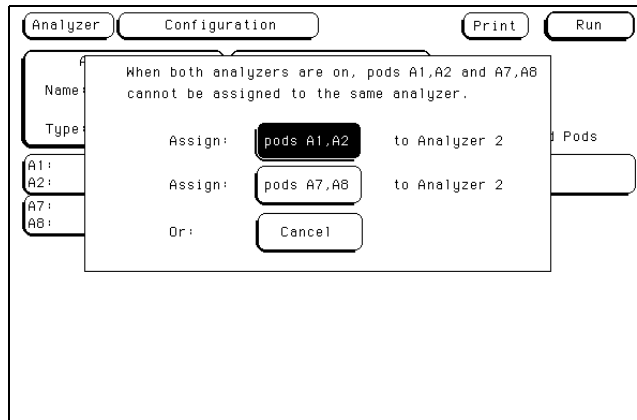

Configuration Reassignment Menu

Activity Indicators

A portion of the Configuration menu that is not a selectable field is the Activity Indicators. The indicators appear in two places. One is in the pod pair displays of this Configuration menu. The other place is in the bit reference line in the Format menu just above the pod bit numbers.

When the logic analyzer is properly connected to an active target system, you will see a high-level dash, a low-level dash, or a transitioning arrow in the Activity Indicator displays for each pod pair. These indicators are very useful in showing proper probe connection and that the logic levels are as expected according to the threshold level setting.

See Also "Bit Assignment Field" in the Format menu chapter for more information on the activity indicators in the Format menu.

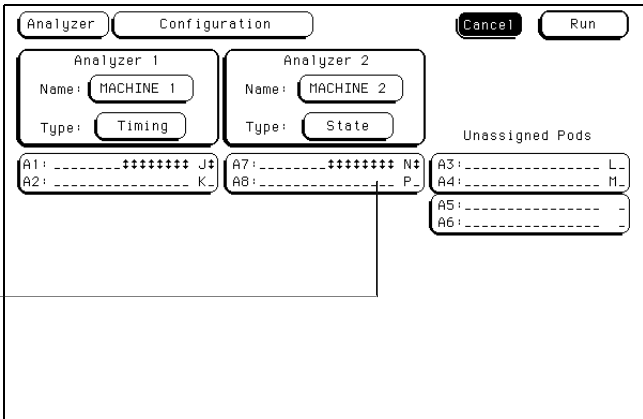

Activity Indicators

System / Analyzer Field

The function of the System/Analyzer field is the same in all menus. For a complete definition of the System/Analyzer field, go to "The Common Menu Fields" chapter at the beginning of the Analyzer part of this User's Reference.

Menu Field

The function of the Menu field is the same in all menus. For a complete definition of the Menu field, go to "The Common Menu Fields" chapter at the beginning of the Analyzer part of this User's Reference.

Print Field

The function of the Print field is the same in all menus. For a complete definition of the Print field, go to "The Common Menu Fields" chapter at the beginning of the Analyzer part of this User's Reference.

Run Field

The function of the Run field is the same in all menus. For a complete definition of the Run field, go to "The Common Menu Fields" chapter.

Common Menu Fields

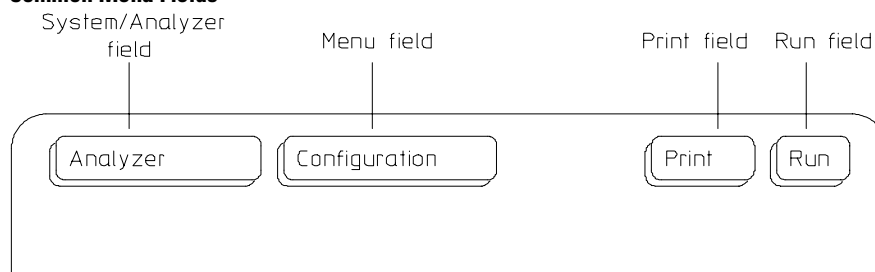

01660b13



The Format Menu

The Format Menu

The Format menu is where you assign which data channels are measured and what acquisition mode is used to capture valid data.

The configuration of the Format menu consists of grouping and labeling the data channels from the system under test to fit your particular measurement. For your convenience in recognizing bit groupings, you can specify symbols to represent them.

If the analyzer is configured as a State analyzer, there are master and slave clocks, clock qualifiers and a variable clock setup and hold to further qualify what data is captured.

Format Menu Map

The following menu map graphically illustrates all fields in the Format menu. Use the menu map as an overview and as a quick reference to the available options in the Format menu.



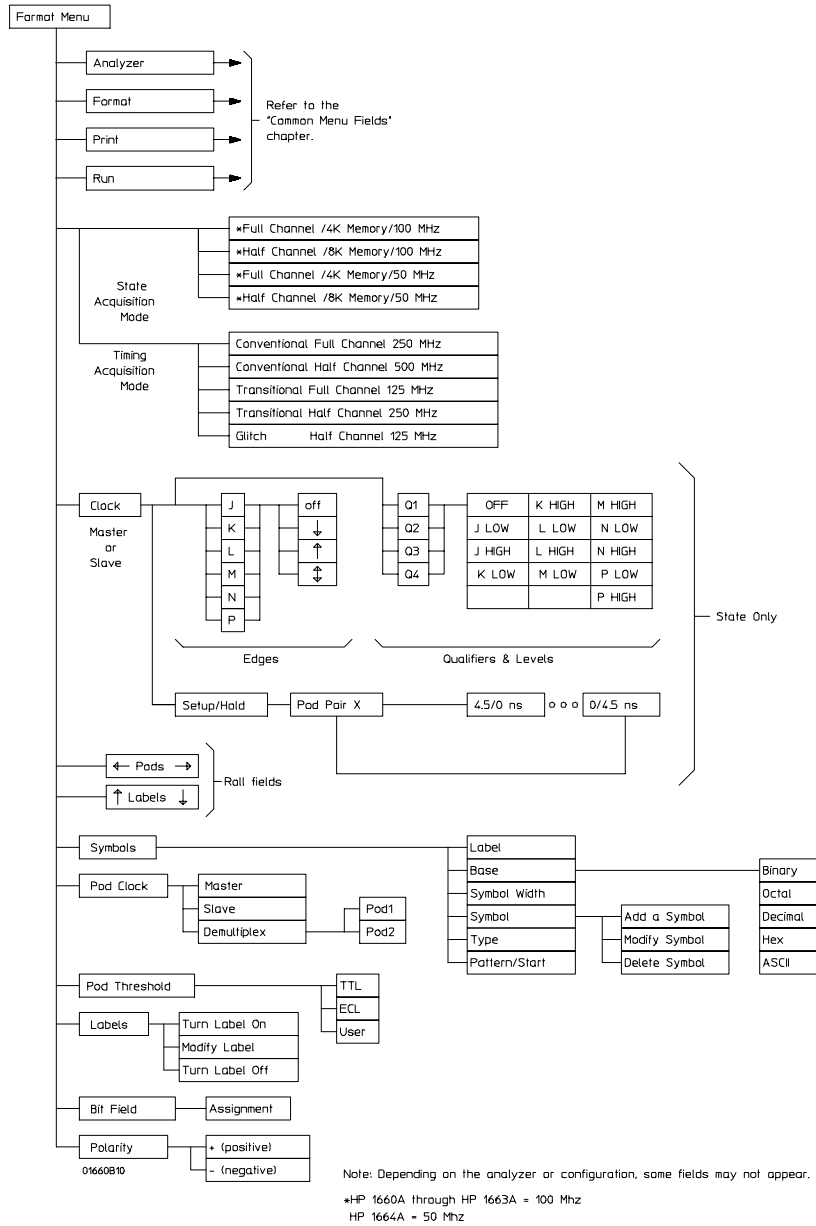

Format Menu Map

State Acquisition Mode Field (State only)

The State Acquisition Mode field identifies the channel width and memory depth of the selected acquisition mode. When the State Acquisition Mode field is selected, two configurations of channel width/memory depth become available. Use the State Acquisition Mode to configure the analyzer for the best use of available memory and channel width.

Full Channel 4K Memory 100 MHz/50 MHz

The Full Channel selection uses both pods in a pod pair for 34 channels of width and a total memory depth of 4 Kbytes per channel. If time or state tags are turned on, the total memory is evenly split between data acquisition storage and time or state tag storage. To maintain the full 4 Kbytes per channel depth, leave one pod pair unassigned. The maximum state clock speed is 100 MHz (1660A through 1663A) or 50 MHz (1664A).

Half Channel 8K Memory 100 MHz/50 MHz

The Half Channel selection cuts the channel width to 17 channels. In this mode, the pod used within the pod pair is selected through the Pod field. In Half Channel mode, the memory depth is increased to 8 Kbytes per channel. Time or state tags are not available in this mode. The maximum state clock speed is 100 MHz (1660A through 1663A) or 50 MHz (1664A).

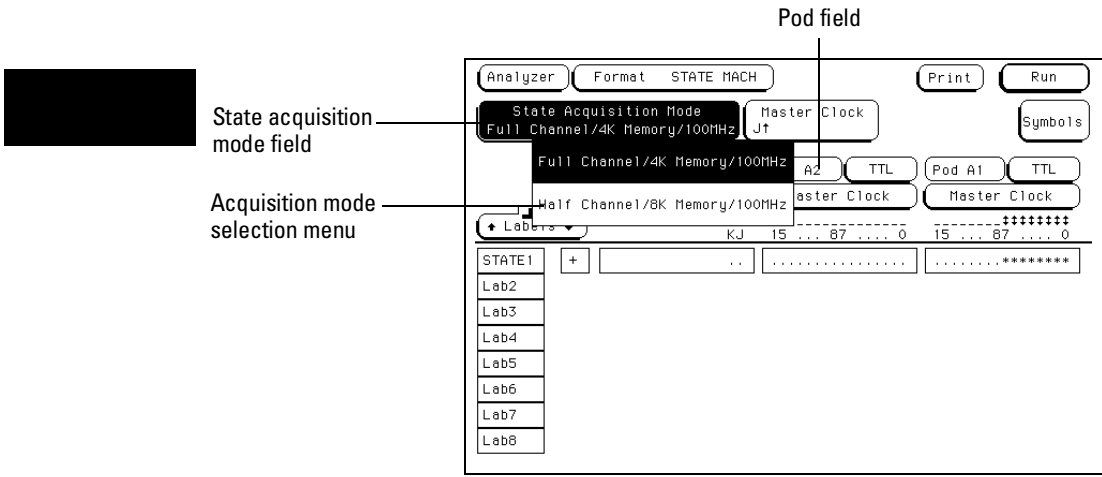

State Acquisition Mode Field

Timing Acquisition Mode Field (Timing only)

The Timing Acquisition Mode field displays the acquisition type, the channel width, and sampling speed of the present acquisition mode. The Timing Acquisition Mode field is used to access an acquisition mode selection menu.

Conventional Acquisition Mode

In Conventional Acquisition Mode the analyzer stores measurement data at each sampling interval.

Conventional Full Channel 250 MHz The total memory depth is 4 Kbytes with data being sampled and stored as often as 4 ns.

Conventional Half Channel 500 MHz The total memory depth is 8 Kbytes with data being sampled and stored as often as 2 ns.

Glitch Acquisition Mode

In Glitch Acquisition Mode, a glitch is defined as a pulse with a minimum width of 3.5 ns and a maximum width of 8 ns, or the sample period, whichever is larger. As an example, if the sample period is 8 ns, then a glitch is defined as being between 3.5 ns and 8 ns. One advantage of the glitch mode is that if you expand the sample rate, a pulse that is less than the sample rate will still be displayed as a vertical dashed line.

Glitch Half Channel 125 MHz The total memory depth is split between data storage and glitch storage. Data acquisition memory depth is 2048 per channel. Glitch storage is 2 Kbytes per channel. Data is sampled for new transitions every 8 ns.

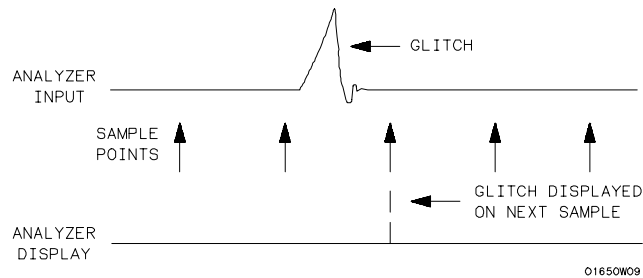

Glitch in a Timing Waveform

Transitional Acquisition Mode

In Transitional acquisition mode, the timing analyzer samples data at regular intervals, but only stores data when there is a level transition on currently assigned bits of a pod pair. Each time a level transition occurs on any of the bits, all bits of the pod pair are stored. A time tag is stored with each stored data sample so the measurement can be reconstructed and displayed later.

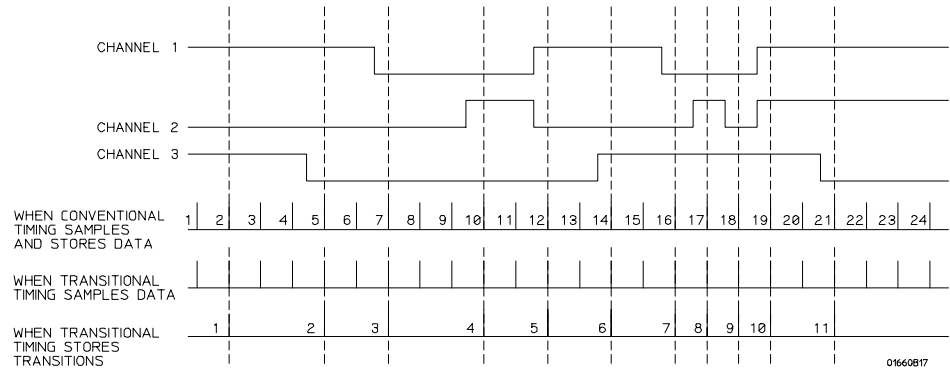

Conventional and Transitional Comparison

One issue when using transitional timing is how many transitions can be stored. The number depends on the mode and frequency of transition occurrence. The following overview explains the number of transitions stored for each transitional timing mode and why.

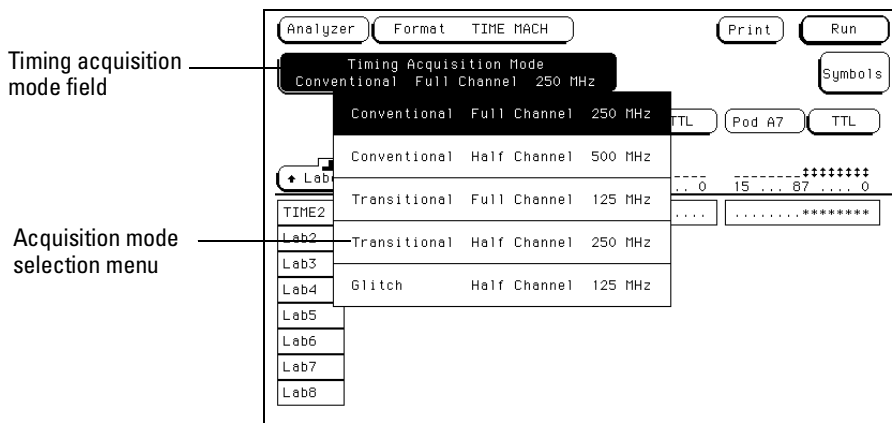

Timing Acquisition Mode Selection

Transitional Full Channel 125 MHz Mode

The total memory depth is 4 Kbytes per channel with a channel width of 34 channels per pod pair. Data is sampled for new transitions every 8 ns.

When the Timing analyzer runs in the 125 MHz mode, it operates very similar to the State analyzer with count Time turned on. The only exceptions are that the store qualification comes from transition detectors instead of the sequencer. Also, the analyzer uses an internal clock.

With 4 Kbytes of memory per channel and count Time turned on, the analyzer uses half its memory (2 Kbytes) to store time tags. It should be noted that each pod pair must store transitions at its own rate, therefore it must store its own set of time-tags. You do not have the option of using a free pod to retain full memory as you have in the normal state mode.

When a transition is detected after a sample with no detected transition, two samples are stored. One sample is a "before transition sample" and the other is an "after transition sample." Then, as long as there are transitions in the subsequent sample, only 1 sample is stored. When the next sample occurs without a transition, the two stored sample sequence (one before, one after) repeats with the next detected transition.

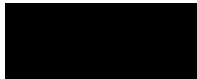

The Format Menu Timing Acquisition Mode Field (Timing only)

Minimum Transitions Stored Normally, transitions occur at a relatively slow rate. A rate slow enough to insure at least one sample with no transitions between the samples with transitions. This is illustrated below with time-tags 2, 5, 7, and 14. When transitions happen at this rate, two cycles are stored for every transition. This means that with 2 Kbytes of memory, 1 Kbytes of transitions are stored. You must subtract 1, which is necessary for a starting point, for a minimum of 1023 stored transitions.

Maximum Transitions Stored If transitions occur at a fast rate, such that there is a transition at each sample point, only one sample is stored for each transition as shown by time-tags 17 through 21 below. If this continues for the entire trace, the number of transitions stored is 2 Kbytes. Again, you must subtract the starting point sample which then yields a maximum of 2047 stored transitions.

In most cases a transitional timing trace is stored by a mixture of the minimum and maximum cases. Therefore, the actual number of transitions stored will be between 1023 and 2047.

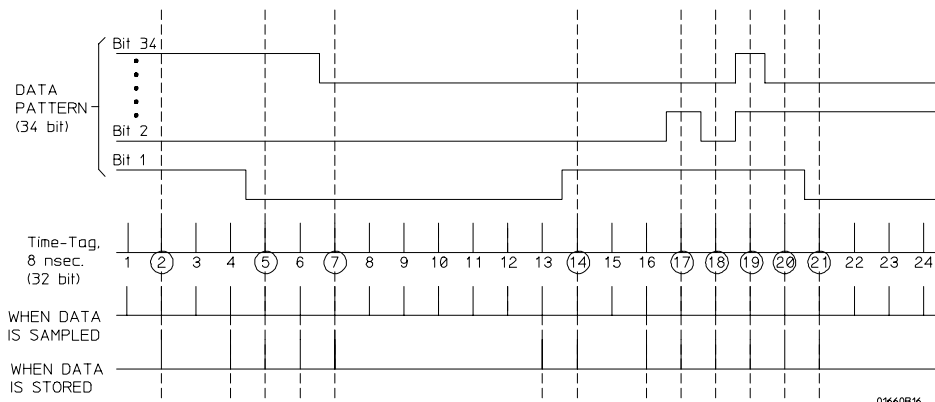

Storing Time-tags and Transitions

Transitional Half Channel 250 MHz Mode

The total memory depth is 8 Kbytes with a channel width of 17 channels on one pod. The pod used within the pod pair is selectable. Data is sampled for new transitions every 4 ns.

Transitional timing running at 250 MHz is the same as the 125 MHz mode, except that two single pod data samples (17 bits x 2 = 34 bits) are stored instead of one full pod pair data sample (34 bits). This is because in half channel mode, data is multiplexed into the sequencer pipeline in two 17 bit samples. The first 17 bit sample is latched, the next 17 bit sample is sent down the pipeline along with the latched 17 bit sample.

This operation keeps the pipeline frequency down to 125 MHz. It should be noted that the transition detector still looks at a full 34 bits. This means it is looking at two samples at a time instead of one. In this mode, between 682 and 4094 transitions are stored.

Minimum Transitions Stored The following example shows what data is stored from a data stream with transitions that occur at a slow rate (more than 24 ns apart).

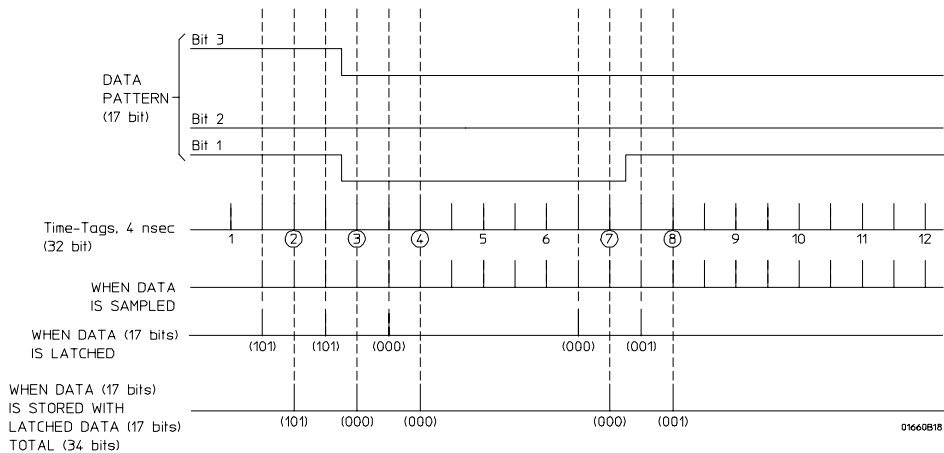

Minimum Transitions Stored

The Format Menu
Timing Acquisition Mode Field (Timing only)

As you can see, transitions are stored in two different ways, depending strictly on chance. Remember that the transition detector only looks at the full 34 bits while the data is stored as two 17 bit samples. So, the transition detector will not see time-tag 3 (101/000) as a transition. However, when it compares it to time-tags 2 (101/101) or 4 (000/000), it sees a difference and detects them as transitions. For this first set of time-tags, the transition detector sees more transitions than are really there. This causes the analyzer to store 6 samples per transition

(three-34 bit sample pairs), instead of just two, like in the 125-MHz mode. If all the transitions will be stored in this way throughout the trace, the minimum number of stored transitions are 682 (4096/6).

However, as you see with time-tags 7 (000/000) and 8 (001/001), transitions can fall between the pairs of samples. When this happens, only one transition is detected and only 4 samples (two sample pairs) are stored. If all transitions will be stored in this way, 1023 (4096/4) transitions are stored.

From run to run, the actual number of transitions stored for transitions that occur at a slower rate will fall between these two numbers, based on the probability of a transition falling between a sample pair or falling within a sample pair.

Maximum Transitions Stored The following example shows the case where the transitions are occurring at a 4 ns rate:

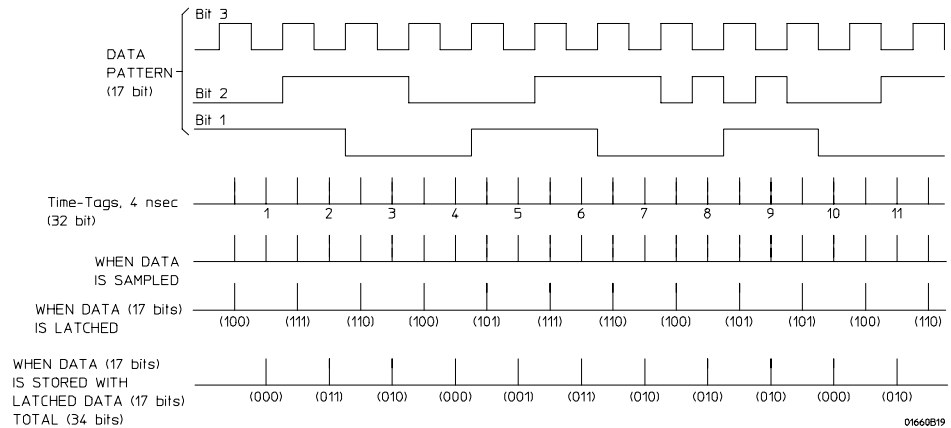

Maximum Transitions Stored

In this case, transitions are being detected with each sample. Therefore, they are all being stored. In addition, each sample pair contains a transition. For example, time tag 1 (100/000) contains a transition and is different from time tag 2 (111/011), which also contains a transition. The difference between the two will trigger the transition detector.

If this were to continue throughout the trace, You would store 4 Kbytes –1 transitions, or 4095. As with the 125-MHz mode, the actual number of transitions stored will fall somewhere between 682 and 4095, depending on the frequency of transitions.

Other Transitional Timing Considerations

Pod Pairs are Independent In single run mode each pod pair runs independently. This means when one pod pair fills its trace buffer it will not shut the others down. Should you have a pod pair with enabled data lines and with no transitions on its lines, you get a message "Storing transitions after trigger for pods nn/nn." In repetitive run mode, a full pod pair waits 2 seconds, then halts all other pod pairs.



Increasing Duration of Storage In the 125-MHz mode a transition on any one of the 34 bits each sample (if they are all turned on) will cause storage. Reducing the number of bits that are turned on for any one pod pair will more than likely increase data storage time.

Separating data lines which contain fast occurring transitions from lines with slow occurring transitions also helps. When doing this, be sure to cross pod pair boundaries. It does not help to move fast lines from pod 1 to pod 2, they must be moved to pod 3, which is a different pod pair.

In the 250 MHz mode a transition on any one of 17 bits (half channel) each sample (if they are all turned on) will cause storage.

Invalid Data The analyzer only looks for transitions on data lines that are turned on. Data lines that are turned off store data, but only when one of the lines that is turned on transitions. If the data line is turned on after a run, you would see data, but it is unlikely that every transition that occurred was captured.

Clock Inputs Display

Beneath the Clock Inputs display, and next to the activity indicators, is a display of all clock inputs available in the present configuration. Depending on the model, the number of available clocks vary. The J and K clocks appears with pod pair 1/2, the L and M with pod pair 3/4, and clocks N and P with pod pairs 7/8 for the 1660 and 5/6 for the 1661. In a model with more than three pod pairs, all other clock lines are displayed to the left of the displayed master clocks, and are used as only data channels.

With the exception of the Range resource, all unused clock bits can be used as data channels. If any clock line is used as a data channel, the bit must be assigned. Activity indicators above the clock identifier show clock or data signal activity.

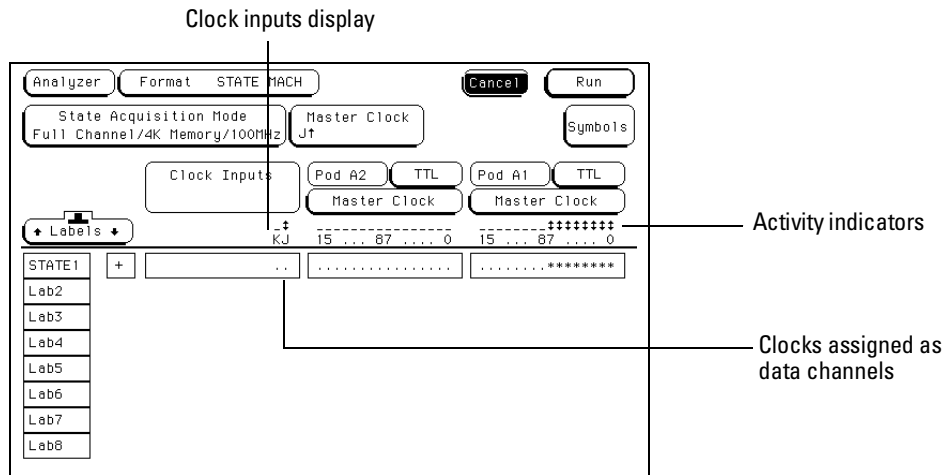

Clock Inputs Display

Pod Field

The Pod field identifies which pod of a pod pair the settings of the bit assignment field, pod threshold field, and pod clock fields effect. In the full channel modes, this field is simply an identifier and is not selectable. However, in the half channel mode, the Pod field turns dark which means it is selectable. It is through the Pod field that you select a pod in the pod pair.

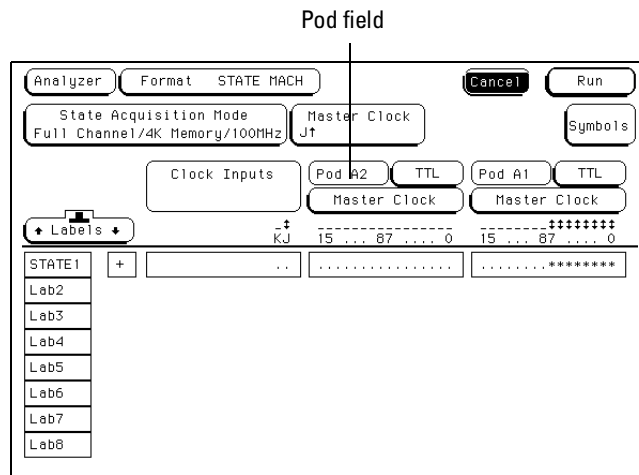

Pod Field

Pod Clock Field (State only)

The Pod Clock field identifies the type of clock arrangement assigned to each pod. When the Pod Clock field is selected, a clock arrangement type menu appears with the choices of Master, Slave, or Demultiplex. Once a pod clock is assigned a clock arrangement, its identity and function follows what is configured in the Master and Slave Clock fields.

The Pod Clock field and the clocking arrangement is only available in a State analyzer.

Master

This option specifies that data on all pods designated "Master Clock," in the same analyzer, are strobed into memory when the status of the clock lines match the clocking arrangement specified under the Master Clock.

See Also

"Master and Slave Clock Field" found later in this chapter for information about configuring a clocking arrangement.

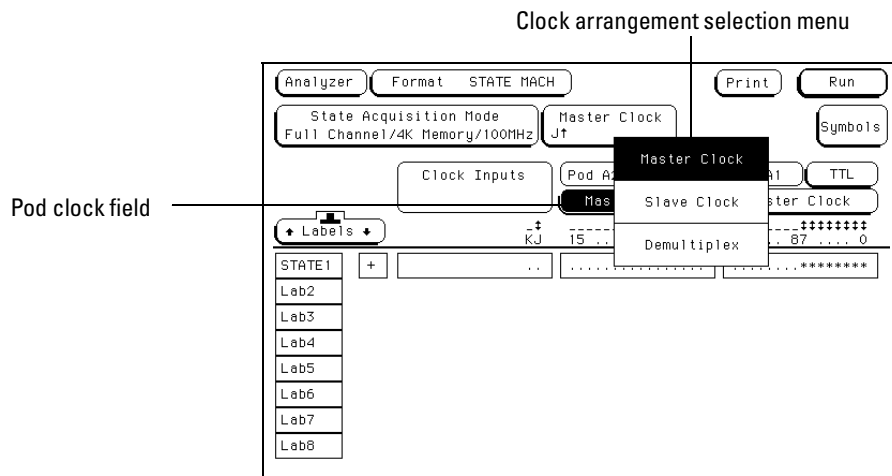

Pod Clock Field

The Format Menu
Pod Clock Field (State only)

Slave

This option specifies that data on a pod designated "Slave Clock" are latched when the status of the slave clock inputs meets the requirements of the slave clocking arrangement. Then, followed by a match of the master clock and the master clock arrangement, the slave data is strobed into analyzer memory along with the master data. See the figure below.

If multiple slave clocks occur between master clocks, only the data latched by the last slave clock prior to the master clock is strobed into analyzer memory.

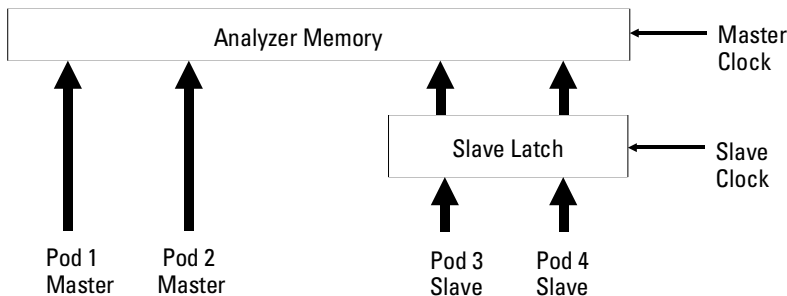

Latching Slave Data

Slave clock arrangement field

Analyzer Format STATE MACH Cancel Run

State Acquisition Mode: Full Channel/4K Memory/100MHz Master Clock: Jt Slave Clock: K4 Symbols

Clock Inputs: Pod A2 TTL Pod A1 TTL

Master Clock Slave Clock

KJ 15 ... 87 ... 0 15 ... 87 ... 0

DATA	+*****
ADDR	+*****
Lab3				
Lab4				
Lab5				
Lab6				
Lab7				
Lab8				

Slave Clock Field

Demultiplex

The Demultiplex mode is used to store two different sets of data that occur at different times on the same channels. In Demultiplex mode, only one pod of the pod pair is used, and that pod is selectable. Both the master and slave clocks are used in the Demultiplex mode. Channels assignments are displayed as Demux Master and Demux Slave. For easy recognition of the two sets of data, it is recommended to assign slave and master data to separate labels.

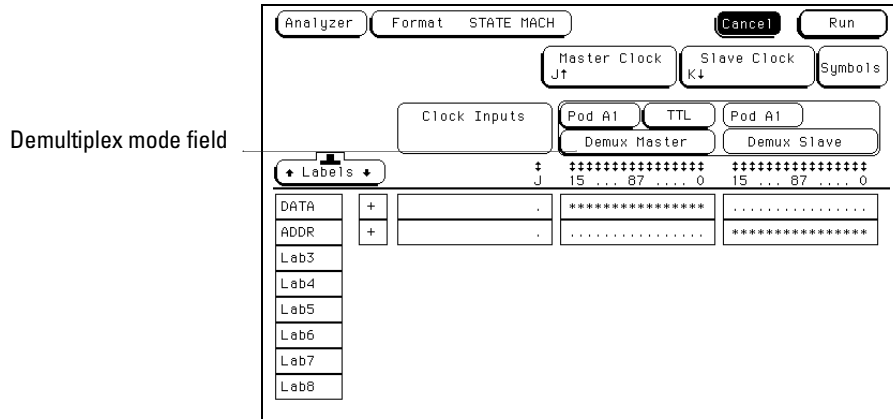

Demultiplex Clocking Mode

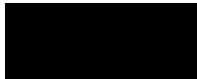

The Format Menu
Pod Clock Field (State only)

When the analyzer sees a match between the slave clock input and the Slave Clock arrangement, Demux Slave data is latched. Then, followed by a match of the master clock and the master clock arrangement, the slave data is strobed into analyzer memory along with the master data. If multiple slave clocks occur between master clocks, only the data latched by the last slave clock prior to the master clock is strobed into analyzer memory.

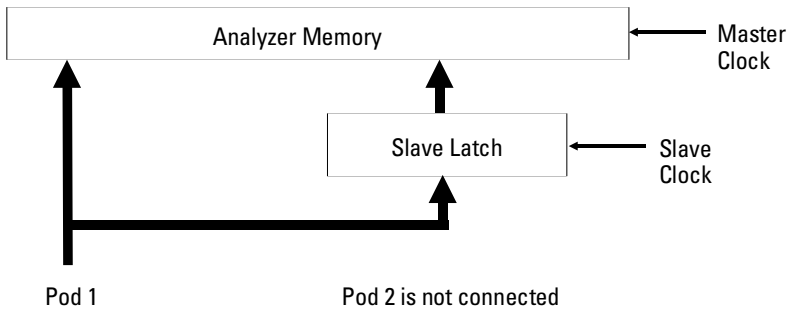

Latching Slave Data In Demultiplex Mode



Pod Threshold Field

The pod threshold field is used to set a voltage level that the data must reach before the analyzer recognizes and displays it as a change in logic levels. You specify a threshold level for each pod in a pod pair. The level specified for each pod is also assigned to the pod's clock threshold.

When the Pod Threshold field is selected, a threshold selection pop-up appears with the following choices:

TTL

When TTL is selected as the threshold level, the data signals must reach +1.5 volts.

ECL

When ECL is selected as the threshold level, the data signals must reach -1.3 volts.



The Format Menu

Pod Threshold Field

User

When USER is selected as the threshold level, the data signals must reach a user selectable value. The range of this value is between -6.0 volts to +6.0 volts.

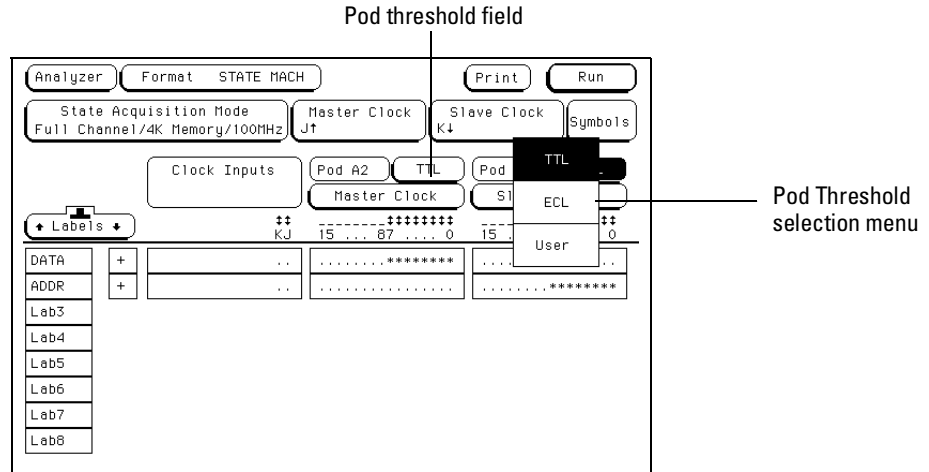

Pod Threshold Field

Master and Slave Clock Field (State only)

The Master and Slave Clock fields are used to construct a clocking arrangement. A clocking arrangement is the assignment of appropriate clocks, clock edges, and clock qualifier levels which allow the analyzer to synchronize itself on valid data.

Clock Selections

When the Master or Slave Clock field is selected, a clock/qualifier selection menu appears showing the available clocks and qualifiers for a clocking arrangement. Depending on the model, there are up to six clocks available (J through P), and up to four clock qualifiers available (Q1 through Q4).

Each pod cable has one clock line. At least one clock edge must be assigned in one of the configured pods. The remaining unassigned clocks can be used as data channels.

See Also

"Pod Clock Field" found earlier in this chapter for information on selecting clocking arrangement types, such as Master, Slave, or Demultiplex.

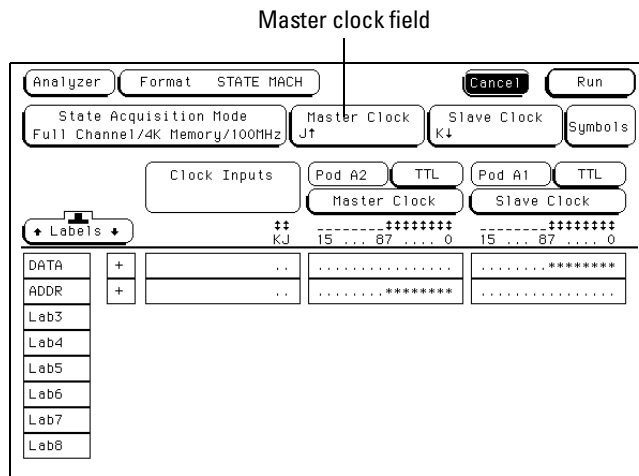

Master Clock Field

The Format Menu Master and Slave Clock Field (State only)

Clock edges are ORed to clock edges, clock qualifier are ANDED to clock edges, and clock qualifiers can be either ANDED or ORed together. All clock and qualifier combinations on the left side of the graphic line are ORed to all combinations on the right side of the line. For example, in a six-clock model, all combinations of the J, K, and L clock with Q1 and Q2 qualifiers, are ORed to the clock combinations of the M, N, and P clocks with Q3 and Q4 qualifiers. The clock threshold level is the same as the level assigned in the Pod Threshold field.

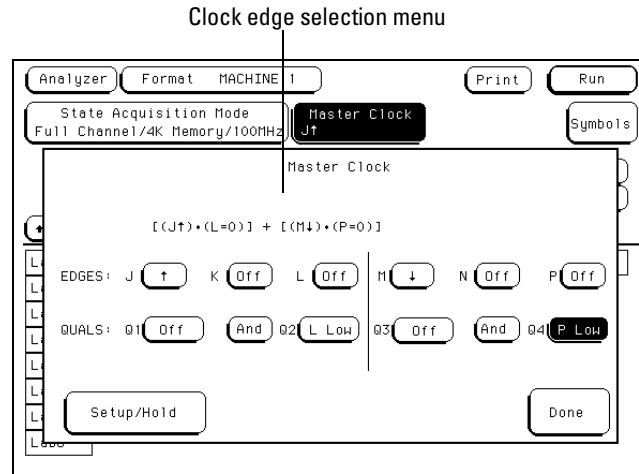

Clock Edges and Levels

Setup/Hold Field (State only)

Setup/Hold adjusts the relative position of the clock edge with respect to the time period that data is valid. When the Setup/Hold field is selected, a configuration menu appears. Use this Setup/Hold configuration menu to select each pod in the analyzer and assign a Setup/Hold selection from the selection list.

With a single clock edge assigned, the choices range from 3.5-ns Setup/0.0-ns Hold to 0.0-ns Setup/3.5-ns Hold. With both edges of a single clock assigned, the choices are from 4.0-ns Setup/0.0-ns Hold to 0.0-ns Setup/4.0-ns Hold. If the analyzer has multiple clock edges assigned, the choices range from 4.5-ns Setup/0.0-ns Hold to 0.0-ns Setup/4.5-ns Hold.

Setup and hold menu

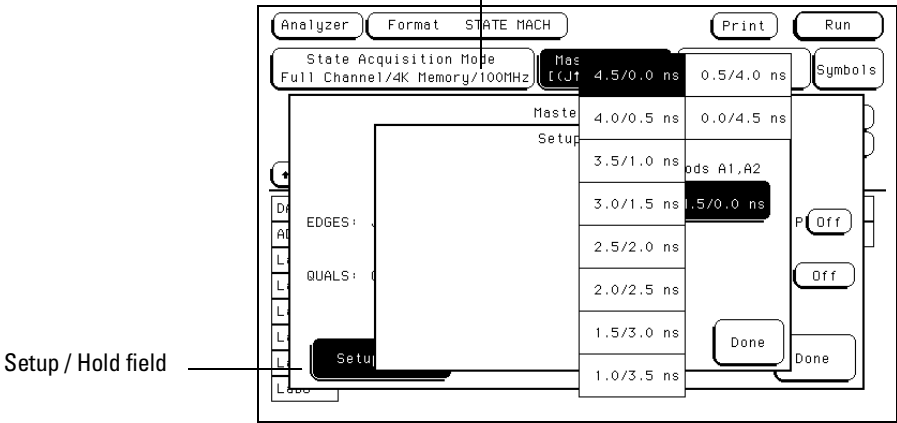

Setup and Hold Menu

The Format Menu Setup/Hold Field (State only)

The relationship of the clock signal and valid data under the default setup and hold is shown in the figure below.

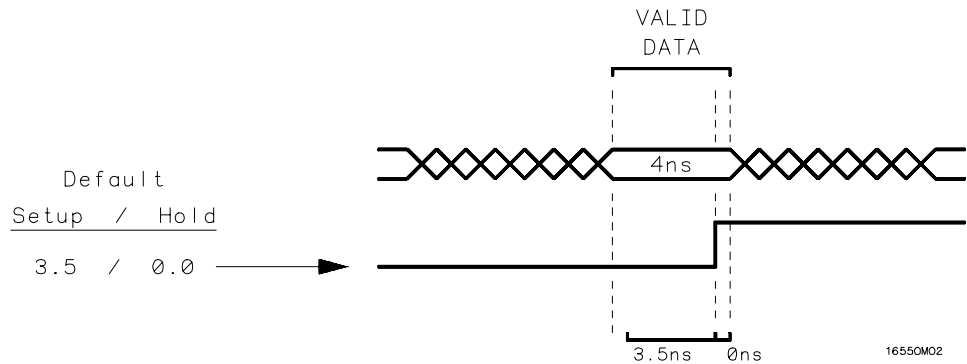

Default Setup and Hold

If the relationship of the clock signal and valid data is such that the data is valid for 1 ns before the clock occurs and 3 ns after the clock occurs, you will want to use the 1.0 setup and 2.5 hold setting.

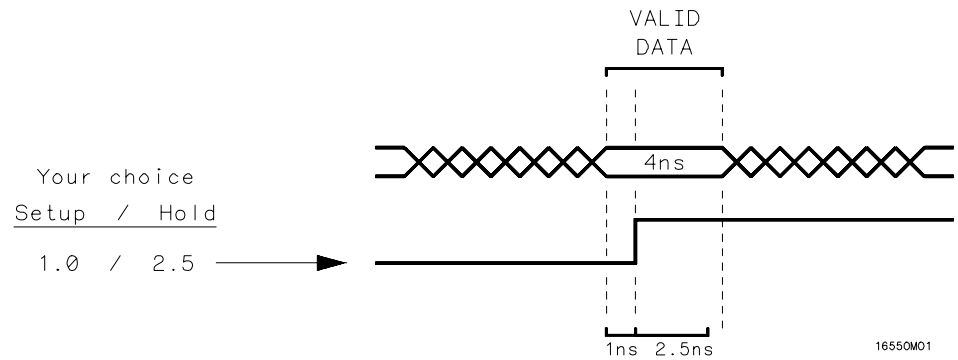

Clock Position in Valid Data

Symbols Field

The Symbols field is located directly below the Run field in the upper right corner of the Format menu. This field is used to access the symbol tables. The symbol tables are used to define a mnemonic for a specific bit pattern of a label. You can specify up to 1000 total symbols, and use them freely between available analyzers. When measurements are made, the mnemonic is displayed where the bit pattern occurs using the selected symbol base.

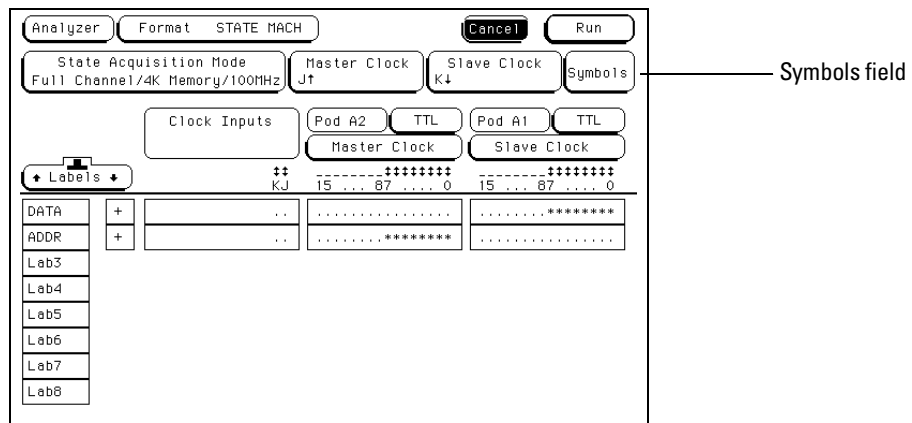

Symbol Field



The Format Menu

Symbols Field

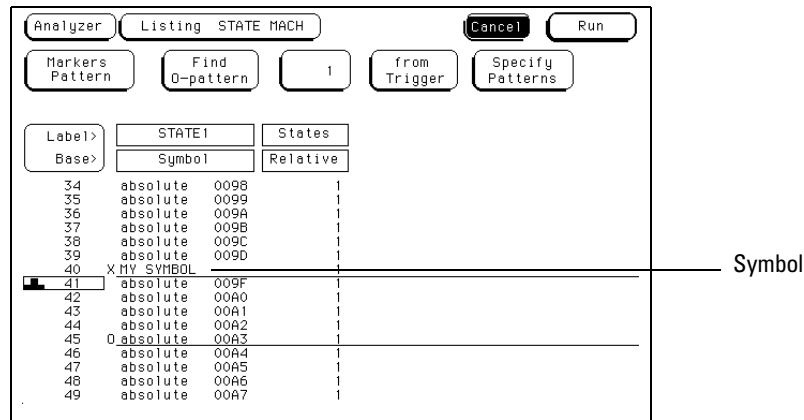

Symbol Located in the Data

Label Field

The Label field identifies the label for which you are specifying symbols. When you select this field, a selection menu appears that lists all the labels turned on for that analyzer. Each label has a separate symbol table, so you can give the same name to symbols defined under different labels. From the label selection menu, select the label for which you wish to specify symbols.

Base Field

The Base field is used to select the numeric base in which the pattern in the symbols menu is displayed. If more than 20 channels are assigned to a label, the Binary option is not offered. As a result, when a symbol is specified as a range, there is only enough room for 20 bits to be displayed on the screen. Decide which base you want to work in and choose that option from the numeric Base pop-up menu.

If you choose the ASCII option, you can see what ASCII characters the patterns and ranges defined by your symbols represent. ASCII characters represented by the decimal numbers 0 to 127 (hex 00 to 7F) are offered on your logic analyzer.

You cannot specify a pattern or range when the base is ASCII. Define the pattern or range in one of the other bases, then switch to ASCII to see the ASCII characters.

Symbol Width Field

The Symbol Width field is used to specify how many characters of the symbol name will be displayed when the symbol is referenced in the Trigger, Waveform, and Listing menus.

To change the Symbol Width, simply highlight the field and turn the knob to set the number of characters in the symbol. You can set the logic analyzer to display from 1 to 16 of the characters in the symbol name.

Symbol Name Field

When you first access the symbol table, there are no symbols specified. The symbol name field reads "New symbol." When this field is selected, a cursor appears and you can then type a symbol name up to a maximum of 16 characters. Press the Done key when you are finished.

When you select Done, a symbol Type field becomes active. The symbol Type field is used to define the symbol type as either a pattern or a range. When you select this field, it toggles between pattern and range.

Pattern Type Field

When the symbol is defined as a pattern, a Pattern/Start field appears to the right of the Type field. Use this field to specify what the pattern is. To assign a pattern, highlight the Pattern/Start field and type in the desired pattern.

Range Type Field

If the symbol is defined as a range, a Pattern/Start field and a Stop field appears. Use these fields to specify the upper and lower boundaries of the range.

To assign pattern values to the boundaries, highlight the fields and type in the pattern with the front-panel keypad. You can specify ranges that overlap or are nested within each other.

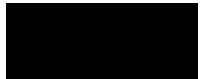

The Format Menu

Symbols Field

To add, delete, or modify symbols in the symbol table, select a symbol name and use one of the following options from the pop-up selection list:

Modify Symbol

If you select this option, a cursor appears under the first letter of the symbol name. Make any changes desired, then press the Done key.

Add a Symbol

When you select this option, a cursor appears in a blank name field. Type in the new name, then press the Done key. The new symbol name appears directly below the old name in the symbol table.

Delete Symbol

If you select this option, the highlighted symbol will be deleted from the symbol table.

When you have specified all your symbols, you can leave the symbol table menu by pressing the Done key.

Modify symbol selection menu

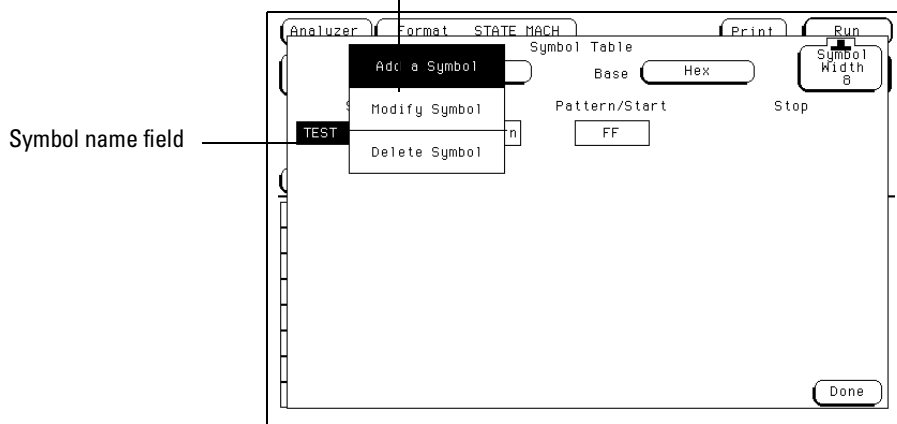

Modify Symbol Selection Menu

Label and Pod Rolling Fields

The Label and Pod rolling fields allow you to view offscreen labels and pods. To view offscreen labels, select the Labels roll field to place the roll indicator into the field, then rotate the knob. The labels scroll up and down.

The Pods rolling field allows you to view offscreen pods. To view offscreen pods, select the Pods roll field to place the roll indicator in the field, then rotate the knob. Pods are positioned with the lowest numbered pod on the right.

See Also

The rolling function is the same for all items that are stored offscreen. For more information on similar fields, refer to "Label/Base Roll Field" in the Common Menu Fields chapter.

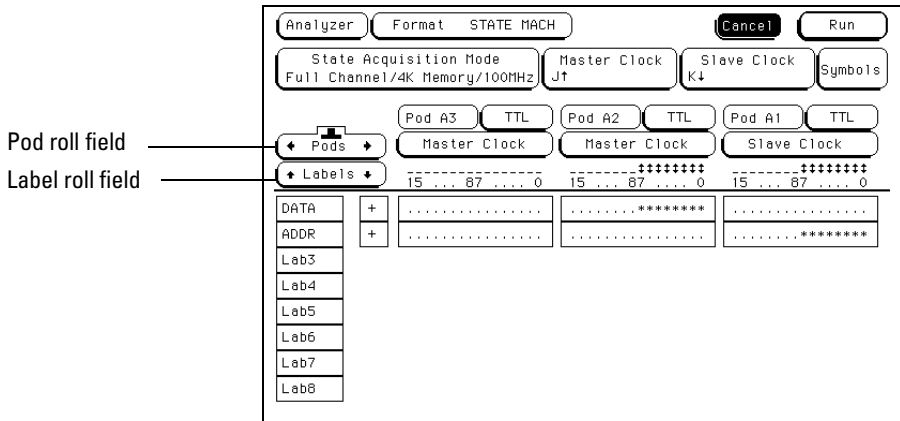

Pod and Label Rolling Fields

Label Assignment Fields

The label assignment fields display the user-defined label names. Custom label names are used when there are different types of data which must be tracked.

The label column contains 126 label fields that you can define. The analyzer displays only 8 labels at any time.

The default label names are Lab1 through Lab126. However, the names can be modified to any six character string by highlighting the field, then typing in the new name. In addition, when any label field is selected, a pop-up menu appears which is used to modify the label list.

See Also

"Label and Pod Rolling Fields" found earlier in this chapter for information on rolling offscreen labels back onscreen.

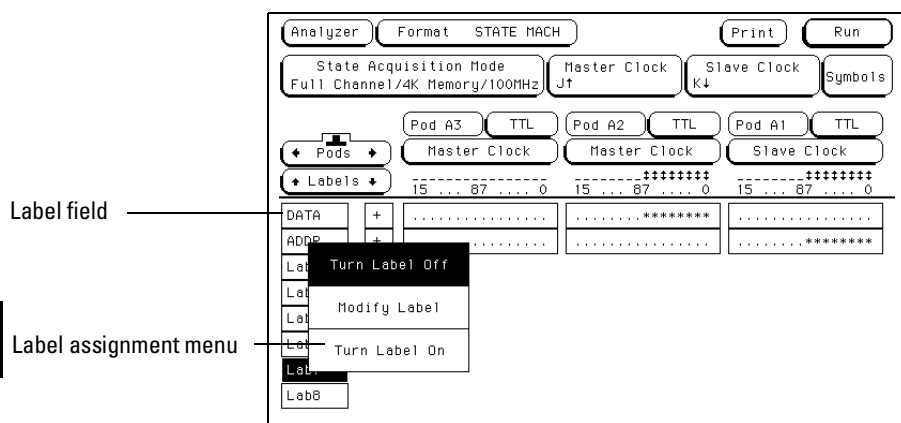

Label Field

Turn Label Off

The Turn Label Off option turns off the label. When a label is turned off, the label name and the bit assignments are saved by the logic analyzer. This gives you the option of turning the label back on and still having the bit assignments and name if you need them. With labels off, the label names remain displayed for identification and searching purposes. With labels off, memory can be saved if in transitional timing.

Modify Label

If you want to change the name of a label, or want to turn on a label and give it a specific name, you would select the Modify label option. When selected, a cursor appears under the first letter. Type in the new name, then press the Done key. Label names can contain up to six characters.

Turn Label On

The Turn Label On selection is used to activate a label and its accompanying bit assignment field. If a custom name is defined for the label, the name remains with the label. If a custom name is not assigned, the default name remain with the label. In addition, if no channels are turned on in the bit assignment fields, the label is turned off when the Format menu is exited.

See Also

For information on how the Label Field modification works in other menus, refer to "Label Field" in the Common Menu Fields chapter.



Label Polarity Fields

The Label Polarity fields are used to assign a polarity to each label. The default polarity for all labels is positive (+). You change the label polarity by selecting the polarity field, which toggles the polarity between positive (+) and negative (-).

When the polarity is inverted, all data as well as bit pattern specific configurations used for identifying, triggering, or storing data reflect the change of polarity.

In a timing analyzer with the data inverted, the waveform display remains positive true.

Polarity field

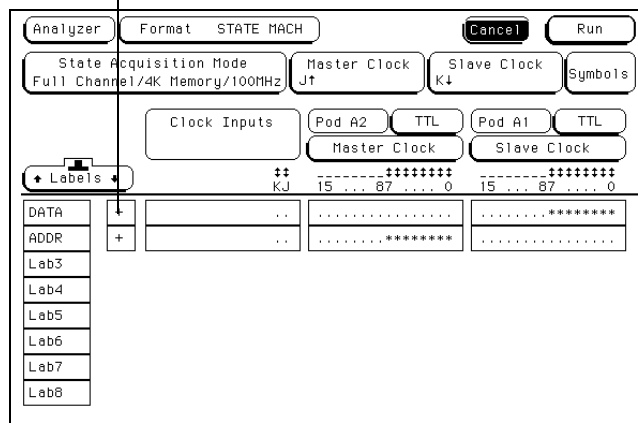

Polarity Field

Bit Assignment Fields

The bit assignment fields are used to assign physical channels to labels. The convention for bit assignment is as follows:

- * (asterisk) indicates an assigned bit.
- . (period) indicates an unassigned bit.

To change a bit assignment, select the bit assignment field and using the knob, move the cursor to the bit you want to change, then select an asterisk or a period. When the bits are assigned as desired, and you close the pop-up, the screen displays the new bit assignment.

To the left of the bit assignment field is a bit reference number that tells you the bit number which is being assigned. In addition, above the bit assignment field, is a reference line with numbers from 0 to 15, with the left bit numbered 15 and the right bit numbered 0. This bit reference line helps you know exactly which assigned bits have a proper connection by displaying activity indicators.

See Also

For more information on the bit reference line and the activity indicators on the bit reference line, refer to "Activity Indicators" in the Configuration menu.

Bit Assignment field

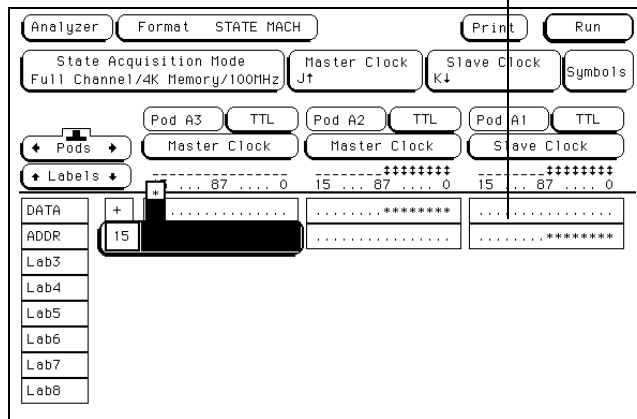

Bit Assignment Field

The Format Menu Bit Assignment Fields

Labels may have from 1 to 32 channels assigned to them. If you try to assign more than 32 channels to a label, the logic analyzer will beep, indicating an error. A message will appear at the top of the screen telling you that 32 channels per label is the maximum.

Channels assigned to a label are numbered from right to left by the logic analyzer. The least significant assigned bit on the far right is numbered 0, the next assigned bit is numbered 1, and all other bits assigned sequentially up to the maximum of 16 per pod. Since 32 channels can be assigned to one label at most, the highest number that can be given to a channel is 31.

Although labels can contain split fields, assigned channels are always numbered consecutively within a label.

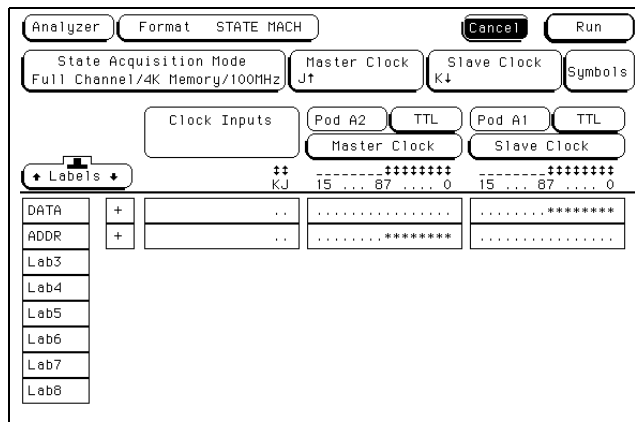

Bit Assignment Example

System / Analyzer Field

The function of the System/Analyzer field is the same in all menus. For a complete definition of the System/Analyzer field, go to "The Common Menu Fields" chapter at the beginning of the Analyzer part of this User's Reference.

Menu Field

The function of the Menu field is the same in all menus. For a complete definition of the Menu field, go to "The Common Menu Fields" chapter at the beginning of the Analyzer part of this User's Reference.

Print Field

The function of the Print field is the same in all menus. For a complete definition of the Print field, go to "The Common Menu Fields" chapter at the beginning of the Analyzer part of this User's Reference.

Run Field

The function of the Run field is the same in all menus. For a complete definition of the Run field, go to "The Common Menu Fields" chapter.

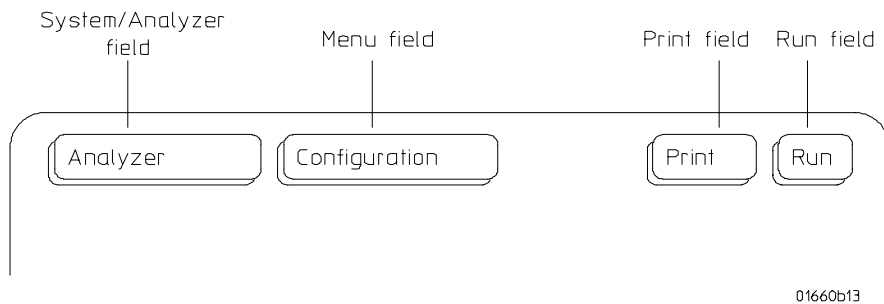

Common Menu Fields



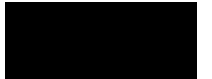

The Trigger Menu

The Trigger Menu

The trigger menu is used to configure when the analyzer triggers, what the analyzer triggers on, and what is stored in acquisition memory. In addition, within the Acquisition Control function, prestore and poststore requirements are set. The Trigger menu is divided into three areas, each dealing with a different area of general operation.

- Sequence Levels
- Resource Terms
- Acquisition Control

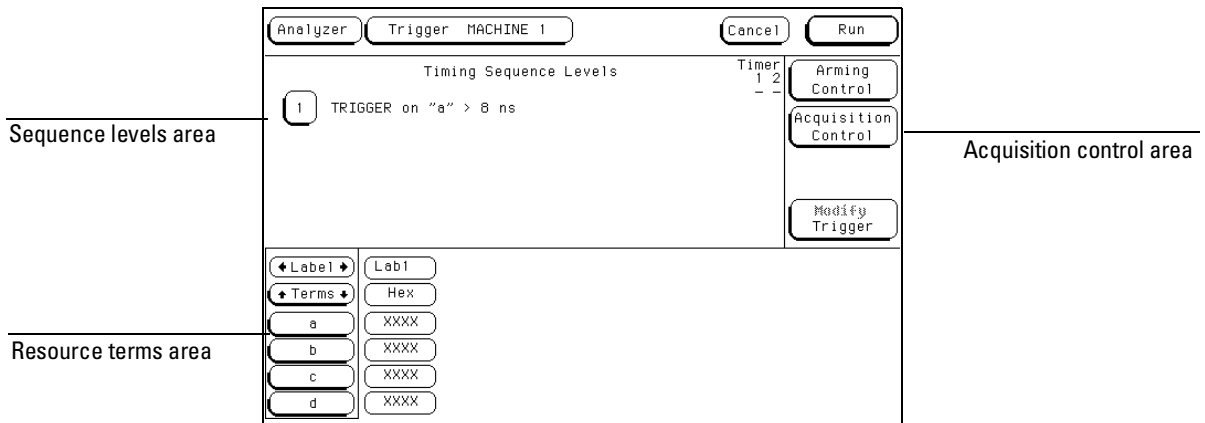

Trigger Menu Areas

Sequence Levels Area

You use the sequence levels area to view the sequence levels currently used in the trigger specification and their timer status. From this area you can also access each individual level for editing.

Resource Terms Area

You use the resource terms area to assign values to the resource terms. Resource terms take the form of bit patterns, ranges, and edges. In addition to assigning values to the resource terms, you also assign values to the two timers, and assign custom names to all the resource terms.

Once defined and inserted into the trigger specification, the resource terms will identify key points in the data stream for branching or the point for data acquisition to occur.

Control Area

You use the acquisition control area to manage the efficient use of analyzer memory. You define any arming control or whether you want time or count tags placed in the stored data.

Within the Acquisition Control function, you can adjust trigger position, sample period, memory length, and whether the resource term that generated a branch is stored.

Trigger Menu Map

The following menu map illustrates all fields and available options in the Trigger menu. The menu map will give you an overview as well as provide you with a quick reference of what the Trigger menu contains.



The Trigger Menu

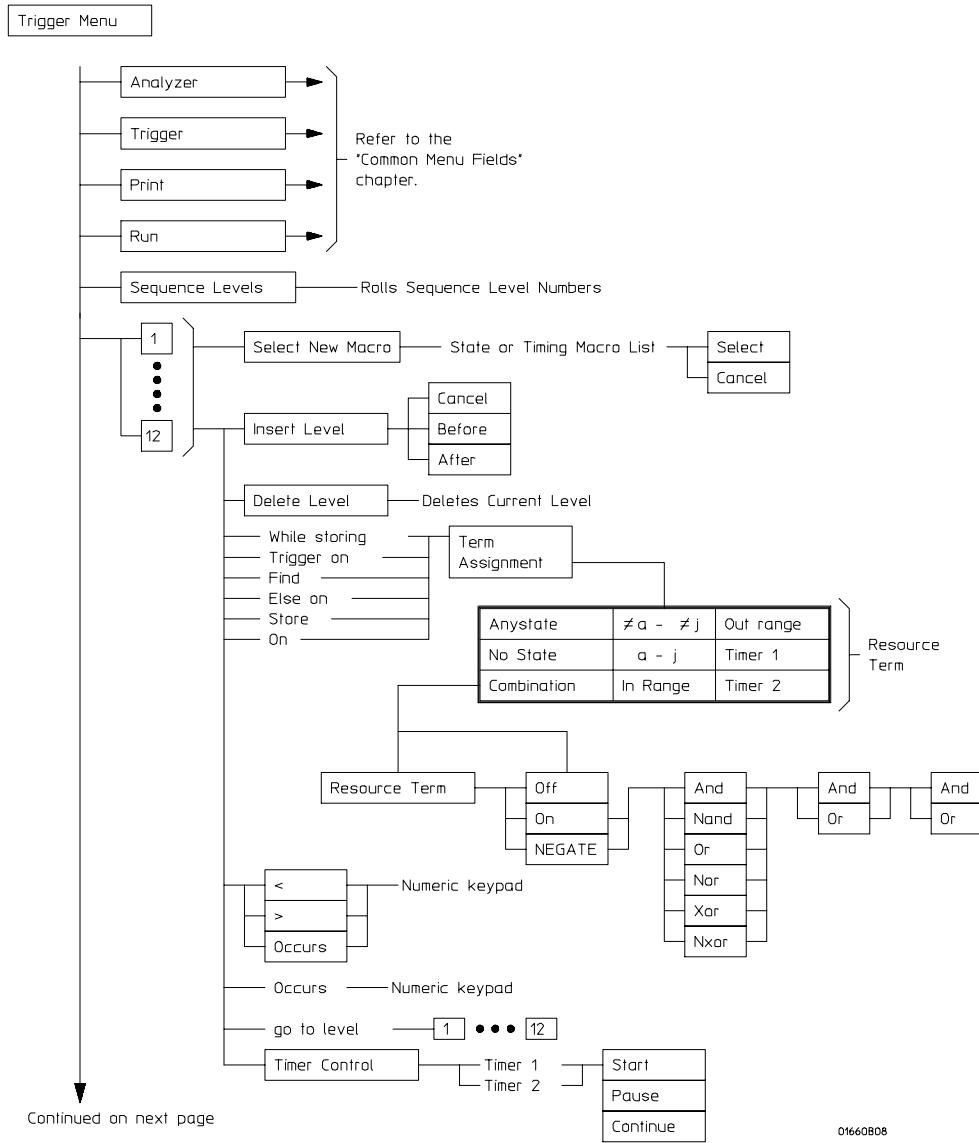

Trigger Menu Map

Continued from previous page

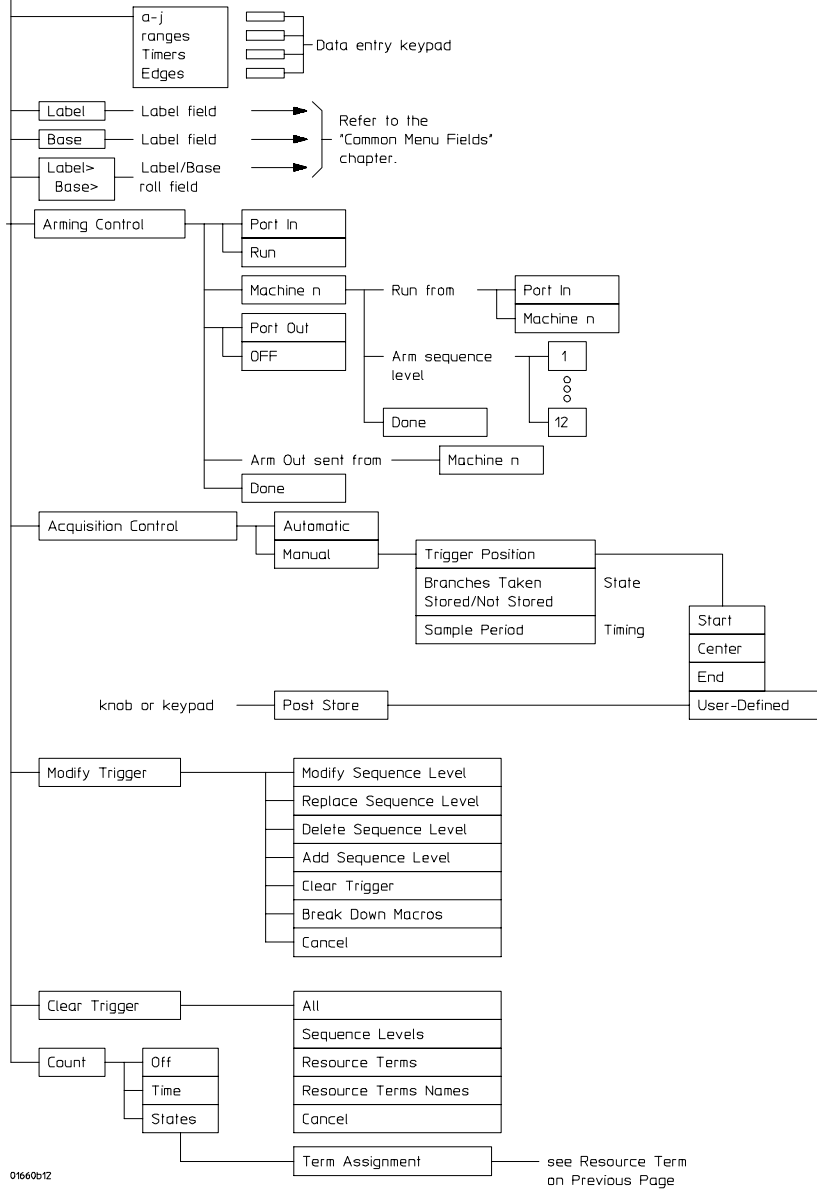

01660b12

Trigger Menu Map (Continued)

Trigger Sequence Levels

Sequence levels are the definable stages of the total trigger specification. When defined, sequence levels control what the analyzer triggers on, when the analyzer triggers, and where trigger will be located in the total block of acquired data. In addition, you can qualify what data is stored when trigger occurs.

By using sequence levels, you create a sequence of instructions for the analyzer to follow. As the sequence levels are executed, all subsequent branching and sequence flow is directed by the statements within the sequence levels. The path taken resembles a flow chart, and the end result is the desired trigger point.

Individual sequence levels are assigned either a pre-defined trigger macro, or a User-level trigger macro. The total trigger specification, (one or more sequence levels) can contain pre-defined macros, User-level macro, or a combination of both. You finish defining each level by inserting resource terms, timers, or occurrence counters into assignment fields within each macro.

In State Acquisition Mode, there are 12 sequence levels available. In Timing Acquisition Mode there are 10 sequence levels available.

Sequence Level Usage

Generally, you would think using one macro in one sequence level uses up one of the available sequence levels. This may not always be the case. Some of the more complex pre-defined macros require multiple sequence levels. Keep this point in mind if you are near the limit on remaining sequence levels. The exact number of internal levels required per macro, and the remaining available levels, is shown within the macro library list.

The only instance where multiple levels are used with the User-level macro, is when the "<" duration is assigned.

Editing Sequence Levels

The higher level editing, such as adding or deleting entire sequence levels, is done using the Modify Trigger field in the main Trigger menu. You can also modify any existing sequence level from the Modify Trigger field.

Another way of editing a specific sequence level is to select the sequence level number field. If the number field is offscreen, select the sequence levels roll field turning it light blue, then use the knob to roll the level back onscreen.

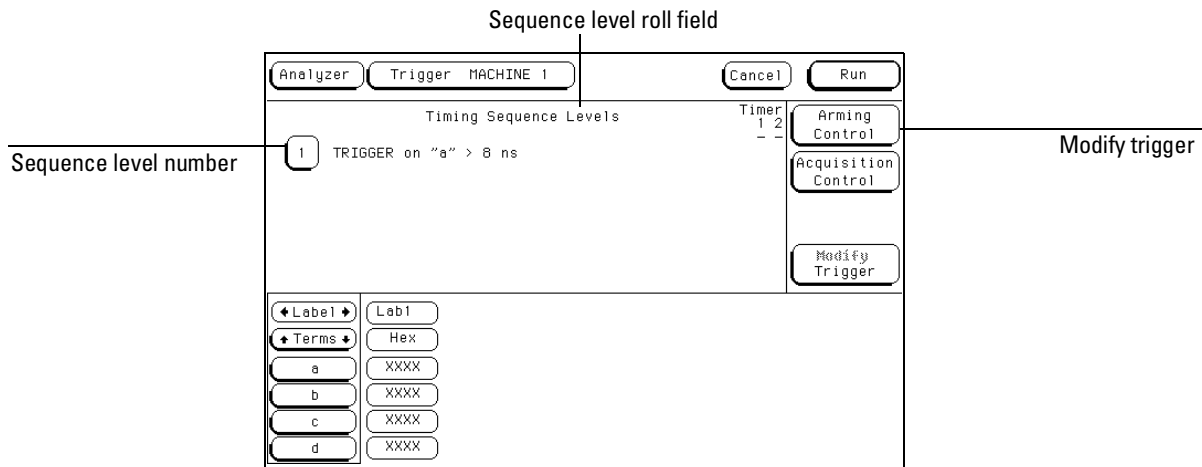

Accessing Sequence Levels

Once you are in any sequence level, you can reconfigure the existing macro by selecting and reassigning the assignment fields and value fields. All appropriate resource terms appear in pop-up selection lists after any of the assignment fields are selected.

To edit the actual values assigned to the resource terms, exit the sequence level and make changes to the terms assignment fields in the resource terms area.

See Also

"Assigning Resource Term Names and Values" found later in this chapter.

Modify Trigger Field

The Modify Trigger field allows you to modify the statements of any single sequence level as well as other high level actions like global clearing of existing trigger statements, and adding or deleting sequence levels.

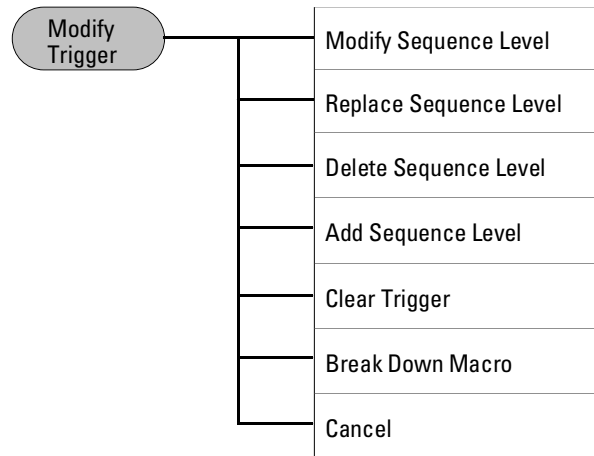

Modify Sequence Level

If there is more than one sequence level assigned, you are asked which level to modify. Once in the desired sequence level, make all appropriate resource changes, then select Done.

Replace Sequence Level

If there is more than one sequence level assigned, you are asked which level to replace. When you replace a level, you pick a new macro to replace the old one. You then assign the appropriate resource in the new level.

Delete Sequence Level

If there is more than one sequence level assigned, you are asked which level to delete.

Add Sequence Level

By default you have one sequence level available at powerup. When you add sequence levels, you are given the choice of inserting them before or after a sequence level.

Clear Trigger

The Clear Trigger field accesses a selection menu used to clear any user-defined values within the trigger specification or within the resource terms list.

Clear All The Clear All option clears sequence levels, resource terms, and resource term names back to their default values.

Clear Sequence Levels The Clear Sequence Levels option resets all assignment fields in the sequence levels to their default values. Any custom names assigned to the resource terms will remain.

Clear Resource Terms The Clear Resources Terms option will reset all assignment fields for the resource terms back to their default values.

Clear Resource Term Names The Clear Resource Term Names option resets all custom names assigned to the resource terms back their default values.

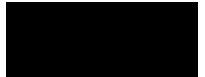

Break Down Macros / Restore Macros

When a pre-defined macro is broken down, the contents of that macro are displayed in the same long form used in the User-level macro. If the macro uses multiple internal levels, all levels are separated out and displayed in the sequence level area of the Trigger menu. Once the macros in your trigger specification are broken down, the Break Down Macros field changes to Restore Macros. Use the Restore Macros field to restore all macros to their original structure.

While in a broken down form, you can change the structure. However, when the macros are restored, all changes are lost and any branching that is part of the original structure is restored.

Use the Break Down Macros if you want to view a particular macro part in its long form to see exactly what flow the sequencer is following. It can also be used as an aid in creating a custom trigger specification. In this application, you would start with a pre-defined macro, break it down, then customize the long form to meet your needs.

When a macro is broken down, you have all the assignment fields and branching options available as if you have configured a User-level macro. For information on the assignment fields, branching, occurrence counters, and time duration function, refer to the section, "Modifying the User-level Macro" found later in this chapter.

Pre-defined Trigger Macros

Both the state and timing acquisition modes have a macro library containing pre-defined trigger macros. Depending on which acquisition mode you are using, you get the corresponding library.

Each macro will require at least one sequence level, and in some cases, may require multiple levels. Sequence levels containing pre-defined macros flow linear without branching. However, if branching is required, the User-level macro can be inserted to provide a branch.

Both lists of macros are divided into the following different groups depending on their function.

Timing Trigger Macro Library:

- User Mode (User-level macro)
- Basic Macros
- Pattern/Edge Combination Macros
- Time Violation Macros
- Delay Macros

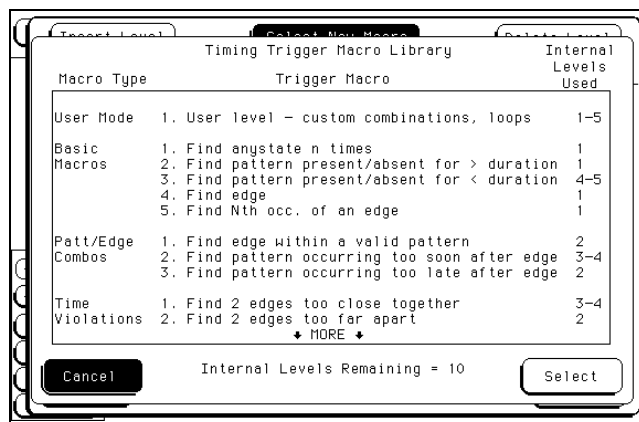

Timing Trigger Macro Library

State Trigger Macro Library:

- User Mode (User-level macro)
- Basic Macros
- Sequence Dependent Macros
- Time Violation Macros
- Delay Macros

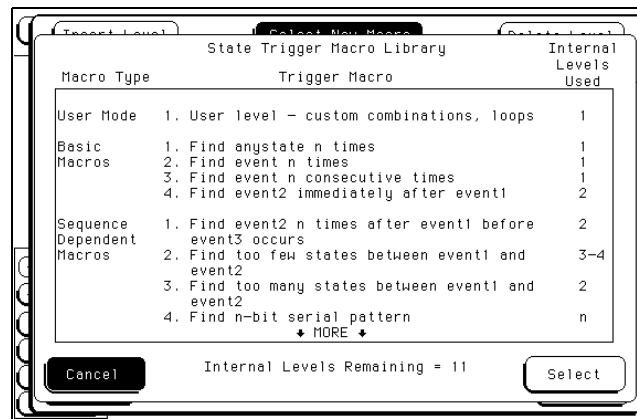

State Trigger Macro Library

Using Macros to Create a Trigger Specification

To configure a trigger specification using trigger macros, follow the procedure below.

- 1 From the Trigger menu, enter the desired sequence level through the **Modify Trigger** field, or by selecting a sequence level number.

See Also

"Editing Sequence Levels" and "Modify Trigger Field" found earlier in this chapter for information on accessing levels.

- 2 From within the sequence level, select the **Select New Macro** field.

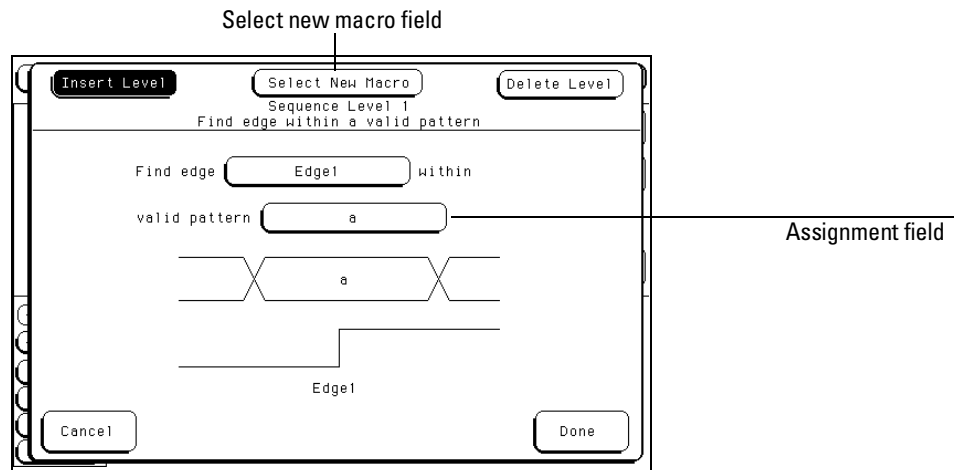

Select New Macro Field

- 3 Scroll and highlight the macro you want, then select the **Select** field.
- 4 Select the appropriate assignment fields and insert the desired pre-defined resource terms, numeric values, and other parameter fields required by the macro. Select the **Done** field.

In State Acquisition mode, a final "go to trigger" level is automatically placed at the end of the trigger specification for you.

See Also

"Resource Terms" found later in this chapter for information on using pre-defined resource terms.

Timing Trigger Macro Library

The following list contains all the macros in the Timing Trigger Macro Library. They are listed in the same order as they appear onscreen.

User Mode

User level - custom combinations, branching

The User level is a user-definable level. This level offers low level configuration and uses one internal sequence level. If the "<" duration is used, four levels are required.

Basic Macros

1. Find anystate "n" times

This macro becomes true when the first state it sees occurs "n" number of times. It uses one internal sequence level.

2. Find pattern present/absent for > duration

This macro becomes true when it finds a designated pattern that has been present or absent for greater than or equal to the set duration. It uses one internal sequence level.

3. Find pattern present/absent for < duration

This macro becomes true when it finds a designated pattern that has been present or absent for less than the set duration. It uses four internal sequence level.

4. Find edge

This macro becomes true when the designated edge is seen. It uses one internal sequence level.

5. Find Nth occurrence of an edge

This macro becomes true when it finds the designated occurrence of a designated edge. It uses one internal sequence level.

Pattern/Edge
Combinations

1. Find edge within a valid pattern.

This macro becomes true when a selected edge type is seen within the time window defined by a designated pattern. It uses two internal sequence level.

2. Find pattern occurring too soon after edge

This macro becomes true when a designated pattern is seen occurring within a set duration after a selected edge type is seen. It uses three internal sequence levels.

3. Find pattern occurring too late after edge

This macro becomes true when one selected edge type occurs, and for a designated period of time after that first edge is seen, a pattern is not seen. It uses two internal sequence levels.

Time Violations

1. Find two edges too close together

This macro becomes true when a second selected edge is seen occurring within a designated period of time after the occurrence of a first selected edge. It uses three internal sequence levels.

2. Find two edges too far apart

This macro becomes true when a second selected edge occurs beyond a designated period of time after the first selected edge. It uses two internal sequence levels.

3. Find width violation on a pattern/pulse

This macro becomes true when the width of a pattern violates designated minimum and maximum width settings. It uses four internal sequence level.

Delay

1. Wait "t" seconds

This macro becomes true after a designated time period has expired. It uses one internal sequence level.

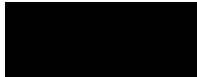

State Trigger Macro Library

The following list contains all the macros in the State Trigger Macro Library. They are listed in the same order as they appear onscreen.

User Mode

User level - custom combinations, loops

The User level is a user-definable level. This level offers low level configuration and uses one internal sequence level.

Basic Macros

1. Find anystate "n" times

This macro becomes true when the first state it sees occurs "n" number of times. It uses one internal sequence level.

2. Find event "n" times

This macro becomes true when it sees a designated pattern occurring a designated number of times consecutively or nonconsecutively. It uses one internal sequence level.

3. Find event "n" consecutive times

This macro becomes true when it sees a designated pattern occurring a designated number of consecutive times. It uses one internal sequence level.

4. Find event 2 immediately after event 1

This macro becomes true when the first designated pattern is seen immediately followed by a second designated pattern. It uses two internal sequence levels.

Sequence
Dependent macros

1. Find event 2 "n" times after event 1, before event 3 occurs

This macro becomes true when it first finds a designated pattern 1, followed by a selected number of occurrences of a designated pattern 2. In addition, if a designated pattern 3 is seen anytime while the sequence is not yet true, the sequence starts over. If patt2's "nth" occurrence is coincident with patt3, the sequence starts over. It uses two internal sequence levels.

2. Find too few states between event 1 and event 2.

This macro becomes true when a designated pattern 1 is seen, followed by a designated pattern 2, and with less than a selected number of states occurring between the two patterns. It uses three internal sequence levels.

3. Find too many states between event 1 and event 2.

This macro becomes true when a designated pattern 1 is seen, followed by at least a selected number of states, then followed by a designated pattern 2. It uses two internal sequence levels.

4. Find n-bit serial pattern

This macro finds an "n" bit serial pattern on a designated channel and a designated label.

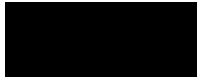

Time Violations

1. Find event 2 occurring too soon after event 1

This macro becomes true when a designated pattern 1 is seen, followed by a designated pattern 2, and with less than a selected time period occurring between the two patterns. It uses two internal sequence levels..

2. Find event 2 occurring too late after event 1

This macro becomes true when a designated pattern 1 is seen, followed by at least a selected time period, before a designated pattern 2 occurs. It uses two internal sequence levels.

Delay

1. Wait "n" external clock states

This macro becomes true after a designated number of user clock states have occurred. It uses one internal sequence level.

Modifying the User-level Macro

Before you begin building a trigger specification using the User-level macro, it should be noted that in most cases one of the pre-defined trigger macros will work.

If you need to accommodate a specific trigger condition, or you prefer to construct a trigger specification from scratch, you will use the User-level macro to build from. This macro appears in long form, which means it has the analyzer's total flexibility available in terms of resource terms, global timers, occurrence counters, duration counters, and two way branching.

The User-level macro has a "fill-in-the-blanks" type statement. You have the following elements to use:

- Bit Patterns, Ranges, and Edges
- Storage Qualification
- < and > Durations
- Occurrence Counters
- Timers
- Branching

The screenshot shows a dialog box titled "User level - custom combinations, loops". At the top, there are three buttons: "Insert Level", "Select New Macro", and "Delete Level". Below these, it says "Sequence Level 1" and "User level - custom combinations, loops". The main area contains a "While storing" field with the value "anystate" and an "Assignment field" label pointing to it. Below that, there is a "TRIGGER on" field with the value "a" and an "Occurs" field with the value "1". This is labeled as the "Primary 'Find' branch". Below the trigger field, there is an "Else on" field with the value "no state" and a "go to level" field with the value "1". This is labeled as the "Secondary 'else on' branch". At the bottom, there is a message "Timer Control is not available in level 1" and two buttons: "Cancel" and "Done".

User-level Macro

The Trigger Menu

Modifying the User-level Macro

The number of User-level macros you will use, or what you assign to the resource terms is difficult to predict because of the variety of applications. A general approach is to think of each field assignment or each new sequence level as an opportunity to lead the analyzer through key points in the data stream. Your end result is to select the desired point in the data to trigger on, and to store only the data you want. If you know the data structure and flow well enough, you could build a flowchart.

A typical method used during a debug operation is to first trigger on a known pattern, edge or range. From that point, it becomes an iterative process of adding more levels to further filter the data. It is important for you to know how to use such elements as occurrence counters, timers, and branching, to zero in and trigger at the desired point.

As the analyzer executes the trigger specification, it searches for a match between the resource term value and the data. When a match is found, that part of the sequence statement becomes true and the sequencing continues to the next part of the statement or the next sequence level.

Eventually a path of "true" resource terms leads to your trigger command. If timers or occurrence counters are used, the analyzer waits or counts occurrences of a specified value before continuing.

The following examples illustrate the use of resource terms, occurrence counters, timers, branching, and store qualification. You will use them in your trigger specification either by themselves or in combination with each other.

Using Bit Patterns, Ranges, and Edges

Bit patterns are set to match specific data values, and ranges are set to match a range of bit patterns. In the Timing Acquisition mode, edges are set to match specific edges of a timing pulse.

Example

The following statement looks for the bit pattern you assigned to term "a" to occur "1" time, before it triggers.

TRIGGER on Occurs

Example

The following statement looks for the positive, negative, or either going edge type you assigned to term "**Edge1**" to occur "**1**" time, before it **Triggers** .

TRIGGER on Occurs

Example

The following statement looks for the combination of either a bit pattern you assigned to "**a**" or an edge type you assigned to "**Edge1**" to occur "**1**" time before it **Triggers**.

TRIGGER on Occurs

Example

The following statement looks for a range of bit patterns assigned to "**Range1**" to occur "**2**" times before it branches to the next sequence level.

TRIGGER on

See Also

"Assigning Resource Term Names and Values" for more information on using resource terms by themselves and in combinations.

Using Storage Qualification

Store qualification enables you to store all data, no data, or just selected data, before trigger occurs.

Example

The following statement determines that all occurrences of the bit pattern you assigned to "a" will be stored before trigger occurs.

While storing 

Setting < and > Durations (Timing only)

When a resource term is found during a timing sequence evaluation, you can dictate how long the term must remain before the term actually becomes true. When < or > duration is assigned, the secondary branching (Else on) is not available.

Example

The following statement dictates the bit pattern you assigned to "a" must appear and remain present for greater than **8 ns**.

TRIGGER on   

> Field When greater-than (>) is used, the analyzer continues sequence level evaluation only after the resource term has been true for greater than or equal to the amount of duration specified.

< Field When less-than (<) is used, the analyzer continues sequence level evaluation only after the resource term has been true for less than or equal to the amount of duration specified. For each (<) assignment, you must delete 4 levels from the total number of sequence levels. So in actuality, using a less than sign requires four sequence levels.

Using the Occurrence Counters

Occurs Field When "Occurs" is selected, the < and > duration functions change to an occurrence counter. Use the occurrence counter to delay sequence evaluation until the resource term has occurred a designated number times. If the "else on" branch becomes true before all specified occurrences of the primary "Trigger on" branch, the secondary "else on" branch is taken.

Example

The following statement assigns the Occurrence Counter to the primary "Trigger on" branch. Once the Occurrence Counter is assigned, a new assignment field appears to set the number of occurrences.

TRIGGER on Occurs

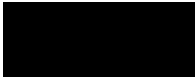

Using the Timer

Timers are like other resource terms in that they are either true or false. Timers can be set to Start, Stop, Pause, or Continue as the analyzer enters a sequence level. The two timers are global, so each sequence level has the ability to control the same timer. The default timer condition in all sequence levels is Off.

Example

The following statement assigns the "Timer 1" to the secondary "else on" branch. If the bit pattern is not seen before the timer counts 400ns, the secondary branch is taken to level 2.

```
TRIGGER on     
  
Else on  go to level 
```

See Also

The "Timer Terms" found later in this chapter for information on how timers work and how to assign a value to a timer.

Branching

If either the < or > durations is used, only the primary "Trigger on" branch is available, otherwise each sequence level has two way branching.

If the primary branch is taken, the analyzer triggers and goes to the next level. If the primary branch is not found, the analyzer immediately evaluates the "Else on" secondary branching term.

If the "Else on" term is found, the secondary branch taken is to the designated sequence level. If the "Else on" term is not found, the analyzer continues to loop within the same sequence level until one of the two branches are found. If the "Else on" branch is taken, the occurrence counter is reset even if the "go to level" branch is back to the same level. If both branches are found true at the same time, the primary branch is taken.

Branching across trigger levels is possible. If this occurs, the sequence level evaluation could loop without ever seeing a trigger term. Care should be taken in designing your sequence instructions.

Example:

The following statement instructs the analyzer to find the bit pattern you assigned to "a." If it finds "a," then the analyzer branches to the next sequence level. If it doesn't find "a", the sequence evaluation immediately branches to sequence level **3**.

Then find Occurs

Else on go to level

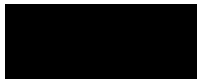

Resource Terms

Resource terms are user-defined variables that are assigned to sequence levels. They are placed into the sequence statement where their bit pattern or edge type is searched for within the data stream. When a match is found, a branch is initiated and the next statement or sequence level is acted upon. Resource terms take the following forms:

- Bit Patterns Terms a–j
- Range Terms 1 and 2
- Edge Terms 1 and 2 (Timing only)

Bit Patterns Terms a–j

When the logic analyzer is configured as a state analyzer, up to twelve resource terms can be assigned in your trigger specification. You can use any of the 10 bit pattern terms a – j, plus any of the two range terms 1 and 2.

When the logic analyzer is configured as a timing analyzer, up to ten resource terms can be assigned in your trigger specification. You can use any of the 10 bit pattern terms a – j, and any of the two edge terms 1 and 2 as long as the total does not exceed ten.

Bit patterns terms can also take the NOTed form of $\neq a - \neq j$.

Range Terms 1 and 2

Two range terms are available which can be set to a range of bit pattern values. The first pattern and the last pattern are part of the range which must be matched.

Range terms take the form of either In Range, or the NOTed form of Out Range.

Edge Terms 1 and 2 (Timing only)

The two edge terms are only available in the timing analyzer. Edge terms are assigned either a positive going , negative going, or both edge type.

Two global Timers

In addition to the resource terms available, there are two global timers available. Each timer can be started, paused, continued, or stopped, from any sequence level.

All resource terms and timer terms are listed under a scrollable Terms field. To view all offscreen terms, select the Terms field, then use the knob to roll the terms list onscreen.

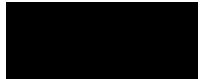

Assigning Resource Term Names and Values

The Terms field identifies the list of available resource terms within the analyzer. The resource term names (a – j, Edge1, Edge2, Range1, Range2) are default names that can be changed if desired. You assign values in the following two ways:

- Using Preset Values
- Bit by Bit Assignment

Using Preset Values

When any of the individual term fields are selected, a configuration pop-up appears. Use this pop-up menu to quickly assign the resource term to a preset value, or assign a customized name to the resource term.

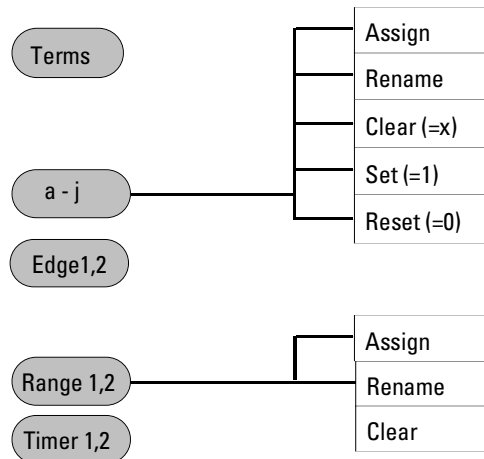

Assign All of the available resource terms except the Edge terms can be assigned to any analyzer. However, a term can only be assigned to one analyzer at a time. When either resource term is selected, it toggles between analyzers.

Rename This function accesses a keypad which you use to create a custom name or edit the existing name for the resource term. This function works for all terms.

Clear (=X) Sets the Term Assignment fields as follows:

In Terms a – j, the assignment field is set to all Xs (don't cares).

In Range 1, 2 terms, the two assignment fields are set to maximum (Fs) and minimum (0s) settings.

In Timers 1, 2 terms, the assignment field is reset to a minimum time of 400 ns.

In Edge 1, 2 terms, the assignment field is reset to a period (.).

Set (=1) Sets the Term Assignment fields as follows:

In Terms a – j, the assignment field is set to all 1s (high).

This option is not available for the two Ranges Timer, and Edge terms.

Reset (=0) Sets the assignment fields as follows:

In Terms a – j, the assignment field is set to all 0s (low).

This option is not available for the two Range, Timer, and Edge terms.

Bit by Bit Assignment

Bit Pattern Terms Just to the right of the bit pattern name fields are the term assignment fields. When any of the individual assignment fields are selected, a keypad appears. Use this keypad to assign real values or Don't Care (x) values.

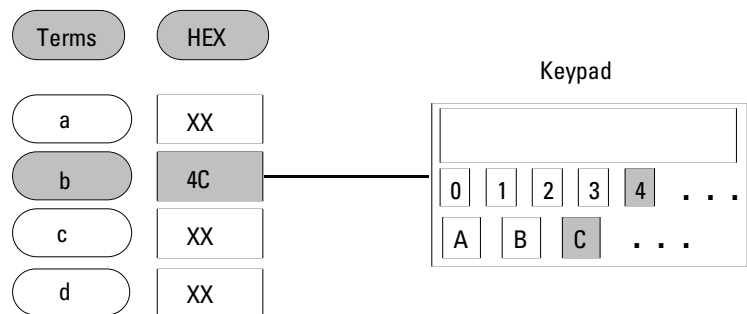

The Trigger Menu

Assigning Resource Term Names and Values

Edge Terms If you want to qualify an edge, place the appropriate edge on the data channel you are watching. When the analyzer sees the correct edge, the term becomes true.

Edge terms can be used singularly or in combination with each other across all assigned channels. When you specify an edge on more than one channel, the analyzer ORs the edges.



The following edge choices are available for each bit:

- Positive edge (↑)
- Negative edge (↓)
- Either positive or negative (↕)
- No edge (.)

After the assignment menu closes, you may see "\$" indicators in the assignment field display. This symbol indicates the assignment can't totally be displayed in the selected base. It was assigned in another base. When Binary is selected for the numeric base, you see the actual assignments.

Range Terms Range terms bracket groups of bit patterns. Each Range term is assigned to either of the two analyzers, but not both. You assign an upper and lower bit pattern boundary. The range is recognized as the data that is numerically between or on the two specified boundaries. In addition, the range must be contained in a single pod pair, with no clock bits allowed.

To assign bit patterns to the upper and lower boundaries of a Range term, you use a pop-up keypad. The keypad appears when you select the upper or lower Range term assignment fields.

Timer Terms

Each Timer term is assigned to either of the two analyzers, but not both. With timers inserted into sequence levels, you can start a timer in one level, pause it, or stop it in another sequence level.

Timers are either true or false. Timers start as you enter the sequence level, and when its count expires, it becomes true. If a timer is paused in one level, it must be continued in another level before it can count through.

As more sequence levels are added, the timer status in the new levels default to Off. Timers must be continue or started in each new level if it is appropriate. When a timer expires or stops, its count resets to zero.

Combination of Terms

Combination terms are configured and selected from within sequence levels. All user-defined resource terms can be combined to create complex qualifiers that occupy a single assignment field space.

When the term assignment field is selected, and "Combination" is selected from the pop-up selection list, a logical assignment menu appears. Use this menu to turn on resource terms and input them into a chain of logical operators.

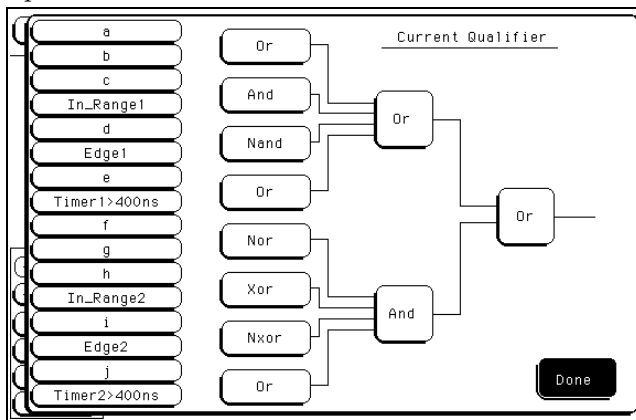

Logic Operation Choices

When the combination is placed in the assignment field, if the term is too long to fit in the assignment field, the display is truncated.

Label and Base Fields

The Label and Base fields show up together in all menus except the Format menu. When a new label is assigned, a base field is automatically assigned to that label.

Label Field Labels are displayed throughout the analyzer as they were assigned in the Format menu. To reorder currently displayed labels in the Trigger menu and the Specify Pattern sub-menus, select the label you want to move, then from the selection menu that appears, choose the label you want to switch positions with.

Base Field All assigned labels will have a base field assigned to it. If the numeric base is changed in a menu, the base in other menus may not change accordingly. As an example, the base assigned to symbols is unique, as is the base assigned in the Compare and Listing menus. If you change one, you may not want the others to change. The base choices are Binary, Octal, Decimal, Hex, ASCII, Symbol and Twos.

Label and Terms Roll Field

The rolling function is the same for all items that are stored offscreen. For more information on rolling labels, base, and pods, refer to the "Common Menu Fields" chapter.



Arming Control Field

The Arming Control field shown below accesses an Arming Control menu. The Arming Control menu is used to configure the arm signals between analyzers, and the Port In/Out signals. By using the arming signals, you influence the order in which the analyzers triggers in a cross-domain measurement.

The screenshot shows a software interface for configuring an Arming Control field. At the top, there are buttons for 'Analyzer', 'Trigger STATE MACH', 'Cancel', and 'Run'. Below this is a 'State Sequence Levels' section with two levels: Level 1 is 'While storing "no state" TRIGGER on "a" 1 time' and Level 2 is 'Store "anystate"'. To the right of this section are 'Timer' controls for levels 1 and 2, and a vertical stack of buttons: 'Arming Control', 'Acquisition Control', 'Count Time', and 'Clear Trigger'. At the bottom, there is a table with columns for 'Label' and 'DATA 1'. The table contains four rows: 'a' with '10101010', 'b' with 'XXXXXXXX', 'c' with 'XXXXXXXX', and 'd' with 'XXXXXXXX'.

Label	DATA 1
a	10101010
b	XXXXXXXX
c	XXXXXXXX
d	XXXXXXXX

Arming Control field

Arming Control Field



Arming Control Between Analyzers

If both analyzers in a module are turned on, you can configure one analyzer to arm the other. An example of this is when a state analyzer triggers on a bit pattern, then arms a timing analyzer which captures and displays the waveform after it triggers.

When you select the analyzer name field in the Arming Control menu shown below, a pop-up menu appears which you use to select where the Arm In signal is coming from. In addition, a sequence level number field appears which you use to select the sequence level in which an "arm" flag is placed.

When an analyzer receives an Arm In signal, an "arm" term is placed in a user selected sequence level and the analyzer automatically begins evaluating its trigger sequence instruction. If, in the sequence evaluation the "arm" term is seen first, the analyzer will trigger. However, if the "arm" term is placed down in the sequence level order, the preceding sequencing could trigger the analyzer before the "arm" term is seen. Generally, the "arm" term is evaluated and used the same as the other resource terms within the sequence instruction.

After you configure the Arming Control menu, a graphical representation of the analyzer arming configuration is displayed as shown below.

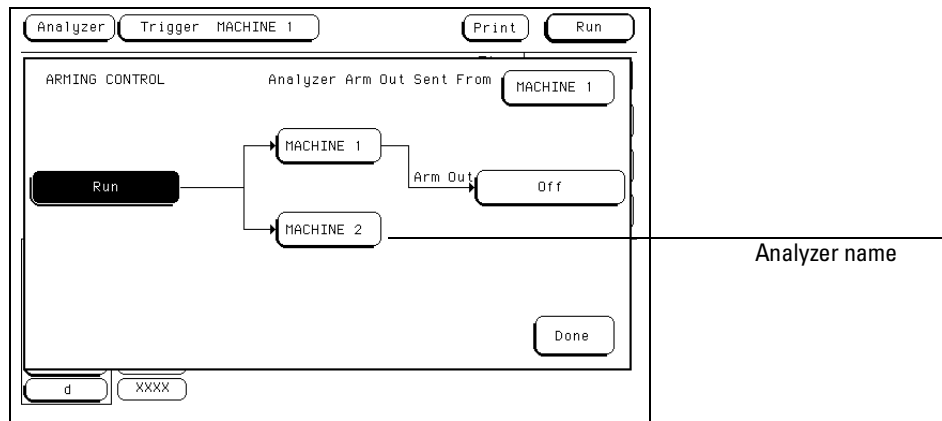

Two Analyzer Arming

Arming Control Using External BNCs

A more complex arming example involves passing arm signals in and out through the External BNCs on the rear panel.

The first analyzer is armed by an Arm In signal from an external trigger source or another test/measurement entity. After the first analyzer triggers, it arms the second analyzer. After the second analyzer triggers, it can send a Port Out signal to an external BNC which is used to arm another external test/measurement entity.

The Arm Out signal is generated by either one of the two local analyzers which you select.

After you configure the Arming Control menu, a graphical representation of the analyzer arming configuration is displayed as shown below.

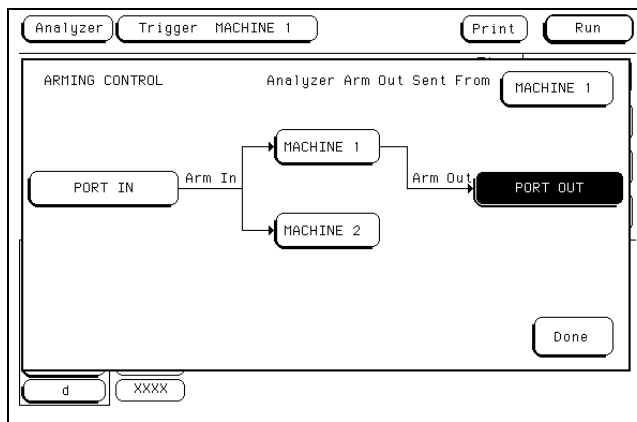

Port In/Out Arming



Acquisition Control

The Acquisition Control menu is used to set the acquisition mode, the trigger position within available memory, and the sample period.

Acquisition Mode Field

The Acquisition Mode field toggles between Manual and Automatic. When set to Automatic, the position of stored data relative to trigger and the sample rate are based on the sec/Div and delay settings in the Waveform menu.

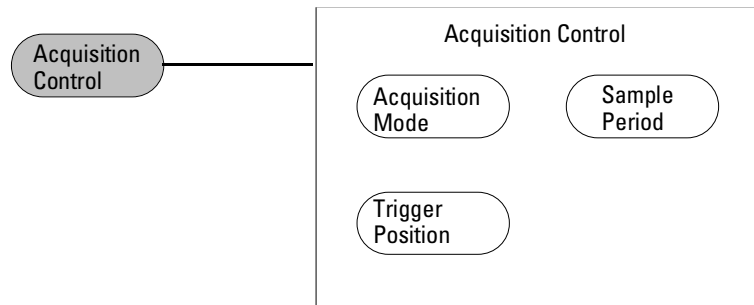

When the Acquisition Mode field is set to Manual, additional configuration fields become available. The additional configuration fields work together with the sequence instructions, in a prioritized manner, to position the memory in relation to the trigger point.

Trigger Position Field

The Trigger Position field accesses a selection menu with the options of Start, Center, End, User Defined, or Delay. When an option is selected, that point of the available memory is positioned relative to the trigger. A representation of this is shown by the blue graphic bar with the "Trig" indicator line. The Trigger Position field determines how much data is stored before and after the trigger occurs for all subsequent acquisitions.

When a Run is started, the analyzer will not look for a trigger until at least the proper percent of pretrigger data has been stored. After a trigger has been detected, the proper percent of posttrigger data is stored before the analyzer halts.

Even when the trigger position is set to Start or End, there will always be a small portion of pretrigger and posttrigger data stored.

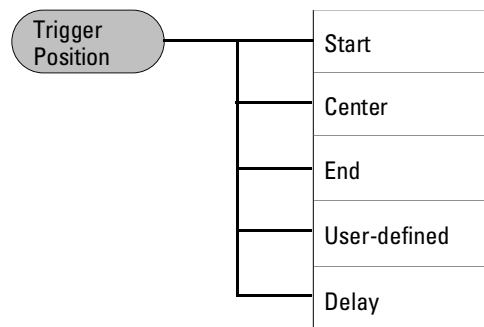

Start When the trigger position is set to Start, the starting point of available memory is positioned relative to the trigger point. This results in maximum posttrigger data and minimum pretrigger data.

Center When the trigger position is set to Center, the center point of available memory is positioned relative to the trigger point. This results in half pretrigger data and half posttrigger data.

End When the trigger position is set to End, the end point of available memory is positioned relative to the trigger point. This results in maximum pretrigger data and minimum posttrigger data.

User Defined When the trigger position is set to User Defined, a Post Store field appears. Use this field to set the trigger position anywhere between 0% and 99%. As the Post Store is adjusted, the blue graphic bar indicates the trigger position.

Delay Use the Delay field to delay the start of acquisition storage after the trigger. The range of the delay time is affected by the sample period but could range between 16ns to 8ks.

Sample Period Field

The Sample Period field is used to set the time period between data samples. Every time a new sample is taken, the analyzer will see updated measurement data.

Branches Taken Stored / Not Stored Field

The Branches Taken field is a toggle field which sets the analyzer to store, or not to store, the resource term that sent the analyzer off on a branch.

As the analyzer steps through the sequence instructions, it may be repeatedly sent off to secondary branches because the first resource term was bypassed (false), and the second "Else" resource term is qualified (true). With Branches Taken set to Stored, both the state data values that caused the secondary branches and the secondary branch is stored into memory.

Count Field (State only)

The Count field is used to access a selection menu which is used to stamp the acquisition data at each memory location with either a Time tag or a State count tag.

Storing Time or State tags

If you have all pod pairs assigned, the state acquisition memory is reduced by half, when time or state tags are turned on. You can maintain full memory depth if you leave a specified pod pair unassigned.

States States count places numbered tags on all pretrigger and posttrigger data. Data stored before trigger has negative numbers and data stored after trigger has positive numbers. State tag numbering is set to be either relative to the previous memory location or absolute from the trigger point. Selecting the Absolute or Relative option is done by toggling the Absolute/Relative field. When State count is selected in the Trigger menu, the exact state locations tagged can be selectively chosen from the Resource Term selection list.

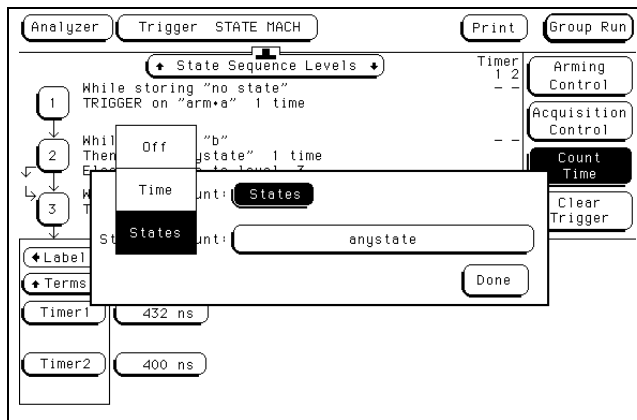

Count Field

The Trigger Menu
Count Field (State only)

Time Time count places time tags on all displayed pretrigger and posttrigger data. Data stored before trigger has negative time numbers and data stored after trigger has positive time numbers. Time tag numbering is set to be either relative to the previous memory location or absolute from the trigger point. Selecting the Absolute or Relative option is done by toggling the Absolute/Relative field. Time tag resolution is 8 ns.

The screenshot shows a menu with the following elements:

- Buttons: Analyzer, Listing STATE MACH, Cancel, Group Run
- Buttons: Markers Pattern, Find X-pattern, 1, from Trigger, Specify Patterns
- Fields: Label>, DATA 1, Time, Base>, Hex, Absolute
- Table of memory locations:

Count	Label	DATA 1	Time
0		AA	0 s
1	X	AB	104 ns
2		AC	200 ns
3		AD	304 ns
4		AE	400 ns
5		AF	504 ns
6		B0	600 ns
7		B1	704 ns
8	0	B2	800 ns
9		B3	904 ns
10		B4	1.000 us
11		B5	1.104 us
12		B6	1.200 us
13		B7	1.304 us

Relative/Absolute Toggle Field

To Retain Full Memory Using Time or State Tags To retain the full memory depth when using time or state tags requires the unassigned of one pod pair. The exact pod pair to unassigned in all possible configurations varies. The table below shows the pod pairs to unassign in most applications.

One Configured Analyzer	Two Configured Analyzers
Pod Pair 3/4	Pod Pair 3/4
Pod Pair 3/4, 5/6	Pod Pair 3/4, 5/6



The Listing Menu

The Listing Menu

The Listing menu is a display menu for state and timing analyzer measurements. The listing is a display of data, address, and control status in memory at each clock cycle in a microprocessor-based system.

The acquired data is displayed in the order the analyzer placed the data into analyzer memory. Data is grouped and displayed by label and in a selectable numeric base. Labeled data from the other state analyzer can be interleaved into the same display.

Listing Menu Map

The menu map on the next page illustrates all fields and the available options in the Listing menu. The menu map will help you get an overview as well as provide you with a quick reference of what the Listing menu contains.

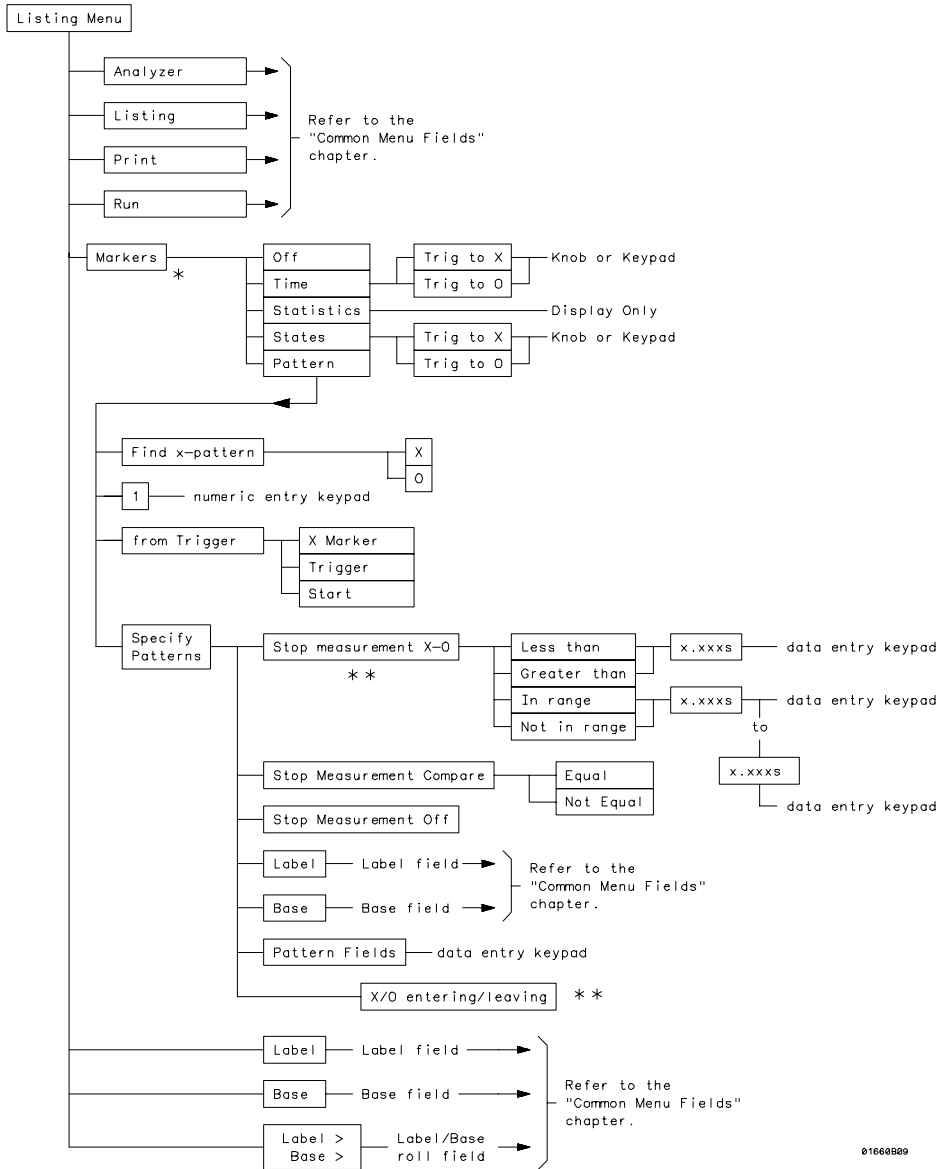

01668889

* Different marker types appear depending on analyzer configurations.
 ** Only available in Timing analyzer or State analyzer with Count set to Time.

Listing Menu Map

Markers Field

The Markers field is used to access the markers selection menu. When the Markers field is selected, a marker selection menu appears with the marker choices available with the present analyzer configuration.

State Analyzer Types

In a state analyzer with count Time and count State turned off in the Trigger menu, only Pattern markers are available. With count Time turned on, additional choices of Time markers and Statistics markers become available. With count States turned on, in addition to Pattern markers there are States markers available.

Timing Analyzer Types

If a timing analyzer you have marker choices of Pattern, Time, or Statistics.

Off

The Off selection turns off marker operations. If a stop measurement was previously specified, and the stop measurement criteria are met, the measurement will stop even though the markers are off.

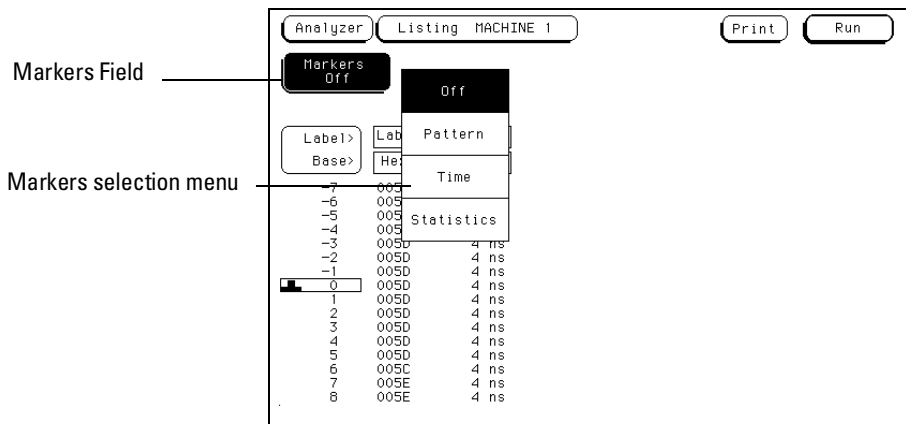

Markers Field

Pattern Markers

When Pattern markers are selected, two markers labeled X and O become available. Pattern markers identify and mark unique bit patterns in the data listing. Once the unique bit patterns are marked, they can be used as reference points or as criteria for a stop measurement.

The markers are graphically displayed by horizontal lines. In addition, both markers are labeled at the left end of the marker line.

When a marker is positioned in the Listing menu, it is also positioned in the Chart menu and Waveform menu.

See Also

"Specify Patterns Field" found later in this chapter for more information on creating a pattern for the X and O markers.



Find X-pattern / O-pattern Field

The Find X-pattern/O-pattern field is a toggle field. When you toggle the Find X-pattern/O-pattern fields, the functionality of the occurrence and trace start fields switch to the other marker. In addition, when the Find X-pattern/O-pattern field is toggled, the data listing will shift so the data marked will appear at center screen.

Find X-pattern field

Label>	STATE1	Time
Base>	Hex	Relative
218	0096	104 ns
219	0097	96 ns
220	0098	104 ns
221	0099	96 ns
222	009A	104 ns
223	009B	96 ns
224	009C	104 ns
225	009D	96 ns
226	009E	104 ns
227	009F	96 ns
228	00A0	104 ns
229	00A1	96 ns
230	00A2	104 ns
231	00A3	96 ns
232	00A4	104 ns
233	00A5	96 ns

X-pattern at center screen

Find X-pattern / O-pattern Field

Pattern Occurrence Fields

The X-pattern and O-pattern occurrence fields designate which pattern occurrence the marker is placed on. The occurrence field is set by highlighting the field, then turning the knob or entering a number from the front-panel keypad.

The reference point from which the occurrence counter starts is either the trigger point, the start of the trace, or in the case of the O-marker, the X-marker. If a negative occurrence number is set, the analyzer will search for pretrigger occurrences.

Pattern occurrence field

Label>	STATE1	Time
Base>	Hex	Relative
218	0096	104 ns
219	0097	96 ns
220	0098	104 ns
221	0099	96 ns
222	009A	104 ns
223	009B	96 ns
224	009C	104 ns
225	009D	96 ns
226	X 009E	104 ns
227	009F	96 ns
228	00A0	104 ns
229	00A1	96 ns
230	00A2	104 ns
231	O 00A3	96 ns
232	00A4	104 ns
233	00A5	96 ns

First occurrence of X pattern after

X-pattern and O-pattern Occurrence Fields

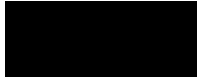

From Trigger / Start / X Marker Field

The from Trigger/Start/X marker field is used to access the selection pop-up for the start point of the X and O marker occurrence counters.

The start points available for the X-marker are either the trace start point or the trigger point. The start points available for the O-marker are the trace start point, trigger point, or the X-marker.

If the marker pattern can not be found, a message appears at the top of the display indicating the search failed. If the O-marker is referenced from the X marker, and the X-marker is not found, the search for both markers will fail.

Trigger / Start / X Marker field

Label>	STATE1	Time
Base>	Hex	Relative
218	0096	104 ns
219	0097	96 ns
220	0098	104 ns
221	0099	96 ns
222	009A	104 ns
223	009B	96 ns
224	009C	104 ns
225	009D	96 ns
226	X 009E	104 ns
227	009F	96 ns
228	00A0	104 ns
229	00A1	96 ns
230	00A2	104 ns
231	O 00A3	96 ns
232	00A4	104 ns
233	00A5	96 ns

First occurrence of X pattern after

Trigger / Start / X-Marker Field

Specify Patterns Field

The Specify Patterns field only appears when the markers are set to Pattern. When the Specify Patterns field is selected, a pop-up menu appears that is used to assign the bit patterns for the X and O markers, the X and O entering/leaving markers, and the stop measurement criteria.

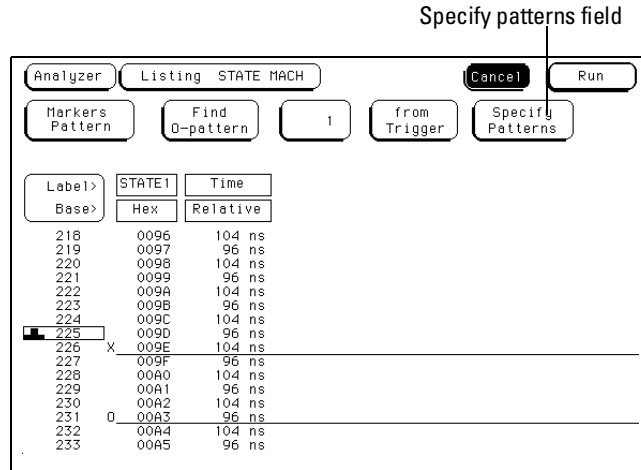

Specify Patterns Field



X and O entering / leaving Fields (Timing only)

If the analyzer is configured as Timing, the X and O pattern markers are placed at either the beginning of the pattern occurrence (entering) or at the end of the pattern occurrence (leaving). When the entering/leaving field of either X or O markers is selected, it toggles between the two choices.

Whichever choice you toggle the field to, the pattern you place in the pattern display field will apply to that choice.

X marker and O marker Fields (State only)

If the analyzer is configured as State, X marker and O marker fields replace the X and O entering/leaving fields. The pattern you place in the pattern display field will apply to the marker labeled at the left.

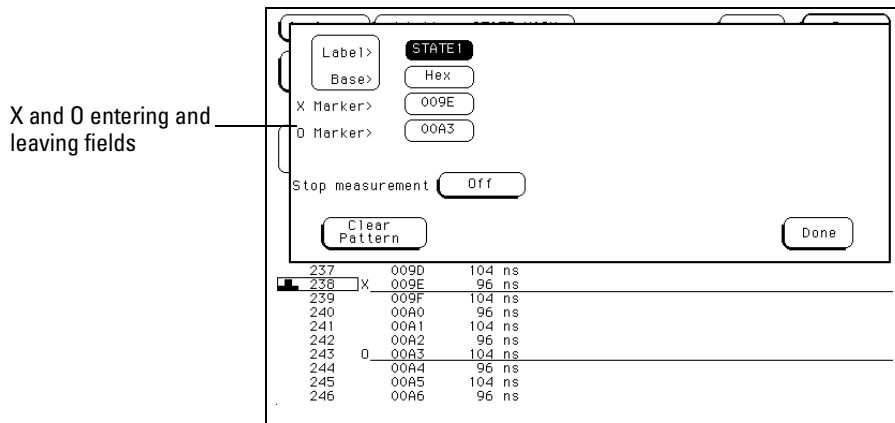

X and O entering / leaving Fields

Pattern Display Fields

The pattern display field displays the alphanumeric bit pattern specified for each X and O marker in all designated labels. The bit pattern is displayed in the same numeric base and same order as the data listing. When the pattern display field is highlighted, a bit pattern can be entered using the front-panel keypad.

When there are more labels assigned than can be displayed in a single screen, the pattern display fields are rolled back on screen by the Label / Base roll field.

See Also

"Label/Base Roll Field" in the Common Menu Fields chapter for a complete definition of the Label/Base roll field.

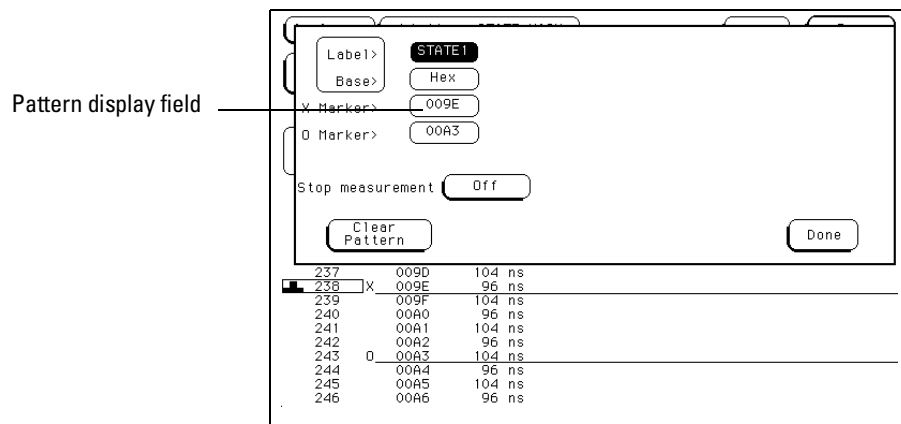

Pattern Display Field



Label and Base Fields

The Label and Base fields show up together in all menus except the Format and Configuration menus. When a new label is assigned, a base field is automatically assigned to that label.

Label Field Labels in the Specify Patterns menu are the same labels assigned in the Format menu. These labels will be displayed throughout the analyzer as they were assigned in the Format menu.

To reorder currently displayed Labels, select the label you want to move, then from the selection menu that appears, choose the label you want to switch positions with.

Base Field The function of the Base field is the same in all menus. A complete definition of the Base field appears in the Common Menu Fields chapter.

Label / Base Roll Field

The function of the Label and Base roll field is the same in all menus. A complete definition of the Label/Base roll function appears in the Common Menu Fields chapter.

See Also

"Label Assignment Field" in the Format menu chapter for a complete definition of label assignment and modification.

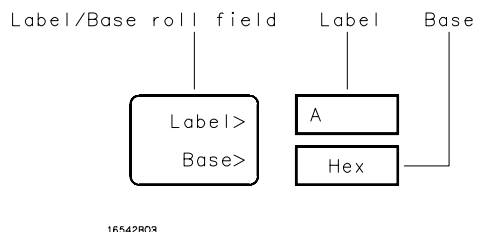

16542803

Label / Base Roll Field

Stop Measurement Field

The stop measurement function allows you to specify a condition which stops the analyzer measurement during a repetitive run. If two analyzers are configured, both analyzers stop when either specified stop condition is satisfied.

When the Stop measurement field is selected, a stop measurement type menu appears. Depending on the analyzer configuration, you have the choices of Off, X-O, and Compare.

Off

The Off selection turns all Stop measurement operations off.

If the stop measurement operation is not turned off and the stop measurement criteria are met, the measurement will stop even though the markers are set to other types or turned off.

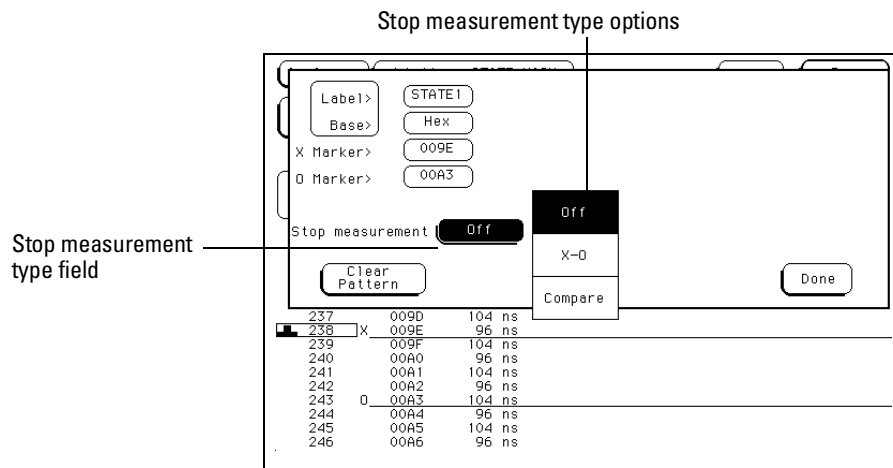

Stop Measurement Field

The Listing Menu
Stop Measurement Field

X-O

The X-O option is available in the Timing analyzer and in the State analyzer with its count set to Time.

When X-O is selected, a repetitive run is stopped when a comparison of the time period between the X and O markers and one of the following time period options is true:

Less Than X-O time must be less than the time value that you specify in the Time field.

Greater Than X-O time must be greater than the time value that you specify in the Time field.

In Range X-O pattern must be within the time range value that you specify in the two Time fields.

Not in Range X-O pattern must not be within the time range value that you specify in the two Time fields.

X to O type field X to O type options

237	009D	104 ns
238	X 009E	96 ns
239	009F	104 ns
240	00A0	96 ns
241	00A1	104 ns
242	00A2	96 ns
243	O 00A3	104 ns
244	00A4	96 ns
245	00A5	104 ns
246	00A6	96 ns

X-O Field

Compare

When you select Compare, a repetitive run is stopped when a comparison of data in the Listing menu and data and criteria in the Reference listing of the Compare menu matches an equality selection. The equality selection is set from the Equal/Not Equal selection pop-up menu.

Equal The data and compare criteria in the Compare menu must be equal to the data in the Listing menu.

Not Equal The data and compare criteria in the Compare menu must not be equal to the data in the Listing menu.

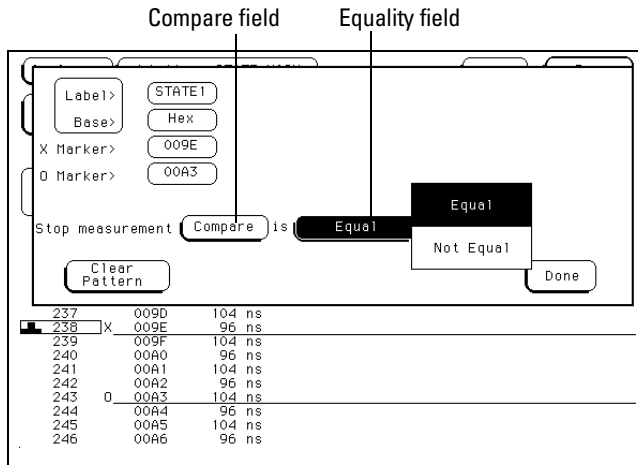

Equal / Not Equal Selection Menu

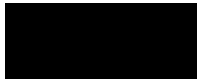

Clear Pattern Field

The Clear Pattern field is used to reset the X and O Marker pattern display fields back to default (don't care = X). The Clear Pattern field accesses a selection menu with the choices of All (displays X &) patterns for 1664A), X-pattern, or O-pattern.

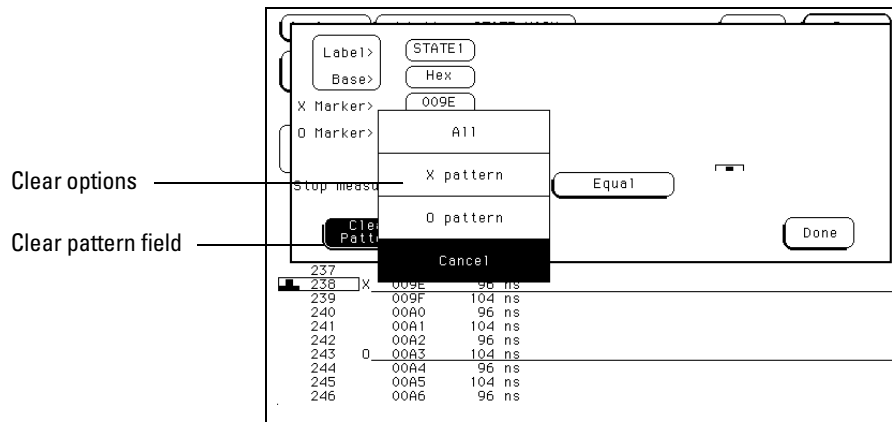

Clear Pattern

Time Markers

Time markers are indicators located in the data listing that are used as reference marks to obtain time values between each marker, or between each marker and the trigger point.

In a State analyzer, Time markers only become available when the Count field in the Trigger menu is set to Time.

The markers are graphically displayed by horizontal lines. In addition, both markers are labeled at the left end of the marker line.

If Pattern markers have been assigned, the Time markers will be initially placed at the same locations in the data listing.

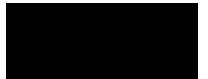

Trig to X / Trig to O Fields

The Trig to X and Trig to O fields are both display fields as well as configuration fields. The Trig to X and Trig to O fields display the time between the trigger point and the markers.

Marker position is set by selecting the desired field and entering a value using the front-panel keypad. The units are set by turning the knob when the assignment pop-up is open. Marker position can also be set by simply turning the knob when the roll indicator is present.

X to O Display Field

The X to O display field is a "read only" field that displays the time between the X and O markers. As the X and O markers are changed, the display changes accordingly.

Trig to X field

Label>	STATE1	Time
Base>	Hex	Relative
231	0097	104 ns
232	0098	96 ns
233	0099	104 ns
234	009A	96 ns
235	009B	104 ns
236	009C	96 ns
237	009D	104 ns
238	009E	96 ns
239	009F	104 ns
240	00A0	96 ns
241	00A1	104 ns
242	00A2	96 ns
243	00A3	104 ns
244	00A4	96 ns
245	00A5	104 ns
246	00A6	96 ns

Trig to X / Trig to O Fields

Statistics Markers

After patterns are assigned to the X and O markers, statistical information is available when markers are set to Statistics. The logic analyzer displays the following information:

- Number of valid runs (runs where Pattern markers were able to be placed on specified patterns).
- Minimum time between the X and O Pattern markers.
- Maximum time between the X and O Pattern markers.
- Average time between the X and O Pattern markers.

In a State analyzer, Statistics markers only become available when the Count field, in the Trigger menu, is set to Time.

The markers are graphically displayed by horizontal lines. In addition, both markers are labeled at the left end of the marker line.

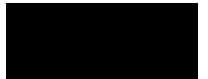

The Listing Menu Trig to X / Trig to O Fields

Statistics are based on the time between the X and O. Both markers must be found before valid statistical information is displayed.

In repetitive run mode, the display is updated each time a valid run occurs until you select Stop. If you select Run after Stop, the statistics continue to update without loss of information.

In single run mode, each time you select Run an additional valid run will be added to the data and the statistics will be updated. This process continues unless you change the placement of the X and O Pattern markers between runs.

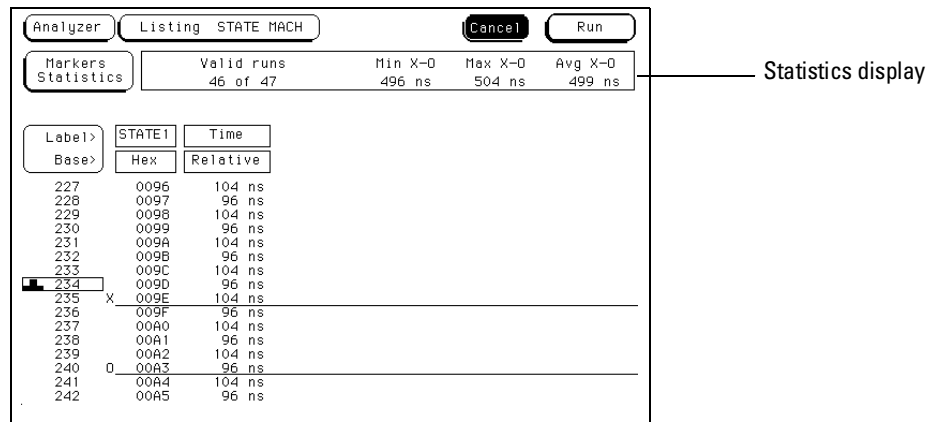

The screenshot shows the 'Analyzer' window with the 'Listing' menu open for 'STATE MACH'. The 'Statistics' tab is selected, displaying the following summary:

Valid runs	Min X-O	Max X-O	Avg X-O
46 of 47	496 ns	504 ns	499 ns

Below the statistics is a table of data points:

Label	STATE1	Time
Base	Hex	Relative
227	0096	104 ns
228	0097	96 ns
229	0098	104 ns
230	0099	96 ns
231	009A	104 ns
232	009B	96 ns
233	009C	104 ns
234	009D	96 ns
235	009E	104 ns
236	009F	96 ns
237	00A0	104 ns
238	00A1	96 ns
239	00A2	104 ns
240	00A3	96 ns
241	00A4	104 ns
242	00A5	96 ns

An arrow points from the text 'Statistics display' to the statistics summary area.

Statistics Display

States Markers (State only)

States markers are indicators located in the data listing that are used as reference marks to obtain the number of states between each marker, or between each marker and the trigger point.

States markers are only available in a state analyzer with the Count field set to State in the Trigger menus.

The markers are graphically displayed by horizontal lines. In addition, both markers are labeled at the left end of the marker line.

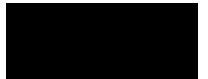

Trig to X / Trig to O Fields

The Trig to X and Trig to O fields are both display fields as well as configuration fields. The Trig to X and Trig to O fields display the number of states between the trigger point and the marker.

Marker position is set by selecting the desired field and entering a value using the front-panel keypad. Marker position can also be set by simply turning the knob when the roll indicator is present.

X to O Display Field

The X to O display field is a "read only" field that displays the number of states between the X and O Pattern markers. As the X and O markers are changed, the display changes accordingly.

Trig to X field

The screenshot shows a configuration window titled "Trig to X field". At the top, there are buttons for "Analyzer", "Listing STATE MACH", "Cancel", and "Run". Below these are three display fields: "Markers States", "Trig to X 0", and "Trig to O 0". To the right of these fields is a label "X to O display" with a line pointing to the "X to O 0" field. Below the fields is a table with columns "Label>", "STATE1", and "States". The table lists states from 227 to 242. State 234 is highlighted with a black bar. State 235 has an "X" marker, and state 240 has an "O" marker.

Label>	STATE1	States
Base>	Hex	Relative
227	0096	
228	0097	
229	0098	
230	0099	
231	009A	
232	009B	
233	009C	
234	009D	
235	009E	X
236	009F	
237	00A0	
238	00A1	
239	00A2	
240	00A3	O
241	00A4	
242	00A5	

Trig to X / Trig to O Fields

Data Roll Field

The column of numbers at the far left represents the location of the acquired data in the state analyzer's memory. The numbered positions are also known as the state locations and are relative to the trigger state location.

The column of state locations along with its data can be rolled to display offscreen data by using the data roll field. The data roll field is the small rectangular box located in the middle of the state location column.

The data roll field is used to either roll the data listing or to select an exact state for display. When the data roll field is selected, the knob is active and can roll data in either direction. You can also roll the listing by highlighting the data roll field and entering a specific location number using the front-panel keypad.

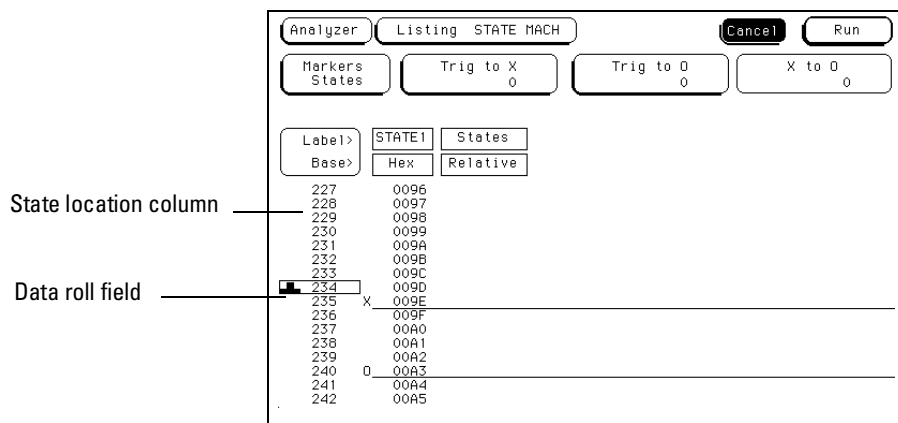

Data Roll Field



Label and Base Fields

The Label and Base fields show up together in all menus except the Format and Configuration menus. When a new label is assigned, a base field is automatically assigned to that label.

Label Field

Labels in the Listing menu are the same labels assigned in the Format menu. These labels will be displayed throughout the analyzer as they were assigned in the Format menu. A complete definition of label assignment and modification appears in the Format menu chapter.

Base Field

The function of the Base field is the same in all menus. A complete definition of the Base field appears in the Common Menu Fields chapter.

Label / Base Roll Field

The function of the Label and Base roll field is the same in all menus. A complete definition of the Label/Base roll function appears in the Common Menu Fields chapter.

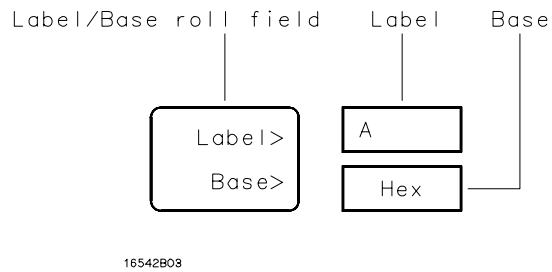

Label / Base Roll Field

System / Analyzer Field

The function of the System/Analyzer field is the same in all menus. For a complete definition of the System/Analyzer field, go to "The Common Menu Fields" chapter at the beginning of the Analyzer part of this User's Reference.

Menu Field

The function of the Menu field is the same in all menus. For a complete definition of the Menu field, go to "The Common Menu Fields" chapter at the beginning of the Analyzer part of this User's Reference.

Print Field

The function of the Print field is the same in all menus. For a complete definition of the Print field, go to "The Common Menu Fields" chapter at the beginning of the Analyzer part of this User's Reference.

Run Field

The function of the Run field is the same in all menus. For a complete definition of the Run field, go to "The Common Menu Fields" chapter.

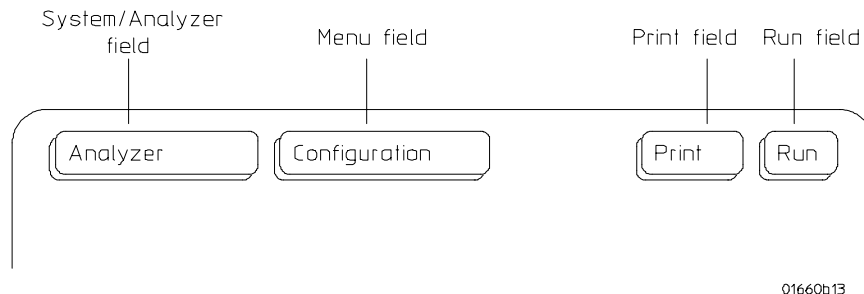

Common Menu Fields



The Waveform Menu



The Waveform Menu

The Waveform menu is one of the analyzer display menus. You use the Waveform menu to view either state or timing data in a format similar to an oscilloscope display. Data is displayed with the horizontal axis representing either states or time, and the vertical axis representing logic highs and lows. The type of data displayed depends on whether the Type field in the Configuration menu is set to State or Timing.

If State is selected, the analyzer displays state relevant activity in reference to the trigger point with the horizontal resolution being states per division.

If Timing is selected, the analyzer displays time relevant activity in reference to the trigger point with the horizontal resolution being time per division.

Waveform Menu Map

The following menu map illustrates all fields and the available options in the Waveform menu. The menu map will help you get an overview as well as provide you with a quick reference of what the Waveform menu contains.



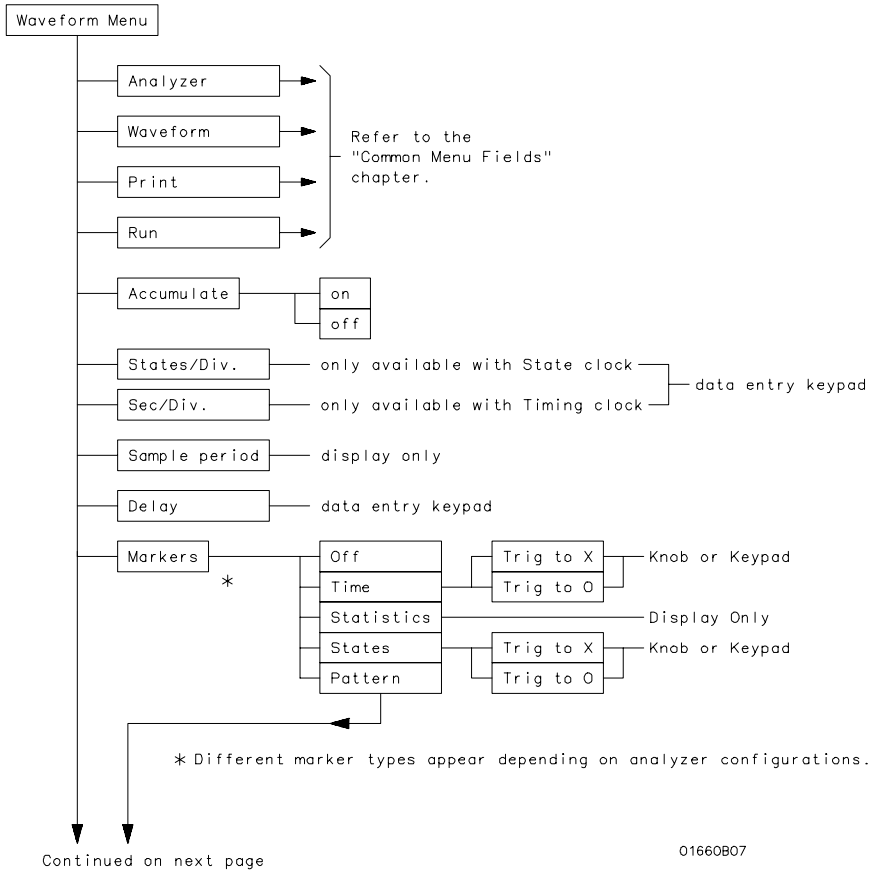

Waveform Menu Map



The Waveform Menu

Continued from previous page

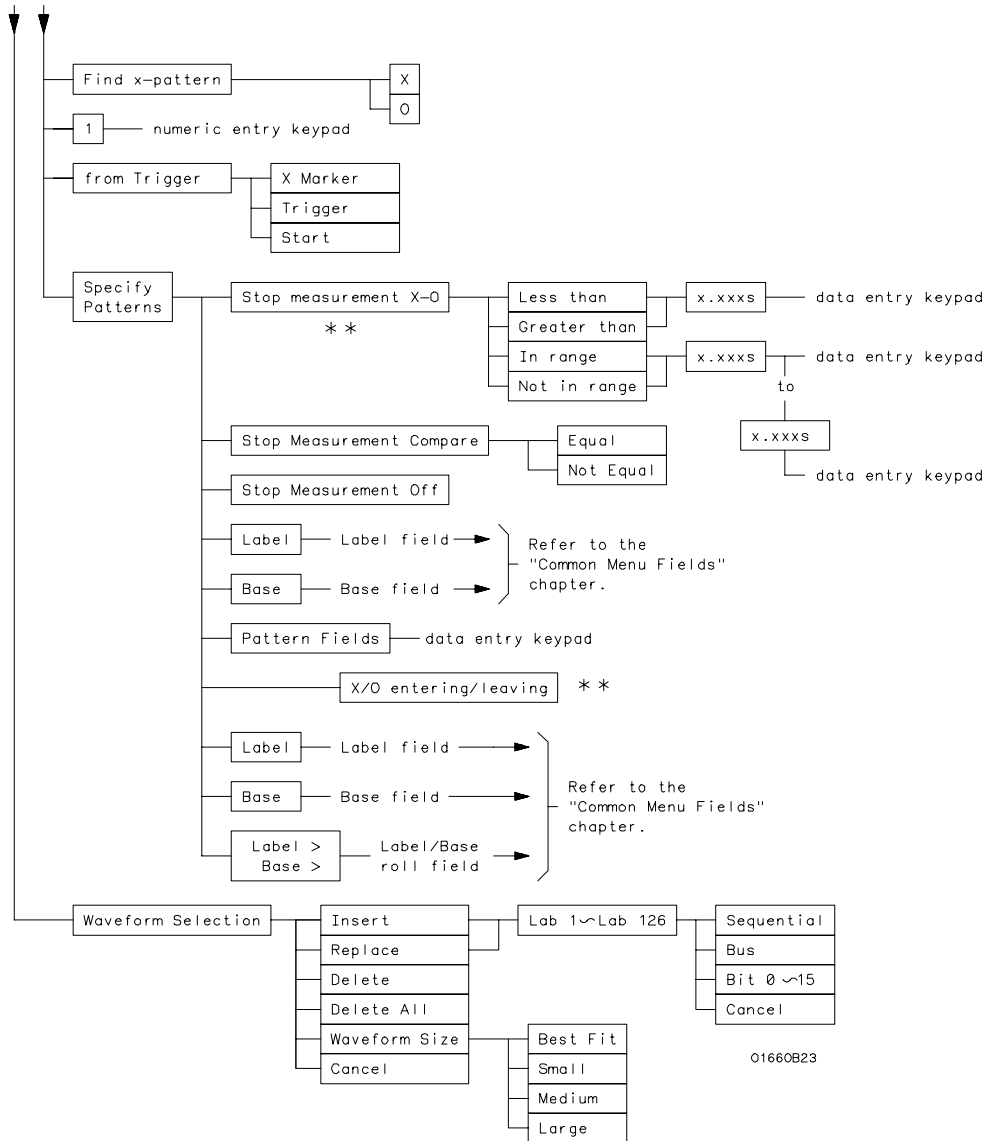

** Only available in Timing analyzer or State analyzer with Count set to Time.

Waveform Menu Map (cont.)

Acquisition Control Field

The function of the Acquisition Control field in the Waveform menu is the same as in the Trigger menu. Refer to the "Acquisition Control Field" in the Trigger menu for complete details.

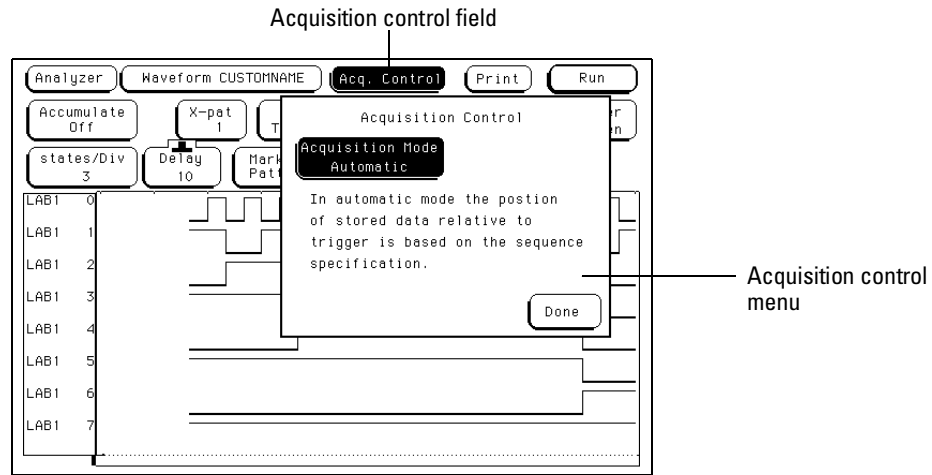

Acquisition Control field



Accumulate Field

The Accumulate field controls whether old data is cleared or displayed along with new data. The Accumulate field will toggle On/Off. When Accumulate is on, the analyzer displays the data from a current acquisition on top of the previously acquired data. When Accumulate is off, the display is cleared before each new run cycle.

If you leave the Waveform menu, or pop up a menu over the waveform display, any accumulated display data is lost and the accumulation process starts over.

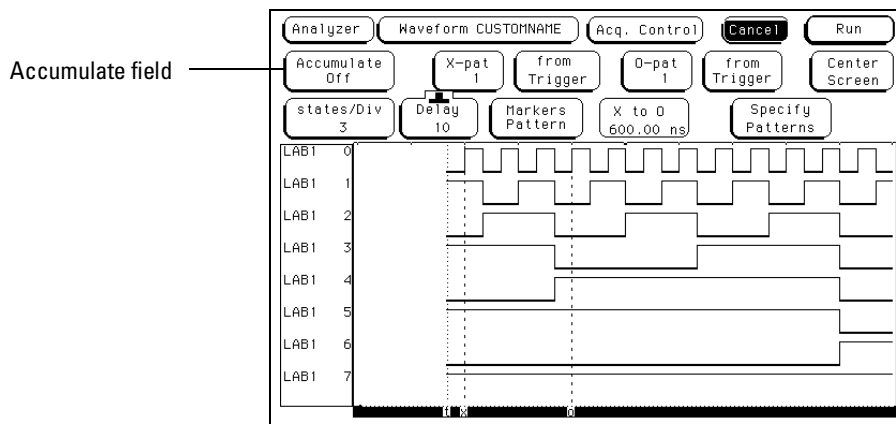

Accumulate Field

States Per Division Field (State only)

When the analyzer Type field in the Configuration menu is set to State, the analyzer uses external clocks from the system under test. In this mode, the X-axis of the waveform display is measured in states per division.

You use the states/Div field to select the states per division resolution of the X-axis. You can specify between 1 and 500 states per division by selecting the states/Div field and rotating the knob, or by highlighting the field and entering a value from the front-panel keypad. By adjusting the states/Div, you can zoom in to view a desired part of the display.

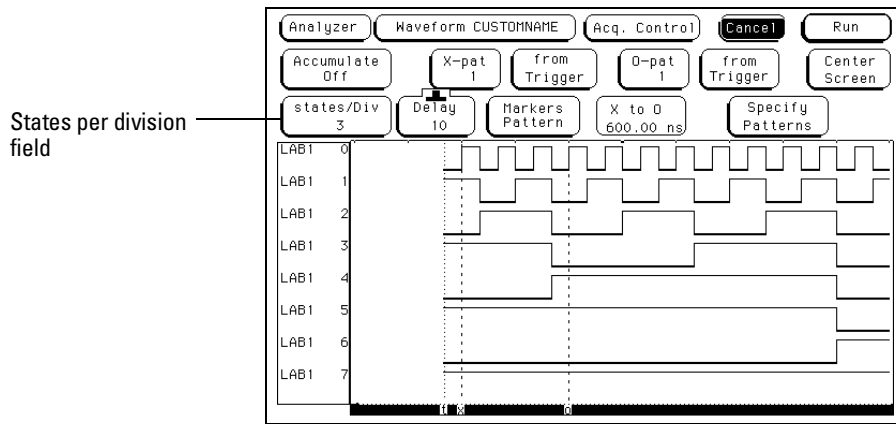

States Per Division Field



Seconds Per Division Field (Timing only)

When the analyzer Type field in the Configuration menu is set to Timing, the analyzer uses its own internal clock. In this mode, the X-axis of the waveform display is measured in seconds per division.

You use the sec/Div field to select the seconds per division resolution of the X-axis. The range of the sec/Div field is 1 ns/Div to 1.0 ks/Div. You set the sec/Div field by either selecting the sec/Div field and rotating the knob, or by highlighting the sec/Div field and entering a value using the front-panel keypad.

When using the knob to set the sec/Div, the value will change in a 1-2-5 sequence. By adjusting the sec/Div, you can zoom in to view a desired part of the display.

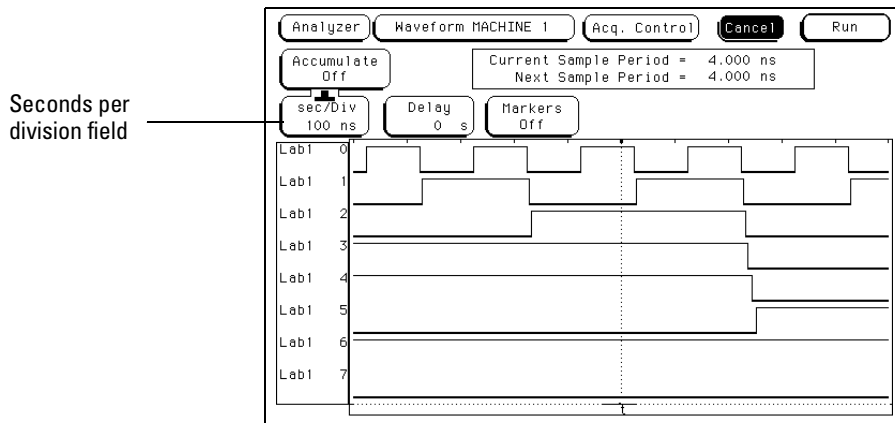

Seconds Per Division Field

Delay Field

Depending on the analyzer configuration, a positive or negative delay measured in either states or time can be set. The Delay field allows you to scroll the data and place the display window at center screen. Changing the delay will not effect the data acquisition unless it is a timing analyzer and the acquisition mode is automatic.

The delay range of a timing analyzer is from -2500 seconds to $+2500$ seconds. The delay range of a state analyzer is from -8192 states to $+8192$ states.

If you want to move the display window to view data located off screen to the right, enter a positive delay. If you want to move the display window to view data located off screen to the left, enter a negative delay.

You can enter a delay by highlighting the Delay field, then turning the knob. You can also enter a delay by selecting the Delay field, then enter a value from the front-panel keypad.

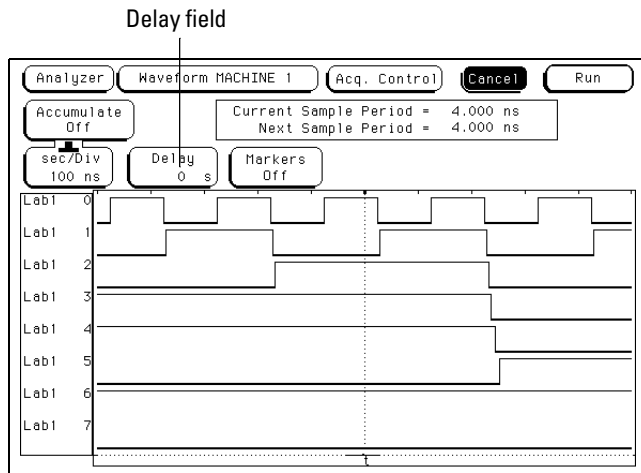

Delay Field



Sample Period Display (Timing only)

The sample period display only appears in a timing analyzer. A sample period is the interval of time between new data samples. Every time a new measurement is taken, the analyzer updates the display.

The Current Sample period display is the sample period used for the last acquisition. The Next Sample period is the new sample period to be used at the next acquisition. If the acquisition mode is set to automatic, changing the sec/Div or delay will affect the sample period.

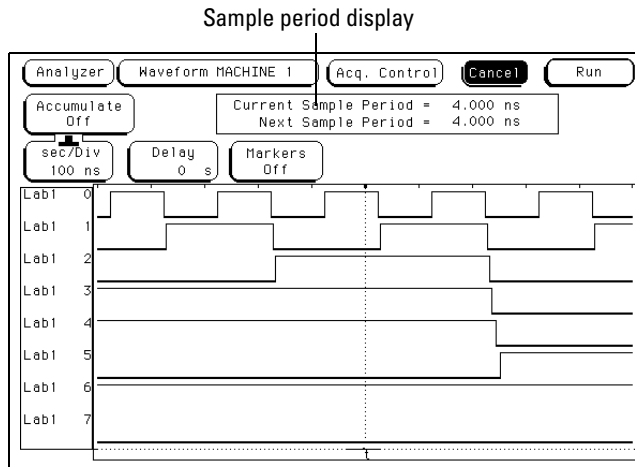

Sample Period Display

Timing waveforms are reconstructed relevant to the sample period. The shorter sample period puts more sample points on the waveform for a more accurate reconstruction but also fills memory more quickly.

If the sec/Div is changed resulting in a change in the next sample period, you must run the analyzer again before the current sample period display is updated.

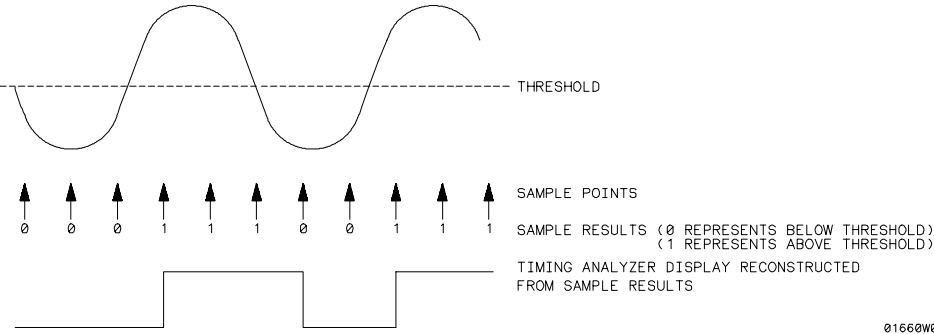

Sample Points



Markers Field

The Markers field is used to access the markers selection menu. When the Markers field is selected, a marker selection menu appears with the marker choices available under the present analyzer configuration.

State Analyzer Types

In a state analyzer with count turned off in the Trigger menu, only Pattern markers are available. With count Time turned on, additional choices of Time markers and Statistics markers become available. With count States turned on, in addition to Pattern markers, States markers are available.

Timing Analyzer Types

In a timing analyzer you have marker choices of Off, Pattern, Time, or Statistics.

Off

The Off selection turns marker operations off. If a Stop measurement was previously specified and the Stop measurement criteria are met, the measurement will stop even though the markers are off.

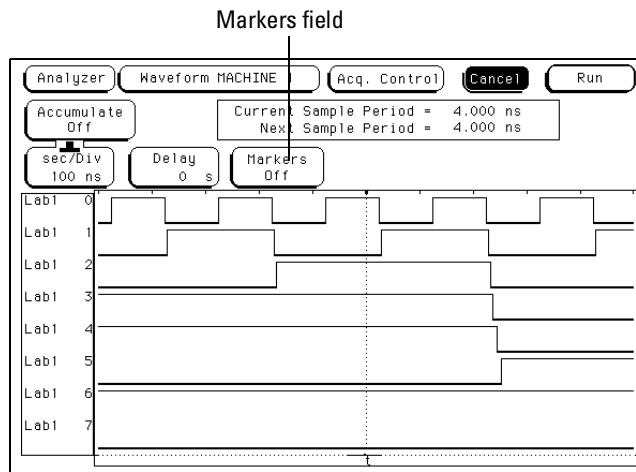

Markers Field

Pattern Markers

When Pattern markers are selected, two markers labeled X and O become available. Pattern markers identify and mark unique bit patterns in the waveform display. Once the unique bit patterns are marked, they can be used as reference points or as criteria for a stop measurement.

The markers are graphically accented in the display by dashed lines. In addition, both markers are labeled at the bottom of the display in the Display Location Reference Line.

When a marker is positioned in the waveform display, it is also positioned in the chart display and data listing.

See Also

"Specify Patterns Field" later in this chapter for information on creating a pattern for the X and O markers.

"Display Location Reference Line" later in this chapter.

X-pat / O-pat Occurrence Fields

The X-pat/O-pat occurrence fields designate which pattern occurrence the marker is placed on. The occurrence field is set by first highlighting the field, then turning the knob or entering a number from the front-panel keypad.

The reference point from which the occurrence counter starts is the trigger point, the start of the trace, or, in the case of the O-marker, the X-marker. If a negative number is set, the analyzer will search for pre-trigger occurrences.

Pattern occurrence fields

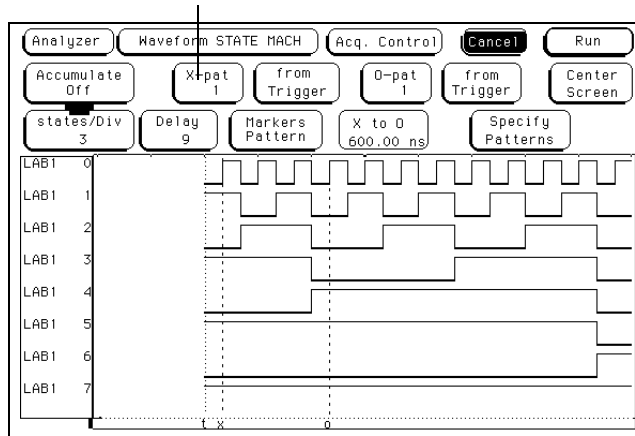

X-pattern and O-pattern Occurrence Fields

From Trigger / Start / X Marker Field

The from Trigger/Start/X marker field is used to access the selection pop-up for the start point of the X and O marker occurrence counters.

The start points available for the X-marker are either the trace start point or the trigger point.

The start points available for the O-marker are either the trace start point, trigger point, or the X-marker.

If the marker pattern can not be found, a message appears at the top of the display indicating the search failed. If the O-marker is referenced from the X marker, and the X-marker is not found, the search for both markers will fail.

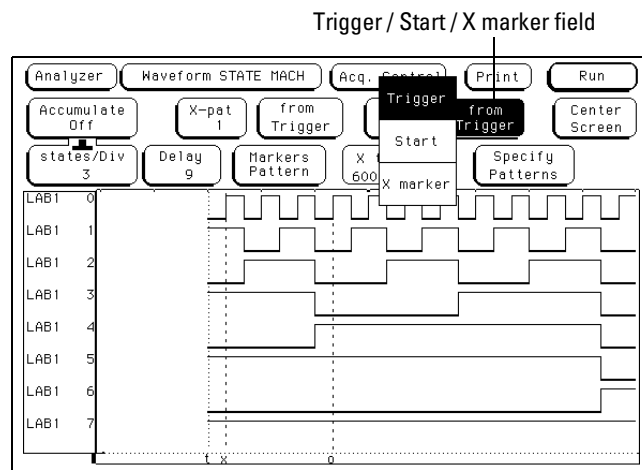

Trigger / Start / X Marker Field



X to O Display Field (Timing only)

The X to O display field only appears when the analyzer is configured as Timing. The X to O display field shows the time between the X and O markers.

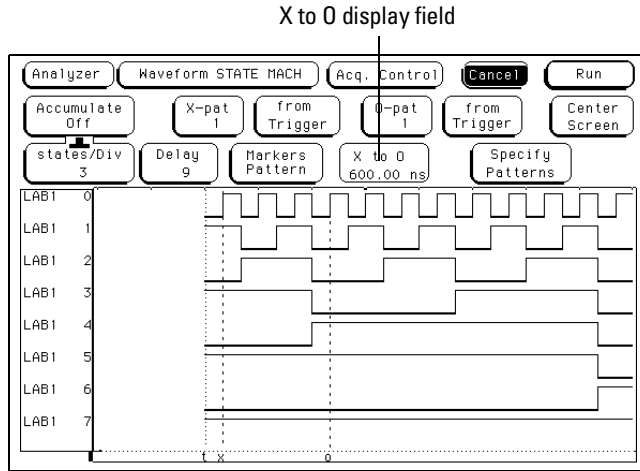

X to O Display Field

Center Screen Field

The Center Screen field accessed a menu which allows you to position the marked points of the waveform display relative to the center of the waveform display.

About Trigger The About Trigger selection is the default position. This choice will position the point of the waveform where the trigger occurred, at center screen.

About X Marker This choice adjusts the delay to position the point of the waveform where the X-marker is placed, at center screen.

About O Marker This choice adjusts the delay to position the point of the waveform where the O-marker is placed, at center screen.

About X & O This choice adjusts the sec/Div to allow both X and O markers to be displayed simultaneously.

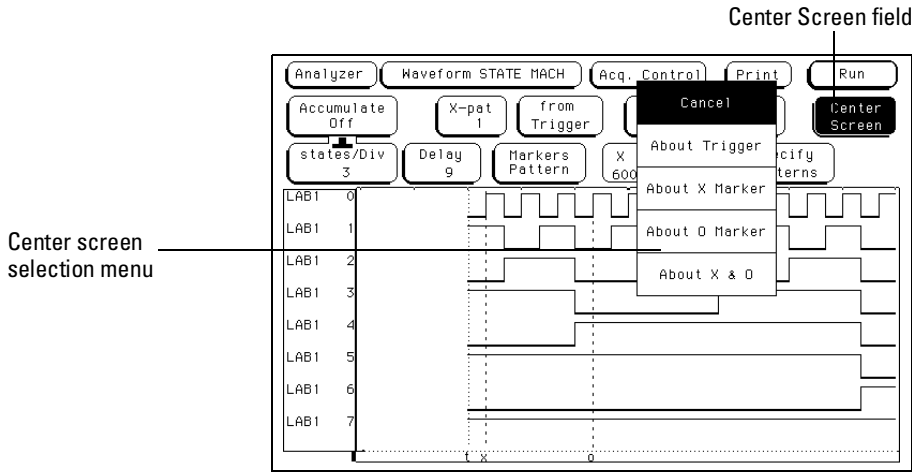

Center Screen Field



Specify Patterns Field

The Specify Patterns field only appears when the markers are set to Pattern. When the Specify Patterns field is selected, a pop-up menu appears that is used to assign the bit patterns for the X and O markers, the X and O entering/leaving, and the stop measurement criteria.

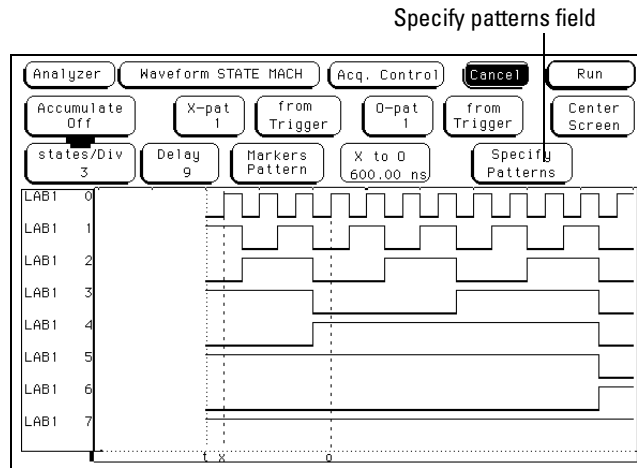

Specify Patterns Field

X and O entering / leaving Fields (Timing only)

If the analyzer is configured as Timing, the X and O pattern markers are placed at either the beginning of the pattern occurrence (entering) or at the end of the pattern occurrence (leaving). When the entering/leaving field of either X or O markers is selected, it will toggle between the two choices.

Whichever choice you toggle the field to, the pattern you place in the pattern display field will apply to that choice.

X-marker and O-marker Fields (State only)

If the analyzer is configured as State, X-marker and O-marker fields replace the X and O entering/leaving fields. The pattern you place in the pattern display field will apply to the marker labeled at the left.

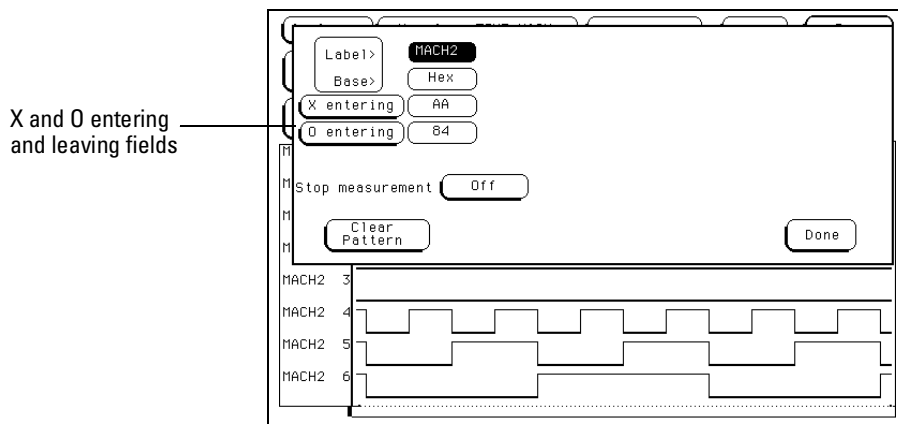

Specify Patterns Menu



Pattern Display Fields

The pattern display field displays the alpha-numeric bit pattern specified for each X and O marker in all designated labels. The bit pattern is displayed in the same numeric base and same order as the data listing. When the pattern display field is highlighted, the front-panel keypad is used to set the bit pattern.

When there are more labels assigned than can be displayed in a single screen, the pattern display fields are rolled back on screen by the Label/Base roll field.

See Also

"Label/Base Roll Field" in the Common Menu Fields chapter for a complete definition of the Label and Base roll function.

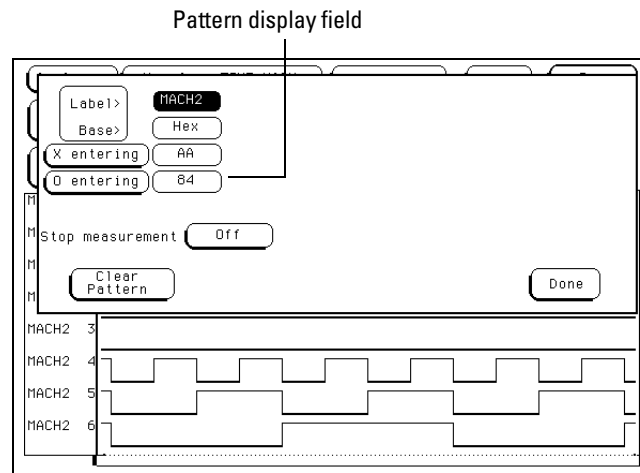

Specify Pattern Menu

Label and Base Fields

The Label and Base fields show up together in all menus except the Format and Configuration menus. When a new label is assigned, a base field is automatically assigned to that label.

Label Field Labels in the Specify Patterns menu are the same labels assigned in the Format menu. These labels will be displayed throughout the analyzer as they were assigned in the Format menu.

See Also

"Label Assignment Field" in the Format menu chapter for a complete definition of label assignment and modification.

To reorder currently displayed Labels, select the label you want to move, then from the selection menu that appears, choose the label you want to switch positions with.

Base Field The function of the Base field is the same in all menus. For a complete definition of the Base field, refer to "Base field" in the Common Menu Fields chapter.

Label / Base Roll Field

The function of the Label and Base roll field is the same in all menus. For a complete definition of the Label/Base roll function, refer to "Label/Base Roll Field in the Common Menu Fields chapter.

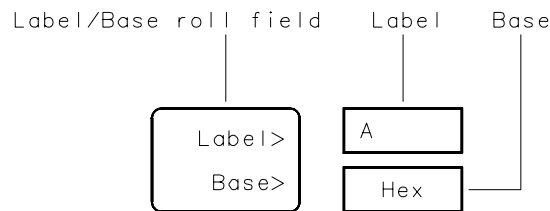

16542B03

Label / Base Roll Field



Stop Measurement Field

The stop measurement function allows you to specify a condition which stops the analyzer measurement during a repetitive run.

When the stop measurement field is selected, a stop measurement type menu appears. Depending on the analyzer configuration, you have choices of Off, X-O, and Compare.

Off

The Off selection turns off all stop measurement operations.

If the stop measurement operation is not turned off and the stop measurement criteria are met, the measurement will stop even though the markers are set to other types or are turned off.

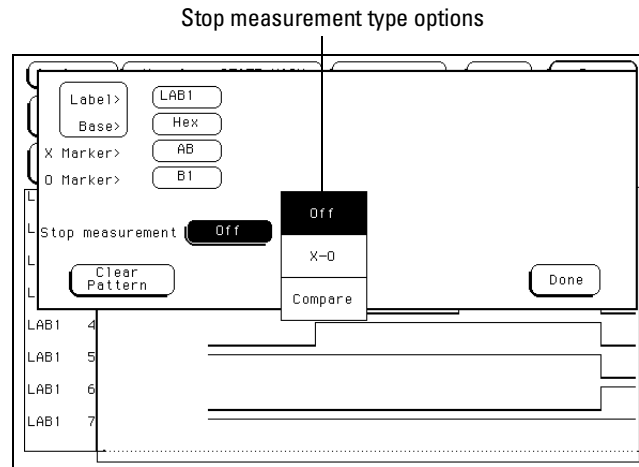

Stop Measurement Field

X-O

The X-O option is available in the Timing analyzer and in the State analyzer with its count set to Time.

When X-O is selected, a repetitive run is stopped when a comparison of the time period between the X and O markers and one of the following time period options is true:

Less Than X-O time must be less than the time value that you specify in the Time field.

Greater Than X-O time must be greater than the time value that you specify in the Time field.

In Range X-O pattern must be within the time range value that you specify in the two Time fields.

Not in Range X-O pattern must not be within the time range value that you specify in the two Time fields.

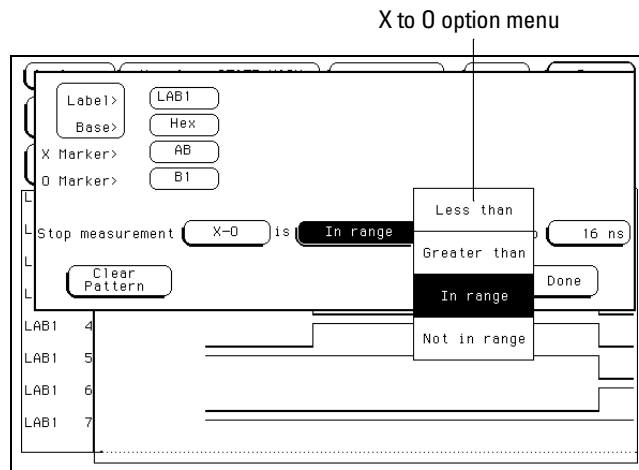

X-O Field



The Waveform Menu Stop Measurement Field

Compare

When Compare is selected, a repetitive run will be stopped when a comparison of data in the Listing menu and data and criteria in a compare image matches an equality selection. The equality selection is set from the Equal/Not Equal selection pop-up menu.

Equal The data and compare criteria in the Compare menu must be equal to the data in the Listing menu.

Not Equal The data and compare criteria in the Compare menu must not be equal to the data in the Listing menu.

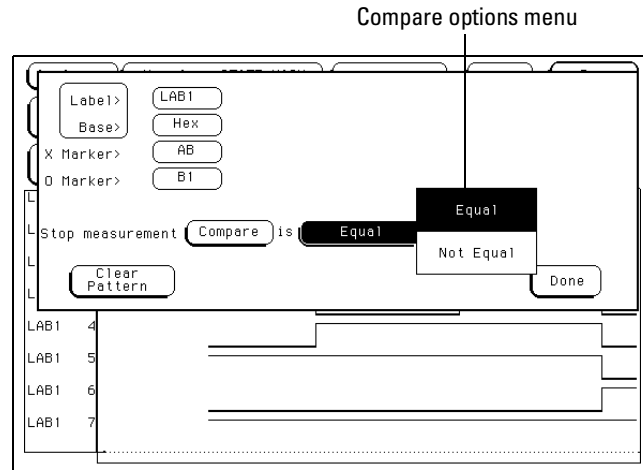

Equal / Not Equal Selection Menu

Clear Pattern Field

The Clear Pattern field is used to reset the X and O Marker pattern display fields back to default (don't care = X). The Clear Pattern field accesses a selection menu with the choices of All (displays X & O patterns for the 1664A), X-pattern, or O-pattern.

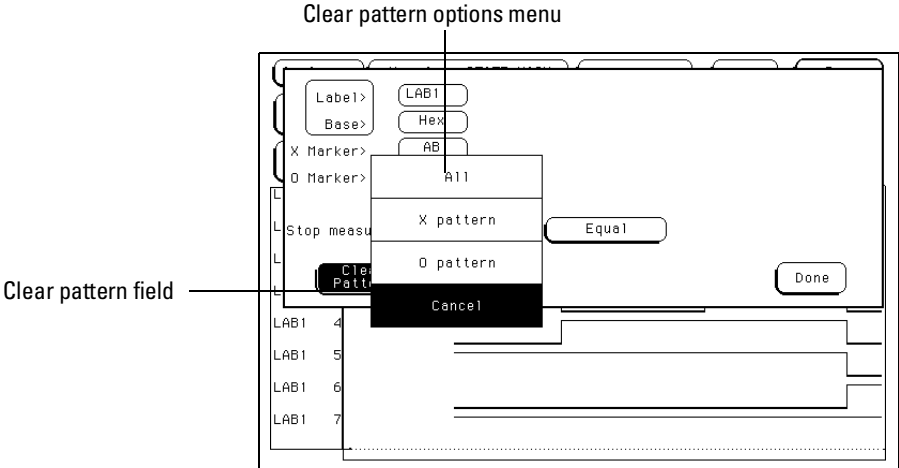

Clear Pattern



Time Markers

Time markers are indicators located in the waveform display that are used as reference marks to obtain time values between each marker, or between each marker and the trigger point.

In a State analyzer, Time markers only become available when the Count field in the Trigger menu is set to Time.

The markers are graphically accented in the display by dashed lines. In addition, both markers are labeled at the bottom of the display in the Display Location Reference Line.

If Pattern markers are assigned, the Time markers are initially placed at the same locations in the data listing.

Trig to X / Trig to O Fields

The Trig to X and Trig to O fields display the time between the trigger point and the marker. They are also used to position the markers with reference to the vertical dashed trigger line.

Marker position is set by first selecting the Trig to X and Trig to O fields, then rotating the knob. In addition, values can be entered by highlighting the field, then entering a value from the front-panel keypad.

X to O Field

In a State analyzer configuration, the X to O field is a "read only" field that displays the difference between the X and O markers. As the X and O markers are changed, the display changes accordingly.

In a Timing analyzer configuration, the X to O field can be set. If this field is changed, both X and O markers will move simultaneously with the relative difference remaining unchanged.

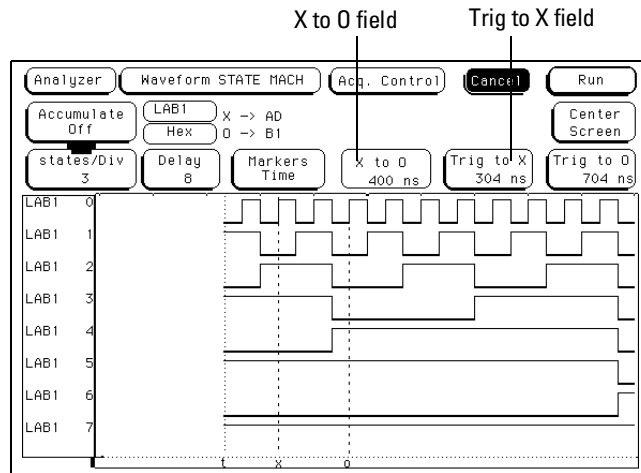

Trig to X / Trig to O Fields



Marker Label / Base and Display

The label field displays the label name for which the X and O marker values are assigned. To display other labels, select the label field and choose the new label from the selection menu that appears. Only preassigned labels are available in the label selection menu.

The base field underneath the label field displays the numeric base the marker values are displayed in. To change the numeric base, select the base field, then choose the desired base from the selection menu.

Data patterns where the markers are currently placed, appear next to the appropriate marker.

See also

"Label Assignment Fields" in the Format menu chapter for information on assigning labels.

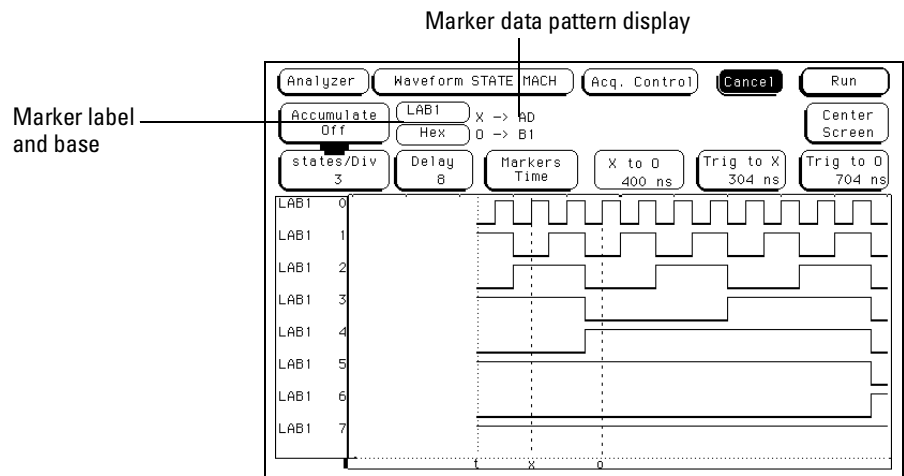

Marker Label / Base and Display

Statistics Markers

After patterns are assigned to the X and O markers, statistical information is available when markers are set to statistics. The logic analyzer displays the following information:

- Number of valid runs (runs where Pattern markers were placed on specified patterns).
- Minimum time between the X and O Pattern markers.
- Maximum time between the X and O Pattern markers.
- Average time between the X and O Pattern markers.

In a State analyzer, Statistics markers only become available when the Count field is set to Time in the Trigger menu.

The markers are graphically accented in the display by dashed lines. In addition, both markers are labeled at the bottom of the display in the Display Location Reference Line.



The Waveform Menu Marker Label / Base and Display

Statistics are based on the time between the X and O. Both markers must be found before valid statistical information is displayed.

In repetitive run mode, the display is updated each time a valid run occurs until you press Stop. If you press Run after Stop, the statistics continue to update without loss of information.

In single run mode, each time you press Run an additional valid run will be added to the data and the statistics will be updated. This process continues unless you change the placement of the X and O Pattern markers between runs.

Reset Statistics

All statistical information can be cleared at any time by selecting the Reset Statistics field. Statistics are also cleared any time the patterns assigned to the X and O markers are changed.

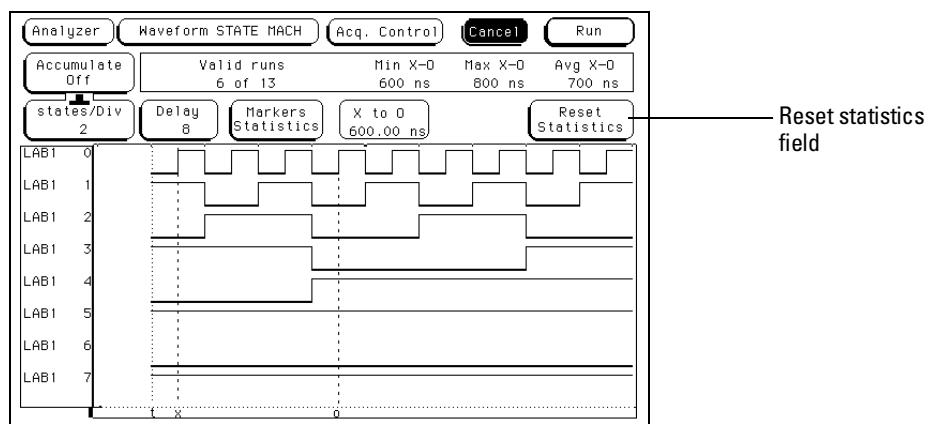

Statistics Display

States Markers (State only)

States markers are indicators located in the waveform display that are used as reference marks to obtain the number of states between each marker, or between each marker and the trigger point.

State markers are only available in a State analyzer with the Count field, in the Trigger menu, set to States.

The markers are graphically accented in the display by dashed lines. In addition, both markers are labeled at the bottom of the display in the Display Location Reference Line.



Trig to X / Trig to O Fields

The Trig to X and Trig to O fields display the time between the trigger point and the marker. They are also used to position the markers with reference to the dashed trigger line.

Marker position is set by first highlighting the Trig to X and Trig to O fields, then rotating the knob. In addition, values can be entered by highlighting the field, then entering a value from the front-panel keypad.

X to O Display Field

The X to O display field is a "read only" field that displays the number of states between the X and O markers. As the X and O markers are changed, the display changes accordingly.

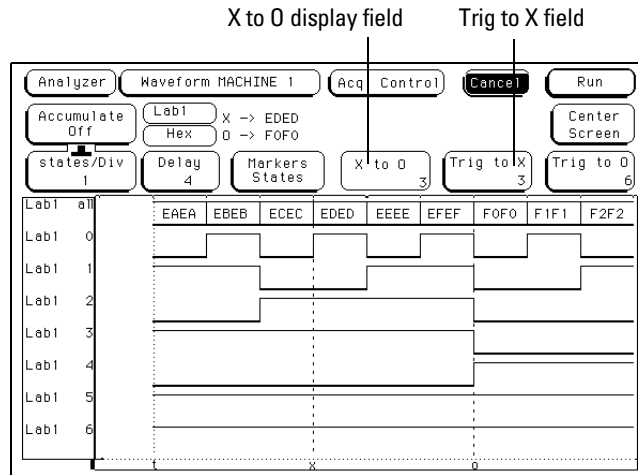

Trig to X / Trig to O Fields

Marker Label / Base and Display

The label field displays the label name for which the X and O marker values are assigned. To display other labels, select the label field and choose the new label from the selection menu that appears. Only preassigned labels are available in the label selection menu.

The base field, underneath the label field, displays the numeric base the marker values are displayed in. To change the numeric base, select the base field, then choose the desired base from the selection menu.

Data patterns, where the markers are currently placed, appear next to the appropriate marker.

See also

"Label Assignment Field" in the Format Menu chapter for information on assigning labels.

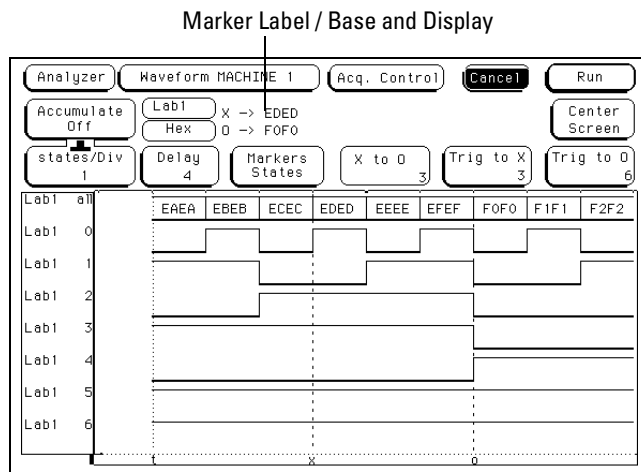

Marker Label / Base and Display



Waveform Display

The waveform display area of the Waveform menu displays state and timing waveforms for labels assigned in the Format menu. If the Waveform menu is for a state analyzer, the display is state waveforms. If the Waveform menu is for a timing analyzer, the display is timing waveforms.

The waveform display area also accesses the fields used to select, delete, or modify waveforms. The function of selecting waveforms for display, and modifying or deleting waveforms is identical for both state and timing waveforms.

Only waveforms with their bits assigned to a label in the Format menu are displayed. Each waveform is a member of a set of waveforms grouped under a label. The label name you assign in the Format menu is the label name that appears in the label selection list.

Display Location Reference Line

At the bottom of the Waveform menu is a reference line which displays the relative location of the display window, the markers, and the trigger point with reference to the total memory.

Total memory is represented by a horizontal dotted line. The display window is represented by an overlaid solid line. The markers and trigger point are represented by small dots above the total memory line, and an X, O, and t label, all of which are located below the total memory line. See the figure below.

As you change settings such as delay, sec/Div, states/Div, trigger point and marker placement, all the relative positions change within the Display Location Reference Line.

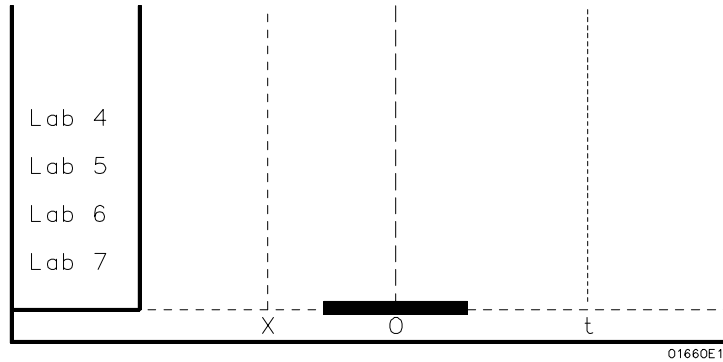

Display Location Reference Line



Waveform Label Field

The waveform label field, located on the left side of the waveform display, is both a display and configuration field. After all desired waveforms are configured for display, they are listed in the waveform label field. If there are more waveforms than can be displayed, the list is rolled by selecting the waveform label field, then after the roll indicator appears, turn the knob.

If the waveform label field is selected a second time, a waveform modification menu appears. Use this menu to configure the waveform display.

When the waveform modification menu appears, select the operation to insert, replace, delete, or scale waveforms into the display. You can display up to 24 waveforms on screen at one time.

Waveform modification

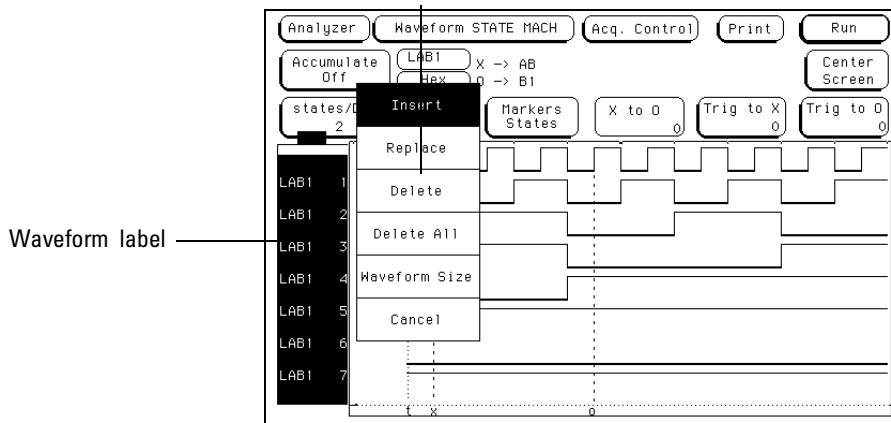

Waveform Selection Options

Insert

When the Insert option is selected, a list of all labels assigned in the Format menu appears. Select the desired label to insert. Select to insert a single bit, all bits in sequential order, or all bits as a Bus in an overlaid form. The new inserted waveform is placed directly below the cursor.

Viewing State Values in the Bus Option When all assigned waveforms in a label are overlaid with the Bus option, the value of the data is displayed to the right of each new transition in the waveform display. This will happen only when the waveform size is set to large.

If the sec/Div is set to view a large increment of time, or the waveform scaling is set to small or medium, the state data readout will not fit between transitions. To display the state data readouts within the waveform, expand the sec/Div and use the large waveform setting. If symbols are assigned to represent data values, the symbol is displayed.

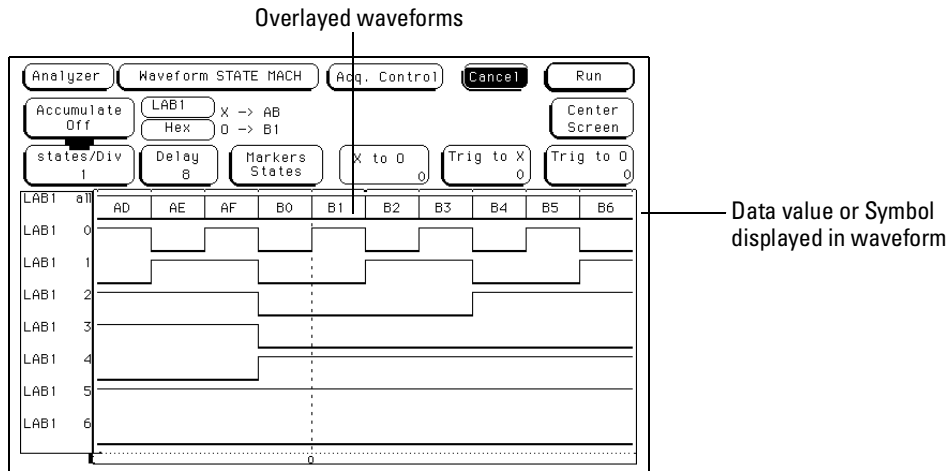

Replace

To replace one waveform with another, select the waveform you wish to replace, then select the Replace field. When the list of bits (waveforms) appears, select the new waveform to replace the old waveform.

Delete and Delete All

The Delete field is used to delete single channels within the group of displayed waveforms. To delete any single channel, select the waveform you wish to delete, then select the Delete field.

To delete all displayed waveforms, select any single waveform to access the options list, then select the Delete All field followed by Continue.

Waveform Size

The Waveform Size field accesses a selection menu which contains choices that scale the displayed waveforms to different sizes. A different waveform size can increase the number of waveforms in the display or make the viewing better for just a few.

Best Fit

When Best Fit is used, the analyzer picks the largest font, either small, medium, or large, that allows all waveforms to be displayed.

Small

The small font will allow 24 waveforms displayed.

Medium

The medium font will allow 16 waveforms displayed.

Large

The large font will allow 8 waveforms displayed. Use this selection if you want to view data values or symbols in the display.



System / Analyzer Field

The function of the System/Analyzer field is the same in all menus. For a complete definition of the System/Analyzer field, go to "The Common Menu Fields" chapter at the beginning of the Analyzer part of this User's Reference.

Menu Field

The function of the Menu field is the same in all menus. For a complete definition of the Menu field, go to "The Common Menu Fields" chapter at the beginning of the Analyzer part of this User's Reference.

Print Field

The function of the Print field is the same in all menus. For a complete definition of the Print field, go to "The Common Menu Fields" chapter at the beginning of the Analyzer part of this User's Reference.

Run Field

The function of the Run field is the same in all menus. For a complete definition of the Run field, go to "The Common Menu Fields" chapter.

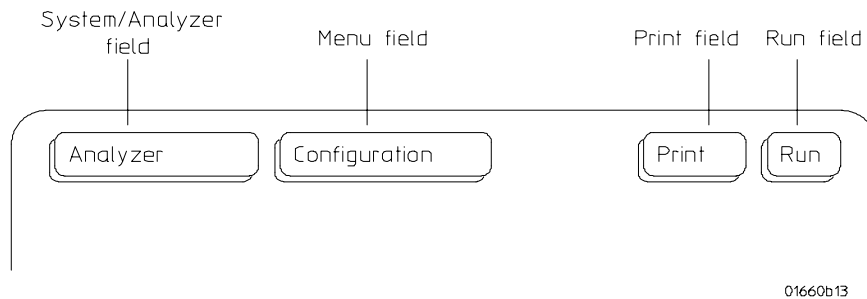

Common Menu Fields



The Mixed Display Menu

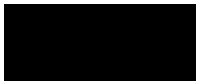

The Mixed Display Menu (1660A Through 1663A Only)

The Mixed Display menu is a multidisplay menu which consists of a state listing display located at the top of the menu and a waveform display located at the bottom of the menu. The Mixed Display menu is used to view both state and timing data in the same display.

The Mixed Display menu only becomes available when at least one analyzer is configured as a state analyzer, with its Count field in the Trigger menu set to Time. If two state analyzers are configured, both state listing displays can be interleaved as well as shown separately, however, the listing menus are the best display menus for a two-state analyzer configuration.

The waveform display area shows timing analyzer waveforms from the configured timing analyzer.

For the most part, the operation of the menu fields in the listing and waveform portions of the Mixed Display menu are identical to their operation in their respective menus.

Only the unique functions and features of the Mixed Display menu are described in this chapter. For complete information about the menu fields refer to the Listing menu and Waveform menu chapters found earlier in this manual.

Inserting Waveforms

To insert waveforms use the same procedure for selecting waveforms when in the Waveform menu.

See Also

"Waveform Display" in the Waveform menu chapter for information on the field definitions and the waveform selection functions.

Interleaving State Listings

Interleaved state listings allows you to view two labels and their data from different analyzers in the same column. The process of interleaving state listings can be performed in either the Listing menu or the Mixed Display menu. For example, if data is interleaved in the Listing menu, it will be automatically interleaved in the Mixed Display menu.

The interleaved label is placed directly above the selected label and all interleaved data is displayed in white. In addition, the state numbers of the interleaved data are indented to the right. Because of the lack of room available in the listing portion of the Mixed Display menu, the label identifying the interleaved data is not displayed. For this reason, it is recommended that when two state analyzers are configured, the listing menus should be used to display interleaved labels.

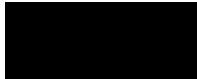

Time-Related Displays

Once the Time markers are set in the Waveform display area of the Mixed Display menu, time-correlated X and O Time markers will be displayed in both the listing and the waveform display areas.

The analyzer uses a counter to track time between the triggering of one display and the triggering of the other display. It uses this count to reconstruct time-correlated data.

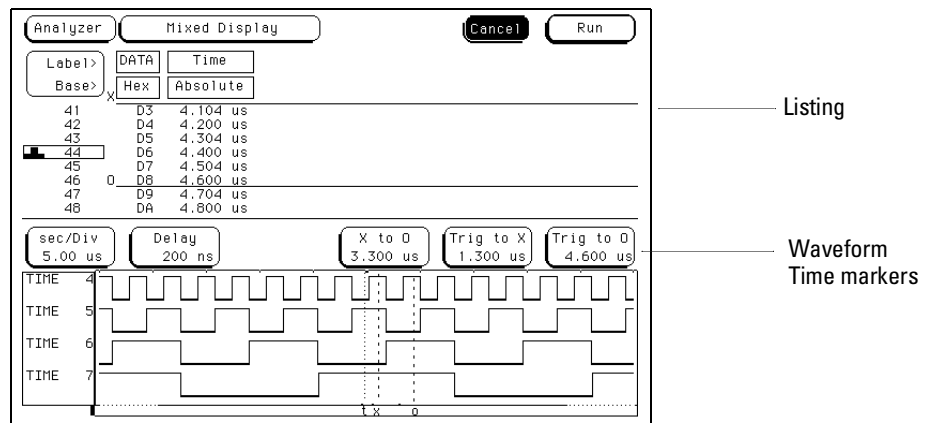

Time Correlated Markers

Markers

The markers in the Mixed Display menu are not the same as in the individual Listing and Waveform menus. You must place new Time markers on your points of interest in the Mixed Display. Even though you have placed markers in the individual listing and waveform displays, the markers will not transfer to the Mixed Display menu.

Time Markers

Only Time markers are available in the Mixed Display menu. You set the Time markers in the waveform display area of the menu. Refer to the chapter "The Waveform Menu" found earlier in this manual for complete information on Time marker operation.

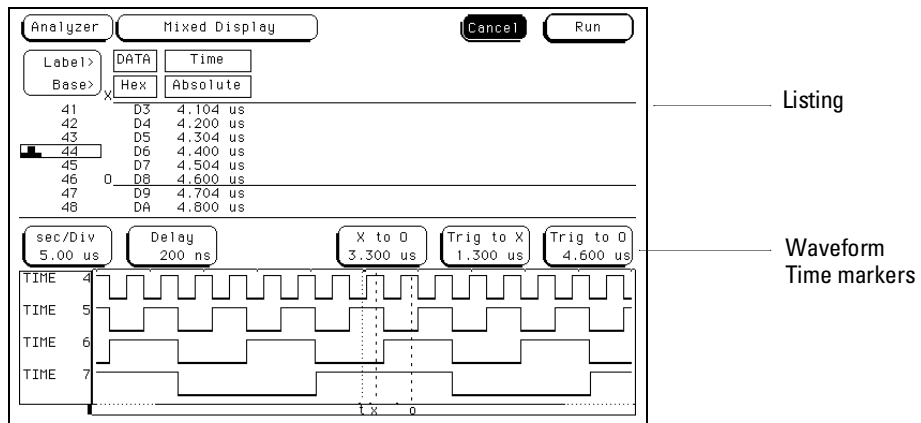

Time Markers

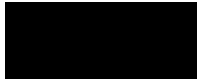





The Chart Menu



The Chart Menu

State Chart is a software post-processing feature that provides the ability to build x-y charts of label activity using state data. The Chart menu builds a graphical representation of the system under test. The y-axis always represents data values for a specified label. You can select whether the x-axis represents states (ie. rows in the state listing) or the data values for another label.

Chart Post-Processing Features

When the x-axis is set to State, X and O markers are available which display the current sample relative to the trace point and the corresponding y-axis data value. Marker placement is synchronized with the normal state listing.

An accumulate mode is available that allows the chart display to build up over several runs.

You can generate x-y charts of Label vs Label or Label vs State.

**Label Value vs. Label Value Charts**

When labels are assigned to both axis, the chart shows how the data acquired under one label varies in relation to the other for a particular measurement. Label values are always plotted in ascending order from the bottom to the top of the chart and in ascending order from left to right across the chart. Plotting a label against itself will result in a diagonal line from the lower left to upper right corner. All markers are disabled when plotting this kind of chart.

Label Value vs. States Charts

The Label value versus State is a plot of data values acquired under a label versus the memory location of the same data. The label value is plotted against successive memory locations numbers.

Chart Menu Map

The following menu map illustrates all fields and the available options in the Chart menu. The menu map will help you get an overview as well as provide you with a quick reference of what the Chart menu contains.

The Chart Menu

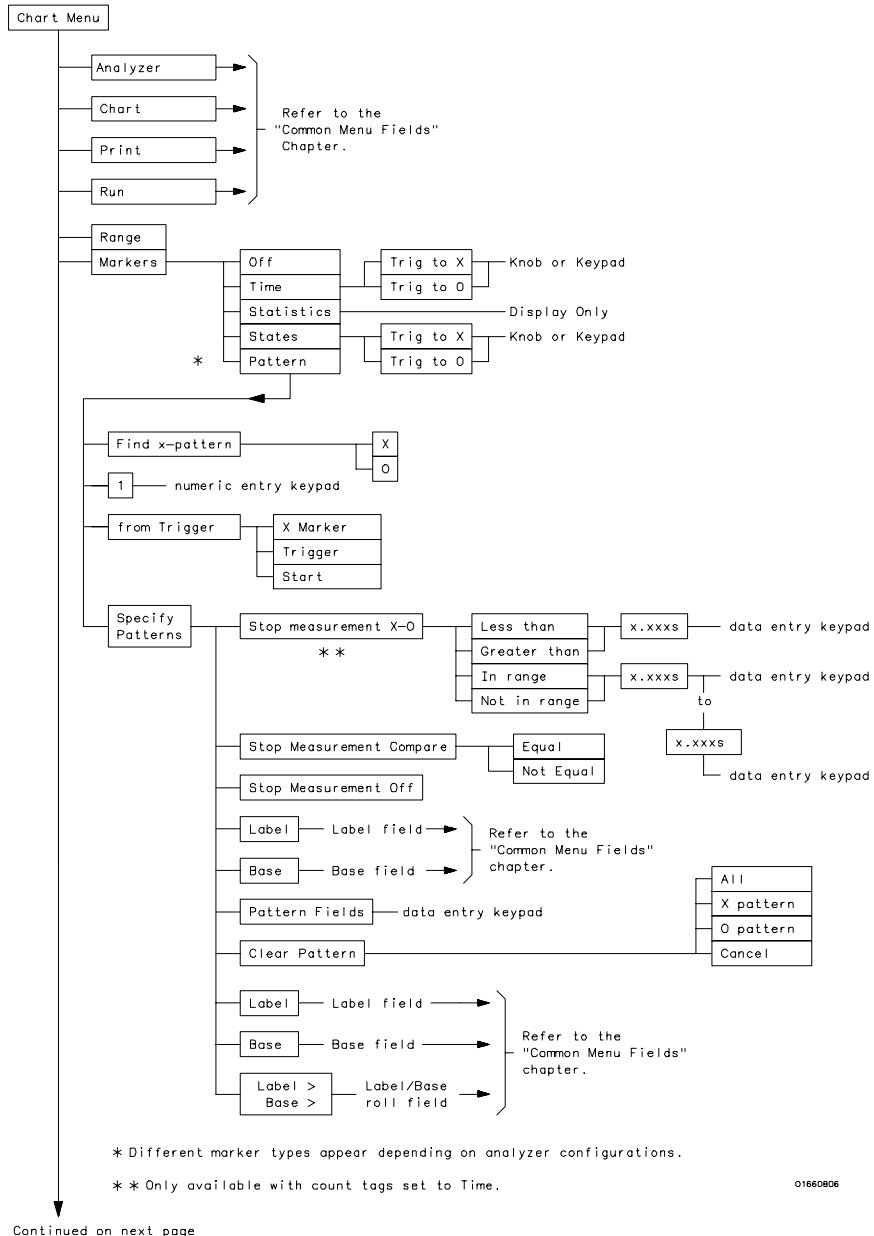

Continued on next page

Chart Menu Map

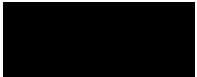

Cont'd from prev page

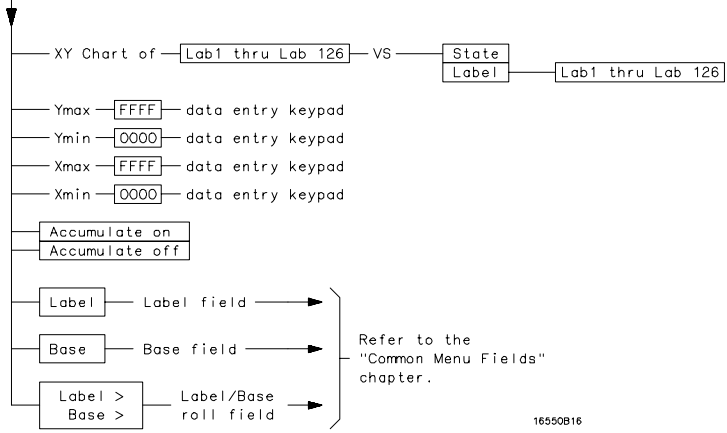

16550B16

Chart Menu Map (cont.)

Selecting the Axes for the Chart

When using the State Chart display, you first select what data you want plotted on each axis. The vertical y-axis will always be the data under a label. The available labels are those which you assigned in the Format menu. The horizontal x-axis can be either the same labels available for the y-axis or state memory location numbers.

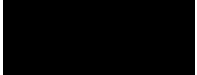

Y-axis Label Value Field

The y-axis label field displays the label assigned to the vertical y-axis. Vertical axis labels are assigned by selecting the y-axis label field, then selecting a label from a selection list. The only label choices available are the labels that were defined in the Format menu.

The value plotted is the measured data value represented by that label, and in the numeric base selected.

The placement of the label data on the graph is determined by the scaling of the Ymin and Ymax fields.

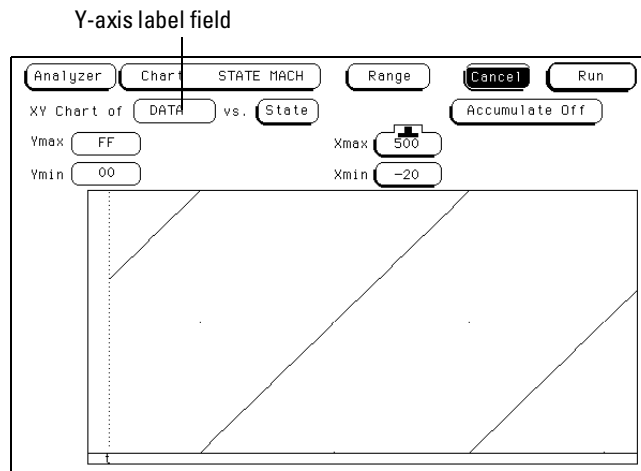

The Y-axis Label Field

X-axis Label / State Type Field

The Label/State type field displays the axis type assigned to the horizontal axis. The x-axis represents state data values, or state memory location numbers.

The x-axis type field is just to the right of "vs." text, and toggles between State and Label. The x-axis type field must be set to either Label or State before the chart's x-axis scaling is assigned.

To assign a label, select the x-axis Label field, then select the desired label from a label selection list. The value plotted is the measured data value represented by that label, and in the numeric base previously selected. The only label choices available are the labels that were defined in the Format menu

To assign the axis type to State, toggle the field to State. The value plotted is the state memory location numbers or a range of memory locations assigned by the Xmin and Xmax fields.

See Also

"Scaling the Axes" found later in this chapter for information on setting the Xmin, Xmax, Ymin, and Ymax fields.

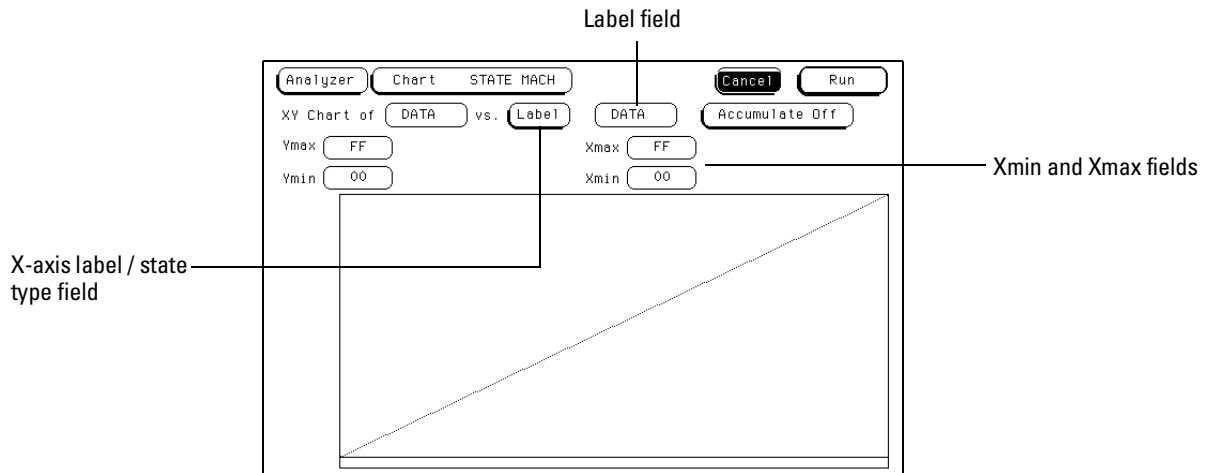

The X-axis Label / State Type Field

Scaling the Axes



When the x-axis is set to State, the horizontal axis represents state memory location numbers. The range of the x-axis can be a single memory location, or a range of memory locations.

When the x-axis is set to Label, the horizontal axis represents a range of data values under the selected label.

Use the Xmin and Xmax fields to set the horizontal axis start point and end point, with the difference between them setting the total axis range.

When the y-axis is set to Label, the vertical axis represents a range of data values under the selected label.

Use the Ymin and Ymax fields to set the vertical axis start point and end point, with the difference between them setting the total axis range.

Min and Max Scaling Fields

Either axis of the x-y chart can be scaled by using the associated vertical or horizontal min (minimum) or max (maximum) value fields. When the scaling fields are selected, minimum and maximum values can then be entered by using the front-panel keypad.

When State is selected for the x-axis, the minimum and maximum values can range from -8192 to +8192 depending on the trace point location.

When Label is selected for the x-axis, the minimum and maximum values range from 00000000 to FFFFFFFF regardless of axis, since labels are restricted to 32 bits.

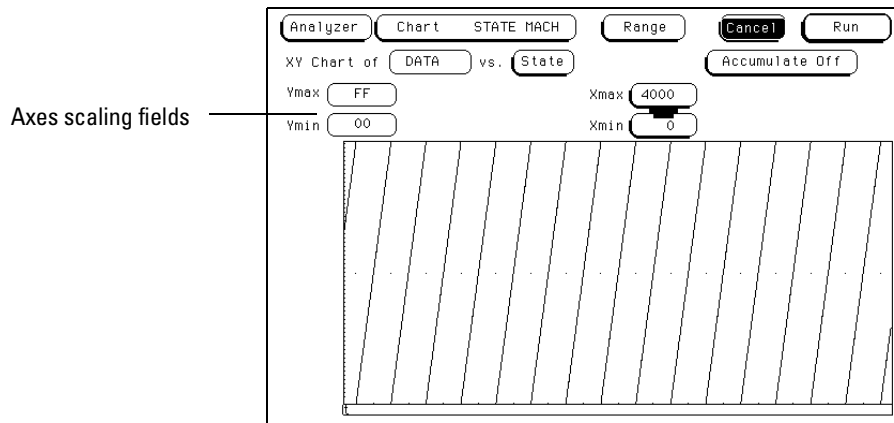

Axes Scaling Fields



Markers / Range Field

The Marker/Range field is a toggle field that switches between Markers and Range when it is selected. If the field is set to Range, x and y range fields become available to set the chart minimum and maximum range points. The Ymin and Ymax fields display the numeric value of the selected label. The numeric base of the label value is what ever was previously set.

When the Marker/Range field is toggled to Markers, a marker selection menu appears with marker choices available with the present analyzer configuration.

In a state analyzer with Time and State count turned off in the Trigger menu, only Pattern markers are available. With Time count turned on, additional choices of Time markers and Statistics markers become available.

With States count turned on, in addition to Pattern markers, States markers are available.

Off

The Off selection turns marker operations off. If a Stop measurement was previously specified, and the Stop measurement criteria are met, the measurement will stop even though the markers are off.

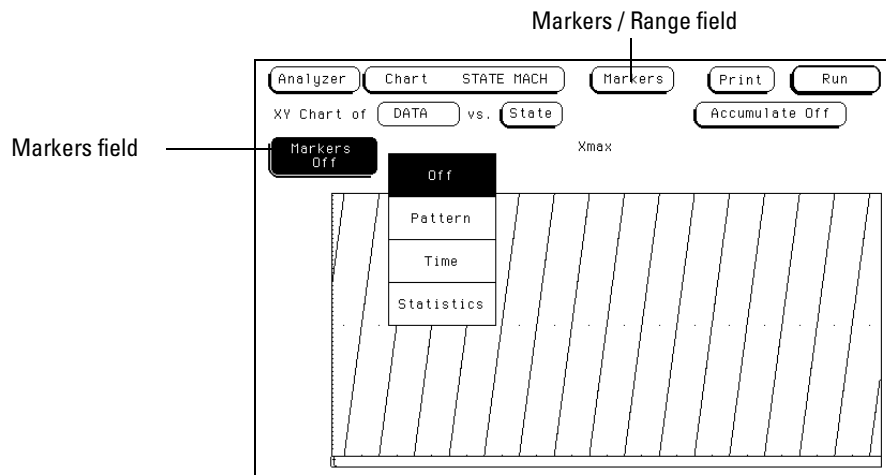

Markers / Range Field

Pattern Markers

When Pattern is selected from the markers type selection menu, two markers labeled X and O become available. Pattern markers identify and mark unique bit patterns in the data listing. Once the unique bit patterns are marked, they can be used as reference points or as criteria for a stop measurement.

The markers are graphically displayed by dashed vertical lines. In addition, both markers are labeled at the bottom of the display.

When a marker is positioned in the Listing menu, it is also positioned in the Chart menu and Waveform menu.

See Also

"Specify Patterns Field" found later in this chapter for more information on creating a pattern for the X and O markers.

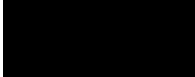

Find X-pattern / O-pattern Field

The Find X-pattern / O-pattern Field is a toggle field. When selected, the occurrence and trace start field assignments switches to the other marker. In addition, when this field is selected, the marker identified and the data it marks, will automatically shift to center screen.

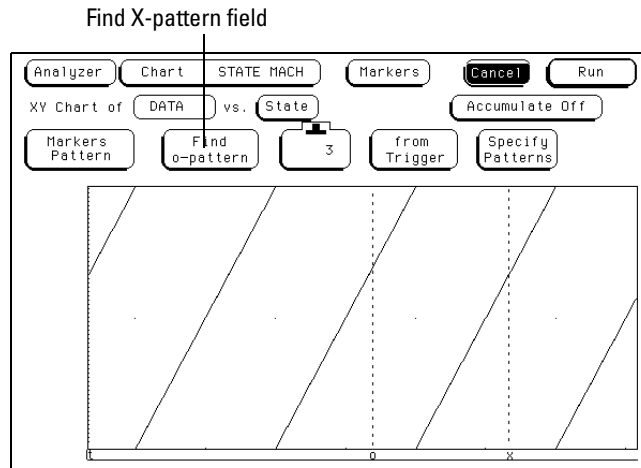

Find X-pattern / O-pattern Field

Pattern Occurrence Fields

The X-pattern and O-pattern occurrence fields designate which pattern occurrence the marker is placed on. The occurrence field is set by first highlighting the field, then turning the knob or entering a number from the front-panel keypad.

The reference point from which the occurrence counter starts is either the trigger point, the start of the trace, or in the case of the O-marker, the X-marker.

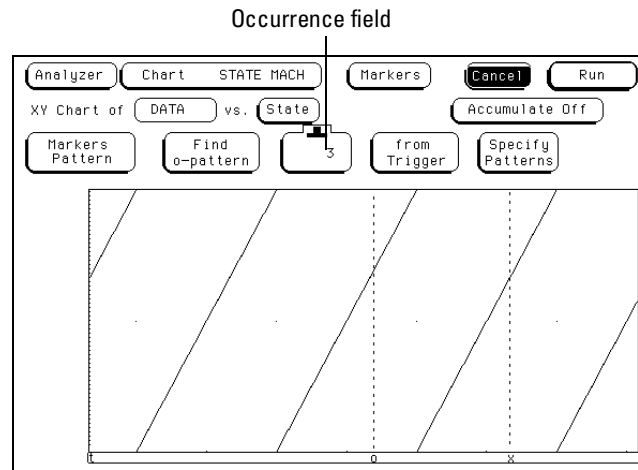

X-pattern and O-pattern Occurrence Fields

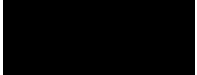

From Trigger / Start / X-Marker Fields

The from Trigger/Start/X-marker field is used to access the selection pop-up for the start point of the X and O marker occurrence counters.

The start points available for the X-marker are either the trace start point or the trigger point. The start points available for the O-marker are either the trace start point, trigger point, or the X-marker.

If the marker pattern can not be found, a message appears at the top of the display indicating the search failed. If the O-marker is reference from the X marker, and the X-marker is not found, the search for both markers will fail.

From Trigger / Start / X marker field

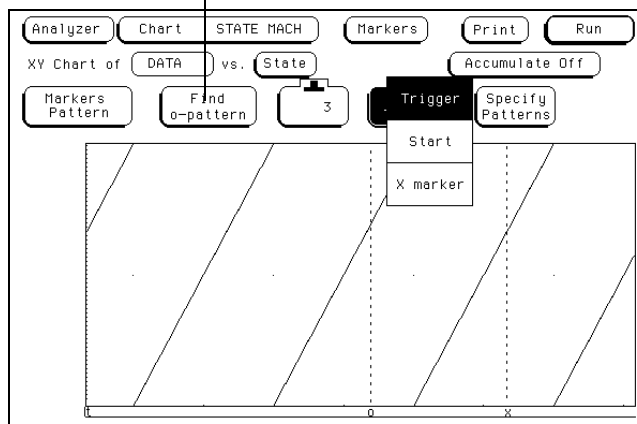

Trigger / Start / X Marker Field

Specify Patterns Field

The Specify Patterns field only appears when the markers are set to Pattern. When the Specify Patterns field is selected, a pop-up menu appears that is used to assign the bit patterns for the X and O markers, and the Stop measurement criteria.

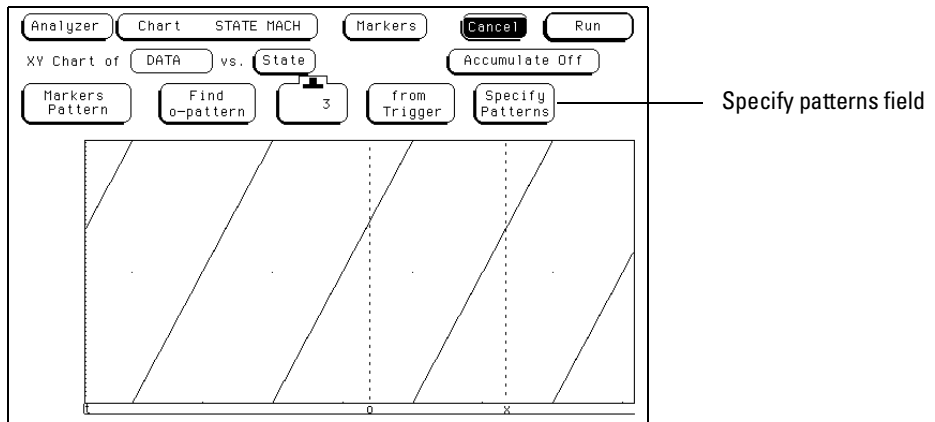

Specify Patterns Field

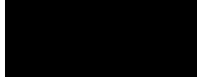

Pattern Display Fields

The pattern display fields display the alpha-numeric bit pattern specified for each X and O marker in all designated labels. The bit pattern is displayed in the same numeric base and same order as the data listing. When the pattern display field is selected, a value can be entered using the front-panel keypad.

When there are more labels assigned than can be displayed in a single screen, the pattern display fields are rolled back on screen by the Label / Base roll field.

See Also

"Label/Base Roll Field" in the Common Menu Fields chapter for a complete definition of the Label/Base roll field.

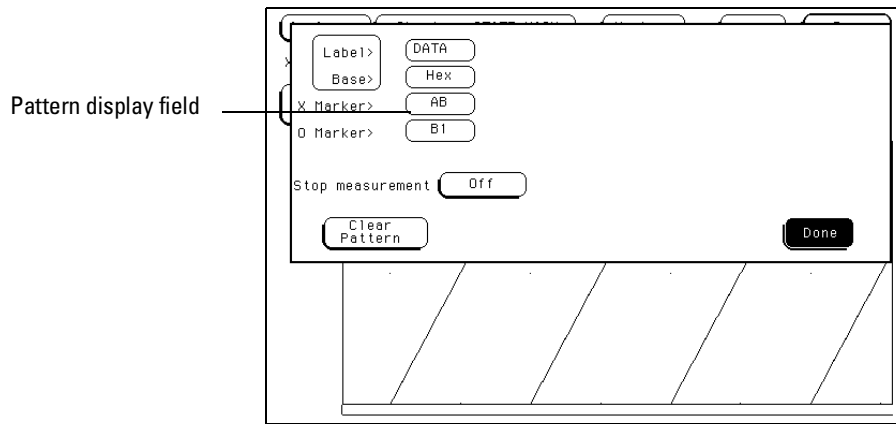

Pattern Display Field

Label and Base Fields

The Label and Base fields show up together in all menus except the Format and Configuration menus. When a new label is assigned, a base field is automatically assigned to that label.

Label Field Labels in the Specify Patterns menu are the same labels assigned in the Format menu. These labels will be displayed throughout the analyzer as they were assigned in the Format menu.

To reorder currently displayed Labels, select the label you want to move, then from the selection menu that appears, choose the label you want to switch positions with.

Base Field The function of the Base field is the same in all menus. For a complete definition of the Base field, refer to "Base field" in the Common Menu Fields chapter.

Label / Base Roll Field

The function of the Label and Base roll field is the same in all menus. For a complete definition of the Label/Base roll function, refer to "Label/Base Roll Field" in the Common Menu Fields chapter.

See Also

"Label Assignment Field" in the Format menu chapter for a complete definition of label assignment and modification.

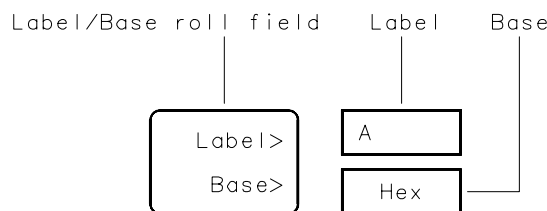

16542B03

Label / Base Roll Field

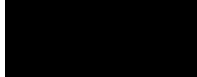

Stop Measurement Field

The Stop measurement function allows you to specify a condition which stops the analyzer measurement during a repetitive run.

When the Stop measurement field is selected, a stop measurement type menu appears. Depending on the analyzer configuration, you have the choices of Off, X-O, and Compare.

Off

The Off selection turns all Stop measurement operations off.

If the Stop measurement operation is not turned off and Stop measurement criteria are met, the measurement will stop even though the markers are off.

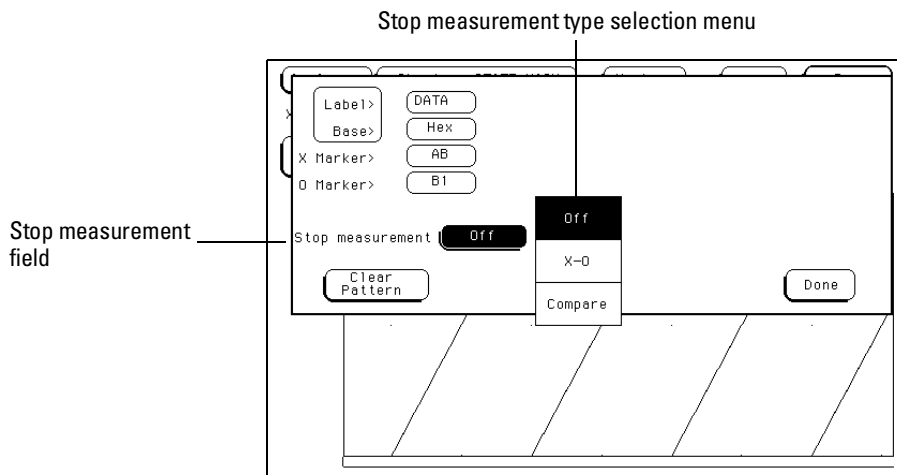

Stop Measurement Field

The Chart Menu

Stop Measurement Field

X-O

The X-O option is available when the Count field in the Trigger menu is set to Time.

When X-O is selected, a repetitive run is stopped when a comparison of the time period between the X and O markers and one of the following time period options is true:

Less Than X-O time must be less than the time value that you specify in the Time field.

Greater Than X-O time must be greater than the time value that you specify in the Time field.

In Range X-O pattern must be within the time range value that you specify in the two Time fields.

Not in Range X-O pattern must not be within the time range value that you specify in the two Time fields.

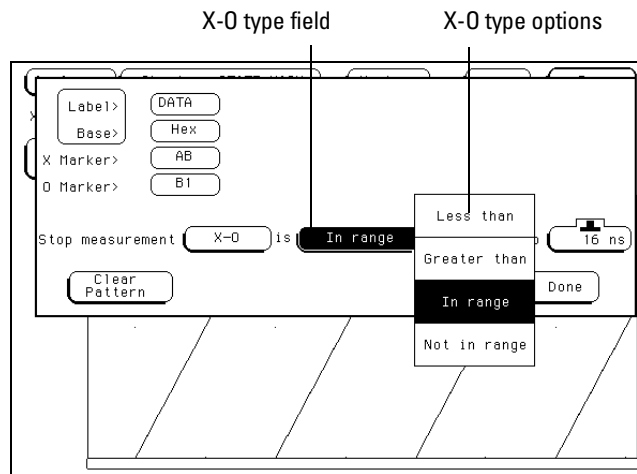

X-O Field

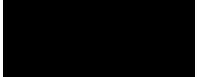

Compare

When Compare is selected, a repetitive run is stopped when a comparison of data in the Listing menu and data and criteria in a compare image matches an equality selection. The equality selection is set from the Equal/Not Equal selection pop-up menu.

Equal The data and compare criteria in the Compare menu must be equal to the data in the Listing menu.

Not Equal The data and compare criteria in the Compare menu must not be equal to the data in the Listing menu.

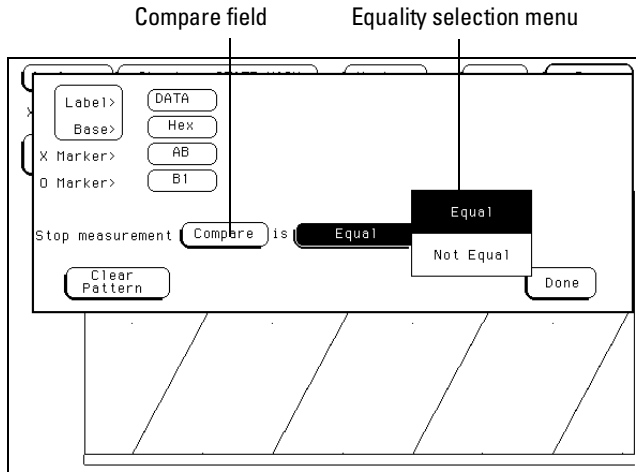

Equal / Not Equal Selection Menu

Clear Pattern Field

The Clear Pattern field is used to reset the X and O Marker pattern display fields back to default (don't care = X). The Clear Pattern field accesses a selection menu with the choices of all (displays X & O patterns for the 1664A), X pattern, or O pattern.

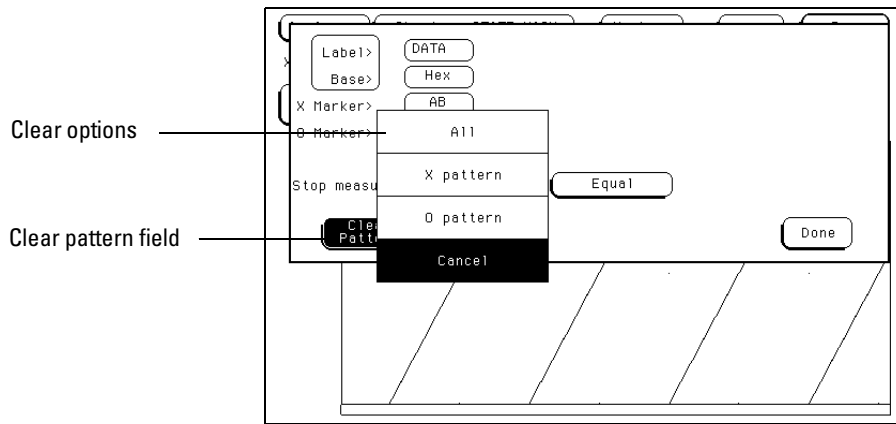

Clear Pattern

Time Markers



Time markers are indicators located in the x-y chart that are used as reference marks to obtain time values between each marker, or between each marker and the trigger point.

Time markers only become available when the Count field, in the Trigger menu, is set to Time.

The markers are graphically displayed by dashed vertical lines. In addition, both markers are labeled at the bottom of the display.

If Pattern markers have been assigned, the Time markers will be initially placed at the same locations as in the data listing.

Trig to X / Trig to O Fields

The Trig to X and Trig to O fields are both display fields as well as configuration fields. The Trig to X and Trig to O fields display the time between the trigger point and the marker.

Marker position is set by selecting the desired field and entering a value using the front-panel keypad. The units are set by turning the knob when the assignment pop-up is open. Marker position can also be set by simply turning the knob when the roll indicator is present.

X to O Display Field

The X to O display field is a "read only" field that displays the time between the X and O markers. As the X and O markers are changed, the display changes accordingly.

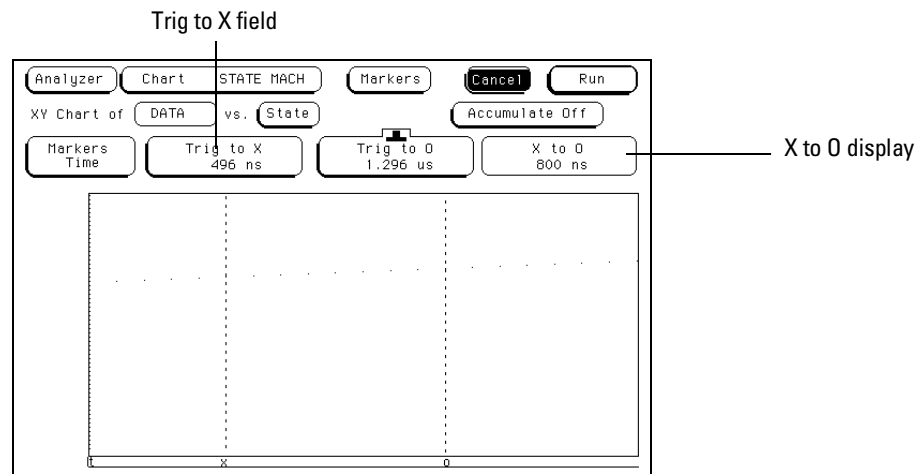

Trig to X / Trig to O Fields



After patterns are assigned to the X and O markers, statistical information is available when markers are set to Statistics. The logic analyzer displays the following information:

- Number of valid runs (runs where Pattern markers were able to be placed on specified patterns).
- Minimum time between the X and O Pattern markers.
- Maximum time between the X and O Pattern markers.
- Average time between the X and O Pattern markers.

Statistics markers only become available when the Count field in the Trigger menu is set to Time.

The markers are graphically displayed by dashed vertical lines. In addition, both markers are labeled at the bottom of the display.



Statistics are based on the time between the X and O markers. Both markers must be found before valid statistical information is displayed.

In repetitive run mode, the display is updated each time a valid run occurs until you select Stop. If you select Run after a Stop, the statistics continue to update without loss of information.

In single run mode, each time you select Run, an additional valid run will be added to the data and the statistics will be updated. This process continues unless you change the placement of the X and O markers between runs.

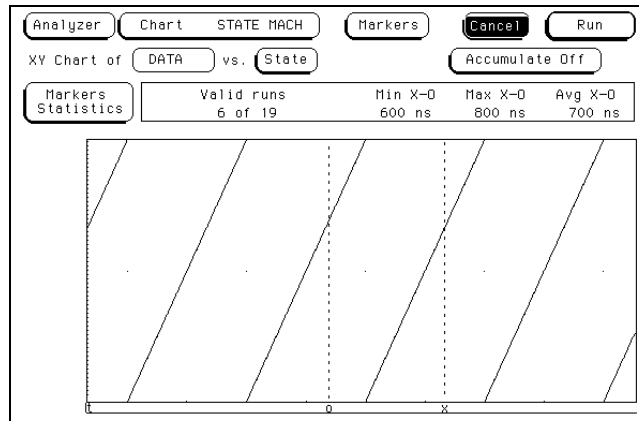

Statistics display

Statistics Display

States Markers

States markers are indicators located in the x-y chart that are used as reference marks to obtain the number of states between each marker, or between each marker and the trigger point.

States markers are only available in a State analyzer with the Count field in the Trigger menu set to States.

The markers are graphically displayed by dashed vertical lines. In addition, both markers are labeled at the bottom of the display.

Trig to X / Trig to O Fields

The Trig to X and Trig to O fields are both display fields as well as configuration fields. The Trig to X and Trig to O fields display the number of states between the trigger point and the marker.

Marker position is set by simply turning the knob when the roll indicator is present.

X to O Display Field

The X to O display field is a "read only" field that displays the number of states between the X and O Pattern Markers. As the X and O markers are changed, the display changes accordingly.

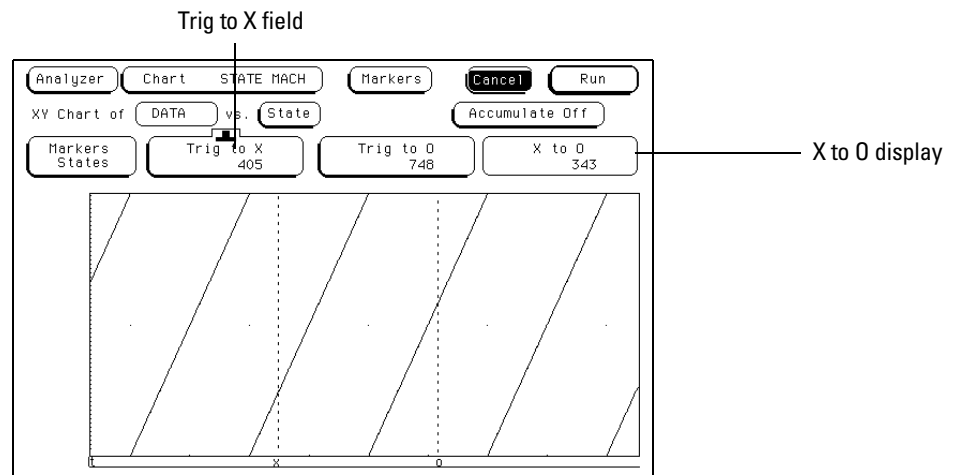

Trig to X / Trig to O Fields

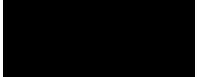

System / Analyzer Field

The function of the System/Analyzer field is the same in all menus. For a complete definition of the System/Analyzer field, go to "The Common Menu Fields" chapter at the beginning of the Analyzer part of this User's Reference.

Menu Field

The function of the Menu field is the same in all menus. For a complete definition of the Menu field, go to "The Common Menu Fields" chapter at the beginning of the Analyzer part of this User's Reference.

Print Field

The function of the Print field is the same in all menus. For a complete definition of the Print field, go to "The Common Menu Fields" chapter at the beginning of the Analyzer part of this User's Reference.

Run Field

The function of the Run field is the same in all menus. For a complete definition of the Run field, go to "The Common Menu Fields" chapter.

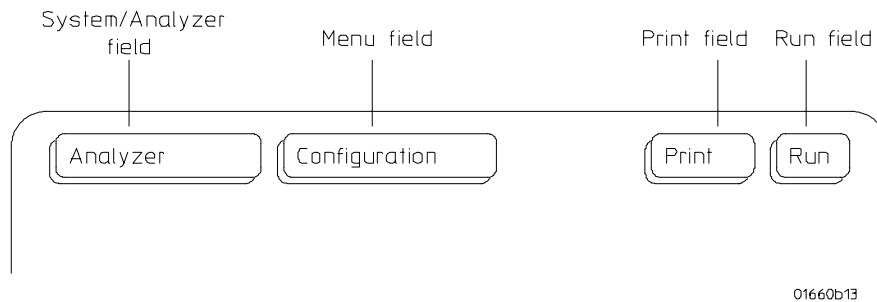

Common Menu Fields





The Compare Menu

The Compare Menu

State Compare is a software postprocessing feature that provides the ability to do a bit by bit comparison between the acquired state data listing and a reference listing.

The comparison between the acquired state listing data and the data in the reference listing is done relative to the trigger points. This means that the two data records are aligned at the trigger points and then compared bit by bit.

Any bits in the acquired data that do not match the bits in the compare image are treated as unequal.

Compare Post-Processing Features

You can view in separate listings the acquired data, your reference listing, and a listing that highlights the bits in the acquired data that do not match the corresponding bits in the reference listing.

You can edit the reference listing for unique comparisons.

You can mask specific bits that you do not want to compare. These "Don't compare" bits can be specified individually for a given label and state row, or specified by channel across all state rows.

You can select a range of states to compare. When a range is selected, only the bits in states on or between the specified boundaries are compared. Also, you can save the reference listing along with the analyzer configuration to disk.

Compare Menu Map

The following menu map graphically illustrates all fields in the Compare menu. Use the menu map as an overview and as a quick reference to the available options in the Compare menu.

The Compare Menu

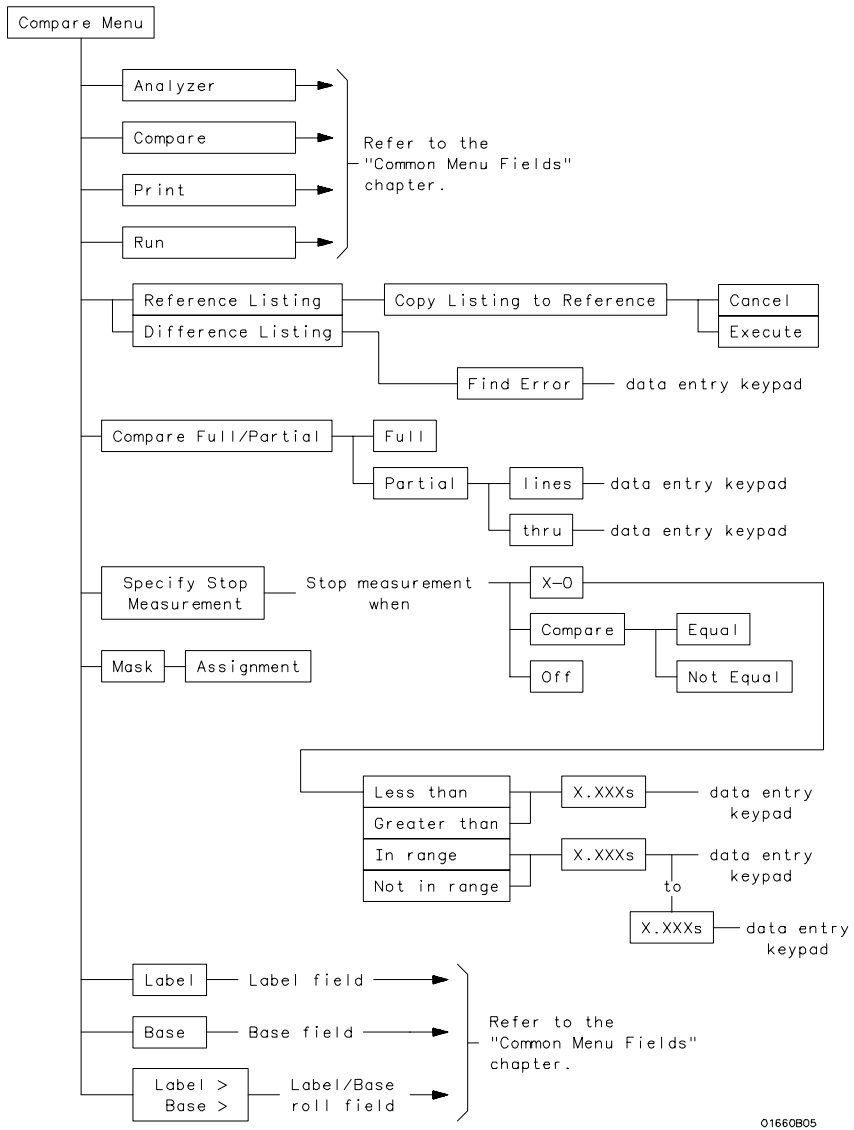

01660B05

Compare Menu Map

Reference Listing Field

The Reference listing and Difference listing field is a toggle field that switches the listing type between the Reference image listing and the Difference listing.

The Reference listing is a display of the image (or template) that acquired data is compared to during a comparison measurement. The boundaries of the image (or size of the template) is controlled by using the channel masking and compare range functions. Any bits in the reference listing displayed as "X" have been set to don't care bits during bit editing.

When the data listing is rolled, the difference data listing and the data listing in the Listing menu are also rolled.

Reference listing field

Item	Binary	Status
0	10101010	Not avail
1	10101011	Not avail
2	10101100	Not avail
3	10101101	Not avail
4	10101110	Not avail
5	10101111	Not avail
6	10110000	Not avail
7	10110001	Not avail
8	10110010	Not avail
9	10110011	Not avail
10	10110100	Not avail
11	10110101	Not avail
12	10110110	Not avail
13	10110111	Not avail
14	10111000	Not avail

Reference Listing Field

Difference Listing Field

The Reference listing and Difference listing field is a toggle field that switches the listing type between the Reference image listing and the Difference listing.

The Difference listing is a display of the acquired data listing with the data that differs, if any, from the Reference listing, highlighted with inverse video. If the base is inverse assembled symbols, the entire line is highlighted with inverse video.

Difference listing field

The screenshot shows a software interface for comparing data. At the top, there are buttons for 'Analyzer', 'Compare', 'STATE MACH', 'Cancel', and 'Run'. Below these are 'Difference listing' (highlighted), 'Find Error 0', 'Compare Full', and 'Specify Stop Measurement'. The 'Mask' field contains '*****'. The 'Label' field has 'DATA' and 'Time' options. The 'Base' field has 'Binary' and 'Absolute' options. A table of data is displayed below, with the row for index 6 highlighted in inverse video.

0	10101010	0	s
1	10101011	96	ns
2	10101100	200	ns
3	10101101	296	ns
4	10101110	400	ns
5	10101111	496	ns
6	10110000	600	ns
7	10110001	696	ns
8	10110010	800	ns
9	10110011	896	ns
10	10110100	1,000	us
11	10110101	1,096	us
12	10110110	1,200	us
13	10110111	1,296	us
14	10111000	1,400	us

Difference Listing Field

The controls that roll the listing in all three menus, the normal State listing, the Reference listing, and the Difference listing are synchronized unless the number of pretrigger states differ between the Reference listing and the acquired data.

This means that when you change the current row position in the Difference listing, the analyzer automatically updates the current row in the acquired State listing, Reference listing and vice-versa.

If the three listings are synchronized and you re-acquire data, the Reference listing may have a different number of pretrigger states depending on the trigger criteria. The Reference listing can be resynchronized to the State and Difference listings by entering the desired state (acquisition memory) location from the front-panel keypad.

This allows you to view corresponding areas of all lists, to cross check alignment, and to analyze the bits that do not match.



Copy Listing to Reference Field

The initial Reference image is generated by either copying the data listing from the listing menu or by loading an analyzer configuration file which contains a Reference listing. You should be aware that if you load an analyzer configuration to get a Reference image, the other menu setups will change.

When the Copy Listing to Reference field is selected, the contents of the acquisition data structure (Listing menu display) is copied to the Reference image buffer. The previous Reference image is lost if it has not been saved to a disk.

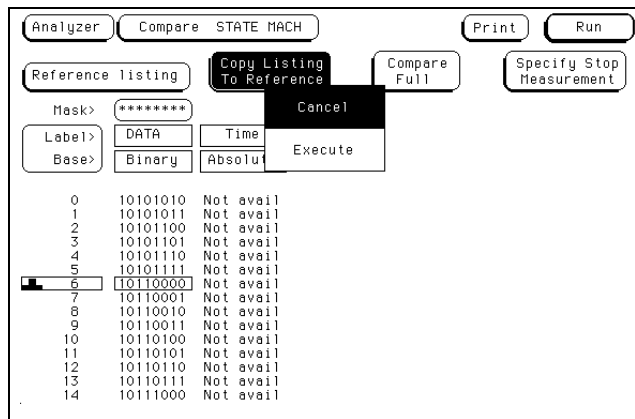

Copy Trace to Compare Field

Find Error Field

The Find Error field allows you to easily locate any patterns that did not match in the last comparison. Occurrences of differences, or errors, are found in numerical ascending order from the start of the listing. The first occurrence of an error has the numerical value of one.

You select which error number to find by highlighting the Find Error field and entering a number from the front-panel keypad. If the roll indicator is in the Find Error field, simply turn the knob. The listing is then scanned sequentially until the specified occurrence is found and rolled into view.

Find error field

The screenshot shows the 'Find error field' interface. At the top, there are buttons for 'Analyzer', 'Compare STATE MACH', 'Cancel', and 'Run'. Below these are 'Difference listing', 'Find Error 0', 'Compare Full', and 'Specify Stop Measurement'. The 'Mask' field contains '*****'. The 'Label' field is set to 'DATA' and 'Time'. The 'Base' field is set to 'Binary' and 'Absolute'. A list of errors is displayed below, with error 5 highlighted. The list shows error numbers, binary data, and time values in ns or us.

Error	Binary Data	Time
0	10101010	0 s
1	10101011	96 ns
2	10101100	200 ns
3	10101101	296 ns
4	10101110	400 ns
5	10101111	496 ns
6	10110000	600 ns
7	10110001	696 ns
8	10110010	800 ns
9	10110011	896 ns
10	10110100	1.000 us
11	10110101	1.096 us
12	10110110	1.200 us
13	10110111	1.296 us
14	10111000	1.400 us

Find Error Field

Compare Full / Compare Partial Field

The Compare Full / Compare Partial field is a toggle field which allows you to compare either the full range of states or define a subset of the total number of states in the Reference image to be used in the comparison.

The Compare mode is accessed by selecting the Compare Full/Compare Partial field in either the Compare or Difference listing menus. When selected, a pop-up appears in which you select either the Full or Partial option.

When you select the Partial option, fields appear for setting the start state and stop state values. Only bits in states (lines) on or between the boundaries are compared against the acquired data.

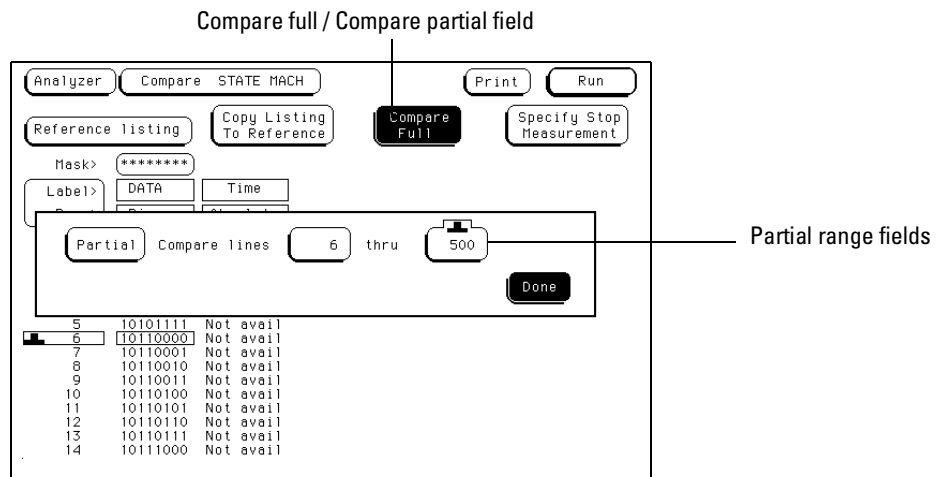

Compare Full / Compare Partial Field

Mask Field

The channel masking field is used to specify a bit, or bits in each label that you do not want compared. This causes the corresponding bits in all states to be ignored in the comparison. The Reference data image itself remains unchanged on the display.

When you select the Mask field an assignment pop-up appears in which you specify which channels are to be compared and which channels are to be masked. A "." (period) indicates a don't compare mask for that channel and an "*" (asterisk) indicates that channel is to be compared.

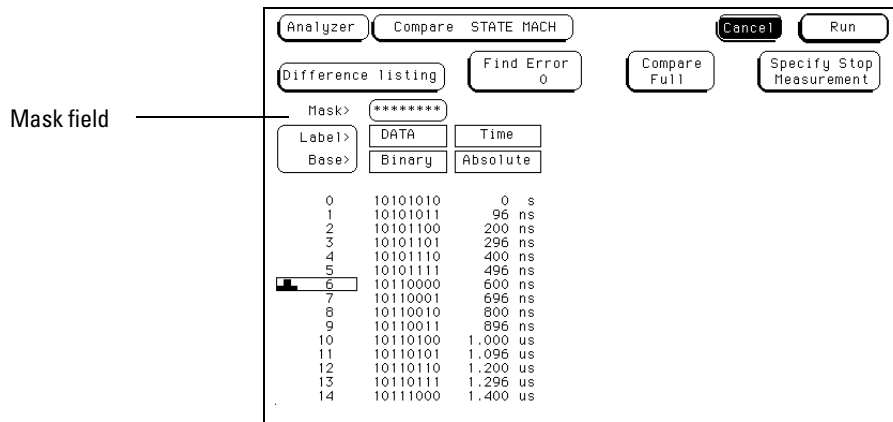

Mask Field

Specify Stop Measurement Field

The Stop measurement function allows you to specify a condition which stops the analyzer measurement during a repetitive run. When the Specify Stop Measurement field is selected, a Stop measurement menu appears which is used to set the stop criteria.

When the Stop measurement type field is selected, a selection menu appears. Depending on the analyzer configuration, you will have the choices of Off, Compare, and X-O.

Off

The Off selection turns all Stop measurement operations off.

If the stop measurement operation is not turned off and the stop measurement criteria are met, the measurement will stop even though the markers are turned off.

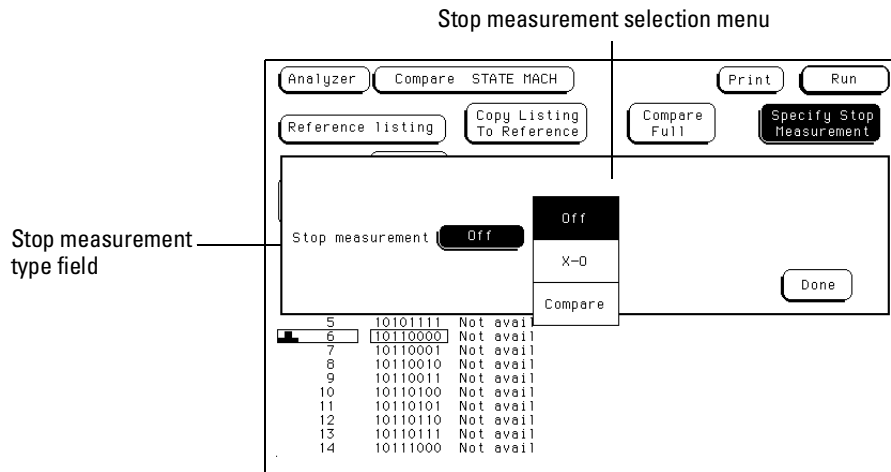

Stop Measurement Fields



Compare

When Compare is selected, a repetitive run is stopped when a comparison of data in the Listing menu and data and criteria in a Reference image matches an equality selection. The equality selection is set from the Equal/Not Equal selection pop-up menu.

Equal The data and compare criteria in the Compare menu must be equal to the data in the Listing menu.

Not Equal. The data and compare criteria in the Compare menu must not be equal to the data in the Listing menu.

Compare type options

Compare field

5	10101111	Not avail
6	10110000	Not avail
7	10110001	Not avail
8	10110010	Not avail
9	10110011	Not avail
10	10110100	Not avail
11	10110101	Not avail
12	10110110	Not avail
13	10110111	Not avail
14	10111000	Not avail

Compare Stop Measurement Type Fields

The Compare Menu Specify Stop Measurement Field

X-O

The X-O option is available in the State analyzer with its count set to Time. When X-O is selected, a repetitive run is stopped when a comparison of the time period between the X and O markers and one of the following time period options is true.

Less Than X-O time must be less than the time value that you specify in the Time field.

Greater Than X-O time must be greater than the time value that you specify in the Time field.

In Range X-O pattern must be within the time range value that you specify in the two Time fields.

Not in Range X-O pattern must not be within the time range value that you specify in the two Time fields.

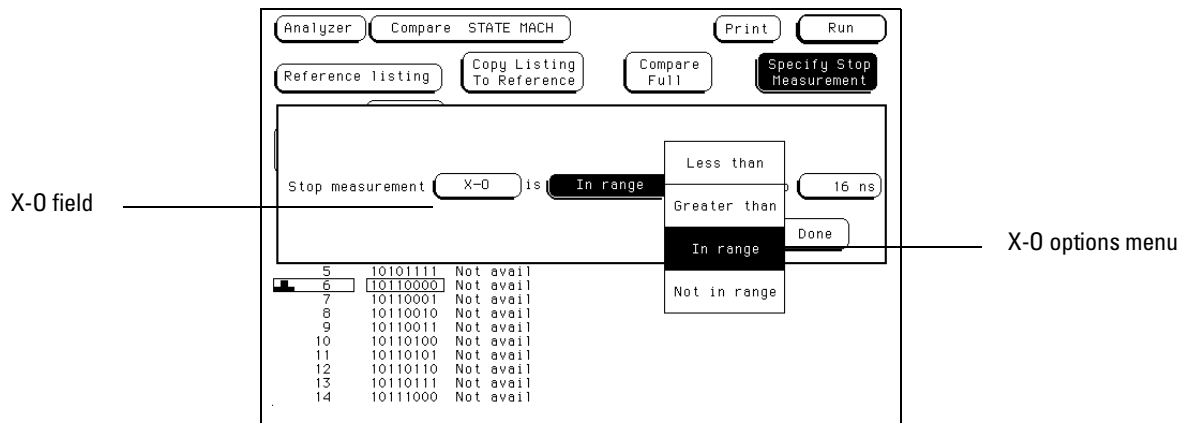

X-O Stop Measurement Type Fields

Data Roll Field

The column of numbers at the far left represents the location of the acquired data in the state analyzer's memory. The numbered positions are also known as the state locations.

The column of state locations along with its data can be rolled to display off-screen data by using the data roll field. The data roll field is the small rectangular box located in the middle of the state location column.

The data roll field is used to either roll the data listing or to select an exact state for display. When the data roll field has the roll indicator in the field, the knob is active and can roll data in either direction.

If you want a specific location, highlight the data roll field, then type in a number from the front-panel keypad. When the keypad is used, the data listing shifts, leaving the selected state in the data roll box.

The screenshot shows a terminal window titled "Analyzer Compare STATE MACH". At the top are buttons for "Analyzer", "Compare STATE MACH", "Cancel", and "Run". Below these are buttons for "Reference listing", "Copy Listing To Reference", "Compare Full", and "Specify Stop Measurement". The main display area contains a table with columns for "Mask", "Label", "Base", and data. The "Mask" field is set to "*****". The "Label" field is set to "DATA" and the "Base" field is set to "Binary". The table lists state locations from 0 to 14. The data for each location is either a binary string or "Not avail". A small rectangular box, the data roll field, is positioned over the state location 6. A line from the text "Data roll field" points to this box. Another line from the text "State location column" points to the first column of the table.

State Location	Binary Data	Status
0	10101010	Not avail
1	10101011	Not avail
2	10101100	Not avail
3	10101101	Not avail
4	10101110	Not avail
5	10101111	Not avail
6	10110000	Not avail
7	10110001	Not avail
8	10110010	Not avail
9	10110011	Not avail
10	10110100	Not avail
11	10110101	Not avail
12	10110110	Not avail
13	10110111	Not avail
14	10111000	Not avail

Data Roll Field

Bit Editing Field

The bit editing fields are located in the center of the Reference listing display. A bit editing field exists for every label in the display unless the label's base is ASCII or inverse assembled symbols. Bit editing field allows you to modify the values of individual bits in the Reference image or specify them as don't compare bits.

You access data in the Reference listing by rolling the data listing using the knob until the data is located in the bit editing field. To enter a desired pattern or don't compare (X) for a bit, select the field and use the front-panel keypad.

The screenshot shows a control panel with several buttons: "Analyzer", "Compare STATE MACH", "Cancel", "Run", "Reference listing", "Copy Listing To Reference", "Compare Full", and "Specify Stop Measurement". Below these buttons are input fields for "Mask" (containing "*****"), "Label" (containing "DATA"), "Time", "Base" (containing "Binary"), and "Absolute". A list of bits (0-14) is displayed, each with a binary value and the text "Not avail". Bit 6 is highlighted with a cursor, and its value "10110000" is shown in a box, indicating it is the active bit editing field.

Bit	Value	Status
0	10101010	Not avail
1	10101011	Not avail
2	10101100	Not avail
3	10101101	Not avail
4	10101110	Not avail
5	10101111	Not avail
6	10110000	Not avail
7	10110001	Not avail
8	10110010	Not avail
9	10110011	Not avail
10	10110100	Not avail
11	10110101	Not avail
12	10110110	Not avail
13	10110111	Not avail
14	10111000	Not avail

Bit editing field

Bit Editing Field

Label and Base Fields

The Label and Base fields show up together in all menus except the Format and Configuration menus. When a new label is assigned, a base field is automatically assigned to that label.

Label Field

Labels in the Compare menu are the same labels assigned in the Format menu. These labels will be displayed throughout the analyzer as they were assigned in the Format menu. For a complete definition of label assignment and modification, go to "Label Assignment Fields" in the Format menu.

For a complete definition of label display and label reordering, go to "Label Field" in the Common Menu Fields chapter.

Base Field

The function of the Base field is the same in all menus. For a complete definition of the Base field, go to "Base Field" in the Common Menu Fields chapter.

Label / Base Roll Field

The function of the Label and Base roll field is the same in all menus. For a complete definition of the Label / Base roll function, go to "Label / Base Roll Field" in the Common Menu Fields chapter.

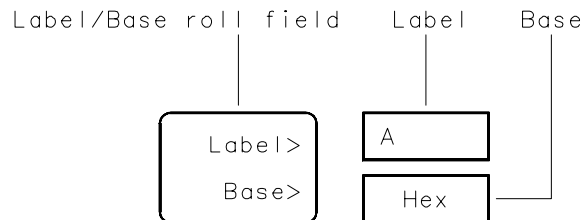

16542B03

Label / Base Roll Field

System / Analyzer Field

The function of the System/Analyzer field is the same in all menus. For a complete definition of the System/Analyzer field, go to "The Common Menu Fields" chapter at the beginning of the Analyzer part of this User's Reference.

Menu Field

The function of the Menu field is the same in all menus. For a complete definition of the Menu field, go to "The Common Menu Fields" chapter at the beginning of the Analyzer part of this User's Reference.

Print Field

The function of the Print field is the same in all menus. For a complete definition of the Print field, go to "The Common Menu Fields" chapter at the beginning of the Analyzer part of this User's Reference.

Run Field

The function of the Run field is the same in all menus. For a complete definition of the Run field, go to "The Common Menu Fields" chapter.

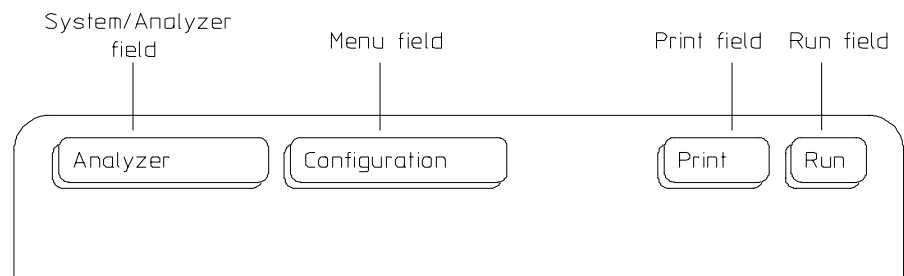

01660b13

Common Menu Fields



Error Messages

Introduction



This chapter lists the online messages that appear when using the analyzer. Depending on the measurement or configuration circumstance, they could indicate an error, warning, or simply an advisory. Generally, an error message indicates that the measurement, or a part of the measurement, will not occur until the problem is fixed. Warning or advisory messages inform the user of conditions or status.

For more information

If a message is encountered while running Self Tests, you can refer to the Service guide for information on test descriptions and troubleshooting procedures.

If a message is encountered during analyzer configuration or general operation, there could be more than one cause for generating the message. In most cases, the analyzer is configured improperly.

Error Messages

Must have at least 1 edge specified. You must assign at least one clock edge to one of the available clocks in the Master clocking arrangement. In addition, if the Slave clock is being used, it must have at least one clock edge assigned. The analyzer will not let you close the clock assignment pop-up until an edge is specified.

Time correlation of data is not possible. Before time correlation of data is possible, time tags must be placed on the data. If you want time correlated data, set the Count field in the Trigger menu to Time.

Maximum of 32 channels per label. This message appears when you try to assign more than 32 channels to a single label. The logic analyzer will only allow 32 channels to be assigned to any single label.

Timer is off in sequence level "n" where it is used. At least one sequence level has specified a timer as part of the sequence instruction and that timer is not turned on. The timer must be set to either Start, Pause, or Continue.

Timer is specified in sequence, but never started. A timer is specified somewhere in the sequence, but was not started. The timer must be set to Start. The timer can be set to Start in any sequence level.

Problems reading file. The user is trying to translate a configuration file that can not be opened a second time.

Inverse assembler not loaded - bad object code. Corrupt inverse assemble file. Try getting another copy of the inverse assembler file and loading that.

Insufficient memory to load IAL - load aborted. There is not a block of free memory large enough to load inverse assembler.

ASCII entry not available. The ASCII base is not available. You must use another base selection.

Measurement Initialization Error Hardware failed calibration prior to start of measurement. User should run PV

No Room for Selected Macro. The macro selected required more physical sequence levels than are available. Reconfigure sequence levels or use a different macro.

Cannot insert after last sequence level. Sequence levels cannot be added after the last level. Add levels before the last level.

Last level of state sequence must be a user level. The last level of a state sequence must be a user macro level. If the user tries to select a new macro or replace this level, this error results.

Cannot delete last level in state sequence. The last level in a state sequence cannot be deleted.

Too many sequence levels needed! Choose "Cancel" to leave the menu. This message is displayed when changes in a sequence level menu causes the translation too use more than the maximum number of levels available.

Too many sequence levels needed! This message is displayed when using GPIB commands and when changes in a sequence level menu causes the translation too use more than the maximum number of levels available.

Error: Min time is = Max time. This error message is displayed if the user attempts to exit the pattern width violation macro level menu with the min width time = to the max width time.

Macro requires timer resource assigned to this machine. If the user tries to select the "event too soon after event", or the "event too late after event" macro, and there are no timer resources assigned to the current machine, the selection is ignored and the user is given this error message.

This macro cannot be selected when no labels are turned on. A macro has been selected that has a label entry, but has no labels turned on in the Format menu. Make sure the configuration is consistent across menus.

Warning! Turning off this label will default trigger sequence! This message appears if a label is used in a macro, and then it is turned OFF in the Format menu. Make sure the configuration is consistent across menus.

This macro requires two unused patterns assigned to this machine. If the user tries to select the n-bit serial pattern macro and there are not at least two pattern resources assigned to the machine that are "unused" (defined as BOTH all don't cares AND not used in the sequence) then this error results, and the selection is ignored.

Warning Messages

Waiting for Prestore. This message is displayed for a timing analyzer waiting for prestore.

Search failed - X pattern not found. The X pattern specified could not be found, therefore the pattern marker could not be placed in the data.

Search failed - O pattern not found. The O pattern specified could not be found, therefore the pattern marker could not be placed in the data.

Warning: Run HALTED due to variable change. This message appears when certain analyzer settings are changed during a repetitive run. When this occurs, the analyzer stops.

Compare not available - Insufficient Memory. There is not enough memory available to store a compare image.

Error not found. The Find Error number specified in the Compare mwnu could not be found.

s/Div set to limit. The s/Div field is set to its limit.

Delay set to limit. The Delay field is set to its limit.

Machine name: "ial name" inverse assembler not found. This message appears when the inverse assembler file could not be found.

Data was acquired without time tags Time tag values will not be displayed because data was stored without time tags. If you want time tags stamped on the data, set Count in the Trigger menu to Time.

Data was acquired without state tags State tag values will not be displayed because data was stored without state tags. If you want state tags stamped on the data, set Count in the Trigger menu to State.

Count Time/States not available when in 8K Memory Mode. When the state mode is changed to Half Channel/8K mode, the time or state tags are not available.

Two pod pairs are needed to use both timers. If both timers are being used in a single chip analyzer, and there are no spare chips, this message is shown when Run is selected. Timer2 references in the sequencer will not be valid.

No active analyzer. This message is displayed if Run is selected with no analyzers turned on.

Cannot read unrecognized data. The user is trying to translate a configuration from a foreign module.

Demultiplexed clocking cannot be translated. The user is trying to translate a configuration that has demultiplexed or mixed clocks.

User thresholds have been truncated. The user is trying to translate a configuration having thresholds greater than 6 Volts or less than -6 Volts.

Slave clocks may need manual adjustment. The user is trying to translate an Agilent Technologies 16540/41A,D configuration which has slave clocks specified. This message appears when the translation is not direct.

Clock Qualifiers not fully restored. The user is trying to translate a configuration that has more than two qualifiers.

No state machines for this module. The user is trying to load an inverse assembler into a module with no state machines.

Error loading Display1. User is loading a configuration with a corrupt Display1 section.

Pods have been truncated. User is loading a configuration with number of chips greater than the current system's number of chips.

Clock pod and least significant pods have been preserved. User is loading a configuration with number of chips greater than the current system's number of chips

< Duration requires two unused sequisition levels. For each sequence level with a "<" assigned, you must leave two sequence levels free. To free up two levels, simply delete two levels.

Mixed Mode not available User is trying to show mixed mode incorrectly.

Ymin is greater than Ymax. The value assigned to Y minimum is greater than the value assigned to Y maximum.

Xmin is greater than Xmax. The value assigned to X minimum is greater than the value assigned to X maximum.

Ymin is equal to Ymax. The value assigned to Y minimum is equal to the value assigned to Y maximum.

Xmin is equal to Xmax. The value assigned to X minimum is equal to the value assigned to X maximum.

Cannot read unrecognized data During the load operation, data does not match expected values or size.

Insert failed - Maximum of 60 entries. 60 listing columns is the maximum number allowed. This advisory appears when you try to configure more than 60 columns.

No valid data. Reference memory cleared. This advisory appears when the Copy Listing To Reference field is selected in the Compare menu and there is no listing data to copy.



Advisory Messages

Computing chart information. Please Wait. This message is displayed when the analyzer is busy computing the data to be charted. When the computing is finished, the new chart will be displayed.

Slow or missing clock. This message indicates a slow or missing clock. This is displayed for a state analyzer only until the first clock occurs.

Occurrences Remaining in Level "n". The analyzer is waiting for the specified level to be satisfied. This advisory is used in analyzers that use the Occurs parameter.

Waiting in Level "n". The analyzer is waiting for the specified level to be satisfied. This advisory is used in analyzers that use the > or < parameter.

Filling Memory after Trigger. This message is displayed for a transitional timing analyzer that has triggered but has not yet finished storing data. This message is also displayed for a conventional timing analyzer with a very slow sample rate.

"n.nnn" s remaining to delay. This advisory is displayed for a conventional/glitch timing analyzer that is doing a long hardware delay (after trigger and during the delay).

Trigger inhibited during timing prestore. This message is displayed while timing analyzer is waiting to satisfy prestore requirements

Storing transitions after trigger for pod "n". This message is displayed for transitional timing analyzer that has triggered, but has not finished storing data.

Trigger occurred before prestore completed. This message is displayed for a state analyzer while in manual acquisition mode, that has not acquired the requested number of states prior to trigger.



Specifications and Characteristics

Specifications and Characteristics



This chapter lists the specifications and characteristics. The specifications are the performance standards against which the product is tested.

The characteristics are not specifications, but are included as additional information.

For complete information on the test procedures to verify product performance, refer to the Service Guide.

Specifications

Maximum State Speed 100 MHz (1660A through 1663A)
50 MHz (1664A)

Minimum State Clock Pulse Width [2] 3.5 ns

Minimum Master to Master Clock Time [2]
10.0 ns (1660A through 1663A)
20.0 ns (1664A)

Minimum Glitch Width 3.5 ns

Threshold Accuracy +/- (100 mV +3% of threshold setting)

Setup/Hold [2] one clock 3.5/0 ns to 0/3.5 ns
one edge (in 0.5 ns increments)

one clock 4.0/0 to 0/4.0 ns
both edges (in 0.5 ns increments)

multi clock 4.5/0 ns to 0/4.5 ns
multi edge (in 0.5 ns increments)

Specifications and Characteristics

Specifications are marked with an asterisk (*)

Probes

Input Resistance 100 kohm +/-2%

Input Capacitance ~8pF (see Figure 1)

Minimum Input Voltage Swing 500 mV peak to peak

Minimum Input Overdrive 250 mV or 30% of input amplitude, whichever is greater

Threshold Range -6.0 V to +6.0 V in 50 mV increments

Threshold Setting Threshold levels may be defined for pods (17 channel groups) on an individual basis .

Threshold Accuracy* +/- (100 mV +3% of threshold setting)

Input Dynamic Range +/- 10 V about the threshold

Maximum Input Voltage +/- 40 V peak

+ 5V Accessory Current 1/3 amp maximum per pod

Channel Assignment Each group of 34 channels (a pod pair) can be assigned to Analyzer 1, Analyzer 2 or remain unassigned.

State Analysis

Maximum State Speed* 100 MHz (1660A through 1664A)
 50 MHz (1664A)

Channel Count [1]

1660A	136/68
1661A	102/51
1662A	68/34
1663A	34/17
1664A	34/17



Memory Depth per Channel [1] 4096/8192

State Clocks Six clocks are available and can be used by either one or two state analyzers at any time. Clock edges can be ORed together and operate in single phase, two phase demultiplexing, or two phase mixed mode. Clock edge is selectable as positive, negative, or both edges for each clock.

State Clock Qualifier The high or low of up to 4 of the 6 clocks can be ANDed or ORed with the clock specification.

Setup/Hold* [2]

one clock	3.5/0 ns to 0/3.5 ns
one edge	(in 0.5 ns increments)
one clock	4.0/0 ns to 0/4.0 ns
both edges	(in 0.5 ns increments)
multi clock	4.5/0 ns to 0/4.5 ns
multi edge	(in 0.5 ns increments)

Minimum State Clock Pulse Width* [2] 3.5 ns

Minimum Master to Master Clock Time* [2]
 10.0 ns (1660A through 1663A)
 20.0 ns (1664A)

Minimum Slave to Slave Clock Time [2]
 10.0 ns (1660A through 1663A)
 20.0 ns (1664A)

Minimum Master to Slave Clock Time [2] 0.0 ns

Minimum Slave to Master Clock Time [2] 4.0 ns

Clock Qualifiers Setup/Hold [2] 4.0/0 ns (fixed)

State Tagging [3] Counts the number of qualified states between each stored state. Measurement can be shown relative to the previous state or relative to trigger. Max. count is 4.29×10^9 .

State Tag Count 0 to 4.29×10^9 (+/- 0 counts)

State Tag Resolution 1 count

Time Tagging [3] Measures the time between stored states, relative to either the previous state or to the trigger. Max. time between states is 34.4 sec. Min. time between states is 8 ns.

Time Tag Count 8 ns to 34.3 s +/- (8 ns + 0.01% of time tag value)

Time Tag Resolution 8 ns or 0.1% (whichever is greater)

Timing Analysis

Conventional Timing [1] Data stored at selected sample rate across all timing channels.

Maximum Timing Speed 250 MHz / 500 MHz

Channel Count

1660A	136/68
1661A	102/51
1662A	68/34
1663A	34/17
1664A	34/17

Sample Period 4 ns/2 ns minimum, 8.38 ms maximum

Memory Depth per Channel 4096/8192

Time Covered by Data Sample period x Memory depth 16.3 us min, 34.3 s/68.6 s max

Transitional Timing [1] Sample is stored in acquisition memory only when the data changes. A time tag stored with each sample allows reconstruction of waveform display. Time covered by a full memory acquisition varies with the frequency of pattern changes in the data.

Maximum Timing Speed 125 MHz/250 MHz

Channel Count

1660A	136/68
1661A	102/51
1662A	68/34
1663A	34/17
1664A	34/17

Sample Period 8 ns/4 ns

Time Covered by Data 16.3 us minimum, 9.7 hrs/6.5 hrs maximum

Maximum Time Between Transitions 34.3 s

Number of Captured Transitions 1023-2047/682-4094 Depending on input signals

Glitch Capture Mode sample period Data samples and glitch information are stored every sample period.

Maximum Timing Speed 125 MHz

Channel Count

1660A	68
1661A	51
1662A	34
1663A	17
1664A	17

Sample Period 8 ns minimum, 8.38 ns maximum

Minimum Glitch Width 3.5 ns

Maximum Glitch Width Sample Period - 1 ns

Memory Depth per Channel 2048

Time Covered by Data Sample Period x 2048 16.3 us minimum, 17.1 s maximum

Time Interval Accuracy

Sample Period Accuracy +/- 0.01 %

Channel-to-Channel Skew 2 ns typical, 3.0 maximum

Time Interval Accuracy

+/- (Sample Period + channel-to-channel skew + 0.01% of time interval reading)

Maximum Delay After Triggering Sample Period 2-8 ns: 8.389 ms.
Sample Period > 8 ns: 1,048,575 x sample period.

Trigger Specification

Pattern Recognizers Each recognizer is the AND combination of bit (0,1, or X) patterns in each label.

Pattern Recognizers 10

Pattern Width	1660A	136
	1661A	102
	1662A	68
	1663A	34
	1664A	34

Minimum Pattern and Range Recognizer Trigger Pulse Width

250 MHz and 500 MHz Timing Modes: 13 ns + channel-to-channel skew.
125 MHz Timing Modes: 1 sample period + 1 ns + channel-to-channel skew + 0.01%.

Range Recognizers Recognize data which is numerically between or on two specified patterns (AND'd combination of zeros and/or ones).

Range Recognizers 2

Range Width 32 channels.

Glitch/Edge Recognizers Trigger on glitch or edge on any channel. Edge can be specified as rising, falling or either.

Glitch/Edge Recognizers 2 (in timing mode only)

Glitch/Edge Width	1660A	136
	1661A	102
	1662A	68
	1663A	34
	1664A	34

Glitch/Edge Recovery Time Sample period 2-8 ns: 28 ns.
Sample period > 8 ns: 20 ns + sample period.

Greater than Duration (timing only) Sample period 2-8 ns: 8 ns to 8.389 ms. Accuracy is -2 ns to +10ns.
Sample period > 8 ns: $(1 \text{ to } 2^{20}) \times \text{sample period}$. Accuracy is -2 ns to +sample period + 2 ns +/- 0.01%.

Less than Duration (timing only) Sample period 2-8 ns: 16 ns to 8.389 ms. Accuracy is +2 ns to -10 ns.
Sample period > 8 ns: $(1 \text{ to } 2^{20}) \times \text{sample period}$. Accuracy is 2 ns to -sample period - 2 ns +/- 0.01%.

Qualifier A user-specified term that can be any state, no state, any recognizer, (patterns ranges or glitch/edges), any timer, or the logical combination (NOT, AND, NAND, OR, NOR, XOR, NXOR) of the recognizers and timers.

Branching Each sequence level has a branching qualifier. When satisfied, the analyzer will branch to the sequence level specified.

Occurrence Counters Sequence qualifier may be specified to occur up to 1,048,575 times before advancing to the next level. Each sequence level has its own counter.

Maximum Occurrence Count 1,048,575

Storage Qualification (state only) Each sequence level has a storage qualifier that specifies the states that are to be stored.

Maximum Sequencer Speed 125 MHz

State Sequence Levels 12

Timing Sequence Levels 10

Timers Qty. 2. Timers may be Started, Paused, or Continued at entry into any sequence level after the first.

Timer Range 400 ns to 500 s

Timer Resolution 16 ns or 0.1% whichever is greater

Timer Accuracy +/- 32 ns or +/- 0.1%, whichever is greater

Timer Recovery Time 70 ns

Data In to Trigger Out BNC Port 110 ns typical

Measurement and Display Functions

Arming Each analyzer can be armed by the Run key, the other analyzer, or the Port In.

Trace Mode Single mode acquires data once per trace specification; repetitive mode repeats single mode acquisitions until stop is pressed or until pattern time interval or compare stop criteria are met.

Labels Channels may be grouped together and given a 6-character name. Up to 126 labels in each analyzer may be assigned with up to 32 channels per label. Trigger terms may be given an 8-character name

Activity Indicators Provided in the Configuration, State Format, and Timing Format menus for monitoring device-under-test activity while setting up the analyzer.

Markers Two markers (X and O) are shown as dashed lines in the display.

Trigger Displayed as a vertical dashed line in the timing waveform, state waveform and X-Y chart displays and as line 0 in the state listing and state compare displays.

Measurement Functions

Run Starts acquisition of data in specified trace mode.

Stop In single trace mode or the first run of a repetitive acquisition, Stop halts acquisition and displays the current acquisition data. For subsequent runs in repetitive mode, Stop halts acquisition of data and does not change current display.

Time Interval The X and O markers measure the time interval between events occurring on one or more waveforms or states (only available when time tagging is on).

Delta States The X and O markers measure the number of tagged states between any two states.

Patterns The X or O marker can be used to locate the nth occurrence of a specified pattern before or after trigger, or after the beginning of data. The O marker can also find the nth occurrence of a pattern before or after the X marker.

Statistics X to O marker statistics are calculated for repetitive acquisitions. Patterns must be specified for both markers, and statistics are kept only when both patterns can be found in an acquisition. Statistics are minimum X to O time, maximum X to O time, average X to O time, and ratio of valid runs to total runs.

Compare Mode Functions Performs a post-processing bit-by-bit comparison of the acquired state data and Compare Image data.

Compare Image Created by copying a state acquisition into the compare image buffer. Allows editing of any bit in the Compare Image to a 1, 0 or X.

Compare Image Boundaries Each channel (column) in the compare image can be enabled or disabled via bit masks in the compare Image. Upper and lower ranges of states (rows) in the compare image can be specified. Any data bits that do not fall within the enabled channels and the specified range are not compared.

Stop Measurement Repetitive acquisitions may be halted when the comparison between the current state acquisition and the current Compare Image is equal or not equal.

Compare Mode Displays Compare Listing display shows the Compare Image and bit masks; Difference Listing display highlights differences between the current state acquisition and the Compare Image.

Data Entry/Display

Display Modes State listing, State Waveforms, State Chart, State Compare Listing, Compare Difference Listing, Timing Waveforms, Timing Listings, interleaved time-correlated listing of two state analyzers (time tagging on), time- correlated State Listing and Timing Waveform on the same display.

State X-Y Chart Display Plots value of a specified label (on y-axis) versus states or another label (on x-axis). Both axes can be scaled.

Markers Correlated to state listing, state compare, and state waveform displays. Available as pattern, time, or statistics (with time counting) and states (with state counting on).

Accumulate Chart display is not erased between successive acquisitions.

State Waveform Display Displays state acquisitions in waveform format.

States/division 1 to 1000 states.

Delay -8191 to +8192 states.

Accumulate Waveform display is not erased between successive acquisitions.

Overlay Mode Multiple channels can be displayed on one waveform display line.

Displayed Waveforms 24 lines maximum on one screen. Up to 96 lines may be specified and scrolled through.

Timing Waveform Display Displays timing acquisition in waveform format.

Sec/div 1 ns to 1000 s; 0.01% resolution.

Delay -2,500 s to +2,500 s.

Accumulate Waveform display is not erased between successive acquisitions.

Overlay Mode Multiple channels can be displayed on one waveform display line. When waveform size set to large, the value represented by the waveforms is displayed inside the waveforms in selected base.

Displayed Waveforms 24 lines maximum on one screen. Up to 96 lines may be specified and scrolled through.

Bases Binary, Octal, Decimal, Hexadecimal, ASCII (display only), User-defined symbols, two's complement.

Symbols

Pattern Symbols User can define a mnemonic for the specific bit pattern of a label. When data display is SYMBOL, mnemonic is displayed where the bit pattern occurs.

Range Symbols User can define a mnemonic covering a range of values. When data display is SYMBOL, values within the specified range are displayed as mnemonic + offset from base of range.

Number of Symbols 1000 maximum.



Operating Environment

Temperature: Instrument, 0°C to 55°C.
Probe lead sets and cables, 0°C to 65°C (32°F to 149°F).

Humidity: Instrument, probe lead sets, and cables, up to 95% relative humidity at 40°C (122°F).

Indoor Use Only

Pollution degree 2

Altitude: to 4.6 km (15,000ft).

Vibration: Operating: Random vibration 5 to 500 Hz,
10 minutes per axis, 0.3g (rms).
Non-operating: Random vibration 5 to 500 Hz,
10 minutes per axis, 2.41g (rms);
and swept sine resonant search, 5 to 500 Hz,
0.75g (0-peak), 5 minute resonant dwell at 4 resonances per axis.



Operator's Service

Operator's Service

This chapter provides the operator with information on how to prepare the logic analyzer for use, and contains self-tests and flow charts used for troubleshooting the logic analyzer.

Preparing For Use

This section gives you instructions for preparing the logic analyzer for use.

Power Requirements

The logic analyzer requires a power source of either 115 Vac or 230 Vac, -22 % to +10 %, single phase, 48 to 66 Hz, 200 Watts maximum power.

Operating Environment

The operating environment is listed in chapter 19. Note the noncondensing humidity limitation. Condensation within the instrument can cause poor operation or malfunction. Provide protection against internal condensation.

The logic analyzer will operate at all specifications within the temperature and humidity range given in chapter 19. However, reliability is enhanced when operating the logic analyzer within the following ranges:

- Temperature: +20 °C to +35 °C (+68 °F to +95 °F)
- Humidity: 20% to 80% noncondensing

Storage

Store or ship the logic analyzer in environments within the following limits:

- Temperature: -40 °C to + 75 °C
- Humidity: Up to 90% at 65 °C
- Altitude: Up to 15,300 meters (50,000 feet)

Protect the logic analyzer from temperature extremes which cause condensation on the instrument.

To inspect the logic analyzer

1 Inspect the shipping container for damage.

If the shipping container or cushioning material is damaged, keep them until you have checked the contents of the shipment and checked the instrument mechanically and electrically.

2 Check the supplied accessories.

Accessories supplied with the logic analyzer are listed in "Accessories" in chapter 1.

3 Inspect the product for physical damage.

Check the logic analyzer and the supplied accessories for obvious physical or mechanical defects. If you find any defects, contact your nearest Agilent Technologies Sales Office. Arrangements for repair or replacement are made, at Agilent Technologies' option, without waiting for a claim settlement.

Ferrites (1664A Only)

Ferrites are included in the logic analyzer accessory pouch for the logic analyzer cable. When properly installed, the ferrites reduce RFI emissions from the logic analyzer.

In order to ensure compliance of the logic analyzer to the CISPR11 Class A radio frequency interference (RFI) limits, you must install the ferrite to absorb radio frequency energy.

Note: Adding or removing the ferrite will not affect the normal operation of the analyzer.

Ferrite Installation Instructions

Use the following steps to install the ferrite on the logic analyzer cable.

- 1 Place the ferrite halves and spacer on the logic analyzer cable like a clamshell around the whole cable. The ferrite should be 10 cm (about 4 in) from the end of the cable shell as shown.

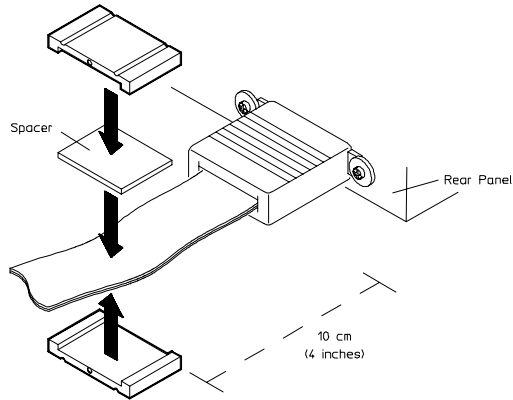

- 2 Insert the clamps onto the ends of the ferrites. The locking tab should fit cleanly in the ferrite grooves.

When properly installed, the ferrite should appear on the logic analyzer cable as shown.

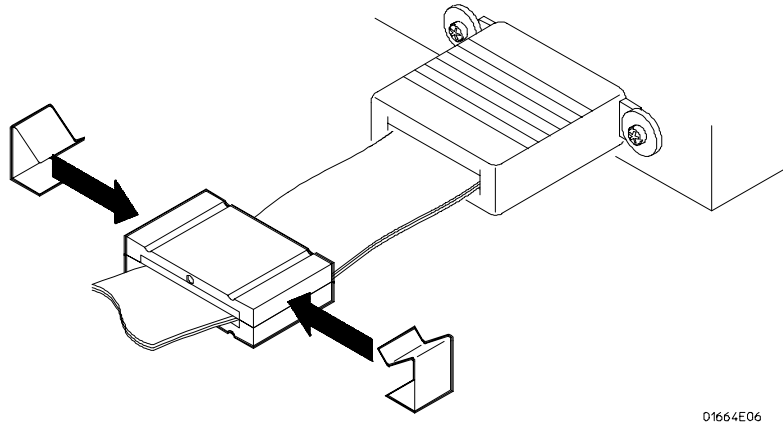

To apply power

CAUTION

Electrostatic discharge can damage electronic components. Use grounded wriststraps and mats when performing any service to the logic analyzer.

- 1** Check that the line voltage selector, located on the rear panel, is on the correct setting and the correct fuse is installed.

See also, "To set the line voltage" on the next page.

- 2** Connect the power cord to the instrument and to the power source.

This instrument is equipped with a three-wire power cable. When connected to an appropriate ac power outlet, this cable grounds the instrument cabinet. The type of power cable plug shipped with the instrument depends on the country of destination.

- 3** Turn on the instrument power switch located on the front panel.

To operate the user interface

To select a field on the logic analyzer screen, use the arrow keys to highlight the field, then press the Select key. For more information about the logic analyzer interface, refer to chapter 7.

To set the GPIB address or to configure for RS-232C or Centronix, refer to chapter 7.



To set the line voltage

When shipped from the factory, the line voltage selector is set and an appropriate fuse is installed for operating the instrument in the country of destination. To operate the instrument from a power source other than the one set, perform the following steps.

- 1 Turn the power switch to the Off position, then remove the power cord from the instrument.
- 2 Remove the fuse module by carefully prying at the top center of the fuse module until you can grasp it and pull it out by hand.

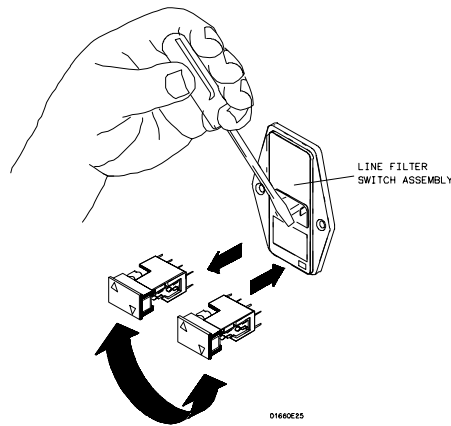

- 3 Reinsert the fuse module with the arrow for the appropriate line voltage aligned with the arrow on the line filter assembly switch.

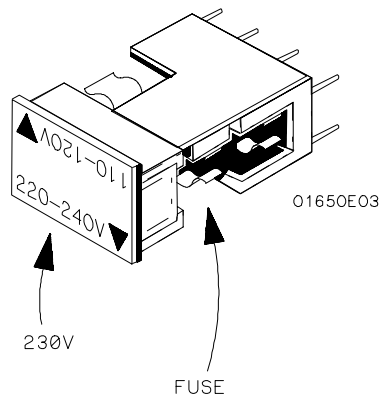
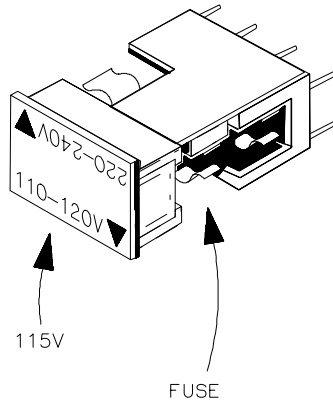

- 4 Reconnect the power cord. Turn on the instrument by setting the power switch to the On position.

To degauss the display

If the logic analyzer has been subjected to strong magnetic fields, the CRT might become magnetized and display data might become distorted. To correct this condition, degauss the CRT with a conventional external television type degaussing coil.

To clean the logic analyzer

With the instrument turned off and unplugged, use mild soap and water to clean the front and cabinet of the logic analyzer. Harsh soap might damage the water-base paint.

To test the logic analyzer

- If you require a test to verify the specifications, the *Agilent Technologies 1660 Series Logic Analyzer Service Manual* is required (*Agilent Technologies 1660 Series Logic Analyzer Service Manual for the 1664A*). Start at the beginning of chapter 3, "Testing Performance."
- If you require a test to initially accept the operation, perform the self-tests described in Troubleshooting in this chapter.
- If the logic analyzer does not operate correctly, go to the flow charts provided in Troubleshooting in this chapter.

Troubleshooting

This section helps you troubleshoot the logic analyzer to find the problem. The troubleshooting consists of flowcharts, self-test instructions, and tests.

If you suspect a problem, start at the top of the first flowchart. During the troubleshooting instructions, the flowcharts will direct you to perform other tests.

This instrument can be returned to Agilent Technologies for all service work, including troubleshooting. Contact your nearest Agilent Technologies Sales Office for more details.

To use the flowcharts

Flowcharts are the primary tool used to isolate problems in the logic analyzer. The flowcharts refer to other tests to help isolate the trouble. The circled letters on the charts indicate connections with the other flowcharts. Start your troubleshooting at the top of the first flowchart.

Operator's Service
To use the flowcharts

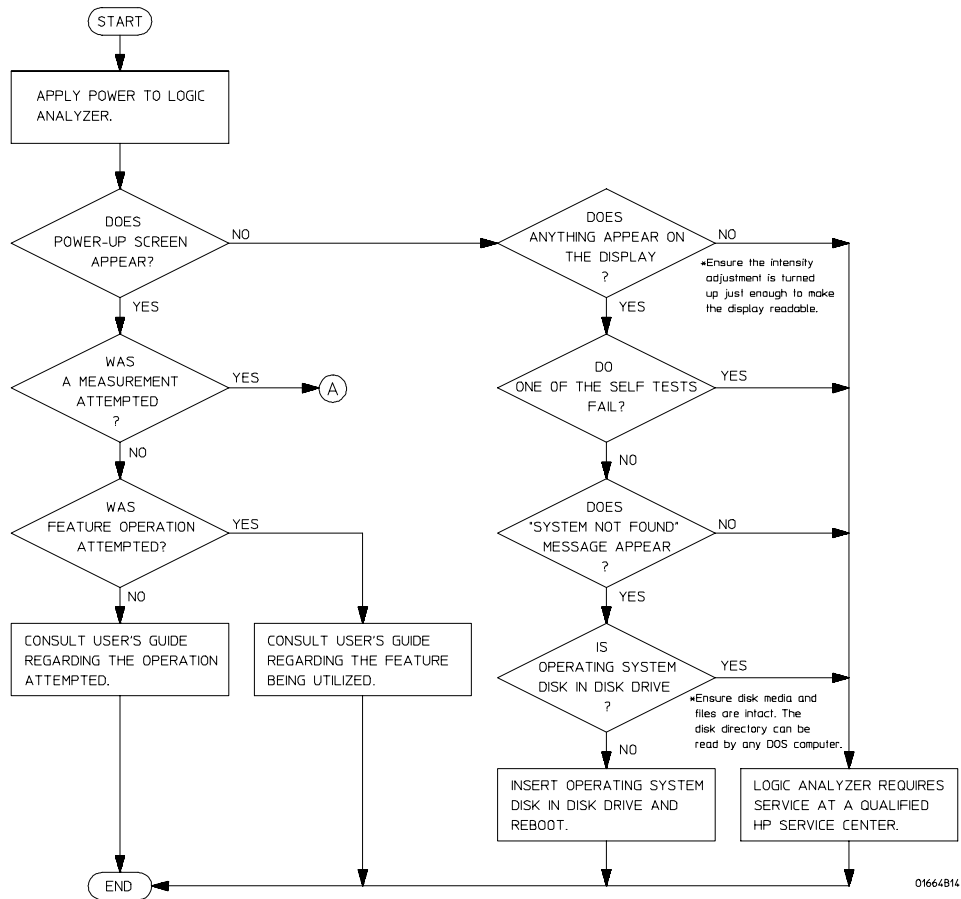

Troubleshooting Flowchart 1

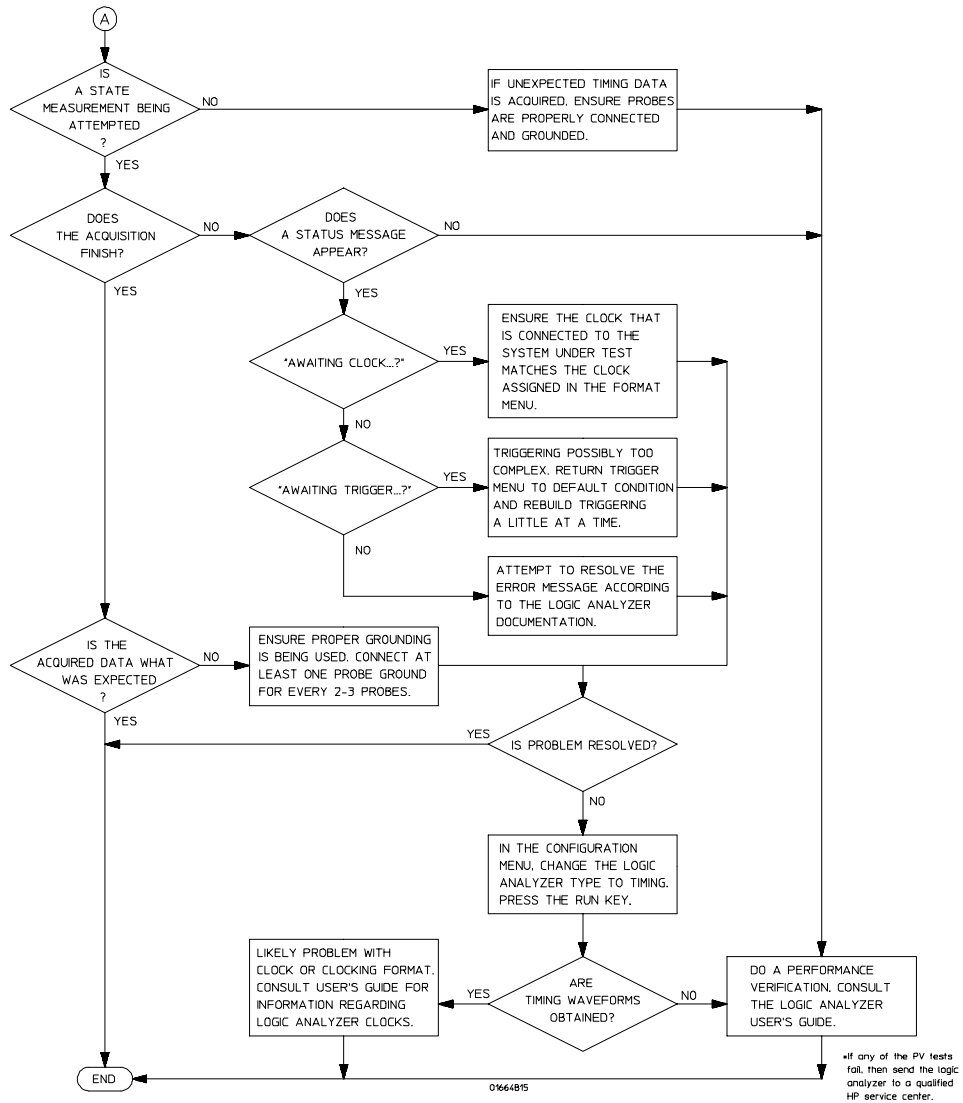

Troubleshooting Flowchart 2

To check the power-up tests

The logic analyzer automatically performs power-up tests when you apply power to the instrument. The revision number of the system boot ROM shows in the upper-right corner of the screen during these power-up tests. As each test completes, either "passed" or "failed" prints on the screen in front of the name of each test.

- 1 Disconnect all inputs, then insert a formatted disk into the disk drive.**
- 2 Let the instrument warm up for a few minutes, then cycle power by turning off then turning on the power switch.**

If the instrument is not warmed up, the power-up test screen will complete before you can view the screen.

- 3 As the tests complete, check if they pass or fail.**

The Front Disk Test reports No Disk if a disk is not in the disk drive.

Performing Power-Up Self-Tests

passed	ROM test
passed	RAM test
passed	Interrupt test
passed	Display test
passed	HIL Controller
passed	HIL Devices
No Disk	Front Disk Test

To run the self-tests (1660A through 1663A)

Self-tests identify the correct operation of major functional areas of the instrument. You can run all self-tests without accessing the interior of the instrument. If a self-test fails, the troubleshooting flowcharts instruct you to return the instrument to a qualified Agilent Technologies service center.

- 1 If you just did the power-up self-tests, go to step 2.

If you did not just do the power-up self-tests, disconnect all inputs, then turn on the power switch. Wait until the power-up tests are complete.

- 2 Press the System key, then select the field next to System. Then, select Test in the pop-up menu.

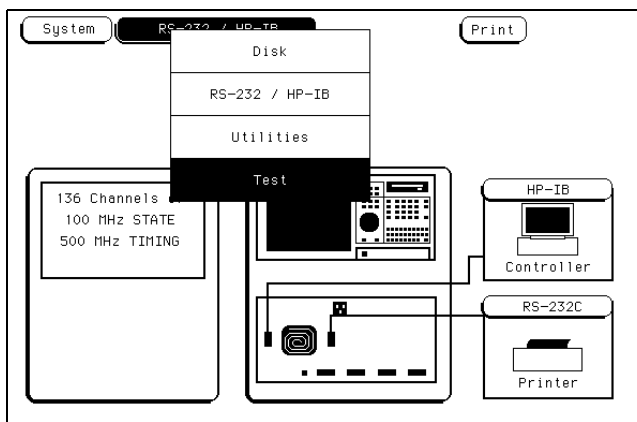

- 3 Insert the disk containing the performance verification tests (self-tests) into the disk drive. Select the box labeled Load Test System, then select Continue.
- 4 Press the System key, then select then field next to Sys PV. Select System Test to access the system tests.

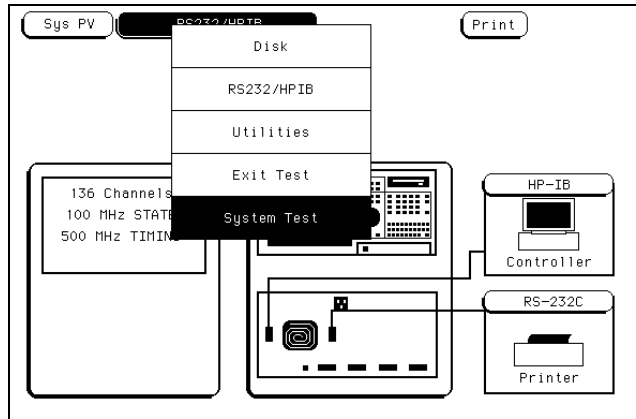

- 5 Select ROM Test. The ROM Test screen is displayed.

You can run all tests at one time by running All System Tests. To see more details about each test, you can run each test individually. This example shows how to run an individual test.

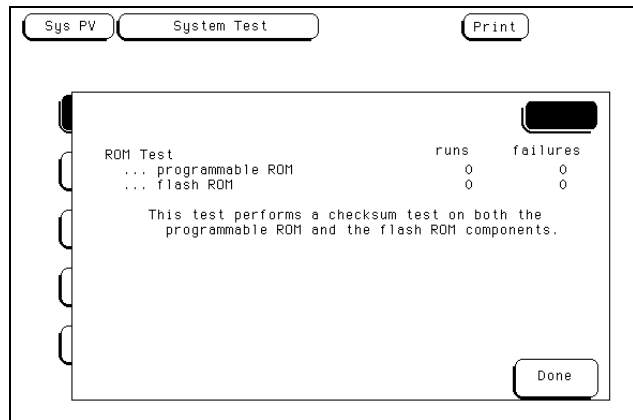

6 Select Run, then select Single.

To run a test continuously, select Repetitive. Select Stop to halt a repetitive test.

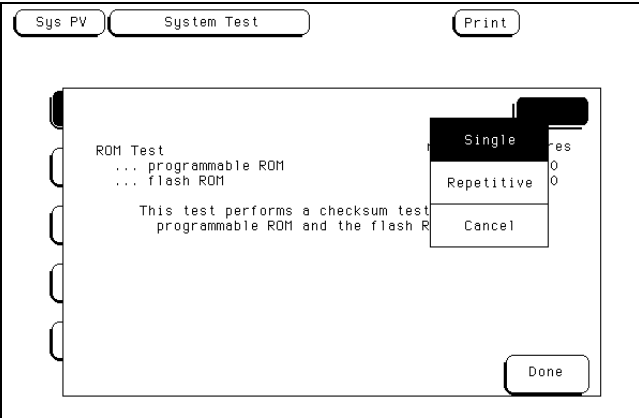

For a Single run, the test runs one time, and the screen shows the results.

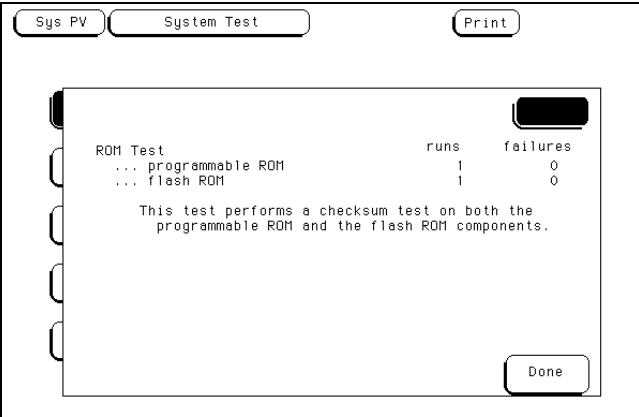

- 7 To exit the ROM Test, select Done. Note that the status changes to Passed or Failed.

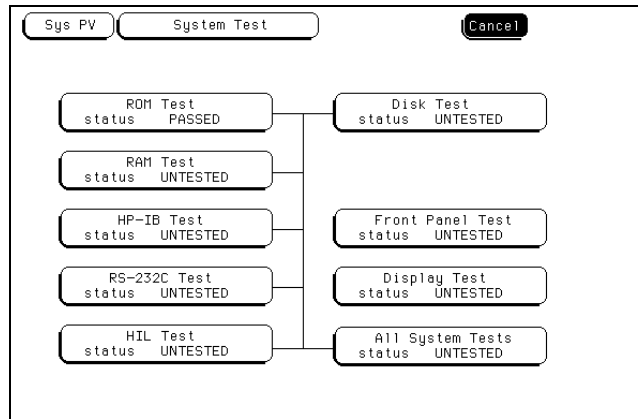

- 8 Install a formatted disk that is not write protected into the disk drive. Connect an RS-232C loopback connector onto the RS-232C port. Run the remaining System Tests in the same manner.

- 9 Select the Front Panel Test.

A screen duplicating the front-panel appears on the screen.

- Press each key on the front panel. The corresponding key on the screen will change from a light to a dark color.
- Test the knob by turning it in both directions.
- Note any failures, then press the Done key a second time to exit the Front Panel Test. The test screen shows the Front Panel Test status changed to Tested.

- 10 Select the Display Test.

A white grid pattern is displayed. These display screens can be used to adjust the display.

- Select Continue and the screen changes to full bright.
- Select Continue and the screen changes to half bright.
- Select Continue and the test screen shows the Display Test status changed to Tested.

- 11 Select Sys PV, then select Analy PV in the pop-up menu. Select Chip 2 Tests.

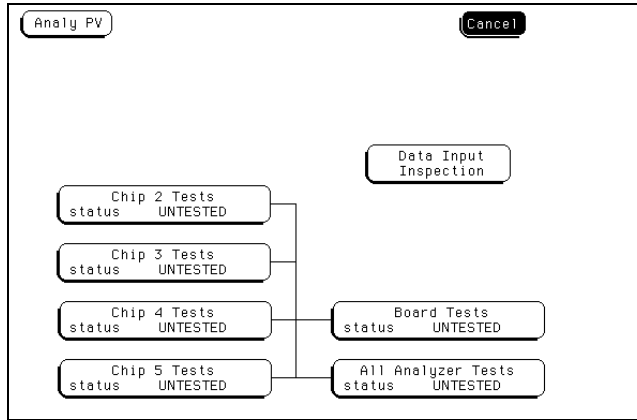

You can run all the analyzer tests at one time by selecting All Analyzer Tests. To see more details about each test, you can run each test individually. This example shows how to run Chip 2 Tests. Chip 3, 4, and 5 Tests operate the same as Chip 2 Tests.

- 12 In the Chip 2 Tests menu, select Run, then select Single. The test runs one time, then the screen shows the results. When the test is finished, select Done. Then, perform the other Chip Tests.

To run a test continuously, select Repetitive. Select Stop to halt a Run Repetitive.

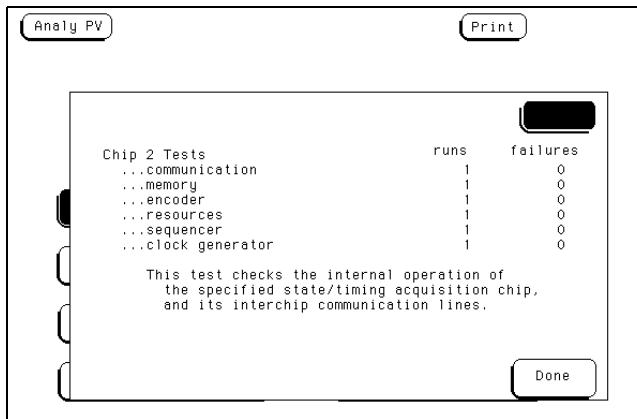

- 13** Select Board Tests, then select Run. When the Board Tests are finished, select Done.

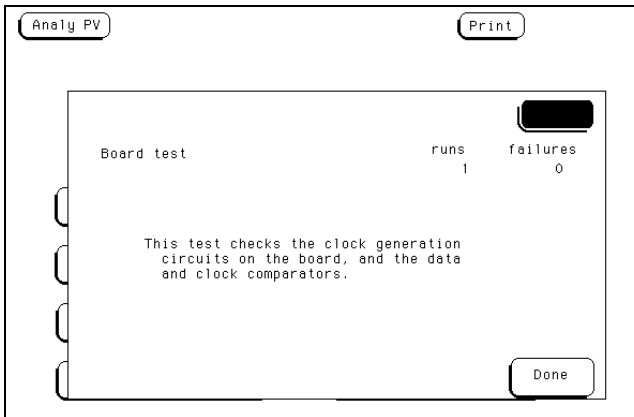

- 14** Select Data Input Inspection. All lines should show activity. Select Done to exit the Data Input Inspection.

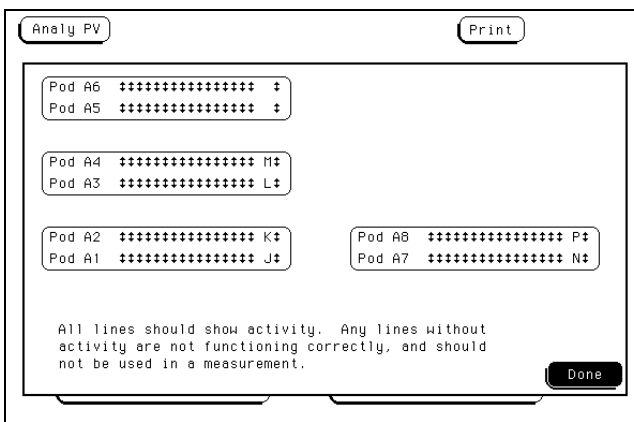

- 18** To exit the tests, press the System key. Select the field to the right of the Sys PV field.

- 19** Remove the disk containing the performance verification test, then select the Exit Test System.

If you are performing the self-tests as part of the troubleshooting flowchart, return to the flowchart.

To run the self-tests (1664A)

Self-tests identify the correct operation of major functional areas of the instrument. You can run all self-tests without accessing the interior of the instrument. If a self-test fails, the troubleshooting flowcharts instruct you to return the instrument to a qualified Agilent Technologies service center.

- 1 If you just did the power-up self-tests, go to step 2.

If you did not just do the power-up self-tests, disconnect all inputs, insert the operating system disk, then turn on the power switch. Wait until the power-up tests are complete.

- 2 Press the System key, then select the field next to System. Select Test in the pop-up menu and then press the Select key.

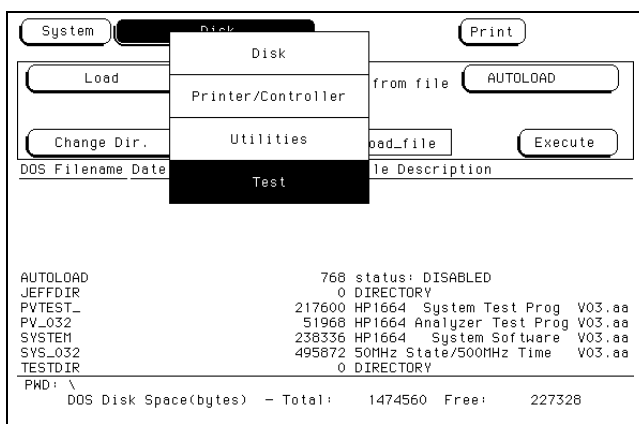

- 3 Select the box labeled Load Test System then press the select key. Insert the disk containing the performance verification tests (self-tests) into the disk drive (normally the same as the boot disk).
- 4 Select the box labeled Continue and press the Select key. After the test files have been loaded, and Analy menu is displayed.

You can run all the analyzer tests at one time by selecting All Analyzer Tests. To see more details about each test, you can run each test individually.

- 5 Select the Chip 5 Tests menu and press the Select key.

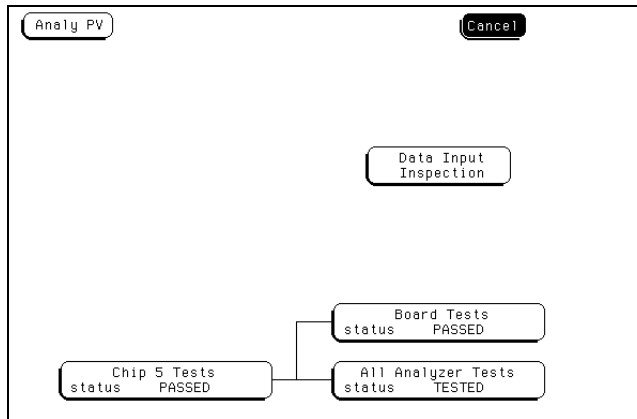

- 6 Select Run, then select Single. The test runs one time, then the screen shows the results. When the test is finished, select Done. To run a test continuously, select Repetitive. Select Stop to halt a Run Repetitive.

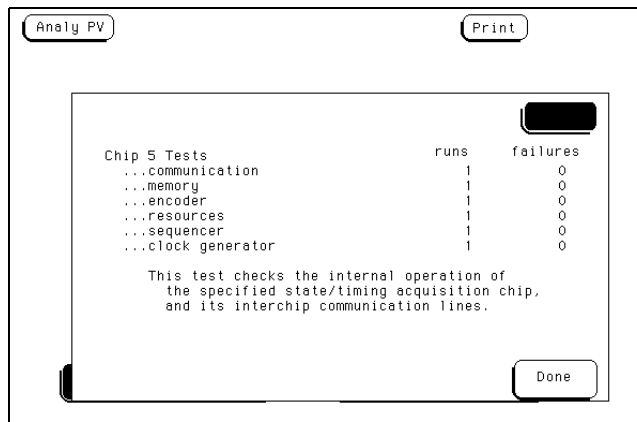

- 7 Select Board Tests, then select Run. When the Board Tests are finished, select Done.

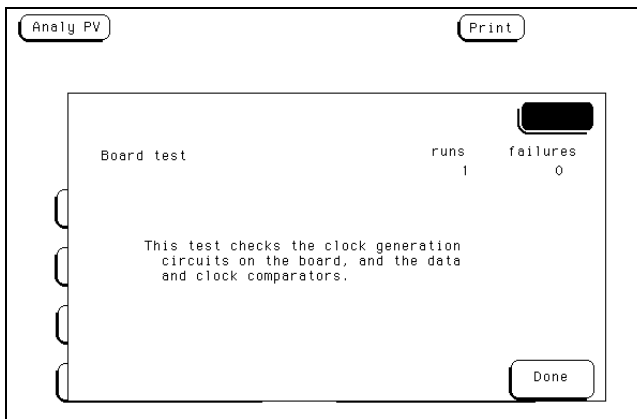

- 8 Select Data Input Inspection. All lines should show activity. Select Done to exit the Data Input Inspection.

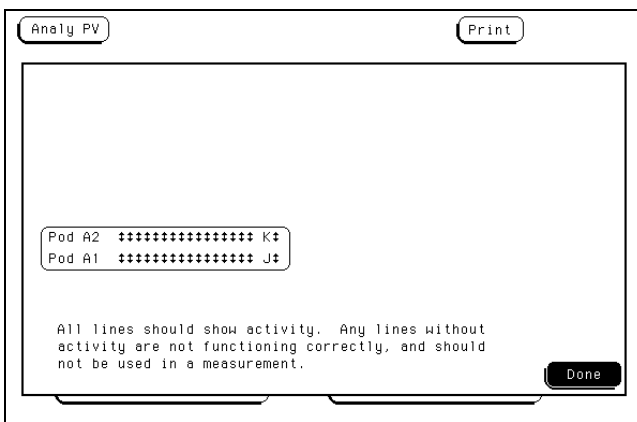

- 9 Select Analy PV, then select Sys PV PV in the pop up menu and press the Select key.

- 10 Select the Printer/Controller field next to Sys PV. Select System Test and press the Select key to access the system tests.

You can run all tests at one time by running All System Tests. To see more details about each test, you can run each test individually. This example shows how to run an individual test.

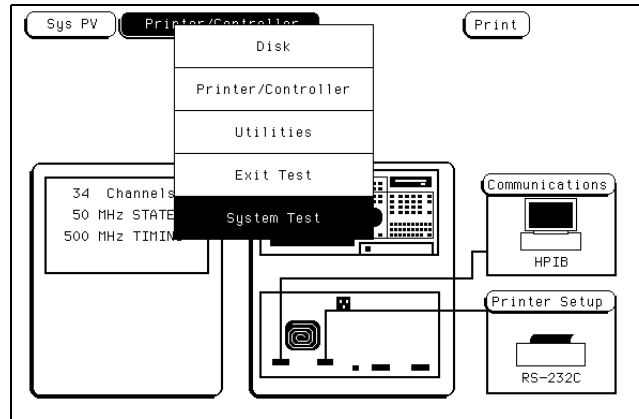

- 11 Select ROM Test. The ROM Test screen is displayed.

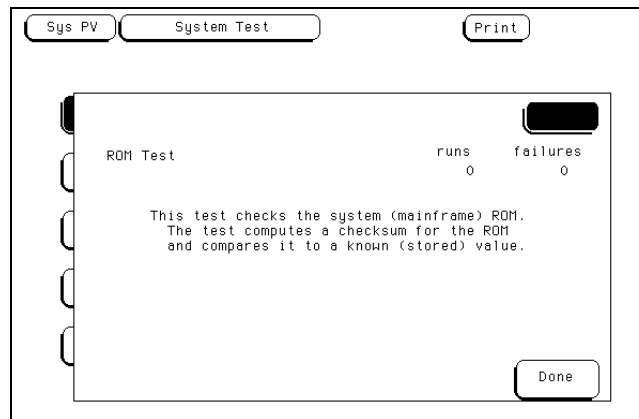

12 Select Run, then select Single.

To run a test continuously, select Repetitive. Select Stop to halt a repetitive test.

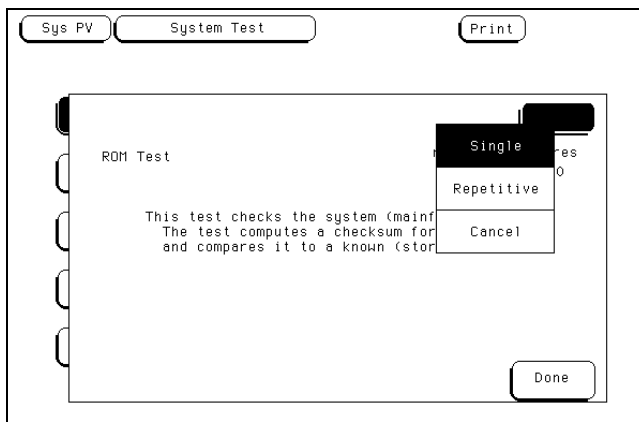

For a Single run, the test runs one time, and the screen shows the results.

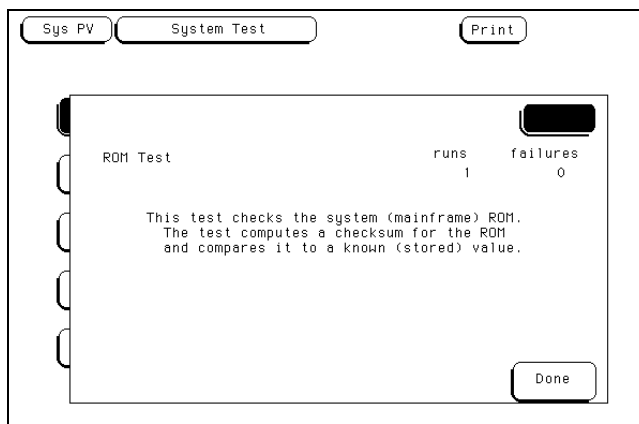

- 13** To exit the ROM Test, select Done. Note that the status changes to Passed or Failed.

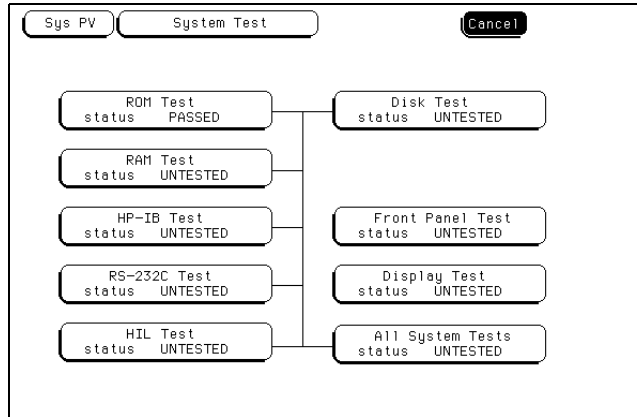

- 14** Install a formatted disk that is not write protected into the disk drive. If an 1664A with option 020 being tested, connect an RS-232C loopback connector onto the RS-232C port. Run the remaining System Tests in the same manner. If option 020 is not installed, the RS-232C test will return a FAILED status.

- 15** Select the Front Panel Test.

A screen duplicating the front-panel appears on the screen.

- Press each key on the front panel. The corresponding key on the screen will change from a light to a dark color.
- Test the knob by turning it in both directions.
- Note any failures, then press the Done key a second time to exit the Front Panel Test. The test screen shows the Front Panel Test status changed to Tested.

- 16** Select the Display Test.

A white grid pattern is displayed. These display screens can be used to adjust the display.

- Select Continue and the screen changes to full bright.
- Select Continue and the screen changes to half bright.
- Select Continue and the test screen shows the Display Test status changed to Tested.

- 17** To exit the tests, press the System key, then select Exit Test in the pop-up menu and press the select key. Reinstall the disk containing the operating system, then select Exit Test System and press the select key.

If you are performing the self-tests as part of the troubleshooting flowchart, return to the flowchart.



To test the auxiliary power

The +5 V auxiliary power is protected by a current overload protection device. If the current on pins 1 and 39 exceed 0.33 amps, the circuit will open. When the short is removed, the circuit will reset in approximately 1 minute. There should be +5 V after the 1 minute reset time.

Equipment Required

Equipment	Critical Specifications	Recommended Model/Part
Digital Multimeter	0.1 mV resolution, better than 0.005% accuracy	Agilent Technologies 3478A

- Using the multimeter, verify the +5 V on pins 1 and 39 of the probe cables.

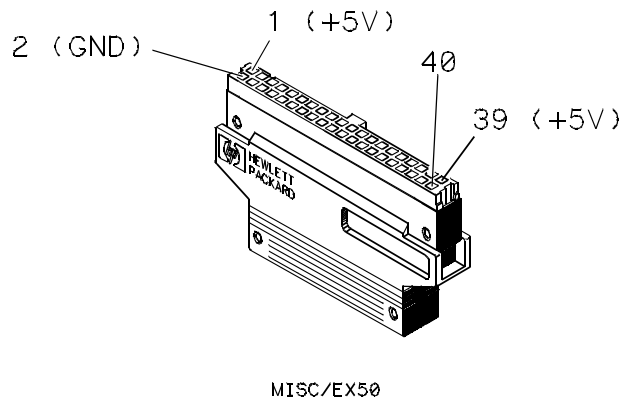

Index

- I**
- field less than 12-22
- field greater than 12-22
- A**
- Accessories
 - available 1-9 - 1-10
 - preprocessor modules 1-9
 - supplied 1-8
- Accumulate field 14-6
- Acquisition control
 - mode types 12-36
 - trigger position 12-37
- Acquisition Control field 14-5
- Acquisition Mode 12-36
- Activity Indicators 10-7
- Advisory Messages 18-8
- analyzer
 - configuration capabilities 1-5 - 1-6
- Analyzer field 9-4
- Analyzer type considerations
 - clock types iii-iv
 - state iii-iv
 - timing iii-iv
- Applying Power 20-6
- Arming
 - between analyzers 12-34
- Arming control field 12-33 - 12-35
- ASCII, print to disc 9-8
- Assignment/Specification Menus
 - description 3-25 - 3-29
 - Specifying Edges 3-28
 - Specifying Patterns 3-27
- Autoload 6-2
 - enabling 6-17
- Auxiliary Power 20-26
- B**
- Base field 9-10, 12-32
- Baud rate
 - defined 7-11
 - setting 7-11
- Bit Assignment 11-33 - 11-34
- Bit Editing field 17-16
- Bit patterns, using 12-20
- Bit reference line 11-33
- Branches Taken Stored/Not Stored 12-38
- Branching 12-19, 12-38
- Branching, using 12-25
- Break down/restore macros 12-10
- C**
- Center Screen field 14-17
- Centronix interface 7-2
 - defined 7-13
- Changing Alpha Entries 3-22
- Channel masking 17-11
- Chart Menu 16-2
 - clear pattern field 16-22
 - find x-pattern/o-pattern fields 16-13
 - from trigger/start/x-marker field 16-15
 - label and base fields 16-18
 - label/base roll field 16-18
 - markers field 16-11
 - menu field 16-29
 - menu map 16-3
 - min and max scaling fields 16-10
 - occurrence field 16-14
 - pattern display field 16-17
 - post-processing features 16-2
 - print field 16-29
 - run field 16-29
 - selecting axes for the chart 16-6
 - specify patterns field 16-16 - 16-18
 - stop measurement field 16-19 - 16-21
 - system/analyzer field 16-29
 - trig to x/trig to o fields 16-24, 16-28
 - X to O display field 16-24, 16-28
 - x-axes label/state value field 16-8
 - y-axes label value field 16-7
- Chart types
 - label value vs label value 16-3
 - label value vs states 16-3
- Cleaning 20-8
- Clear Display key 4-4
- Clear Line key 4-4
- Clear Pattern Field 13-16, 14-25, 16-22
- Clock Inputs Display 11-13
- Clocks
 - demultiplexed clocking arrangement 11-16
 - master clocking arrangement 11-15
 - selection 11-21
 - slave clocking arrangement 11-16
 - state configuration 10-4
 - timing configuration 10-4
- Common Menu Fields 9-2
 - base field 9-10
 - label field 9-11 - 9-12
 - label/base roll field 9-13
 - menu field 9-5
 - menu map 9-3
 - print field 9-6 - 9-8
 - run field 9-9
- Compare Full/Compare Partial field 17-10
- Compare image 17-5
- Compare Menu 17-2
 - bit editing field 17-16
 - compare full/compare partial field 17-10
 - copy trace to compare field 17-8
 - data roll field 17-15
 - difference listing field 17-6 - 17-7
 - find error field 17-9
 - label and base fields 17-17
 - label/base roll field 17-17
 - mask field 17-11
 - menu field 17-18
 - menu map 17-3
 - post-processing features 17-3
 - print field 17-18
 - reference listing field 17-5
 - run field 17-18
 - specify stop measurement 17-12 - 17-14
 - system / analyzer field 17-18
- Configuration Menu 10-2
 - activity indicators 10-7
 - menu field 10-8
 - menu map 10-2
 - name: field 10-3
 - print field 10-8
 - run field 10-8
 - system/analyzer field 10-8
 - type: field 10-4
- Configuring options 3-18
- Connecting
 - Grabbers to probes 2-11
 - probe cables to analyzer 2-8
- Controller interface
 - defined 7-7
- Conventional Acquisition Mode 11-5
- Copy 6-2, 6-20
- Copy Trace to Compare field 17-8
- Count Field 12-39 - 12-40

-
- cursor 1-4, 3-3
 - moving with home key 4-3
 - Cursor keys
 - duplicating knob motion 4-3
 - D**
 - Data bits
 - defined 7-11
 - supported 7-11
 - Data Roll field 13-23, 17-15
 - Degaussing the Display 20-8
 - Delay field
 - negative/positive 14-9
 - Delete Line key 4-4
 - Description
 - accessories supplied 1-8
 - configuration capabilities 1-5 - 1-6
 - key features 1-7
 - logic analyzer 1-2
 - user interface 1-4
 - Difference Listing field 17-6 - 17-7
 - Disk Drive 3-7
 - access menu 6-5
 - autoload a file 6-17 - 6-18
 - copy a file 6-20 - 6-21
 - duplicate a disk 6-23 - 6-24
 - format a disk 6-10 - 6-11
 - install a disk 6-6
 - load a file 6-8 - 6-9
 - make a directory 6-25 - 6-26
 - pack a disk 6-22
 - purge a file 6-19
 - rename a file 6-15 - 6-16
 - select an operation 6-7
 - store a file 6-12 - 6-14
 - Disk Drive Operations 6-2
 - Disk Eject Button 3-7
 - Disk operations
 - autoload 6-2
 - copy 6-2
 - default values 6-8, 6-10 - 6-12, 6-14 - 6-15
 - duplicate disk 6-2
 - format disk 6-2
 - load 6-3
 - pack disk 6-3
 - purge 6-3
 - rename 6-3
 - selecting 6-7
 - store 6-3
 - Disks
 - duplicating 6-23
 - formatting 6-10
 - installing 6-6
 - packing 6-22, 6-25
 - storing files on 6-12
 - Display
 - printing 5-17
 - Display adjustment 8-5
 - Don't Care Key 3-6
 - Done key 4-8
 - Duplicate disk 6-2, 6-23
 - E**
 - Edges
 - example of assignment 3-28
 - Entering alpha data 3-21 - 3-22
 - Entering numeric data 3-19 - 3-20
 - Environment
 - Operating 20-3
 - Storage 20-3
 - EPS, print to disk 9-8
 - Epson printers 5-3
 - F**
 - Ferrites 20-4 - 20-5
 - File types 6-15
 - Files
 - copying 6-20
 - loading 6-8
 - purging 6-19
 - renaming 6-15
 - storing 6-12
 - Find Error field 17-9
 - Find X Pattern/Find O Pattern fields 16-13
 - Find X-pattern/O-pattern 13-6
 - FLASH ROM Update 8-5
 - Flowcharts 20-9 - 20-11
 - Format a disk 6-10 - 6-11
 - Format disk 6-2, 6-10
 - Format Menu 11-2
 - bit assignment fields 11-33 - 11-34
 - clock inputs display 11-13
 - label and pod rolling fields 11-29
 - label assignment fields 11-30 - 11-31
 - label polarity fields 11-32
 - labels 11-30 - 11-31
 - master and slave clock field 11-21 - 11-22
 - menu field 11-35
 - menu map 11-2
 - pod clock field 11-15 - 11-18
 - pod threshold field 11-19 - 11-20
 - print field 11-35
 - run field 11-35
 - setup/hold field 11-23 - 11-24
 - state acquisition mode field 11-4
 - symbol field 11-25 - 11-28
 - system/analyzer field 11-35
 - timing acquisition mode field 11-5 - 11-12
- Formatting 6-10 - 6-11
 - From Trigger/Start/X-marker Field 13-8, 14-15, 16-15
 - Front-Panel Controls 3-3 - 3-7
 - Run Key 3-6
 - Front-Panel Interface
 - description 3-2
 - Function keys 4-5
 - Fuse 20-7
 - G**
 - General Purpose Probing 2-5 - 2-7
 - Glitch Acquisition Mode 11-5
 - GPIO Interface 7-2
 - configuring 7-14
 - defined 7-8
 - Listen Always 7-14
 - selecting an address 7-8 - 7-9
 - GPIO printers
 - configuration 5-5 - 5-6
 - Listen Always 5-3 - 5-4
 - setup 5-3
 - supported 5-3
 - Grabbers 2-7
 - I**
 - Illegal configuration 10-6
 - Importing labels 9-12
 - Indicator Light 3-7
 - Input Voltage for Probes 2-7
 - Inspection 20-4
 - interfaces
 - RS-232C 1-2
 - user 1-4
 - Interleave labels 9-12

K

keyboard 1-4, 4-2
 Clear Display key 4-4
 Clear Line key 4-4
 cursor keys 4-3
 defining units of measure 4-7
 Delete Line key 4-4
 Done key 4-8
 edge assignment 4-8
 edge trigger assignment keys 4-8
 Enter key 4-4
 function keys 4-5
 functions 4-2
 home key 4-3
 next and previous keys 4-3
 overlays 4-5 - 4-6
 Select key 4-4
 time unit keys 4-7
 Keyboard overlays
 function keys 4-5
 using 4-5
 knob 1-4

L

Label / Base roll field 9-13
 Label and Pod Rolling fields 11-29
 Label Assignment fields 11-30 - 11-31
 Label field 9-11 - 9-12
 delete 9-11
 insert 9-11
 interleave 9-12
 replace 9-11
 Label polarity fields 11-32
 Labels 11-30 - 11-31
 Labels field 12-32
 Line Voltage Selector 20-7
 Listen Always 5-3 - 5-4, 7-14
 Listing Menu 13-2
 clear pattern field 13-16
 data roll field 13-23
 find x-pattern/o-pattern field 13-6
 from trigger/start/x-marker field 13-8
 label and base fields 13-12, 13-24
 label/base roll field 13-12, 13-24
 markers field 13-4
 menu field 13-25
 menu map 13-2
 pattern display field 13-11

pattern occurrence field 13-7
 print field 13-25
 run field 13-25
 specify patterns field 13-9 - 13-12
 states markers 13-21
 statistics markers 13-19
 stop measurement field 13-13 - 13-15
 system/analyzer field 13-25
 trig to x/trig to o fields 13-18, 13-20, 13-22
 x and o entering/leaving fields 13-10
 x to o display field 13-18, 13-22
 Load 6-3, 6-8
 Loading on signal line 2-7
 Logic analyzer 1-2

M

Macros 12-11
 definition 12-11
 state 12-16 - 12-18
 timing 12-14 - 12-15
 using 12-13
 Marker Label/Base and Display 14-28,
 14-30, 14-33, 14-35
 Markers
 chart menu 16-12
 listing menu 13-5
 mixed display menu 15-5
 pattern 14-13
 states 13-21, 14-31, 16-27
 statistics markers 13-19, 14-29, 16-25
 time markers 13-17, 14-26, 16-23
 Markers field 13-4, 14-12, 16-11
 Mask field 17-11
 Master and Slave Clock field 11-21 - 11-22
 Master and Slave Clock selections 11-21
 Maximum Probe Input Voltage 2-7
 Menu Field 9-5
 Menu Keys 3-3
 Menu map
 system utilities 8-3
 Menu maps
 chart menu 16-3
 common menu fields 9-3
 compare menu 17-3
 configuration menu 10-2
 disk menu 6-4
 format menu 11-2
 listing menu 13-2

Printer/Controller menu 7-5
 RS-232/GPIB menu 7-3
 trigger menu 12-3
 waveform menu 14-2
 Microprocessor measurements 1-9
 Min and Max Scaling Fields 16-10
 Mixed Display
 markers 15-5
 Mixed Display Menu 15-2
 inserting waveforms 15-3
 interleaving state listings 15-3
 markers 15-5
 time-correlated displays 15-4
 Modify trigger field 12-8 - 12-10, 12-12
 Mouse 1-4
 connector 3-9
 how to use 4-4

N

Name: field 10-3
 Negative delay 14-9

O

Occurrence counters, using 12-23
 Occurrence field 13-7, 14-14, 16-14
 Occurs Field 12-23
 Operator's Service 20-2

P

Pack disk 6-3, 6-22, 6-25
 Paging data 3-23 - 3-24, 9-13
 Parity
 defined 7-11
 selecting 7-11
 Pattern durations, using 12-22
 Pattern Markers 13-5, 14-13, 16-12
 chart menu 16-12
 listing menu 13-5
 waveform menu 14-13
 Pattern occurrence fields 13-7, 14-14,
 16-14
 Patterns
 example of assignment 3-27
 PCX, print to disk 9-8
 Pod Clock Field 11-15 - 11-18
 Pod Field 11-4, 11-14
 Pod Grounding 2-6
 Pod Threshold

-
- levels 11-19
 - Pod Threshold field 11-19 - 11-20
 - Pod Thresholds 2-7
 - Pop-up Menus 3-15
 - Post-processing Features
 - chart menu 16-2
 - compare menu 17-3
 - Power On 3-10
 - Power Requirements 20-3
 - Power-up Tests 20-12
 - Pre-defined sequence type 12-11
 - Preparation for use 20-3
 - Preprocessors 1-9
 - using 1-9
 - Print all 9-7
 - Print disk 9-8
 - Print field 9-6 - 9-8
 - Print partial 9-7
 - Print screen 9-6
 - print to disk;ASCII 9-8
 - print to disk;B/W TIFF 9-8
 - print to disk;EPS 9-8
 - print to disk;Gray TIFF 9-8
 - print to disk;PCX 9-8
 - Printer
 - connecting to 5-2, 5-15 - 5-16
 - GPIB setup 5-3
 - GPIB type 5-3 - 5-7
 - making a hardcopy 5-17
 - Parallel setup 5-13
 - Parallel type 5-13 - 5-14
 - print to DOS disk 5-17
 - RS-232 setup 5-8
 - RS-232 type 5-8 - 5-12
 - Printer interface, defined 7-7
 - Printers
 - alternate 5-5 - 5-6, 5-10 - 5-11, 5-14
 - EpsonB 5-3
 - GPIB 5-3
 - other HP 5-15
 - RS-232C 5-8, 5-13
 - supported 5-2
 - Probe Cables 2-7
 - Probe Connecting
 - disconnecting probes from pods 2-10
 - grabbers to probes 2-11
 - grabbers to test points 2-11
 - pods to probe cables 2-9
 - Probe Cables to Analyzer 2-8 - 2-9
 - Probe Leads 2-6
 - Probe Tip Assemblies 2-5
 - Probing 2-2
 - assembly 2-8 - 2-12
 - general purpose 2-3
 - grabbers 2-7
 - maximum probe input voltage 2-7
 - microprocessor and bus 2-3
 - minimal signal amplitude 2-7
 - options 2-2
 - pod thresholds 2-7
 - probe and pod grounding 2-6
 - probe cable 2-7
 - probe leads 2-6
 - probe tip assemblies 2-5
 - termination adapter 2-3
 - user definable interface 2-2
 - Probing Options
 - 10320C User-Definable Interface 2-2
 - General Purpose Probing 2-3
 - Protocol
 - changing 7-12
 - defined 7-12
 - Purge 6-3, 6-19
- R**
- Real Time Clock Adjustment 8-4
 - Rear-Panel Controls 3-8 - 3-9
 - Rear-Panel Controls and Connectors
 - External Trigger BNCs 3-8
 - Fan 3-9
 - GPIB Interface Connector 3-9
 - Intensity Control 3-9
 - Line Power Module 3-8
 - Pod Cable Connectors 3-9
 - RS-232C Interface Connector 3-9
 - Reference Listing field 17-5
 - Rename 6-3, 6-15
 - Resource terms 12-26
 - assigning combinations 12-31
 - assigning custom names 12-28 - 12-31
 - assigning edges 12-30
 - assigning timers 12-31
 - bit patterns 12-26
 - edge terms 12-27
 - edges 12-26
 - range terms 12-26
 - timers 12-27
 - using bit by bit 12-29
 - using presets 12-28
 - RFI Emission 20-4
 - Rolling data 3-23 - 3-24, 9-13
 - RS-232C interface 7-2
 - configuring 7-14
 - defined 7-10
 - RS-232C printers
 - configuration 5-10 - 5-11, 5-13
 - setup 5-8, 5-13
 - supported 5-8, 5-13
 - Run field 9-9
 - Run repetitive 9-9
 - Run single 9-9
- S**
- Sample period 12-38
 - Sample Period Display 14-10 - 14-11
 - Scaling the Axes 16-9
 - Seconds per division field 14-8
 - Select key 4-4
 - Selecting fields 3-15 - 3-17
 - Selecting Menus 3-11 - 3-14
 - selecting waveforms display 14-36 - 14-38
 - delete and delete all fields 14-38
 - waveform display size 14-38
 - Self-Tests 20-13 - 20-25
 - Sequence levels
 - branching 12-19, 12-25
 - definition 12-6
 - editing 12-7
 - types 12-6
 - usage 12-6
 - Setting Line Voltage 20-7
 - Setup/Hold field 11-23 - 11-24
 - Signal Line Loading 2-7
 - Sound adjustment 8-5
 - Specify Patterns field 13-9 - 13-12, 14-18 - 14-21, 16-16 - 16-18
 - Specify Stop Measurement 17-12 - 17-14
 - compare 17-13
 - x - o 17-14
 - Specifying Edges 3-28
 - Specifying Patterns 3-27
 - State Acquisition Mode
 - full channel 4K memory 11-4
 - half channel 8K memory 11-4
-

-
- State Acquisition Mode Field 11-4
 - State Data in Timing Waveform Display 14-37
 - State tags 12-39
 - State/State display 9-12
 - States Markers 13-21
 - chart menu 16-27
 - waveform menu 14-31
 - States per Division field 14-7
 - Statistics Markers 16-25
 - chart menu 16-25
 - listing menu 13-19
 - waveform menu 14-29
 - Stop bits
 - changing 7-11
 - defined 7-11
 - Stop Measurement field 13-13 - 13-15, 14-22 - 14-24, 16-19 - 16-21
 - compare 13-15, 14-24, 16-21
 - x - o 13-14, 14-23, 16-20
 - Storage qualification, using 12-22
 - Store 6-3, 6-12
 - Storing Branches 12-38
 - Symbol field 11-25 - 11-28
 - Symbol tables 11-25
 - Symbols 11-25
 - add 11-28
 - delete 11-28
 - label and base fields 11-26
 - modify name 11-28
 - name field 11-27
 - pattern and range fields 11-27
 - width field 11-27
 - System field 9-4
 - System Front Disk menu
 - accessing 6-5
 - menu map 6-4
 - System menu subset 9-4
 - System Rear Disk menu
 - menu map 6-4
 - System Utilities 8-2
 - System Utilities Menu
 - described 8-2
- T**
- Tagging Data 12-39 - 12-40
 - Template 17-5
 - Termination Adapter 2-3
 - Testing 20-8
 - TIFF, B/W; print to disk 9-8
 - TIFF, Gray, print to disk 9-8
 - Time Markers
 - chart menu 16-23
 - listing menu 13-17
 - waveform menu 14-26
 - Time tags 12-40
 - Time unit keys 4-7
 - Time-Correlated Displays 15-4
 - Timers, using 12-24
 - Timing Acquisition Mode 11-6
 - conventional full Channel 11-5
 - conventional half channel 11-5
 - glitch 11-5
 - glitch half channel 11-5
 - Timing Acquisition Mode Field 11-5 - 11-12
 - Toggle Fields 3-17
 - Transitional Timing 11-6
 - full channel 125MHz mode 11-7
 - half channel 250MHz mode 11-9
 - other considerations 11-11
 - Trig to X/Trig to O Field 13-22
 - Trig to X/Trig to O Fields 13-18, 13-20, 14-27, 14-32, 16-24, 16-28
 - Trigger macros 12-11
 - Trigger Menu
 - count field 12-39 - 12-40
 - menu map 12-3
 - Trigger position 12-37
 - Trigger sequence levels 12-6
 - Troubleshooting 20-9
 - Type: field 10-4
- U**
- Unassigned Pods display 10-5 - 10-6
 - User Interface 1-4, 20-6
 - Changing Alpha Entries 3-22
 - configure options 3-18
 - entering alpha data 3-21 - 3-22
 - entering numeric data 3-19 - 3-20
 - keyboard 4-2
 - Pop-up Menus 3-15
 - Power On 3-10
 - rolling data 3-23 - 3-24
 - selecting fields 3-15 - 3-17
 - Selecting Menus 3-11 - 3-14
 - Toggle Fields 3-17
 - User's Reference iii-iii
 - analyzer type considerations iii-iv
 - User-Definable Interface 2-2
 - User-level macro, modify 12-19 - 12-25, 12-27
 - Utilities Menu
 - menu map 8-3
- W**
- Warning Messages 18-5 - 18-7
 - Waveform Display 14-34
 - Waveform Menu 14-2
 - accumulate field 14-6
 - acquisition control field 14-5
 - center screen field 14-17
 - clear pattern field 14-25
 - delay field 14-9
 - from trigger/start/x-marker field 14-15
 - label and base fields 14-21
 - label/base roll field 14-21
 - marker label/base and display 14-28, 14-30, 14-33, 14-35
 - markers field 14-12
 - menu field 14-39
 - menu map 14-2
 - pattern display field 14-20
 - print field 14-39
 - run field 14-39
 - sample period display 14-10 - 14-11
 - seconds per division field 14-8
 - specify patterns field 14-18 - 14-21
 - states per division field 14-7
 - stop measurement field 14-22 - 14-24
 - system / analyzer field 14-39
 - trig to X/trig to O fields 14-27, 14-32
 - waveform display 14-34
 - x and o entering/leaving fields 14-19
 - X to O display 14-32
 - X to O display field 14-16
 - x-pattern/o-pattern field occurrence field 14-14
 - Waveform reconstruction 14-11
-

X

X to O Display Field 13-18, 13-22, 14-32,
16-24, 16-28
X to O field 14-16
X-axes Label/State Value field 16-8

Y

Y-axes Label Value field 16-7

DECLARATION OF CONFORMITY

according to ISO/IEC Guide 22 and EN 45014

Manufacturer's Name: Agilent Technologies

Manufacturer's Address: Digital Design Product Generation Unit
1900 Garden of the Gods Road
Colorado Springs, CO 80907 USA

declares that the product

Product Name: Logic Analyzer

Model Number(s): 1664A

Product Option(s): All

conforms to the following Product Specifications:

Safety: IEC 348:1978 / HD 401 S1:1981
UL 1224
CSA-C22.2 No. 231 (Series M-89)

EMC: CISPR 11:1990 / EN 55011:1991 Group 1, Class A
IEC 555-2:1982 + A1:1985 / EN 60555-2:1987
IEC 555-3:1982 + A1:1990 / EN 60555-3:1987 + A1:1991
IEC 801-2:1991 / EN 50082-1:1992 4 kV CD, 8 kV AD
IEC 801-3:1984 / EN 50082-1:1992 3 V/m, {1kHz 80% AM, 27-1000 MHz}
IEC 801-4:1988 / EN 50082-1:1992 0.5 kV Sig. Lines, 1 kV Power Lines

Supplementary Information:

The product herewith complies with the requirements of the Low Voltage Directive 73/23/EEC and the EMC Directive 89/336/EEC and carries the CE marking accordingly.

This product was tested in a typical configuration with Agilent Technologies test systems.

Colorado Springs, 7/11/94

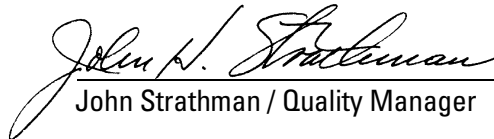
John Strathman / Quality Manager

European Contact: Your local Agilent Technologies and Service Office or Agilent Technologies GmbH, Department ZQ / Standards Europe, Herrenberger Strasse 130, D-71034 Böblingen Germany (FAX: +49-7031-14-3143)

Product Regulations

Safety IEC 348:1978 / HD 401 S1:1981
UL 1244
CSA-C22.2 No. 231 (Series M-89)

EMC This Product meets the requirement of the European Communities (EC)
EMC Directive 89/336/EEC.



Emissions EN55011/CISPR 11 (ISM, Group 1, Class A equipment)

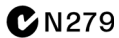

Immunity EN50082-1

	Code	Notes
--	------	-------

IEC 555-2	1	1
IEC 555-3	1	1
IEC 801-2 (ESD) 8kV AD	2	1
IEC 801-3 (Rad.) 3 V/m	1	1
IEC 801-4 (EFT) 0.5 kV, 1kV	1	1,2

Performance Codes:

- 1 Pass - Normal operation, no effect.
- 2 Pass - Temporary degradation, self recoverable.
- 3 Pass - Temporary degradation, operator intervention required.
- 4 Fail - Not recoverable, component damage.

Notes:

- 1 TTL logic threshold, all cables disconnected
- 2 The GPIB and RS232 cables were temporarily attached for the appropriate EFT test.

Sound Pressure Level Less Than 60 dBA

© Copyright Agilent Technologies 1991-2000
All Rights Reserved.
MS-DOS[®] is a US registered trademark of Microsoft Corporation.

Reproduction, adaptation, or translation without prior written permission is prohibited, except as allowed under the copyright laws.

Document Warranty

The information contained in this document is subject to change without notice.

Agilent Technologies makes no warranty of any kind with regard to this material, including, but not limited to, the implied warranties or merchantability and fitness for a particular purpose.

Agilent Technologies shall not be liable for errors contained herein or for incidental or consequential damages in connection with the furnishing, performance, or use of this material.

Complete product warranty information is given on the last page of this guide.

Safety

This apparatus has been designed and tested in accordance with IEC Publication 348, Safety Requirements for Measuring Apparatus, and has been supplied in a safe condition. This is a Safety Class I instrument (provided with terminal for protective earthing). Before applying power, verify that the correct safety precautions are taken (see the following warnings). In addition, note the external markings on the instrument that are described under "Safety Symbols."

Warning

- Before turning on the instrument, you must connect the protective earth terminal of the instrument to the protective conductor of the (mains) power cord. The mains plug shall only be inserted in a socket outlet provided with a protective earth contact. You must not negate the protective action by using an extension cord (power cable) without a protective conductor (grounding). Grounding one conductor of a two-conductor outlet is not sufficient protection.
- Only fuses with the required rated current, voltage, and specified type (normal blow, time delay, etc.) should be used. Do not use repaired fuses or short-circuited fuseholders. To do so could cause a shock or fire hazard.

- Service instructions are for trained service personnel. To avoid dangerous electric shock, do not perform any service unless qualified to do so. Do not attempt internal service or adjustment unless another person, capable of rendering first aid and resuscitation, is present.
- If you energize this instrument by an auto transformer (for voltage reduction), make sure the common terminal is connected to the earth terminal of the power source.
- Whenever it is likely that the ground protection is impaired, you must make the instrument inoperative and secure it against any unintended operation.
- Do not operate the instrument in the presence of flammable gasses or fumes. Operation of any electrical instrument in such an environment constitutes a definite safety hazard.
- Do not install substitute parts or perform any unauthorized modification to the instrument.
- Capacitors inside the instrument may retain a charge even if the instrument is disconnected from its source of supply.
- Use caution when exposing or handling the CRT. Handling or replacing the CRT shall be done only by qualified maintenance personnel.

Safety Symbols



Instruction manual symbol: the product is marked with this symbol when it is necessary for you to refer to the instruction manual in order to protect against damage to the product.



Hazardous voltage symbol.



Earth terminal symbol: Used to indicate a circuit common connected to grounded chassis.

WARNING

The Warning sign denotes a hazard. It calls attention to a procedure, practice, or the like, which, if not correctly performed or adhered to, could result in personal injury. Do not proceed beyond a Warning sign until the indicated conditions are fully understood and met.

CAUTION

The Caution sign denotes a hazard. It calls attention to an operating procedure, practice, or the like, which, if not correctly performed or adhered to, could result in damage to or destruction of part or all of the product. Do not proceed beyond a Caution symbol until the indicated conditions are fully understood or met.

Product Warranty

This Agilent Technologies product has a warranty against defects in material and workmanship for a period of one year from date of shipment. During the warranty period, Agilent Technologies will, at its option, either repair or replace products that prove to be defective.

For warranty service or repair, this product must be returned to a service facility designated by Agilent Technologies.

For products returned to Agilent Technologies for warranty service, the Buyer shall prepay shipping charges to Agilent Technologies and Agilent Technologies shall pay shipping charges to return the product to the Buyer. However, the Buyer shall pay all shipping charges, duties, and taxes for products returned to Agilent Technologies from another country.

Agilent Technologies warrants that its software and firmware designated by Agilent Technologies for use with an instrument will execute its programming instructions when properly installed on that instrument. Agilent Technologies does not warrant that the operation of the instrument software, or firmware will be uninterrupted or error free.

Limitation of Warranty

The foregoing warranty shall not apply to defects resulting from improper or inadequate maintenance by the Buyer, Buyer-supplied software or interfacing, unauthorized modification or misuse, operation outside of the environmental specifications for the product, or improper site preparation or maintenance.

No other warranty is expressed or implied. Agilent

Technologies specifically disclaims the implied warranties or merchantability and fitness for a particular purpose.

Exclusive Remedies

The remedies provided herein are the buyer's sole and exclusive remedies. Agilent Technologies shall not be liable for any direct, indirect, special, incidental, or consequential damages, whether based on contract, tort, or any other legal theory.

Assistance

Product maintenance agreements and other customer assistance agreements are available for Agilent Technologies products.

For any assistance, contact your nearest Agilent Technologies Sales Office.

Certification

Agilent Technologies certifies that this product met its published specifications at the time of shipment from the factory. Agilent Technologies further certifies that its calibration measurements are traceable to the United States National Institute of Standards and Technology, to the extent allowed by the Institute's calibration facility, and to the calibration facilities of other International Standards Organization members.

About this edition

This is the second edition of the Agilent Technologies 1660 Series 50/100-MHz State, 500-MHz Timing Logic Analyzers User's Reference Guide

Publication number
01660-97034

Printed in USA.

Edition dates are as follows:

Second edition, January 2000

First edition, October 1994

New editions are complete revisions of the manual.

Update packages, which are issued between editions, contain additional and replacement pages to be merged into the manual by you. The dates on the title page change only when a new edition is published.

A software or firmware code may be printed before the date. This code indicates the version level of the software or firmware of this product at the time the manual or update was issued. Many product updates do not require manual changes; and, conversely, manual corrections may be done without accompanying product changes. Therefore, do not expect a one-to-one correspondence between product updates and manual updates.

The following list of pages gives the date of the current edition and of any changed pages to that edition.

All pages original edition