

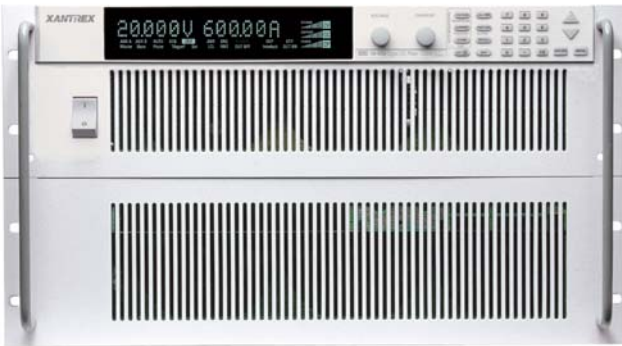

Smart choice for power

xantrex



- | | |
|-------------------|--------------------|
| XDC 10-600 | XDC 10-1200 |
| XDC 20-300 | XDC 20-600 |
| XDC 30-200 | XDC 30-400 |
| XDC 40-150 | XDC 40-300 |
| XDC 60-100 | XDC 60-200 |
| XDC 80-75 | XDC 80-150 |
| XDC 100-60 | XDC 100-120 |
| XDC 150-40 | XDC 150-80 |
| XDC 300-20 | XDC 300-40 |
| XDC 600-10 | XDC 600-20 |

Operating Manual

**XDC 6000 Watt
and 12000 Watt Series
Digital Programmable
DC Power Supply**



Operating Manual for

**XDC 6000 Watt and
12000 Watt Series
Digital Programmable
DC Power Supply**

Limited Warranty

What does this warranty cover and how long does it last?

This Limited Warranty is provided by Xantrex Technology, Inc. (“Xantrex”) and covers defects in workmanship and materials in your **XDC 6000 Watt or 12000 Watt Series Digital DC Power Supply**. This warranty lasts for a Warranty Period of **5 years** from the date of purchase at point of sale to you, the original end user customer.

What will Xantrex do?

Xantrex will, at its option, repair or replace the defective product free of charge, provided that you notify Xantrex of the product defect within the Warranty Period, and provided that Xantrex through inspection establishes the existence of such a defect and that it is covered by this Limited Warranty.

Xantrex will, at its option, use new and/or reconditioned parts in performing warranty repair and building replacement products. Xantrex reserves the right to use parts or products of original or improved design in the repair or replacement. If Xantrex repairs or replaces a product, its warranty continues for the remaining portion of the original Warranty Period or 90 days from the date of the return shipment to the customer, whichever is greater. All replaced products and all parts removed from repaired products become the property of Xantrex.

Xantrex covers both parts and labor necessary to repair the product, and return shipment to the customer via a Xantrex-selected non-expedited surface freight within the contiguous United States and Canada. Alaska and Hawaii are excluded. Contact Xantrex Customer Service for details on freight policy for return shipments outside of the contiguous United States and Canada.

How do you get service?

If your product requires troubleshooting or warranty service, contact your merchant. If you are unable to contact your merchant, or the merchant is unable to provide service, contact Xantrex directly at:

Phone:	604 422 8595
Toll Free North America:	1 800 667 8422
Fax:	604 421 3056
Email:	info@xantrex.com

Direct returns may be performed according to the Xantrex Return Material Authorization Policy described in your product manual. For some products, Xantrex maintains a network of regional Authorized Service Centers. Call Xantrex or check our website to see if your product can be repaired at one of these facilities.

In any warranty claim, dated proof of purchase must accompany the product and the product must not have been disassembled or modified without prior written authorization by Xantrex.

Proof of purchase may be in any one of the following forms:

- The dated purchase receipt from the original purchase of the product at point of sale to the end user, or
- The dated dealer invoice or purchase receipt showing original equipment manufacturer (OEM) status, or
- The dated invoice or purchase receipt showing the product exchanged under warranty

What does this warranty not cover?

This Limited Warranty does not cover normal wear and tear of the product or costs related to the removal, installation, or troubleshooting of the customer's electrical systems. This warranty does not apply to and Xantrex will not be responsible for any defect in or damage to:

- a. the product if it has been misused, neglected, improperly installed, physically damaged or altered, either internally or externally, or damaged from improper use or use in an unsuitable environment;
- b. the product if it has been subjected to fire, water, generalized corrosion, biological infestations, and high input voltage from lightning strikes;
- c. the product if repairs have been done to it other than by Xantrex or its authorized service centers (hereafter "ASCs");
- d. the product if it is used as a component part of a product expressly warranted by another manufacturer;
- e. the product if its original identification (trade-mark, serial number) markings have been defaced, altered, or removed.

Disclaimer Product

THIS LIMITED WARRANTY IS THE SOLE AND EXCLUSIVE WARRANTY PROVIDED BY XANTREX IN CONNECTION WITH YOUR XANTREX PRODUCT AND IS, WHERE PERMITTED BY LAW, IN LIEU OF ALL OTHER WARRANTIES, CONDITIONS, GUARANTEES, REPRESENTATIONS, OBLIGATIONS AND LIABILITIES, EXPRESS OR IMPLIED, STATUTORY OR OTHERWISE IN CONNECTION WITH THE PRODUCT, HOWEVER ARISING (WHETHER BY CONTRACT, TORT, NEGLIGENCE, PRINCIPLES OF MANUFACTURER'S LIABILITY, OPERATION OF LAW, CONDUCT, STATEMENT OR OTHERWISE), INCLUDING WITHOUT RESTRICTION ANY IMPLIED WARRANTY OR CONDITION OF QUALITY, MERCHANTABILITY OR FITNESS FOR A PARTICULAR PURPOSE. ANY IMPLIED WARRANTY OF MERCHANTABILITY OR FITNESS FOR A PARTICULAR PURPOSE TO THE EXTENT REQUIRED UNDER APPLICABLE LAW TO APPLY TO THE PRODUCT SHALL BE LIMITED IN DURATION TO THE PERIOD STIPULATED UNDER THIS LIMITED WARRANTY.

IN NO EVENT WILL XANTREX BE LIABLE FOR ANY SPECIAL, DIRECT, INDIRECT, INCIDENTAL OR CONSEQUENTIAL DAMAGES, LOSSES, COSTS OR EXPENSES HOWEVER ARISING WHETHER IN CONTRACT OR TORT INCLUDING WITHOUT RESTRICTION ANY ECONOMIC LOSSES OF ANY KIND, ANY LOSS OR DAMAGE TO PROPERTY, ANY PERSONAL INJURY, ANY DAMAGE OR INJURY ARISING FROM OR AS A RESULT OF MISUSE OR ABUSE, OR THE INCORRECT INSTALLATION, INTEGRATION OR OPERATION OF THE PRODUCT.

Exclusions If this product is a consumer product, federal law does not allow an exclusion of implied warranties. To the extent you are entitled to implied warranties under federal law, to the extent permitted by applicable law they are limited to the duration of this Limited Warranty. Some states and provinces do not allow limitations or exclusions on implied warranties or on the duration of an implied warranty or on the limitation or exclusion of incidental or consequential damages, so the above limitation(s) or exclusion(s) may not apply to you. This Limited Warranty gives you specific legal rights. You may have other rights which may vary from state to state or province to province.

Information WITHOUT LIMITING THE GENERALITY OF THE FOREGOING, UNLESS SPECIFICALLY AGREED TO BY IT IN WRITING, XANTREX

- a. MAKES NO WARRANTY AS TO THE ACCURACY, SUFFICIENCY OR SUITABILITY OF ANY TECHNICAL OR OTHER INFORMATION PROVIDED IN MANUALS OR OTHER DOCUMENTATION PROVIDED BY IT IN CONNECTION WITH THE PRODUCT; AND
- b. ASSUMES NO RESPONSIBILITY OR LIABILITY FOR LOSSES, DAMAGES, COSTS OR EXPENSES, WHETHER SPECIAL, DIRECT, INDIRECT, CONSEQUENTIAL OR INCIDENTAL, WHICH MIGHT ARISE OUT OF THE USE OF SUCH INFORMATION.

THE USE OF ANY SUCH INFORMATION WILL BE ENTIRELY AT THE USER'S RISK.

WARNING: Please refer to your product user manual for limitations on uses of the product.
Limitations on Use Specifically, please note that this power supply is not intended for use in connection with life support systems and Xantrex makes no warranty or representation in connection with any use of the product for such purposes.

Xantrex Technology, Inc.
8999 Nelson Way
Burnaby, British Columbia
Canada V5A 4B5

Information About Your Power Supply Please record the following information when you first open your Power Supply package:

Model Number	_____
Serial Number	_____
Purchased From	_____
Purchase Date	_____

Release Release 3.0 (2002-06)

Copyright © 2002 Xantrex Technology Inc. All rights reserved.
Printed in Canada

Warnings and Cautions

Warnings and cautions are defined and formatted in this manual as shown below.



WARNING

Describes a potential hazard which could result in injury or death, or, a procedure which, if not performed correctly, could result in injury or death.



CAUTION

Describes a procedure which, if not performed correctly, could result in damage to data, equipment, or systems.

Power Supply Safety



WARNING—High Energy and High Voltage

Exercise caution when using and calibrating a power supply. High energy levels can be stored at the output voltage terminals on a power supply in normal operation. In addition, potentially lethal voltages exist in the power circuit and on the output and sense connectors of a power supply with a rated output greater than 40 V. Filter capacitors store potentially dangerous energy for some time after power is removed.



CAUTION

Operate the power supply in an environment free of flammable gases or fumes. To ensure that the power supply's safety features are not compromised, use the power supply as specified in this manual and do not substitute parts or make any unauthorized modifications. Contact the service technician for service and repair help. Repairs must be made by experienced service technicians only.









CAUTION

For Use as a Battery Charger

When you are using any of these power supplies for battery charging applications, it is essential to provide an appropriately sized fuse or circuit breaker in series between the power supply output and the battery.

Installation of a protector (fuse or DC circuit breaker) rated for about 115% of the maximum current rating of the power supply and designed specifically to interrupt the DC voltage of the battery, will provide adequate reverse polarity current protection. Where several power supplies are in parallel, it is best to fuse each one, rather than one large fuse for all.

**IEC
Symbols
Used in This
Manual**

-  Earth (Ground) Terminal
-  Protective Conductor Terminal
-  On (Supply)
-  Off (Supply)
-  Warning (Shock Hazard)
-  Caution (Check manual for specific information.)

Approvals CE Mark

CE-marked units meet the following standards:

- IEC 1010-1-92 including Amendments 1 and 2:
 - Overvoltage Category II
 - Permanently Connected Equipment
- EN50081-2-1996 Electromagnetic Generic Emission - Industrial Equivalent
- EN50082-2-1995 Electromagnetic Compatibility Generic Immunity - Industrial Environment

CSA Certified

CSA C22.2 No. 1010.1-92

UL Listed (pending)

Meets UL3101-1 Electrical Equipment for Laboratory Use; Part 1: General Requirements

General safety requirements for electrical equipment intended for professional, industrial process, and educational use, including equipment and computing devices for: measurement and test; control; laboratory use; and accessories intended for use with the above.

FCC Compliance

FCC Part 15 - Radio Frequency Devices - Class A Limits

Canadian EMC Requirements

The unit complies with Canadian EMC requirements of ICES-001.

About This Manual

Who Should Use This Manual

This manual is designed for users who understand basic electrical theory, especially as applied to the operation of power supplies. This implies a recognition of constant voltage and constant current operating modes and the control of input and output power, as well as the observance of safe techniques while making connections to the supply and any changes in settings.

Navigation

To help you locate information easily, this manual has the following:

- A Table of Contents
- A List of Figures
- A List of Tables
- An Index

Sections

Section 1: About the XDC Power Supply describes the power supply features, front panel controls, front panel display, and rear panel connectors. It also gives an overview of operation.

Section 2: Installation describes how to mount the power supply, how to connect it, and how to run initial self-tests.

Section 3: Operation describes basic operation and functions carried out from the front panel using the function keys and menu options.

Section 4: Remote Operation explains how to hook up remote interfaces and how to send commands to the power supply through the SCPI programming language.

Section 5: Current Sharing (6000 Watt only) explains how to configure the power supply for current sharing among units connected in parallel.

Appendix A: Calibration describes calibration parameters and procedures.

About This Manual

Appendix B: SCPI Command Reference describes the Standard Commands for Programmable Instruments (SCPI) commands supported by this model.

Appendix C: Error Messages describes the error messages that could appear during operation.

Appendix D: GPIB describes the General Purpose Interface Bus (GPIB) commands and lines supported by this model.

Appendix E: Specifications and Characteristics provides electrical and mechanical specifications.

Revisions

The current release of this manual is listed below. Updates may be issued as an addendum.

Release 3.0 (2002-06)

Contents

About This Manual	ix
List of Tables	xvii
List of Figures	xix

Section 1. About The XDC Power Supply

Overview	21
Features	21
Front Panel	22
Display	28
Status Annunciators	28
Rear Panel	30
Overview of Operation	31
Power ON	31
Control Modes	31

Section 2. Installation

Overview	33
Basic Setup Procedure	33
Inspection, Cleaning, and Packaging	34
Initial Inspection	34
Maintenance	34
Returning Power Supplies to the Manufacturer	35
Return Material Authorization Policy	35
Packaging for Shipping or Storage	36
Location, Mounting, and Ventilation	37
Rack Mounting	37
Ventilation	39
AC Input Power	40
AC Input Connector	40
AC Input Wire	41
AC Wire Input Connection for 6000 W	41
AC Wire Input Connection for 12000 W	43
Basic Checks or Self-Tests	45
Equipment Required	45
Display Test	45
Power ON Check	46
Voltage Mode Operation Check	46
Current Mode Operation Check	47
Load Wiring	48
Current Carrying Capacity	48
Load Wiring Length for Operation with Sense Lines	49
Noise and Impedance Effects	49

Contents

Load Connections	50
Wire Size	50
Isolation	50
Single Load	51
Multiple Loads	52
Output Strain Relief/Cover	53
Remote Sensing	56

Section 3. Operation

Overview	57
Powering ON the Power Supply	57
Powering OFF the Power Supply	58
Power Supply Operating States	58
Power-On	58
Output Shutdown	58
Soft Start	58
Normal Operation	58
Calibration	58
Power Supply Regulation Modes	59
Constant Voltage (CV)	59
Constant Current (CC)	59
Constant Power (CP)	59
Automatic Mode Crossover	59
Remote Control Modes	60
Front Panel Controls	61
Function Keys	61
Menu Navigation	62
Top Level Menu Items	62
Control Knobs	63
Power Supply Operation	64
Set Voltage	64
Set Current	64
Set Power	65
Turn Output On or Off	65
Set Output Protection	65
Set Shutdown Recovery for AC Off and OTP	71
Respond to Alarms	72
Set Up Remote Control	74
Toggle Local/Remote	74
Select Remote Control Source	75
Configure Remote Control Source	76
Store User Settings	77
Change Stored Settings	78
Recall Settings	79
Read Error Messages	82
Configure User Lines	83
Configure Power ON Settings	84

Program Auto Sequence 87
 Programming a Sequence 88
 Deleting a Sequence 91
 Editing a Sequence Step 92
 Inserting a Sequence Step 93
 Deleting a Sequence Step 94
 Editing Repeat Times of a Sequence 95
 Editing Trigger Source of a Sequence 96
 Using Auto Sequencing 97
 Configure Display 98
 Lock Out Control Knobs 98
 Set V, I, and P Limits 100
 Slew Rate 102
 View Model Information 104
 Default Display 104
 View Power Output 104
 Monitor Status 104

Section 4. Remote Operation

Overview 105
 Making Connections for Remote Control 107
 Remote Analog Operation 108
 Analog Connections 108
 Configure Analog Control 110
 Using Remote Analog Control 112
 Multichannel Operation (6000 Watt only) 113
 Multichannel Connections 113
 Configuration 114
 Setup 114
 Using Multichannel Operation 115
 Multichannel Commands 116
 Multichannel Broadcast Commands 117
 Specifications 117
 RS-232 Operation 118
 RS-232 Connection 118
 Configuration 118
 Using RS-232 119
 GPIB Operation 120
 GPIB Connection 120
 Configuration 121
 Using GPIB 122
 SCPI Commands for Digital Interfaces 123
 Set Up Power ON Defaults 123
 Power On Output State 125
 Store User Settings 127
 Change Remote/Local Control of Power Supply 128

Contents

Enable Output	128
Program V,I,P	128
Configure V, I, P Protection Limits	130
Configure Other Protection Mechanisms	132
Clear Protection Event	134
View Power Supply Output	134
Configure Auxiliary Status Lines	134
Read Error Messages	135
Triggering Commands	136
Auto Sequencing	136
Programming Sequences	138
Auto Sequence Operation	140
Slew Rate	141
Identification Query	142
Option Identification Query	142
SCPI Version Query	142
Status Registers	142
Status Register Commands	157

Section 5. Current Sharing (6000 Watt only)

Overview	173
Theory of Operation	173
Configure Current Share	174
Setup Current Sharing Network	175
Operation	176
Errors	176
Specifications	177

Appendix A. Calibration

Overview	179
Entering Calibration Mode	179
Front Panel	180
SCPI	181
Security code	181
Setup and Equipment	182
Front Panel Calibration Procedure	183
Output Voltage	183
Output Current	183
Analog Programming Interface 0-5V Range	184
Analog Programming Interface 0-10V Range	187
Remote Interface Calibration Procedure	187
Output Voltage	187
Output Current	187
Analog Programming Interface 0-5V Range	188
Analog Programming Interface 0-10V Range	191
Exit calibration mode	192
Restore Factory Calibration	192

Appendix B. SCPI Command Reference

Overview 193

Codes and Standards 193

 IEEE 488.2 Requirements 193

 SCPI Requirements 193

IEEE-488.2/SCPI Syntax and Style 194

 Parameters 194

SCPI Command Hierarchy 194

Using SCPI Commands 195

 Using Minimum and Maximum 196

 Using Queries 196

 Terminating Characters 196

 Common Commands 196

Parameter Types 197

 Boolean Parameters 197

 Discrete Parameters 197

 Numeric Parameters 197

 String Parameters 197

SCPI Command Summary 198

 Notations Used in the Tables 198

Expressions 213

Appendix C. Error Messages

Overview 215

Command Error List 216

Execution Error List 216

Device-Specific Error List 218

Query Error List 219

User Request Event 219

Operation Complete Event 219

Front Panel Error Codes 220

CPU Error Codes 220

Analog Programming Interface Error codes 220

Auto Sequencing Error Codes 220

CANbus Error Codes 221

Multichannel Error Codes 221

Current Share Error Codes 222

Contents

Appendix D. GPIB

Overview	223
Codes and Standards	223
Message Terminators	223
Address Range	223
Primary Address	223
Secondary Address	223
Service Request and Polling	223
Protocol Specifications.	224
Multiline Control Functions	224
Interface Functions	224
Electrical Specifications	225
Driver Requirements	225
Mechanical Specifications	225
Performance Specifications	225

Appendix E. Specifications and Characteristics

Electrical Specifications—Summary	228
AC Line Input Specifications	236
AC Line Input Voltage Operating Ranges	236
Output Performance Specifications	237
Environmental Specification.	242
Thermal Specification	242
Humidity Specification	242
International Approvals	242
Mechanical Specification	243

Index

Index	245
-----------------	-----

List of Tables

Table 1.1	Front Panel Functions	26
Table 2.1	Basic Setup Procedure	33
Table 2.2	AC Wire Specification for 6000 Watt units.	41
Table 2.3	AC Wire Specification for 12000 Watt units.	41
Table 2.4	Current Carrying Capacity for Load Wiring	48
Table 3.1	Settings Affected by Recall	81
Table 4.1	User Line Pins	108
Table 4.2	Analog Programming Pins.	109
Table 4.3	Analog Pin Connections for Power Loop Back	110
Table 4.4	Analog Pin Connections with a Contact Closure	110
Table 4.5	CANbus Pins	113
Table 4.6	RS-232 Pins.	118
Table 4.7	GPIB Pins	120
Table 4.8	Features Affected by Reset (*RST) Command	126
Table 4.9	OPERation Status Register	145
Table 4.10	REGulating Sub-Register	146
Table 4.11	SHUTdown Sub-Register	146
Table 4.12	Protection SHUTdown Sub-Register	147
Table 4.13	Remote CONtrol Sub-Register	148
Table 4.14	Current SHare Sub-Register	148
Table 4.15	QUESTionable Status Register	151
Table 4.16	VOLTage Sub-Register	152
Table 4.17	CURRent Sub-Register	152
Table 4.18	POWER Sub-Register	152
Table 4.19	TEMPerature Sub-Register	153
Table 4.20	Standard Event Status Register	154
Table 4.21	Status Byte Summary Register	155
Table 4.22	Preset Values of User Configurable Registers	157
Table B.1	IEEE 488.2 Commands	199
Table B.2	Readback Commands	200
Table B.3	Commands for Output Control.	201
Table B.4	Commands for Current Share (6000 W only)	202
Table B.5	Commands for Calibration.	203
Table B.6	Command to Clear all Protection Mechanisms	203
Table B.7	Commands for Fold Protection	204
Table B.8	Commands for Triggering	204
Table B.9	System Commands	204

List of Tables

Table B.10	Status Commands	205
Table B.11	Protection Commands	209
Table B.12	User Lines	209
Table B.13	Output State	209
Table B.14	Auto Sequence Commands	210
Table B.15	Legacy Commands	212
Table B.16	Expressions	213
Table C.1	Command Error List	216
Table C.2	Execution Error List.	216
Table C.3	Device-Specific Error List	218
Table C.4	Query Error List.	219
Table C.5	User Request Event	219
Table C.6	Operation Complete Event	219
Table C.7	Front Panel Error Codes	220
Table C.8	CPU Error Codes	220
Table C.9	Analog Programming Interface Error code	220
Table C.10	Auto Sequencing Error Codes	220
Table C.11	CANbus Error Codes	221
Table C.12	Multichannel Error Codes	221
Table C.13	Current Share Error Codes.	222
Table D.1	Multiline Control Functions	224
Table D.2	Interface Functions	224
Table D.3	Driver Types for Interface Lines	225
Table E.1	Specifications for 6000 Watt units (10V to 60V Models).	228
Table E.2	Drift Specifications for 6000 Watt units (10V to 60V Models).	229
Table E.3	Specifications for 6000 Watt units (80V to 600V Models).	230
Table E.4	Drift Specifications for 6000 Watt units (80V to 600V Models).	231
Table E.5	Specifications for 12000 Watt units (10V to 60V Models).	232
Table E.6	Drift Specifications for 12000 Watt units (10V to 60V Models).	233
Table E.7	Specifications for 12000 Watt units (80V to 600V Models).	234
Table E.8	Drift Specifications for 12000 Watt units (80V to 600V Models).	235
Table E.9	AC Line Input Specifications.	236

List of Figures

Figure 1.1	Front Panel (6000 Watt)	22
Figure 1.2	Front Panel (12000 Watt)	23
Figure 1.3	Keypad	24
Figure 1.4	Front Panel Display	28
Figure 1.5	Front Panel Display, Status Annunciators	28
Figure 1.6	Rear Panel (6000 Watt low and medium output shown)	30
Figure 2.1	Typical Box Label for Storage	36
Figure 2.2	Unpacking the Power Supply (6000 Watt shown)	38
Figure 2.3	Mounting the Power Supply in the Rack With Support Rails	39
Figure 2.4	AC Input Connector for 6000 Watt units	40
Figure 2.5	Attaching the AC Input Wires for 6000 Watt units	42
Figure 2.6	Attaching the AC Input Wires for 12000 Watt units	44
Figure 2.7	Fastening the Output Wires (6000 Watt)	52
Figure 2.8	Output Bus Bar Cover for 6000 Watt units	53
Figure 2.9	Output for 12000 Watt units (Low and Medium Voltage)	53
Figure 2.10	Output Cover with Strain Relief for 6000 Watt units	54
Figure 2.11	Output for 12000 Watt units (High Voltage 300–600V)	55
Figure 4.1	View of Remote Interface Connections	107
Figure 4.2	Schematic For User Line Interface	109
Figure 4.3	Connections for Multichannel Operation	115
Figure 4.4	Operation Status Registers	144
Figure 4.5	Questionable Status Registers	150
Figure 4.6	IEEE 488.2 Status Register and Status Byte	153
Figure 5.1	Connections for Current Share Operation	173
Figure E.1	Power Supply Dimensions (6000 Watt unit)	243
Figure E.2	Power Supply Dimensions (12000 Watt unit)	244

List of Figures

Section 1. About The XDC Power Supply

Overview

The XDC Series of digital, programmable DC power supplies is designed for use in OEM, ATE, burn-in, magnet charging, and other high power systems for a broad range of applications. The XDC uses our newly developed digital technology which, combined with “Soft Switching,” provides superior performance and a high level of user control through both front panel and remote interfaces.

- Features**
- Digital processing for highly accurate control
 - Ten, 99-step auto sequences for easy bench-top programming of complex test routines
 - Ten stored settings
 - Zero voltage (soft) switching for low noise output, improved efficiency and higher reliability
 - Active Power Factor Correction (PFC) for lower input current draw and lower current harmonic generation
 - Remote voltage sense with 5V line drop compensation
 - Automatic Voltage/Current mode crossover
 - Constant power mode
 - Seven load protection mechanisms
 - Alarms and messages for over- and under-programmed trip points
 - Auxiliary status lines for monitoring power supply conditions
 - Remote interlock and trigger ports
 - Selectable standby, last setting, programmed sequence and other power-on defaults
 - Active current sharing with parallel connected units for higher power requirements*
 - Standard RS-232 remote control interface and optional GPIB (IEEE 488.2) port
 - CANbus communications link for multichannel addressing, and master/slave current sharing*
 - Extensive SCPI command set
 - Keypad, knobs, and arrow keys for fast and tactile front panel operation

About The XDC Power Supply

Front Panel

- Bright vacuum fluorescent display with annunciators to indicate complete supply status at a glance
- Front panel, software-based calibration
- Fully isolated analog programming and readback capabilities
- CE Mark, CSA Certified, FCC Compliance, UL (pending)

*These features are available on 6000 Watt units when the power supply is equipped with the optional GPIB/CANbus interface card.

Front Panel

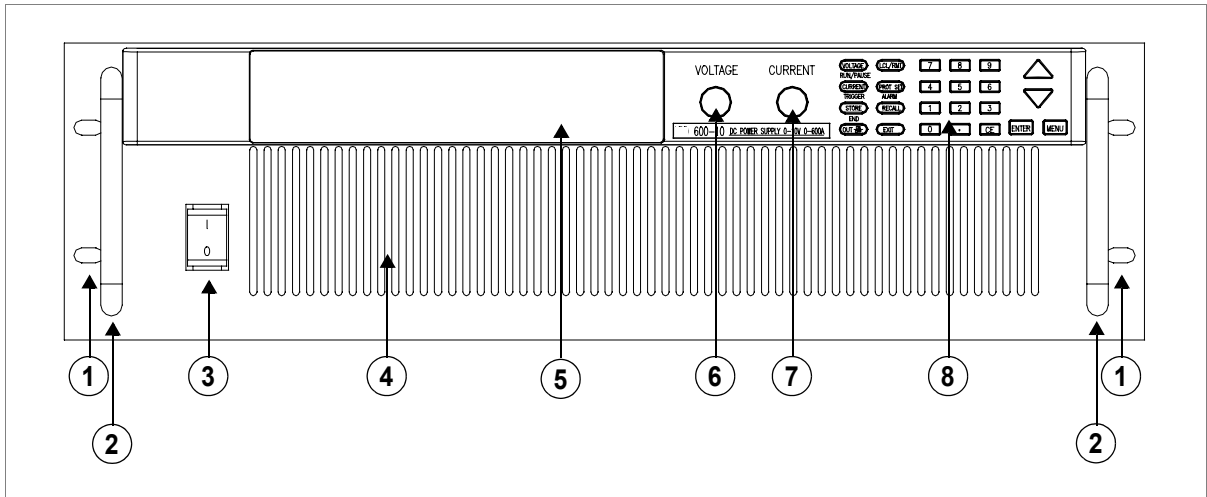

Figure 1.1 Front Panel (6000 Watt)

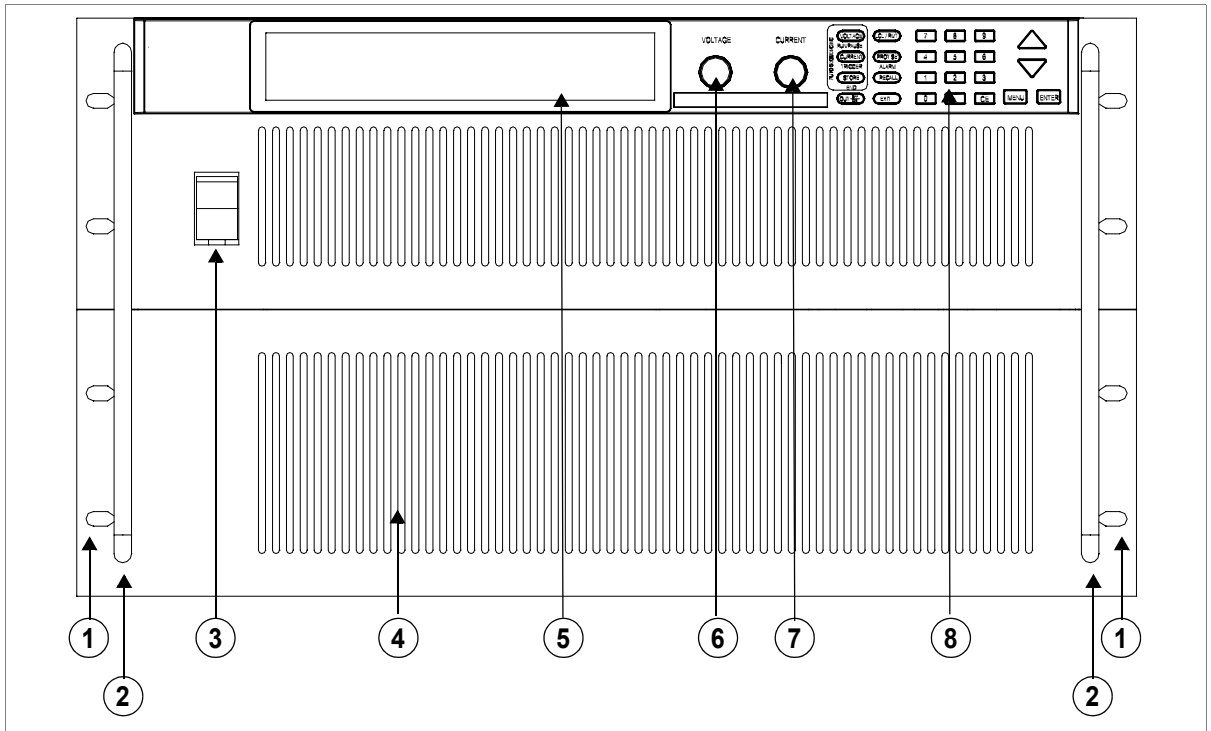

Figure 1.2 Front Panel (12000 Watt)

1. Rack mount brackets
2. Handles
3. On/Off switch
4. Air intake vents
5. Front panel display (vacuum fluorescent display). See Figure 1.4 for details.
6. Voltage knob
7. Current knob
8. Keypad. (See Figure 1.3 for details.)

About The XDC Power Supply

Front Panel

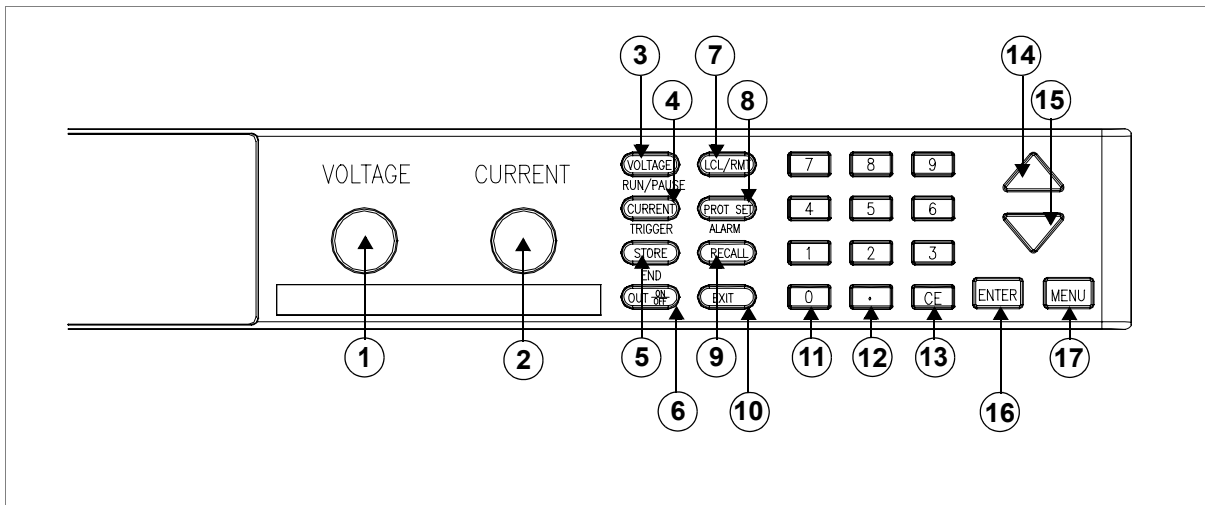

Figure 1.3 Keypad

1. **Voltage knob:** Turn knob to increase or decrease output voltage. (This is a velocity- sensitive rotary encoder.)
2. **Current knob:** Turn knob to increase or decrease output current limit. (This is a velocity-sensitive rotary encoder.)

Note The secondary functions for keys 3 to 5 listed below operate when the power supply is in Auto Sequence mode.

3. **VOLTAGE set key:** View and set voltage output setpoint.
RUN/PAUSE Auto Sequence Program: Start a selected program or pause the program.
4. **CURRENT set key:** View and set current output setpoint.
TRIGGER for Auto Sequence Program: Apply a trigger when requested. This key may also be used to advance to the next step in the program by pressing and holding.
5. **STORE settings key:** Save power supply output settings to one of ten locations.
END Auto Sequence Programming: Stop the program. The program will start from the beginning when RUN is pressed.
6. **OUT ON/OFF key:** Toggle between Output ON and Output OFF.
7. **LCL/RMT key:** Toggle between local mode and remote mode (or Go to Local for GPIB operation) except during calibration.

8. **PROTECTION SET key:** View and set protection setpoints.
ALARM response: Read and clear alarm messages. ALARM annunciator indicates if there are any alarm messages.
9. **RECALL settings key:** Apply stored power supply settings.
10. **EXIT key:** Cancel operation, exit menu or get out of Calibration mode or Auto Sequence mode. Automatic timeout will also cancel operation except calibration and auto sequence operation.
11. **Numeric keypad:** Numbers 0 to 9, used for data entry.
12. **Decimal key:** Enter a decimal. Used for data entry.
13. **CE key:** Clear the entire data field. Used for data entry. In Store User Setting mode, used to delete selected setting or program.
14. **Up arrow key:** Scroll through menus and lists, or, in data entry mode, increase the displayed value. In default operating mode, use this key to view the output power. In Auto Sequence Operating mode, use this key to view present sequence number, step numbers, and sequence loop count.
15. **Down arrow key:** Scroll through menus and lists, or, in data entry mode, decrease the displayed value.
16. **ENTER key:** Select a menu item or accept data.
17. **MENU key:** Access all menu functions.

About The XDC Power Supply

Front Panel

Table 1.1 Front Panel Functions

Key Functions				
Voltage Setpoint	<i>Enter voltage</i>			
Current Setpoint	<i>Enter current</i>			
Output ON/OFF Toggle				
Local/Remote Mode Toggle				
Protection Set	OVP level	<i>Enter OV level</i>		
	UVP level	<i>Enter UV level</i>	S/D if tripped?	<i>Select Y or N</i>
	OCP level	<i>Enter OC level</i>	S/D if tripped?	<i>Select Y or N</i>
	UCP level	<i>Enter UC level</i>	S/D if tripped?	<i>Select Y or N</i>
	OPP level	<i>Enter OP level</i>	S/D if tripped?	<i>Select Y or N</i>
	UPP level	<i>Enter UP level</i>	S/D if tripped?	<i>Select Y or N</i>
	Fold Mode	<i>Select fold mode</i>	<i>Select fold delay</i>	
Read Alarms	<i>Read alarm msgs</i>			
Store User Setting	<i>Select 1 to 10</i>			
Recall	<i>Factory default</i>			
	<i>Last setting</i>			
	<i>User setting</i>	<i>Select 1 to 10</i>		
	<i>Auto sequence</i>	<i>Select 1 to 10</i>		
Auto Sequence Operation (Run/Pause, Trigger, Stop)				
MENU	Access menu functions			
ENTER	Make a selection			
UP/DOWN	Scroll to view selections, increment numerical entries			
CE	Clear entry			
Numeric keypad	Enter data			
EXIT	Cancel operation			
Special Key Functions				
UP	View power readback (from default window)			
CE	Deletes a selected user setting from memory (Hold for 2 seconds)			
EXIT	Exit auto sequence			

Menu Function						
ERROR MSGS	<i>Read error msgs</i>					
USER LINES	Aux line A	<i>Configure aux line A</i>	<i>Set aux line A polarity</i>			
	Aux line B	<i>Configure aux line A</i>	<i>Set aux line B polarity</i>			
PON CONFIG	<i>Factory default</i>	<i>Set output on/off</i>				
	<i>Last setting</i>	<i>Set output on/off</i>				
	<i>User setting</i>	<i>Select 1 to 10</i>	<i>Set output on/off</i>			
	<i>Auto sequence</i>	<i>Select 1 to 10</i>	<i>Set output on/off</i>			
S/D RECOVERY	<i>Select OTP recovery</i>	<i>Select AC Off recovery</i>				
REMOTE SELECT	<i>Select remote interface</i>					
REMOTE CONFIG	RS-232	<i>Select baud rate</i>	<i>Select flow control</i>			
	GPIB	<i>Select address</i>	<i>Select PON SRQ</i>			
	Analog	<i>Select input voltage range</i>				
	Multichannel	<i>Select address</i>				
AUTO SEQ PGM	<i>Select Sequence</i>	<i>Edit Sequence</i>	<i>Select Step</i>	<i>Edit Step</i>	<i>Enter Value/Duration</i>	<i>To Next Step or EXIT to finish</i>
				<i>Insert Step</i>		
				<i>Delete Step</i>		
		<i>Set Repeat</i>	<i>#Select repetitions for sequence</i>			
		<i>Trig Source</i>	<i>Select trigger source</i>			
	<i>Delete Sequence</i>	<i>Confirm delete</i>				
CURRENT SHARE	<i>No sharing</i>					
	<i>Master Slave</i>	<i>Display summed current?</i>	<i>Select Y or N</i>			
POWER SETPOINT	<i>Set power</i>					
DISPLAY CONFIG	<i>Set display config</i>					
KNOB LOCKOUT	<i>Lock voltage knob? Lock current knob?</i>					
SETPOINT LIMIT	<i>Voltage limit</i>	<i>Enter max limit</i>	<i>Enter min limit</i>			
	<i>Current limit</i>	<i>Enter max limit</i>	<i>Enter min limit</i>			
	<i>Power limit</i>	<i>Enter max limit</i>	<i>Enter min limit</i>			
SLEW RATE	<i>Voltage slew</i>	<i>Enter voltage step</i>	<i>Enter time interval</i>			
	<i>Voltage slew default</i>					
CALIBRATION	<i>Calibrate voltage</i>					
	<i>Calibrate current</i>					
	<i>Calibrate analog 5V voltage programming</i>					
	<i>Calibrate analog 5V voltage readback</i>					
	<i>Calibrate analog 5V current programming</i>					
	<i>Calibrate analog 5V current readback</i>					
	<i>Calibrate analog 10V voltage programming</i>					
	<i>Calibrate analog 10V voltage readback</i>					
	<i>Calibrate analog 10V current programming</i>					
	<i>Calibrate analog 10V current readback</i>					
	<i>Restore factory calibration</i>					
<i>Change calibration security code</i>						

About The XDC Power Supply

Display

MODEL INFO [View info](#)

Display

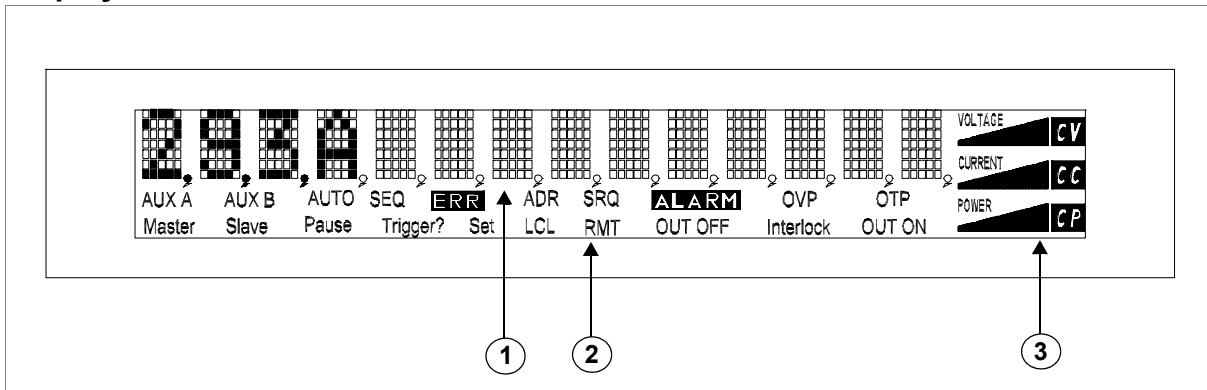

Figure 1.4 Front Panel Display

1. **Main Display:** Shows setpoints, readback, and menus. There are 14 characters. Each character is 5 pixels wide by 7 pixels high.
2. **Status Annunciators:** See “Status Annunciators” on page 28 and Figure 1.5 for detailed information.
3. **Voltage, Current, and Power Bar Graphs:** Show present voltage, current limit, and power output in graphical format. Also indicates regulation mode.

Status Annunciators

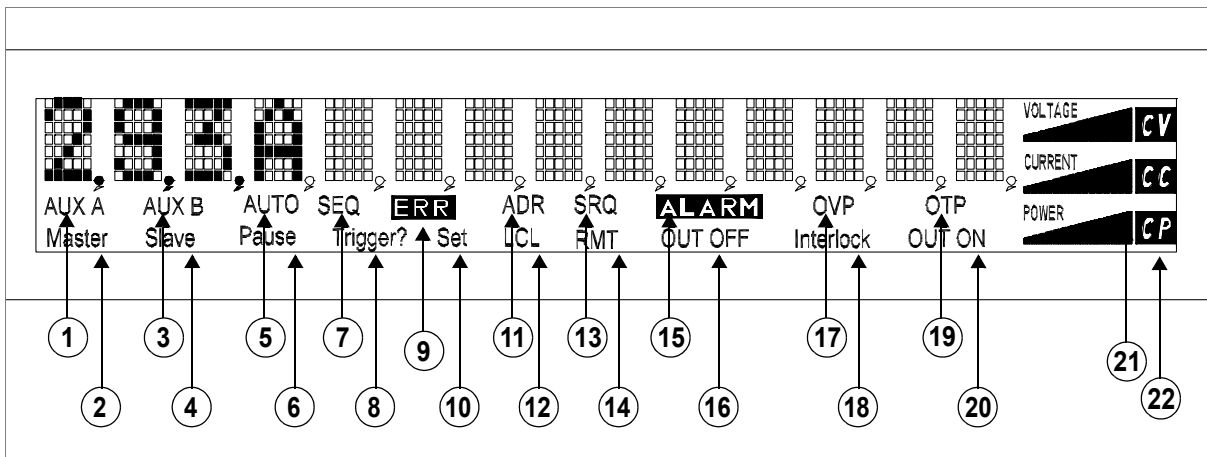

Figure 1.5 Front Panel Display, Status Annunciators

1. **AUX A:** Condition selected for auxiliary line A is TRUE.
2. **Master:** Power supply is selected to be the master in current share configurations.
3. **AUX B:** Condition selected for auxiliary line B is TRUE.
4. **Slave:** Power supply is selected to act as a slave in current share configurations.
5. **AUTO:** Power supply is in auto sequence operation.
6. **Pause:** Auto sequence program is paused. (Output is still on.) Press **RUN/PAUSE** key to continue.
7. **SEQ:** Power supply is in auto sequence setup mode (if **Set** is also turned on) or in auto sequence operation.
8. **Trigger?:** Auto sequence program is waiting for a trigger signal to continue execution.
9. **ERR:** An error has occurred.
10. **Set:** Setting or setpoint is to be entered.
11. **ADR:** Power supply is being addressed (receiving data). (All remote digital interfaces.)
12. **LCL:** Power supply is under local (front panel) control.
13. **SRQ:** Service request. GPIB only.
14. **RMT:** Power supply is under remote control.
15. **ALARM:** Power supply is operating outside the parameters the user set by using **PROT SET**, or the power supply's internal temperature has exceeded an internally set trip point (OTP).
16. **OUT OFF:** Power supply output is disabled; all other circuits are active; unit is in standby mode.
17. **OVP:** Power supply has exceeded an over-voltage trip point.
18. **Interlock:** Signals that the external shutdown line (the safety interlock line) has been activated, disabling the supply output.
19. **OTP:** Power supply has exceeded an over-temperature trip point, disabling the supply output.
20. **OUT ON:** Output is on.
21. **Bar graphs:** Graphical representation of output voltage, current, and power.
22. **CV, CC, CP:** Power supply is in constant voltage mode, constant current mode, or constant power mode.

About The XDC Power Supply

Rear Panel

Rear Panel

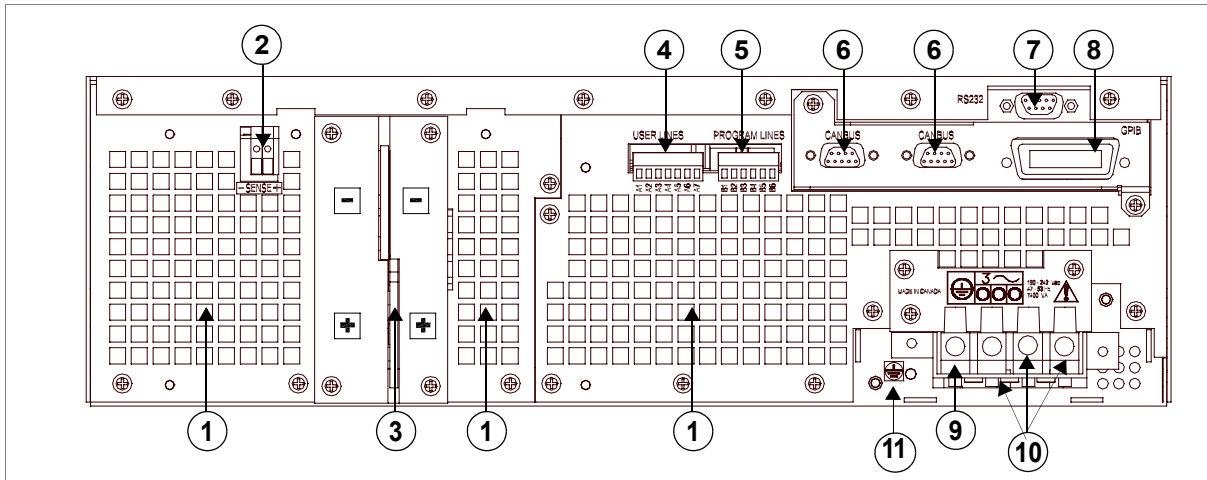

Figure 1.6 Rear Panel (6000 Watt low and medium output shown)

1. Fan Exhaust Vents: Do not obstruct.
2. Remote Sensing Ports: From the rear point of view, left is negative; right is positive.
3. DC Output: Bus bars are shown. Terminal blocks are used for higher voltages (300 and 600 Vdc only).
4. Auxiliary Status Lines, External Interlock, and Trigger Input
5. Analog Program and Readback
6. CANbus Port: For current sharing or multichannel operation (optional for 6000 Watt units)
7. RS-232 Connector
8. GPIB (optional)
9. Protective Conductor Ground Screw
10. AC Input
11. Chassis ground stud

Overview of Operation

Power ON Power ON describes the period between the time the AC power is turned ON and the time the power supply is ready for normal operation. Each supply comes with a series of factory default settings that may be in effect at the conclusion of the Power ON period. These include:

- **Output OFF:** No current is sent to the DC output connections. You must press **Out ON/OFF** to activate the supply output.
- **Voltage 0V:** The Voltage setpoint is zero.
- **Current 0A:** The Current setpoint is zero.
- Local mode operation

The output state depends on the Power ON output setting. You can customize the Power ON settings to suit your needs. See “Configure Power ON Settings” on page 84 for more information.

Control Modes One local method and 4 remote methods are available for controlling the power supply:

- **Local Mode:** Where the user operates the menu keypad and knobs
- **RS-232:** Where the user operates the supply remotely through a serial port connection (standard feature).
- **GPIB:** Where the user operates the supply remotely through the faster General Purpose Interface Bus. The GPIB bus follows the IEEE 488.2 standard and is an optional feature of this power supply.
- **Multichannel:** Where the user operates the supply remotely through the optional multichannel link between 2 or more (up to 50) power supplies (optional feature).
- **Analog:** Where the user operates the supply remotely through the isolated analog programming and readback port (standard feature). Three options are available:
 - Analog V and I
 - Analog V
 - Analog I

Each of these methods is referred to as a control mode.

About The XDC Power Supply

Overview of Operation

Section 2. Installation

Overview

Section 2 provides recommendations and procedures for inspecting, installing, and testing the power supply. For more information about controls and connectors, refer to the front panel diagrams (Figure 1.1 to Figure 1.5) as well as the rear panel diagram (Figure 1.6) in Section 1.

Basic Setup Procedure

Table 2.1 provides a summary of the setup procedure and an overview of the subsections in this chapter. Use this table as a quick reference if you are familiar with the installation requirements for the power supply. If you require more information, each step in the table refers to a subsequent section which contains more details. Complete each step in the sequence given.

Table 2.1 Basic Setup Procedure

Step #	Description	Action	Reference
1	Inspection	Visually inspect the power supply.	“Inspection, Cleaning, and Packaging” on page 34
2	Installation	Install the power supply, ensuring adequate ventilation.	“Location, Mounting, and Ventilation” on page 37
3	Input Power	Connect AC input power.	“AC Input Power” on page 40
4	Test	Perform functional tests for voltage mode operation, current mode operation, and front panel controls.	“Basic Checks or Self-Tests” on page 45
5	Select Wires	Select wires that can tolerate the DC current output.	“Load Wiring” on page 48
6	Connect Load	Connect the load wires to the DC output.	“Load Connections” on page 50
7	Connect Remote Sensing (if required)	Connect remote sensing connectors on power supply to load.	“Remote Sensing” on page 56

Installation

Inspection, Cleaning, and Packaging

Inspection, Cleaning, and Packaging

Initial Inspection

When you receive your power supply, do a quick visual check.

1. Ensure that the box contains the power supply, the operating manual, the AC input cover and strain relief, and the output cover.
2. Inspect the unit for scratches and cracks as well as broken switches, connectors, or displays.

If the unit is damaged, save all packaging materials and notify the carrier immediately.

Maintenance

Routine servicing of the power supply is not required except for periodic cleaning. Whenever a unit is removed from operation, clean the metal surfaces with naphtha or an equivalent mild solvent, and clean the front panel with a damp cloth using a weak solution of soap and water. Use low-pressure compressed air to blow dust from in and around vent openings and components on the printed circuit boards.

Returning Power Supplies to the Manufacturer

Return Material Authorization Policy

Before returning a product directly to Xantrex you must obtain a Return Material Authorization (RMA) number and the correct factory “Ship To” address. Products must also be shipped prepaid. Product shipments will be refused and returned at your expense if they are unauthorized, returned without an RMA number clearly marked on the outside of the shipping box, if they are shipped collect, or if they are shipped to the wrong location.

When you contact Xantrex to obtain service, please have your operating manual ready for reference and be prepared to supply:

- The serial number of your product
- Information about the installation and use of the unit
- Information about the failure and/or reason for the return
- A copy of your dated proof of purchase

When you ship:

1. Package the unit safely following the procedures on page 36, preferably using the original box and packing materials. Please ensure that your product is shipped fully insured in the original packaging or equivalent. This warranty will not apply where the product is damaged due to improper packaging.
2. Include the following:
 - The RMA number supplied by Xantrex Technology Inc clearly marked on the outside of the box.
 - A return address where the unit can be shipped. Post office boxes are not acceptable.
 - A contact telephone number where you can be reached during work hours
 - A brief description of the problem

Ship the unit prepaid to the address provided by your Xantrex customer service representative.

If you are returning a product from outside of the USA or Canada:

In addition to the above, you **MUST** include return freight funds and are fully responsible for all documents, duties, tariffs, and deposits.

If you are returning a product to a Xantrex Authorized Service Center (ASC):

A Xantrex return material authorization (RMA) number is not required. However, you must contact the ASC prior to returning the product or presenting the unit to verify any return procedures that may apply to that particular facility.

Installation

Returning Power Supplies to the Manufacturer

Packaging for Shipping or Storage

Follow these instructions to prepare the power supply for shipping or storage.

1. When returning the unit or sending it to the service center, attach a tag to the unit stating its model number (located on the front panel label) and serial number (located on the rear panel label). Give the date of purchase and an invoice number, if you have it, as well as a brief description of the problem.
2. For storage and shipping, repack the power supply in its original container. If the original container is not available, seal the unit in a plastic bag and then pack it into a wooden or sturdy cardboard box large enough to allow 2 in. (5cm) of cushioning material to surround the unit. For cushioning, use material such as foam slabs that are capable of supporting the unit.
3. Label the box as shown below in Figure 2.1.
4. If shipping, mark the service center address and your return address on the carton.
5. If storing, stack no more than 5 boxes high. Check the storage temperature range specification in Appendix E.

<p>POWER SUPPLY</p> <p>Model Number: _____</p> <p>Serial Number: _____</p> <p>FRAGILE – ELECTRONIC EQUIPMENT</p>
--

Figure 2.1 Typical Box Label for Storage

Location, Mounting, and Ventilation

Use the power supply in rack-mounted applications only. The power supply is designed to fit in a standard 19 in. (483mm) equipment rack.

Rack Mounting



WARNING- High Energy and High Voltage

Ensure that the 8-32 rack mounting screws do not extend more than 1/8 in. (3.0mm) into the sides of the power supply.

To install the power supply in an equipment rack:

1. Open the box containing the unit. See Figure 2.2.
2. With the help of at least one other person, lift the unit out of its package and slide it into an empty space in a mounting rack equipped with rails that are rated to support the unit's weight. See Figure 2.3.
On 12000 Watt units, remove the temporary lifting handles before installing the unit in a rack.



CAUTION

The power supply is too heavy for one person to safely lift and mount. To avoid injury, ask a co-worker for assistance.

3. While your assistant(s) holds the unit steady, fasten it to the rack by inserting bolts through the mounting brackets on either side of the front panel and securing them with a washer and nut.
4. The front panel mounting brackets are designed to prevent the unit from sliding out of the rack, not to support its full weight. Provide adequate support for the rear of the unit without obstructing the ventilation inlets. Use slide rails as illustrated in Figure 2.3 or slide brackets attached to the 8-32 mounting holes on each side of the unit. Follow the manufacturer's instructions to install rails or slides.

Installation

Location, Mounting, and Ventilation

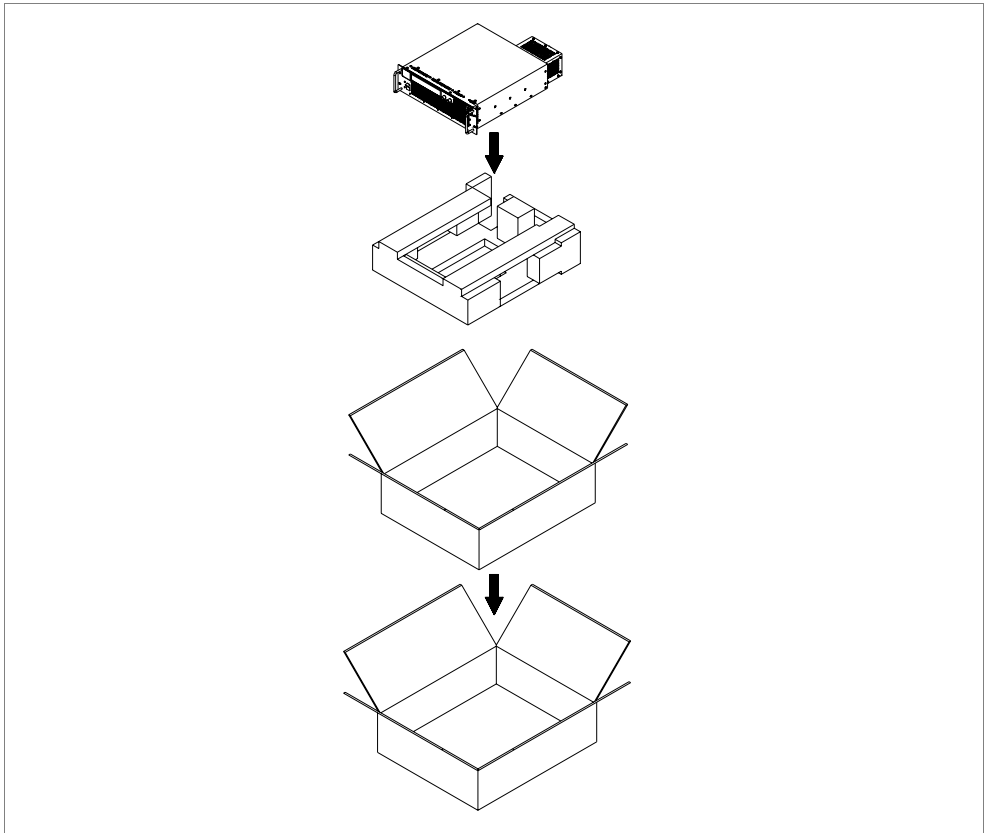

Figure 2.2 Unpacking the Power Supply (6000 Watt shown)

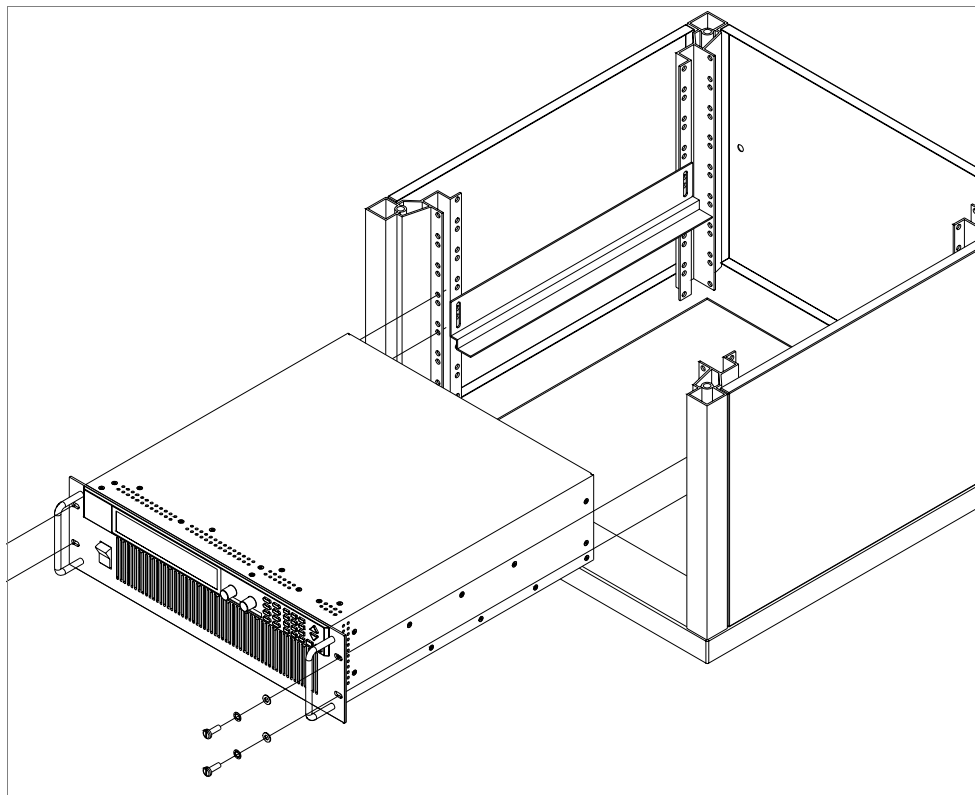

Figure 2.3 Mounting the Power Supply in the Rack With Support Rails¹
(6000 W shown)

Ventilation Allow cooling air to reach the ventilation inlets on the front of the unit and allow 4 in. (10 cm) of unrestricted air space at the rear of the unit for the fan exhaust. Ventilation inlets are located on the top and sides; they are not required, however, and may be blocked, if required.

See “Specifications and Characteristics” on page 227 for the operating ambient temperature range.

1. Available from rack or cabinet vendors (e.g. Schroff, part number 30150-094).

AC Input Power



WARNING

Disconnect AC power from the unit before removing the connector cover. Live line voltages may be exposed when the cover is removed.



WARNING

A safety ground wire must be connected to the unit as shown in Figure 2.4 and Figure 2.6 to ensure operator safety.



CAUTION

When the power switch is turned on, output voltage or current previously set may be applied to loads, depending on the supply configuration.

AC Input Connector

The AC input connector is a standard wire clamp terminal block with 3-phase connectors and a chassis ground connector. The safety ground wire, alternatively, may be connected to the chassis using a ring tongue on the ground stud as shown in Figure 2.4 and Figure 2.6.

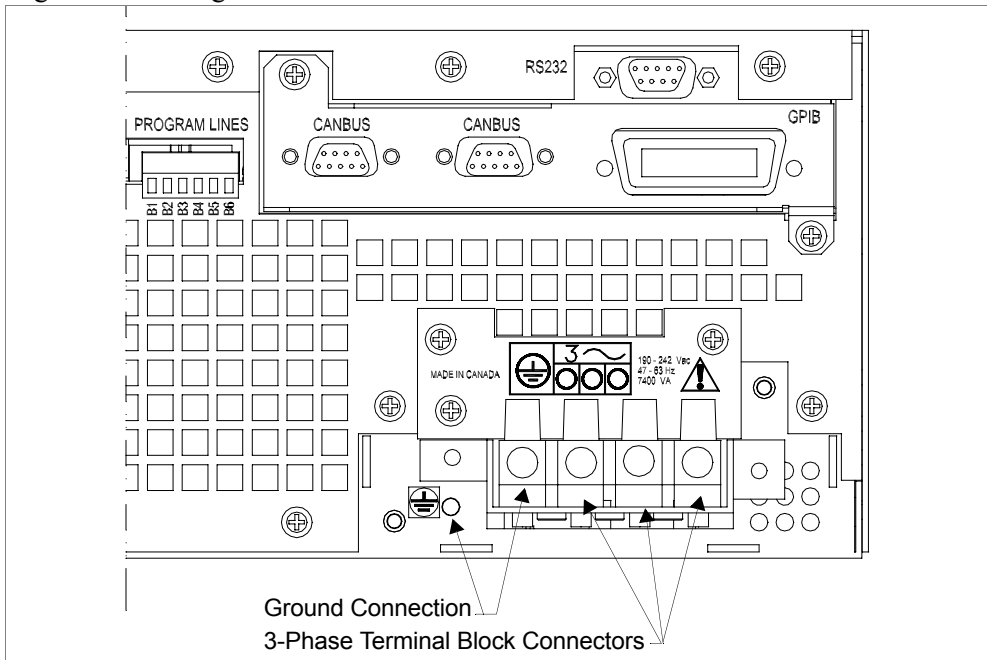

Figure 2.4 AC Input Connector for 6000 Watt units

AC Input Wire The manufacturer recommends the AC input wire specified in Table 2.2 and Table 2.3. This must be permanently connected to an approved AC distribution box with suitably rated over-current protection. If you require a special cord, contact the manufacturer.

Table 2.2 AC Wire Specification for 6000 Watt units

AC Input Voltage Range	Wire
190–242Vac, 47–63Hz, 3-phase, 4 wire (standard)	4 x 10 AWG (3 wire plus safety ground), stranded copper, 60°C minimum, 300V, 0.800 in. maximum cable diameter, rated for 25A.
342–500Vac, 47–63Hz, 3-phase, 4 wire (HV-Input)	4 x 14 AWG (3 wire plus safety ground), stranded copper, 60°C minimum, 600V, 0.800 in. maximum cable diameter, rated for 13A.

Table 2.3 AC Wire Specification for 12000 Watt units

AC Input Voltage Range	Wire
190–242Vac, 47–63Hz, 3-phase, 4 wire (standard)	4 x 6 AWG (3 wire plus safety ground), stranded copper, 60°C minimum, 300V, outside diameter (OD) of cable is ≤ 1 in., rated for 50 A.
342–500Vac, 47–63Hz, 3-phase, 4 wire (HV-Input)	4 x 10 AWG (3 wire plus safety ground), stranded copper, 60°C minimum, 600V, outside diameter (OD) of cable is ≤ 1 in., rated for 25 A.

AC Wire Input Connection for 6000 W See Figure 2.5, on page 42.

To connect the 6000 W AC input wires:

1. Ensure that the AC input cord is de-energized, and that the power switch on the front of the power supply is OFF.
2. Strip approximately 4 in. (10 cm) from the jacket of the AC wire. Strip 0.55 in. (14 mm) at the end of each wire.
3. Undo the 2 screws for the AC wiring strain relief/cover on the rear panel. Remove the cover.
4. Undo the strain relief screws. Insert the AC input cable through the strain relief until the outer cable jacket is flush with the inside of the strain relief. Tighten the strain relief cable clamp screws.
5. Insert the ground wire (green) 0.55 in. (14 mm) into the left-most terminal location, and tighten securely. (The safety ground wire may alternatively be connected to the chassis ground stud next to the terminal block, using a suitably sized ring terminal).

Installation

AC Input Power

6. Route the AC wires to the input terminal block by connecting the red, black, and white wires to the remaining 3 cable clamp connectors. There is no set order for connecting the wires. Any of the 3-phase wires can be connected to any of the 3 line input connectors. To connect each wire, loosen the terminal screw, insert the stripped wire 0.55 in. (14mm) into the terminal, and tighten the screw securely.
7. Reinstall the AC input strain relief/cover, routing wires inside the cover to prevent pinching.
8. Connect the free end of the cable to the AC source, checking that the voltage is within the approved input range for the supply.
9. Energize the AC input.

It is now safe to turn the power supply on.

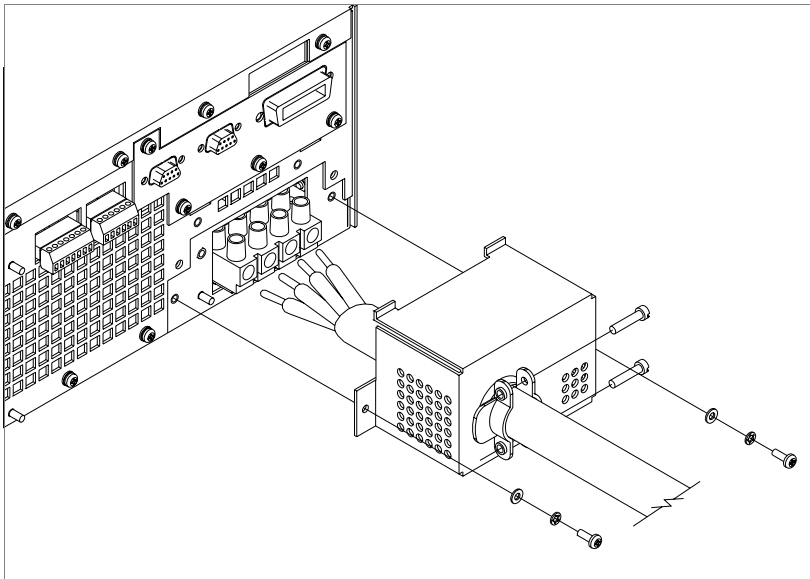

Figure 2.5 Attaching the AC Input Wires for 6000 Watt units

AC Wire Input Connection for 12000 W See Figure 2.6, on page 44.

To connect the 12000 W AC input wires:

1. Ensure that the AC input cord is de-energized, and that the power switch on the front of the power supply is OFF.
2. Strip approximately 2.75 in. (70 mm) from the jacket of the AC wire. Strip 0.55 in. (14 mm) at the end of each wire.
3. Remove the square AC input cover plate from the AC input bracket on the rear panel, and a round knock-out from either the rear or right side of the bracket.
4. Insert the AC input cable through the knock-out and through the removable nut from the strain relief until there is enough cord to attach the AC wires to the terminal block (the nut must be inside the AC input bracket). Tighten the cable clamp screws and the strain relief nut inside the AC input bracket until the AC input wire is firmly held between the nut and the cable clamp screws.
5. Insert the ground wire (green) 0.55 in. (14 mm) into the left-most terminal location, and tighten securely.
6. Route the AC wires to the input terminal block by connecting the red, black, and white wires to the remaining 3 cable clamp connectors. There is no set order for connecting the wires. Any of the 3-phase wires can be connected to any of the 3 line input connectors. To connect each wire, loosen the terminal screw, insert the stripped wire 0.55 in. (14mm) into the terminal, and tighten the screw securely.
7. Reinstall the AC input cover plate.
8. Connect the free end of the cable to the AC source, checking that the voltage is within the approved input range for the supply.
9. Energize the AC input.

It is now safe to turn the power supply on.

Installation

AC Input Power

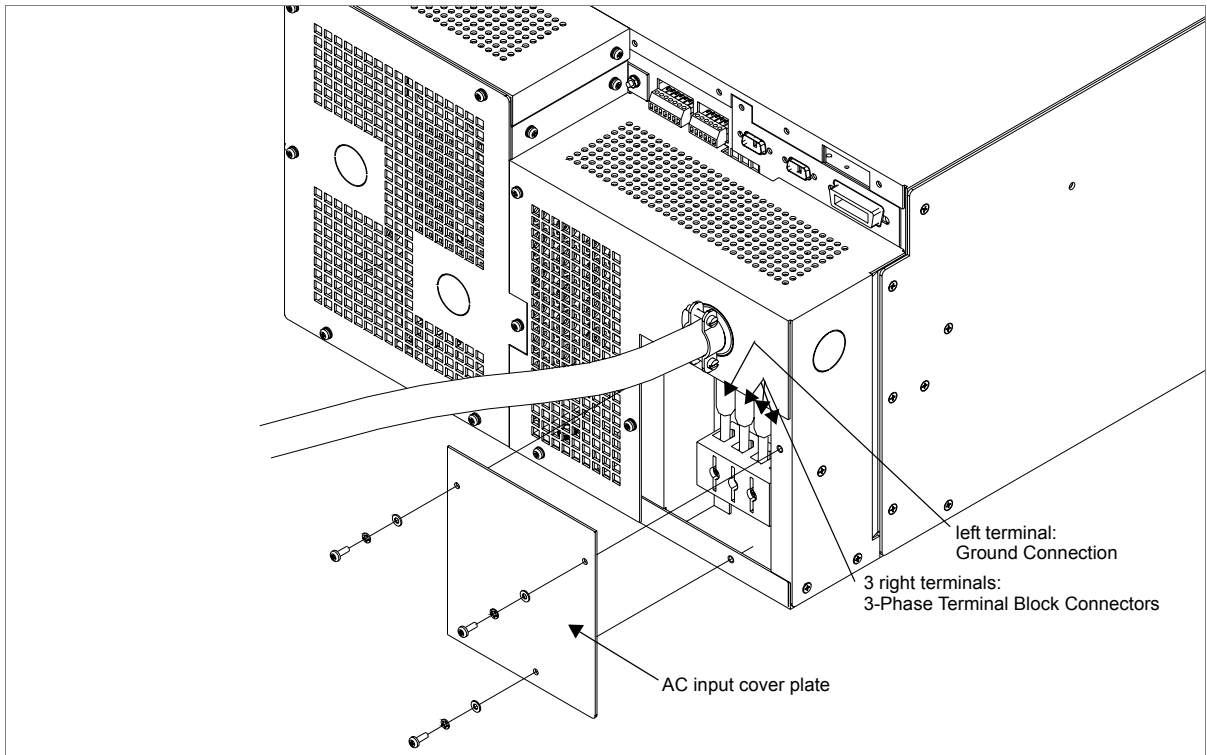

Figure 2.6 Attaching the AC Input Wires for 12000 Watt units

Basic Checks or Self-Tests



WARNING

The factory setting for Power ON is 0V and 0A with the output OFF. These settings can be customized by end users. If you suspect that the power supply has been used by someone else since it was received from the factory, be prepared for the unit to power ON with a live DC output.

The functional test procedures described in this section include power-on and front panel function checks as well as voltage and current mode operation checks.

Equipment Required

- Digital Voltmeter (DVM) rated better than 0.05% accuracy.
- DC shunt 1mV/A ($\pm 0.25\%$) with connecting wire. The recommended current ratings for the DC shunt and the wire must be at least 10% more than the output current of the power supply.

Display Test

To ensure that the display is working properly:

1. Turn the power switch ON.
2. Observe the display panel.
Every pixel should illuminate for 2 seconds as part of the power-on self-test.

If you need to rerun the test:

1. Turn the power switch OFF.
2. Wait until the pixels fade to black.
Some residual charge may remain in the capacitors after the power is OFF. Waiting for the display to fade ensures that the capacitors have sufficiently discharged their power to reset the power supply.
3. Turn the power switch ON.
4. Observe the display panel.

If you observe or suspect that one or more of the display pixels is malfunctioning, contact the manufacturer.

Installation

Basic Checks or Self-Tests

Power ON To complete the power on check:

Check

1. Ensure that the AC power switch is OFF.
2. Connect the unit to an AC outlet.
3. Turn the front panel AC power switch to ON.

After a short power-on delay, the front panel digital meters and the CV annunciator illuminate. Both voltmeter and ammeter displays should read zero.

Check the front panel annunciators. If OUT ON is illuminated, press **OUT ON/OFF** to disable the output. The OUT OFF annunciator should now be illuminated. For an illustration of the annunciators and their locations, see “Status Annunciators” on page 28.

If the ERR indicator is lit, see “Read Error Messages” on page 82 or page 135 on how to read an error message, and consult Appendix C to determine the meaning of the error. If an unexpected error persists after the power has been cycled, contact the manufacturer for assistance.

Voltage Mode Operation Check



WARNING

On units rated higher than 40V, ensure that the electrical connections are protected to prevent accidental contact.



CAUTION

When making connections to the bus bars, ensure that each terminal’s mounting hardware and wiring assembly are placed so they don’t touch the other terminal and short the power supply outlet. Heavy connecting cables must have some form of strain relief so the connections aren’t loosened and the bus bars aren’t bent.

To complete the voltage mode operation check:

1. Ensure that the OUT OFF annunciator is illuminated. If OUT ON is illuminated, press **OUT ON/OFF**.
2. Connect a Digital Voltmeter (DVM) to the output terminals on the rear panel, observing correct polarity.
3. Press **OUT ON/OFF** to turn the DC output ON.

4. Slowly turn the Current knob clockwise 1 or 2 turns. Slowly turn the Voltage knob clockwise and observe both the front panel voltmeter and the DVM. Do not exceed 10V.
5. Compare the DVM reading with the front panel voltmeter reading to verify the accuracy of the internal voltmeter. Both readings should be the same within the accuracy of the meters. The minimum control range is from zero to the maximum rated output for the power supply model. Check that the Constant Voltage (CV) annunciator is illuminated.
6. Press **OUT ON/OFF** to turn the DC output OFF.

Current Mode Operation Check



WARNING- High Temperature Hazard

Ensure that the current output does not exceed the rating of the shunt or load wiring during this test.

To complete the current mode operation check:

1. Ensure that the OUT OFF annunciator is illuminated. If OUT ON is illuminated, press **OUT ON/OFF**.
2. Connect the DC shunt across the output terminals on the rear panel.
3. Connect the DVM across the DC shunt.
4. Press **OUT ON/OFF** to turn the DC output ON.
5. Slowly turn the Voltage knob clockwise to a maximum reading of 10V.
6. Slowly turn the Current knob clockwise to a maximum reading of 10A.
7. Compare the DVM reading with the front panel ammeter reading using $I=V/R$ where I is the current, V is the DVM reading, and R is the DC shunt resistance. The minimum control range is from zero to the maximum rated output for the power supply model. Check that the Constant Current (CC) annunciator is illuminated.
8. Press **OUT ON/OFF** to turn the DC output OFF.
9. Disconnect the DVM and the shunt.

Installation

Load Wiring

Load Wiring

When connecting load wiring to the power supply, consider the following factors:

- Current carrying capacity of the wire
- Maximum load wiring length for operation with sense lines
- Noise and impedance effects of the load lines

Current Carrying Capacity

As a minimum, load wiring must have a constant capacity greater than the output current rating of the power supply. This ensures that the wiring will not be damaged even if the load is shorted. Table 2.4. shows the maximum current rating, based on 450A per square centimeter, for various gauges of wire rated for 105°C operation. Operating at the maximum current rating results in a temperature rise of approximately 30°C for a wire operating in free air. Where load wiring must operate in areas with elevated ambient temperatures or bundled with other wiring, use larger gauges or higher temperature-rated wiring. For high current applications, custom-designed bus bars are typically used. To increase the current carrying capability, use parallel cables.

Table 2.4 Current Carrying Capacity for Load Wiring¹

Wire Size (AWG)	Maximum Current (A)	Wire Size (AWG)	Maximum Current (A)
20	2.5	4	97
18	4	2	155
16	6	1	192
14	10	1/0	247
12	16	2/0	303
10	21	3/0	350
8	36	4/0	405
6	61	250MCM	455

1. Single insulated conductors in free air, 30°C

Load Wiring Length for Operation with Sense Lines For applications using remote sensing, or for improved voltage regulation at the load, you must limit the voltage drop across each load line. We recommend that you use the larger load wiring to ensure a smaller voltage drop (1V maximum), although units will compensate for up to 5V drop in each line with the remote sense lines connected.

Noise and Impedance Effects To minimize noise pickup or radiation, use the shortest possible length of shielded-twisted pair wiring for load lines. Connect the shield to the chassis via a rear panel mounting screw. Where shielding is not possible or is impractical, twisting the wires together offers some noise immunity. When using local sense connections, use the largest practical wire size to minimize the effects of load line impedance on the regulation of the supply.

Installation

Load Connections

Load Connections



WARNING

Exercise caution when operating the power supply. High energy levels can be stored at the output terminals on a power supply in normal operation. In addition, potentially lethal voltages exist in the power circuit and on the output and sense connectors of a power supply with a rated output greater than 40V. Filter capacitors store potentially dangerous energy for some time after power is removed.



CAUTION

When making connections to the bus bars, ensure that each terminal's mounting hardware and wiring assembly are placed to avoid touching the other terminal and shorting the power supply outlet. Heavy connecting cables must have some form of strain relief so they don't loosen the connections or bend the bus bars.

Make load connections at the rear of the power supply at the positive and negative output bus bars or to the 4-terminal wire clamp connector, depending on the model. (See Figure 2.7.)

Wire Size The wire should be one size larger than necessary to accommodate the required output current. Normally, the next largest commonly used gauge is used. For example, use 10AWG for 20A, and 8AWG for 30A.

Isolation The wire must have a suitable insulating coating that will prevent arcing between the positive and negative output current, and must be rated for 105°C operation.

Single Load To connect a single load to the DC output bus bars (10–150V outputs):

1. Ensure that the power supply is powered OFF.
2. Place a bolt in the connecting hole of the negative bus bar, and fasten the negative wire or bus bar, a washer, and a nut to the bolt.
3. Using a wrench, turn the bolt until it is secure at approximately 25 foot-pounds (34Nm).
4. Fasten the positive wire or bus bar to the positive bus, using a bolt, washer, and nut.
5. Tighten the bolt to approximately 25 foot-pounds (34Nm).
6. Ensure that the positive and negative wires are arranged so bare wires do not come into contact with each other or the chassis.

To connect the DC output wire clamp connectors (300V, 600V outputs):

- Connect appropriately sized wires as described in steps 1 to 6 above, except strip 0.5 in. (14mm) of insulation off each load wire, and clamp in the output connector by securely tightening the vertical clamp screw for each output.

Installation

Load Connections

Multiple Loads To connect multiple loads in parallel:

- Follow the “Single Load” procedure with the following exception:
- To minimize interaction between loads, bring the wiring for each load directly back to the supply output. When each load to the power supply is wired separately, the loads will see only the precisely regulated output from the supply. If 2 loads share a single cable, the fluctuation in current to one load will cause the voltage to vary on the others. This is due to wire impedance drops.

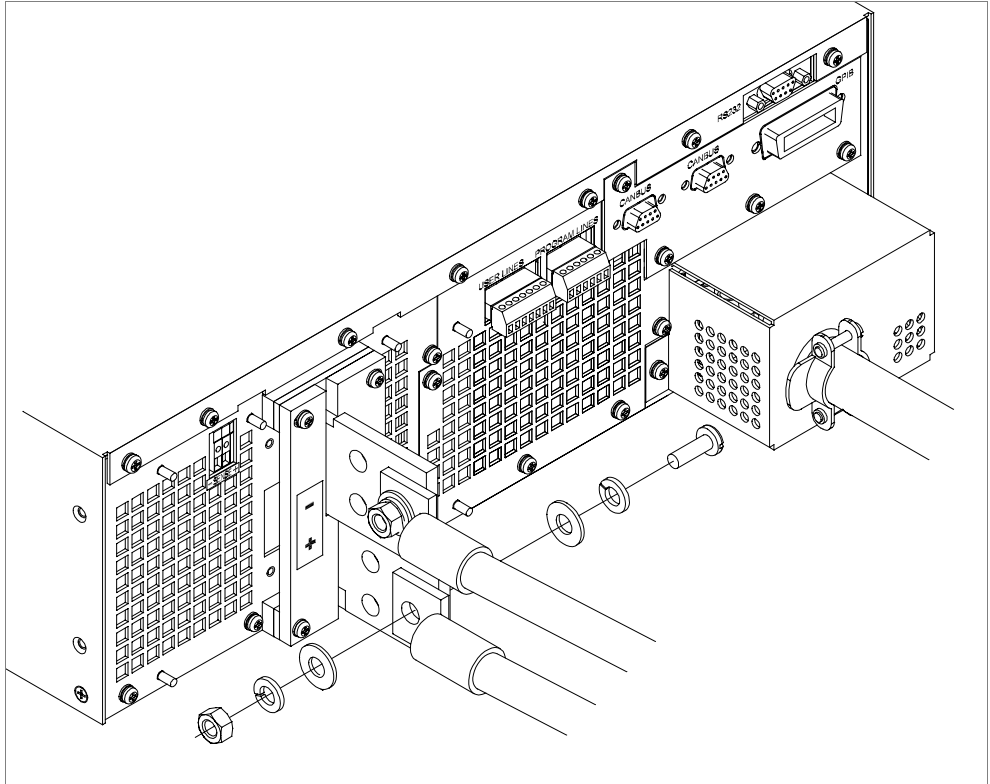

Figure 2.7 Fastening the Output Wires (6000 Watt)
(Low and Medium Voltage)

Output Strain Relief/Cover

See Figure 2.8 and Figure 2.9 for installation of the output cover. Use this cover to protect users from accidental contact with the bus bars and to clamp output cables in place.

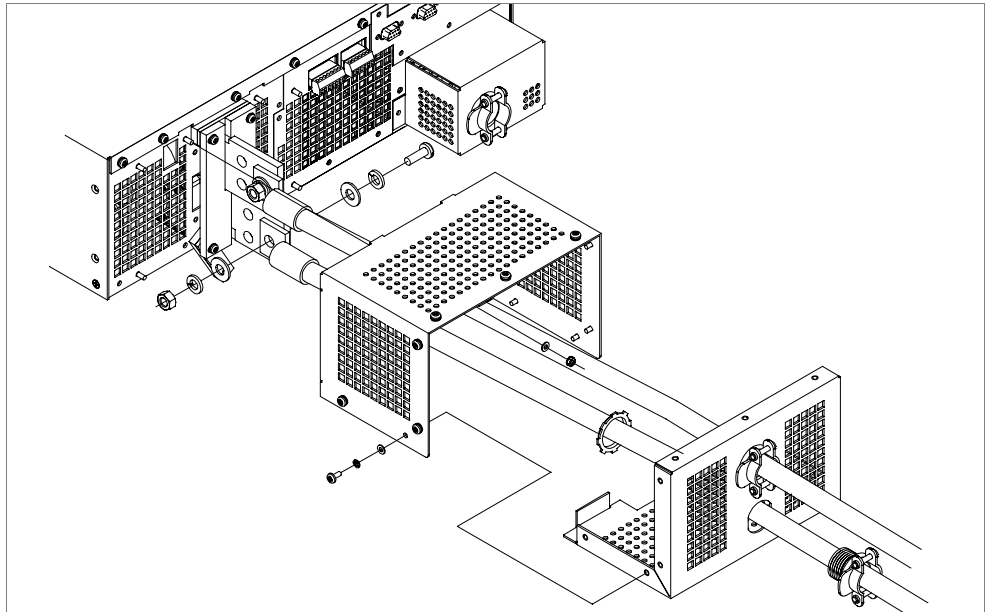

Figure 2.8 Output Bus Bar Cover for 6000 Watt units (Low and Medium Voltage)

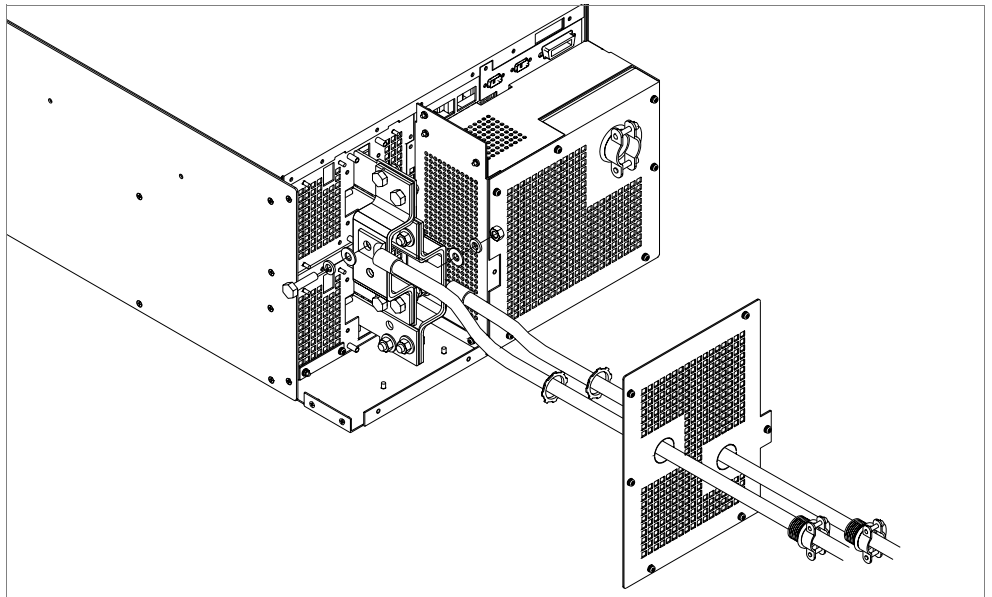

Figure 2.9 Output for 12000 Watt units (Low and Medium Voltage)

Installation

Load Connections

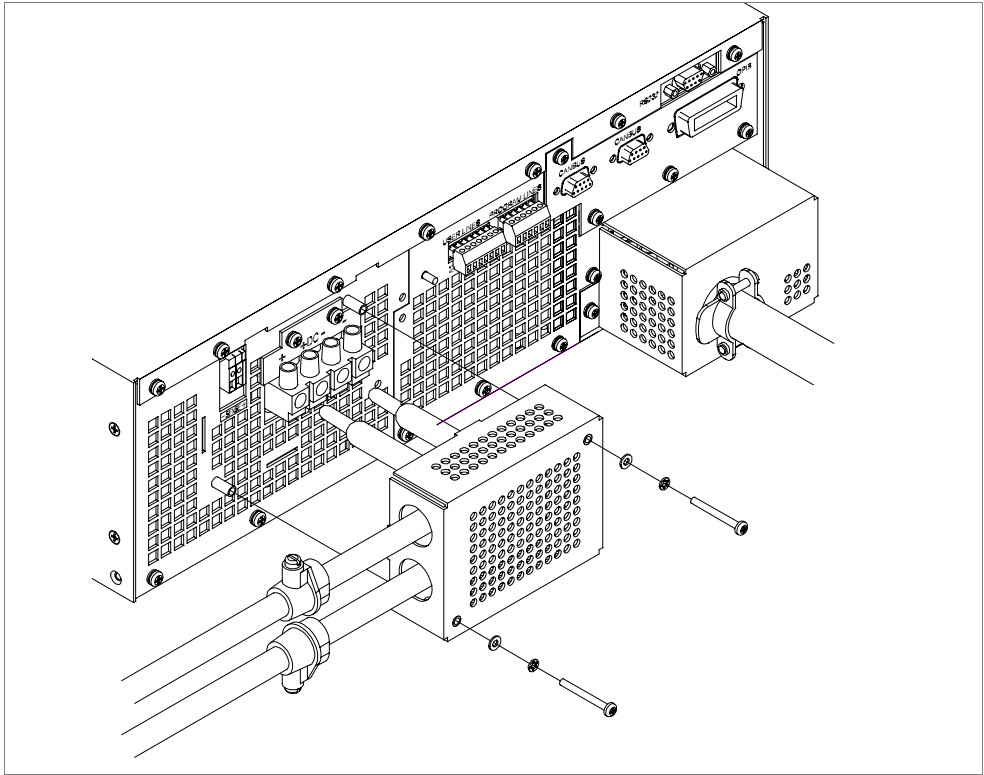

Figure 2.10 Output Cover with Strain Relief for 6000 Watt units
(High Voltage 300–600V)

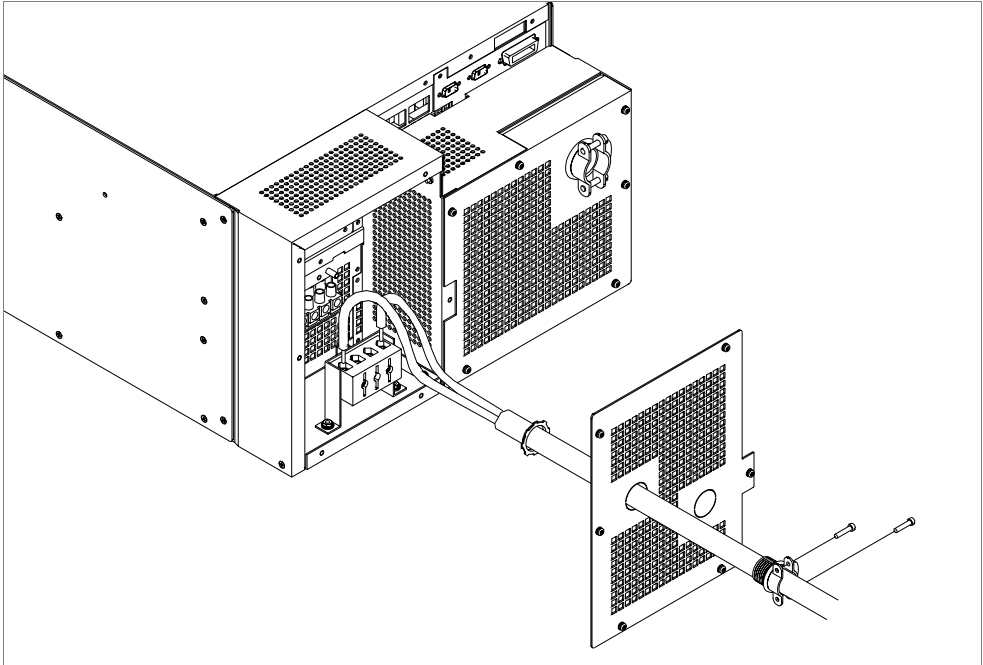

Figure 2.11 Output for 12000 Watt units (High Voltage 300–600V)

Installation

Remote Sensing

Remote Sensing

The power supply regulates the output voltage at the output connectors in its normal configuration without remote sense lines connected.

Remote sensing lets the power supply track and regulate the output voltage at the load, and thereby compensate for the voltage drop in the load lines. The power supply will only compensate within the limitations of its voltage rating, to a maximum of 5V per load line. Remote sensing is normally only required for critical loads which cannot tolerate the slight voltage drop in the load lines caused by their resistance. Remote sensing has no effect when the power supply is operating in Constant Current mode.

Two remote sensing connectors are located on the rear panel of the power supply. See “Rear Panel” on page 30 for location and polarity. Connect 2 wires from these ports to the load, where the power supply cables terminate for your connection. Carefully observe the correct polarity when making the connection. On 12000 Watt units, connect the sense wires to the connector on the top or master power module.

The remote sensing input is sensitive to electrical noise, so always use a shielded twisted pair, 22AWG or greater for the sense line cable. Terminate the shield to the supply chassis or the negative output of the power supply for best results.

Section 3. Operation

Overview

Once you have installed the power supply and connected both the AC input power and the load as explained in Section 2, the power supply is in its default configuration and is ready to operate in local control mode.

Section 3 begins by explaining how to power on and power off the power supply. It then provides information about configuring the power supply, and also gives procedures for operating the supply via the front panel controls and menu functions.

In addition, brief descriptions are provided of Constant Voltage, Constant Current, and Constant Power modes. See “Power Supply Operation” on page 64.

Powering ON the Power Supply



WARNING- Shock Hazard

The factory setting for Power ON is 0V and 0A with the output OFF. These settings can be customized by end users. If you suspect that the power supply has been used by someone else since it was received from the factory, be prepared for the unit to power ON with a live DC output.

To power on the power supply:

1. Ensure that the AC power switch is OFF.
2. Connect the unit to an AC outlet.
3. Turn on the front panel AC power switch.

After a short power-on delay, the digital meters on the front panel and the CV annunciator illuminate. The voltmeter and ammeter displays should read zero.

Check the front panel annunciators. If OUT ON is illuminated, press **OUT ON/OFF** to disable it. The OUT OFF annunciator should now be illuminated. For an illustration of the annunciators and their locations, see Figure 1.5.

Operation

Power Supply Operating States

Powering OFF the Power Supply

From the front panel, the safest method for shutting down the power supply is:

Step #	Do This	You Will See
1		The OUT OFF annunciator illuminates; Output V and I are 0.
2	Switch the AC power to OFF.	The AC OFF alarm, and then the unit fades to black.

Power Supply Operating States

The power supply has 5 operating states:

- Power-On
- Output Shutdown
- Soft Start
- Normal Operation
- Calibration

Power-On This is the period between the time that AC power is applied to the supply (AC breaker turned on) and the time that the power supply is ready for operation. During this period, the internal circuits are powering up and performing self-tests. At the end of the Power-On period, the supply is normally in its default Power-On mode with the output OFF, $V_{SET}=0$ and $I_{SET}=0$.

Output Shutdown In this state, the output is disabled and there is no output regardless of power settings. The power supply can be placed in the Output Shutdown state by a command (via the front panel or from the programming interface), via the Interlock signal, or from a protection mechanism. This is also called the Standby mode.

Soft Start In this state, the output power is ramping up gradually towards its target load. This reduces equipment stress. This state occurs whenever the supply output is set to ON or a protection state is re-set, and is approximately 2 seconds in duration.

Normal Operation This is the normal operating state for the power supply. The power supply is ready to accept commands.

Calibration This is a service mode that is used to calibrate setpoints and readback levels for accuracy. Calibration should only be performed by qualified service personnel. For detailed information, see Appendix A.

Power Supply Regulation Modes

The power supply has 3 regulation modes while in the Normal Operation State:

- Constant Voltage (CV)
- Constant Current (CC)
- Constant Power (CP)

The CV, CC, and CP annunciators indicate the regulation mode.

Constant Voltage (CV) In this mode, the supply's output voltage is constant while the current and power vary with the load. The power supply will operate in constant voltage mode whenever the load current I_L is less than the current limit setting I_{SET} , or: $I_L < I_{SET}$. ($I_L = V_{SET}/R_L$). In constant voltage mode, the power supply maintains the output voltage at the selected value (V_{SET}) while the load current I_L varies with the load requirements.

Constant Current (CC) In this mode, the supply's output current is constant while the voltage and power vary with the load. The power supply will operate in constant current mode whenever the load resistance is low enough that the load current I_L is equal to the current limit setting I_{SET} . ($V_L = I_{SET}R_L$). In constant current mode, the power supply maintains the output current at the selected value (I_{SET}) while the load voltage V_L varies with the load requirements.

Constant Power (CP) In this mode, the supply's output power is constant while the voltage and current vary with the load resistance. The power supply will operate in Constant Power mode when the power drawn by the load is equal to the power setpoint and the product of the voltage and current setpoint (V_{SET} and I_{SET}) is greater than the power limit point (P_{SET}). In Constant Power mode, the power supply maintains the output power at the selected value (P_{SET}) while the load voltage V_L and load current I_L varies with the load requirements. The power limit is normally set to the maximum supply rating, so the Constant Voltage or Constant Current modes will always be in effect without entering into the Constant Power mode of operation.

Automatic Mode Crossover This feature allows the power supply to automatically switch operating modes in response to changing load requirements. If, for example, the power supply was operating in Constant Voltage (CV) Mode ($I_L < I_{SET}$), and the load changed so the load current (I_L) became EQUAL TO the current limit setting (I_{SET}), the power supply would automatically switch into Constant Current (CC) Mode and the output voltage would vary in response to changes in load current. If the additional load was subsequently removed so the load current was again LESS THAN the current limit setting, the supply would automatically return to Constant Voltage (CV) Mode.

Operation

Remote Control Modes

Remote Control Modes

A number of control interfaces are available. You can control the power supply remotely using 0–5V or 0–10V signals via the remote analog programming interface or from a remote terminal using a remote digital interface. A remote digital interface following RS-232 protocol is standard. An optional remote digital interface following IEEE 488.2 (GPIB) protocol is also available. An optional CANbus port for 6000 Watt units is also available which enables multi-channel communication from a single GPIB address, and supports current sharing with parallel connected units. (For detailed information, see Section 4, “Remote Operation”.)

Front Panel Controls

The power supply is shipped ready to operate in local mode. The factory default power-on setting is 0V, 0A with the DC output turned off.

This section describes the function keys, menu options, and control knobs that you use to operate the power supply. (Additional details about the front panel keys, control knobs, and display annunciators are provided in Section 1, “About The XDC Power Supply”.)

The next section (“Power Supply Operation” on page 64) provides details about configuring and operating the power supply.

Function Keys Eight function keys are located on the front panel. Each is described below. For the purposes of simple front panel control, you should understand the function of the **LCL/RMT**, **OUT ON/OFF**, **VOLTAGE**, and **CURRENT** keys.

1. **VOLTAGE:** Lets you pre-set a setpoint before enabling it. To pre-set a voltage setpoint, press **VOLTAGE**, use the Voltage knob or the numeric keypad to enter a value, and then press **ENTER** to enable it. (See “Set Voltage” on page 64.)

This output can be changed while the output is OFF.

2. **CURRENT:** Lets you pre-set a setpoint before enabling it. To pre-set a current setpoint, press **CURRENT**, use the Current knob or the numeric keypad to enter a value, and then press **ENTER** to enable it. (See “Set Current” on page 64.)

This output can be changed while the output is OFF.

3. **STORE:** Lets you save power supply settings. (See “Store User Settings” on page 77.)
4. **OUT ON/OFF:** This is a toggle key that enables and disables the power supply output. Normally, you should leave the power supply in its Output Off state when no load is attached or there is no need for DC output. (See “Turn Output On or Off” on page 65.)

When the Out On annunciator is illuminated, the output is on. When the Out Off annunciator is illuminated, the output is off.

5. **LCL/RMT:** This key lets you toggle between local and remote control. If the RMT annunciator is illuminated, press **LCL/RMT** to return control to the front panel, if local mode has been enabled by the controller. (See “Toggle Local/Remote” on page 74.)

Operation

Front Panel Controls

6. **PROT SET:** Lets you view and set protection setpoints. (See “Set Output Protection” on page 65.)
7. **RECALL:** Lets you apply stored power supply settings. (See “Recall Settings” on page 79.)
8. **EXIT:** Lets you cancel an operation or leave Calibration mode or Auto Sequence mode.

Menu Navigation

Four keys allow you to access many functions available on the menu. These keys are **MENU**, **ENTER**, and the **Up** and **Down** arrow keys.

Top Level Menu Items

To display the first menu item, press **MENU**. To display the other top level menu items in the order listed below, press **MENU** or the **Down arrow** repeatedly. To display the other items in reverse order, press the **Up arrow** repeatedly.

The top level menu items are:

1. **ERROR MSGS:** Lists up to 50 queued errors. (See “Read Error Messages” on page 82.)
2. **USER LINES:** Configures auxiliary lines A and B. (See “Configure User Lines” on page 83.)
3. **PON CONFIG:** Configures the power-on settings. (See “Configure Power ON Settings” on page 84.)
4. **S/D RECOVERY:** Sets up shutdown recovery options for AC Off and Over-Temperature Protection. (See “Set Shutdown Recovery for AC Off and OTP” on page 71.)
5. **REMOTE SELECT:** Sets up the remote access option. (See “Select Remote Control Source” on page 75.)
6. **REMOTE CONFIG:** Configures the remote access option. (See “Configure Remote Control Source” on page 76.)
7. **AUTO SEQ PGM:** Programs automatic sequences. (See “Program Auto Sequence” on page 87.)
8. **CURRENT SHARE:** Sets up master/slave relationships for multiple-supply configurations. (See Section 5, “Current Sharing (6000 Watt only)”.)
9. **POWER SETPT:** Sets up the power output. (See “Set Power” on page 65.)
10. **DISPLAY CFG:** Sets up the display to show the desired combination of voltage, current, and power. (See “Configure Display” on page 98.)

11. **KNOB LOCKOUT:** Locks out either the Voltage or Current knob, or locks out both. (See “Lock Out Control Knobs” on page 98.)
12. **SETPT LIMIT:** Sets up minimum and maximum voltage, current, and power setpoints. (See “Set V, I, and P Limits” on page 100.)
13. **SLEW RATE:** Sets the programmable slew rate. (See “Slew Rate” on page 102.)
14. **CALIBRATION:** Displays the Calibration menu. This menu item can be password protected. (See Appendix , “.?”.)
15. **MODEL INFO:** Displays make, electrical ratings, ROM version, FPGA version, and SCPI version. (See “View Model Information” on page 104.)

Control Knobs

The Voltage and Current knobs are the simplest way to control the power supply.

The Voltage and Current knobs are digital encoders, and therefore, there are no start or end points to their rotation, and their rotation positions are meaningless when the power supply is powered OFF. The control knobs can be disabled through a menu command. See “Lock Out Control Knobs” on page 98 for more information.



Operation

Power Supply Operation



Power Supply Operation

This section describes how to configure and operate the power supply.





Set Voltage The **VOLTAGE** key allows you to set and view the DC voltage output setpoint.

Step #	Do This	You Will See
1		Set #####V
2	Use the numeric keypad, Voltage knob, or arrow keys to enter a value (0–103% of rated voltage).	
3		This saves the setting and enables the new voltage setpoint.

Set Current The **CURRENT** key allows you to set and view the DC current output setpoint.

Step #	Do This	You Will See
1		Set #####A
2	Use the numeric keypad, Current knob, or arrow keys to enter a value (0–103% of rated current).	
3		This saves the setting and enables the new current setpoint.

Set Power The POWER SETPOINT menu option lets you select the power output limit, measured in watts. The following table shows how to access and work with the Power Setpoint option. The power setpoint is normally at the maximum rating of the power supply, in the factory default configuration and does not need to be re-set for typical use.

Step #	Do This	You Will See
1		ERROR MSGS
2	 Press 8 times.	POWER SETPOINT
3		SET ##### W
4	Use the numeric keypad or arrow keys to enter the value, which must be 3–103% of the unit's rated power.	
5		This saves the value and enables the new power setpoint.

Turn Output On or Off Use the **OUT ON/OFF** toggle key to enable or disable the power supply's output. When the output is disabled, the voltage and current at the output are zero regardless of the setpoints.

When the output is on and you press **OUT ON/OFF**, **OUTPUT OFF** is momentarily displayed. Then the readback is 0000V 0000A to indicate that output is zero, and the **OUT OFF** annunciator illuminates. This is also known as Standby mode.

When you press **OUT ON/OFF** again, the **OUT ON** annunciator illuminates and the power supply resumes normal operation, with the display showing a readback of the output.

Set Output Protection Seven configurable protection mechanisms are available:

- **OVP:** Over-Voltage Protection. Factory default = 103% V_{RATED}
- **UVP:** Under-Voltage Protection. Factory default = 0V (disabled)
- **OCP:** Over-Current Protection. Factory default = 0A (disabled)
- **UCP:** Under-Current Protection. Factory default = 0A (disabled)
- **OPP:** Over-Power Protection. Factory default = 0W (disabled)
- **UPP:** Under-Power Protection. Factory default = 0W (disabled)
- **Fold:** Fold Protection. (See below.)

Operation

Power Supply Operation

OVP shuts down the power supply if the protection limit is exceeded. The other options offer a choice: they shut down the power supply or issue a warning. When the protection level is set to zero, that mechanism is considered disabled. However, in the case of OVP, a hardware protection mechanism still exists.

The last protection mechanism is **Fold Mode** protection, when the unit will shut down if it enters the selected regulation mode for a specified period of time.



Other protection mechanisms designed to protect the power supply are:

- **AC Off:** AC Off protection will disable the output if the AC line drops below the acceptable range.
- **High Temperature Alarm:** A High Temperature condition will queue an alarm message when the temperature of critical internal components nears the maximum operating temperature.
- **Over Temperature Protection (OTP):** An over temperature condition will disable the output.
- **Sense Protection:** Sense Protection will disable the output when the internal sense circuit is tripped by either reversed polarity at the output of the supply or a high voltage present at the output.

Recovery options are available for AC Off and OTP.

Also, see “Status Registers” on page 142.

To set the Over-Voltage Protection:

Step #	Do This	You Will See
1		OVP SHUTDOWN
2		OVP SET 0V
3	Use the Voltage knob, the numeric keypad, or the arrow keys to enter a value. The value must be between 0–103% of the unit's rated voltage.	OVP SET ####V
4		This setting is saved and the display returns to its default operating mode.

The other protection options follow a similar procedure, but have 2 extra steps:





1. When you press **PROT SET / ALARMS**, the OVP prompt appears. Press **PROT SET / ALARMS** repeatedly to cycle through the other protection options.
2. Protection options, other than OVP, prompt you with `S/D if trip? N`. Use the arrow keys to select **Yes** or **No**.
Yes shuts down the power supply if the protection limit is reached.
No issues a warning (a message in the Alarms menu) without shutting down the supply.

Operation





Power Supply Operation

These 2 extra steps are shown in the following example.

To set the Under-Voltage Protection:

Step #	Do This	You Will See
1		OVP SET 0V
2	 Press repeatedly until the desired setting appears.	UVP SET 0V
3		UVP SET 0V
4	Use the Voltage knob, the numeric keypad, or the arrow keys to enter a value (0–103% of the unit's rated voltage).	UVP SET ####V
5		S/D if trip? N
6	Use the arrow keys to select Yes or No. For this example, Yes is selected.	S/D if trip? Y
7		This setting is saved and the display returns to its default operating mode.

To set the Over-Current Protection:

Step #	Do This	You Will See
1		OVP SET 0V
2	 Press repeatedly until the desired setting appears.	OCP SET 0A
3		OCP SET 0A
4	Use the Current knob, the numeric keypad, or the arrow keys to enter a value (0–103% of the unit's rated current).	OCP SET ####A
5		S/D if trip? N
6	Use the arrow keys to select Yes or No. For this example, Yes is selected.	S/D if trip? Y
7		This setting is saved and the display returns to its default operating mode.

To set the Under-Current Protection:

Step #	Do This	You Will See
1	<input type="button" value="PROT SET ALARMS"/>	OVP SET 0V
2	<input type="button" value="PROT SET ALARMS"/> Press repeatedly until the desired setting appears.	UCP SET 0A
3	<input type="button" value="ENTER"/>	UCP SET 0A
4	Use the Current knob, the numeric keypad, or the arrow keys to enter a value. The value must be between 0–103% of the unit's rated current.	UCP SET ####A
5	<input type="button" value="ENTER"/>	S/D if trip? N
6	Use the arrow keys to select Yes or No. For this example, Yes is selected.	S/D if trip? Y
7	<input type="button" value="ENTER"/>	This setting is saved and the display returns to its default operating mode.





To set the Over-Power Protection:

Step #	Do This	You Will See
1	<input type="button" value="PROT SET ALARMS"/>	OVP SET 0V
2	<input type="button" value="PROT SET ALARMS"/> Press repeatedly until the desired setting appears.	OPP SET 0W
3	<input type="button" value="ENTER"/>	OPP SET 0W
4	Use both the Current and Voltage knobs, or the numeric keypad, or the arrow keys to enter a value. The value must be between 0W and 103% of the unit's rated power.	OPP SET ####W
5	<input type="button" value="ENTER"/>	S/D if trip? N
6	Use the arrow keys to select Yes or No. For this example, Yes is selected.	S/D if trip? Y
7	<input type="button" value="ENTER"/>	This setting is saved and the display returns to its default operating mode.

Operation

Power Supply Operation

To set the Under-Power Protection:





Step #	Do This	You Will See
1		OVP SET 0V
2	 Press repeatedly until the desired setting appears.	UPP SET 0W
3		UPP SET 0W
4	Use both the Current and Voltage knobs, or the numeric keypad, or the arrow keys to enter a value (must be between 0W and 103% of the unit's rated power).	UPP SET ####W
5		S/D if trip? N
6	Use the arrow keys to select Yes or No. For this example, Yes is selected.	S/D if trip? Y
7		This setting is saved and the display returns to its default operating mode.

Fold Protection options are:

- **None:** Fold protection disabled
- **CC:** Shutdown on entering CC mode
- **CV:** Shutdown on entering CV mode
- **CP:** Shutdown on entering CP mode

A programmable delay time causes the supply to wait before shutting down the output.

To set Fold Protection:

Step #	Do This	You Will See
1		OVP SET 0V
2	 Press repeatedly.	Fold SD Mode
3		
4	Use the arrow keys or the numeric keypad to select the value: None, CC, CV, CP	Fold on ####
5		
6	Use the arrow keys or the numeric keypad to select the delay time.	Delay 0s
7		This setting is saved.

Set Shutdown Recovery for AC Off and OTP

The Shutdown Recovery menu offers 2 options for AC Off (ACO) and Over-Temperature protection (OTP):







- **Auto-Recovery:** With this method, the power supply returns to its normal operating state once the alarm condition no longer exists. For example, if there was an over-temperature alarm and the protection was set to auto-recovery, the power supply would return to its normal operating state once the temperature was reduced below the alarm level.
- **Latched:** With this method, the power supply remains in Shutdown state until the operator manually clears the protection level and manually turns the output back on.

You can set either or both the OTP and AC Off to Auto-Recovery or Latched.

Operation

Power Supply Operation

To set both OTP and AC Off to Auto-Recovery:

Step #	Do This	You Will See
1		ERROR MSGS
2	 3 times ¹	S/D RECOVERY
3		OTP Latched ²
4		OTP AutoRecov
5		ACO AutoRecov ³ OTP is set to Auto Recovery.
6		ACO remains set to Auto Recovery and the display returns to its default operating mode.



1. You can also press **MENU** 4 times to bring up the Shutdown Recovery option.
2. The default is *Latched*. You can leave it at *Latched* or change it to *Auto-Recovery*. Press either arrow key repeatedly until the desired option appears.
3. The default is *AutoRecov*. You can leave it at *Auto-Recovery* or change it to *Latched*. Press either arrow key repeatedly until the desired option appears.

Respond to Alarms

If there is a protection alarm, press the **PROT SET/ALARMS** key to read the message or messages. Once you have read a message, the system clears it from memory. To tell the system that a message has been read, press an arrow key. If a message has been read and the conditions that caused the alarm no longer exist, the display shows *Alarms Cleared*.

If the unit has shut down, resume operation by pressing the **OUT ON/OFF** key.

The following table shows what to do if there is an OC Alarm and an OP Alarm, and the conditions that caused the alarms no longer exist:

Step #	Do This	You Will See
1		OC Alarm
2		OP Alarm

If the alarms are cleared, the system returns to its default operating state. If the alarms persist, the system prompts `OVP SET #####V`. The system has shifted to output protection mode. You can press **ENTER** to work with the OVP setting or press the arrow keys to view the other protection settings. See “Set Output Protection” on page 65 for more information.



WARNING- Fire Hazard

If an over-voltage, over-current, or over-power protection error persists without apparent cause, press **OUT ON/OFF** to disable the output, and turn the AC switch OFF. Inspect the load and power supply for evidence of an electrical fault. The power supply should not be brought back into operation if there is any evidence of an electrical fire or other safety hazards.

The possible alarms are:

- OVP Shutdown
- UVP Shutdown
- OCP Shutdown
- UCP Shutdown
- OPP Shutdown
- UPP Shutdown
- UVP Alarm
- OCP Alarm
- UCP Alarm
- OPP Alarm
- UPP Alarm
- Fold Shutdown
- SenseShutdown
- Hi Temp Alarm
- OTP Shutdown
- AC Off

Operation

Power Supply Operation

Shutdown vs Protection Alarm

If a protection setpoint is exceeded, the system does the following:

1. If `S/D if tripped?` Y has been selected, the unit shuts down.
If it is an OVP alarm, the unit shuts down.
2. If `S/D if tripped?` N has been selected, and it is not an OVP alarm, the unit does not shut down but does create an alarm message.
3. If the unit is not shutting down, the system still sets the appropriate status bits in the questionable status register, which can be queried remotely. See “Status Registers” on page 142 for more information.

Set Up Remote Control

The power supply can be controlled locally with the front panel or remotely through several different interfaces. The remote interfaces are discussed in Section 4, “Remote Operation”, Appendix B. “SCPI Command Reference”, and Appendix D. “GPIB”.

The factory default remote control setting is RS-232. It has a default configuration of 9600 baud.

Toggle Local/Remote

The **LCL/RMT** key allows you to shift between local and remote control.

To shift from local to remote control:

Do This	You Will See
	RS-232

In the case shown, the power supply has changed from local, front panel control to remote control through its RS-232 port. The remote control options are RS-232, Analog V and I, Analog V, Analog I, GPIB, and Linked. You can change the remote control source through the **REMOTE SELECT** menu option. (See “Select Remote Control Source” below.)

There are 2 exceptions to this function:







- If the power supply has Local Lockout (LLO) active, it will not let you shift from remote to local control. Instead, the display will show `LLO on`, and the system will remain in remote control.
- If the system is using GPIB, it will shift to remote control only when the Remote enable line, `REN = 1` and a command is sent from the remote controller.

Select Remote Control Source The **REMOTE SELECT** menu option allows you to select an interface for remote control. Before selecting a remote control source, be sure to set up each interface using the Remote Configure menu. See “Configure Remote Control Source” on page 76

Remote control sources are listed here along with their respective programming interfaces:

- RS-232
- Analog V & I: Voltage and current programmed via the analog interface
- Analog V: Voltage programmed via the analog interface; current programmed via front panel
- Analog I: Current programmed via the analog interface; voltage programmed via front panel
- GPIB
- Multichnl: multichannel operation using the optional CANbus interface between units (only available for 6000 Watt units)

To change the remote control source:

Step #	Do This	You Will See
1		ERROR MSGS
2	 4 times	REMOTE SELECT
3		RS-232
4	 or  Press repeatedly until the desired remote control source appears.	The options are RS-232, Analog V & I, Analog V, Analog I, GPIB, and RMT linked.
5		The setting is saved and the display returns to its default operating mode.

If you change the remote setting to GPIB, the next time you shift from local to remote control, the unit will shift to GPIB control.







Operation

Power Supply Operation

Configure Remote Control Source

The **REMOTE CONFIG** menu option lets you set up the attributes of the remote control sources.

The following table shows how to access and work with the Remote Configuration option.

Step #	Do This	You Will See
1		ERROR MSGS
2	 5 times ¹	REMOTE CONFIG
3		RS-232 Cfg
4	 or  Press repeatedly until the desired remote control source appears.	RS-232 Cfg Analog Cfg GPIB Cfg Multichnl Cfg
5		See the tables that follow to see how to proceed.

1. You can also press **MENU** 5 times.

After you have selected the remote control source you want to configure, configure that setting using appropriate values from the following table. Select values using the arrow keys or the numeric keypad. To save a value you have selected, press **ENTER**.

See Section 4, “Remote Operation” for detailed instructions on setting up remote interfaces.

Remote Control Source	Prompt	Configuration Settings
RS-232	Baud #####	1200, 2400, 4800, 9600, 19200, 38400 ¹
	Flow Ctl ####	Hdwr, XON, None ²
Analog	Input ##### V	Select the operating range of the API: 0–5 0–10
GPIB	GPIB Addr ##	1–30
	PON SRQ? Y	Y, N
Multichannel	Slave Addr ##	2-50
	Connect?	Y, N

1. This range depends on the user's network configuration.

2. Hdwr = hardware handshake; XON = software flow control XON/XOFF characters used; None = no flow control

Store User Settings If you have a frequent or constant need for a specific voltage and current output, you can save these setpoints in the power supply's memory as a user setting. Once a setting is stored, it remains in the power supply's memory after the unit is powered off.

Ten user setting memory locations are available, and each saves the following parameters:

- Voltage setpoint
- Current setpoint
- Power setpoint
- Over-voltage protection setpoint (OVP)
- Under-voltage protection setpoint and shutdown configuration (UVP)
- Over-current protection setpoint and shutdown configuration (OCP)
- Under-current protection setpoint and shutdown configuration (UCP)
- Over-power protection setpoint and shutdown configuration (OPP)
- Under-power protection setpoint and shutdown configuration (UPP)
- Foldback protection mode and delay settings
- Over-temperature protection auto recovery configuration (OTP)
- AC Off auto recovery configuration (ACO)
- Aux line configuration
- Front panel display configuration
- Front panel knob lockout
- Voltage, current, and power limits
- Triggered voltage, current and power setpoints
- Trigger source

Note All parameters are saved and used when the user setting is recalled. Therefore, you should set parameters that you do not care about to the factory defaults.

To create and save a user setting:

1. Set up the power supply with all the parameters you require.
2. Press **STORE**.
3. Select a memory location, and press **ENTER** to save your settings.

Operation

Power Supply Operation

The following table demonstrates how to set and save current and voltage settings:

Step #	Do This	You Will See
1	VOLTAGE	Set #####V
2	Turn the Voltage knob or use the numeric keypad to enter a voltage setpoint.	Set #####V Your voltage setting appears on the display.
3	ENTER	Your voltage setting is saved.
4	CURRENT	Set #####A
5	Turn the Current knob or use the numeric keypad to enter a current setpoint.	Your current setting appears on the display.
6	STORE	Set 1 (unused) ¹
7	ENTER	Set 1 Your voltage and current setting is now saved as Set 1.





1. (unused) appears with Set 1 if there are no saved settings in the system. Press **Enter** to save your setting as Set 1. If (unused) does not appear, then you can overwrite Set 1 with your new setting or use the numeric keypad or arrow keys to find the next unused set number. You can also press **CE** to clear an existing setting and then press **ENTER** to replace the cleared setting with your new setting.

Change Stored Settings

To change a stored setting, overwrite it with a new setting, or select the setting, press **CE** and hold it for a few seconds to clear the setting from memory.

Recall Settings After you have saved one or more settings, you can press **RECALL** to retrieve them from the power supply’s non-volatile memory or to run an auto-sequence program. (You can also recall stored settings through your Power ON configuration. See “Configure Power ON Settings” on page 84.)

To retrieve a setting using RECALL:

Step #	Do This	You Will See
1		Last Setting
2		User Settings
3		User Set 1 ¹
4		This setting is retrieved from memory, the power supply’s output changes to match the setting, and the display returns to its default operating mode.



1. If you want a different setting besides Set 1, use the arrow keys or numeric keypad.

Four options are available from the Recall memory:

1. **Last Setting:** Returns the setpoints to values stored before power was turned off.
2. **User Settings:** Returns the setpoints to one of ten possible saved values.
3. **Factory Preset:** Returns the setpoints to the original out-of-the-box values.
4. **Auto Sequence:** Returns control of the setpoints to one of ten possible saved programs. (For further information, see “Program Auto Sequence” on page 87.)

To access these options, press **RECALL** repeatedly until the correct option appears, or press the arrow keys. Pressing **RECALL** lets you scroll through the options in the direction listed above. Pressing the arrow keys lets you cycle through the options in either direction.



To restore the last setting:

Step #	Do This	You Will See
1	 Press once.	Last Settings
2	 Press to restore last setting.	

Operation



Power Supply Operation

To select a stored user setting:

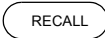

Step #	Do This	You Will See
1	 Press twice.	User Setting
2	 Use the numeric keypad or arrow keys to enter a value between 1 and 10.	User Set ## ¹
3	 Use the numeric keypad or arrow keys to enter a value between 1 and 10.	

1. This prompt appears when there is at least one saved setting in memory. If there are no saved settings, the display reads `None Saved` and then automatically returns to `User Settings`.

To select a factory setting:

Step #	Do This	You Will See
1	 Press 3 times.	Factory Preset
2	 This restores the setpoints to factory defaults.	

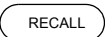
To select Auto Sequence:

Step #	Do This	You Will See
1	 Press 4 times.	Auto Sequence
2	 Use the numeric keypad or arrow keys to enter a value between 1 and 10.	User Set ## ¹
3	 This runs the selected Auto Sequence program.	

1. This prompt appears when there is at least one saved programs in memory. If there are no saved programs, the display reads `None Saved` and then automatically returns to `Auto Sequence`.

For operation of Auto Sequence mode, see “Using Auto Sequencing” on page 97.

Table 3.1 Settings Affected by Recall



Feature	Factory Preset Value
Voltage setpoint	0.0V
Current setpoint	0.0A
Power setpoint	103% of power rating
Triggered voltage setpoint	Disabled (DEF)
Triggered current setpoint	Disabled (DEF)
Triggered power setpoint	Disabled (DEF)
Trigger source	None
Low voltage setpoint limit	0.0V
High voltage setpoint limit	103% of voltage rating
Low current setpoint limit	0.0A
High current setpoint limit	103% of current rating
Low power setpoint	0% of power rating
High power setpoint	103% of power rating
Over voltage protection	Disabled (0.0V)
Under voltage protection	Disabled (0.0V) and not shutdown when tripped
Over current protection	Disabled (0.0A) and not shutdown when tripped
Under current protection	Disabled (0.0A) and not shutdown when tripped
Over power protection	Disabled (0.0W) and not shutdown when tripped
Under power protection	Disabled (0.0W) and not shutdown when tripped
Fold shutdown protection	None and delay 0.5s
AC off shutdown recovery	Auto recover
Over temperature shutdown recovery	Latched
Front panel display config	Show V, I & P
Knob lockout	None
Aux line configuration	None and active low

Operation

Power Supply Operation

Read Error Messages The **ERROR MSGS** menu option lets you display up to 50 queued messages. Once each message has been read, it is cleared from the system. Press either arrow key to clear the displayed message and bring up the next message. Once all messages have been read and cleared, the prompt reads `No errors`, and the power supply automatically returns to the default state.

To read and clear error messages:

Step #	Do This	You Will See
1		<code>ERROR MSGS</code>
2		<code>Error -###</code>
3	 Press repeatedly until all messages have been read and cleared.	<code>No errors</code>

For a detailed description of all error messages, see Appendix C.







Configure User Lines

The USER LINES menu option lets you configure the auxiliary status lines

The Auxiliary (Aux) lines are 2 open collector outputs that can be used to monitor the status of the power supply. The auxiliary lines are referred to as AUX A and AUX B. See “Making Connections for Remote Control” on page 107 for details. Each user line also has a corresponding annunciator on the front panel display to indicate when it is on. Aux lines can be set up to report the following status conditions:

- **None**
- **Unregul:** Output Unregulated
- **OVP:** Over-Voltage Condition
- **UV:** Under-Voltage Condition
- **OC:** Over-Current Condition
- **UC:** Under-Current Condition
- **OP:** Over-Power Condition
- **UP:** Under-Power Condition
- **AC Off:** Input power has failed or is out of range
- **OTP:** Over-Temperature Condition
- **Hi Temp:** High-Temperature Condition
- **SenseProt:** Sense Protection Tripped
- **Fold Prot:** Fold Protection Tripped
- **CC:** Constant Current Mode
- **CV:** Constant Voltage Mode
- **CP:** Constant Power Mode
- **Out ON:** Output On
- **Out OFF:** Output Off

To access and work with the USER LINES menu option:

Step #	Do This	You Will See
1		ERROR MSGS
2	 1	USER LINES
3		Aux line A
4	 or  to select which line to configure.	Aux line B
5		Cfg None





1. You can also press **MENU** again to bring up the AUX LINES option.

Operation

Power Supply Operation

Aux line B has been selected to be configured.

To configure Aux line B:

Step #	Do This	You Will See
1	 Press repeatedly until the desired option appears. For this example, CV is selected.	Cfg CV
2		Pol Act High
3	 Press repeatedly until the desired option appears. Select either “Act High” (Active high logic) or “Act Low” (Active low logic) for the auxiliary lines. In this example, Active Low is selected.	Pol Act Low
4		This setting is saved and the display returns to its default operating mode.

Configure Power ON Settings

The Power ON configuration can be set with 4 options:

- **Factory Preset:** Where the Power ON output is reset to the original factory levels. These include: Output=OFF, $V_{SET}=0$, and $I_{SET}=0$. (default configuration)
- **Last Setting:** Where the Power ON output is set to the same level as when it was last powered OFF. This is useful for automatic recovery from short power failures.
- **User Settings:** Where the Power ON output is set to a stored setting that is recalled from memory. See “Store User Settings” on page 77.
- **Auto Sequence:** Where the Power ON output can be recalled from memory. See “To edit the sequence’s trigger source:Using Auto Sequencing” on page 96.

The output state also depends on the Power ON Output setting. The values listed above are true only if the OUT ON? setting is **Yes**. Otherwise Output is off (unit in Standby mode).









See “Recall Settings” on page 79 for settings affected by the Power ON feature.

Each of the 4 Power ON configuration options can be accessed from the Front Panel menus or remotely through a set of digital commands. The procedures that follow show how to use the Front Panel menus.

Factory Preset

Selecting **Factory Preset** lets you restore the factory defaults the next time the power supply is powered ON.

To select Factory Preset:

Step #	Do This	You Will See
1		ERROR MSGS
2	 2 times ¹	PON CONFIG
3		Last Setting
4	 2 times ¹	Factory Preset
5		Out ON? Y
6	 to select, or  and  to change.	The default display for the selected operating mode.

1. You can also press the Down arrow 2 times.











Operation

Power Supply Operation

User Setting

User Setting lets you restore a custom setting the next time the unit is powered on. This assumes at least one user setting has been stored in memory. See “Store User Settings” on page 77.

To select User Setting:







Step #	Do This	You Will See
1		ERROR MSGS
2	 2 times ¹ .	PON CONFIG
3		Last Setting
4		User Settings
5	 Enter a value from 1 to 10.	User Set ##
6	 or  to scroll,  to select.	Out ON? Y
7	 to select, or  and  to change.	The default display for the selected operating mode.

1. You can also press the Down arrow 2 times.

Last Setting

Selecting **Last Setting** lets you restore the settings that are in use when the power supply is powered off, the next time it is powered on.

To select Last Setting:









Step #	Do This	You Will See
1		ERROR MSGS
2	 2 times ¹ .	PON CONFIG
3		Last Setting
4		Out ON? Y
5	 to select, or  and  to change.	The default display for the selected operating mode.

1. You can also press the Down arrow 2 times.

Auto-Sequence

Auto Sequence lets you recall a stored program next time the unit is powered on. (Assumes at least one program has been saved in memory. See “To edit the sequence’s trigger source:Using Auto Sequencing” on page 96.)

To select Auto Sequence:

Step #	Do This	You Will See
1		ERROR MSGS
2	 2 times ¹ .	PON CONFIG
3		Last Setting
4	 3 times ² .	Auto Sequence
5		Auto Seq 1
6	 or  to scroll ³ ,  to select.	The default display for the selected operating mode.

1. You can also press the Down arrow 2 times.
2. You can also press the Down arrow 3 times.
3. You can scroll through up to 10 stored programs.

Program Auto Sequence The **AUTO SEQ PGM** menu option is used to set up command programs for automated operation. There are 10 programmable sequences with up to 99 steps per sequence.

Each sequence can be repeated a programmable number of times or forever. If the sequence contains steps that advance by a trigger event, a single trigger source can be selected to advance those steps.

Each step can be programmed to set the voltage setpoint, current setpoint, power setpoint, and OVP level automatically. Each step can also be programmed to advance by a delayed time or a trigger event. The duration of each step may range from 10 ms to 99 hours.

Operation













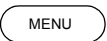

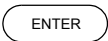

Power Supply Operation

Programming a Sequence

This option allows you to set up command programs for automated operation.

To program a sequence:

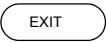

Note In the following procedure, only change the default setpoints if required. Otherwise simply press **ENTER** to accept.

Step #	Do This	You Will See
1		ERROR MSGS
2	 or  6 times	AUTO SEQ PGM
3		Sequence 1
4	 or  . Use the scroll keys to select a sequence to work with.	Sequence #
5		Edit Sequence
6	 Edit mode is selected	Step 1
7		Edit Step
8	 Enter the step voltage setpoint	S01 ####V
9	 Enter the step current setpoint.	S01 ####A
10	 Enter the step power.	S01 ####W
11	 Enter the step OVP level.	S01 ####V
12		Set Step Time
13	 or  . Use the scroll keys to select how you want to advance to the next step: <ul style="list-style-type: none">• Set Step Time waits for a certain period. See the "Setting step advance by time:" table below.• Wait for Trig waits for a trigger event. See the "Setting step advance by trigger:" table below.	

Step #	Do This	You Will See
14	Set the step advance method.	To Next Step
15	<p> To go to the next step in the sequence. This will return you to step 7 in this table. Repeat steps 7 to 14 for all remaining steps in the sequence.</p> <p> Press to exit auto sequence programming and return to the default screen.</p>	Step 2

Setting step advance by time:

This procedure is continued from step 13 in the “To program a sequence:” table. It describes how to program the sequence to advance a particular step by waiting for a certain time period.

Step #	Do This	You Will See
		Set Step Time
1	<p> Enter the Step duration. The format of the display is hh:mm:ss.ss.</p> <p>Use the decimal key to move to the right.</p>	T=##:##:##.##
2		To Next Step



The completion of this procedure will bring you back to step 15 of the “To program a sequence:” table. Continue programming the current step.

Operation

Power Supply Operation

Setting step advance by trigger:

This procedure continues from step 13 in the “To program a sequence:” table. It explains how to program the sequence to advance a particular step by waiting for a certain trigger event. See “Editing Trigger Source of a Sequence” on page 96 for more information about trigger event.

Step #	Do This	You Will See
		Set Step Time
1	 or  . Use the scroll keys to select the Wait for Trig option.	Wait for Trig
2		To Next Step











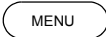

The completion of this procedure will bring you back to step 15 of the “To program a sequence:” table. Continue programming the current step.

Note The default value for a sequence’s repeat time and trigger source is repeat once and trigger from key. See “Editing Repeat Times of a Sequence” on page 95 and “Editing Trigger Source of a Sequence” on page 96 for an explanation of how to edit these values.

Deleting a Sequence

This option allows you to delete an entire sequence.

To delete a sequence:

Step #	Do This	You Will See
1		ERROR MSGS
2	 6 times or  .	AUTO SEQ PGM
3		Sequence 1
4	 or  . Use the scroll keys to select a sequence to delete.	Sequence #
5		Edit Sequence
6	 or  . Use the scroll keys to select the Del Sequence option.	Del Sequence
7		Delete Seq? N
8	 or  . Use the scroll keys to confirm deletion.	Delete Seq? Y
9		Seq Erased
10	Wait. Sequence is now deleted.	













Operation

Power Supply Operation

Editing a Sequence Step

This option allows you to edit a particular step in a sequence that has already been programmed or to add steps to a new program.











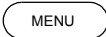

To edit a step in a programmed sequence:

Step #	Do This	You Will See
1		ERROR MSGS
2	 6 times or  .	AUTO SEQ PGM
3		Sequence 1
4	 or  . Use the scroll keys to select a sequence to work with.	Sequence #
5		Edit Sequence
6		Step 1
7	 or  . Use the scroll keys to select a sequence to edit.	Step #
8		Edit Step
9	 or  . Use the scroll keys to select the Edit Step option. Follow step 8 of the "To program a sequence:" table in the "Programming a Sequence" section to finish editing the step.	Edit Step

Inserting a Sequence Step

This option allows you to insert a particular step in a sequence that has already been programmed.

To insert a step into a programmed sequence:

Step #	Do This	You Will See
1		ERROR MSGS
2	 6 times or  .	AUTO SEQ PGM
3		Sequence 1
4	 or  . Use the scroll keys to select a sequence to work with.	Sequence #
5		Edit Sequence
6		Step 1
7	 or  . Use the scroll keys to select the step to insert in front of.	Step #
8		Edit Step
9	 or  . Use the scroll keys to select the Insert Step option. Follow step 8 of the "To program a sequence:" table in the "Programming a Sequence" section to finish inserting the step.	Insert Step

















Operation

Power Supply Operation

Deleting a Sequence Step

This option allows you to delete a particular step in a sequence that has already been programmed.













To delete a step in a programmed sequence:

Step #	Do This	You Will See
1		ERROR MSGS
2	 6 times or  .	AUTO SEQ PGM
3		Sequence 1
4	 or  . Use the scroll keys to select a sequence to work with.	Sequence #
5		Edit Sequence
6		Step 1
7	 or  . Use the scroll keys to select the step to delete.	Step #
8		Edit Step
9	 or  . Use the scroll keys to select the Delete Step option.	Delete Step
10		Step ## Deleted
11		Step ##
12	Step has now been deleted. Select another step to work with or escape by pressing  .	

Editing Repeat Times of a Sequence

This option allows you to edit the number of times the sequence will run before it goes into STOP mode.

To edit the sequence's repeat times:

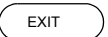
Step #	Do This	You Will See
1		ERROR MSGS
2	 6 times or  .	AUTO SEQ PGM
3		Sequence 1
4	 or  . Use the scroll keys to select a sequence to work with.	Sequence #
5		Edit Sequence
6	 or  . Use the scroll keys to select the Set Repeat # option.	Set Repeat #
7		Run Once
8	 or  . Use the scroll keys to select the number of times to run the sequence: <ul style="list-style-type: none"> • Once will run the sequence once. • 2 to 9999 times will run the sequence the specified number of times. • Forever will run the sequence forever. 	Run XXXX
9		Edit Sequence
10	The sequence's repeat times has now been changed. Select another sequence to work with or escape by pressing 	













Operation

Power Supply Operation

Editing Trigger Source of a Sequence

When steps are programmed to advance step by trigger, this option allows you to edit the source of those trigger events.

To edit the sequence's trigger source: Using Auto Sequencing

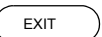
Step #	Do This	You Will See
1		ERROR MSGS
2	 6 times or  .	AUTO SEQ PGM
3		Sequence 1
4	 or  . Use the scroll keys to select a sequence to work with.	Sequence #
5		Edit Sequence
6	 or  . Use the scroll keys to select the Trig Source option.	Trig Source
7		Trig From Man
8	 or  . Use the scroll keys to select the trigger source: <ul style="list-style-type: none">• Man is triggered by pressing the trigger key.• Ext is triggered by the rear external trigger line.• Imm is triggered by receiving an INIT:IMM command• Bus is triggered by a GPIB GET command or a *TRG command.	Trig from ###
9		Edit Sequence
10	The sequence's trigger source has now been changed. Select another sequence to work with or escape by pressing 	

Using Auto Sequencing

Auto Sequence programs can be set to run as a Power ON default or recalled from memory by pressing the **RECALL** key. In Auto Sequence mode, 3 of the function keys operate as alternates:

- **VOLTAGE** operates as **RUN/PAUSE**.
- **CURRENT** operates as **TRIGGER**.
- **STORE** operates as **END**.

In the following discussion about running programs in Auto Sequence mode, each of the keys mentioned above is referred to as their alternate function.





When an Auto Sequence program is launched from Recall, the AUTO SEQ annunciator illuminates on the front panel. Press **EXIT** to return the unit to normal operating mode.

Auto sequence programs can operate 3 different ways:

- They can run automatically through a series of steps, repeating those steps a pre-set number of times if necessary, and complete their operation without intervention from an operator.
- They can run automatically and be paused. If you need to stop the program temporarily, you can press **PAUSE** to stop it, and then press **RUN** to resume the program's operation when ready. When a sequence is manually paused, the Pause annunciator is illuminated. (The output remains on and voltage may be present at the output.)
- They can run automatically programmed to wait for a trigger at certain points in the sequence. If you want the program to resume, you can press **TRIGGER** or supply a trigger signal to the rear panel Trigger input. When a sequence is paused by a trigger, the Trigger? annunciator is illuminated.

During operation, press the Up key to display information on the currently running sequence including sequence number, step number, step parameters (settings), the trigger source, as well as the loop count.

To run an auto sequence program:

Step #	Do This	You Will See
1	 4 times	Auto Sequence
2		Auto Seq 1
3		Seq 1 ready
4		#####V #####A





Operation

Power Supply Operation

Configure Display The **DISPLAY CONFIG** menu option allows you to select the readback values displayed when the power supply is operating in its default state.

The factory default is to display voltage and current readback, but you can also choose voltage and power, current and power, or voltage, current, and power.

This table shows how to access and work with the **DISPLAY CONFIG** option.







Step #	Do This	You Will See
1		ERROR MSGS
2	 until you see the “DISPLAY CFG” option ¹	DISPLAY CFG
3		Show V, I & P
4	 Using the arrow keys, select from Show V and I, Show V and P, Show I and P, Show V, I, & P ² .	Show V and I
5		The setting is saved.

1. You can also press **MENU** repeatedly to bring up the **Display Config** option.

2. The option, Show V, I, & P is not available in current share mode.







Lock Out Control Knobs The **KNOB LOCKOUT** menu option allows you to lock the front panel knobs, forcing changes to be made via the **VOLTAGE** and **CURRENT** keys. Knobs should be locked out whenever you do not want someone to accidentally adjust the supply settings while the unit is operating in local mode.

To lock out both knobs:

Step #	Do This	You Will See
1		ERROR MSGS
2	 until you see the “KNOB LOCKOUT” option	KNOB LOCKOUT
3		Lock V Knob? N
4		Lock V Knob? Y
5		Lock I Knob? N The Voltage knob is locked out.
6		Lock I Knob? Y
7		The setting is saved and the display returns to its default operating mode.

If you attempt to use either knob, the display shows `Knobs Locked`, and there is no effect on the output.

To lock out only the Voltage knob:

Step #	Do This	You Will See
1		ERROR MSGS
2	 until you see the "KNOB LOCKOUT" option	KNOB LOCKOUT
3		Lock V Knob? N
4		Lock V Knob? Y
5		Lock I Knob? N The Voltage knob is locked out.
6		The Current knob is not locked out. This setting is saved, and the display returns to its default operating mode.

If you attempt to use the Voltage knob, the display shows `V Knob Locked`, and the output is not affected. If you attempt to use the Current knob, the knob operates normally. You can also lock the Current knob without locking the Voltage knob. To unlock the knobs, repeat the steps above, and select `N` for `Lock _ Knob?`

Operation







Power Supply Operation

Set V, I, and P Limits The voltage, current and power setpoints can be limited to less than the supply rating range to match the tolerance of connected equipment or any other criteria you may have.







You can control the voltage, current and power setpoint limits through the **SETPT LIMIT** menu option. Once the limits have been changed from the supply's default rated output, settings outside this range are no longer accepted.

Note Setpoint limits do not apply to the triggered outputs and auto sequence outputs.

To set the voltage limits:

Step #	Do This	You Will See
1		ERROR MSGS
2	 until you see the "SETPT LIMIT" option	SETPT LIMIT
3		Voltage Limit
4		High 0V
5	Use the Voltage knob, arrow keys, or numeric keypad to enter a value. The value must be within 0V to 103% of the unit's rated voltage.	High #####V
6		Low 0V The Maximum setting is saved and the Minimum setting appears.
7	Use the Voltage knob, arrow keys, or numeric keypad to enter a value. The value must be within 0V to 103% of the unit's rated voltage.	Low #####V
8		The setting is saved and the display returns to its default operating mode.







To set the current limits:

Step #	Do This	You Will See
1		ERROR MSGS
2	 until you see the "SETPT LIMIT" option	SETPT LIMIT
3		Voltage Limit
4		Current Limit
5		High 0A
6	Use the Current knob, arrow keys, or numeric keypad to enter a value. The value must be within 0A to 103% of the unit's rated current.	High #####A
7		Low 0A The Maximum setting is saved and the Minimum setting appears.
8	Use the Voltage knob, arrow keys, or numeric keypad to enter a value. The value must be within 0A to 103% of the unit's rated current.	Low #####A
9		The setting is saved and the display returns to its default operating mode.

Operation

Power Supply Operation

To set the power limit:

Step #	Do This	You Will See
1		ERROR MSGS
2	 until you see the "SETPT LIMIT" option	SETPT LIMIT
3		Voltage Limit
4	 2 times	Power Limit
5		High #####W
6	Use the Voltage and Current knobs, arrow keys, or numeric keypad to enter a value. The value must be within 0W to 103% of the unit's rated power.	High #####W
7		Low #####W The Maximum setting is saved and the Minimum setting appears.
8	Use the Voltage knob, arrow keys, or numeric keypad to enter a value. The value must be within 0W to 103% of the unit's rated power.	Low #####W
9		The setting is saved and the display returns to its default operating mode.

Slew Rate The slew rate is calculated as a function of change in the output voltage and a given time interval. The maximum slew rate is 1% rated voltage/150us. The slew rate is saved upon power off and restored at power on. Output ON/OFF and shutdown are not affected by the programmable slew rate. These functions have a slew rate of 1%/20ms.

The range of output voltage is 5% - 0.1% of rated voltage.

The range of time interval is 1.5 s - 150 us.

The negative slew rate is limited by the discharge rate of the output capacitors.

During current share, slaves operate with their default slew rate. The master operates at its programmed slew rate. Hence a programmable slew rate for the system is achieved. However, this slew rate is limited by the speed of the control loop. The slaves will return to their programmed slew rate when they exit current share slave operation.

The slew rate error increases as the slew rate increases.

Selecting **SLEW RATE** from the main menu will give you two choices:

Voltage slew - adjust the voltage slew rate

Voltage default - restore the default voltage slew rate

Selecting **VOLTAGE DEFAULT** will return the slew rate to the default value of 1% rated voltage per 150us.

To set the slew rate:

Step #	Do This	You Will See
1	<input type="button" value="MENU"/>	ERROR MSGS
2	Use the scroll keys to get the SLEW RATE menu.	SLEW RATE
3	<input type="button" value="ENTER"/>	Voltage slew
4	<input type="button" value="ENTER"/>	dV: 0.100 V
5	Enter the desired voltage step. Allowable range is 0.1% to 5% rated voltage.	dV: 1.000 V
6	<input type="button" value="ENTER"/>	dt: 150 us
7	Enter the time interval. The range is 150 us to 1.5 s.	dt: 1000 us
8	<input type="button" value="ENTER"/>	

The combination must not exceed 1%/30us. Though the software will attempt to achieve higher slew rates, it is limited to this value by hardware constraints. The power supply slew rate cannot be faster than the rise and fall times given in the product specifications on page 228. Manufacturer's recommendation is to keep the slew rate at or below the default value.



Operation

Default Display

View Model Information The **MODEL INFO** menu option displays hardware and software information including:

- Manufacturer (Xantrex)
- Model description (e.g. XDC 60–100)
- Voltage and current ratings (60 V 100 A)
- ROM version (e.g. ROM Ver. 5.000)
- FPGA version (e.g. FPGA Ver. A007)
- SCPI version supported (e.g. SCPI 1997.0)
- Serial number

To access and work with the View Model Information option:

Step #	Do This	You Will See
1		ERROR MSGS
2	 1 time	MODEL INFO
3		Xantrex
Press Up or Down arrow keys to cycle through Model Information.		

Default Display

The default display normally shows the readback of the voltage and current output. (To change the display to show voltage and power, or current and power, or voltage, current, and power, see “Configure Display” on page 98.) The display also shows the Regulation mode, CV, CC, or CP. Bar graphs represent the percentage of full voltage, current, and power being output by the supply.

View Power Output To see the present power output in watts, press the Up arrow key. The output power appears on the display. After a few seconds, the display shows the voltage and current output again.

Monitor Status The front panel display has a large number of indicators and annunciators. See “Display” on page 28 and “Status Annunciators” on page 28.

Section 4. Remote Operation

Overview

This chapter is divided into 3 main parts:

- “Remote Analog Operation” on page 108 provides an overview of how to use remote analog control
- “Multichannel Operation (6000 Watt only)” on page 113 gives information on the setup and use of Multichannel functionality
- “RS-232 Operation” on page 118 explains how to send commands to the power supply using the SCPI programming language

In addition to front panel operation, the power supply can be operated remotely through the following interfaces:

- Analog 0 to 5V, 0 to 10V
- RS-232
- GPIB (with optional GPIB/CANbus card, only available for 6000 Watt units)
- Multichannel (with optional GPIB/CANbus card, only available for 6000 Watt units)

The connecting ports for these interfaces are shown in, Figure 1.6 and Figure 4.1.

The remote interfaces (except for the analog programming interface) accept commands in 2 formats: IEEE 488.2 common commands and SCPI commands.

SCPI commands that are aliases for the IEEE 488.2 common commands have been provided for use over the multichannel interface.

Remote Operation

Overview

The IEEE 488.2 common commands that are supported are:

*CLS	*PSC
	<on_off_state>
*ESE	*RCL
	<user_setting>
*ESE <enable_mask>	*RST
*ESR?	*SAV
	<user_setting>
*IDN?	*SDS
*OPC	*SRE?
*OPC?	*SRE
	<enable_mask>
*OPT	*STB
*PRE?	*TRG
*PRE <enable_mask>	*TST?
*PSC?	*WAI

For a detailed listing of all SCPI commands, see Appendix B, Table B.1 to Table B.14.

Before using a SCPI command, familiarize yourself with the information in “Using SCPI Commands” on page 195.

Making Connections for Remote Control

See Figure 4.1 for the locations of the RS-232, GPIB and CANbus connectors and the locations and the pin numbers of the User Lines and the Analog Programming Lines. GPIB and CANbus are optional.

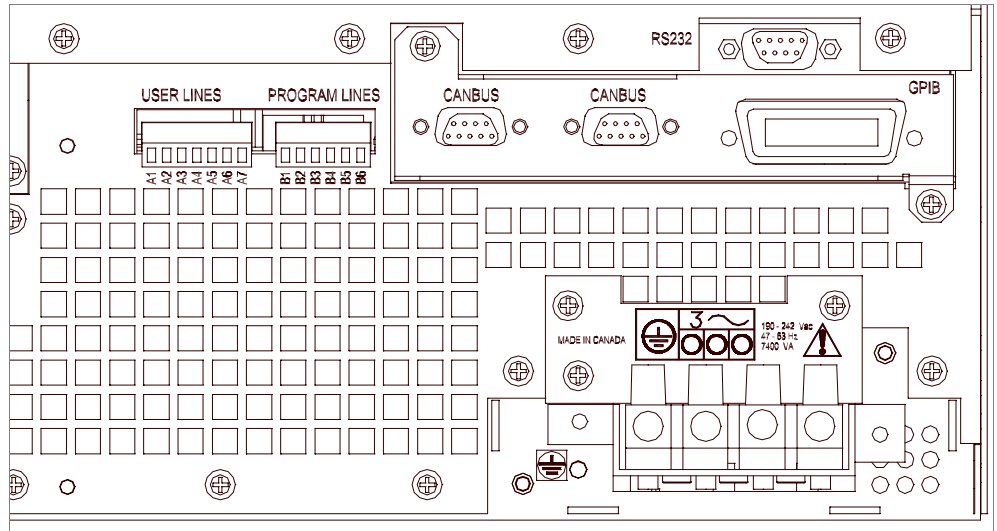

Figure 4.1 View of Remote Interface Connections

Removable mating connectors are supplied for the user lines and program lines, while the mating connectors and cables for the other ports are supplied by the user.

Remote Analog Operation

Analog Connections The analog interface has 2 ports: the user lines and the analog programming lines. The tables below show the function and power flow for each pin on these ports.

The user lines are optically isolated. The output lines are open collector configuration. The input lines are capable of sinking 10mA (with recommended 5V at input) up to a maximum 90mA.

The analog program and monitor lines are fully isolated from the supply output, but not each other. Use precision variable low noise voltage sources for the program lines, and be sure that the program source ground potential is the same as on the analog readback circuitry.

The external analog monitoring circuitry must be high impedance because the onboard V and I readback sources have approximately 300 ohms output impedance.

Connect your program and readback lines to the removable wire clamp connectors marked “user lines” and “program lines” in Figure 4.1. Strip 0.2” (5mm) of insulation from the wires and clamp securely at the appropriate pin. See Table 4.1, Figure 4.1 and Table 4.2 for the location and function of each connector.

Use shielded twisted pairs of 22–24AWG for signal connections.

Pin Connections

Table 4.1 User Line Pins

Pin #	Function	Input/Output
A1	Aux Status Line A	Output
A2	Aux Status Line B	Output
A3	External Trigger 4–12V	Input
A4	Safety Interlock (Shutdown) 4–12V	Input
A5	Safety Interlock (Shutdown) GND	Input
A6	User Power, 5–12Vdc	Input
A7	User Ground	Input

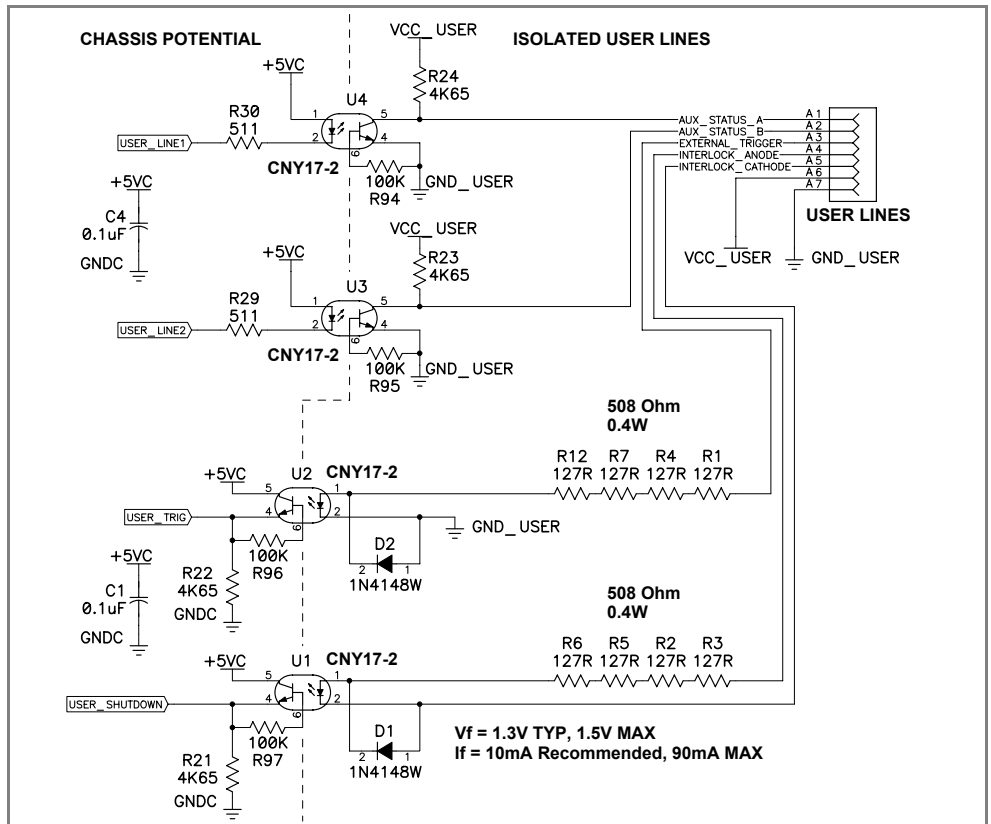

Figure 4.2 Schematic For User Line Interface

Table 4.2 Analog Programming Pins

Pin #	Function	Input/Output
B1	Analog Programming (GND)	Output
B2	12V (unregulated) 10mA max	Output
B3	Voltage Setpoint (0–5/10V)	Input
B4	Current Setpoint (0–5/10V)	Input
B5	Voltage Readback (0–5/10V)	Output
B6	Current Readback (0–5/10V)	Output

The analog setpoint and readback pins may be configured to work in either a 0–5V range or 0–10V range.

The programming lines have their own isolated power source (10mA max), and this power can be looped back to power the user lines, if required. Connect the pins as shown in Table 4.3.

Remote Operation

Remote Analog Operation

Table 4.3 Analog Pin Connections for Power Loop Back

Programming Line Pin #		User Line Pin #
B1	to	A7
B2	to	A6

Remote Interlock Using a Contact Closure

The interlock input may be configured for use with an external voltage free contact. Connect pins as shown:

Table 4.4 Analog Pin Connections with a Contact Closure

Programming Line Pin #		User Line Pin #
B2	to	A4
B1	to	A5









Closing an external contact across the interlock pins A4/A5 will then enable the unit. Opening the contact will disable the supply output.

Configure Analog Control

You may configure the analog programming lines to work in either a 0 to 5V range or a 0 to 10V range. You may also select whether the voltage, current or both are controlled with the programming lines. If you select only voltage or only current, the other will be controlled via the front panel.

Front Panel

First, configure the analog programming lines.







Step #	Do This	You Will See
1		ERROR MSGS
2	 5 times ¹	REMOTE CONFIG
3		RS-232 Cfg
4		Analog Cfg
5		Input 0-5V
6	 or  Select the input range.	0-5V or 0-10V
7		Setting is saved and menu is exited.

1. You can also press **MENU** 5 times.

Next select analog programming as the remote control interface.

Your options are

- Analog V & I - voltage and current programmed via the analog interface
- Analog V - voltage programmed via the analog interface; current set via front panel
- Analog I - current programmed via the analog interface; voltage set via front panel

Step #	Do This	You Will See
1		ERROR MSGS
2	 4 times	REMOTE SELECT
3		RS-232
4	 or  Select desired option.	Analog V&I, Analog V, or Analog I
5		Setting is saved.

Press the LCL/RMT button to begin remote operation via the analog interface.

SCPI

To select which setpoints to control via analog programming lines, use the command:

```
SYST:REM:SOUR {AVOL|ACUR|AVC}
```

Where

- AVOL (Analog VOLTage) selects only voltage to be programmed via the analog programming lines
- ACUR (Analog CURrent) selects only current to be programmed via the analog programming lines
- AVC (Analog Voltage and Current) selects voltage and current to be programmed via the analog programming lines

To select the voltage level:

```
SYST:COMM:APR:LEV {5|10}
```

Where

“5” is the 0-5V range, and

“10” is the 0-10V range

To put the unit into remote control:

```
SYST:REM:STAT REM
```

Remote Operation

Remote Analog Operation

Using Remote Analog Control Connect your programming voltage sources and monitors, ensuring that the appropriate 0–5V or 0–10V range has been configured and selected. (See page 75.) With the Analog Control mode selected, varying the programming source from 0 to 5V (or 10) will vary the output voltage or current from 0 to its rated maximum. A voltage in the range of 0–5V (or 10) on the corresponding monitor line is proportional to 0–100% of the rated output.

The output V and I readback lines are active for all operating modes as are the user interface lines. The analog programming inputs are active only when selected using the procedure in “Select Remote Control Source” on page 75. You can select analog remote control or either the output voltage or current, or both. When only voltage or current is being remotely controlled, the other setpoint is under front panel local control.

Multichannel Operation (6000 Watt only)

Multichannel Connections Multichannel operation is only available for 6000 Watt units. You may remotely control up to 50 power supplies from one programming interface (RS-232 or GPIB) by using multichannel addressing if the CANbus option is installed.

One power supply will be connected to a PC via RS-232 or GPIB. All other power supplies are connected via CANbus (Controller Area Network) to that unit. SCPI commands that include a channel address will be sent via the CANbus to the other power supplies. (Commands with the local address will be executed locally and will not be sent).

The multichannel address must be appended to the program mnemonic. If no multichannel address is appended to the program mnemonic, the command is executed by the local (directly connected) power supply.

Each unit of the network can send and receive commands to and from other units on the network. It is highly recommended that only one command be sent at a time. Any RS-232 and GPIB timeout settings should be increased when using multichannel commands.

CANbus

The CANbus port is a one male, one female DB9 connector to support “daisy chain” connections. The CAN (Controller Area Network) is an ISO standard (ISO11898) for a serial communication network. Table 4.5 describes the pin functions. Pins 1, 4, 8, and 9 are not used. The CANbus is used for communications in multichannel operation or current sharing (master/slave) operation, and is part of the optional GPIB/CANbus interface card.

Table 4.5 CANbus Pins

Pin #	Function
1	Not used
2	CANLO
3	Ground
4	Not used
5	Ground
6	Ground
7	CANHI
8	Not used
9	Not used

Remote Operation

Multichannel Operation (6000 Watt only)

Configuration Before connecting a power supply to a multichannel network, you must configure each power supply with a unique address. The front panel or a remote interface maybe used to do this.

One power supply must be configured to operate via RS-232 or GPIB.

Front Panel

1. Select the "REMOTE CONFIG" menu
2. Select the "Multichnl Cfg" menu. Press ENTER.
3. When prompted with "Addr" enter a unique network address in the range 1–50. Press ENTER

To receive and execute commands:

1. Select the "REMOTE SELECT" menu, then select "Multichannel" from the list. Press ENTER.

SCPI

Set a slave's multichannel address using the command:

```
SYSTem:COMMunicate:MCHannel:ADDRESS  
<multichannel-address>
```

where multichannel-address is an integer in the range of 1-50, and the command is sent via a controller directly connected to the slave's RS-232 port.

If the unit is to execute commands, set the power supply to accept control via multichannel commands (the CANbus interface) with the SCPI command:

```
SYSTem:REMote:SOURce MCHannel
```

- Setup**
1. Connect power supplies to be controlled via the CANbus network. Parallel male DB9 to female DB9 cables (N-1) are required. Connect the power supplies in series, linking the first power supply to the second using one cable, and then the second to the third using a second cable and the second CAN port. A single ribbon cable with multiple connectors may be used instead of several cables for ease of connection. Terminate the bus at both ends with 120 ohm, 1/4 Watt resistors (included) across the CAN HI and CAN LO signals (Pins 2 and 7). See Table 4.5, "CANbus Pins," on page 113.

2. At least one power supply should be connected to a PC via RS-232 or GPIB for multichannel functionality. Configure each of the power supplies with a unique address, as described in the configuration section. Addresses may be in the range 1 to 50 inclusive.
3. Turn the power supplies on one at a time, setting the remote control source of each power supply which will accept commands to "multichannel."

See Figure 4.3.

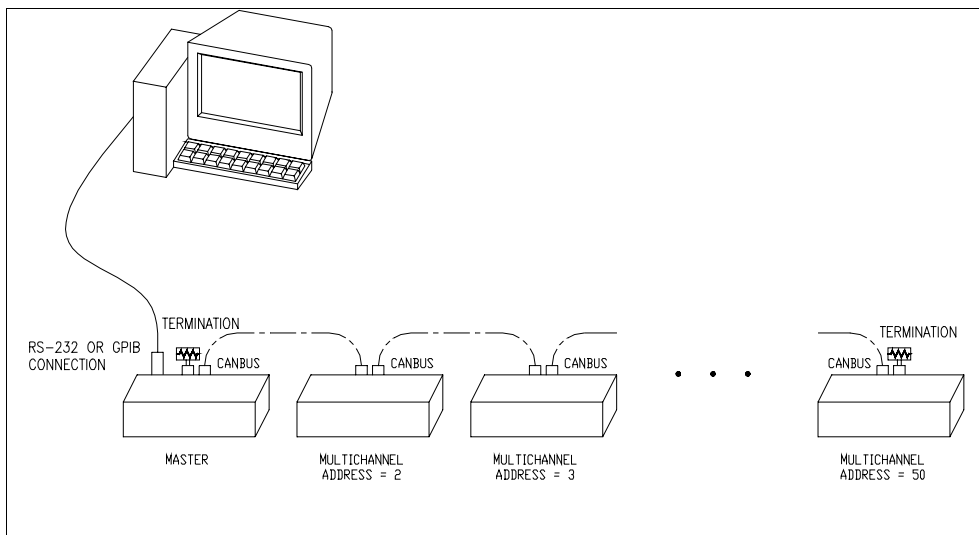

Figure 4.3 Connections for Multichannel Operation

Using Multichannel Operation

Once the power supplies have been configured and connected, you may power them on.

Power supplies controlled via multichannel have full capabilities, including changing REM/LCL modes and calibration.

Any power supply may send multichannel commands, if they are connected to a PC via RS-232 or GPIB.

A power supply will attempt to connect to the network:

- on power up, and
- when the multichannel address is changed.

Remote Operation

Multichannel Operation (6000 Watt only)

Note that slave units have an automatic readdressing capability when in multichannel mode. A slave unit will attempt another address when it is added to a string with an address that is already taken. If no new address can be found then the following error will be queued:

Error 1702, "Multichannel address taken" is queued if the power supply fails to connect.

SCPI Remote Control (RCONtrol) subregister will indicate the status of the connection. A power supply that has been disabled will not have any bits set. Use the SCPI command:

```
STAT:OPER:RCON:COND?
```

to query the condition of the multichannel interface.

See Table 4.13, "Remote CONTROL Sub-Register," on page 148 for a description of the bits in this register.

Multichannel Commands

To send a command to a multichannel power supply, attach the channel address to the command. If no channel number is specified, the command will be executed by the directly connected power supply.

For example, the command:

```
SOURCE12:VOLT 10.0
```

will set the power supply with address 12 to 10V output. The master receives the command and puts in on the CANbus.

Appendix B. "SCPI Command Reference" lists all commands.

[<channel>] indicates where the multichannel address is to be inserted into the command.

IEEE488.2 commands have been given an alias that is SCPI compliant if the command is applicable to a power supply in multichannel operation. These commands include *CLS, *IDN?, *OPT?, *RST, *TST?, *RCL, *SAV, *SDS, and *WAI. See Table B.9, "System Commands," on page 204.

Note The multichannel interface may not handle multiline response messages.

Multichannel Broadcast Commands Add a suffix of "0" to simultaneously broadcast the "command" to the master and all other units on the CANbus. Only commands are allowed, queries are not allowed. Note that there will be a lag in execution time between the local unit and all other units of up to a maximum of 20 ms. For example:

```
SOURCE0:VOLT 10.0
```

will set all units in a multichannel string to 10.0 V

Specifications

Max connected units	50
Max cable length	40 m
Bus speed	700 kbits/sec
Termination	120 ohm 1/4 W
Connections	parallel male DB9 to female DB9 cable
Addresses	1 to 50

Remote Operation

RS-232 Operation

RS-232 Operation











- RS-232 Connection** Use a standard null modem cable to connect the power supply to the host interface. The RS-232 port is a standard male DB9 connector. Table 4.6 describes the pin functions. Pins 1, 4, 6, and 9 are not used.

Table 4.6 RS-232 Pins





Pin #	Function
1	Not used
2	Receive
3	Transmit
4	Not used
5	Ground
6	Not used
7	Ready to Send (RTS)
8	Clear to Send (CTS)
9	Not used

Configuration Front Panel

First set the RS-232 parameters:

Step #	Do This	You Will See
1		ERROR MSGS
2	 5 times	REMOTE CONFIG
3		RS-232 Cfg
4		Baud 9600
5	 or  Select the baud rate.	Baud #####
6		Flow Ctl None
7	 or  Select the flow control option.	Options are None = no flow control Hdwr = CTS/DTS hardware handshake XON = software, XON/XOFF characters used
8		Settings are saved.

Next, select RS-232 as the remote control interface.

Step #	Do This	You Will See
1		ERROR MSGS
2	 4 times	REMOTE SELECT
3		RS-232
4		RS-232 setting is saved.

Press the LCL/RMT button to begin remote operation via the RS-232 interface.

SCPI

Set the band rate:

```
SYST:COMM:SER:BAUD {1200 | 2400 | 4800 | 9600 | 19200 | 38400}
```

Select flow control:

```
SYST:COMM:SER:PACE {HARD | XON | NONE}
```

Where

- HARD means hardware flow control
- XON means XON/XOFF characters are used
- NONE means no flow control

Select RS-232 to be the remote control source:

```
SYST:REM:SOUR RS232
```

Put the unit into remote operation:

```
SYST:REM:STAT REM
```

Using RS-232 Use any terminal emulation program to send commands to the power supply.

To change between remote and local modes, press the LCL/RMT button or the command:

```
SYST:REM:STAT {REM | LOC | RWL}
```

If you are in local mode, you may still communicate receive responses to queries, but you may not change any settings. Attempting to do so will cause Error -221, "Settings conflict".

Remote Operation

GPIB Operation

GPIB Operation

GPIB Connection The GPIB port is a special GPIB female connector. Table 4.7 describes the pin functions. Pin 12 is not used.









Table 4.7 GPIB Pins

Pin #	Function
1	D1
2	D2
3	D3
4	D4
5	EOI
6	DAV
7	NRFD
8	NDAC
9	IFC
10	SRQ
11	ATN
12	Not used
13	D5
14	D6
15	D7
16	D8
17	REN
18	Ground
19	Ground
20	Ground
21	Ground
22	Ground
23	Ground
24	Ground







Configuration Configure the power supply's GPIB address and power-on service request setting. The defaults are GPIB address 2 and power-on service request off.

Front panel

First set the GPIB parameters:

Step #	Do This	You Will See
1		ERROR MSGS
2	 5 times	REMOTE CONFIG
3		RS-232 Cfg
	 2 times	GPIB Cfg
4		GPIB Addr ##
5	Select an address from 1-30	GPIB Addr 2
6		PON SRQ? Y
7	 or  Select whether power-on service request is to be sent.	Options are Y (Yes) or N (No)
8		Settings are saved.

Next, select GPIB as the remote control interface.

Step #	Do This	You Will See
1		ERROR MSGS
2	 4 times	REMOTE SELECT
3		RS-232
4	 or  Select GPIB.	GPIB
5		GPIB setting is saved.

Remote Operation

GPIB Operation

SCPI

To set up GPIB control parameters:

```
SYST:COMM:GPIB:ADDR <GPIB-address>
```

where

- the GPIB address may be in the range 1 to 30.

To configure the unit to generate a power-on service request:

```
SYST:COMM:GPIB:PONS {ON | OFF}
```

To select GPIB as the remote control source:

```
SYST:REM:SOUR GPIB
```

Using GPIB Sending a GPIB command should put the power supply in remote mode with the **RMT** annunciator lit.

Refer to the manual for your GPIB interface card. Commands to change remote and local mode will be specific to that card.

Press the **LCL/RMT** button to return to local mode, except if the power supply is in LLO (local lockout) state.

SCPI Commands for Digital Interfaces

These SCPI commands are for use with GPIB, RS-232 and Multichannel remote digital interfaces.

Set Up Power ON Defaults For a complete list of commands and remote functionality, see Appendix B, “SCPI Command Reference”.

The Power On configuration can be set with one of 4 options:

- **Factory Preset:** The output is reset to the original factory levels at power on.
- **Last Setting:** The output is set to the same levels as when it was last powered OFF.
- **User Settings:** The output is set to a stored setting that is recalled from memory. See “Store User Settings” on page 77.
- **Auto Sequence:** The output is controlled by a program that is recalled from memory. See “Auto Sequencing” on page 136.

All these options can be accessed from the Front Panel menus, or remotely through a set of digital commands. The instructions that follow show how to work remotely through SCPI commands.

Refer to Table 3.1, “Settings Affected by Recall,” on page 81 for more details.

Factory Preset

Selecting **Factory Preset** lets you restore the factory defaults the next time the power supply is powered ON.

To power on factory settings:

```
OUTP:PON:REC PRES
```

To check the current user setting:

```
OUTP:PON:REC?
```

The response should be PRES, which stands for PRESet.

Remote Operation

SCPI Commands for Digital Interfaces

Last Setting

Selecting **Last Setting** lets you restore the settings that are in use when the power supply is powered off, the next time it is powered on.

To power on the last stored setting:

```
OUTP:PON:REC LAST
```

To check the current user setting:

```
OUTP:PON:REC?
```

The response should be LAST.

User Setting

Selecting **User Setting** lets you restore a custom setting next time the unit is powered on. This assumes that at least one user setting has been set up and stored in memory. See “Store User Settings” on page 77.

To power on user setting #1:

```
OUTP:PON:REC USER1
```

To check the setting:

```
OUTP:PON:REC?
```

The response should be USER1.

The user setting must be in the range of 1–10. See “Store User Settings” on page 127 for an explanation of how to save user settings.

Auto Sequence

Selecting **Auto Sequence** lets you recall a stored program next time the unit is powered ON. This assumes that at least one program has been created and stored in memory. See “Editing Trigger Source of a Sequence” on page 96 for more information. See for information about remotely programming and running auto sequence programs.

To reset to user setting #1:

```
OUTP:PON:REC SEQ1
```

To check the setting:

```
OUTP:PON:REC?
```

The response should be SEQ1.

Power On Output State You may also change the output state whether the output is enabled or disabled at power on.

To change the power on at output state:

OUTP:PON:STAT [ON|OFF|1|0]

To check the setting:

OUTP:PON:STAT?

Reset

Resetting the unit puts certain features to a known state. These states are listed in the table below.

To reset the unit:

*RST or SYST:RES

Remote Operation

SCPI Commands for Digital Interfaces

Table 4.8 Features Affected by Reset (*RST) Command

Feature	Reset State (*RST)
Voltage setpoint	0.0V
Current setpoint	0.0A
Power setpoint	103% of power rating
Low voltage setpoint limit	0.0V
High voltage setpoint limit	103% of voltage rating
Low current setpoint limit	0.0A
High current setpoint limit	103% of current rating
Low power setpoint	3% of power rating
High power setpoint	103% of power rating
Over voltage protection	Disabled (0.0V)
Under voltage protection	Disabled (0.0V) and not shutdown when tripped
Over current protection	Disabled (0.0A) and not shutdown when tripped
Under current protection	Disabled (0.0A) and not shutdown when tripped
Over power protection	Disabled (0.0W) and not shutdown when tripped
Under power protection	Disabled (0.0W) and not shutdown when tripped
Fold shutdown protection	None and delay 0.5s
AC off shutdown recovery	Autorecover
Over temperature shutdown recovery	Latched
Triggered voltage setpoint	Disabled (Default)
Triggered current setpoint	Disabled (Default)
Triggered power setpoint	Disabled (Default)
Autosequence mode	Exit
Front panel display config	Show V & I
Knob lockout	None
Calibration mode	False
Output	Disabled

Store User Settings If you have a frequent or constant need for a specific voltage and current output, you can save these setpoints in the power supply's memory as a user setting. Once a setting is stored, it remains in the power supply's memory after the unit is powered off.

See "Store User Settings" on page 77 for a list of parameters that are saved.

To store (save) settings:

*SAV <user-setting>

Example:

*SAV 1 will save all the present settings to user setting location 1.

To recall settings:

*RCL <user-setting>

To save default settings:

*SDS <user-setting>

This will save factory default settings to a user setting location, replacing any setting that was previously saved there.

Example:

To save settings, set up the power supply with all required settings (we recommend that you do this right after recalling the factory default settings).

For example, you can set voltage, current, and all protection levels.

Then to save the settings to Location 1: issue the command *SAV 1

When you want to recall the settings, issue the command *RCL 1. If you want to recall them at the next power on, issue the command `OUTP:PON:REC USER1`

To recall last settings:

If you wish to recall the settings present when the supply was last powered off, send the command:

`SYST:REC:LAST`

Remote Operation

SCPI Commands for Digital Interfaces

Change Remote/Local Control of Power Supply A SCPI command is provided for use with the RS-232 and multichannel interfaces to change the remote/local mode. (GPIB will use IEEE 4888-1 functions to change modes.)

```
SYST:REM:STAT {LOC|REM|RWL}
```

Where:

- LOC: go to local mode operation
- REM: go to remote mode operation
- RWL: remote with local lockout. Go to remote mode operation with local mode locked out. With RWL set, the user cannot return to local mode via the front panel.

To query to remote mode:

```
SYST:REM:STAT?
```

Enable Output **To enable or disable the output:**

```
OUTP {ON|OFF}
```

To query the state of the output enable:

```
OUTP?
```

Program V,I,P SCPI

To change setpoints:

```
SOUR:VOLT <voltage>
```

```
SOUR:CURR <current>
```

```
SOUR:POW <power>
```

To check setpoints:

```
SOUR:VOLT?
```

```
SOUR:CURR?
```

```
SOUR:POW?
```

To set a triggered setpoint:

```
SOUR:VOLT:TRIG <voltage>
```

```
SOUR:CURR:TRIG <current>
```

```
SOUR:POW:TRIG <power>
```

See “Triggering Commands” on page 136 for more information.

To check a triggered setpoint:

```
SOUR:VOLT:TRIG?  
SOUR:CURR:TRIG?  
SOUR:POW:TRIG?
```

To set limits:

```
SOUR:VOLT:LIM:HIGH <voltage>  
SOUR:VOLT:LIM:LOW <voltage>  
SOUR:CURR:LIM:HIGH <current>  
SOUR:CURR:LIM:LOW <current>  
SOUR:POW:LIM:HIGH <power>  
SOUR:POW:LIM:LOW <power>
```

If the high end of the range was set to 5 volts, the command, SOUR:VOLT 10 would return an error.

To check ranges:

```
SOUR:VOLT:LIM:HIGH?  
SOUR:VOLT:LIM:LOW?  
SOUR:CURR:LIM:HIGH?  
SOUR:CURR:LIM:LOW?  
SOUR:POW:LIM:HIGH?  
SOUR:POW:LIM:LOW?
```

Example:

To set voltage to 5.5V and current limit to 100A, send the command:

```
:VOLT 5.5; :CURR 100
```

Then check the output:

```
MEAS:VOLT? 5.500 (example readback, default unit V)
```

```
MEAS:CURR? 0.010 (example readback, default unit A)
```

```
MEAS:POW? 0.005 (example readback, default unit W)
```

Remote Operation

SCPI Commands for Digital Interfaces

Configure V, I, P Protection Limits

Over-Voltage Protection

To set the Over-Voltage Protection level:

```
SOUR:VOLT:PROT <voltage>
```

To check the Over-Voltage Protection level:

```
SOUR:VOLT:PROT?
```

To check if the Over-Voltage Protection was tripped:

```
SOUR:VOLT:PROT TRIP?
```

Alternatively, you can query the status registers. See Appendix B.

Under-Voltage Protection

To set the Under-Voltage Protection level:

```
SOUR:VOLT:PROT:UND <voltage>
```

```
SOUR:VOLT:PROT:UND:STAT <on-off-state>
```

The first UVP protection command sets the protection level. The second command lets you choose a warning alarm only [OFF] or shut down with an alarm [ON] if the protection level is exceeded.

To check the Under-Voltage Protection level:

```
SOUR:VOLT:PROT:UND?
```

To check if the Under-Voltage Protection was tripped:

```
SOUR:VOLT:PROT:UND:TRIP?
```

Alternatively, you can query the status register. See Appendix B, “SCPI Command Reference”.

Over-Current Protection

To set the Over-Current Protection level:

```
SOUR:CURR:PROT <current>
```

```
SOUR:CURR:PROT:STAT <on-off-state>
```

The first OCP protection command sets the protection level. The second command lets you choose a warning alarm only [OFF] or shut down with an alarm [ON] if the protection level is exceeded.

To check the Over-Current Protection level:

```
SOUR:CURR:PROT?
```

To check if the Over-Current Protection was tripped:

```
SOUR:CURR:PROT:TRIP?
```

Under-Current Protection

To set the Under-Current Protection level:

```
SOUR:CURR:PROT:UND <current>  
SOUR:CURR:PROT:UND:STAT <on-off-state>
```

The first UCP protection command sets the protection level. The second command lets you choose a warning alarm only [OFF] or shut down with an alarm [ON] if the protection level is exceeded.

To check the Under-Current Protection level:

```
SOUR:CURR:PROT?
```

To check if the Under-Current Protection was tripped:

```
SOUR:CURR:PROT:TRIP?
```

Over-Power Protection

To set the Over-Power Protection level:

```
SOUR:POW:PROT <wattage>  
SOUR:POW:PROT:STAT <on-off-state>
```

The first OPP protection command sets the protection level. The second command lets you choose a warning alarm only [OFF] or shut down with an alarm [ON] if the protection level is exceeded.

To check the Over-Power Protection level:

```
SOUR:POW:PROT?
```

To check if the Over-Power Protection was tripped:

```
SOUR:POW:PROT:TRIP?
```

Under-Power Protection

To set the Under-Power Protection level:

```
SOUR:POW:PROT:UND <wattage>  
SOUR:POW:PROT:UND:STAT <on-off-state>
```

The first UPP protection command sets the protection level. The second command lets you choose a warning alarm only [OFF] or shut down with an alarm [ON] if the protection level is exceeded.

To check the Under-Power Protection level:

```
SOUR:POW:PROT?
```

To check if the Under-Power Protection was tripped:

```
SOUR:POW:PROT:TRIP?
```

Remote Operation

SCPI Commands for Digital Interfaces

Configure Other Protection Mechanisms

Fold Protection

Fold protection causes the supply to shut down if the selected regulation mode is entered. A delay time may be specified as well.

To set the fold mode:

```
OUTP:PROT:FOLD {CC|CV|CP|NONE}
```

Where:

NONE indicates fold protection is disabled.

CC indicates the supply will shut down due to constant current condition.

CV indicates the supply will shut down due to constant voltage.

CP indicates the supply will shut down due to constant power.

The default value is NONE.

To set the fold delay:

```
OUTP:PROT:FOLD:DEL <delay_time>
```

Where:

<delay_time> is a value in the range of 0–60 seconds.

Units may be specified as “ms” (milliseconds) “s” (seconds), or “min” (minutes). If no units are specified, the default seconds are assumed. (Increments of 0.1s are allowed.) The default value is 0.5 second.

Over Temperature Protection

The user has the option of setting whether the over temperature protection (OTP) mechanism is latched or automatically resumes operation. (The trip levels are internally set and cannot be changed by the user.)

```
SENSE:TEMP:PROT:LATCH {ON|1|OFF|0}
```

Where:

ON or 1 means the supply will be latched in shutdown if OTP is tripped, until the user clears the alarm and re-enables the output.

and

OFF or 0 means the supply will automatically resume operation when the temperature drops to below the trip level.

The default value is ON.

To query if OTP has tripped:

```
SENSE:TEMP:PROT:TRIP?
```

AC Off Protection

The user has the option of setting whether the AC Off protection mechanism is latched or automatically resumes operation.

```
SENSE:VOLT:AC:PROT:LATCH {ON|1|OFF|0}
```

Where:

ON or 1 means the supply will be latched in shut down if an AC Off condition occurs, until the user re-enables the output.

and

OFF or 0 means the supply will automatically resume operation when the AC line input returns to normal.

The default value is OFF.

To query if AC Off has tripped:

```
SENSE:VOLT:AC:PROT:TRIP?
```

Remote Operation

SCPI Commands for Digital Interfaces

Clear Protection Event **To clear a protection mechanism that has tripped:**
OUTP:PROT:CLE

This will clear all protection mechanisms and re-enable the output. If the condition that caused the alarm still exists, the protection will be allowed to trip again.

View Power Supply Output The following 3 commands query the voltage, current, or power being supplied at the output terminals.

To measure the voltage output:

MEAS:VOLT?

To measure the current output:

MEAS:CURR?

To measure the power output:

MEAS:POW?

Configure Auxiliary Status Lines **To set up Auxiliary line A:**
OUTP:AUXA:SOUR <aux-line-mnemonic>

The choices for <aux-line-mnemonic> include:

- **NONE**
- **ON:** Output On
- **OFF:** Output Off
- **OVOL:** Over-Voltage Condition
- **UVOL:** Under-Voltage Condition
- **OCUR:** Over-Current Condition
- **UCUR:** Under-Current Condition
- **OPOW:** Over-Power Condition
- **UPOW:** Under-Power Condition
- **ACOF:** AC Power had been turned off or failed
- **OTEM:** Over-Temperature Condition
- **HTEM:** High-Temperature Condition
- **SPR:** Sense Protection Tripped
- **FOLD:** Fold Protection Tripped
- **CC:** Constant Current Mode
- **CV:** Constant Voltage Mode
- **CP:** Constant Power Mode
- **UNR:** Output Unregulated

To check the setting:

OUTP:AUXA:SOUR?

To set up Auxiliary line B:

OUTP:AUXB:SOUR <aux-line-mnemonic>

To set the polarity of the auxiliary status lines:

OUTP:AUXA:POL {HIGH|LOW}

OUTP:AUXB:POL {HIGH|LOW}

Where:

HIGH means that the logic of the output is active high. (That is, if the condition is true, the line is pulled high.)

LOW means the logic of the output is active low.

The user can select polarity for either of the auxiliary lines.

To check the state of the line:

OUTP:AUXA:STAT?

This command returns a 1 or 0. If it returns a 1, this means that the status selected as the auxiliary line mnemonic is true.

Read Error Messages **To read from the error queue:**

SYST:ERR?

This command returns an error code and message from the error queue. For example:

- -315, "Configuration memory test"
- -100, "Command error"
- 0, "No error"

The queue can store up to 50 error messages. See Appendix C, "Error Messages" for descriptions of the messages.

Remote Operation

SCPI Commands for Digital Interfaces

Triggering Commands Triggers are event-driven signals that instruct power supplies to change their output. Triggering provides a method to control changes in the power supply's output and to program several power supplies to react at the same time. Triggering is useful in manufacturing processes where power requirements change as the machinery performs different operations.



CAUTION

Setpoint limits do not apply to triggered setpoints.

To program triggers:

1. Configure the desired output levels as a result of a trigger.

```
VOLTage:TRIGgered {<voltage>|MAX|MIN|DEF}  
CURRent:TRIGgered {<current>|MAX|MIN|DEF}  
POWER:TRIGgered {<power>|MAX|MIN|DEF}
```

The user can choose to set all or any one of voltage, current, and power triggered levels.

DEF (Default) means that when a trigger is received, no change will occur.

2. Specify a trigger signal source.

```
TRIGger:SOURce {BUS|EXT|IMM|NONE} Where:
```

- BUS means the trigger source is the IEEE 488.1 GET or “*TRG”
- EXT means the source is the external trigger line
- IMM means the trigger source is the SCPI command INIT:IMM
- NONE means triggering is disabled. See , p. 109.

Auto Sequencing Auto Sequencing allows users to program a sequence of steps. Each step has the properties of voltage, current, power limits, and OVP limit. The steps are either programmed to run for a predetermined length of time or are programmed to pause and wait for a trigger.



CAUTION

Setpoint limits do not apply to auto sequence programmed setpoints.

Programmed sequences can run one time only, or repeatedly up to 9999 times or infinitely. You can store up to 10 sequences of 99 steps each. The duration of each step may range from a minimum of 10 milliseconds to a maximum of 99 hours.

Operation

Users can select and start a sequence, and while the sequence is running, pause or end it. Users can press and hold the **TRIGGER** button to skip over steps that have a set duration.

Commands are also available to let users run, pause, resume, and restart an autosequence. A pause, or wait for trigger, causes the power supply to hold the output at the programmed level until the appropriate signal to continue is received.

Editing

Users can delete single steps or entire sequences. If a step is deleted, the subsequent steps will shift up. If a new step is inserted, the subsequent steps will shift down.

Remote programming of auto sequences has the same functionality as using the front panel.

Remote Operation

SCPI Commands for Digital Interfaces

Programming Sequences **Select Sequence to Program**

```
PROG:NAME <sequence_number>
```

<sequence_number> is a number between 1 and 10 that corresponds to the number of the sequence.

Define the name of the program to be selected. If <sequence_number> already exists, then that existing program is selected. If the program name does not exist, then the new name is selected, but no program is defined by this selection.

Editing the Sequence

To edit an existing step or to program new steps, use the following commands:

```
PROG:STEP<step_number>[:EDIT] [[[[<voltage>]  
,<current>],<power>],<OVP_level>],{<time>|TRIG}]
```

Any of the step parameters may be omitted, in which case the default parameters will be used. The defaults are 0 V, 0 A, 0 W, 0 V, 10 ms.

To insert a step between commands in an existing program, use this command:

```
PROG:STEP<step_number>:INS <voltage>  
,<current>,<power>,<OVP_level>,{<time>|TRIG}
```

The step number is where the inserted step is to be located. The existing step and all following steps at that location are moved down.

In both the edit and insert commands:

- <step_number> ranges from 1 to 99.
- <time> defines the duration of the step and must be entered in the format milliseconds. It ranges from 10ms to 99 hours.
- TRIG may be entered instead of a step duration. In this case, the unit will hold the output levels at that step until a trigger signal is supplied.

Setting Sequence Repetitions

```
PROG:REP {ONCE |<sequence_count>|FOR|INF}
```

- ONCE will run the sequence once and return it to its STOP condition.
- <sequence_count> ranges from 1 to 9999. It will run the sequence the number of times specified before putting it into the STOP condition.
- FOREver and INFInity cause the sequence to repeat forever. A query will return 9.9E37, representing INFInity.

Selecting a Trigger Source

If any triggers are programmed into the sequence, select a trigger source:

```
PROG:TRIG:SOUR {BUS|MAN|EXT|IMM}
```

- **BUS** - trigger signal is IEEE 488.1 GET or *TRG
- **MANual** - trigger input is from the front panel TRIGGER key
- **EXTernal** - The external trigger line is selected as the source.
- **IMMediate** - The source is the SCPI command “INIT:IMM”

Editing Step Parameters

Commands are provided to edit only one of voltage, current, power, OVP level, step duration, or end action.

- **Program step voltage:** `PROG:STEP<step_number>:VOLT <voltage>`
- **Program step current:** `PROG:STEP<step_number>:CURR <current>`
- **Program step power:** `PROG:STEP<step_number>:POW <power>`
- **Program step OVP level:** `PROG:STEP<step_number>:OVP <OVLevel>`
- **Program step time (duration):** `PROG:STEP<step_number>:DWEL {<time>|TRIG}`

To delete a step:

```
PROG:STEP<step_number>:DELeTe
```

An error will result if the last step with the end action is deleted, without a new end action programmed to take its place.

Deleting Sequences

If you no longer need a sequence, select it with the `PROG:NAME` command and then delete it with the following:

```
PROG:DELeTe
```

You can also use the following to delete all sequences:

```
PROG:DELeTe:ALL
```

Remote Operation

SCPI Commands for Digital Interfaces

Auto Sequence Operation **Select Sequence to Run**

PROG:NAME <sequence_number>

where <sequence_number> can range from 1 to 10.

Operation

Running

PROG:STATe [RUN|PAUSE|STOP]

- Once the programmed sequence has been selected, you can start it by setting the state to RUN, by sending the command `PROG:STAT RUN`.
- At any time you can pause the sequence by sending `PROG:STAT PAUS`. A paused sequence will cause the supply to hold the output levels at the setpoints programmed by the current step. To resume, set the state to RUN again.
- To end the sequence operation, send the command `PROG:STAT STOP`. Sending RUN will restart the auto sequence program from the first step.
- You can query the state of the selected auto sequence program with `PROG:STAT?`

Trigger

If the auto sequence was programmed to wait for a trigger, the power supply holds the output levels at the programmed setpoints until a trigger is received. It then advances to the next step. A trigger must come from the selected trigger source.

Skipping a Step

PROG:STEP:NEXT

Querying Operation

PROG:STEP:EXEC?

You can query the step number that is currently operating.

Slew Rate The slew rate is calculated as a function of change in the output voltage and a given time interval. The maximum slew rate is 1% V rating/150us. The slew rate is saved upon power off and restored at power on. Output ON/OFF and shutdown are not affected by the programmable slew rate. These functions have a slew rate of 1%/20ms. For more information on setting slew rates, see “Slew Rate” on page 102.

The SCPI commands for changing the voltage slew rate are:

`:VOLT:SLEW:STEP {<slewrates-voltage> | MAX | MIN | DEF}`

where voltage-step has the units V, mV, etc.

and the range is 0.1% to 5% of rated voltage.

default step is 0.1% of rated output voltage.

`:VOLT:SLEW:INTerval {<slewrates-interval> | MAX | MIN | DEF}`

where time interval has the units s, ms, or us

and the range is 150 us to 1.5s

default interval is 150us.



CAUTION

Check both the voltage step and the interval to ensure you get the required slew rate.

The combination must not exceed 1% V rating/150us. Though the software will attempt to achieve higher slew rates, it is limited to this value by hardware constraints. Manufacturer's recommendation is to keep the slew rate at or below the default value.

Example:

Set a slew rate of 100V/10s for a 100V-60A power supply.

This slew rate is 1V/0.1s, which is within the acceptable range.

Send the commands:

`" :VOLT:SLEW:STEP 1 ", and`

`" :VOLT:SLEW:INT 100ms "`

Remote Operation

SCPI Commands for Digital Interfaces

Identification Query The identification query command returns a string that states the manufacturer, model, serial number, and firmware revision.

*IDN?

may return "Xantrex, XDC 60-100, 100000, 3.000/0/0/0000.

Option Identification Query

*OPT?

or

SYST[<channel>]:OPTion?

The option identification query returns a string listing any reportable options that are installed in the power supply. Reportable options are GPIB and CANbus, but may include others in the future. A zero will be returned if no options are installed.

Example:

*OPT? may return "GPIB, CANBUS" to indicate that both the GPIB and CANbus (Multichannel/Current Share) options are installed.

SCPI Version Query

SYST:VERS?

will return the SCPI version to which the unit complies (for example 1997-0).

Status Registers The Status Register structure is mandatory for SCPI and IEEE 488.2 compliance. The register bits are defined by the SCPI and IEEE 488.2 standards.

Each status register has a Condition, Event, and Enable register and transition filters. See "Status Register Commands" on page 157 for commands to read or change their values.

Condition Register

Transitions of the condition register are automatic and reflect the condition of the instrument at the moment. Reading a condition register has no effect on the contents.

Event Register

The event register bits are set automatically to correspond with changes in the condition register. The rules are dependent on the positive and negative transition registers. Reading an event register clears it. The *CLS command clears all event registers.

Enable Register

The enable register enables reporting of the event bits to the summary bit or the status byte. The contents of the enable register are unchanged by *CLS and *RST.

Transition Filters

A positive transition filter allows an event to be reported when a condition changes from false to true. Setting both positive and negative filters to TRUE allows an event to be reported any time the condition changes. Clearing both filters disables event reporting.

The contents of transition filters are unchanged by *CLS and *RST.

The status registers may be divided into 4 categories, the operation status registers, the questionable status registers, the standard event status register and the status byte.

OPERation Status Register

The operation status register is a 16-bit register which contains information about conditions which are part of the power supply's normal operation.

The Operation Status data structure has the operation status register and 5 sub-registers to represent regulation, shutdown, protection shutdown, remote control, and current sharing modes. Each of the sub-registers is summarized in a summary bit.

Figure represents the Operation Status data structure. The “+” represents the logical summation of bits in a register. Table 4.9, Table 4.10, Table 4.11, Table 4.13, and Table 4.14 describe the meanings of each bit as well as the bit number and bit weight.

Remote Operation

SCPI Commands for Digital Interfaces

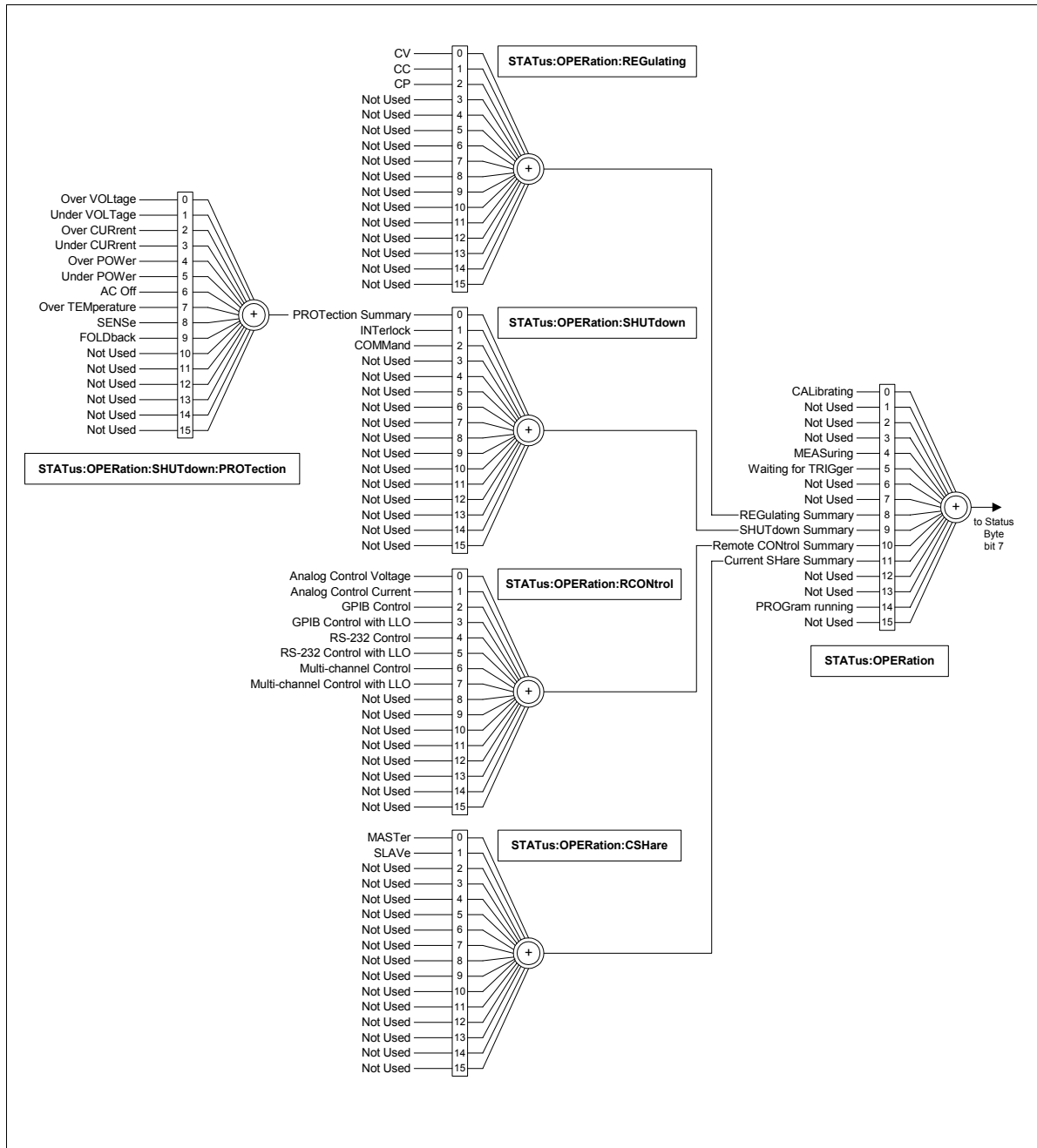

Figure 4.4 Operation Status Registers

Table 4.9 OPERation Status Register

Bit	Bit Weight	Bit Name	Description
0	1	CALibrating	Indicates that the supply is in CALibration Mode.
1	2	SETTLing	Not implemented
2	4	RANGing	Not implemented
3	8	SWEeping	Not implemented
4	16	MEASuring	Not implemented
5	32	Waiting for TRIGger Summary	Indicates if the supply is waiting for a TRIGger.
6	64	Waiting for ARM Summary	Not implemented
7	128	CORRECTing	Not implemented
8	256	REGulating Summary	Reflects the summary of the REGulating Sub-Register.
9	512	SHUTdown Summary	Reflects the summary of the SHUTdown Sub-Register.
10	1024	Remote CONtrol Summary	Reflects the summary of the Remote CONtrol Sub-Register.
11	2048	Current SHareSummary	Reflects the summary of the Current Share Sub-Register.
12	4096	Not Used	Not used
13	8192	INSTrument Summary	Not implemented
14	16384	PROGram Running	Indicates that an Automated Sequence is running.
15	32768	Not Used	Not used

Remote Operation

SCPI Commands for Digital Interfaces

REGulating Sub-Register

This describes the regulating mode. If none of these bits is active, the output unregulated (UNRegulated) bit is active in the questionable status register.

Table 4.10 REGulating Sub-Register

Bit	Bit Weight	Bit Name	Description
0	1	CV	The power supply is regulating in Constant Voltage mode.
1	2	CC	The power supply is regulating in Constant Current mode.
2	4	CP	The power supply is regulating in Constant Power mode.

SHUTdown Sub-Register

Describes the cause of the power supply shutting down. More than one bit may be active, and multiple actions will be required to restart the unit. The protection shutdown sub-register indicates which protection mechanisms have caused the power supply to shutdown.

Table 4.11 SHUTdown Sub-Register

Bit	Bit Weight	Bit Name	Description
0	1	PROTECTio n Summary	The power supply is shut down by a power supply protection mechanism.
1	2	INTerlock	The power supply is shut down by INTERlock signal.
2	4	COMMand	The power supply is shut down by a command.

Protection SHUTdown Sub-Register

Table 4.12 Protection SHUTdown Sub-Register

Bit	Bit Weight	Bit Name	Description
0	1	Over VOLTage	Over voltage protection has tripped
1	2	Under VOLTage	Under voltage protection has tripped
2	4	Over CURrent	Over current protection has tripped
3	8	Under CURrent	Under current protection has tripped
4	16	Over POWer	Over power protection has tripped
5	32	Under POWer	Under power protection has tripped
6	64	AC Off	AC Off protection has tripped
7	128	Over TEMPerature	Over temperature protection has tripped
8	256	SENSe	Sense protection has tripped
9	512	FOLDback	Foldback protection has tripped

Remote CONTROL Sub-Register

This identifies which remote interface is controlling the unit. Only one bit is active at a time with the exception of analog control, where voltage or current alone, or both may be under remote control. Current share mode is considered to be under local control, even though the user cannot adjust the voltage setting from the front panel.

Remote Operation

SCPI Commands for Digital Interfaces

Table 4.13 Remote CONtRol Sub-Register

Bit	Bit Weight	Bit Name	Description
0	1	Analog Control Voltage	The Voltage Setpoint is under control of the Analog Programming Interface.
1	2	Analog Control Current	The Current Setpoint is under control of the Analog Programming interface.
2	4	GPIB CONtRol	The power supply is under Remote CONtRol via the GPIB interface.
3	8	GPIB CONtRol with LLO	The power supply is under Remote Control via the GPIB interface, with local controls locked out.
4	16	RS-232 CONtRol	The power supply is under Remote CONtRol via the RS-232 interface.
5	32	RS-232 Control with LLO	The power supply is under Remote CONtRol via the RS-232 interface, with local controls locked out.
6	64	Multi-channel CONtRol	The power supply is under Remote CONtRol via the Multi-channel Programming interface.
7	128	Multi-channel Control with LLO	The power supply is under Remote CONtRol via the Multi-channel Programming interface, with local controls locked out.

Current SHare Sub-Register

This register shows the state of the current share configuration, which can either be set through the front panel Current Share Config menu, or through the SCPI command `SOURce:COMBine:CSHare:MODE`.

Table 4.14 Current SHare Sub-Register

Bit	Bit Weight	Bit Name	Description
0	1	MASTer	The power supply is configured to be a Current Share Master.
1	2	SLAVe	The power supply is configured to be a Current Share Slave.

QUEStionable Status Register

The Questionable Status Register is a 16-bit register that stores information about questionable events or status during power supply operation. That is, bits in these registers may indicate that the output of the supply is of undesirable or questionable quality.

The Questionable Status data structure consists of a questionable status register and 4 sub-registers representing the status of the voltage, current, power outputs and temperature.

Figure gives an overview of the Questionable Status data structure. The “+” represents the logical summation of bits in a register. Table 4.15, Table 4.16, Table 4.17, Table 4.18, and Table 4.19, describe the meanings of each bit as well as the bit number and bit weight.

Remote Operation

SCPI Commands for Digital Interfaces

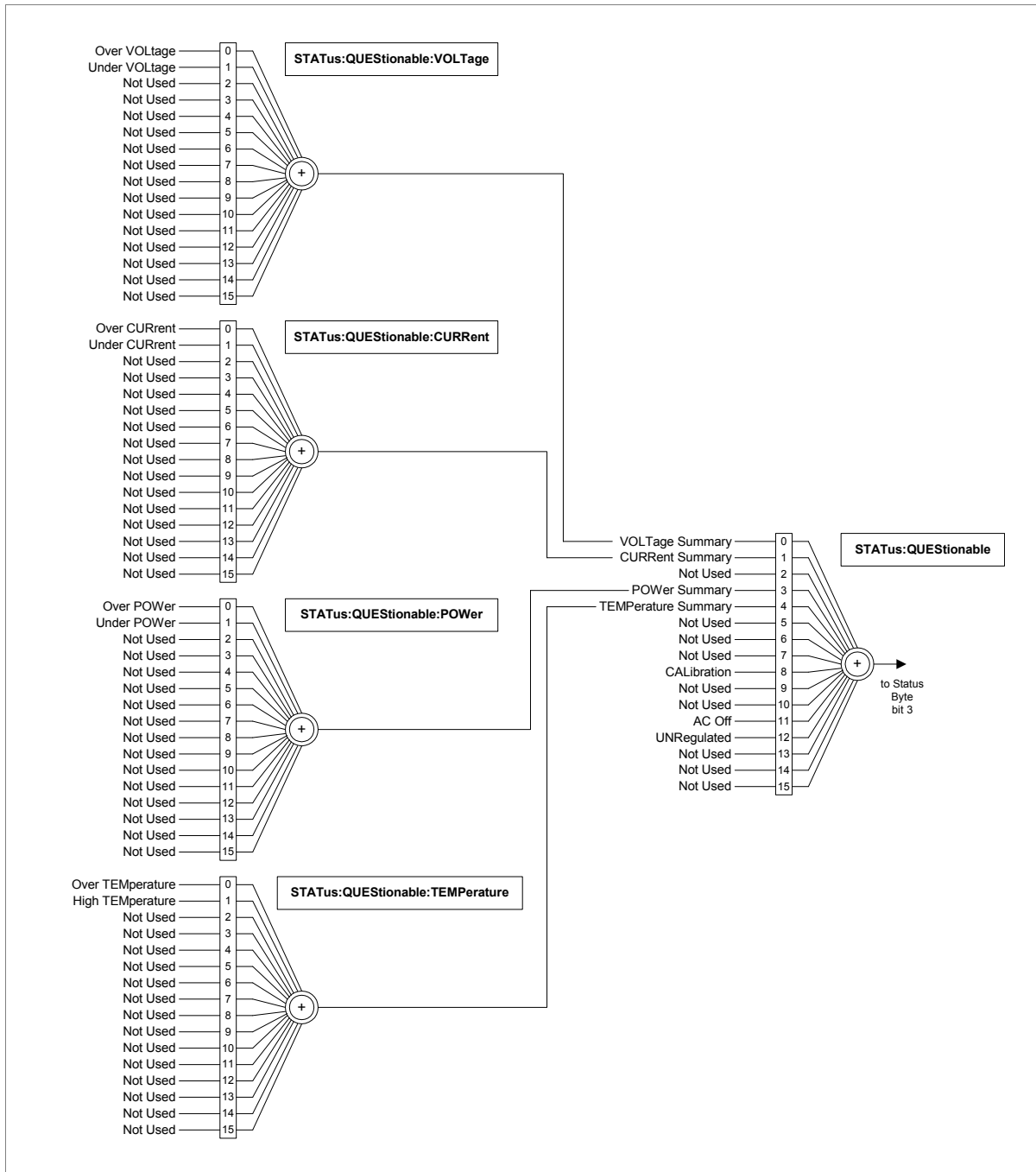

Figure 4.5 Questionable Status Registers

Table 4.15 QUEStionable Status Register

Bit	Bit Weight	Bit Name	Description
0	1	VOLTage Summary	Reflects a summary of the VOLTage Sub-Register.
1	2	CURRent Summary	Reflects a summary of the CURRent Sub-Register.
2	4	TIME	Not implemented
3	8	POWer Summary	Reflects a summary of the POWer Sub-Register.
4	16	TEMPerature Summary	Reflects a summary of the TEMPerature Sub-Register.
5	32	FREQUency Summary	Not implemented
6	64	PHASe Summary	Not implemented
7	128	MODulation Summary	Not implemented
8	256	CALibration	Indicates an error in the unit calibration.
9	512	Not Used	Not implemented
10	1024	Not Used	Not implemented
11	2048	AC Off	Indicates an AC Supply failure.
12	4096	UNRegulated	Indicates that the output is not regulated in either Constant Voltage mode, Constant Current mode or Constant Power mode. Reflects the inverse of the Operation Regulation Summary bit.
13	8192	INSTrument Summary	Not implemented
14	16384	Command Warning	Not implemented
15	32768	Not Used	Always zero

Remote Operation

SCPI Commands for Digital Interfaces

VOLTage Sub-Register

This shows whether the present voltage level is over or under the specified trip limit.

Table 4.16 VOLTage Sub-Register

Bit	Bit Weight	Bit Name	Description
0	1	Over VOLTage	Set if the supply's output voltage exceeds the over-voltage trip level, either user-specified variable trip limit, or the fixed trip limit.
1	2	Under VOLTage	Set if the supply's output voltage is less than the user-specified under-voltage trip level (variable trip limit) and the supply is in Operation state.

CURRent Sub-Register

This shows whether the present current level is over or under the specified trip limit.

Table 4.17 CURRent Sub-Register

Bit	Bit Weight	Bit Name	Description
0	1	Over CURrent	Set if the supply's output current is greater than the user-specified over-current trip level (variable trip limit) and the supply is in Operation state.
1	2	Under CURrent	Set if the supply's output current is less than the user-specified under current trip level (variable trip limit) and the supply is in Operation state.

POWER Sub-Register

This shows whether the present power level is over or under the specified trip limit.

Table 4.18 POWER Sub-Register

Bit	Bit Weight	Bit Name	Description
0	1	Over POWER	Set if the supply's output power is greater than the user-specified over-power trip level (variable trip limit), and the supply is in Operation state.
1	2	Under POWER	Set if the supply's output power is less than the user-specified under-power trip level (variable trip limit), and the supply is in Operation state.

TEMPerature Sub-Register

This shows whether the temperature of critical components is near or over the maximum operating temperature.

Table 4.19 TEMPerature Sub-Register

Bit	Bit Weight	Bit Name	Description
0	1	Over TEMperature	Set if the power supply temperature exceeds the maximum operating temperature.
1	2	High TEMperature	Set if the power supply temperature exceeds 90% of the maximum operating temperature.

Standard Event Status Register

The standard event status register sets bits for specific events during power supply operation. All bits in the standard event status registers are set through the error event queue. The register is defined by 488.2 and is controlled using 488.2 common commands, *ESE, *ESE?, and *ESR?.

Figure 4.6 summarizes the standard Event Status Register

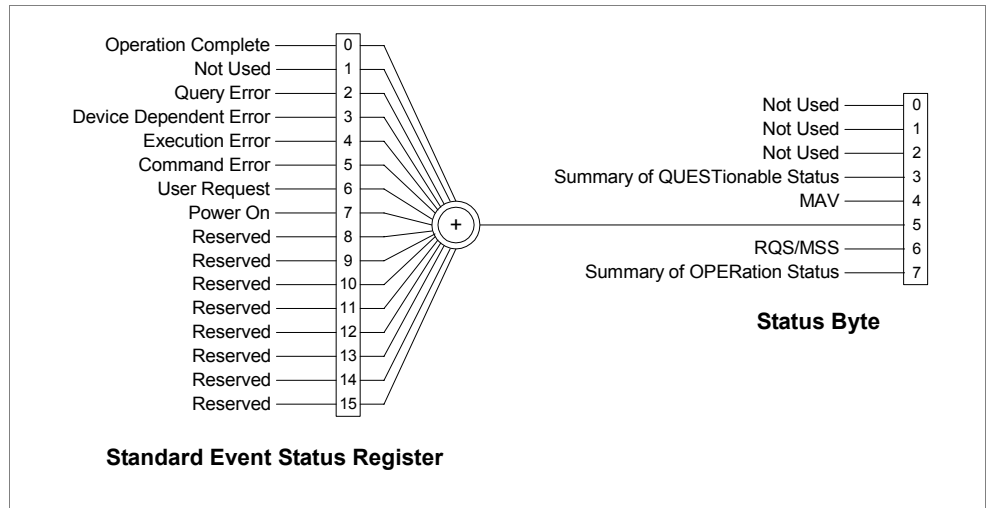

Figure 4.6 IEEE 488.2 Status Register and Status Byte

Remote Operation

SCPI Commands for Digital Interfaces

Table 4.20 Standard Event Status Register

Bit	Bit Weight	Bit Name	Description
0	1	Operation Complete (OPC)	Set if KOPC command has been received and all pending operations have been completed. The message, Event –800 Operation Complete, is loaded into the Error/Event Queue.
1	2	Request Control (RQC)	Not implemented. Always set to 0.
2	4	Query Error (QYE)	Set if an attempt is being made to read data from the output queue when no output is either present or pending. Suggests that data in the output queue has been lost. See “Query Error List” on page 219 for possible error codes.
3	8	Device Dependent Error (DDE)	Set if there is a device-specific error. See “Device-Specific Error List” on page 218 for possible error codes.
4	16	Execution Error (EXE)	Set if a program data element, following a header, was evaluated by the power supply as outside of its legal input range, or is otherwise inconsistent with the power supply’s capabilities. Suggests that a valid program message could not be properly executed due to some power supply condition. See “Execution Error List” on page 216 for possible error codes.
5	32	Command Error (CME)	Set if an IEEE488.2 syntax error has been detected by the parser, an unrecognized header was received, or a group Execute Trigger was entered into the input buffer inside an IEEE 488.2 program message. See “Command Error List” on page 216 for possible error codes.
6	64	User Request (URQ)	Set if the bit is unmasked and the instrument wishes to support a 488.2 user request event. An event occurs when the instrument detects the activation of a user request local control. The message, Event –600 User Request, is loaded into the Error/Event Queue.
7	128	Power ON (PON)	Not implemented
8–15		Reserved	Reserved for possible future use by IEEE. Bit values are reported as zero.

Status Byte

The Status byte register contains the STB and RQS(MSS) messages as defined in 488.1. The user can read the status byte register using a 488.1 serial poll or the 488.2 *STB? common command. If the user sends a serial poll, bit 6 will respond with Request Service (RSQ). The value of the status byte is not altered by a serial poll.

The *STB? query causes the device to send the contents of the Status Byte Register and the Master Summary Status (MSS) summary message. The *STB? query does not alter the status byte, MSS, or RQS.

Table 4.21 Status Byte Summary Register

Bit	Bit Weight	Bit Name	Description
0	1	Reserved	
1	2	Reserved	
2	4	Error/Event Queue (ERR)	Set if any errors are present in the Error/Event queue.
3	8	Questionable Status Register (QSR)	Set if any bits are set in the Questionable Status Event register.
4	16	Message Available (MAV)	Indicates whether the output queue is empty. MAV is TRUE if the device is ready to accept a request from the controller.
5	32	Standard Event Status Bit Summary (ESB)	A summary of the Standard Event Status Register.
6	64	Request Service (RQS) Master Status Summary (MSS)	MSS indicates that the device has at least one reason for requesting service.
7	128	Operation Status Register (OSR)	Present if a bit is set in the Operation status register.

Error/Event Queue (ERR)

This bit is TRUE if any errors are present in the Error/Event Queue.

Remote Operation

SCPI Commands for Digital Interfaces

Questionable Status Register Summary (QSR)

This bit is TRUE when a bit in the Questionable Event Status Register is set and its corresponding bit in the Questionable Status Enable Register is TRUE.

Message Available (MAV)

This bit is TRUE whenever the power supply is ready to accept a request by the Digital Programming Interface to output data bytes. This message is FALSE when the output queue is empty.

Standard Event Status Summary (ESB)

This bit is TRUE when a bit is set in the Standard Event Status Register.

Master Summary Status (MSS)

This is caused by one of the following:

- Status Byte bit 0 AND Service Request Enable Register bit 0
- Status Byte bit 1 AND Service Request Enable Register bit 1
- Status Byte bit 2 AND Service Request Enable Register bit 2
- Status Byte bit 3 AND Service Request Enable Register bit 3
- Status Byte bit 4 AND Service Request Enable Register bit 4
- Status Byte bit 5 AND Service Request Enable Register bit 5
- Status Byte bit 7 AND Service Request Enable Register bit 7.

Request Service (RQS)

RQS is TRUE if the Service Request Enable Register has a bit set and there is a corresponding bit within the Status Byte.

The SRQ line of the GPIB will be set. The SRQ annunciator will be lit.

Operation Status Register Summary (OSR)

This bit is TRUE when a bit in the Operation Event Status Register is set and its corresponding bit in the Operation Status Enable Register is set.

**Status
Register
Commands**

In the following sections <status-enable> is a value from 0 to 32767 representing a 15-bit register mask.

SCPI Status Commands

Preset Status

Configures the status data structures to ensure that certain events are reported at a higher level through the status-reporting mechanism. These events are summarized in the mandatory structures, the Operation Status Register, and Questionable Status Register.

The PRESet command affects only the enable registers and the transition filter registers of the status data structures. PRESet does not clear any of the event registers or any item from the error/event queue. The *CLS command is used to clear all event registers and queues in the device status-reporting mechanism.

For the device-dependent status data structures, the PRESet command sets the enable register to all 1s and the transition filter register to report only positive transitions. For the SCPI mandatory status data structures, the PRESet command sets the transition filter registers to recognize only positive transitions and sets the enable register to 0s. The following will not be affected by this command: Service Request Enable Register, Parallel Poll Enable Register, the memory register associated with the *SAV command, the power supply address, Output Queue, and the power-on-status-clear flag setting.

Table 4.22 Preset Values of User Configurable Registers

Register	Filter/Enable	Preset Value
Operational	Enable Register	0s
	Positive Transition Filter	1s
	Negative Transition Filter	0s
Questionable	Enable Register	0s
	Positive Transition Filter	1s
	Negative Transition Filter	0s
All others	Enable Register	1s
	Positive Transition Filter	1s
	Negative Transition Filter	0s

SCPI command: STATus [<channel>] :PRESet

Remote Operation

SCPI Commands for Digital Interfaces

IEEE 488.2 Status and Event Commands

Clear Status Command

Clears all Event Registers, including the Status Byte, the Standard Event Status and the Error Queue.

Command: *CLS

SCPI equivalent for multichannel use: STATus [<channel>] :CLEAr

Standard Event Status Enable Register

The Event Summary Enable command determines which bits in the Standard Event Status Register are summarized in the Event Summary Bit (ESB) of the Status Byte.

The Power-on Status Clear command determines if the Standard Event Status Enable Register is cleared at power-on.

E.g.

Sending "*ESE 16" sets bit 4 of the Standard Event Status Enable Register. This will cause the Event Summary bit (ESB) in the Status Byte to be set whenever the Execution Error bit (bit 4) in the Standard Event Status Register gets set.

Command: *ESE <status-enable>, *ESE?

SCPI equivalent for multichannel use:

STATus [<channel>]:STANdard:ENABle <status-enable>

STATus [<channel>]:STANdard:ENABle?

Standard Event Status Register

The Standard Event Status Register query allows the user to determine the current contents of the Standard Event Status Register. (See “Standard Event Status Register” on page 153.) Reading this register clears it.

Command: *ESR?

SCPI equivalent for multichannel use:

STATus [<channel>]:STANdard[:EVENTt]?

Service Request Enable Register

The Service Request Enable Register allows the user to select the reasons for the power supply to issue a service request. The Service Request Enable Register allows the user to select which summary messages in the Status Byte Register may cause service requests.

To clear the Service Request Enable Register send "*SRE 0." The Power-on Status Clear command also determines if the Service Request Enable Register is cleared at power-on. A cleared register does not allow status information to generate a service request.

E.g.

Sending "*SRE 8" sets bit 3 of the Service Request Enable Register. This will cause the Summary bit of the Questionable Status register (bit 3) in the Status Byte to generate a service request message whenever it gets set.

Command: *SRE <Service-Request-Enable>, *SRE?

SCPI equivalent for multichannel use:

STATus[<channel>]:SREQuest:ENABLE <status-enable>
STATus[<channel>]:SREQuest:ENABLE?

Parallel Poll Enable Register

Each of the 16 bits in the Parallel Poll Enable register correspond to bits in the Status Byte. Each bit in the Parallel Poll Enable register is ANDed with its corresponding bit in the Status Byte and the resulting bits are ORed together to generate ist. Therefore using the parallel poll enable register allows any single bit or combination of bits to control the ist message.

The Power-on Status Clear command determines if the Parallel Poll Enable Register is cleared at power-on.

E.g.

Sending "*PRE 8" sets bit 3 of the Parallel Poll Enable Register. This will cause the Summary bit of the Questionable Status register (bit 3) in the Status Byte to generate a TRUE ist message whenever it gets set.

Command: *PRE <status-enable>, *PRE?

Remote Operation

SCPI Commands for Digital Interfaces

Status Byte

The status byte query will return the contents of the status byte register and the MSS (Master Summary Status) message. The response is in the format of a weighted decimal value representing the status byte register and the MSS message (bit 6). Thus, the response to *STB? is identical to the response to a serial poll except that the MSS message appears in bit 5 in place of the RQS message. (See “Status Byte” on page 155 for details.)

Command: *STB?

SCPI equivalent:

STATus:SBYTe[:EVENT]?

Power-on Status Clear

The Power-On Status Clear command controls the automatic power-on clearing of the Service Request Enable Register, the Standard Event Status Enable Register, the Parallel Poll Enable Register and the Error/Event Queue.

Command: *PSC {0|1}, *PSC?

SCPI equivalent for multichannel use:

SYSTEM[<channel>]:POSClear {ON|OFF|0|1}

SYSTEM[<channel>]:POSClear?

Individual Status Query

The individual status query allows the programmer to read the state of the IEEE 488.1 ist (individual status) message without performing a parallel poll. The query returns a "1" or "0."

The ist message is formed by ANDing the bits in the Parallel Poll Enable Register (*PRE) with the Status Byte and then ORing the result. In other words, the ist is TRUE if any of bits of the Parallel Poll Enable Register AND'ed with the Status Byte are TRUE.

Command: *IST?

Operation Complete

The Operation Complete command causes the power supply to generate the operation complete message in the Standard Event Status Register when all pending operations have been finished.

Command: *OPC, *OPC?

Wait-to-Continue Command

The Wait-to-Continue command prevents the power supply from executing any further commands or queries until the no-operation-pending flag is TRUE.

Command: *WAI

Operation Status Register Commands

Query Operation Status Register Event

SCPI command: STATus [<channel>]:OPERation[:EVENT]?

Query Operation Status Register Condition

SCPI command: STATus [<channel>]:OPERation:CONDition?

Enable Operation Status Register

SCPI command:

STATus [<channel>]:OPERation:ENABLE <status-enable>

Query Format:

STATus [<channel>]:OPERation:ENABLE?

Set Operation Status Positive Transition Filter

SCPI command:

STATus [<channel>]:OPERation:PTRansition <status-enable>

Query Format:

STATus [<channel>]:OPERation:PTRansition?

Set Operation Status Negative Transition Filter

SCPI command:

STATus [<channel>]:OPERation:NTRansition <status-enable>

Query Format:

STATus [<channel>]:OPERation:NTRansition?

Remote Operation

SCPI Commands for Digital Interfaces

Regulating Sub-Register Commands

Query Regulating Event

SCPI command:

```
STATus [<channel>]:OPERation:REGulating[:EVENT]?
```

Query Regulating Condition

SCPI command:

```
STATus [<channel>]:OPERation:REGulating:CONDition?
```

Enable Regulating Sub-Register

SCPI command:

```
STATus [<channel>]:OPERation:REGulating:ENABLE  
<status-enable>
```

Query format:

```
STATus [<channel>]:OPERation:REGulating:ENABLE?
```

Set Regulating Positive Transition Filter

SCPI command:

```
STATus [<channel>]:OPERation:REGulating:PTRansition  
<status-enable>
```

Query format:

```
STATus [<channel>]:OPERation:REGulating:PTRansition?
```

Set Regulating Negative Transition Filter

SCPI command:

```
STATus [<channel>]:OPERation:REGulating:NTRansition  
<status-enable>
```

Query format:

```
STATus [<channel>]:OPERation:REGulating:NTRansition?
```

Shutdown Sub-Register Commands

Query Shutdown Event

SCPI command:

```
STATus [<channel>]:OPERation:SHUTdown[:EVENT]?
```

Query Shutdown Condition

SCPI command:

```
STATus [<channel>]:OPERation:SHUTdown:CONDition?
```

Enable Shutdown Sub-Register

SCPI command:

```
STATus [<channel>]:OPERation:SHUTdown:ENABle <status-enable>
```

Query format:

```
STATus [<channel>]:OPERation:SHUTdown:ENABle?
```

Set Shutdown Positive Transition Filter

SCPI command:

```
STATus [<channel>]:OPERation:SHUTdown:PTRansition  
<status-enable>
```

Query format:

```
STATus [<channel>]:OPERation:SHUTdown:PTRansition?
```

Set Shutdown Negative Transition Filter

SCPI command:

```
STATus [<channel>]:OPERation:SHUTdown:NTRansition  
<status-enable>
```

Query format:

```
STATus [<channel>]:OPERation:SHUTdown:NTRansition?
```

Remote Operation

SCPI Commands for Digital Interfaces

Protection Shutdown Sub-Register Commands

Query Protection Shutdown Event

SCPI command:

```
STATus [<channel>]:OPERation:SHUTdown:PROTection[:EVENT]  
?
```

Query Protection Shutdown Condition

SCPI command:

```
STATus [<channel>]:OPERation:SHUTdown:PROTection:CONDiti  
on?
```

Enable Protection Shutdown Sub-Register

SCPI command:

```
STATus [<channel>]:OPERation:SHUTdown:PROTection:ENABle  
<status-enable>
```

Query format:

```
STATus [<channel>]:OPERation:SHUTdown:PROTection:ENABle?
```

Set Protection Shutdown Positive Transition Filter

SCPI command:

```
STATus [<channel>]:OPERation:SHUTdown:PROTection:PTRansi  
tion <status-enable>
```

Query format:

```
STATus [<channel>]:OPERation:SHUTdown:PROTection:PTRansi  
tion?
```

Set Protection Shutdown Negative Transition Filter

SCPI command:

```
STATus [<channel>]:OPERation:SHUTdown:PROTection:NTRansi  
tion <status-enable>
```

Query format:

```
STATus [<channel>]:OPERation:SHUTdown:PROTection:NTRansi  
tion?
```

Remote Control Sub-Register Commands

Query Remote Control Event

SCPI command:

```
STATus [<channel>]:OPERation:RCONtrol[:EVENT]?
```

Query Remote Control Condition

SCPI command:

```
STATus [<channel>]:OPERation:RCONtrol:CONDition?
```

Enable Remote Control Sub-Register

SCPI command:

```
STATus [<channel>]:OPERation:RCONtrol:ENABle  
<status-enable>
```

Query Format:

```
STATus [<channel>]:OPERation:RCONtrol:ENABle?
```

Set Remote Control Positive Transition Filter

SCPI command:

```
STATus [<channel>]:OPERation:RCONtrol:PTRansition  
<status-enable>
```

Query Format:

```
STATus [<channel>]:OPERation:RCONtrol:PTRansition?
```

Set Remote Control Negative Transition Filter

SCPI command:

```
STATus [<channel>]:OPERation:RCONtrol:NTRansition  
<status-enable>
```

Query Format:

```
STATus [<channel>]:OPERation:RCONtrol:NTRansition?
```

Remote Operation

SCPI Commands for Digital Interfaces

Current Share Sub-Register Commands

Query Current Share Register Event

STATus [<channel>]:OPERation:CSHare[:EVENT]?

Query Current Share Register Condition

SCPI command:

STATus [<channel>]:OPERation:CSHare:CONDition?

Enable Current Share Sub-Register

SCPI command:

STATus [<channel>]:OPERation:CSHare:ENABLE
<status-enable>

Query Format:

STATus [<channel>]:OPERation:CSHare:ENABLE?

Set Current Share Positive Transition Filter

SCPI command:

STATus [<channel>]:OPERation:CSHare:PTRansition
<status-enable>

Query Format:

STATus [<channel>]:OPERation:CSHare:PTRansition?

Set Remote Control Negative Transition Filter

SCPI command:

STATus [<channel>]:OPERation:CSHare:NTRansition
<status-enable>

Query Format:

STATus [<channel>]:OPERation:CSHare:NTRansition?

Questionable Status Register Commands

Query Questionable Status Register Event

SCPI command:

```
STATus [<channel>]:QUESTionable[:EVENT]?
```

Query Questionable Status Register Condition

SCPI command:

```
STATus [<channel>]:QUESTionable:CONDition?
```

Enable Questionable Status Register

SCPI command:

```
STATus [<channel>]:QUESTionable:ENABle <status-enable>
```

Query Format:

```
STATus [<channel>]:QUESTionable:ENABle?
```

Set Questionable Status Positive Transition Filter

SCPI command:

```
STATus [<channel>]:QUESTionable:PTRansition  
<status-enable>
```

Query Format:

```
STATus [<channel>]:QUESTionable:PTRansition?
```

Set Questionable Status Negative Transition Filter

SCPI command:

```
STATus [<channel>]:QUESTionable:NTRansition  
<status-enable>
```

Query Format:

```
STATus [<channel>]:QUESTionable:NTRansition?
```

Remote Operation

SCPI Commands for Digital Interfaces

Voltage Sub-Register Commands

Query Voltage Sub-Register Event

SCPI command:

```
STATus [<channel>]:QUESTionable:VOLTage[:EVENT]?
```

Query Voltage Sub-Register Condition

SCPI command:

```
STATus [<channel>]:QUESTionable:VOLTage:CONDition?
```

Enable Voltage Sub-Register

SCPI command:

```
STATus [<channel>]:QUESTionable:VOLTage:ENABLE  
<status-enable>
```

Query Format:

```
STATus [<channel>]:QUESTionable:VOLTage:ENABLE?
```

Set Voltage Positive Transition Filter

SCPI command:

```
STATus [<channel>]:QUESTionable:VOLTage:PTRansition  
<status-enable>
```

Query Format:

```
STATus [<channel>]:QUESTionable:VOLTage:PTRansition?
```

Set Voltage Negative Transition Filter

SCPI command:

```
STATus [<channel>]:QUESTionable:VOLTage:NTRansition  
<status-enable>
```

Query Format:

```
STATus [<channel>]:QUESTionable:VOLTage:NTRansition?
```

Current Sub-Register Commands

Query Current Sub-Register Event

SCPI command:

```
STATus [<channel>]:QUEStionable:CURRent[:EVENT]?
```

Query Current Sub-Register Condition

SCPI command:

```
STATus [<channel>]:QUEStionable:CURRent:CONDition?
```

Enable Current Sub-Register

SCPI command:

```
STATus [<channel>]:QUEStionable:CURRent:ENABle  
<status-enable>
```

Query Format:

```
STATus [<channel>]:QUEStionable:CURRent:ENABle?
```

Set Current Positive Transition Filter

SCPI command:

```
STATus [<channel>]:QUEStionable:CURRent:PTRansition  
<status-enable>
```

Query Format:

```
STATus [<channel>]:QUEStionable:CURRent:PTRansition?
```

Set Current Negative Transition Filter

SCPI command:

```
STATus [<channel>]:QUEStionable:CURRent:NTRansition  
<status-enable>
```

Query Format:

```
STATus [<channel>]:QUEStionable:CURRent:NTRansition?
```

Remote Operation

SCPI Commands for Digital Interfaces

Power Sub-Register Commands

Query Power Sub-Register Event

SCPI command:

```
STATus [<channel>]:QUESTionable:POWer[:EVENT]?
```

Query Power Sub-Register Condition

SCPI command:

```
STATus [<channel>]:QUESTionable:POWer:CONDition?
```

Enable Power Sub-Register

SCPI command:

```
STATus [<channel>]:QUESTionable:POWer:ENABLE  
<status-enable>
```

Query Format:

```
STATus [<channel>]:QUESTionable:POWer:ENABLE?
```

Set Power Positive Transition Filter

SCPI command:

```
STATus [<channel>]:QUESTionable:POWer:PTRansition  
<status-enable>
```

Query Format:

```
STATus [<channel>]:QUESTionable:POWer:PTRansition?
```

Set Power Negative Transition Filter

SCPI command:

```
STATus [<channel>]:QUESTionable:POWer:NTRansition  
<status-enable>
```

Query Format:

```
STATus [<channel>]:QUESTionable:POWer:NTRansition?
```

Temperature Sub-Register Commands

Query Questionable Temperature Sub-Register Event

Temperature Event Sub-Register is read and then cleared.

SCPI command:

```
STATus [<channel>]:QUEStionable:TEMPerature[:EVENT]?
```

Query Questionable Temperature Sub-Register Condition

SCPI command:

```
STATus [<channel>]:QUEStionable:TEMPerature:CONDition?
```

Enable Temperature Sub-Register

SCPI command:

```
STATus [<channel>]:QUEStionable:TEMPerature:ENABLE  
<status-enable>
```

Query Format:

```
STATus [<channel>]:QUEStionable:TEMPerature:ENABLE?
```

Set Temperature Positive Transition Filter

SCPI command:

```
STATus [<channel>]:QUEStionable:TEMPerature:PTRansition  
<status-enable>
```

Query Format:

```
STATus [<channel>]:QUEStionable:TEMPerature:PTRansition?
```

Set Temperature Negative Transition Filter

SCPI command:

```
STATus [<channel>]:QUEStionable:TEMPerature:NTRansition  
<status-enable>
```

Query Format:

```
STATus [<channel>]:QUEStionable:TEMPerature:NTRansition?
```

Remote Operation

SCPI Commands for Digital Interfaces

Section 5. Current Sharing (6000 Watt only)

Overview

The current sharing function is only available for 6000 Watt units. Power supplies can be equipped with the optional CANbus interface to allow current sharing between units connected in parallel. Current sharing can use a maximum of 5 supplies. All power supplies must be the same model. Every unit must have a unique address. See “Multichannel Operation (6000 Watt only)” on page 113.

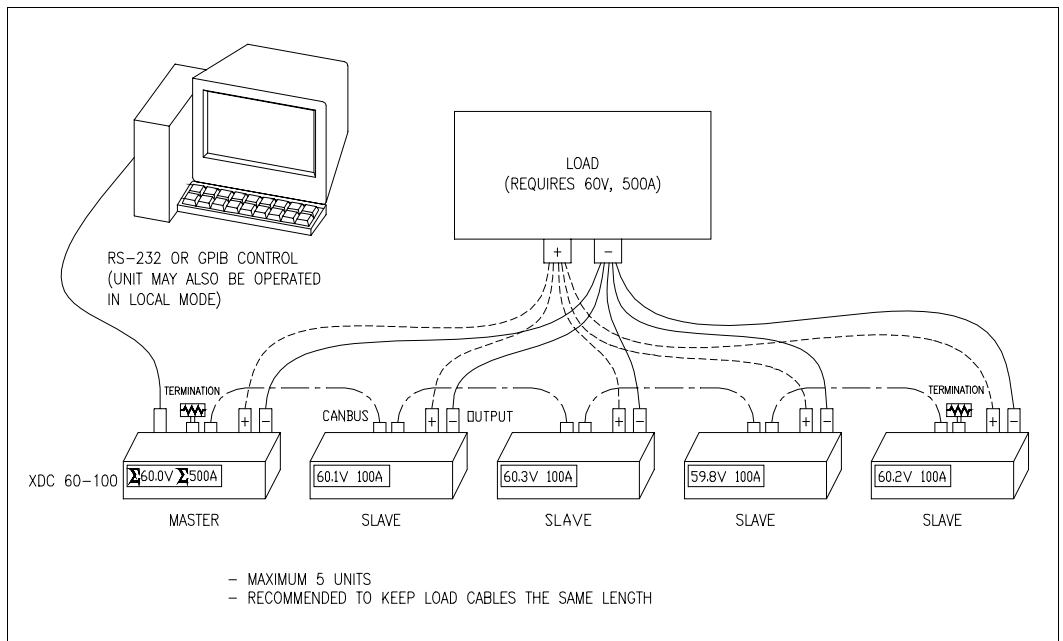

Figure 5.1 Connections for Current Share Operation

Theory of Operation Power supplies may be connected in parallel to supply a large current to a load. Typically, because of differences in the load connections, each power supply may provide different amounts of current to the load.

When multiple power supplies are configured for current sharing, the master supply will make minute changes to the slave's voltage and current to equalize the current draw from each.

The slaves will track the master's voltage, current, output and output on/off setting.

Current Sharing (6000 Watt only)

Overview

Configure Current Share Current sharing may be configured either by SCPI commands sent via a remote interface or by using the Front Panel. The current sharing modes available are:











- **No sharing**
- **Master:** sets up the unit as the master controller.
- **Slave:** sets up the unit as the controlled slave.

Front Panel

In addition to selecting the current share mode, the master may be set up to display the summed current from all units.

On the front panel, a **MASTER** or **SLAVE** annunciator will light up to indicate the current share mode.

To configure current share with the front panel:

Step #	Do This	You Will See
1		ERROR MSGS
2	 or  Press 7 times	CURRENT SHARE
3		No share
4	 or  to select the current share option (No share, Master or Slave). Press  to save. If No share or Slave are selected, configuration is complete and the menu exits.	Master
4a	If Master has been selected, you will be prompted to select whether the master should display the total current output of all current share units. Use  or  to select Y or N. Press 	Display Sum? Y

SCPI

Select whether the unit will operate as a master or slave unit:

```
SOURCE:COMBine:CSHare:MODE [MASTer | SLAVe | OFF]
```

To query the total output current of all current sharing units, use the SCPI command:

```
MEAS:CURR? SUM
```

The current share subregister (CSHare) will show whether the master or slave is operating.

```
STAT:OPER:CSH:COND?
```

See Table 4.14, “Current SHare Sub-Register,” on page 148 for a description of the bits in this register.

Setup Current Sharing Network

To set up multiple supplies for current share operation, follow these steps:

1. Configure each supply with a unique multichannel address. (See “Multichannel Operation (6000 Watt only)” on page 113.)
Configure one supply to operate as the master. Configure others to operate as slaves.
2. Power down the units. Connect the CAN ports of all paralleled units as you would for multichannel operation
3. Make load connections. It is recommended to keep load cables the same length if possible. See Figure 5.1.
4. Power up the master, then all slaves.
5. Set the voltage on the master, then enable the output.

Current Sharing (6000 Watt only)

Operation

Operation

Once a current sharing network is setup, you may adjust the voltage setpoint on the master. The master will automatically adjust the setpoints of the slave units to equalize the current output of all units. You may also disable or enable the output of the master, automatically disabling or enabling the output of all slaves.

You may use local or remote (RS-232, GPIB, multichannel or analog) control to operate the master.

Slaves will be operating under remote control from the master and in local lockout. Hence, they will only respond to remote queries or the OUT ON/OFF key on the front panel.

The default display will show a greek letter sigma before the readback current if the summed current output is being displayed. E.g. The display may read "60.00V Σ 500A". However, the setpoint displayed on the master is still the current limit for a single unit.

The master or slave annunciators will light up to show that current share is operating properly.

Power supplies may not enter calibration mode while current sharing, or enter current share operation while in calibration mode.

Errors The slave annunciator will flash if it does not detect a master on the network. Check the cable and the master configuration.

A master or slave will be disabled from current sharing (set to "No share") if:

- there is more than one master connected to the CANbus, (Error +1811)
- there are more than 4 slaves, (Error +1822), or
- the model does not match that of the master, (Error +1822).

In each of these cases, the current share mode will be set to "No share".

If a unit becomes disconnected due to a failure in communications, the master will queue error +1812, "Current Share Slave Lost" and the slave will queue error +1821, "Current Share Master Lost." The slave's output will be disabled, and the slave annunciator will flash.

See "Current Share Error Codes" on page 222 for the list of error codes and messages.

Specifications

Max current share units	5
Max cable length	40m
Bus speed	700 kbits/sec
Termination	120 ohm, 1/4 Watt
Connections	parallel male DB9 to female DB9 cable

Current Sharing (6000 Watt only)

Operation

Appendix A. Calibration

These are the calibration procedures for the 6000 W unit. If you purchased a 12000 W unit, please reference the accompanying addendum for the correct calibration procedures.

Overview

The calibration of the unit is software dependent; there are no potentiometers to adjust.

Calibration may be performed via the front panel or SCPI commands. Front panel calibration is partially automated. The calibration points are set automatically and you will be prompted to enter the measurement data.

There are 10 items that need to be calibrated. Output voltage and output current are mandatory. If you intend to use the analog programming interface, you must calibrate it as well. It needs to be calibrated in both the 0-5V and the 0-10V ranges. In each range, voltage programming, voltage readback, current programming and current readback need to be calibrated.

All calibration data is taken at 10% and 90% of the rated outputs.

The setting and readback accuracy of the power supply should be checked annually, and calibration done only if the unit is not operating within its specification.

Note POWER is calculated from voltage and current readback.

The OTP and AC off protection mechanisms are operational during calibration. All other protection mechanisms are disabled.

Entering Calibration Mode



CAUTION





Calibration procedures should only be performed by qualified users. Failure to adhere to this warning may cause damage to the power supply, or pose a safety hazard for the user.

Calibration mode can be entered from the front panel by selecting "CALIBRATION" from the main menu or by using the "change calibration state" SCPI command.

Calibration

Entering Calibration Mode

Front Panel To access calibration mode via the front panel:

Step #	Do This	You Will See
1		ERROR MSGS
2	 Press 2 times.	CALIBRATION
3		Code #####
4	Enter the calibration security code. The factory code is "0000".	Code 0000
5	 You are now in the Calibration menu.	Output V Cal

If your password code is incorrect, the prompt displays `Incorrect code` and automatically returns to `Code #####`. Either try again or press **EXIT** to escape.

If your password code is correct, the prompt displays `Output V Cal`. This is the first of 12 available options. The 12 sets of parameters that must be adjusted during calibration are:

- **Output V Cal:** Calibrate voltage output and readback.
- **Output I Cal:** Calibrate current output and readback.
- **ANLG V PGM 5V:** Calibrate 5V analog programming interface for setting voltage output.
- **ANLG V RB 5V:** Calibrate 5V analog programming interface for monitoring voltage output.
- **ANLG I PGM 5V:** Calibrate 5V analog programming interface for setting current output.
- **ANLG I RB 5V:** Calibrate 5V analog programming interface for monitoring current output.
- **ANLG V PGM 10V:** Calibrate 10V analog programming interface for setting voltage output.
- **ANLG V RB 10V:** Calibrate 10V analog programming interface for monitoring voltage output.
- **ANLG I PGM 10V:** Calibrate 10V analog programming interface for setting current output.
- **ANLG I RB 10V:** Calibrate 10V analog programming interface for monitoring current output.
- **Factory Cal:** Lets you restore the factory calibration constants.
- **Change Code:** Lets you change the password code.

SCPI To access calibration mode via remote interface, use the command:

```
CAL:STAT ON, "0000"1
```



To check if the power supply is in calibration mode, use the command:

```
CAL:STAT ?
```

Security code To protect calibration data, a security code is required to enter calibration mode. The security code set at the factory to "0000."

The password can be changed from the remote interface or the front panel. Calibration state must be ON to change the password. From the front panel, select "Change Code" from the calibration menu and enter the new code.

To change the Calibration security code:

Step #	Do This	You Will See
1		Output V Cal
2	 or  Scroll to select Change Code.	Change Code
3	Enter a new 4-digit code. 	Code ####
4	You are back in the Calibration menu.	Output V Cal

If you have entered a valid code, the prompt displays Output V Cal. You can either continue working with the calibration options or press **EXIT** to leave calibration mode.

The SCPI command to change the security code is:

```
CAL:CODE <security_code>
```

The security code is any 4-digit number enclosed by quotation marks. Trying to change the password to an invalid one causes an error.

1. where the parameter "0000" may be replaced with your own 4-digit security code.

Calibration

Setup and Equipment

Setup and Equipment

- 6 digit DVM
- current shunt
- variable load
- 0-10 V DC power supply (analog programming interface)
- Load wiring sized for the maximum available output current. See Table 2.4, on page 48.

To set up to calibrate output voltage and current:

Connect a load to the output of the power supply and a current shunt in series.

You will need to use the DVM to measure both the voltage at the output of the power supply and the voltage across the shunt. You will need to convert the voltage across the shunt to a current measurement.

To set up to calibrate the analog programming interface, you will need a 0-10V power supply to provide a programming signal to the voltage and current programming lines. You will also need to connect the DVM to measure the signal at the readback lines.

Front Panel Calibration Procedure

Calibration can also be done via remote control, using SCPI commands. See “Remote Interface Calibration Procedure” on page 187.

Calibration of voltage programming and readback are combined in a single procedure.

- Output Voltage**
1. Set the load to open circuit. Attach a DVM across the output terminals.
 2. *Enter output voltage calibration menu*
Select Output V Cal from the calibration menu. Press ENTER.
You will be prompted to set up for output voltage calibration. Press ENTER when ready.
 3. *Minimum calibration level*
The power supply will automatically set the output voltage to 10%.
 4. *Enter voltage data*
Enter the voltage output, read from the external DVM. Press ENTER
 5. *Maximum calibration level*
The power supply will set the output voltage to 90%.
 6. *Enter voltage data*
Enter the voltage output, read from the external DVM. Press ENTER.
 7. Power supply calculates and stores calibration constants.
 8. The menu will go to the Output Current Calibration menu.
- Output Current**
1. Set the power supply and load operate at full output. You must ensure the power supply is operating in current mode during current calibration. Place a shunt on the load line so that you can measure the current. Attach a DVM across the shunt
 2. *Enter output current calibration menu*
Select Output I Cal from the calibration menu. Press ENTER.
You will be prompted to set up for output current calibration. Press ENTER when ready.
 3. *Minimum calibration level*
The power supply will automatically set the output current to 10%

Calibration

Front Panel Calibration Procedure

4. *Enter current data*

Enter the current output, read from the external DVM via the shunt. Press ENTER

5. *Maximum calibration level*

The power supply will set the output to 90%.

6. *Enter current data*

Enter the current output, read from the external DVM via the shunt. Press ENTER.

7. Power supply calculates and stores calibration constants.

8. The menu will go to the 5V analog voltage programming calibration menu.

Analog Programming Interface 0-5V Range

To set up to calibrate the analog programming interface, you will need a DC power source capable of outputting 0 to 5V and a DVM.

See Table 4.2 “Analog Programming Pins”

Analog Programming Interface Voltage Programming Calibration

1. Connect the power source across the voltage programming lines, Pins B3 and B1(GND). Attach a DVM across the voltage programming lines as well.

2. *Enter 5V analog voltage programming calibration menu*

Select ANLG V PGM 5V from the calibration menu. Press ENTER.

You will be prompted to set up for analog voltage programming calibration. Press ENTER when ready.

3. *Minimum calibration level*

Set the input to the programming lines to approximately 0.5V (10% of full scale).

4. *Enter voltage data*

Enter the voltage at the voltage programming lines, read from the external DVM. Press ENTER

5. *Maximum calibration level*

Set the input to the programming lines to approximately 4.5V (90% of full scale).

6. *Enter voltage data*

Enter the voltage at the voltage programming lines, read from the external DVM. Press ENTER.

7. Power supply calculates and stores calibration constants.
8. The menu will go to the 5V analog voltage readback calibration menu.

Analog Programming Interface Voltage Readback Calibration

1. Attach a DVM across the voltage readback lines, Pins B5 and B1(GND).
2. *Enter 5V analog voltage readback calibration menu*
Select ANLG V PGM 5V from the calibration menu. Press ENTER.

You will be prompted to set up for output voltage calibration. Press ENTER when ready.
3. *Minimum calibration level*
The power supply will automatically set the voltage readback lines to approximately 10% of full scale.
4. *Enter voltage data*
Enter the voltage across the voltage readback lines, read from the external DVM.
Press ENTER
5. *Maximum calibration level*
The power supply will automatically set the voltage readback lines to approximately 90% of full scale.
6. *Enter voltage data*
Enter the voltage across the voltage readback lines, read from the external DVM.
Press ENTER.
7. Power supply calculates and stores calibration constants.
8. The menu will go to the 5V analog current programming calibration menu.

Analog Programming Interface Current Programming Calibration

1. Connect the power source across the current programming lines, Pins B4 and B1(GND). Attach a DVM across the current programming lines as well.
2. *Enter 5V analog current programming calibration menu*
Select ANLG I PGM 5V from the calibration menu. Press ENTER.

You will be prompted to set up for calibration. Press ENTER when ready.
3. *Minimum calibration level*
Set the input to the programming lines to approximately 0.5V (10% of full scale).

Calibration

Front Panel Calibration Procedure

4. *Enter voltage data*

Enter the voltage at the current programming lines, read from the external DVM. Press ENTER

5. *Maximum calibration level*

Set the input to the programming lines to approximately 4.5V (90% of full scale).

6. *Enter voltage data*

Enter the voltage at the current programming lines, read from the external DVM. Press ENTER.

7. Power supply calculates and stores calibration constants.

8. The menu will go to the 5V analog current readback calibration menu.

Analog Programming Interface Current Readback Calibration

1. Attach a DVM across the current readback lines, Pins B6 and B1(GND).

2. *Enter 5V analog current readback calibration menu*

Select ANLG I RB 5V from the calibration menu. Press ENTER.

You will be prompted to set up for analog current readback calibration. Press ENTER when ready.

3. *Minimum calibration level*

The power supply will automatically set the current readback lines to approximately 10% of full scale.

4. *Enter voltage data*

Enter the voltage read from the external DVM. Press ENTER

5. *Maximum calibration level*

The power supply will automatically set the current readback lines to approximately 90% of full scale.

6. *Enter voltage data*

Enter the voltage at the current readback lines, read from the external DVM. Press ENTER.

7. Power supply calculates and stores calibration constants.

8. The menu will go to the 10V analog voltage programming calibration menu.

- Analog Programming Interface 0-10V Range** The 0-10V range of the analog programming interface must be calibrated separately. Follow the procedure exactly as for calibrating the 0-5V range, using the corresponding 10V menu options. All the analog signals will be scaled by a factor of 2.

Remote Interface Calibration Procedure

Calibration can also be done via front panel. See “Front Panel Calibration Procedure” on page 183.

Calibration of voltage programming and readback are combined in a single procedure.

- Output Voltage**
1. Set the load to open circuit. Attach a DVM across the output terminals.
 2. *Minimum calibration level*
Set the output voltage to 10% by sending the command:
CAL:OUTP:VOLT:LEV MIN
 3. *Enter voltage data*
Enter the voltage read from the external DVM.
CAL:OUTP:VOLT:DATA <voltage>
 4. *Maximum calibration level*
Set the output voltage to 90% by sending the command:
CAL:OUTP:VOLT:LEV MAX
 5. *Enter voltage data*
Enter the voltage read from the external DVM.
CAL:OUTP:VOLT:DATA <voltage>
 6. Power supply calculates and stores calibration constants.
- Output Current**
1. Set the power supply and load operate at full output. You must ensure the power supply is operating in current mode during current calibration. Place a shunt on the load line so that you can measure the current. Attach a DVM across the shunt
 2. *Minimum calibration level*
Set the output current to 10% by sending the command:
CAL:OUTP:CURR:LEV MIN

Calibration

Remote Interface Calibration Procedure

3. *Enter current data*

Enter the current read from the external DVM via the shunt.

```
CAL:OUTP:CURR:DATA <current>
```

4. *Maximum calibration level*

Set the output current to 90% by sending the command:

```
CAL:OUTP:CURR:LEV MAX
```

5. *Enter current data*

Enter the current read from the shunt via the external DVM.

```
CAL:OUTP:CURR:DATA <current>
```

6. Power supply calculates and stores calibration constants.

Analog Programming Interface 0-5V Range

To set up to calibrate the analog programming interface, you will need a DC power source capable of outputting 0 to 5V and a DVM.

Table 4.2 “Analog Programming Pins”

Analog Programming Interface Voltage Programming Calibration

1. Connect the power source across the voltage programming lines, Pins B3 and B1(GND). Attach a DVM across the voltage programming lines as well.

2. *Minimum calibration level*

Set the input to the programming lines to approximately 0.5V (10% of full scale).

Set the power supply to receive 5V analog voltage programming calibration data with the command:

```
CAL:ANAL:5V:PROG:VOLT:LEV MIN
```

3. *Enter voltage data*

Enter the voltage at the voltage programming lines, read from the external DVM.

```
CAL:ANAL:5V:PROG:VOLT:DATA <voltage>
```

4. *Maximum calibration level*

Set the input to the programming lines to approximately 4.5V (90% of full scale).

Set the power supply to receive 5V analog voltage programming calibration data with the command:

```
CAL:ANAL:5V:PROG:VOLT:LEV MAX
```

5. *Enter voltage data*

Enter the voltage at the voltage programming lines, read from the external DVM.

CAL:ANAL:5V:PROG:VOLT:DATA <voltage>

6. Power supply calculates and stores calibration constants.

Analog Programming Interface Voltage Readback Calibration

1. Attach a DVM across the voltage readback lines, Pins B5 and B1(GND).

2. *Minimum calibration level*

Set the voltage readback lines to approximately 10% of full scale by sending the command:

CAL:ANAL:5V:READ:VOLT:LEV MIN

3. *Enter voltage data*

Enter the voltage across the voltage readback lines, read from the external DVM.

CAL:ANAL:5V:READ:VOLT:DATA <voltage>

4. *Maximum calibration level*

Set the voltage readback lines to approximately 90% of full scale by sending the command:

CAL:ANAL:5V:READ:VOLT:LEV MAX

5. *Enter voltage data*

Enter the voltage across the voltage readback lines, read from the external DVM.

CAL:ANAL:5V:READ:VOLT:DATA <voltage>

6. Power supply calculates and stores calibration constants.

Analog Programming Interface Current Programming Calibration

1. Connect the power source across the current programming lines, Pins B4 and B1(GND). Attach a DVM across the current programming lines as well.

2. *Minimum calibration level*

Set the input to the programming lines to approximately 0.5V (10% of full scale).

Set the power supply to receive 5V analog current programming calibration data with the command:

CAL:ANAL:5V:PROG:CURR:LEV MIN

Calibration

Remote Interface Calibration Procedure

3. *Enter voltage data*

Enter the voltage at the current programming lines, read from the external DVM.

CAL:ANAL:5V:PROG:CURR:DATA <voltage>

4. *Maximum calibration level*

Set the input to the programming lines to approximately 4.5V (90% of full scale).

Set the power supply to receive 5V analog current programming calibration data by sending the command:

CAL:ANAL:5V:PROG:CURR:LEV MAX

5. *Enter voltage data*

Enter the voltage at the current programming lines, read from the external DVM.

CAL:ANAL:5V:PROG:CURR:DATA <voltage>

6. Power supply calculates and stores calibration constants.

Analog Programming Interface Current Readback Calibration

1. Attach a DVM across the current readback lines, Pins B6 and B1(GND).

2. *Minimum calibration level*

Set the current readback lines to approximately 10% of full scale by sending the command:

CAL:ANAL:5V:READ:CURR:LEV MIN

3. *Enter voltage data*

Enter the voltage across the current readback lines, read from the external DVM.

CAL:ANAL:5V:READ:CURR:DATA <voltage>

4. *Maximum calibration level*

Set the current readback lines to approximately 90% of full scale by sending the command:

CAL:ANAL:5V:READ:CURR:LEV MAX

5. *Enter voltage data*

Enter the voltage across the current readback lines, read from the external DVM.

CAL:ANAL:5V:READ:CURR:DATA <voltage>

6. Power supply calculates and stores calibration constants.

**Analog
Programming
Interface
0-10V Range**

The 0-10V range of the analog programming interface must be calibrated separately. Follow the procedure exactly as for calibrating the 0-5V range, except that all the analog signals will be scaled by a factor of 2.

The commands will begin with the header:

```
CAL:ANAL:10V:...
```

The inputs to the programming lines should be approximately 1V for the minimum calibration level and 9V for the maximum calibration level.

Calibration

Exit calibration mode

Exit calibration mode



When you have completed calibration, hit the EXIT key.

The SCPI command is:

CAL:STAT OFF, "0000"

Restore Factory Calibration

To restore the unit to the calibration constants set at the factory:

Step #	Do This	You Will See
1		Output V Cal
2	 or  Scroll to select Factory Cal.	Factory Cal
3	Select Y to Restore the factory calibration. Selecting N will exit.	Restore? Y

The SCPI command is

CALibration:REStore

Note This procedure should not be used in place of regular calibration, but may be useful to restore the unit to an operational state in case of failure.

Appendix B. SCPI Command Reference

Overview

This appendix provides a summary of the Standard Commands for Programmable Instruments (SCPI) that are supported by the this Programmable Power Supply.

Codes and Standards

This power supply conforms to the following international standards:

- IEEE Std 488.2-1992 “IEEE Standard Codes, Formats, Protocols, and Common Commands For Use With IEEE Std 488.1-1987”
- IEEE Std 488.1-1987 “IEEE Standard Digital Interface for Programmable Instrumentation”
- TIA/EIA-232F
- Standard Commands for Programmable Instruments (SCPI) Version 1997.0

IEEE 488.2 Requirements GPIB control implements all IEEE 488.2 requirements.

SCPI Requirements The power supply conforms to the following SCPI requirements:

- SCPI mandated commands
- Questionable Status Register (QSR), Condition, Event, Enable
- Operation Status Register (OSR), Condition, Event, Enable
- Status Byte Register (SBR)
- Standard Event Status Register (SESR)

IEEE-488.2/SCPI Syntax and Style

Parameters Units of Measure and Multipliers

Refer to *IEEE 488.2*, section 7.7.3 for the definition of units of measure.

The default units of measure include:

- V (Volt – voltage)
- A (Ampere – current)
- W (Watt – power)
- S (seconds – time)

The supported optional multipliers include:

- m (milli)
- k (kilo)

Note The SI standard for these multipliers is specifically lowercase, while the IEEE standard specifies uppercase. Both combinations are supported.

SCPI Command Hierarchy

SCPI is an ASCII-based command language designed for use in high-technology test and measurement equipment. The command structure is organized around common roots, or nodes, which are the building blocks of SCPI subsystems. An example of a common root is CALibration, and some of the commands that reside in the CALibration subsystem are shown below.

CALibration

```
:CURRent
  [:DATA] <numeric value>
  :LEVel {MIN|MAX}
[:SECure]
  :CODE <new code>
  :STATe {OFF|ON}, <code>
  :STATe?
```

CALibration is the root keyword of the command. CURRent and SECure are second-level keywords, and DATA, LEVel, CODE, and STATe, are third-level keywords. A colon (:) is used to separate a command keyword from a lower-level keyword.

Using SCPI Commands

Throughout these commands, the optional command [`<channel>`] is available for the 6000 W units, but not available for 12000 W power supplies.

This manual shows SCPI commands in the following format:

```
CALibration:CURRent:LEVel {<current>|MIN|MAX}
```

The command is expressed as a mixture of upper- and lowercase letters. The uppercase letters suggest how the command can be abbreviated into a short form. SCPI commands can be sent in long or short forms. The short form is better for data entry. The long form is better for readability.

Command strings are not case sensitive: CURR, Curr, and curr are all acceptable abbreviations for CURRent. As for the long form, CURRENT, Current, and current are all acceptable.

The command strings include punctuation. While some punctuation is sent with the string, other markings are used to identify different elements of the command syntax and are not sent with the string.

The following punctuation is sent with the command string:

- **Colons (:)** separate command keywords from lower-level keywords. For example, `CAL:CURR:STAT`.
- **Blank spaces** separate command keywords from parameter values. For example, `CURR 0.1`.
- **Commas** separate parameters from each other when more than one parameter is sent in the same string. For example, `CAL:STAT OFF,"1234."`
- **Semicolons (;)** separate multiple commands from the same subsystem. This allows for greater efficiency. For example:

```
CAL:CURR:LEV MIN;VOLT:LEV MIN
```

is the same as typing:

```
CAL:CURR:LEV MIN  
CAL:VOLT:LEV MIN
```

- **Colons and semicolons** can be used together to link commands from different subsystems. For example:

```
CAL:CURR:LEV MIN;:MEAS:CURR?
```

The following punctuation is not sent with the command string:

- **Braces ({ })** identify a selection of choices. Choose one of the enclosed values.
- **Vertical bars, or pipes, (|)** separate the choices found within the braces.

SCPI Command Reference

Using SCPI Commands

- **Angle brackets (< >)** identify where specific values must be entered for a parameter. For example, in the example at the top of the page, the parameter <current> appears in the command string. To set the current setpoint to 0.1A, the syntax is `CAL:CURR:LEV 0.1`.
- **Square brackets ([])** identify optional parameters. If an optional parameter is not sent with the command string, a default parameter is sent in its place.

Using Minimum and Maximum

In the following example, Minimum and Maximum are offered as alternative choices to declaring a specific parameter value.

```
CAL:CURRent:LEVel {<current>|MIN|MAX}
```

The string `CAL:CURR:LEV MIN` sets the current calibration level to the minimum model value.

Using Queries

A question mark lets you query the present value for most parameters. For example, to query the current calibration state use:

```
CAL:SEC:STAT?
```

You can also use the following to query minimum and maximum allowed values for most parameters:

```
:VOLT? MIN  
:VOLT? MAX
```

Note If you send 2 queries, it is best to read and respond to the first response before trying to read the second. Otherwise, you may receive an incomplete first response followed by a complete second response. To avoid this, you can either wait for and read the first response before sending the second query, or send a device clear message before sending the second query.

Terminating Characters

Every command string must end with a terminating <new line> character. An IEEE-488 EOI (end-or-identify) can be used instead of a <new line> character. It is also acceptable to use a <carriage return> followed by a <new line>. Terminating a command string always resets the SCPI command path to the root level.

Common Commands

The IEEE-488.2 standard includes a set of common commands for functions such as reset and self-test. These common commands always start with an asterisk (*), contain 4 or 5 characters, and may have one or more parameters. The command is always separated from the parameter by a blank space. Multiple commands sent in the same string are separated by a semi-colon (;). The following is an example of how 3 common commands can be sent together in the same string:

```
*OPC; *PSC Off; *TRG
```

Parameter Types

Several different data types are defined for use in program messages and response messages.

Boolean Parameters Boolean parameters are single binary conditions such as 1 and 0, or ON and OFF. The following is an example of a command that uses Boolean parameters:

```
SYST:COMM:PIB:PONS {ON|OFF|1|0}
```

Discrete Parameters Discrete parameters are used when program settings have a limited number of values. If you query a discrete parameter, the response will always be in the short form with all uppercase letters. The following is an example of a command that uses discrete parameters:

```
TRIG:SOUR {BUS|EXT|IMM|NONE}
```

Numeric Parameters Numeric parameters are number representations such as decimal points, optional signs, and scientific notation. Values such as MINimum and MAXimum are accepted as substitutes for numbers. When DEFault is provided as a parameter, the machine selects the default value automatically. You can also use engineering unit suffixes such as V, A, or W with numeric parameters. In cases where specific numeric values are accepted, the power unit will round the input parameters. The following is an example of a command that uses numeric parameters:

```
VOLT:PROT {<voltage>|MAX|MIN}
```

String Parameters String parameters are used when a series of ASCII characters is required. Strings must be enclosed within single or double quotations. The beginning and ending quotation marks must be matching. Quote delimiters may be included in the string by typing the quotation marks twice without any characters in between. The following is an example of a command that uses string parameters:

```
CAL:STAT ON, "0000"
```

SCPI Command Summary

The SCPI commands supported by the this Programmable Power Supply are described in the tables in the remainder of this section. These tables use the following column headings:

- **Function** The commonly used name for the function
- **SCPI Command** The full command in long form
- **Description** Explains what the command does or what is affected by it
- **Query?** Indicates whether the unit supports a query version of the listed command

Notations Used in the Tables

The following abbreviations are used in the command listings:

- **N/A** Not applicable. (The command has no associated setpoint value.)

Table B.1 IEEE 488.2 Commands

Function	SCPI Command	Description	Query
Clear Status	*CLS [:]STATUS[<channel>]:CLEAR	Clears the status data structures.	N/A
Standard Event Status Enable Query	*ESE? [:]STATUS[<channel>]:STANDARD:ENABLE	Query the Standard Event Status Enable register settings.	N/A
Standard Event Status Enable	*ESE [:]STATUS[<channel>]:STANDARD:ENABLE <ESE-word>	Set the Standard Event Status Enable Register bits.	N/A
Standard Event Status Register Query	*ESR? [:]STATUS[<channel>]:STANDARD[:EVENT]?	Query Standard Event Status Register.	N/A
Identification Query	*IDN? [:]SYSTEM[<channel>]:IDENTIFY?	Query identification string. (Manufacturer's information.)	N/A
Individual Status Query	*IST?	Reads the current state of the IEEE 488.1 defined "ist" local message in the device	N/A
Operation Complete Command	*OPC	Causes the device to generate the operation complete message in the Standard Event Status register when all pending detected device operations have finished	N/A
Query Operation Complete Command	*OPC?	Place and ASCII character "1" into the output queue when all pending operations have been finished. See IEEE 488.2-1992 section 12.5.3.	N/A
Option Identification Query	*OPT? [:]SYSTEM[<channel>]:OPTION	Identify reportable device options	N/A
Parallel Poll Enable Register Query	*PRE?	Query the Parallel Poll Enable Register setting	N/A
Parallel Poll Enable Register Command	*PRE <status-enable>	Sets the Parallel Poll Enable Register bits. See IEEE 488.2 section 11.6 for details.	N/A
Query Power On Status Clear	*PSC? [:]STATUS[<channel>]:POSCLEAR?	Query Power-On Status Clear setting	N/A
Power-On Status Clear	*PSC [:]STATUS[<channel>]:POSCLEAR <on-off-state>	Controls the automatic power-on clearing of the Service Request Enable Register, Standard Event Status Enable Register, Parallel Poll Enable Register and other event enable registers. Possible values are 0 (leave them alone) or 1 (clear them).	N/A
Recall	*RCL [:]SYSTEM[<channel>]=RECALL <setting_location>	Restores the settings of unit from values stored in memory.	N/A
Reset	*RST [:]SYSTEM[<channel>]:RESET	Performs a device reset. Set the power supply to a known state that is independent of the use history of the device.	N/A
Save User Settings	*SAV [:]SYSTEM[<channel>]:SAVE[USER] <setting_location>	Stores the current setting of the device in local memory. Scope is same as *RST	N/A

Save Default Settings	*SDS [:]SYSTem[<channel>]:SAVE:DEFault <setting_location>	Save the factory default settings.	N/A
Query Service Request Enable	*SRE? [:]STATus[<channel>]:SREQuest:ENABLE?	Query the Service Request Enable Register bits.	N/A
Service Request Enable	*SRE [:]STATus[<channel>]:SREQuest:ENABLE <status-enable>	Set the Service Request Enable Register bits.	N/A
Read Status Byte	*STB? [:]STATus[<channel>]:SBYTE[EVENT]?	Read the status byte and Master Summary Status bit.	N/A
Trigger	*TRG	Trigger commands. Analogous to the IEEE 488.1 defined Group Execute Trigger interface message. See IEEE 488.2 section 6.1.4.2.5	N/A
Self-Test Query	*TST? [:]SYSTem[<channel>]:TEST?	Internal self-test and responds indicating whether or not the device completed the self-test without any detected errors.	N/A
Wait To Continue	*WAI [:]SYSTem[<channel>]:WAIT	Prevents the device from executing any further commands or queries until the no-operation-pending flag is TRUE>(*OPC?)	N/A

Table B.2Readback Commands

Function	SCPI Command	Description	Query
Read Output Current	[:]MEASure[<channel>][:SCALar]:CURRent[:DC]?	Read output current	N/A
Read Output Power	[:]MEASure[<channel>][:SCALar]:POWer[:DC]?	Read output power	N/A
Read Output Voltage	[:]MEASure[<channel>][:SCALar][:VOLTage][:DC]?	Read output voltage	N/A

Table B.3 Commands for Output Control

Function	SCPI Command	Description	Query
Set (Immediate) Current Setpoint	[[[:]SOURCE][<channel>]:CURRENT[:LEVEL][:IMMEDIATE][:AMPLITUDE] {<current> MAXimum MINimum}	Change current setpoint	Yes
Set Triggered Current Setpoint	[[[:]SOURCE][<channel>]:CURRENT[:LEVEL]:TRIGGERED[:AMPLITUDE] {<current> MAXimum MINimum DEFAULT}	Change triggered current setpoint	Yes
Set (Immediate) Power Setpoint	[[[:]SOURCE][<channel>]:POWER[:LEVEL][:IMMEDIATE][:AMPLITUDE] {<power> MAXimum MINimum}	Change power setpoint	Yes
Set Triggered Power Setpoint	[[[:]SOURCE][<channel>]:POWER[:LEVEL]:TRIGGERED[:AMPLITUDE] {<power> MAXimum MINimum DEFAULT}	Change triggered power setpoint	Yes
Set (Immediate) Voltage Setpoint	[[[:]SOURCE][<channel>]:VOLTAGE[:LEVEL][:IMMEDIATE][:AMPLITUDE] {<voltage> MAXimum MINimum}	Change voltage setpoint	Yes
Set Triggered Voltage Setpoint	[[[:]SOURCE][<channel>]:VOLTAGE[:LEVEL]:TRIGGERED[:AMPLITUDE] {<voltage> MAXimum MINimum DEFAULT}	Change triggered voltage setpoint	Yes
Set Voltage Slew Rate Voltage	[[[:]SOURCE][<channel>]:VOLTAGE:SLEW:STEP<slewrates-voltage> MAXimum MINimum DEFAULT}	Sets the voltage slew rate voltage change for the programmed time interval	Yes
Set Voltage Slew Rate Interval	[[[:]SOURCE][<channel>]:VOLTAGE:SLEW:INTERVAL<slewrates-interval> MAXimum MINimum DEFAULT}	Sets the voltage slew rate time interval for the programmed voltage change	Yes
Set Over Current Protection Level	[[[:]SOURCE][<channel>]:CURRENT:PROTECTION[:OVER][:LEVEL] {<current> MAXimum MINimum}	Set the over current protection level	Yes
Set Over Current Protection Shutdown State	[[[:]SOURCE][<channel>]:CURRENT:PROTECTION[:OVER]:STATE <on-off-state>	Select over current protection to shutdown(ON) or set alarm (OFF)	Yes
Query Over Current Protection Tripped	[[[:]SOURCE][<channel>]:CURRENT:PROTECTION[:OVER]:TRIPPED?	Query if over current protection mechanism has tripped	N/A
Set Under Current Protection Level	[[[:]SOURCE][<channel>]:CURRENT:PROTECTION:UNDER[:LEVEL] {<current> MAXimum MINimum}	Set under current protection level	Yes
Set Under Current Protection Shutdown State	[[[:]SOURCE][<channel>]:CURRENT:PROTECTION:UNDER:STATE <on-off-state>	Select under current protection to shutdown (ON) or set alarm (OFF)	Yes
Query Under Current Protection Tripped	[[[:]SOURCE][<channel>]:CURRENT:PROTECTION:UNDER:TRIPPED?	Query if under current protection mechanism has tripped	N/A
Set Over Power Protection Level	[SOURCE][<channel>]:POWER:PROTECTION[:OVER][:LEVEL] {<power> MAXimum MINimum}	Set the over power protection level	Yes
Set Over Power Protection Shutdown State	[SOURCE][<channel>]:POWER:PROTECTION[:OVER]:STATE <on-off-state>	Select over power protection to shutdown (ON) or set alarm (OFF)	Yes
Query Over Power Protection Tripped	[[[:]SOURCE][<channel>]:POWER:PROTECTION[:OVER]:TRIPPED?	Query if over power protection mechanism has tripped	N/A
Set Under Power Protection Level	[[[:]SOURCE][<channel>]:POWER:PROTECTION:UNDER[:LEVEL] {<power> MAXimum MINimum}	Set under power protection level	Yes

Set Under Power Protection Shutdown State	[[[:]SOURCE] [<channel>]:POWER:PROTECTION:UNDER:STATE <on-off-state>	Select under power protection to shutdown (ON) or set alarm (OFF)	Yes
Query Under Power Protection Tripped	[[[:]SOURCE] [<channel>]:POWER:PROTECTION:UNDER:TRIPPED?	Query if under power protection mechanism has tripped	N/A
Set Over Voltage Protection Level	[[[:]SOURCE] [<channel>]:VOLTAGE:PROTECTION[:OVER][:LEVEL] {<voltage> MAXIMUM MINIMUM}	Set the over voltage protection level	Yes
Query Over Voltage Protection Tripped	[SOURCE] [<channel>]:VOLTAGE:PROTECTION[:OVER]:TRIPPED?	Query if over voltage protection mechanism has tripped	N/A
Set Under Voltage Protection Level	[[[:]SOURCE] [<channel>]:VOLTAGE:PROTECTION:UNDER[:LEVEL] {<voltage> MAXIMUM MINIMUM}	Set under voltage protection level	N/A
Set Under Voltage Protection Shutdown State	[[[:]SOURCE] [<channel>]:VOLTAGE:PROTECTION:UNDER:STATE <on-off-state>	Select under voltage protection to shutdown (ON) or set alarm (OFF)	Yes
Query Under Voltage Protection Tripped	[[[:]SOURCE] [<channel>]:VOLTAGE:PROTECTION:UNDER:TRIPPED?	Query if under voltage protection mechanism has tripped	N/A
Set High Current Limit	[[[:]SOURCE] [<channel>]:CURRENT:LIMIT:HIGH {<current> MAXIMUM MINIMUM}	Set upper limit of current setpoint range (soft limits)	Yes
Set Low Current Limit	[[[:]SOURCE] [<channel>]:CURRENT:LIMIT:LOW {<current> MAXIMUM MINIMUM}	Set lower limit of current setpoint range (soft limits)	Yes
Set High Power Limit	[[[:]SOURCE] [<channel>]:POWER:LIMIT:HIGH {<power> MAXIMUM MINIMUM}	Set upper limit of power setpoint range (soft limits)	Yes
Set Low Power Limit	[[[:]SOURCE] [<channel>]:POWER:LIMIT:LOW {<power> MAXIMUM MINIMUM}	Set lower limit of power setpoint range (soft limits)	Yes
Set High Voltage Limit	[[[:]SOURCE] [<channel>]:VOLTAGE:LIMIT:HIGH {<voltage> MAXIMUM MINIMUM}	Set upper limit of voltage setpoint range (soft limits)	Yes
Set Low Voltage Limit	[[[:]SOURCE] [<channel>]:VOLTAGE:LIMIT:LOW {<voltage> MAXIMUM MINIMUM}	Set lower limit of voltage setpoint range (soft limits)	Yes

Table B.4 Commands for Current Share (6000 W only)

Function	SCPI Command	Description	Query
Set Current Sharing Mode	[[[:]SOURCE] [<channel>]:COMBINE:CSHARE:MODE {NONE MASTER SLAVE}	Select current share mode	Yes
Read Summed Current	[[:]MEASURE[:SCALAR]:CURRENT[:DC]? SUM	Read total current output of all current sharing supplies	N/A

Table B.5Commands for Calibration

Function	SCPI Command	Description	Query
Restore Factory ion	[:]CALibration[<channel>]:REStore	Restores the calibration to the constants set at the factory	N/A
Change Calibration Password	[:]CALibration[<channel>][:SECure]:CODE <codeword>	Changes the calibration security code.	No
Set Calibration State	[:]CALibration[<channel>][:SECure]:STATe <on-off-state>,<codeword>	Change calibration state (mode)	Yes
Set Analog Current Programming Input Level	[:]CALibration[<channel>]:ANALog:<5V 10V>:PROGram:CURRent:LEVel {MINimum MAXimum}	Set analog programming current calibration level	No
Enter Analog Current Programming Input Data	[:]CALibration[<channel>]:ANALog: :{5V 10V}:PROGram:CURRent[:DATA] <current>	Set analog programming current calibration data	No
Set Analog Voltage Programming Input Level	[:]CALibration[<channel>]:ANALog: :{5V 10V}:PROGram:VOLTage:LEVel {MINimum MAXimum}	Set analog programming voltage calibration level	No
Enter Analog Voltage Programming Input Data	[:]CALibration[<channel>]:ANALog: :{5V 10V}:PROGram:VOLTage[:DATA] <current>	Set analog programming voltage calibration data	No
Set Analog Current Readback Output Level	[:]CALibration[<channel>]:ANALog: :{5V 10V}:READback:CURRent:LEVel {MINimum MAXimum}	Set analog readback current calibration level	No
Enter Analog Current Readback Output Data	[:]CALibration[<channel>]:ANALog: :{5V 10V}:READback:CURRent[:DATA] <current>	Set analog readback current calibration data	No
Set Analog Voltage Readback Output Level	[:]CALibration[<channel>]:ANALog: :{5V 10V}:READback:VOLTage:LEVel {MINimum MAXimum}	Set analog readback voltage calibration level	No
Enter Analog Voltage Readback Output Data	[:]CALibration[<channel>]:ANALog: :{5V 10V}:READback:VOLTage[:DATA] <current>	Set analog readback voltage calibration data	No
Set Supply Output Current Level	[:]CALibration[<channel>]:OUTPut:CURRent:LEVel {MINimum MAXimum}	Set output current calibration level	No
Enter Output Current Data	[:]CALibration[<channel>]:OUTPut:CURRent[:DATA] <current>	Set output current calibration data	No
Set Supply Output Voltage Level	[:]CALibration[<channel>]:OUTPut:VOLTage:LEVel {MINimum MAXimum}	Set voltage output calibration level	No
Enter Output Voltage Data	[:]CALibration[<channel>]:OUTPut:VOLTage[:DATA] <voltage>	Set voltage output calibration data	No

Table B.6Command to Clear all Protection Mechanisms

Function	SCPI Command	Description	Query
Clear Output Protection	[:]OUTPut [<channel>]:PROTection:CLEar	Clears the protection mechanism.	N/A

Table B.7 Commands for Fold Protection

Function	SCPI Command	Description	Query
Set Output Fold Delay	[:]OUTPut[<channel>]:PROTection:FOLD:DElay <delay>	Set the delay time (seconds) before fold protection is triggered.	Yes
Set Output Fold Mode	[:]OUTPut[<channel>]:PROTection:FOLD[:MODE] {NONE CC CP CV}	Select which regulation mode to fold back (None, CV, CC, CP)	Yes
Query Fold Protection Tripped	[:]OUTPut[<channel>]:PROTection:FOLD:TRIPped?	Query if fold protection has tripped	N/A

Table B.8 Commands for Triggering

Function	SCPI Command	Description	Query
Set Immediate Initiation of Trigger System	[:]INITiate[<channel>][:IMMediate]	Initiate a triggered event or sequence	N/A
Set Trigger Source	[:]TRIGger[<channel>][:SEQuence]:SOURce {BUS EXTErnal IMMediate NONE}	Sets the trigger source for triggered setpoints	Yes

Table B.9 System Commands

Function	SCPI Command	Description	Query
Query System Error	[:]SYSTem[<channel>]:ERRor[:NEXT]?	Returns the next error in the instrument's error queue	N/A
Recall Default Factory Preset	[:]SYSTem[<channel>]:RECall:DEFault	Restore the factory preset values	N/A
Select Remote Control Source	[:]SYSTem[<channel>]:REMOte:SOURce {RS232 GPIB AVOLtage ACURrent AVCurrent MCHannel}	Select the remote control source	Yes
Set RS-232 Baud Rate	[:]SYSTem[<channel>]:COMMunicate:SERial[:RECEive]:BAUD {1200 2400 4800 9600 ...}	Configure the RS-232 baud rate	Yes
Set RS-232 Flow Control	[:]SYSTem[<channel>]:COMMunicate:SERial[:RECEive]:PACE {HARDware XON NONE}	Select type of flow control for RS-232	Yes
Set Multichannel Address (6000 W only)	[:]SYSTem[<channel>]:COMMunicate:MCHannel:ADDRESS <channel>	Select the multichannel unit address	Yes
Set GPIB Address	[:]SYSTem[<channel>]:COMMunicate:GPIB[:SELF]:ADDRESS <GPIB_address>	Configure GPIB address	Yes
Set GPIB Power On Service Request	[:]SYSTem[<channel>]:COMMunicate:GPIB[:SELF]:PONsrq {ON OFF 0 1}	Configure GPIB PON SRQ	Yes
Select Range for Analog Programming Interface	[:]SYSTem[<channel>]:COMMunicate:APROgram:LEVel {5 10}	Select analog interface voltage levels	Yes
Set Remote Control Operation (Serial Interface)	[:]SYSTem[<channel>]:REMOte:STATe {LOCAL REMOte RWLock}	RS-232 Only. Change remote control mode	Yes
Query SCPI Version	[:]SYSTem[<channel>]:VERSion?	Returns the SCPI version to which the instrument complies. Format is YYYY.V	N/A

Table B.10 Status Commands

Function	SCPI Command	Description	Query
Power On Status Clear (*PSC)	[:]STaTus[<channel>]:POSClear <on-off-state>	Controls the automatic power-on clearing of the Service Request Enable Register, Standard Event Status Enable Register, Parallel Poll Enable Register and other event enable registers	Yes
Query Operation Status Condition Register	[:]STaTus[<channel>]:OPERation:CONDition?	See Table 4.9, on page 145.	N/A
Set Operation Status Enable Register	[:]STaTus[<channel>]:OPERation:ENABle <status-enable>	See Table 4.9, on page 145.	Yes
Query Operation Status Event Register	[:]STaTus[<channel>]:OPERation[:EVENT]?	See Table 4.9, on page 145.	N/A
Set Operation Status Negative Transition Register	[:]STaTus[<channel>]:OPERation:NTRansition <status-enable>	See Table 4.9, on page 145.	Yes
Set Operation Status Positive Transition Register	[:]STaTus[<channel>]:OPERation:PTRansition <status-enable>	See Table 4.9, on page 145.	Yes
Query Operation Status Current Sharing Condition Register	[:]STaTus[<channel>]:OPERation:CSHare:CONDition?	See Table 4.14, on page 148.	N/A
Set Operation Status Current Sharing Enable Register	[:]STaTus[<channel>]:OPERation:CSHare:ENABle <status-enable>	See Table 4.14, on page 148.	Yes
Query Operation Status Current Sharing Event Register	[:]STaTus[<channel>]:OPERation:CSHare[:EVENT]?	See Table 4.14, on page 148.	N/A
Set Operation Status Current Sharing Negative Transition Register	[:]STaTus[<channel>]:OPERation:CSHare:NTRansition <status-enable>	See Table 4.14, on page 148.	Yes
Set Operation Status Current Sharing Positive Transition Register	[:]STaTus[<channel>]:OPERation:CSHare:PTRansition <status-enable>	See Table 4.14, on page 148.	Yes
Query Operation Status Remote Control Condition Register	[:]STaTus[<channel>]:OPERation:RCONTRol:CONDition?	See Table 4.13, on page 148.	N/A
Set Operation Status Remote Control Enable Register	[:]STaTus[<channel>]:OPERation:RCONTRol:ENABle <status-enable>	See Table 4.13, on page 148.	Yes
Query Operation Status Remote Control Event Register	[:]STaTus[<channel>]:OPERation:RCONTRol[:EVENT]?	See Table 4.13, on page 148.	N/A

Set Operation Status Remote Control Negative Transition Register	[:]STATUS[<channel>]:OPERation:RCONtrol:NTRansiion <status-enable>	See Table 4.13, on page 148.	Yes
Set Operation Status Remote Control Positive Transition Register	[:]STATUS[<channel>]:OPERation:RCONtrol:PTRansiion <status-enable>	See Table 4.13, on page 148.	Yes
Query Operation Status Regulating Condition Register	[:]STATUS[<channel>]:OPERation:REGulating:CONDition?	See Table 4.10, on page 146.	N/A
Set Operation Status Regulating Enable Register	[:]STATUS[<channel>]:OPERation:REGulating:ENABle <status-enable>	See Table 4.10, on page 146.	Yes
Query Operation Status Regulating Event Register	[:]STATUS[<channel>]:OPERation:REGulating[:EVENT]?	See Table 4.10, on page 146.	N/A
Set Operation Status Regulating Negative Transition Register	[:]STATUS[<channel>]:OPERation:REGulating:NTRansiion <status-enable>	See Table 4.10, on page 146.	Yes
Set Operation Status Regulating Positive Transition Register	[:]STATUS[<channel>]:OPERation:REGulating:PTRansiion <status-enable>	See Table 4.10, on page 146.	Yes
Query Operation Status Shutdown Condition Register	[:]STATUS[<channel>]:OPERation:SHUTdown:CONDition?	See Table 4.11, on page 146.	N/A
Set Operation Status Shutdown Enable Register	[:]STATUS[<channel>]:OPERation:SHUTdown:ENABle <status-enable>	See Table 4.11, on page 146.	Yes
Query Operation Status Shutdown Event Register	[:]STATUS[<channel>]:OPERation:SHUTdown[:EVENT]?	See Table 4.11, on page 146.	N/A
Set Operation Status Shutdown Negative Transition Register	[:]STATUS[<channel>]:OPERation:SHUTdown:NTRansiion <status-enable>	See Table 4.11, on page 146.	Yes
Set Operation Status Shutdown Positive Transition Register	[:]STATUS[<channel>]:OPERation:SHUTdown:PTRansiion <status-enable>	See Table 4.11, on page 146.	Yes
Query Operation Status Shutdown Protection Condition Register	[:]STATUS[<channel>]:OPERation:SHUTdown:PROtECTION:CO NDition?	See Table 4.11, on page 146.	N/A
Set Operation Status Shutdown Protection Enable Register	[:]STATUS[<channel>]:OPERation:SHUTdown:PROtECTION:EN ABle <status-enable>	See Table 4.11, on page 146.	Yes
Query Operation Status Shutdown Protection Event Register	[:]STATUS[<channel>]:OPERation:SHUTdown:PROtECTION[:E VENT]?	See Table 4.11, on page 146.	N/A

Set Operation Status Shutdown Protection Negative Transition Register	[:]STATUS[<channel>]:OPERation:SHUTdown:PROTection:NT Ransition <status-enable>	See Table 4.11, on page 146.	Yes
Set Operation Status Shutdown Protection Positive Transition Register	[:]STATUS[<channel>]:OPERation:SHUTdown:PROTection:PT Ransition <status-enable>	See Table 4.11, on page 146.	Yes
Preset Enable, Positive Transition and Negative Transition Status Registers	[:]STATUS[<channel>]:PRESet		N/A
Query Questionable Status Condition Register	[:]STATUS[<channel>]:QUEStionable:CONDition?	See Table 4.15, on page 151.	N/A
Set Questionable Status Enable Register	[:]STATUS[<channel>]:QUEStionable:ENABle <status-enable>	See Table 4.15, on page 151.	Yes
Query Questionable Status Event Register	[:]STATUS[<channel>]:QUEStionable[:EVENT]?	See Table 4.15, on page 151.	N/A
Set Questionable Status Negative Transition Register	[:]STATUS[<channel>]:QUEStionable:NTRansition <status-enable>	See Table 4.15, on page 151.	Yes
Set Questionable Status Positive Transition Register	[:]STATUS[<channel>]:QUEStionable:PTRansition <status-enable>	See Table 4.15, on page 151.	Yes
Query Questionable Status Current Condition Register	[:]STATUS[<channel>]:QUEStionable:CURRent:CONDition?	See Table 4.17, on page 152.	N/A
Set Questionable Status Current Enable Register	[:]STATUS[<channel>]:QUEStionable:CURRent:ENABle <status-enable>	See Table 4.17, on page 152.	Yes
Query Questionable Status Current Event Register	[:]STATUS[<channel>]:QUEStionable:CURRent[:EVENT]?	See Table 4.17, on page 152.	N/A
Set Questionable Status Current Negative Transition Register	[:]STATUS[<channel>]:QUEStionable:CURRent:NTRansition <status-enable>	See Table 4.17, on page 152.	Yes
Set Questionable Status Current Positive Transition Register	[:]STATUS[<channel>]:QUEStionable:CURRent:PTRansition <status-enable>	See Table 4.17, on page 152.	Yes
Query Questionable Status Power Condition Register	[:]STATUS[<channel>]:QUEStionable:POWer:CONDition?	See Table 4.18, on page 152.	N/A
Set Questionable Status Power Enable Register	[:]STATUS[<channel>]:QUEStionable:POWer:ENABle <status-enable>	See Table 4.18, on page 152.	Yes
Query Questionable Status Power Event Register	[:]STATUS[<channel>]:QUEStionable:POWer[:EVENT]?	See Table 4.18, on page 152.	N/A

Set Questionable Status Power Negative Transition Register	[:]STATUS[<channel>]:QUESTIONable:POWer:NTRansi <status-enable>	See Table 4.18, on page 152.	Yes
Set Questionable Status Power Positive Transition Register	[:]STATUS[<channel>]:QUESTIONable:POWer:PTRansi <status-enable>	See Table 4.18, on page 152.	Yes
Query Questionable Status Temperature Condition Register	[:]STATUS[<channel>]:QUESTIONable:TEMPerature:CONDiti on?	See Table 4.19, on page 153	N/A
Set Questionable Status Temperature Enable Register	[:]STATUS[<channel>]:QUESTIONable:TEMPerature:ENABLe <status-enable>	See Table 4.19, on page 153.	Yes
Query Questionable Status Temperature Event Register	[:]STATUS[<channel>]:QUESTIONable:TEMPerature[:EVENT] ?	See Table 4.19, on page 153	N/A
Set Questionable Status Temperature Negative Transition Register	[:]STATUS[<channel>]:QUESTIONable:TEMPerature:NTRansi tion <status-enable>	See Table 4.19, on page 153	Yes
Set Questionable Status Temperature Positive Transition Register	[:]STATUS[<channel>]:QUESTIONable:TEMPerature:PTRansi tion <status-enable>	See Table 4.19, on page 153	Yes
Query Questionable Status Voltage Condition Register	[:]STATUS[<channel>]:QUESTIONable:VOLTage:CONDiti on?	See Table 4.16, on page 152.	N/A
Set Questionable Status Voltage Enable Register	[:]STATUS[<channel>]:QUESTIONable:VOLTage:ENABLe <status-enable>	See Table 4.16, on page 152.	Yes
Query Questionable Status Voltage Event Register	[:]STATUS[<channel>]:QUESTIONable:VOLTage[:EVENT] ?	See Table 4.16, on page 152.	N/A
Set Questionable Status Voltage Negative Transition Register	[:]STATUS[<channel>]:QUESTIONable:VOLTage:NTRansi <status-enable>	See Table 4.16, on page 152.	Yes
Set Questionable Status Voltage Positive Transition Register	[:]STATUS[<channel>]:QUESTIONable:VOLTage:PTRansi <status-enable>	See Table 4.16, on page 152.	Yes
Query the Standard Event register (ESR?)	[:]STATUS[<channel>]:STANdard[:EVENT]?	See Table 4.20, on page 154.	N/A
Enable the Standard Event register (*ESE,*ESE?)	[:]STATUS[<channel>]:STANdard:ENABLe	See Table 4.20, on page 154.	Yes
Query the Status Byte (*STB)	[:]STATUS[<channel>]:SBYTE[:EVENT]?	See Table 4.21, on page 155.	N/A
Service Request Enable (*SRE,*SRE?)	[:]STATUS[<channel>]:SSREQuest:ENABLe <status-enable>	Set the bits in the Service Request Enable Register.	Yes

Table B.11Protection Commands

Function	SCPI Command	Description	Query
Set Over Temperature Response	[:]SENSE[<channel>]:TEMPerature:PROTection:LATCh <on-off-state>	Select if output is latched off or auto recovers in the case of an over temperature condition	Yes
Query Over Temperature Protection Tripped	[:]SENSE[<channel>]:TEMPerature:PROTection:TRIPped?	Query temperature protection tripped	N/A
Set AC Fail Response	[:]SENSE[<channel>]:VOLTage:AC:PROTection:LATCh <on-off-state>	Select if output is latched off or auto recovers in the case of an AC Fail	Yes
Query AC Fail Protection Tripped	[:]SENSE[<channel>]:VOLTage:AC:PROTection:TRIPped?	Query AC protection circuit tripped	N/A

Table B.12User Lines

Function	SCPI Command	Description	Query
Select polarity of Auxiliary Lines	[:]OUTPut[<channel>]:AUXiliary<A B>:POLarity {HIGH LOW}	Configure the polarity of the auxiliary line	Yes
Select Source of Auxiliary Line State	[:]OUTPut[<channel>]:AUXiliary<A B>:SOURce <aux_line_mnemonic>	Configure the auxiliary line	Yes
Query state of Auxiliary Line	[:]OUTPut[<channel>]:AUXiliary<A B>:STATe?	Query the state of the auxiliary line	N/A

Table B.13Output State

Function	SCPI Command	Description	Query
Set Output State	[:]OUTPut[<channel>][:STATe] <on-off-state>	Enable/disable the power supply output.	Yes
Set Output State at Power-On	[:]OUTPut[<channel>]:PON:STATe <on-off-state>	Selects the state of the output at power-on	Yes
Power-On Configuration	[:]OUTPut[<channel>]:PON:RECall {LAST PRESet USER<setting_location> SEQ<sequence_number>}	Configure the supply to recall last setting, one of the user settings, factory preset values or to enable an auto sequence.	Yes

Table B.14 Auto Sequence Commands

Function	SCPI Command	Description	Query
Delete selected sequence	[:]PROGRAM[<channel>][:SELEcted]:DELEte[:SELEcted]	The selected sequence is deleted	N/A
Delete all sequences	[:]PROGRAM[<channel>][:SELEcted]:DELEte:ALL	All sequences are deleted	N/A
Select a sequence to run or edit	[:]PROGRAM[<channel>][:SELEcted]:NAME<sequence_number>	Select sequence to run or edit	Yes
Change Auto Sequence operating state	[:]PROGRAM[<channel>][:SELEcted]:STATE{RUN PAUSE STOP}	Change operating state of current auto sequence	Yes
Skip to the next step (while running in auto sequence)	[:]PROGRAM[<channel>][:SELEcted]:STEP:NEXT	Skip to start of next step. Error if STATE is not RUN	N/A
Read selected sequence number of steps	[:]PROGRAM[<channel>][:SELEcted]:COUNT?	Read number of programmed steps in selected sequence	Yes
Delete selected sequence step	[:]PROGRAM[<channel>][:SELEcted]:STEP<step_number>:DELEte	Delete the selected sequence step	N/A
Exit a selected sequence	[:]PROGRAM[<channel>][:SELEcted]:EXIT	Exit a selected sequence	N/A
Read current step number	[:]PROGRAM[<channel>][:SELEcted]:STEP:EXECuting?	Query current step in execution	N/A
Edit selected sequence step	[:]PROGRAM[<channel>][:SELEcted]:STEP<step_number>[:EDIT][[[[<voltage>],<current>],<power>],<OVP_level>],{<time> TRIG}]	Edit the selected sequence step	Yes
Insert step into selected sequence	[:]PROGRAM[<channel>][:SELEcted]:STEP<step_number>:INSErt[[[[[<voltage>],<current>],<power>],<OVP_level>],{<step_time> TRIG}]	Insert a step into the selected sequence	N/A
Program selected sequence step current	[:]PROGRAM[<channel>][:SELEcted]:STEP<step_number>:CURRENT <current>	Edit/program step current of selected sequence	Yes
Program selected sequence step voltage	[:]PROGRAM[<channel>][:SELEcted]:STEP<step_number>:VOLTage <voltage>	Edit/program step voltage of selected sequence	Yes
Program selected sequence step power	[:]PROGRAM[<channel>][:SELEcted]:STEP<step_number>:POWER <power>	Edit/program step power of selected sequence	Yes
Program selected step OVP	[:]PROGRAM[<channel>][:SELEcted]:STEP<step_number>:OVP <OVP_level>	Edit/program step OVP level of selected sequence	Yes
Program selected sequence step time	[:]PROGRAM[<channel>][:SELEcted]:STEP<step_number>:DWEll {<step_time> TRIG}	Edit/program step time or triggering of selected sequence	Yes
Program selected sequence trigger source	[:]PROGRAM[<channel>][:SELEcted]:TRIGGER:SOURCE{BUS MANual EXTErnal IMMediate}	Edit/program trigger source of selected sequence	Yes
Program selected sequence end action	[:]PROGRAM[<channel>][:SELEcted]:REPEAT{<sequence_count> ONCE FOREver INFIInity}	Edit/program end action of selected sequence	Yes
Read specific sequence number of steps	[:]PROGRAM[<channel>]:SEQUENCE<sequence_number>:STEP:COUNT?	Read number of programmed steps in specific sequence	Yes
Delete a specific sequence	[:]PROGRAM[<channel>]:SEQUENCE<sequence_number>:DELEte	The specific sequence is deleted	N/A

Delete specific sequence step	[:]PROGram[<channel>]:SEQuence<sequence_number>:STEP<step_number>:DELEte	Delete a specific sequence step	N/A
Edit specific sequence step	[:]PROGram[<channel>]:SEQuence<sequence_number>:STEP<step_number>[:EDIT] [[[[[<voltage>],<current>],<power>],<OVP_level>],{<time> TRIG}]	Edit a specific sequence step	Yes
Insert step into specific sequence	[:]PROGram[<channel>]:SEQuence<sequence_number>:STEP<step_number>:INSert <voltage>,<current>,<power>,<OVP_level>,{<step_time> TRIG}	Insert a step into a specific sequence	N/A
Program specific sequence step current	[:]PROGram[<channel>]:SEQuence<sequence_number>:STEP<step_number>:CURRent <current>	Edit/program step current of specific sequence	Yes
Program specific sequence step voltage	[:]PROGram[<channel>]:SEQuence<sequence_number>:STEP<step_number>:VOLTAge <voltage>	Edit/program step voltage of specific sequence	Yes
Program specific sequence step power	[:]PROGram[<channel>]:SEQuence<sequence_number>:STEP<step_number>:POWer <power>	Edit/program step power of specific sequence	Yes
Program specific step OVP	[:]PROGram[<channel>]:SEQuence<sequence_number>:STEP<step_number>:OVP <OVP_level>	Edit/program step OVP level of specific sequence	Yes
Program specific sequence step time	[:]PROGram[<channel>]:SEQuence<sequence_number>:STEP<step_number>:DWELL {<step_time> TRIG}	Edit/program step time or triggering of specific sequence	Yes
Program specific sequence trigger source	[:]PROGram[<channel>]:SEQuence<sequence_number>:TRIGger:SOURce {BUS MANual EXTernal IMMediate}	Edit/program trigger source of specific sequence	Yes
Program specific sequence end action	[:]PROGram[<channel>]:SEQuence<sequence_number>:REPeat {<sequence_count> ONCE FOrever INFinity}	Edit/program end action of specific sequence	Yes

Table B.15 Legacy Commands

Function	Legacy Command	Description	Query
Reset	CLR	Equivalent to *RST and SYSTem:RESet commands Performs a device reset. Set the power supply to a known state that is independent of the use history of the device	N/A
Query System Error	ERR?	Equivalent to SYSTem:ERRor? command except that the return string contains the command Returns the next error in the instrument's error queue	N/A
Identification Query	ID?	Query identification string. (Model ID and Version)	N/A
Read Output Current	IOUT?	Equivalent to MEASure:CURRent? command Read output current	N/A
Set High Current Limit	IMAX <current>	Equivalent to SOURce:CURRent:LIMit:HIGH <current> command. Set upper limit of current setpoint range (soft limits)	Yes
Set (Immediate) Current Setpoint	ISET <current>	Equivalent to SOURce:CURRent command. Change current setpoint	Yes
Set Output State	OUT <on-off-state>	Equivalent to OUTP <on-of-state> command. Enable/disable the power supply output	Yes
Set Over Voltage Protection Level	OVSET <voltage>	Equivalent to SOURce:VOLTag:e:PROTection:OVER:LEVel <voltage> command. Set the over voltage protection level	Yes
ROM Query	ROM?	Queries the main firmware version	N/A
Clear Output Protection	RST	Equivalent to OUTPut:PROTection:CLEar command. Clears the protection mechanism	N/A
Set High Voltage Limit	VMAX <voltage>	Equivalent to SOURce:VOLTag:e:LIMit:HIGH <voltage> command. Set upper limit of voltage setpoint range (soft limits)	Yes
Read Output Voltage	VOUT?	Equivalent to MEASure:VOLTag:e? command. Read output voltage	N/A
Set (Immediate) Voltage Setpoint	VSET <voltage>	Equivalent to SOURce:VOLTag:e command. Change voltage setpoint	Yes

Notes:

All legacy commands that change a value conform to the same rules as SCPI. Commands will cause an error if the unit's remote source, remote state, current share mode status and calibration status is incorrect.

Legacy commands do not have multichannel capabilities.

Query commands return a string containing the command itself.

The "CLR" command does not clear any legacy fault registers.

The "RST" command only clears the protections so that the voltage and setpoints can take effect. It does not change any setpoint values. When a protection is tripped the unit's output may be turned off (configurable).

Expressions

Table B.16 Expressions

Expression	Details
aux_line_mnemonic	Define the output of the auxiliary line. The possible values are NONE, ON, OFF, OVOLTage, UVOLTage, OCURrent, UCURrent, OPOWER, UPOWER, ACOFF, OTEMPerature, HTEMPertature, SPRotectiOn, UNRegulated, FOLD, CC, CV, CP.
channel	The address for a multichannel slave. An integer value in the range 2 to 50.
codeword	A string representing any 4-digit positive integer.
current	A numeric value as defined by SCPI. May also be <i>MAXimum</i> or <i>MINimum</i> . May include current-related suffix units such as “mA”, “uA”, “A” etc. Range may be 0 to 103% of model’s rated current.
delay	A length of time in the range 0 to 60 seconds. May include time-related suffix units such as “S”, “MIN”, “mS”, “uS” etc. By default, the value is in seconds.
ESE-word	Range 0–255. An 8-bit status mask for the Standard Event Status Register that determines which bits are OR’d to form the ESB bit in the Status Byte Register.
GPIB_address	The address for a GPIB controlled unit. An integer value in the range 1 to 30.
on-off-state	A Boolean indicator of a state. Possible values are <i>ON</i> , <i>OFF</i> , <i>0</i> (off), or <i>1</i> (on).
OVP_level	A numeric value as defined by SCPI. May also be <i>MAXimum</i> or <i>MINimum</i> . May include voltage-related suffix units such as “mV”, “uV”, “V”, etc. Range is 0 to 103% of model’s rated voltage.
power	A numeric value as defined by SCPI. May also be <i>MAXimum</i> or <i>MINimum</i> . May include power-related suffix units such as “mW”, “uW”, “W”, etc. Range is 0 to 101% of model’s rated power.
setting_location	A numeric indication of an internal set of setting registers. An integer value in the range 1 to 10.
sequence_count	Number of times a sequence is to be repeated. Range is 1 to 9999.
sequence_number	The name of an auto sequence program. Range is 1 to 10. The suffix is part of the SEQUENCE command name and is not a parameter.
status-enable	A 16-bit status mask for any condition register that determines which bits are to be used for synthesizing the summary bit of that register.
step_number	The step number of an auto sequence program. Possibly considered a SCPI suffix. Range is 1 to 99.
step_time	The duration of an auto sequence step in the format hh:mm:ss.s. May include time-related suffix units such as “S”, “MIN”, “mS”, “uS”, etc. By default, the value is in seconds.
voltage	A numeric value as defined by SCPI. May also be <i>MAXimum</i> or <i>MINimum</i> . May include voltage-related suffix units such as “mV”, “uV”, “V”, etc. Range is 0 to 103% of model’s rated voltage.

SCPI Command Reference

Expressions

Appendix C. Error Messages

Overview

Errors are placed in a queue as they are detected. The queue works on a first in, first out (FIFO) basis. If the queue overflows, the last error in the queue is replaced with error -350, "Queue Overflow". When all errors have been read from the queue, further error queries return 0, "No error".

The error queue is cleared when any of the following occur (IEEE 488.2, section 11.4.3.4):

- Upon receipt of a *CLS command
- Upon reading the last item from the queue

All negative values are reserved by the SCPI standard. All errors unique to the power supply have positive values.

Command Error List

An error in the range [-199, -100] indicates that an IEEE 488.2 syntax error has been detected by the instrument's parser. The occurrence of any error in this class causes the command error bit (bit 5) in the Event Status Register to be set.

Table C.1 Command Error List

Error code	Error Message Description
-100	Command error This is the generic syntax error.
-105	GET not allowed A Group Execute Trigger was received within a program message.
-114	Header suffix out of range The value of a numeric suffix attached to a program mnemonic is out of range. May refer to multichannel addressing, auto sequence number or auto sequence step number.
-120	Numeric data error This error is generated when parsing a data element which appears to be numeric, including the non-decimal numeric types.
-123	Exponent too large The magnitude of the exponent was larger than 32000.
-151	Invalid string data The data with the enclosed (") double apostrophes (string) is invalid. Possibility of wrong length or character.

Execution Error List

An error in the range [-299, -200] indicates that an error has been detected by the instrument's execution control block. The occurrence of any error in the class causes the execution error bit (bit 4) in the Event Status Register to be set.

Execution errors are reported by the device after rounding and expression evaluation operations have taken place.

Table C.2 Execution Error List

Error code	Error Message Description
-200	Execution error This is the generic error for the power supply.
-203	Command protected Indicates that a legal password-protected program command or query could not be executed because the command was disabled. Check calibration state.

Error code	Error Message Description
-220	Parameter error Indicates that a program data element related error occurred.
-221	Setting conflict Indicates that a legal program data element was parsed but could not be executed due to the current power supply state. Factors that may contribute to this error are: Remote source - To set most values, the remote source must be correct. Remote state - To set most values, the unit must be in remote mode. Calibration mode - when in calibration mode, certain settings will cause as error. Current share mode - When the unit is in current share mode (other than none) certain settings will cause an error.
-222	Data out of range Indicates that a legal command could not be executed because the interpreted value was outside the legal range as defined by the power supply.
-225	Out of memory The power supply has insufficient memory to perform the requested operation.
-231	Data questionable Indicates that measurement accuracy is suspect.
-240	Hardware error (occurs during flash update if there is a failure) Indicates that a legal program command or query could not be executed because of a hardware problem in the power supply.
-241	Hardware missing Indicates that a legal program command or query could not be executed because of missing power supply hardware; e.g. an option not installed.
-282	Illegal program name The name used to reference an auto sequence program was invalid or there is no program selected.
-284	Program currently running Certain operations dealing with auto sequence programs may be illegal while the program is running. For example, deleting a running program is not possible.
-285	Program syntax error There is an error in the program definition.
-290	Memory use error Indicates that a user request has directly or indirectly caused an error related to memory or <data_handle>s. This is not the same as "bad" memory.

Error Messages

Device-Specific Error List

Device-Specific Error List

An error in the range [-399, 300] or [1, 32767] indicates that the instrument has detected an error which is not a command error, a query error, or an execution error; some device operations did not properly complete, possibly due to an abnormal hardware or firmware condition. These codes are also used for self-test response errors. The occurrence of any error in the class causes the device-specific error bit (bit 3) in the Event Status Register to be set.

Table C.3 Device-Specific Error List

Error code	Error Message Description
-300	Device-specific error. Indicates that the power supply could not complete the operation due to some condition of the power supply.
-310	System error. This error is queued when the power supply cannot convert the input to a calibrated value.
-313	Calibration memory lost.
-314	Save/recall memory lost. Indicates that the non-volatile data saved by the *SAV command has been lost.
-315	Configuration memory lost. Indicates that non-volatile configuration data saved by the power supply has been lost.
-321	Out of memory. An internal operation needed more memory than was available.
-330	Self-test failed.
-350	Queue overflow. A specific code entered into the queue in lieu of the code that caused the error. This code indicates that there is no room in the queue and an error occurred but was not recorded.
-360	Communication error. This is the generic communication error for errors which cannot be classified below.
-361	Parity error in program message. Parity bit not correct when data received.
-362	Framing error in program message. A stop bit was not detected when data was received, e.g. a baud rate mismatch.
-363	Input buffer overrun. Software or hardware input buffer on serial port overflows with data caused by improper (or nonexistent) pacing.

Query Error List

An error number in the range [-499, -400] indicates that the output queue control of the instrument has detected a problem with the message exchange protocol described in IEEE 488.2, chapter 6. The occurrence of any error in this class causes the query error bit (bit 2) in the Event Status Register to be set.

Table C.4 Query Error List

Error code	Error Message Description
-400	Query Error This is the generic query error for the power supply, used only when the other types of errors do not apply.
-410	Query INTERRUPTED Generated when a new command was received before it could finish the query.

User Request Event

An error/event in the range [-699, -600] is used when the instrument wishes to report a 488.2 user request event. This event also sets the user request bit (bit 6) of the Standard Event Status Register.

Table C.5 User Request Event

Error code	Error Message Description
-600	User request

Operation Complete Event

An error/event in the range [-899, -800] is used when the instrument wishes to report a 488.2 operation complete event. This event occurs when an instrument's synchronization protocol, having been enabled by an *OPC command, completes all selected pending operations. This event also sets the operation complete bit (bit 0) of the Standard Event Status Register.

Table C.6 Operation Complete Event

Error code	Error Message Description
-800	Operation complete

Error Messages

Front Panel Error Codes

Front Panel Error Codes

Table C.7 Front Panel Error Codes

Error code	Error Message Description
+1301	Front Panel Protocol Error Invalid data from the front panel was sent to the CPU
+1302	Front Panel Not Responding
+1303	Front Panel Self-Test Failed

CPU Error Codes

Table C.8 CPU Error Codes

Error code	Error Message Description
+1401	ColdFire Self-Test Failed

Analog Programming Interface Error codes

Table C.9 Analog Programming Interface Error code

Error code	Error Message Description
+1501	Analog programming self-test failed

Auto Sequencing Error Codes

Table C.10 Auto Sequencing Error Codes

Error code	Error Message Description
+1601	Invalid step number Step does not exist, is out of allowed range or preceding steps do not exist.

CANbus Error Codes

Table C.11 CANbus Error Codes

Error code	Error Message Description
+1701	CANbus hardware missing The CANbus option is not installed on the controller card, or controller card is not present.
+1702	CANbus device specific error An error has occurred on the CANbus circuit. Probable causes are AC input too low, AC input not secure, controller card not securely fastened or other noise sources.
+1703	CANbus input buffer corrupted.
+1704	CANbus input buffer corrupted.
+1705	CANbus input buffer overrun. Data is sent on the CANbus faster than the CPU can process.
+1706	CANbus output buffer overrun. Data cannot be transmitted fast enough.

Multichannel Error Codes

Multichannel functionality is only available with the 6000 Watt power supply.

Table C.12 Multichannel Error Codes

Error code	Error Message Description
+1800	Multichannel general error An error has occurred while sending multichannel commands. One such cause is sending a command that is too long.
+1802	Multichannel address taken The multichannel address configured for this unit has already been assigned to another unit on the CANbus network.
+1803	Multichannel originator not responding The originator of the message is not responding to the handshaking.
+1804	Multichannel recipient not responding The recipient of the message is not acknowledging the reception of the command.
+1805	Multichannel command overwritten A received command through the CANbus has been overwritten.

Error Messages

Current Share Error Codes

Current Share Error Codes

Current share functionality is only available with the 6000 Watt power supply.

Table C.13 Current Share Error Codes

Error code	Error Message Description
+1900	Current Share General Error
+1911	Current share master already online A unit on the CANbus network has already been assigned the current share master unit. Only one is allowed per network.
+1912	Current share slave lost One of the connected current share slaves have not responded in time.
+1921	Current share master lost The assigned master has not responded in time.
+1922	Current share slave connection refused Connection as a slave on the current share network has been refused due to one of the following reasons: 4 slaves are already online, the voltage rating does not match those of the master's, the current rating does not match those of the master's.
+1924	Current share data out of range The voltage or current readback or setpoint values passed are out of range.
+1925	Current share slave output off by unknown One of the slave's output is off because of unknown reasons
+1926	Current share slave output off by command One of the slave's output is off because of a command from a remote source or the front panel.
+1927	Current share slave output off by AC fail One of the slave's output is off because of an AC fail condition.
+1928	Current share slave output off by OTP (Over Temperature Protection) One of the slave's output is off because of an OTP condition.

Appendix D. GPIB

Overview

This power supply can be programmed from a remote terminal using a General Purpose Interface Bus (GPIB) interface. Communications over the GPIB interface meet IEEE 488.2 standards and are SCPI compliant.

Codes and Standards

The GPIB interface of the this Programmable DC Power Supply has been implemented according to IEEE standard 488.1-1987, “IEEE Standard Digital Interface for Programmable Instrumentation.”

The communications protocol complies with IEEE 488.2-1992.

Message Terminators

The GPIB End of message (EOM) terminators can be the END message (EOI), the ASCII code for line feed (LF) or both.

The power supply terminates responses with line feed (LF).

Address Range

Primary Address The power supply will respond to any GPIB address in the range 1 to 30.

Secondary Address The power supply does not support secondary addressing.

Service Request and Polling

The power supply's serial poll responses and SRQ generation use an IEEE 488.2 reporting structure. See “Status Registers” on page 142.

The Request Service bit (bit 6) in the Status Byte will generate a service request (SRQ) on the GPIB.

The power supply can be set up to generate a service request (SRQ) at power-on. Use the command:

```
SYSTem:COMMunicate:GPIB:PONSrq [ON|OFF|1|0]
```

Protocol Specifications

Multiline Control Functions IEEE 488.2 (Section 5) requires specific Device Interface Functions.

Table D.1Multiline Control Functions

Function	Mnemonic	Description	Functions Subset
Source Handshake	SH1	Complete capability	SIDS, SGNS, SDYS, STRS, SWNS, SIWS
Acceptor Handshake	AH1	Complete capability	AIDS, ANRS, ACRS, ACDS, AWNS
Talker	T6	Includes serial poll	TIDS, TADS, TACS, SPAS, SPIS, SPMS, TPIS, TPAS
Listener	L4		LIDS, LADS, LACS, LPIS, LPAS

Interface Functions IEEE 488.1 (Section 2).

Table D.2Interface Functions

Function	Mnemonic	Description	Functions Subset
Device Clear	DC1	Complete capability	DCIS, DCAS
Device Trigger	DT1	Complete capability	DTIS, DTAS
Drivers	E2	Tri state drivers where selectable	
Parallel Poll	PP1	Parallel Poll	
Remote/Local	RL1	Complete capability	LOCS, LWLS, REMS, RWLS
Service Request	SR1	Complete capability	NPRS, SQRS, APRS
Controller	C0	Device does not act as a controller	

Electrical Specifications

Driver Requirements IEEE 488.2 (Section 3.3).

Table D.3 Driver Types for Interface Lines

Signal Line	Driver	Signal Line	Driver
DIO1	Tri State	EOI	Tri State
DIO2	Tri State	DAV	Tri State
DIO3	Tri State	NRFD	Open Collector (mandatory)
DIO4	Tri State	NDAC	Open Collector (mandatory)
DIO5	Tri State	REN	Tri State
DIO6	Tri State	IFC	Tri State
DIO7	Tri State	SRQ	Open Collector (mandatory)
DIO8	Tri State	ATN	Tri State

Driver Specifications for 1 megabyte/second:

- Low State: Output voltage $< +0.5V$ at $+48mA$ sink current
- High State: Output Voltage (3 state) $\geq +2.4V$ at $-5.2mA$

The Output Voltage (open collector) is dependent on the composite Device Load Requirements. The Voltage values are measured at the device connector between the signal line and the logic ground.

Mechanical Specifications

Mechanical Specifications comply with IEEE 488.1 standards.

See Appendix E for details.

Performance Specifications

The power supply responds within 2 ms of receiving a command over the GPIB interface.

GPIB
Performance Specifications

Appendix E. Specifications and Characteristics

Notes

- These specifications are represented over the full operating temperature range.
 - Nominal line input voltage assumed unless otherwise stated.
 - All sense lines are configured for default local operation.
 - All specifications are subject to change without notice.
-

Specifications and Characteristics

Electrical Specifications—Summary

Electrical Specifications—Summary

Table E.1 Specifications for 6000 Watt units (10V to 60V Models)

Models	10-600	20-300	30-200	40-150	60-100
Output Ratings:					
Output Voltage ¹	0–10 V	0–20 V	0–30 V	0–40 V	0–60 V
Output Current ²	0–600 A	0–300 A	0–200 A	0–150 A	0–100 A
Output Power	6000 W	6000 W	6000 W	6000 W	6000 W
Line Regulation: ³					
Voltage (0.01% of Vmax)	1 mV	2 mV	3 mV	4 mV	6 mV
Current (0.05% of Imax)	300 mA	150 mA	100 mA	75 mA	50 mA
Load Regulation: ⁴					
Voltage (0.05% of Vmax + 5 mV)	10 mV	15 mV	20 mV	25 mV	35 mV
Current (0.1% of Imax + 20 mA)	620 mA	320 mA	220 mA	170 mA	120 mA
Meter Accuracy:					
Voltage (0.15% of Vmax)	15 mV	30 mV	45 mV	60 mV	90 mV
Current (0.5% of Imax)	3 A	1.5 A	1.0 A	750 mA	500 mA
Output Noise (0–20 MHz):					
Voltage (p–p)	75 mV	75 mV	75 mV	75 mV	100 mV
Output Ripple (rms):					
Voltage	10 mV	10 mV	12 mV	15 mV	15 mV
Current ⁵	3100 mA	1600 mA	1000 mA	750 mA	450 mA
OVP Adjustment Range: (0% to 103% of Vmax)	0–10.3 V	0–20.6 V	0–30.9 V	0–41.2 V	0–61.8 V
Efficiency: ⁶	0.85	0.87	0.87	0.87	0.89

1. Minimum output voltage is <0.3% of rated voltage at zero output setting.
2. Minimum output current is <0.2% of rated current at zero output setting when measured with rated load resistance.
3. For input voltage variation over the AC input voltage range, with constant rated load.
4. For 0–100% load variation, with constant nominal line voltage.
5. Current mode noise is measured from 10% to 100% of rated output voltage, full current, unit in CC mode.
6. Typical efficiency at nominal input voltage and full output power.

Table E.2 Drift Specifications for 6000 Watt units (10V to 60V Models)

Models	10–600	20–300	30–200	40–150	60–100
Drift (30 minutes): ¹					
Voltage (0.04% of Vmax)	4 mV	8 mV	12 mV	16 mV	24 mV
Current (0.6% of I _{max})	3600 mA	1800 mA	1200 mA	900 mA	600 mA
Drift (8 hours): ²					
Voltage (0.02% of Vmax)	2 mV	4 mV	6 mV	8 mV	12 mV
Current (0.04% of I _{max})	240 mA	120 mA	80 mA	60 mA	40 mA
Temperature Coefficient: ³					
Voltage (0.04% of Vmax/°C)	4 mV	8 mV	12 mV	16 mV	24 mV
Current (0.06% of I _{max} /°C)	360 mA	180 mA	120 mA	90 mA	60 mA

1. Maximum drift over 30 minutes with constant line, load, and temperature, after power on.
2. Maximum drift over 8 hours with constant line, load, and temperature, after 30 minute warm-up.
3. Change in output per °C change in ambient temperature, with constant line and load.

Specifications and Characteristics

Electrical Specifications—Summary

Table E.3 Specifications for 6000 Watt units (80V to 600V Models)

Models	80–75	100–60	150–40	300–20	600–10
Output Ratings:					
Output Voltage ¹	0–80 V	0–100 V	0–150 V	0–300 V	0–600 V
Output Current ²	0–75 A	0–60 A	0–40 A	0–20 A	0–10 A
Output Power	6000 W	6000 W	6000 W	6000 W	6000 W
Line Regulation: ³					
Voltage (0.01% of Vmax)	8 mV	10 mV	15 mV	30 mV	60 mV
Current (0.05% of Imax)	37.5 mA	30 mA	20 mA	10 mA	5 mA
Load Regulation: ⁴					
Voltage (0.05% of Vmax + 5 mV)	45 mV	55 mV	80 mV	155 mV	305 mV
Current (0.1% of Imax + 20 mA)	95 mA	80 mA	60 mA	40 mA	30 mA
Meter Accuracy:					
Voltage (0.15% of Vmax)	120 mV	150 mV	225 mV	450 mV	900 mV
Current (0.5% of Imax)	375 mA	300 mA	200 mA	100 mA	50 mA
Output Noise (0–20 MHz):					
Voltage (p–p)	100 mV	100 mV	150 mV	250 mV	350 mV
Output Ripple (rms):					
Voltage	15 mV	20 mV	20 mV	30 mV	80 mV
Current ⁵	320 mA	230 mA	120 mA	50 mA	25 mA
OVP Adjustment Range: (0% to 110% of Vmax)	0–88 V	0–110 V	0–165 V	0–330 V	0–660 V
Efficiency: ⁶	0.89	0.90	0.90	0.91	0.91

1. Minimum output voltage is <0.3% of rated voltage at zero output setting.
2. Minimum output current is <0.2% of rated current at zero output setting when measured with rated load resistance.
3. For input voltage variation over the AC input voltage range, with constant rated load.
4. For 0–100% load variation, with constant nominal line voltage.
5. Current mode noise is measured from 10% to 100% of rated output voltage, full current, unit in CC mode.
6. Typical efficiency at nominal input voltage and full output power.

Table E.4 Drift Specifications for 6000 Watt units (80V to 600V Models)

Models	80–75	100–60	150–40	300–20	600–10
Drift (30 minutes): ¹					
Voltage (0.04% of Vmax)	32 mV	40 mV	60 mV	120 mV	240 mV
Current (0.6% of I _{max})	450 mA	360 mA	240 mA	120 mA	60 mA
Drift (8 hours): ²					
Voltage (0.02% of Vmax)	16 mV	20 mV	30 mV	60 mV	120 mV
Current (0.04% of I _{max})	30 mA	24 mA	16 mA	8 mA	4 mA
Temperature Coefficient: ³					
Voltage (0.04% of Vmax/°C)	32 mV	40 mV	60 mV	120 mV	240 mV
Current (0.06% of I _{max} /°C)	45 mA	36 mA	24 mA	12 mA	6 mA

1. Maximum drift over 30 minutes with constant line, load, and temperature, after power on.
2. Maximum drift over 8 hours with constant line, load, and temperature, after 30 minute warm-up.
3. Change in output per °C change in ambient temperature, with constant line and load.

Specifications and Characteristics

Electrical Specifications—Summary

Table E.5 Specifications for 12000 Watt units (10V to 60V Models)

Models	10-1200	20-600	30-400	40-300	60-200
Output Ratings:					
Output Voltage ¹	0–10 V	0–20 V	0–30 V	0–40 V	0–60 V
Output Current ²	0–1200 A	0–600 A	0–400 A	0–300 A	0–200 A
Output Power	12000 W	12000 W	12000 W	12000 W	12000 W
Line Regulation: ³					
Voltage (0.01% of Vmax)	1 mV	2 mV	3 mV	4 mV	6 mV
Current (0.1% of I _{max})	1200 mA	600 mA	400 mA	300 mA	200 mA
Load Regulation: ⁴					
Voltage (0.05% of Vmax + 5 mV)	10 mV	15 mV	20 mV	25 mV	35 mV
Current (0.2% of I _{max} + 40 mA)	2440 mA	1240 mA	840 mA	640 mA	440 mA
Meter Accuracy:					
Voltage (0.15% of Vmax)	15 mV	30 mV	45 mV	60 mV	90 mV
Current (0.5% of I _{max})	6 A	3 A	2.0 A	1.5 A	1 A
Output Noise (0–20 MHz):					
Voltage (p–p)	75 mV	75 mV	75 mV	75 mV	100 mV
Output Ripple (rms):					
Voltage	10 mV	10 mV	12 mV	15 mV	15 mV
Current ⁵	6200 mA	3200 mA	2000 mA	1500 mA	900 mA
OVP Adjustment Range: (0% to 103% of Vmax)					
	0–10.3 V	0–20.6 V	0–30.9 V	0–41.2 V	0–61.8 V
Efficiency: ⁶					
	0.85	0.87	0.87	0.87	0.89

1. Minimum output voltage is <0.3% of rated voltage at zero output setting.
2. Minimum output current is <0.2% of rated current at zero output setting when measured with rated load resistance.
3. For input voltage variation over the AC input voltage range, with constant rated load.
4. For 0–100% load variation, with constant nominal line voltage.
5. Current mode noise is measured from 10% to 100% of rated output voltage, full current, unit in CC mode.
6. Typical efficiency at nominal input voltage and full output power.

Table E.6 Drift Specifications for 12000 Watt units (10V to 60V Models)

Models	10–1200	20–600	30–400	40–300	60–200
Drift (30 minutes): ¹					
Voltage (0.04% of Vmax)	4 mV	8 mV	12 mV	16 mV	24 mV
Current (0.6% of Imax)	7200 mA	3600 mA	2400 mA	1800 mA	1200 mA
Drift (8 hours): ²					
Voltage (0.02% of Vmax)	2 mV	4 mV	6 mV	8 mV	12 mV
Current (0.05% of Imax)	600 mA	300 mA	200 mA	150 mA	100 mA
Temperature Coefficient: ³					
Voltage (0.04% of Vmax/°C)	4 mV	8 mV	12 mV	16 mV	24 mV
Current (0.06% of Imax/°C)	720 mA	360 mA	240 mA	180 mA	120 mA

1. Maximum drift over 30 minutes with constant line, load, and temperature, after power on.
2. Maximum drift over 8 hours with constant line, load, and temperature, after 30 minute warm-up.
3. Change in output per °C change in ambient temperature, with constant line and load.

Specifications and Characteristics

Electrical Specifications—Summary

Table E.7 Specifications for 12000 Watt units (80V to 600V Models)

Models	80–150	100–120	150–80	300–40	600–20
Output Ratings:					
Output Voltage ¹	0–80 V	0–100 V	0–150 V	0–300 V	0–600 V
Output Current ²	0–150 A	0–120 A	0–80 A	0–40 A	0–20 A
Output Power	12000 W	12000 W	12000 W	12000 W	12000 W
Line Regulation: ³					
Voltage (0.01% of Vmax)	8 mV	10 mV	15 mV	30 mV	60 mV
Current (0.1% of I _{max})	150 mA	120 mA	80 mA	40 mA	20 mA
Load Regulation: ⁴					
Voltage (0.05% of Vmax + 5 mV)	45 mV	55 mV	80 mV	155 mV	305 mV
Current (0.2% of I _{max} + 40 mA)	340 mA	280 mA	120 mA	100 mA	60 mA
Meter Accuracy:					
Voltage (0.15% of Vmax)	120 mV	150 mV	225 mV	450 mV	900 mV
Current (0.5% of I _{max})	750 mA	600 mA	400 mA	200 mA	100 mA
Output Noise (0–20 MHz):					
Voltage (p–p)	100 mV	100 mV	150 mV	250 mV	350 mV
Output Ripple (rms):					
Voltage ⁵	15 mV	20 mV	20 mV	30 mV	80 mV
Current ⁵	640 mA	460 mA	240 mA	100 mA	50 mA
OVP Adjustment Range: (0% to 110% of Vmax)	0–88 V	0–110 V	0–165 V	0–330 V	0–660 V
Efficiency: ⁶	0.89	0.90	0.90	0.91	0.91

1. Minimum output voltage is <0.3% of rated voltage at zero output setting.
2. Minimum output current is <0.2% of rated current at zero output setting when measured with rated load resistance.
3. For input voltage variation over the AC input voltage range, with constant rated load.
4. For 0–100% load variation, with constant nominal line voltage.
5. Current mode noise is measured from 10% to 100% of rated output voltage, full current, unit in CC mode.
6. Typical efficiency at nominal input voltage and full output power.

Table E.8 Drift Specifications for 12000 Watt units (80V to 600V Models)

Models	80–150	100–120	150–80	300–40	600–20
Drift (30 minutes): ¹					
Voltage (0.04% of Vmax)	32 mV	40 mV	60 mV	120 mV	240 mV
Current (0.6% of I _{max})	900 mA	720 mA	480 mA	240 mA	120 mA
Drift (8 hours): ²					
Voltage (0.02% of Vmax)	16 mV	20 mV	30 mV	60 mV	120 mV
Current (0.05% of I _{max}) ³	75 mA	60 mA	40 mA	20 mA	16 mA
Temperature Coefficient: ⁴					
Voltage (0.04% of Vmax/°C)	32 mV	40 mV	60 mV	120 mV	240 mV
Current (0.06% of I _{max} /°C)	90 mA	72 mA	48 mA	24 mA	12 mA

1. Maximum drift over 30 minutes with constant line, load, and temperature, after power on.
2. Maximum drift over 8 hours with constant line, load, and temperature, after 30 minute warm-up.
3. Current drift for 600V-20A unit is 0.08% of I_{max}.
4. Change in output per °C change in ambient temperature, with constant line and load.

Specifications and Characteristics

AC Line Input Specifications

AC Line Input Specifications

The input to the power supply requires the following specifications.

AC Line Input Voltage Operating Ranges

Table E.9 AC Line Input Specifications

Operating Range	
nominal 208V _{rms} (Standard)	190 to 242 V _{ac} 3 ϕ (3 wire + safety ground)
nominal 400V _{rms} (with HV-Input option)	342 to 500 V _{ac} 3 ϕ (3 wire + safety ground)
Frequency Range	47 to 63 Hz
Maximum Peak In-rush Current at turn on	35 A _{rms} (6000 Watt) 70 A _{rms} (12000 Watt)
Minimum Power Factor ¹	
nominal 208V _{rms} (Standard)	0.95
nominal 400V _{rms} (with HV-Input option)	0.9
Operating Current	
nominal 208V _{rms} (Standard)	
Maximum ²	24 A (6000 Watt) 48 A (12000 Watt)
Typical ³	20 A (6000 Watt) 40 A (12000 Watt)
Operating Current	
nominal 400V _{rms} (with HV-Input option)	
Maximum ⁴	13 A (6000 Watt) 26 A (12000 Watt)
Typical ⁵	11 A (6000 Watt) 22 A (12000 Watt)

1. At nominal input voltage and maximum power
2. At 190V_{ac} input voltage, 55°C ambient temperature and maximum power
3. At 208V_{ac} input voltage, 25°C ambient temperature and maximum power
4. At 342V_{ac} input voltage, 50°C ambient temperature and maximum power
5. At 400V_{ac} input voltage, 25°C ambient temperature and maximum power

Output Performance Specifications

These specifications define the electrical performance specifications of the power supply output. These specifications apply to both local and remote sense configurations, except where noted. These specifications apply to all programming sources, except where noted.

Rated Output Range

Voltage	0–100%
Current	0–100%

Efficiency

- Typical 89% efficiency at nominal line voltage and ambient temperature.
- Minimum 82% efficiency. Specific minimum efficiency limits are model dependent.

Load Regulation

Voltage	5 mV + 0.05% of Vmax
Current	6000 W: 20 mA + 0.1% of Imax 12000 W: 40 mA + 0.2% of Imax
Power	1% of Pmax

Line Regulation

Voltage	0.01% of Vmax
Current	6000 W: 0.05% of Imax 12000 W: 0.1% of Imax
Power	1% of Pmax

Programming Range for Voltage, Current, and Power

Voltage and Current	From 0–103% of the rated maximum output
Power	From 3–103% of the rated maximum output

OVP Programming Range

- 0–103% of maximum rated voltage

Specifications and Characteristics

Output Performance Specifications

Typical Programming Resolution

Front Panel or Remote Digital Interface	
Voltage	0.002% of V_{max}
Current	0.002% of I_{max}
Power	0.05% of P_{max}
Over Voltage Protection	0.002% of V_{max}

Remote Analog Programming Interface	
Voltage	0.002% of V_{max}
Current	0.002% of I_{max}

Typical Measurement Resolution

Front Panel or Remote Digital Interface	
Voltage	0.002% of V_{max}
Current	0.002% of I_{max}
Power	0.05% of P_{max}

Remote Analog Programming Interface	
Voltage	0.002% of V_{max}
Current	0.002% of I_{max}

Programming Accuracy¹

Front Panel or Remote Digital Interface	
Voltage Programming	0.1% of V_{max}
Current Programming	0.5% of I_{max}
Power Programming	0.5% of P_{max}
Over voltage Programming	0.1% of V_{max}

Remote Analog Programming Interface	
Voltage Programming	0.2% of V_{max}
Current Programming	0.5% of I_{max}

Readback Accuracy

Front Panel or Remote Digital Interface	
Voltage Readback	0.15% of V_{max}
Current Readback	0.5% of I_{max}
Power Readback	0.5% of P_{max}

Remote Analog Programming Interface	
Voltage Readback	0.3% of V_{max}
Current Readback	0.5% of I_{max}

1. Accuracy specifications apply for settings in range of 1% to 100% of rated output

30 Minute Drift¹

Voltage	0.04% of Vmax
Current	0.6% of Imax
Power	6000W: 1% of Pmax 12000W: 2% of Pmax

8 Hour Drift Temperature Stability²

Voltage	0.02% of Vmax
Current	6000W: 0.04% of Imax 12000W: 0.05% of imax 12000W 600V model: 0.08% of Imax
Power	0.1% of Pmax

Temperature Coefficients

Front Panel or Remote Digital Interface	
Voltage Programming	0.04% of Vmax/°C
Current Programming	0.06% of Imax/°C
Power Programming	0.1% of Pmax/°C
Voltage Readback	0.04% of Vmax/°C
Current Readback	0.06% of Imax/°C
Power Readback	0.1% of Pmax/°C
Remote Analog Programming Interface	
Voltage Programming	0.04% of Vmax/°C
Current Programming	0.06% of Imax/°C
Voltage Readback	0.04% of Vmax/°C
Current Readback	0.06% of Imax/°C

Analog Programming Interface

Programming Lines, Impedance	
0-5 V _{dc} range	>30 kOhm
0-10 V _{dc} range	>30 kOhm
Readback Lines, Impedance	
0-5 V _{dc} range	<500 Ohm
0-10 V _{dc} range	<1 kOhm
Isolation, all program and readback lines	
300 Vdc with respect to chassis potential or negative output	

1. At 25°C ±5°C, with full power load
2. At 25°C ±5°C after 30 minutes full load operation

Specifications and Characteristics

Output Performance Specifications

User Line Interface

Includes auxiliary status lines, interlock, and external trigger lines.

Maximum Current Sink Capability, Each Output	10 mA
Maximum Supply Voltage	15 V _{dc}
Minimum Supply Voltage	4 V _{dc}
Isolation	300 Vdc with respect to chassis potential or negative output

Switching Frequency

Typical 31 kHz; 62 kHz output ripple

Rise Time

5 to 95% step in output voltage.

Load Condition	Time (Max)
No Load	100 ms
Full Load	100 ms

Fall Time

For a programmed 95% to 5% step in output voltage.

Load Condition	Time (Max)
No Load ¹	3 s
Full Load	50 ms

1. Fall time is ≤ 4 s for 300 V and 600 V units.

Time Delay From Power On Until Output Stable

5 s maximum
(Within regulation envelope)

Time Delay From Output Enable Until Output Stable

2 s maximum
(Within regulation envelope)

Output Hold-Up Time – Power Off

Minimum 4 ms (at full load)

Output Hold-Up Time – Source Interruption

Minimum 4 ms with output deviation less than 5% of maximum output voltage after source interruption.

Transient Response Time¹

Time to recover within 0.75% of rated output of previous level after step change in load current between 50% and 100%.

Mode	Time
Voltage Mode	3 ms (6000 W models)
Voltage Mode	35 ms (12000 W models)

Mode Crossover

Maximum deviation as a percentage of rated output voltage.

CV – CC Overshoot	1%
-------------------	----

Peak–Peak and RMS Noise Bandwidth Limits

The frequency range for Peak to Peak measurements is 10 Hz–20 MHz.

The frequency range for RMS measurements is 10 Hz–100 kHz.

Maximum Remote Sense Line Drop Compensation

Minimum 3.8 V for each line, 5 V typical

Isolation

AC Input to Output	1350 V _{ac}
AC Input to Chassis	1350 V _{ac}
Output to Chassis	600 V _{ac}

1. Time for the output voltage to recover within 0.75% of rated output of its previous level after a step change in load current of up to 50% - 100% and 100% to 50% of rated output

Specifications and Characteristics

Environmental Specification

Environmental Specification

Operating Altitude	Up to 6,500 feet (2,000 m)
Storage Altitude	Up to 50,000 feet (15,000 m)
Installation Category	II (IEC 1010-1)
Polution Degree	2 (IEC 1010-1)

Thermal Specification

Operating Temperature Range	0°C–50°C ¹
Storage Temperature Range	–40°C–+85°C

1. Consult the factory for operation below 0°C and above 50°C.

Humidity Specification

Operating Humidity Range	< 95% RH, Non-condensing
Storage Humidity Range	< 95% RH, Non-condensing

International Approvals

CE-marked units meet: EN61010-1, EN50081-2 and EN500082-2.

CSA C/US certified to C22.2 No 1010.1 and UL3111-1.

Meets USA EMC standard: FCC, part 15, class A.

Meets Canadian EMC standard: ICES-001.

Mechanical Specification

Weight 6000 W: approx. 75 lb. (34 kg) for 10 V-600 A unit, without packaging
12000 W: approx. 170 lb. (77 kg) for 10 V-1200 A unit, without packaging

Size

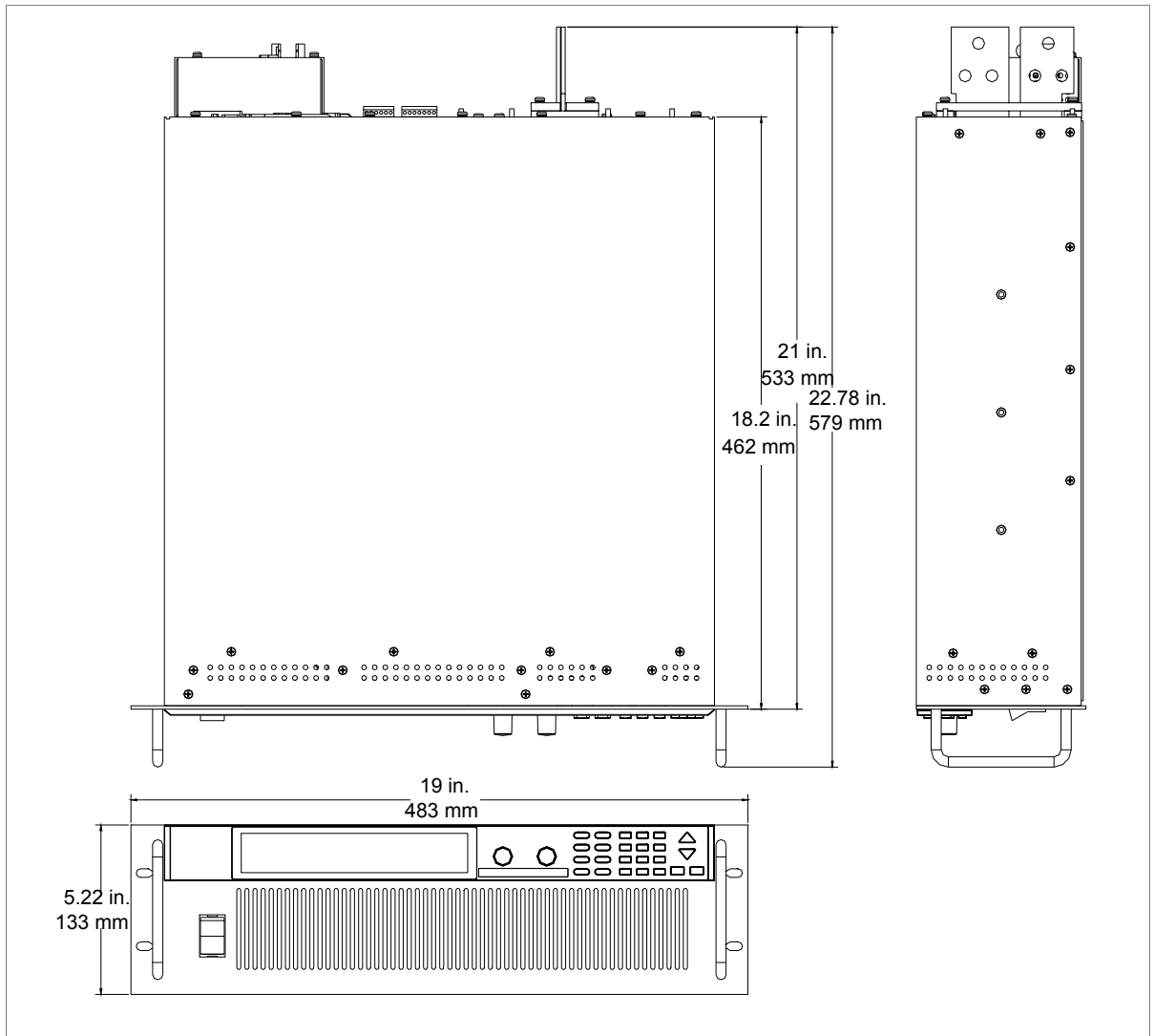

Figure E.1 Power Supply Dimensions (6000 Watt unit)

Specifications and Characteristics

Mechanical Specification

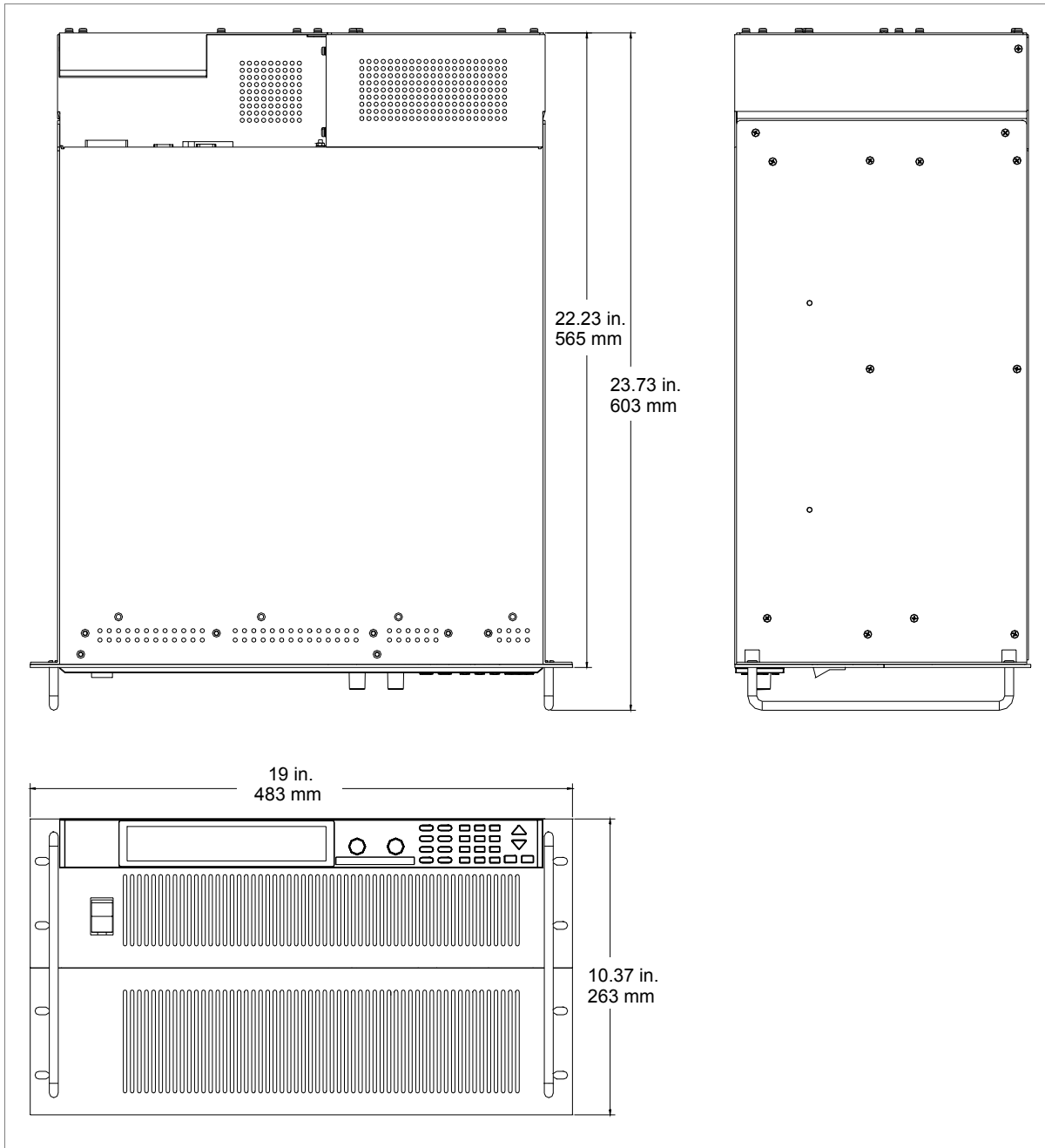

Figure E.2 Power Supply Dimensions (12000 Watt unit)

Index

A

- AC input connector 30, 40
- AC input power 40
- AC input wires
 - connecting 41, 43
 - illustrated 42, 44
 - specification 41
- AC off
 - auto-recovery 71
- active power factor correction 21
- ADR display annunciator 29
- air intake vents 23
- ALARM display annunciator 29
- ALARM key 25
- alarms 72
- analog control mode described 31
- analog programming
 - connections 108
 - pins 109
 - using 112
- analog programming lines 107
- approvals
 - Canadian EMC Requirements viii
 - CSA viii
 - FCC viii
 - UL viii
- AUTO display annunciator 29
- AUTO SEQ (menu option) 87
- AUTO SEQ PGM (menu item) 62, 87
- auto sequencing 136
 - deleting a sequence 91, 94, 139
 - editing a sequence step 92
 - function keys 97
 - inserting a sequence step 93
 - operation 137, 140
 - operation via front panel 97
 - programming a sequence 88, 138
 - recalling 97
 - repetitions 95, 138
 - running a program 97
 - trigger source 96, 139

- automatic mode crossover 59
- AUX A display annunciator 29
- AUX B display annunciator 29
- auxiliary 134

B

- bar graph
 - current 28
 - power 28
 - voltage 28
- bar graphs display annunciator 29

C

- calibration
 - change code 181
 - front panel procedure 183
 - mode 179
 - overview 179
 - remote interface procedure 187
 - restore factory defaults 192
- CALIBRATION (menu item) 63
- calibration operating state 58
- Canadian EMC Requirements viii
- CANbus 113
- CANbus port 30
- CC display annunciator 29
- CE key 25
- command errors, list of 216
- constant current (CC) mode 59
- constant power (CP) mode 59
- constant voltage (CV) mode 59
- control knobs
 - locking out voltage 99
 - locking out voltage and current 98
 - unlocking 99
- control modes 31
 - analog mode described 31
 - GPIB mode described 31
 - local mode described 31
 - multichannel mode described 31
 - RS-232 mode described 31

Index

- control options
 - configuring remote control source 76
 - described 21
 - GPIB 21
 - remote vs local 74
 - RS-232 21
 - SCPI 21
 - selecting remote control source 75
- CP display annunciator 29
- CSA approval viii
- current bar graph 28
- current carrying capacity for load wiring 48
- CURRENT key 24, 61
- current knob
 - described 24, 63
 - illustrated 23
- current limit, setting 101
- current mode operation test 47
- current output setpoint, setting 64
- current share
 - configure 174
 - errors 176
 - operation 176
 - overview 173
 - setup 175
 - specifications 177
- CURRENT SHARE (menu item) 62
- current sharing 30
- CV display annunciator 29

D

- DC output 30
- decimal key, described 25
- defaults
 - configuring power on 123
 - saving 127
- device-specific errors, list of 218
- digital processing 21
- display
 - defaults 104
- display annunciators
 - ADR 29
 - ALARM 29
 - AUTO 29
 - AUX A 29

- AUX B 29
- bar graphs 29
- CC 29
- CP 29
- CV 29
- ERR 29
- illustrated 28
- Interlock 29
- LCL 29
- Master 29
- OTP 29
- OUT OFF 29
- OUT ON 29
- OVP 29
- Pause 29
- RMT 29
- SEQ 29
- Set 29
- Slave 29
- SRQ 29
- Trigger? 29
- DISPLAY CFG (menu item) 62, 98
- display test 45
- down arrow key 25

E

- END key 24
- ENTER key 25
- ERR display annunciator 29
- error messages 135
 - For individual error codes and error message descriptions, see Appendix E. 215
 - command errors 216
 - device-specific errors 218
 - execution errors 216
 - operation complete event 219
 - query errors 219
 - reading 81, 135
 - user request event 219
- ERROR MSGS (menu item) 62
- execution errors, list of 216
- exhaust fan 30
- exhaust vents 30
- EXIT key 25, 62

F

factory default settings 31
 FCC compliance viii
 fold protection
 options 70, 132
 setting 71
 front panel controls 61
 front panel, illustrated 22, 28
 function keys
 ALARM 25
 CE 25
 CURRENT 24, 61
 ENTER 25
 EXIT 25, 62
 LCL/RMT 24, 61
 MENU 25
 OUT ON/OFF 24, 61
 PROT SET 25, 62
 RECALL 25, 62
 STORE 24, 61
 VOLTAGE 24, 61

G

General Purpose Interface Bus. See GPIB.

GPIB

configuration 121
 connection 120
 electrical specifications 225
 location 107
 mechanical specifications 225
 performance specifications 225
 protocol specifications 224
 using 122
 GPIB control mode described 31
 GPIB port 30
 ground screw 30

I

identification 142
 IEC viii
 IEC symbols
 Caution vii
 Earth (Ground) Terminal vii
 Off (supply) vii

On (supply) vii

Protective Conductor Terminal vii

Warning (Shock Hazard) vii

incorrect code 180

information about your power supply 104, 142

input connector 40

input power 40

input wires

 connecting 45

 recommended size 41

 specifications 41, 42, 44

installation

 AC input power 40

 connecting multiple loads 52

 connecting single load 51

 inspecting the power supply 34

 load wiring 48

 location 37

 mounting 37

 rack mounting 37

 tests 45

 ventilation requirements 39

Interlock display annunciator 29

K

keypad, illustrated 23, 24

KNOB LOCKOUT (menu item) 63, 98

L

LCL display annunciator 29

LCL/RMT key 24, 61

limits, changing setpoint 100

load connections

 illustrated 52

 wire size 50

load wiring

 current carrying capacity 48

 length 49

 noise and impedance 49

local control mode, described 31

local lockout 128

local mode

 changing 128

locking out voltage and current knobs 98

Index

M

maintenance 34

Master display annunciator 29

menu

navigation 62

menu items

AUTO SEQ PGM 62

CALIBRATION 63

CURRENT SHARE 62

DISPLAY CFG 62

ERROR MSGS 62

KNOB LOCKOUT 63

MODEL INFO 63

PON CONFIG 62

POWER SETPT 62

REMOTE CONFIG 62

REMOTE SELECT 62

S/D RECOVERY 62

SETPT LIMIT 63

SLEW RATE 63

USER LINES 62

MENU key 25

MODEL INFO (menu item) 63, 104

model information, viewing 104

multichannel

commands 116

configuration 114

connections 21, 113

control mode described 31

operation 30, 115

setup 114

multiple loads, connecting 52

N

noise and impedance on lines 49

normal operation operating state 58

numeric keypad, described 25

O

On/Off switch 23

operating states

calibration 58

normal operation 58

output shutdown 58

power-on 58

soft start 58

operation

control modes 31

overview 31

power on 31

operation (local control mode) 57

powering off 58

powering on 57

operation complete event error 219

OTP display annunciator 29

OUT OFF display annunciator 29

OUT ON display annunciator 29

OUT ON/OFF key 24, 61

output

enabling 128

setting current 64

setting power 65

output shutdown operating state 58

output wires

fastening 52

illustrated 52

over-temperature protection

auto-recovery 71

latched 71

OVP display annunciator 29

P

Pause display annunciator 29, 97

PON CONFIG (menu item) 62

power bar graph 28

power limit, setting 102

power on 31

power on settings

auto sequence 87

configuring 84

factory preset 85

last setting 86

user setting 86

power on test 46

power output setpoint 65

power output, viewing 104

POWER SETPT (menu item) 62

powering off 58

powering on 57

power-on operating state 58
 programming capability 22
 PROT SET key 25, 62
 protection 65

- AC off 133
- clearing 134
- fold 70, 132
- over current (OCP) 68, 130
- over power (OPP) 69, 131
- over temperature (OTP) 133
- over voltage (OVP) 67, 130
- shutdown recovery 71
- under current (UCP) 69, 131
- under power (UPP) 70, 131
- under voltage (UVP) 68, 130

Q

query errors, list of 219

R

rack mounting

- illustrated 39
- procedure 37

 readback

- configure display 98
- default display 104

 readback capability 22
 rear panel

- described 30
- illustrated 30

 RECALL key 25, 62
 recall memory options

- auto sequence 79
- factory preset 79
- last setting 79
- user settings 79

 regulation modes

- automatic mode crossover 59
- constant current 59
- constant power 59
- constant voltage 59

 REMOTE CONFIG (menu item) 62
 remote control

- configuring remote control source 76

- selecting source 75

 remote control modes, described 60
 remote control vs local control 74
 remote mode

- changing 128

 REMOTE SELECT (menu item) 62
 remote sensing 56
 remote sensing ports 30
 reset 125
 RMT display annunciator 29
 RS-232

- configuration 118
- connection 118
- location 107
- using 119

 RS-232 control mode described 31
 RS-232 port 30
 RUN/PAUSE key 24

S

S/D RECOVERY (menu item) 62
 SCPI

- version 142

 SCPI commands 123

- for specific items, see the Table of Contents at the beginning of Appendix B.
- parameter types 197
- using 195

 security code 181
 self-tests

- current mode operation test 47
- display test 45
- equipment required 45
- power on test 46
- voltage mode operation test 46

 sense protection 66
 SEQ display annunciator 29
 Set display annunciator 29
 setpoints

- changing 128
- soft limits 100, 129

 SETPT LIMIT (menu item) 63, 100
 settings

- factory default 31
- power on 84

Index

- recall 79, 127
 - user 77, 127
- shutdown recovery 71
- single load, connecting 51
- Slave display annunciator 29
- slew rate
 - overview 102
 - programming via SCPI 141
 - setting 103
- SLEW RATE (menu item) 63
- soft start operating state 58
- soft switching power 21
- specifications
 - electrical 228
 - environmental 242
 - For a more detailed list of specification items, see the Table of Contents at the beginning of Appendix E. 227
- SRQ display annunciator 29
- Standard Commands for Programmable Instruments.
 - See SCPI commands.
- status conditions, listed 83
- status register 142
 - commands 157
 - condition 142
 - current 152
 - current share 148
 - enable 143
 - event 142
 - power 152
 - questionable 149
 - remote control 147
 - standard event 153
 - status byte 155
 - temperature 153
 - transition filters 143
 - voltage 152
- STORE key 24, 61

T

- terminal blocks 30
- TRIGGER key 24
- Trigger? display annunciator 29, 97
- triggering 136
 - auto sequence 90, 96, 139
 - external input 108
 - setpoints 129
 - sources 136

U

- UL approval viii
- unlocking control knobs 99
- up arrow key 25
- user lines 83, 107, 109
 - Also see triggering interlock auxiliary status lines
- USER LINES (menu item) 62
- user request event error 219
- user settings
 - changing 78
 - recalling settings 79
 - storing 77

V

- vacuum fluorescent display 22, 23
- ventilation 39
- VIEW MODEL INFO (menu item) 104
- voltage bar graph 28
- VOLTAGE key 24, 61
- voltage knob
 - described 24, 63
 - illustrated 23
 - locking out 99
- voltage limit
 - setting 100, 129
- voltage mode operation test 46

W

- wire specification (AC) 41

Xantrex Technology Inc.

8999 Nelson Way
Burnaby, British Columbia
Canada V5A 4B5

604 422 8595 Tel
604 421 3056 Fax
800 667 8422 Toll Free North America

prg.info@xantrex.com
www.xantrex.com