



Advanced Test Equipment Corp.  
www.atecorp.com 800-404-ATEC (2832)



**narda**   
Safety Test Solutions

Safety in electromagnetic fields up to 90 GHz



**FieldMan**®

**Narda Electromagnetic  
Field Meter**

Narda has opened up new dimensions in the versatility and handling of electromagnetic field measuring devices with the FieldMan. This light, easy to use instrument can be operated with various probes to provide reliable, omnidirectional measurements from 0 Hz (DC) up to 90 GHz.

The successor to the established NBM-500 series, FieldMan captures high and low frequency electric and magnetic fields, delivering meaningful and authoritative results from precise, reproducible measurements.



**Advantages of the Narda FieldMan:**

- ▶ Wide measurement range from 0 Hz (DC) to 90 GHz
- ▶ Digital probe interface: no calibration of the measuring device required, only the probe is calibrated
- ▶ Anti-glare, brilliant color display with automatic brightness adjustment can easily be read even in poor lighting conditions or intense sunlight
- ▶ Sensors measure temperature, air humidity, pressure and height above ground
- ▶ Rapid data transmission using various interfaces

The high degree of user friendliness of the FieldMan is in the details: An intuitive operating menu, built-in climate sensors, and the distance meter make everyday measurements much easier to make.

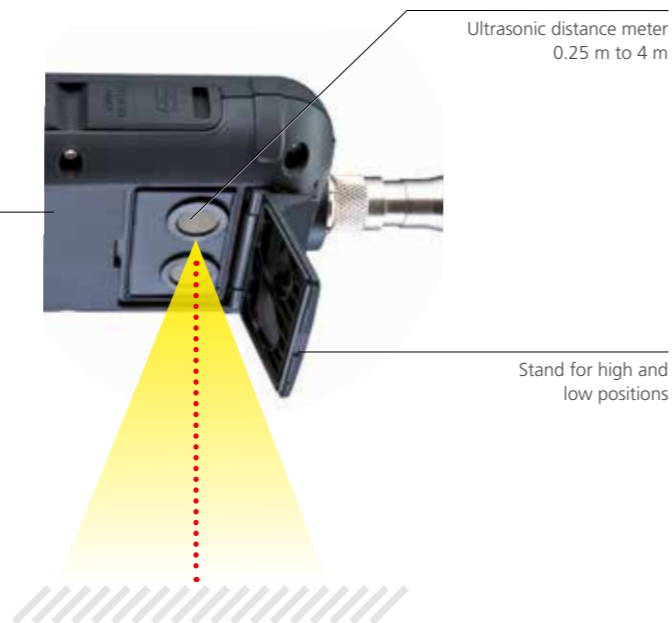

Ultrasonic distance meter  
0.25 m to 4 m

Stand for high and  
low positions

The clever device stand protects the probes from mechanical stresses when placed on a flat surface. The stand can be set to different heights to suit the probe type.

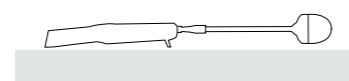

Low position for smaller probes

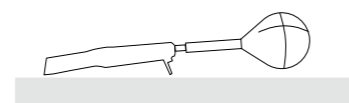

High position for larger probes

Ergonomically shaped handle  
for one hand operation



Probe connector

Brightness sensor

Status LED

Microphone,  
Humidity sensor

5" color display  
(HD 1280 x 720 pixels)

Isotropic measurement

Individual axis measurements

Statistical measurements  
Min / Max / Average

Measured value graph: Time  
response, spectrum, or bar graph



On / Off

Back button

Loudspeaker

Status bar

Probe information

Measured value information



Interface slot  
- USB-C  
- RP-02 (optical)  
- μSD (memory card)  
- Ethernet

Function key icons

Function keys

Save button

Navigator button

Pleasant feel and comfortable operation thanks to raised keys with a distinct click point. The long operating time of up to 16 hours when using broadband probes is outstanding. The powerful Lithium-ion battery supplied with the device is exchangeable.

Shown actual size

Its compact, handy design and simple operation make the FieldMan the ideal instrument for on-site applications. The sturdy casing and rugged probes ensure reliable results even under adverse weather conditions thanks to IP 54 class protection.

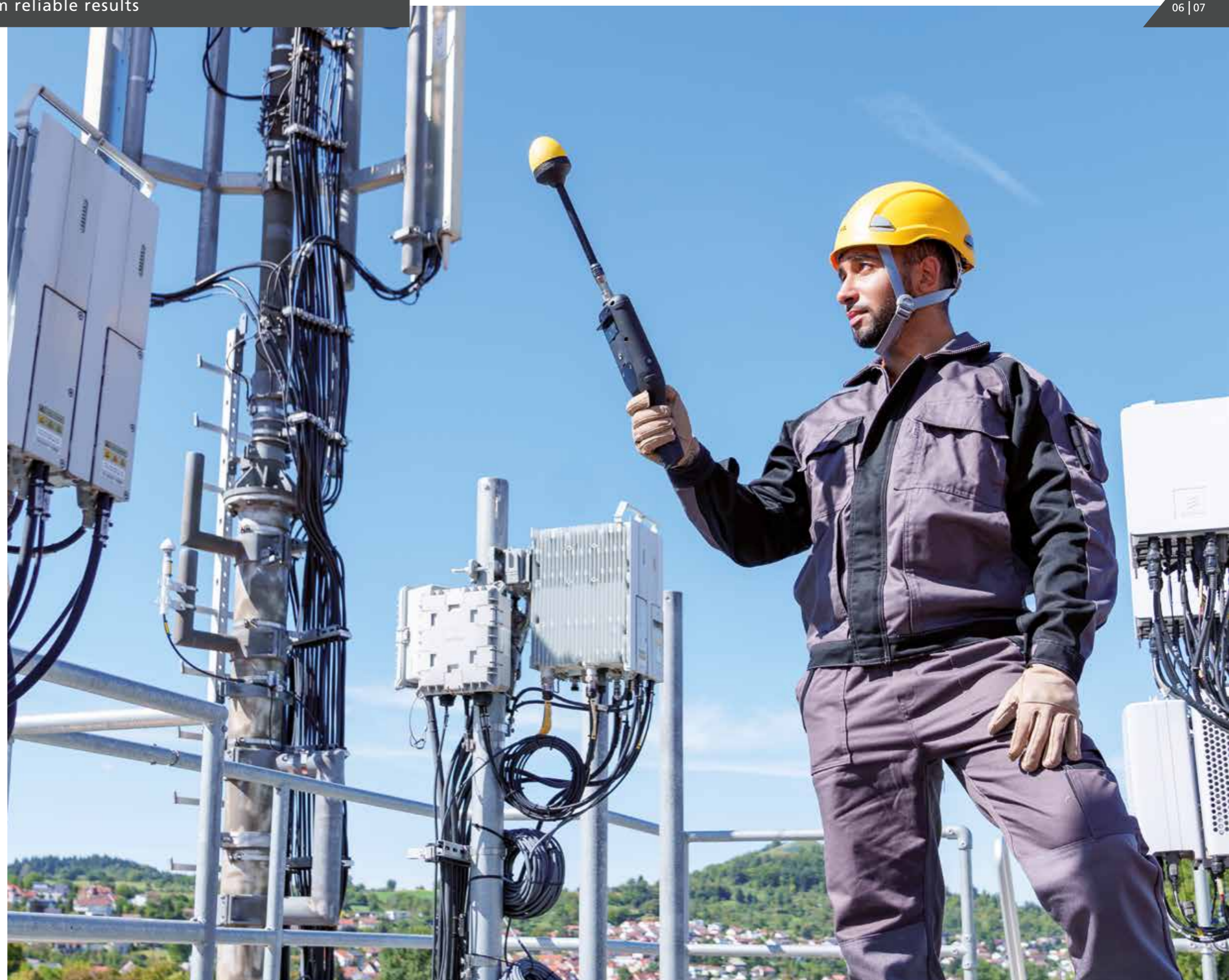

→ The FieldMan also shows its strengths during everyday use with its various storage and readout facilities. A Micro SD card makes it super easy to personalize. The optional WiFi / Bluetooth interface enables remote control using the smartphone app.



The capability for using a wide range of different probes means that the FieldMan covers the entire frequency band from 0 Hz (DC) up to 90 GHz. This means that the range of applications runs from the analysis of low frequency fields in the industrial environment right through to high frequency measurements on mobile radio antennas, transmitter equipment, and radar installations.

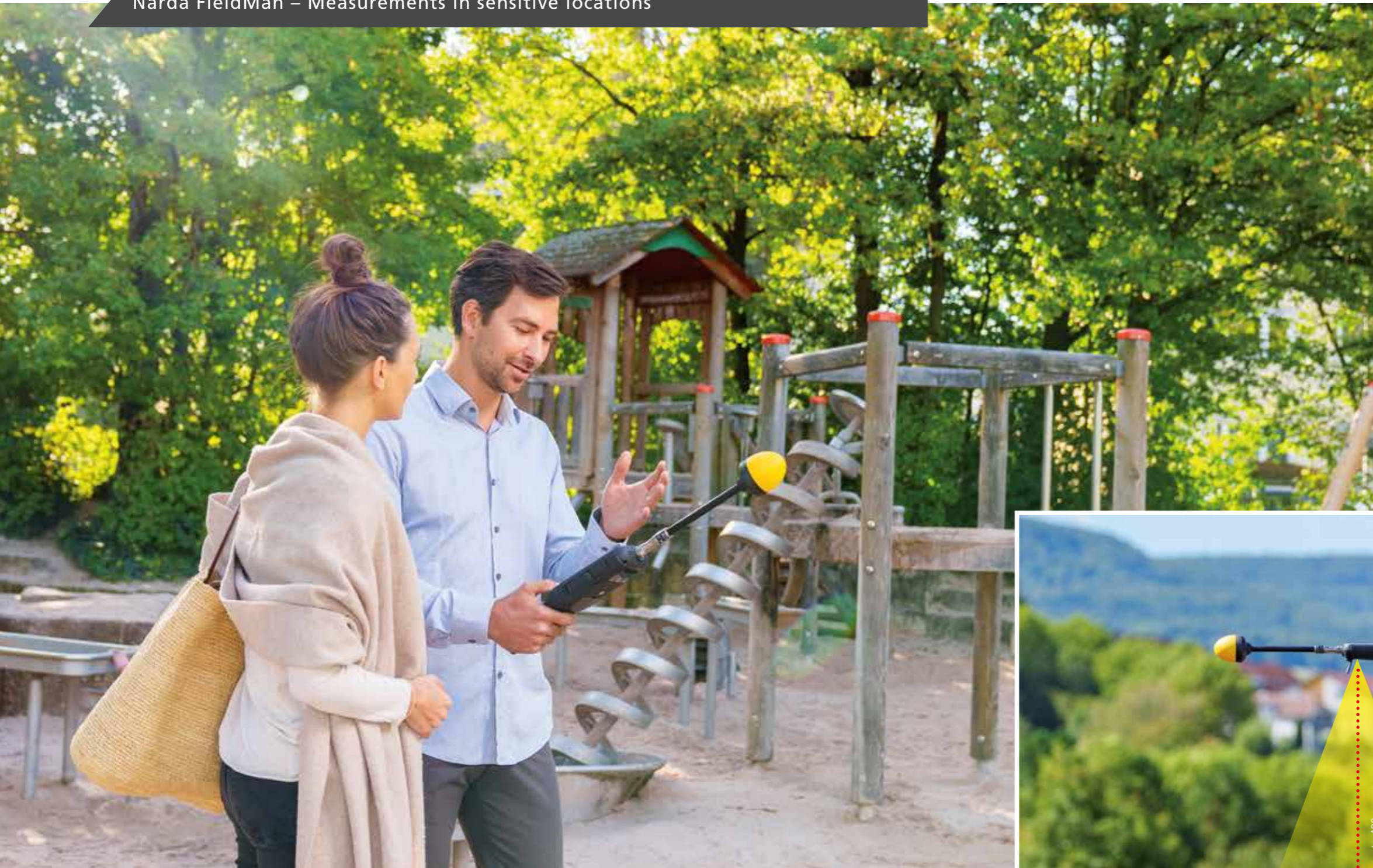

Cellphones, power supplies, machinery... electric, magnetic and electromagnetic fields are found everywhere in the human environment. High and low frequency fields are considered separately. But, regardless of which frequencies are being emitted, soundly based measurements are the foundation for ensuring that limit values are adhered to, and that the safety of those working on or near antennas as well as of the general public is protected.

With its broad measurement range, the Narda FieldMan covers all the bases when it comes to capturing the frequency spectrum that is present, and it is sensitive enough to measure even low field strengths from a greater distance.

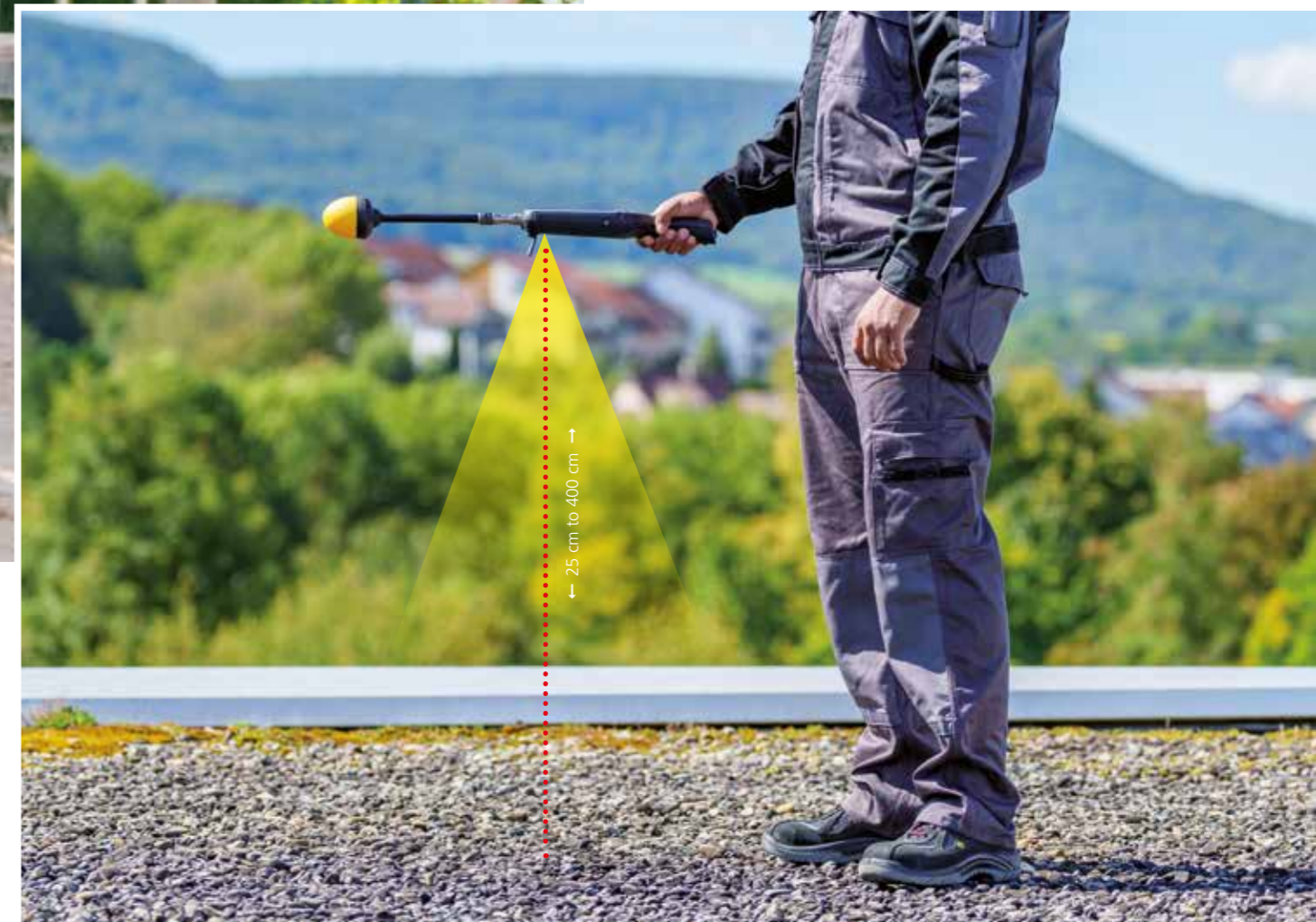

↑ The thermal effects of electromagnetic fields on the human body have been demonstrated scientifically. And, we are surrounded almost everywhere by electromagnetic fields. Just as with other environmental pollution, there are limit values here too, that must not be exceeded. Sensitive locations such as kindergartens and schools will therefore often need to be surveyed separately in order to compile exposure level statistics.



→ The ultrasonic distance meter precisely measures the height above ground where the FieldMan is being operated. The measurement is accurate to within one centimeter, with a capture angle of 15 degrees and a range of 25 cm to 400 cm. The measurement units can be set to meters, inches, feet or yards. Separate measurement with a ruler is therefore no longer necessary.

It is not just transmitting equipment that emits electromagnetic radiation. Electric or magnetic fields occur everywhere that voltages are present or currents flow. Such sources of danger are often found in industrial production areas. Employers are obligated to protect all affected persons from any effects that may be hazardous to health. Safe distances from equipment emitting radiation must be determined, access restricted, and other safety measures implemented. This often requires the measurement of the field exposure level and its evaluation in accordance with current workplace safety standards.



Unlike electric fields, magnetic fields are not easily shielded. The new H field probes from Narda measure magnetic fields omnidirectionally and can easily be precisely positioned, thanks to the geometric arrangement of their coils.

High intensity pulsed magnetic fields occur very close to welding equipment. These fields can be precisely detected and evaluated with the aid of the Narda H field probes.



Processing of the recorded measurement data is supported by numerous features, which together with many additional functions allow comprehensive evaluation and analysis to be performed. For example, the status bar is configured similar to a smartphone, which makes operation easier and prevents mistakes. Also, standardized and self-explanatory softkey labels and a navigation button make for faster operation.

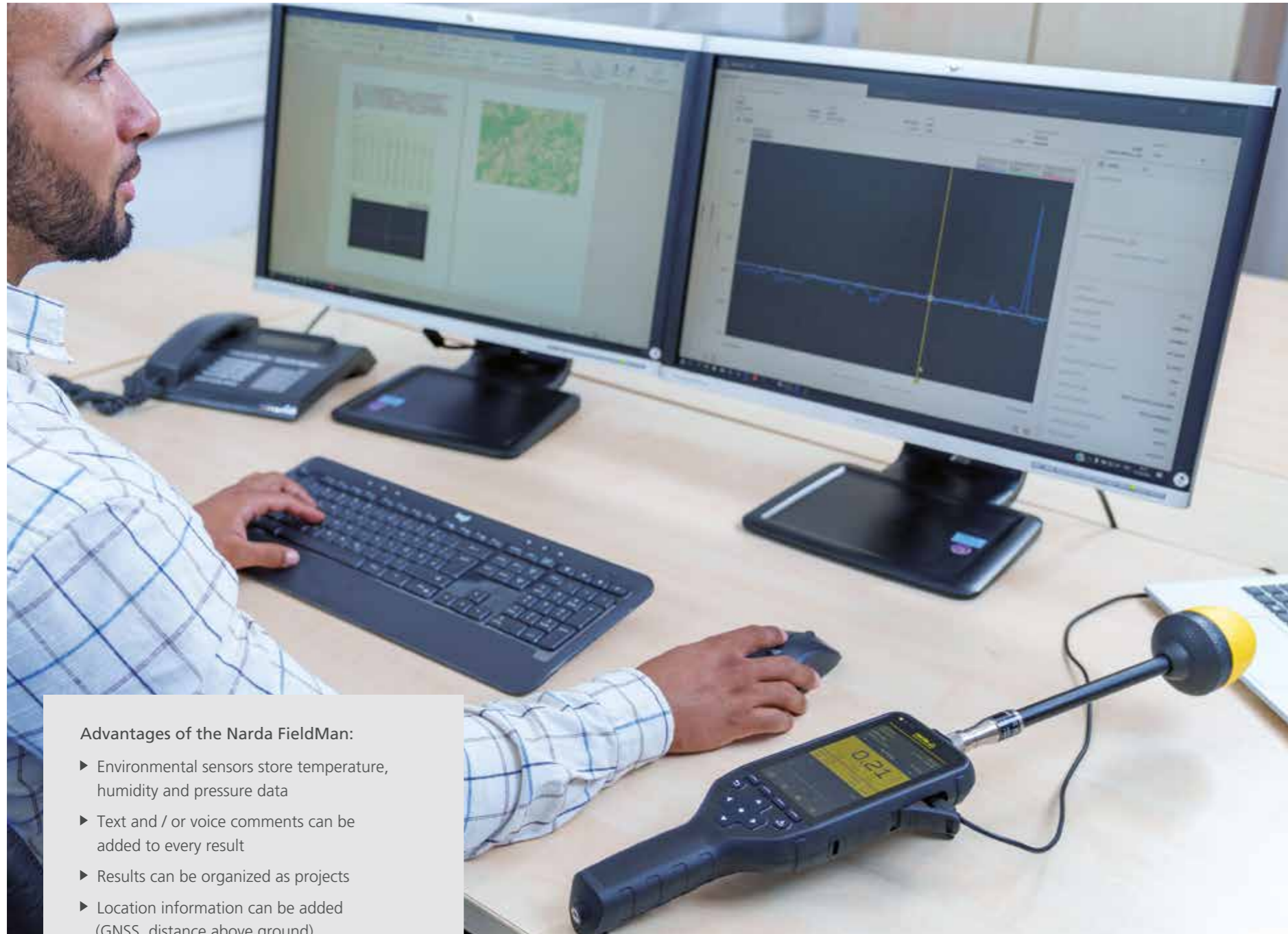

↑ The WiFi / Bluetooth interface enables remote control of the FieldMan via the optional smartphone app. In this way, you can create photos and videos that can be added to the measurement data.

### Advantages of the Narda FieldMan:

- ▶ Environmental sensors store temperature, humidity and pressure data
- ▶ Text and / or voice comments can be added to every result
- ▶ Results can be organized as projects
- ▶ Location information can be added (GNSS, distance above ground)
- ▶ Photos and videos can be added
- ▶ Interface with USB-C, optical RP-02, microSD card and Gigabit Ethernet

### Narda-TSX PC software included

The FieldMan and other Narda products work with Narda-TSX, the new software platform with a common user interface. The modern, easy to understand user interface includes uncomplicated data management, comprehensive result evaluation, and creation of test reports along with many other features. Narda-TSX is available as a free download from the Internet.

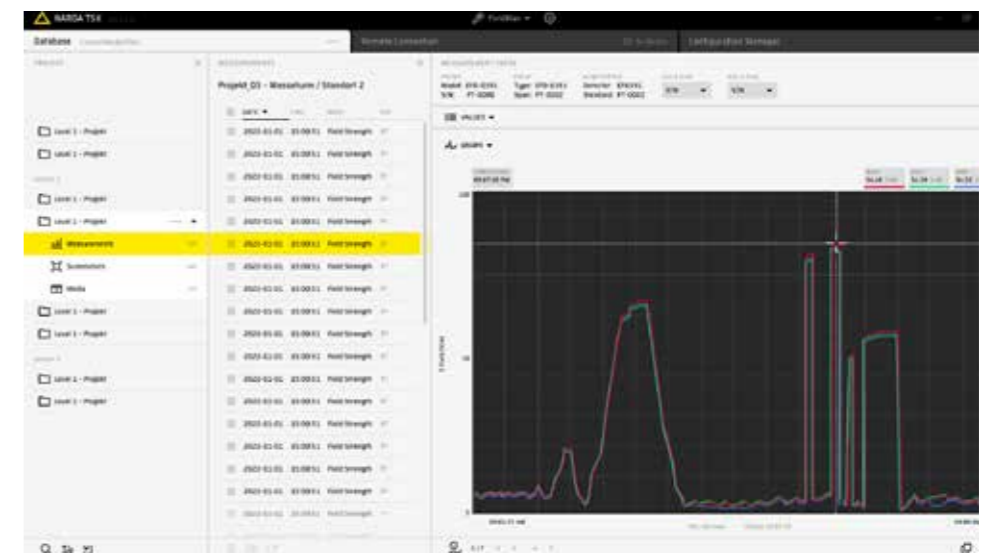



The Narda FieldMan can be equipped with probes that cover practically every application in the frequency range from 0 Hz (DC) up to 90 GHz. Alongside the tried and tested E field and H field probes for broadband detection of field strengths in the long wave to microwave frequency range, there are now two new B field probes available to users for the separate measurement of magnetic field components. The BFD-400-1 and BFD-400-3 digital probes measure omnidirectionally and can be positioned easily, thanks to their geometrically arranged coils. Accredited probe calibration and integrated probe and sensor testing ensure the highest accuracy and reliability regardless of the frequency range.

The FieldMan is distinguished by its low operating costs as well as by high dependability and reliability. For example, the basic unit does not require calibration. This means that test and measurement service providers can keep on measuring even if one of the probes is being calibrated. Further advantages are the identical connectors / interfaces for LF and HF probes and an integrated probe and sensor test for greater reliability.



**Narda FieldMan operating modes**

**Field Strength**

Broadband field measurements. Numerical results with time curve or bar graph

**Spatial Average**

Method for determining the spatial average of broadband measurements from several positions

**Timer Logging**

Timer controlled broadband field strength measurement over a defined time period

**Additionally, with LF probes:**

**Spectrum**

FFT analysis with spectrum display, marker evaluation, and broadband level indicator

**Shaped Time Domain**

Time domain evaluation (WPM = weighted peak method, WRM = weighted RMS method) with digital filtering referenced to a selected human safety standard

**Scope**

Triggered measurement of the field versus time characteristic with pre-trigger function (also displays the trace prior to the trigger event)

**Advantages:**

- ▶ Only one basic unit required, which can be used with all the probes
- ▶ Automatic offset adjustment without interrupting measurements
- ▶ Built-in probe and sensor testing for greater reliability
- ▶ Triggered scope function for transient signals
- ▶ Spectrum with powerful real-time analysis for uninterrupted measurements
- ▶ Time domain WPM and WRM for all relevant standards: 2013/35/EU, IEC/EN 62311, ICNIRP 1998, ICNIRP 2010, IEC/EN 62233, GB-8702-2014, EMFV 2016
- ▶ Rapid data streaming to PC and direct connection to a measuring computer or test system via a USB connector (via optical repeater for high frequency probes)



Five different colored, easy to exchange rings can be used as visual markers to quickly distinguish between different probes

**Digitale NF probe BFD-400-1**

with 100 cm<sup>2</sup> sensor area. Can be used directly on the measuring device or connected via a probe extension cable. The coil geometry is clearly visible.

**Digitale HF probe EFD-0691**

with extended temperature range from -20 °C to +50 °C. Low temperature dependency thanks to compensation from built in temperature sensors.

Reliable omnidirectional measurements of high and low frequency electric and magnetic fields in the range from 0 Hz (DC) up to 90 GHz.

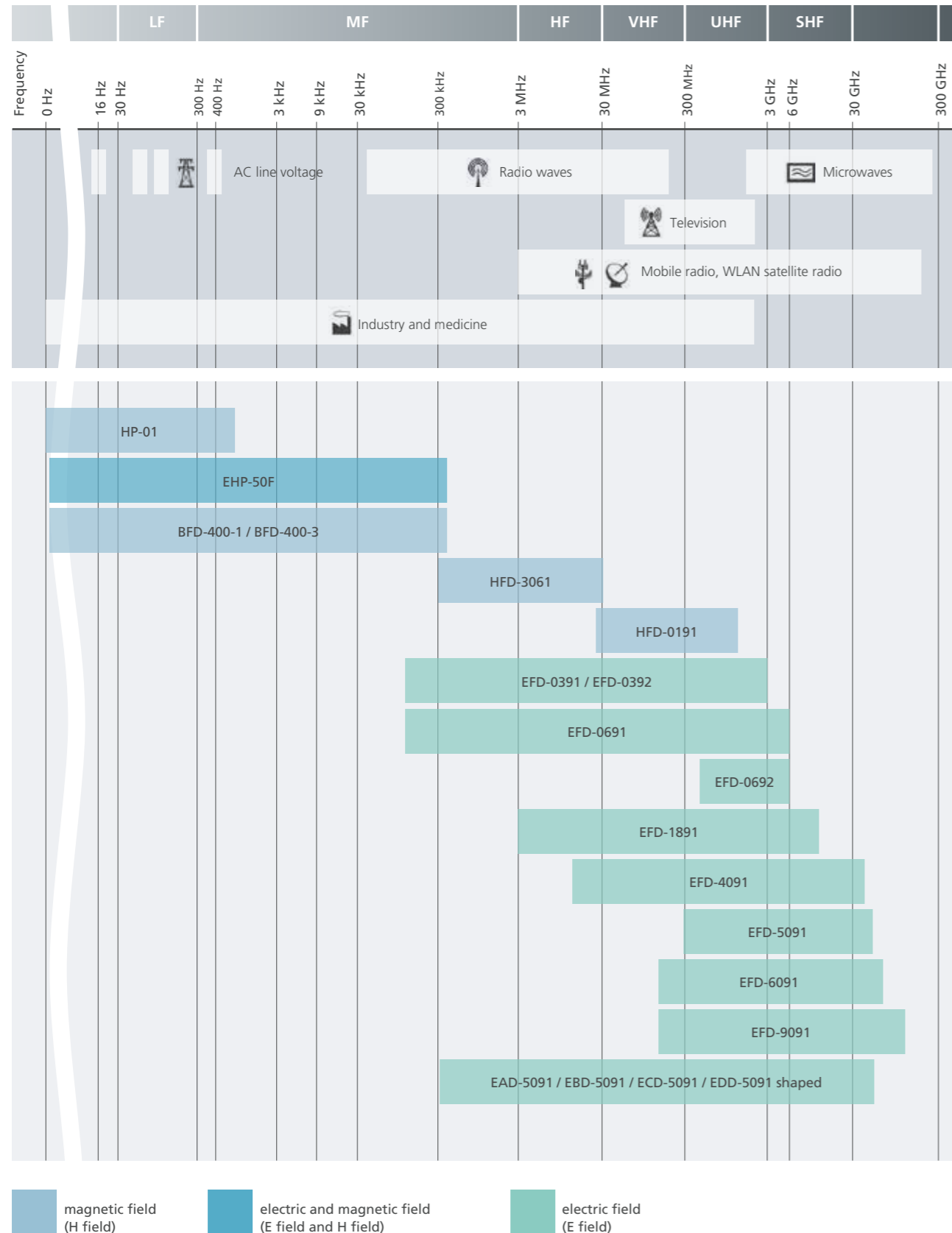

All probes are recognized automatically when connected to the FieldMan. The automatic self test function will detect any possible fault in the sensor system, eliminating the need for checking with a separate test generator.

Type name	HP-01	EHP-50F	BFD-400-1 (100 cm <sup>2</sup> ) BFD-400-3 (3 cm <sup>2</sup> )	HFD-3061	HFD-0191	EFD-0391 EFD-0392 EFD-0691 EFD-0692	EFD-1891 EFD-4091	EFD-5091 EFD-6091 EFD-9091	EAD-5091 EBD-5091 ECD-5091 EDD-5091	
Frequency range	DC to 1 kHz	up to 400 kHz	up to 400 kHz	up to 30 MHz	up to 1 GHz	up to 6 GHz	up to 40 GHz	up to 90 GHz	up to 50 GHz	
Field type: Magnetic (H), electric (E)	H	E+H	H	H	H	E	E	E	E shaped	
Spectrum (FFT)	●	●	●							
5G mobile radio / telecommunications				●	●	●	●	●	●	
Broadcast radio / TV				●	●	●	●		●	
Satellite communications							●	●	●	
Radar							●	●	●	
Industry: Heating and tempering				●		●				
Industry: Plastics welding				●		●				
Industry: Semiconductor production				●		●				
Medicine: Diathermy, hyperthermy						●			●	
Leakage location							●	●	●	
Domestic appliances			●							
Electric welding equipment		●	●							
Railroad operations	●	●	●							
Automotive operations	●		●							
Energy supply systems		●	●							
Electric medical devices	●	●	●							
Probe interface	Optical connection			Digital probe interface						



## Leaders in EMF Measurement

### Global leaders in technology – practical on-site applications

Narda Safety Test Solutions leads the field worldwide in the development and production of measuring devices for electric, magnetic, and electromagnetic fields. Our expertise comes from many years of experience in high frequency and microwave technology – and from more than 95% of all the published patents for the measurement of these fields. The result is a range of high-quality, application-tailored measurement technology solutions that are permanently assured by our management system which covers all areas and meets the requirements of the ISO 9001 and ISO/IEC 17025 standards.

**narda**   
Safety Test Solutions

Narda Safety Test Solutions GmbH  
Sandwiesenstraße 7  
72793 Pfullingen, Germany  
Phone +49 7121 97 32 0  
info@narda-sts.com

[www.narda-sts.com](http://www.narda-sts.com)

Narda Safety Test Solutions  
North America Representative Office  
435 Moreland Road  
Hauppauge, NY11788, USA  
Phone +1 631 231 1700  
info@narda-sts.com

Narda Safety Test Solutions  
S.r.l.  
Via Benessea 29/B  
17035 Cisano sul Neva, Italy  
Phone +39 0182 58641  
nardait.support@narda-sts.it

Narda Safety Test Solutions GmbH  
Beijing Representative Office  
Xiyuan Hotel, No. 1 Sanlihe Road, Haidian  
100044 Beijing, China  
Phone +86 10 6830 5870  
support@narda-sts.cn