

## Model 865 RF / Ultra Low Noise Microwave Signal Generator



### Features

- Excellent Signal Purity: Ultra-Low Phase Noise and Low Spurious
- Combination of Highest Output Power and Fastest Switching
- Powerful Touch-Display Control
- Portable, External Battery Modules Available

### Applications

- ATE
- R&D Low Noise Signal Source
- Signal Simulation
- Product Testing
- Service and Maintenance
- Aerospace and Defense



### Model 865 Datasheet v1.34

100 kHz to 40 GHz RF / Ultra Low Noise  
Microwave Signal Generator

## DEFINITIONS

The specifications in the following pages describe the warranted performance of the instrument for  $23 \pm 5$  °C after a 30-minute warm-up period

**Typical:** Expected mean values, not warranted performance

**Min and max:** Parameter range that is guaranteed by product design, and/or production tested. Warranted performance specifications include guard-bands to account for the expected statistical performance distribution, measurement uncertainties, and changes in performance due to environmental conditions.

## INTRODUCTION



### Ultra-low noise Microwave Signal Generator 100 kHz to 6, 12.75, 20, 26 and 40 GHz

The Model 865 is an ultra-low-noise and fast-switching microwave signal generator covering a continuous frequency range from 100 kHz up to 6, 12.75, 20 GHz, 26 or 40 GHz, respectively, with a lower than 0.001 Hz resolution. The Model 865 provide an accurately levelled output power range and high spurious suppression. Advanced frequency synthesis combines fastest switching speeds with ultra-low SSB phase noise and fine frequency and power resolution.

The Model 865 supports analog modulation including pulse and chirp modulation with programmable patterns.

The Model 865 allows fast digital sweeps including flexible list sweeps, where frequency, power and dwell times can be set individually. A flexible triggering system simplifies synchronization within test environments.

All Model 865 operate with ultra-stable temperature compensated frequency reference (OCXO) to ensure minimal drift and can be phase-locked to an external reference.

The compact unit allows full front panel control via touch panel display.

# FACTS & FIGURES & SPECIFICATIONS

## Signal Specifications

PARAMETER	MIN	TYPICAL	MAX	NOTE
<b>Frequency Range</b>	100 kHz 100 kHz 100 kHz 100 kHz 100 kHz 8 kHz		6 GHz 12.75 GHz 20 GHz 26 GHz 40 GHz	Model 865-6 Model 865-12 Model 865-20 Model 865-26 Model 865-40 Option 8K
Resolution		0.001 Hz		
<b>Phase Resolution</b>		0.01 deg		
<b>Switching Speed</b> SCPI CW mode Sweep / List Mode		1.5 ms 500 µs 30 µs		Valid signal after SCPI received  Option FS
<b>SSB Phase noise at 1 GHz</b>				(see also plots / tables)
at 10 Hz from carrier		-87 dBc/Hz -100 dBc/Hz	-95 dBc/Hz	Option LN
at 1 kHz from carrier		-130 dBc/Hz	-125 dBc/Hz	
at 20 kHz from carrier		-145 dBc/Hz	-140 dBc/Hz	
at 100 kHz from carrier		-150 dBc/Hz	-145 dBc/Hz	
<b>SSB Phase noise at 4 GHz</b>				
at 10 Hz from carrier		-74 dBc/Hz -90 dBc/Hz	-70 dBc/Hz -85 dBc/Hz	Option LN
at 1 kHz from carrier		-121 dBc/Hz	-116 dBc/Hz	
at 20 kHz from carrier		-133 dBc/Hz	-128 dBc/Hz	
at 100 kHz from carrier		-138 dBc/Hz	-133 dBc/Hz	
<b>SSB Phase noise at 10 GHz</b>				
at 10 Hz from carrier		-67 dBc/Hz -80 dBc/Hz		Option LN
at 1 kHz from carrier		-113 dBc/Hz		
at 20 kHz from carrier		-124 dBc/Hz		
at 100 kHz from carrier		-130 dBc/Hz		
<b>SSB Phase noise at 40 GHz</b>				
at 10 Hz from carrier		-55 dBc/Hz -68 dBc/Hz		Option LN
at 1 kHz from carrier		-101 dBc/Hz		
at 20 kHz from carrier		-112 dBc/Hz		
at 100 kHz from carrier		-118 dBc/Hz		
<b>Harmonics (at +5 dBm Pout)</b> 0.01 to 6 GHz >6GHz Option FILT, >1 GHz		-40 dBc -35 dBc -60 dBc	-30 dBc -25 dBc -50 dBc	See plot
<b>Sub-Harmonics</b> <5 GHz 5 - 20 GHz >20 GHz Option FILT, >20 GHz		-75 dBc -70 dBc -55 dBc -65 dBc		
<b>Non-Harmonic Spurious (&gt; 10 kHz offset)</b> <1.2 GHz 1.2 - 2.5 GHz 2.5 - 5 GHz 5 - 10 GHz 10 - 20 GHz >20 GHz		-90 dBc -92 dBc -90 dBc -84 dBc -80 dBc -70 dBc	-85 dBc -88 dBc -86 dBc -80 dBc -74 dBc -66 dBc	

PARAMETER	MIN	TYPICAL	MAX	NOTE
<b>Output power level</b>				
> 100 kHz and <10 MHz	-20 dBm		+18 dBm	
0.01 to 6 GHz	-20 dBm		+24 dBm	
6 to 12.75 GHz	-20 dBm		+23 dBm	
12.75 to 26 GHz	-20 dBm		+20 dBm	
26 to 40 GHz	-20 dBm		+18 dBm	See plots
<b>Output power level (Model 865-6,12,20 with Option PE4)</b>				
> 100 kHz and <10 MHz	-90 dBm		+18 dBm	
0.01 to 6 GHz	-90 dBm		+21 dBm	
6 to 12.75 GHz	-90 dBm		+20 dBm	
12.75 to 20 GHz	-80 dBm		+15 dBm	See plots
<b>Output power level (Model 865-26, 40 with Option PE4)</b>				
>100 kHz and <10 MHz	-55 dBm		+18 dBm	
0.01 to 20 GHz	-55 dBm		+20 dBm	
20 to 40 GHz	-55 dBm		+15 dBm	See plots
<b>Output power level (Model 865-26, 40 with Option FILT)</b>				
> 100 kHz and <10 MHz	-30 dBm		+18 dBm	
0.01 to 20 GHz	-30 dBm		+15 dBm	
20 to 35 GHz	-30 dBm		+13 dBm	
35 to 40 GHz	-30 dBm		+11 dBm	See plots
<b>Output power level (Model 865-26, 40 with Option FILT+8k)</b>				
<100 kHz	-30 dBm		+7 dBm	
0.01 to 20 GHz	-30 dBm		+15 dBm	
20 to 40 GHz	-30 dBm		+10 dBm	
<b>Power Resolution</b>		0.01 dB		
<b>Power Level Uncertainty</b>				
<6 GHz		0.25 dB	0.8 dB 1.2 dB	-15 to +15 dBm -60 to -15 dBm or >15 dBm
6 to 12.75 GHz		0.3 dB	0.9 dB 1.3 dB	-15 to +15 dBm -60 to -15 dBm or >15 dBm
12.75 to 26 GHz		0.3 dB	1.0 dB 1.6 dB	-15 to +15 dBm -60 to -15 dBm or >15 dBm
26 to 40 GHz		0.4 dB	1.2 dB 2.5 dB	-15 to +15 dBm -55 to -15 dBm or >15 dBm
<b>Reverse Power Protection</b>				
DC Voltage			±10 V	
RF Power			30 dBm	
<b>Output impedance</b>				
VSWR		50 Ohms	1.4 1.8	



## Modulation Capabilities (Option MOD)

PARAMETER	MIN	TYPICAL	MAX	NOTE
<b>Pulse Modulation</b>				
Modulation source		Internal/ External		
Pulse rise/fall time		10 ns		
On/off ratio (high ON/OFF mode)		80 dB 75 dB	70 dB 65 dB	Pout > +10 dBm, f<18 GHz > 18 GHz
Pulse overshoot			10%	
Pulse delay		20 ns		
Pulse polarity		Normal, inverse		selectable
External input threshold	0.85 V	0.9 V	0.95 V	TTL compatible
External input voltage range	-0.5 V		+5.5 V	TTL compatible
External input hysteresis		60 mV		
<b>Internal pulse generator</b>				
Repetition frequency (PRF)	0.1 Hz		50 MHz	= 1/T
Duty cycle	1 % to 99 % in 1% steps			within specified minimum pulse width
Minimum pulse settling range	30 ns 10 ns		20 s 20 s	Option FS
Pulse Pattern Modulation & Staggered PRF				Using internal pattern generator
Programmable pattern length	2		65536	
Duty cycle	0.05%		99.95%	
Pulse width resolution		5 ns		
Pulse period (T) accuracy		0.00005xT+ 3ns		
Pulse width accuracy		0.00005xT+ 5ns		
Pulse width resolution		5 ns		
Pulse jitter		1 ns	5 ns	
Polarity		selectable		
<b>Amplitude Modulation</b>				
Modulation source		Internal/ (External)		
Modulation Depth	0%		90%	
Deviation accuracy		2%	4%	1 kHz rate, 30% depth
Deviation resolution		1%		
Distortion (THD)			1%	1 kHz rate, 30% depth
Modulation rate	0.1 Hz		30 kHz	
Modulation waveforms	Sine			
External input voltage range	0 V		+10 V	Input voltage must be positive
External input termination		600 Ohms		Internal termination
External input coupling		AC		Cutoff 1 Hz typical (-3 dB)
<b>Chirped Pulse Modulation</b>				
Modulation source		Internal		Option FS & MOD
Chip span	1 Hz		3 %	of RF
Chip rate	1 Hz		100 kHz	
Pulse width	10 μs		1 sec	
Chip slope			0.5% / μs	of RF

Chip mode		Linear, exponential, up, down, bidirectional		
-----------	--	---	--	--

PARAMETER	MIN	TYPICAL	MAX	NOTE
<b>Frequency Modulation</b>				
Modulation source		Internal/ (External)		
Maximum Frequency deviation (peak)	N · 200 MHz			< 1.25 GHz (N=1) 1.25 GHz to 2.5 GHz (N=0.125) 2.5 GHz to 5 GHz (N=0.25) 5 GHz to 10 GHz (N=0.5) 10 GHz to 20 GHz (N=1) 20 GHz to 40 GHz (N=2)
Deviation accuracy		0.50%	2%	
Distortion (THD)		< 1 %		1 kHz rate, 10 kHz deviation
Modulation rate	0.1 Hz		80 kHz	
Modulation waveforms	Sine			
External input voltage range	0 V		+10 V	Input voltage must be positive
External input termination		600 Ohms		Internal termination
External input coupling		AC		Cutoff 1 Hz typical (-3 dB) DC coupling on request
<b>Phase Modulation</b>				
Modulation source		Internal/ (External)		
Phase deviation (peak)	0		300 · N · rad	
Deviation accuracy		0.50%	2%	
Modulation rate	0.1 Hz		80 kHz	
Modulation waveforms	Sine			
Distortion (THD)	< 1%			1 kHz rate & N x rad deviation
External input voltage range	0 V		+10 V	Input voltage must be positive
External input termination		600 Ohms		Internal termination
External input coupling		AC		Cutoff 1 Hz typical (-3 dB)

### Sweeping Capability, Sweep type: linear, logarithmic, random

PARAMETER	MIN	TYPICAL	MAX	NOTE
<b>Sweep Parameters</b>				
	Frequency, power, phase, list			
Step time ( $t_{step}$ )	500 $\mu$ s 30 $\mu$ s		19998 s 19998 s	Option FS
Settling time ( $t_{inv}$ )			15 $\mu$ s	To stabilize phase and amplitude, depends on frequency step
Trigger latency ( $t_{de}$ )			1 $\mu$ s	Time from trigger to initiate signal transient
Time resolution		5 ns		
Timing accuracy per point		5 ns		

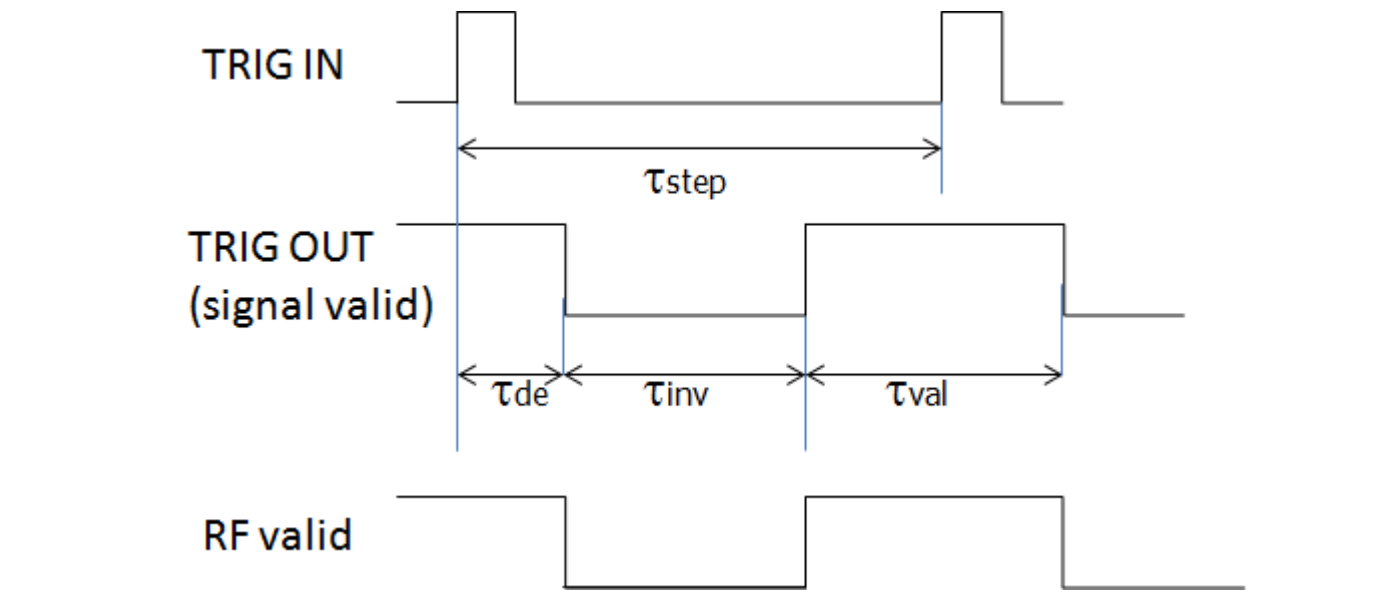

## Frequency Reference

PARAMETER	MIN	TYPICAL	MAX	NOTE
<b>Internal reference frequency</b>		100 MHz 10 MHz		Option LN
Temperature stability 0 to 50 degC			±100 ppb ±20 ppb	Option LN
Aging 1st year			1 ppm 0.3 ppm	Option LN
Aging per day			5 ppb 0.5 ppb	after 30 days operations Option LN
Warm-up time		5 min		
Output of internal reference		100 MHz 10/100 MHz		Option LN
Output power		0 dBm		
Output impedance		50 Ohms		
<b>Bypass Internal reference Input</b>		100 MHz		High phase synchronous mode
<b>Phase Lock to External Reference</b>		10 MHz integer MHz 100 MHz	250	Option VREF
Bypass Mode	5			
<b>Reference input level</b>				
10 MHz or 1-250 MHz	-5 dBm	0 dBm	+10 dBm	
100 MHz	5 dBm		+15 dBm	
<b>Lock Range</b>				
10 MHz or 1-250 MHz			±1.5 ppm	
100 MHz			>100 ppm	
<b>Reference input impedance</b>		50 Ohms		

## Trigger (TRIG IN): Input is TRIG IN at front panel

PARAMETER	MIN	TYPICAL	MAX	NOTE
<b>Trigger Types</b>	Continuous, single (point), gated, gated direction			
<b>Trigger Source</b>	external, bus (LAN, USB)			
<b>Trigger Modes</b>	Continuous free run, trigger and run, reset and run			
Trigger latency		5 ns		
Trigger uncertainty		10 ns		
External Trigger delay	50 ns		40 s	settable
External Delay Resolution		5 ns		
<b>Trigger Modulo</b>	1		255	Execute only on Nth trigger event
<b>Trigger Polarity</b>	Rising, falling			
<b>External trigger input threshold</b>	0.85 V	0.9 V	0.95 V	TTL compatible
<b>External trigger input voltage range</b>	-0.5 V		+5.5 V	TTL compatible
<b>External trigger input hysteresis</b>		60 mV		



## SSB Phase Noise Performance with option LN

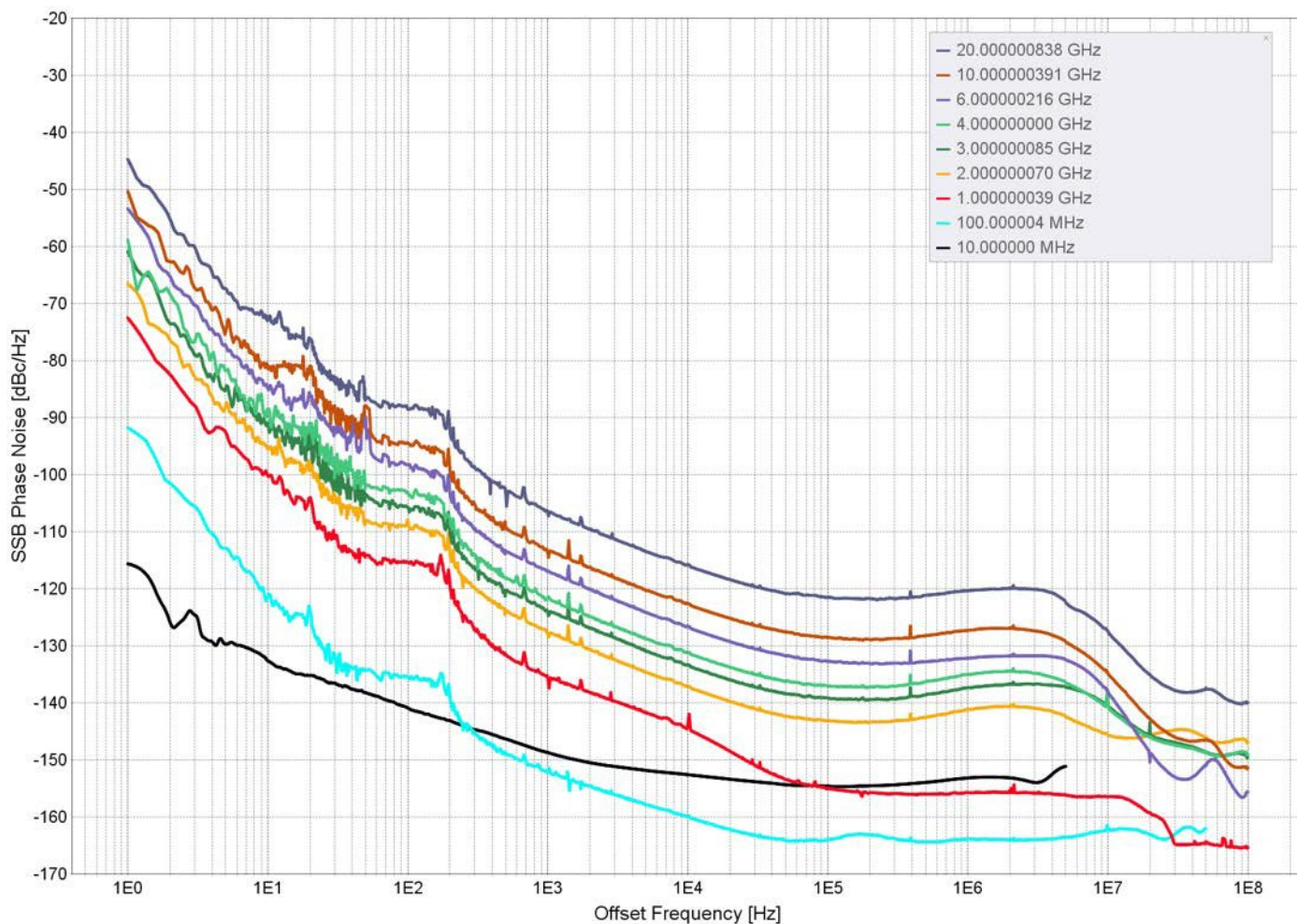

**Typical SSB Phase Noise [dBc/Hz], CW, level = 20 dBm, Option LN**

Offset → RF ↓	1 Hz	10 Hz	100 Hz	1 kHz	10 kHz	100 kHz	1 MHz	floor
10 MHz	-116	-133	-141	-149	-153	-155	-154	-155
100 MHz	-96	-121	-137	-148	-157	-162	-162	-162
1 GHz	-76	-100	-120	-132	-142	-153	-156	-165
2 GHz	-70	-94	-114	-125	-135	-143	-143	-155
3 GHz	-66	-90	-110	-122	-132	-139	-139	-151
4 GHz	-64	-88	-108	-118	-129	-137	-137	-151
6 GHz	-60	-84	-104	-115	-124	-132	-133	-151
10 GHz	-56	-80	-100	-111	-121	-129	-129	-151
20 GHz	-50	-74	-94	-105	-116	-123	-123	-150

# SSB Phase Noise Performance, without option LN

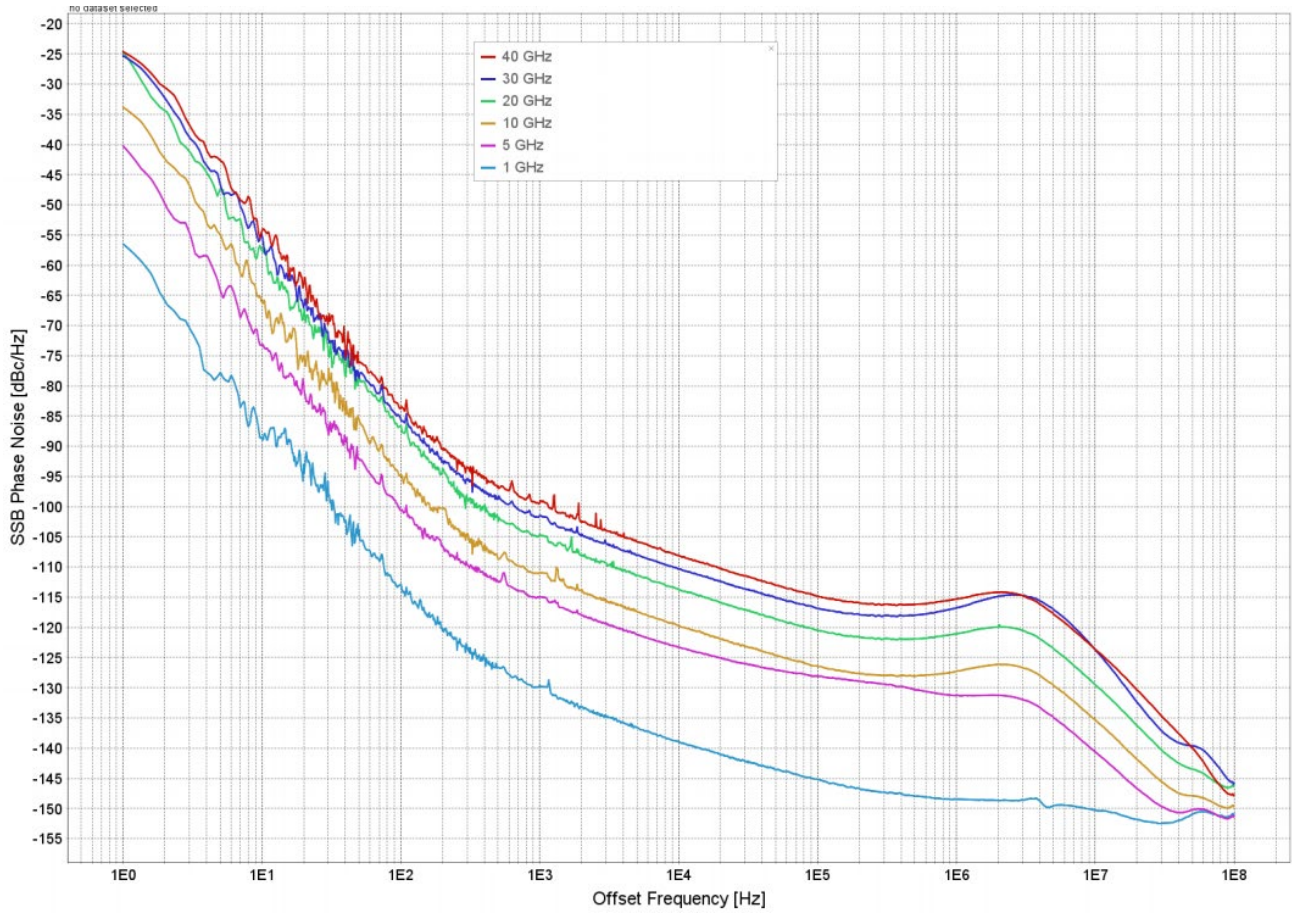

Typical SSB Phase Noise [dBc/Hz], CW, level = 20 dBm, without option LN

Offset → RF ↓	1 Hz	10 Hz	100 Hz	1 kHz	10 kHz	100 kHz	1 MHz	floor
10 MHz	-96	-128	-146	-149	-153	-155	-154	-155
100 MHz	-76	-108	-140	-148	-157	-162	-162	-162
1 GHz	-57	-88	-114	-130	-140	-145	-150	-165
5 GHz	-41	-74	-101	-116	-123	-128	-131	-151
10 GHz	-37	-68	-95	-111	-121	-127	-127	-151
20 GHz	-31	-62	-90	-105	-116	-121	-121	-150
40 GHz	-25	-56	-84	-100	-110	-115	-115	-150

## Output Power 0.01 to 20 GHz (Model 865-20)

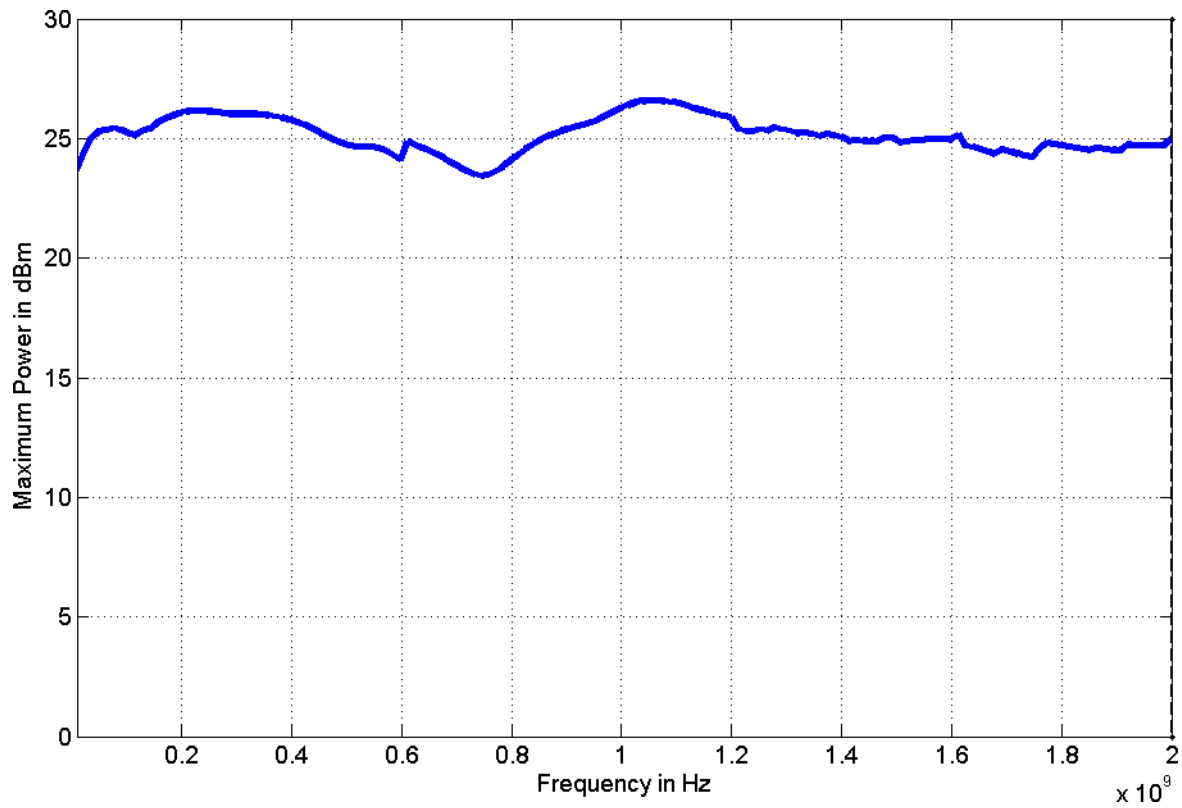

## Min & Max Output Power 0.01 to 40 GHz (Model 865-40)

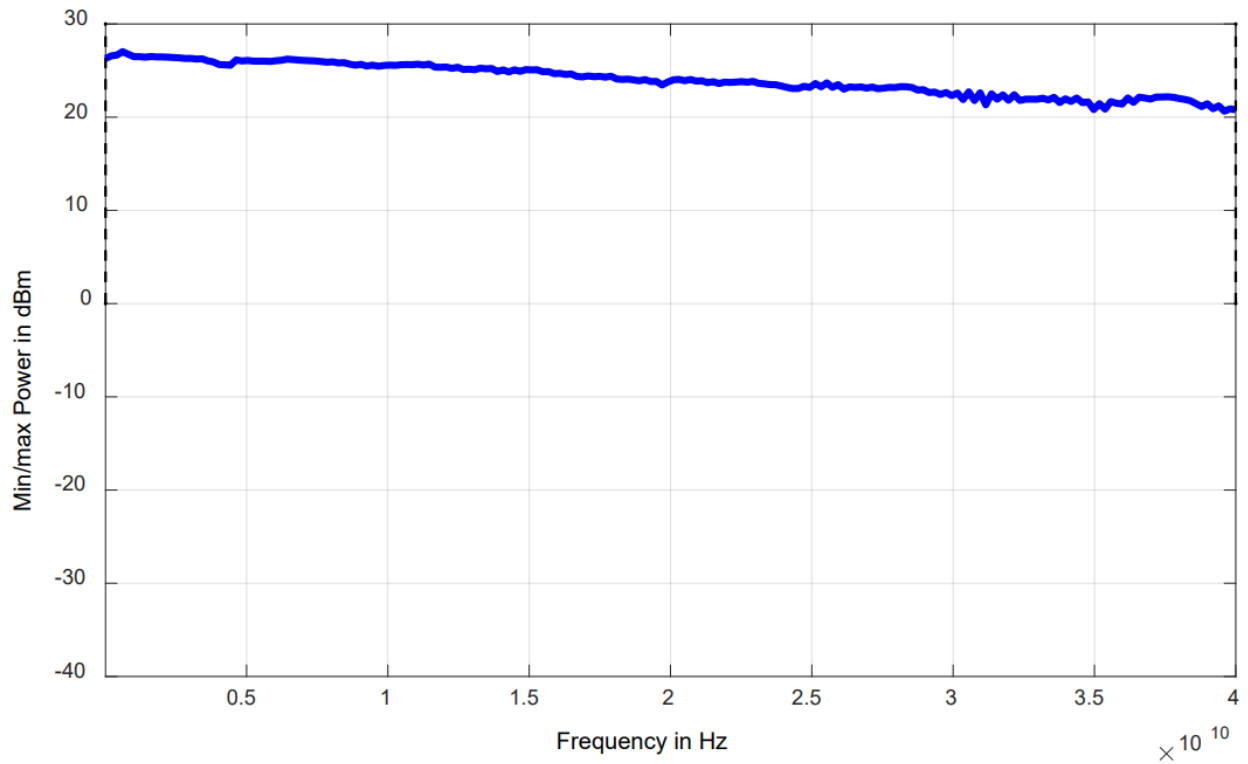

### Max Output Power 0.01 to 20 GHz (Model 865-20 with option PE4)

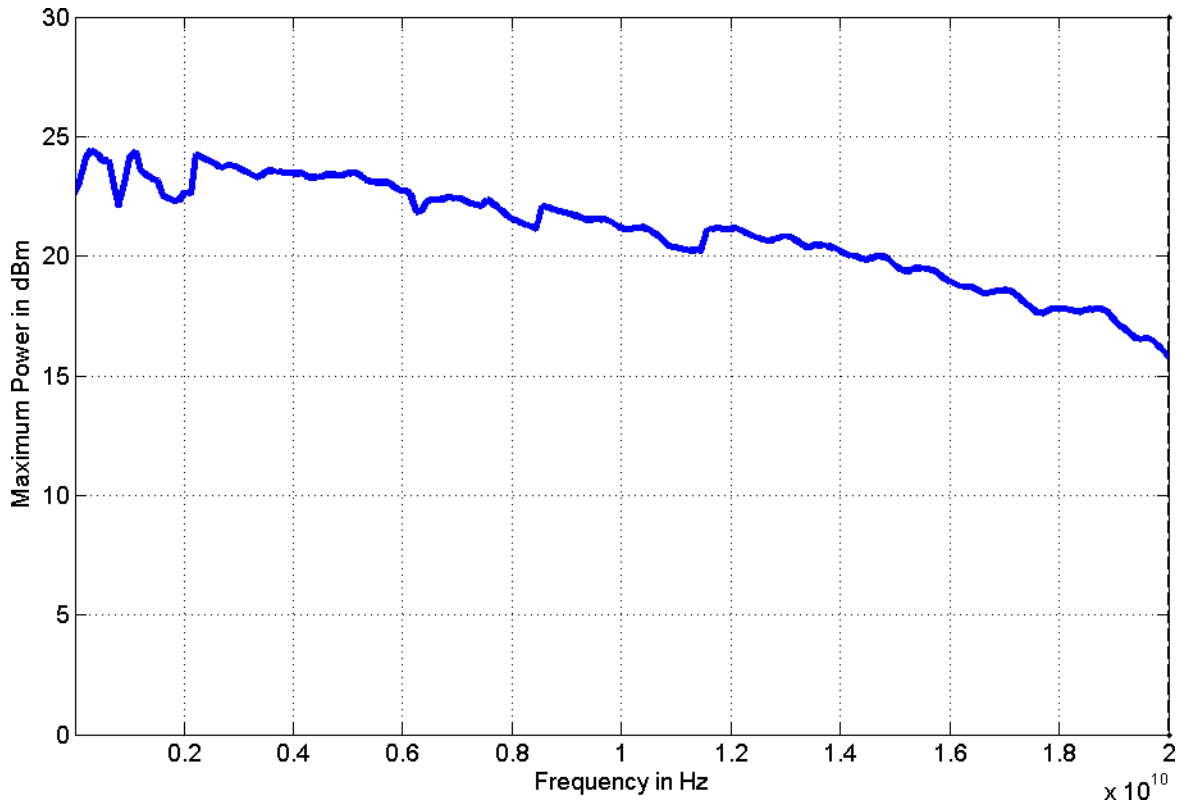

### Max Output Power 0.01 to 40 GHz (Model 865-40 with option PE4)

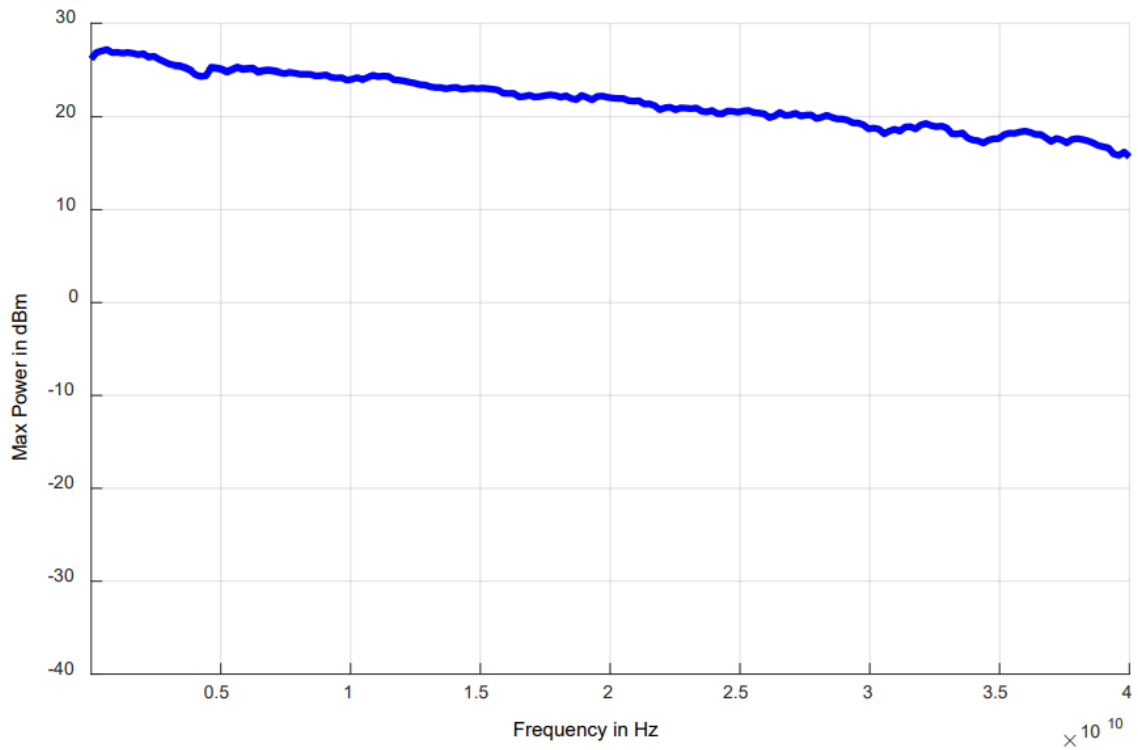

### Max Output Power 0.01 to 40 GHz (Model 865-40 with option FILT)

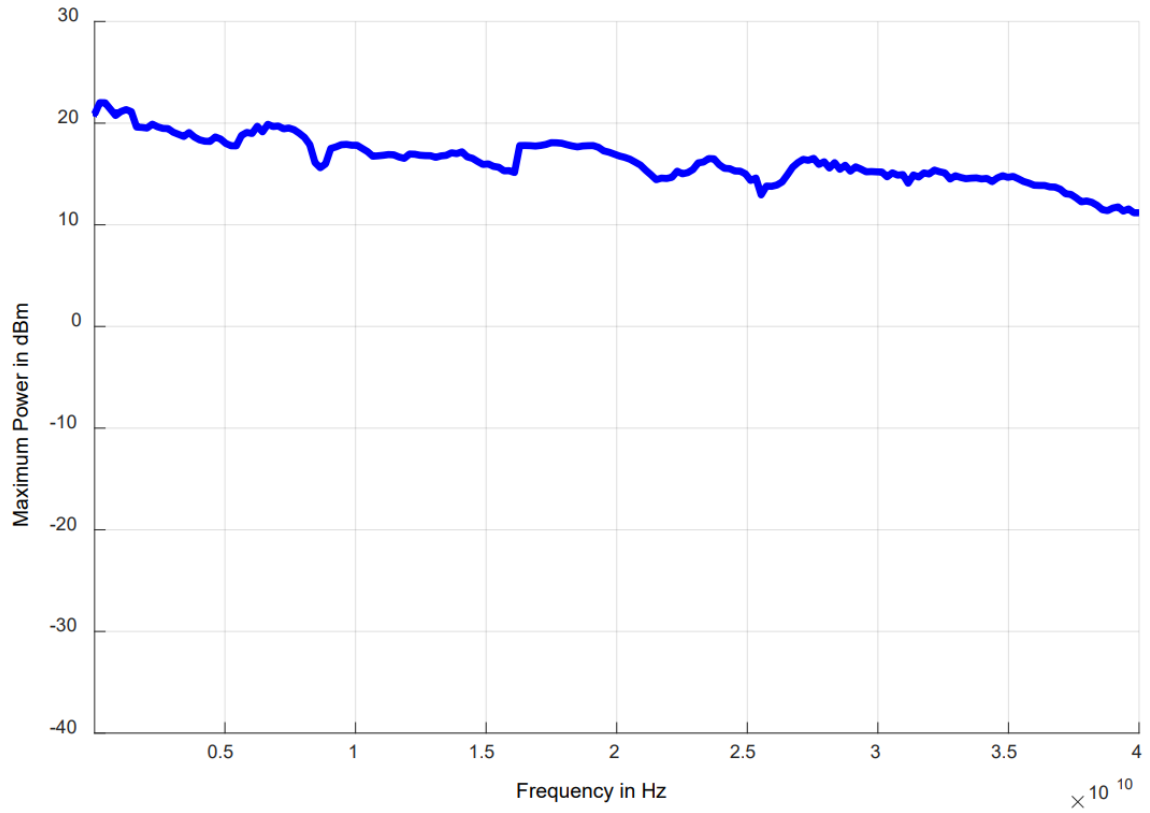

### Harmonics (2nd, 3rd at P=+5 dBm, Model 865-40 with option FILT)

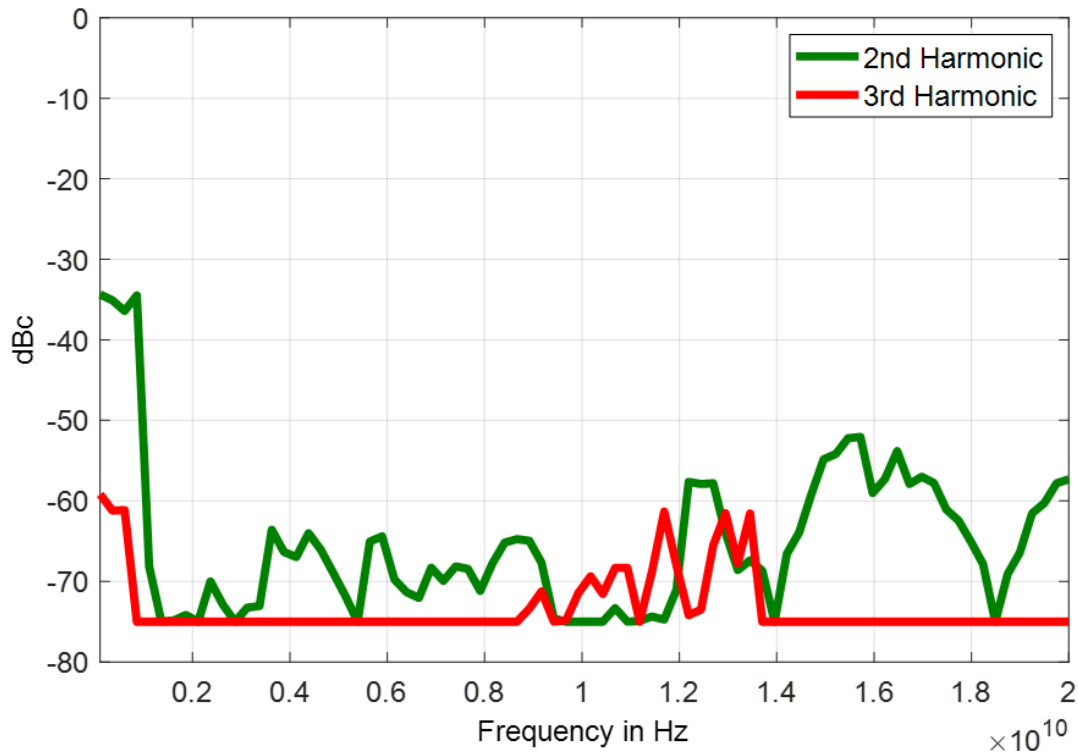

## Harmonics (2nd, 3rd at P=+10 dBm, Model 865-20)

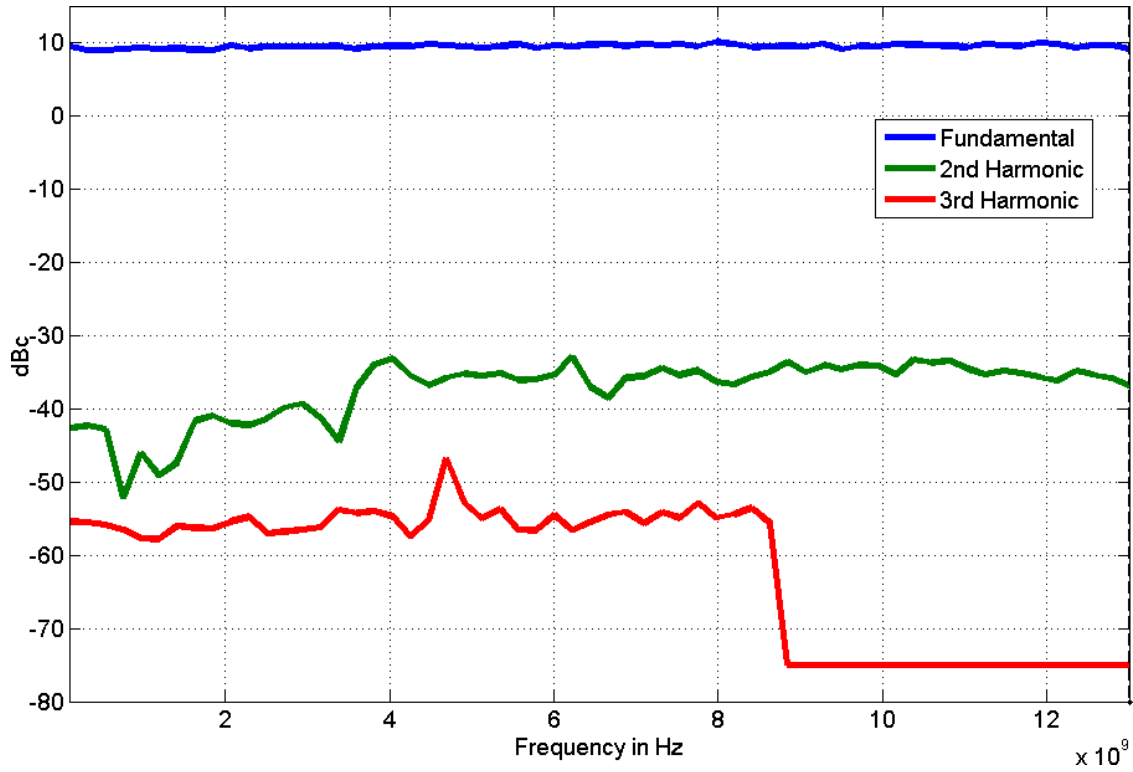

## Typical Frequency Response 0 to 20 GHz at different power levels (Model 865-20)

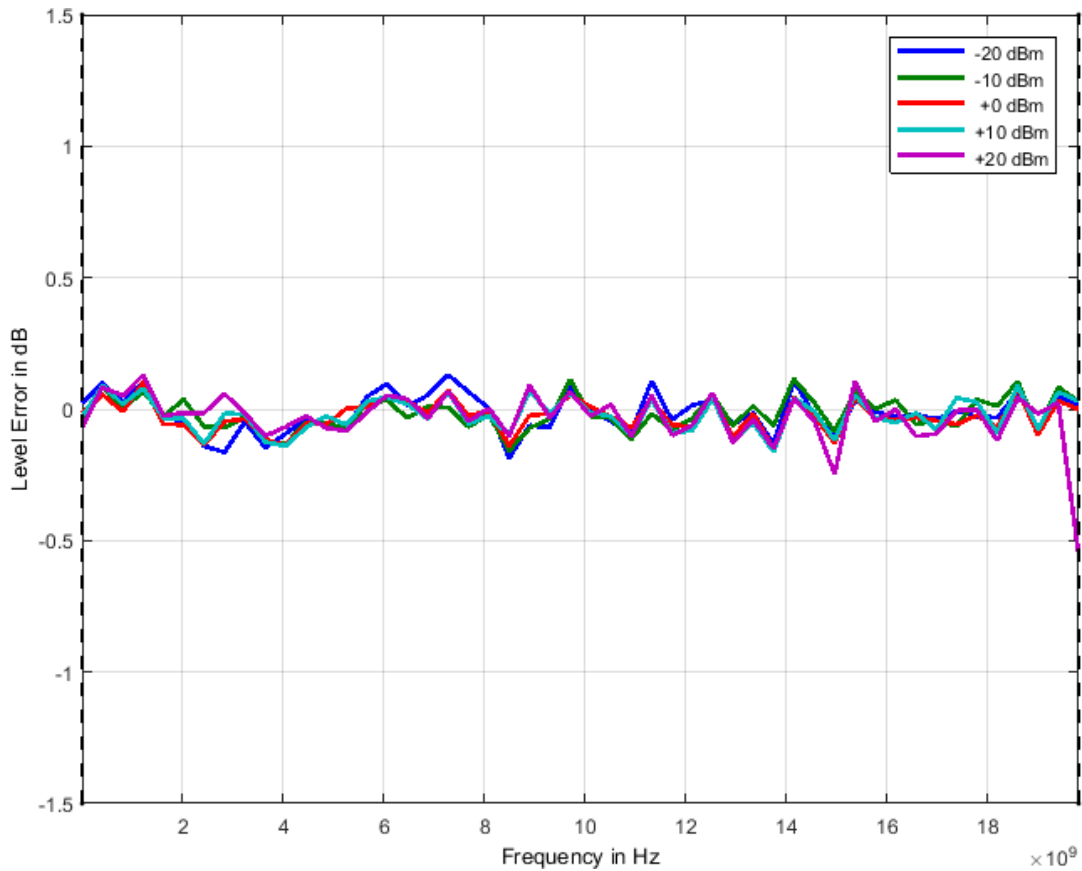

## Typical Output Power Linearity (Model 865-40)

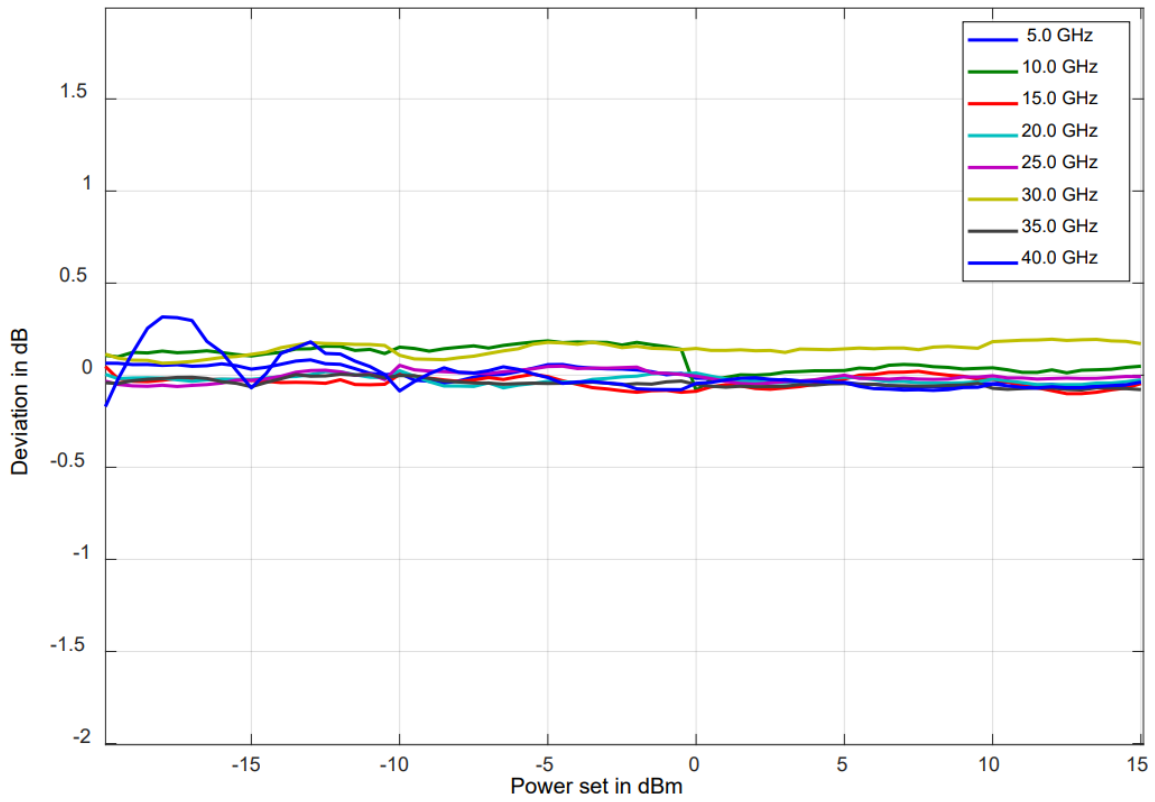

## Typical VSWR (Model 865-20)

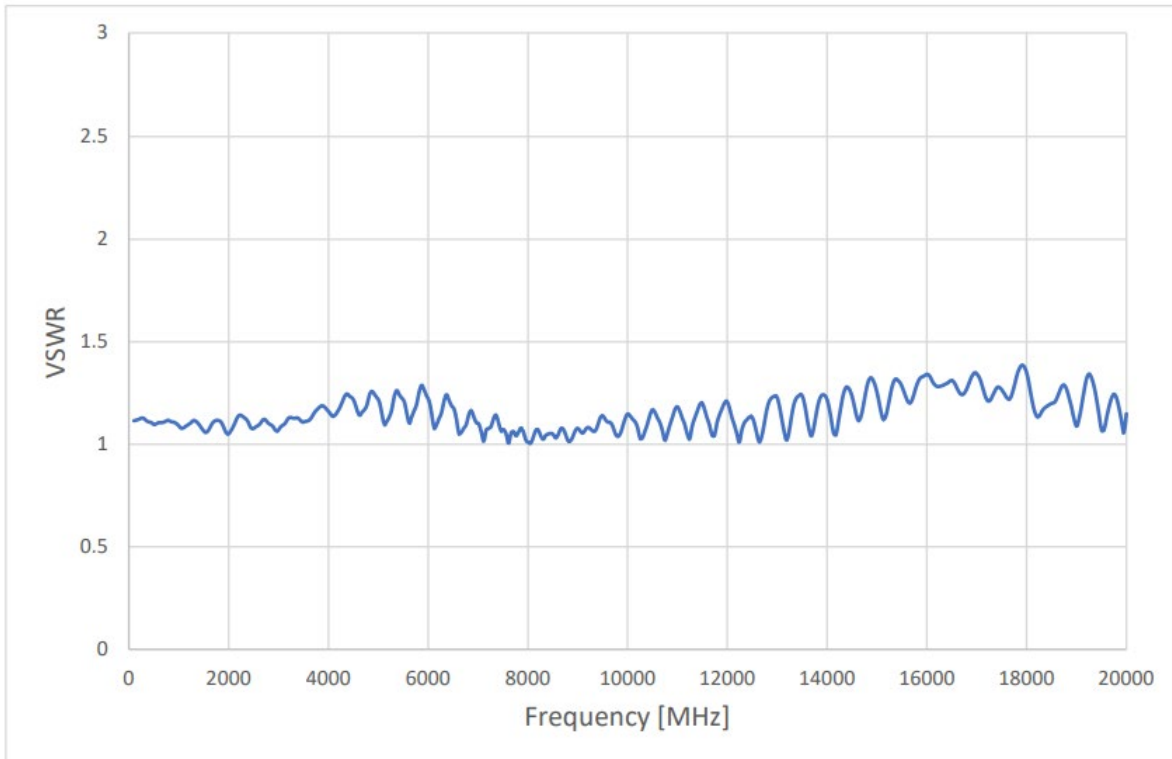

Internal Pulse Modulation (10 GHz, 40ns period, 15 ns pulse width)

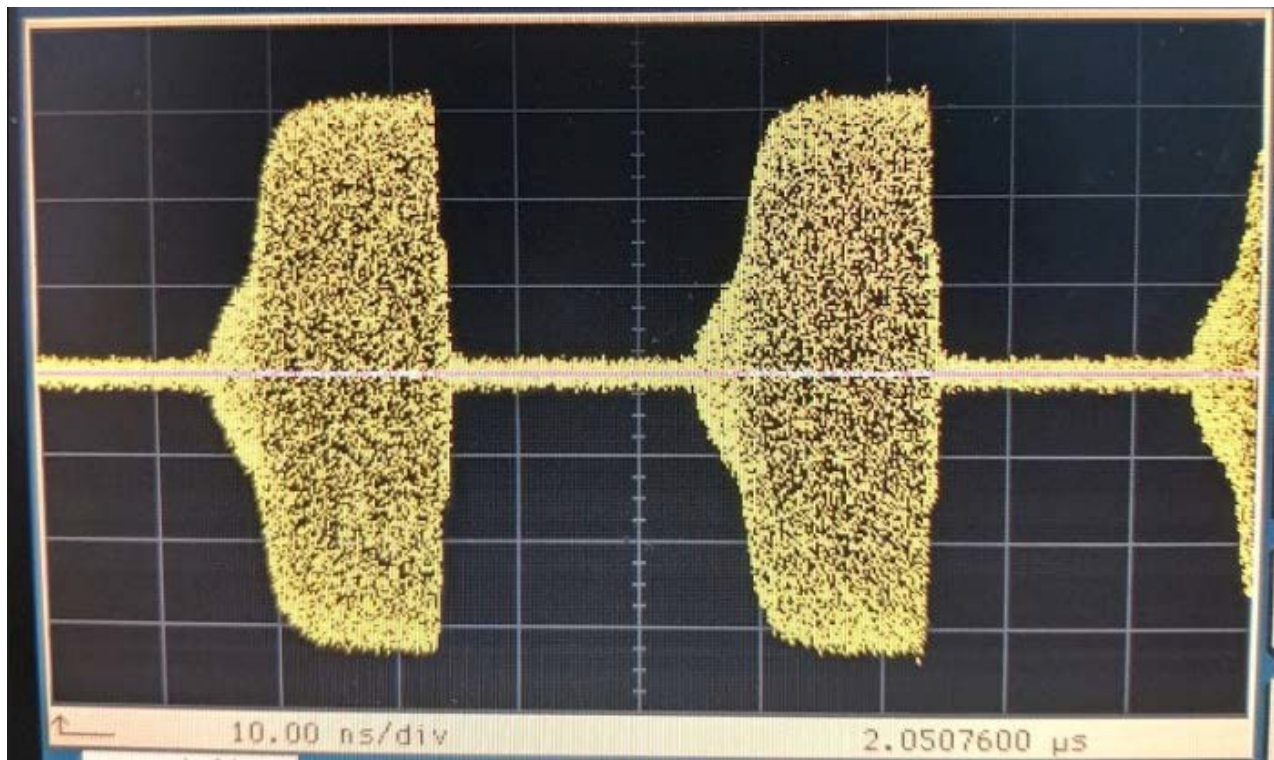

Internal Pulse Modulation (38.8 GHz, 15ns period, 7 ns pulse width)

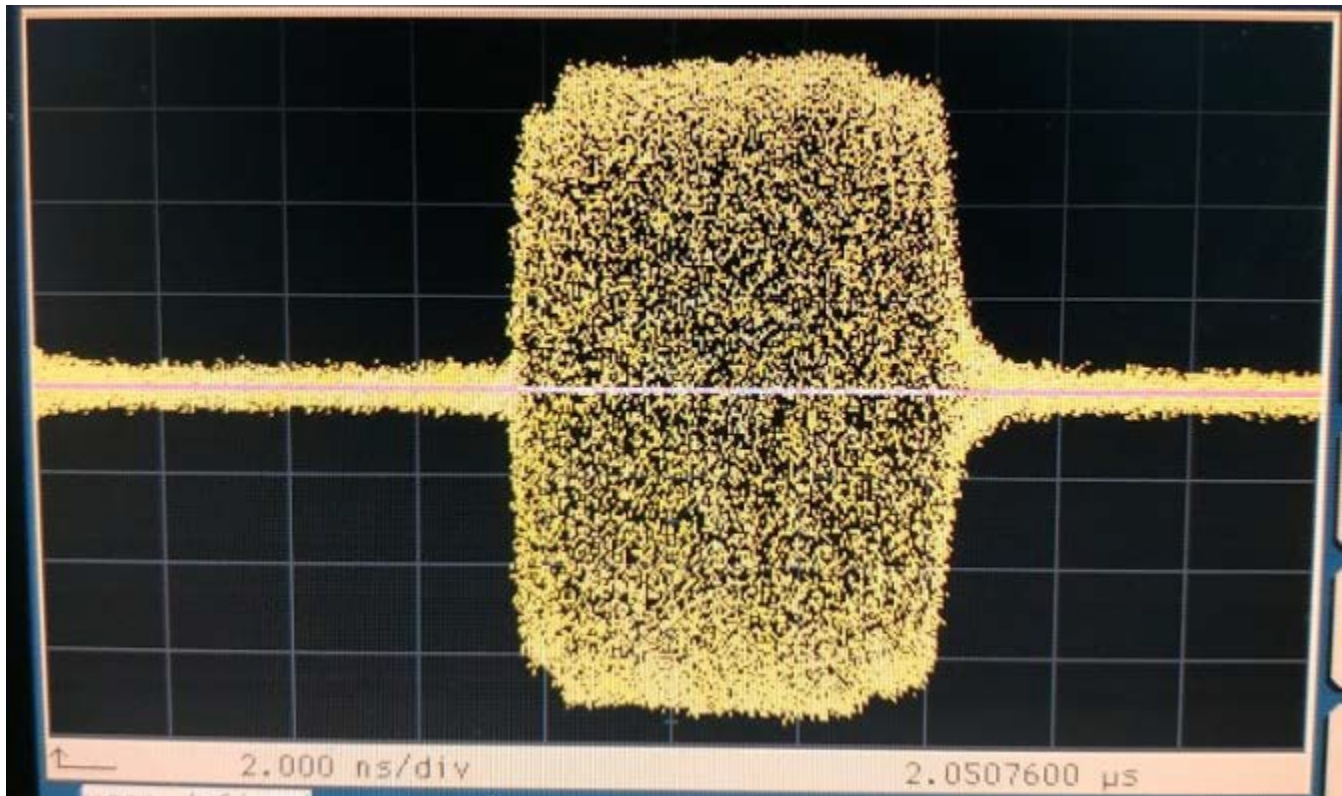



## Front panel:

1. RF output:

Model 865-40: K (2.92 mm) female

Model 865-6,12,2026: SMA female

2. Rotary knob

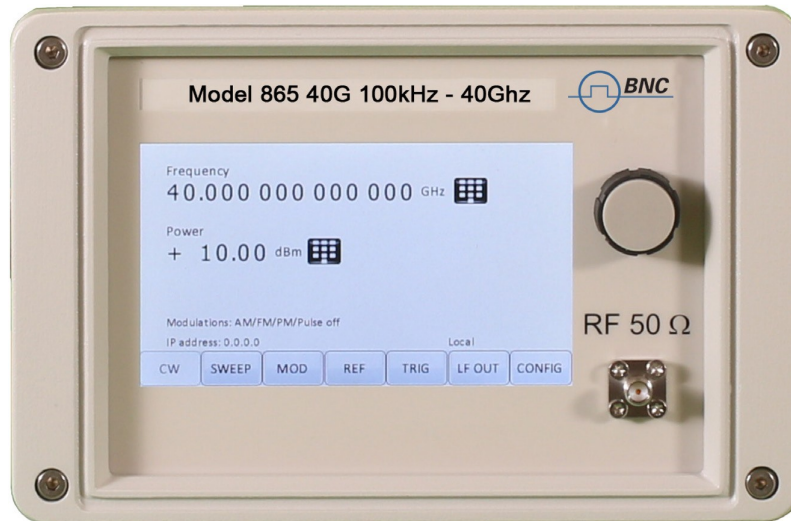

## Rear panel:

1. TRIG IN: Trigger input: BNC female

2. TRIG OUT: Trigger output: BNC female

3. REF OUT: External reference input: BNC female

4. REF IN: Internal reference output: BNC female

5. MOD IN modulation input for AM/FM/PM: BNC female

6. PULSE IN: Pulse modulation input: BNC female

7. LAN connection: RJ-45

8. USB 2.0 host and device

9. GPIB: IEEE-488.2, 1987 with listen and talk (optional)

10. DC Power plug (24V, 3 A)

11. DC power switch

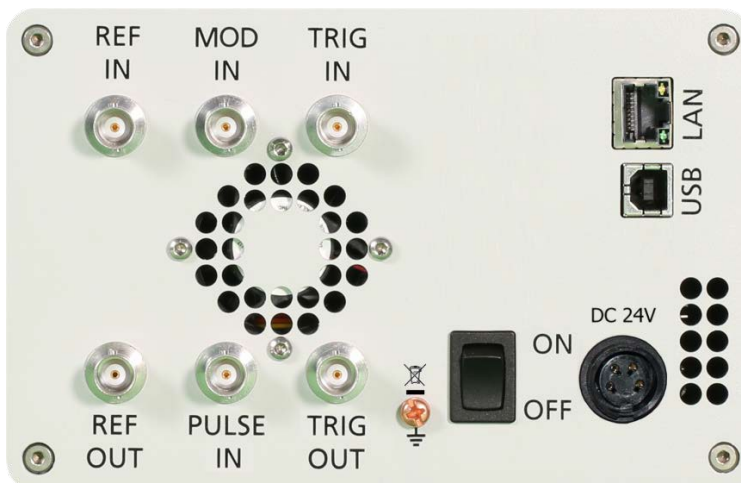

# ORDERING INFORMATION



HOST MODEL	PRODUCT	DESCRIPTION
Model 865-6	Model 865-6	100 kHz – 6 GHz
Model 865-12	Model 865-12	100 kHz – 12.75 GHz
Model 865-20	Model 865-20	100 kHz – 20 GHz
Model 865-26	Model 865-26	100 kHz – 26 GHz
Model 865-40	Model 865-40	100 kHz – 40 GHz
Model 865-XX	<b>Option LN</b>	Enhanced close in phase noise & frequency stability
Model 865-XX	<b>Option FS</b>	Ultra-fast switching speed
Model 865-XX	<b>Option MOD</b>	Analog modulation
Model 865-40	<b>Option FILT</b>	Enhanced harmonic rejection
Model 865-XX	<b>Option 8K</b>	Frequency range extension to 8 kHz
Model 865-XX	<b>Option VREF</b>	Variable External Reference
Model 865-6/12	<b>Option PE4-6/12</b>	Electrical step attenuator (6 & 12 GHz version)
Model 865-20/26	<b>Option PE4-20/26</b>	Electrical step attenuator (20 & 26 GHz version)
Model 865-40	<b>Option PE4-40</b>	Electrical step attenuator (40 GHz version)
Model 865-XX	<b>Option EB</b>	External power bank
Model 865-XX	<b>Option GPIB</b>	GPIB interface
Model 865-XX	<b>Option 1URM</b>	19" 1HU rack enclosure
Model 865-XX	<b>Option REAR</b>	Move output to the rear
Model 865-XX	<b>Option FLASH</b>	MicroSD card slot for removable microSD memory
Model 865-XX	<b>Option WE</b>	One year warranty extension
Model 865-XX	<b>Option ReCal</b>	Recalibration with test data

## GENERAL CHARACTERISTICS

### Remote programming interfaces

Ethernet 100BaseT LAN interface,  
USB 2.0 host & device  
GPIB (IEEE-488.2,1987) with listen and talk (optional)  
Control language SCPI Version 1999.0

**Power requirements** 24V  $\pm$  3.0 VDC; 25 W maximum

**Mains adapter supplied:** 100-240 VAC in/ 24 V 4.0 A DC out

**Environmental** (Levels similar to MIL-PRF-28800F Class 3/4)

Environmental stress Samples of this product have been type tested to be robust against the environmental stresses of storage, transportation, and end-use; those stresses to temperature, humidity, shock, vibration, altitude, and power line conditions.

**Operating temperature range** 32 to 113 F (0 to 45 °C)

**Storage temperature range** -40 to 158 F (-40 to 70 °C)

**Operating and storage altitude** up to 15,000 feet (4600 m)



notice

**EMC** complies and EMC regulations and directives for emission and immunity to interference (EN 61326-1 Industrial, EN/IEC 61326-2-1).

**Safety** complies with applicable Safety regulation in line with IEC/EN 61010-1

This product complies with directive 2011/65/EU

**Weight** 2.5 kg (6 lbs) net,  $\leq$  4 kg (8 lb.) shipping

**Dimensions** 4.21 in H x 6.77 in W x 11.42 in L (incl. connectors) [106 mm H x 172 mm W x 290 mm L]

**Recommended calibration cycle** 24 months