



Advanced Test Equipment Corp.

www.atecorp.com 800-404-ATEC (2832)

1689 # \$,950<sup>00</sup>

GR1658 # 9,350<sup>00</sup>?  
RLC Digibridge®

Form 1658-0120-D

# Instruction Manual

10-8-82

# Contents

- Specifications
- Introduction – Section 1
- Installation – Section 2
- Operation – Section 3
- Theory – Section 4
- Service and Maintenance – Section 5
- Parts Lists and Diagrams – Section 6

1689 \$ 9,350<sup>00</sup>  
\$ 9,350<sup>00</sup> ?

## GR 1658 RLC Digibridge<sup>®</sup>

Form 1658-0120-D

# Specifications

**Measurement Parameters and Modes:** Series or parallel R and Q, series or parallel L and Q, series or parallel C and D. Continuous-repetitive, single, or averaged (set of 10) measurements; start button initiates single or averaged measurements. Keyboard selection of these and all measurement conditions.

**Main Displays:** (3 selections): Value display is LED-type numerical readout with automatically positioned decimal points and illumination of units; five digits for RLC (99999) and simultaneously four digits for DQ (9999). Limits display shows comparator bin limits and nominal values. Bin No. display shows the bin assignment of the measured device.

**Measurement Rates:** Approximately 2, 3, and 7 measurements/second. Keyboard selections are: "slow, medium, fast."

**Test Frequencies:** Keyboard selection between 2. Accuracy re panel legends is +2%, -0.1%. Actual frequencies: for 1658-9700, 120.00 Hz  $\pm$  .01% and 1020.0 Hz  $\pm$  .01% (panel legend "1 kHz"); for 1658-9800, 100.00 and 1000.0 Hz  $\pm$  .01%.

**Applied Voltage:** 0.3 V rms, maximum.

**Ranges:** Automatic ranging for best accuracy; autorange can be inhibited by keyboard selection. Three basic ranges (best accuracy, see table) of 2 decades each, for each parameter. Automatic extensions to min and max, as tabulated.

Parameter	Minimum	Basic ranges	Maximum
R; 1 kHz	0.0001 $\Omega$	2 $\Omega$ to 2 M $\Omega$	9.9999 M $\Omega$
R; 120 Hz*	0.0001 $\Omega$	2 $\Omega$ to 2 M $\Omega$	99.999 M $\Omega$
L; 1 kHz	.00001 mH	0.2 mH to 200 H	999.99 H
L; 120 Hz*	0.0001 mH	2 mH to 2000 H	9999.9 H
C; 1 kHz	.00001 nF	0.2 nF to 200 $\mu$ F	999.99 $\mu$ F
C; 120 Hz*	0.0001 nF	2 nF to 2000 $\mu$ F	9999.9 $\mu$ F
Q (with R)	.0001	(fully automatic)	9.999
Q (with L)	00.01	(fully automatic)	999.9
D (with C)	.0001	(fully automatic)	9.999

\*120 Hz or 100 Hz, depending on the instrument.

**Accuracy:** For R, L, and C:  $\pm$  0.1% of reading in basic ranges, if quadrature component is small (< 10% of principal measurement), for slow measurement rate. More details given in table. Accuracy of Q (with R):  $\pm$  .001; of Q (with L):  $\pm$  .01; of D (with C):  $\pm$  .0005; in basic ranges, for D or Q << 1; (otherwise, see table).

Parameter	Basic accuracy			Cross-term factor
	F* Low extens	Basic ranges	High extensions	
R; either freq	$\pm$ M [2 m $\Omega$ ,	0.1% of rdg,	(R/20 M $\Omega$ ) % of rdg]	(1+Q)
L; 1 kHz	$\pm$ M [0.2 $\mu$ H,	0.1% of rdg,	(L/2000 H) % of rdg]	(1+1/Q)
L; 120 Hz**	$\pm$ M [2 $\mu$ H,	0.1% of rdg,	(L/20 kH) % of rdg]	(1+1/Q)
C; 1 kHz	$\pm$ M [0.2 pF†,	0.1% of rdg,	(C/2000 $\mu$ F) % of rdg]	(1+D)
C; 120 Hz**	$\pm$ M [2 pF†,	0.1% of rdg,	(C/.02 F) % of rdg]	(1+D)
Q (with R)	$\pm$ KM [ .001 + .001	Q (1+Q)	]	
Q (with L)	$\pm$ K [ .01 + .001	MQ(1+Q)	]	
D (with C)	$\pm$ KM [ .0005 + .001	D (1+D)	]	

\*Factors: M is 1, 2, or 5 for SLOW, MEDIUM, or FAST measurement rate, respectively. K is the quotient (RLC basic accuracy) / (RLC basic accuracy in basic range). Therefore, K = 1 in basic ranges. \*\*120 Hz or 100 Hz. † Fixed offset "zero" capacitance is < 2.0 pF.

**Bias:** Connector for external voltage source, on-off switch, and indicator light. Limit, 60 V (max). External source requirements: ripple < 1 mV pk-pk, dynamic Z << 1  $\Omega$  with currents of  $\pm$  50 mA pk (source and sink); external discharge circuit recommended.

**Supplementary displays:** Parameters, modes, overrange and under-range conditions, range held, bias on, and remote control.

**Sorting:** Limit comparator sorts vs a DQ limit and up to 8 pairs of RLC limits into 10 bins, conveniently defined by keyboard entries. GO/NO-GO is indicated, whether bin number or measured value is selected as main display.

**Interface option:** 2 ports (1 with choice of 2 modes); a 24-pin connector for each port. IEEE-488 INTERFACE PORT: Functions are SH1, AH1, T5, L4, SR1, RL2, PP0, DC0, DT1, C0. Refer to IEEE Standard 488-1978. Switch selection between 2 modes as follows. TALKER-LISTENER MODE: Input commands from system controller can disable keyboard and program all functions (except setting limits for sorting); any or all measurement results are available as outputs. TALKER-ONLY MODE: Measurement results are always output, for use in systems without controllers. HANDLER INTERFACE PORT: 1 input (start signal), 2 output (status signals), and set of 10 output lines (sorting data); active-low logic; for input, logic

low is 0.0 to +0.4 V (current is 0.4 mA max) and logic high is +2.4 to +5.0 V; for outputs, open-collector drivers rated at +30 V max, 40 mA max (sink), each, this port only. (External power supply and pullup resistors are required.)

**Environment:** TEMPERATURE: 0 to 40°C operating, -40 to +75°C storage. HUMIDITY: 0 to 85% R.H., operating.

**Supplied:** Power cord, axial-lead adaptors, bias cable, instruction manual.

**Line Voltage and Power:** 90 to 125 V or 180 to 250 V, 50 to 60 Hz. Either of these ranges selected by rear-panel switch. 30 W max.

**Mechanical:** Bench mounting. DIMENSIONS: (wxhxd): 375x112x343 mm (14.8x4.4x13.5 in.). WEIGHT: 6 kg (13.5 lb) net, 10 kg (22 lb) shipping.

Description	Catalog Number
1658 RLC Digibridge TM	
120 Hz and 1 kHz Test Frequencies	1658-9700
Same with Interface Option	1658-9701
100 Hz and 1 kHz Test Frequencies	1658-9800
Same with Interface Option	1658-9801
Extender Cable (for remote measurements)	1657-9600

# Table of Contents

Condensed Operating Instructions are on page 1-6.

Specifications		3.7 Bias . . . . .	3-11
Warranty		3.7.1 Bias Less Than 30 V and C Less Than 1000 $\mu$ F . . . . .	3-12
Introduction --- Section 1		3.7.2 Bias Up to 60 V . . . . .	3-12
1.1 Purpose . . . . .	1-1	3.8 Operation with a Handler . . . . .	3-12
1.2 General Description . . . . .	1-1	3.9 System Considerations . . . . .	3-12
1.2.1 Basic Digibridge . . . . .	1-1	3.9.1 IEEE-488 Interface Unused . . . . .	3-12
1.2.2 Interface Option . . . . .	1-1	3.9.2 Talk-Only Use . . . . .	3-12
1.2.3 References . . . . .	1-1	3.9.3 Talk/Listen Use . . . . .	3-12
1.3 Controls, Indicators, and Connectors . . . . .	1-1		
1.4 Accessories . . . . .	1-1	Theory --- Section 4	
Installation --- Section 2		4.1 Introduction . . . . .	4-1
2.1 Unpacking and Inspection . . . . .	2-1	4.1.1 General . . . . .	4-1
2.2 Dimensions . . . . .	2-1	4.1.2 Brief Description of the Digibridge . . . . .	4-1
2.3 Power-Line Connection . . . . .	2-1	4.1.3 Block Diagram . . . . .	4-2
2.4 Line-Voltage Regulation . . . . .	2-2	4.2 Principal Functions . . . . .	4-2
2.5 Test-Fixture Connections . . . . .	2-2	4.2.1 Elementary Measurement Circuit . . . . .	4-2
2.6 External Bias . . . . .	2-2	4.2.2 Frequency and Time Source . . . . .	4-2
2.7 Handler Interface (Option) . . . . .	2-3	4.2.3 Sine-Wave Generation . . . . .	4-3
2.8 IEEE-488 Interface (Option) . . . . .	2-4		
2.8.1 Purpose . . . . .	2-4	Service and Maintenance --- Section 5	
2.8.2 Interface Functions . . . . .	2-5	5.1 Customer Service . . . . .	5-1
2.8.3 Signal Identification . . . . .	2-5	5.2 Instrument Return . . . . .	5-1
2.8.4 Codes and Addresses . . . . .	2-5	5.2.1 Returned Material Number . . . . .	5-1
2.9 Environment . . . . .	2-9	5.2.2 Packaging . . . . .	5-1
Operation --- Section 3		5.3 Repair and Replacement of Circuit Boards . . . . .	5-1
3.1 Basic Procedure . . . . .	3-1	5.4 Performance Verification . . . . .	5-2
3.2 Connection of DUT . . . . .	3-2	5.5 Minimum Performance Standards . . . . .	5-2
3.2.1 The Integral Test Fixture . . . . .	3-2	5.5.1 General . . . . .	5-2
3.2.2 The Extender Cable . . . . .	3-2	5.5.2 Resistance Measurement Accuracy . . . . .	5-4
3.2.3 Correction for Cable Capacitance . . . . .	3-2	5.5.3 Single and Average Modes . . . . .	5-5
3.3 Accuracy and Speed . . . . .	3-3	5.5.4 Capacitance Measurement Accuracy (Small C) . . . . .	5-5
3.3.1 RLC Basic Accuracy . . . . .	3-3	5.5.5 Limit Comparison Bins . . . . .	5-5
3.3.2 RLC Accuracy Factor . . . . .	3-4	5.5.6 Capacitance Measurement Accuracy (Large C) . . . . .	5-7
3.3.3 D and Q Accuracy . . . . .	3-4	5.5.7 D-Measurement Accuracy . . . . .	5-7
3.3.4 Convenience of Logarithmic Scales . . . . .	3-4	5.5.8 Inductance Measurement Accuracy . . . . .	5-9
3.3.5 Insignificant Digits . . . . .	3-4	5.5.9 Zero Capacitance . . . . .	5-9
3.3.6 Measurement Rate . . . . .	3-5	5.6 Disassembly and Access . . . . .	5-9
3.4 Test Frequency and Equivalent Circuit . . . . .	3-5	5.6.1 Disassembly . . . . .	5-9
3.4.1 General . . . . .	3-5	5.6.2 Access . . . . .	5-11
3.4.2 Rules . . . . .	3-5	5.6.3 Reference Designations . . . . .	5-11
3.4.3 Series and Parallel Parameters . . . . .	3-6	5.6.4 Removal of Multiple-Pin Packages . . . . .	5-11
3.4.4 Equivalent Series R for Capacitors . . . . .	3-6	5.7 Periodic Maintenance . . . . .	5-11
3.4.5 Parallel Equivalent Circuits for Inductors . . . . .	3-7	5.7.1 Care of the Test Fixture . . . . .	5-11
3.5 Parameter, Range Holding, and Mode . . . . .	3-7	5.7.2 Care of the Display Panel . . . . .	5-12
3.5.1 Parameter --- R, L, or C . . . . .	3-7	5.8 Trouble Analysis . . . . .	5-13
3.5.2 Ranges and Range Holding . . . . .	3-7	5.8.1 General . . . . .	5-13
3.5.3 Measurement Modes . . . . .	3-8	5.8.2 Power Supply . . . . .	5-15
3.6 Limit-Comparison Bins . . . . .	3-9	5.8.3 Sinewave Generator . . . . .	5-15
3.6.1 Introduction . . . . .	3-9	5.8.4 Front End Amplifiers and Switches . . . . .	5-17
3.6.2 Limit Entry Methods . . . . .	3-9	5.8.5 Control Signal Checks . . . . .	5-19
3.6.3 Limit Entry Procedure . . . . .	3-9	5.8.6 Digital Circuitry . . . . .	5-21
3.6.4 Examples . . . . .	3-10		
3.6.5 Entries in General . . . . .	3-11	Parts List and Diagrams --- Section 6	
3.6.6 Verification of Nominal and Limit Values . . . . .	3-11	6.1 General . . . . .	6-1
3.6.7 Displays . . . . .	3-11	6.2 Reference Designations . . . . .	6-1
		6.3 Diagrams . . . . .	6-1
		Figure 6-1. Front view, Mechanical Parts . . . . .	6-2

Figure 6-2. Rear view, Mechanical Parts . . . . .	6-2	Figure 6-9. Interface Diagram . . . . .	6-13
Federal Manufacturers Code	6-4	Figure 6-10. Display Board Layout . . . . .	6-14
Figures 6-3 ... 6-9. Analog and Control Board, MB 1658-4700, as follows:		Figure 6-11. Display Board Diagram . . . . .	6-15
Figure 6-3. Signal Sources Diagram . . . . .	6-5	Figure 6-12. Keyboard Module Assembly . . . . .	6-16
Figure 6-4. Complete Layout . . . . .	6-6	Figure 6-13. Keyboard Circuit Layout . . . . .	6-17
Figure 6-5. Front End Diagram . . . . .	6-7	Figure 6-14. Keyboard Circuit Diagram . . . . .	6-17
Figure 6-6. I-C Layout . . . . .	6-8	Figure 6-15. Interface Option Layout . . . . .	6-18
Figure 6-7. Digital Center Diagram . . . . .	6-9	Figure 6-16. Interface Option Diagram . . . . .	6-19
Figure 6-8. Counter, Driver Diagram . . . . .	6-11	Figure 6-17. Power Supply Board Layout . . . . .	6-21
		Figure 6-18. Power Supply Diagram . . . . .	6-21

---

## Warranty

---



We warrant that this product is free from defects in material and workmanship and, when properly used, will perform in accordance with applicable GenRad specifications. If within one year after original shipment it is found not to meet this standard, it will be repaired or, at the option of GenRad, replaced at no charge when returned to a GenRad service facility. Changes in the product not approved by GenRad shall void this warranty. GenRad shall not be liable for any indirect, special, or consequential damages, even if notice has been given of the possibility of such damages.

**THIS WARRANTY IS IN LIEU OF ALL OTHER WARRANTIES, EXPRESSED OR IMPLIED, INCLUDING, BUT NOT LIMITED TO, ANY IMPLIED WARRANTY OF MERCHANTABILITY OR FITNESS FOR A PARTICULAR PURPOSE.**

GenRad policy is to maintain product repair capability for a period of ten years after original shipment and to make this capability available at the then prevailing schedule of charges.

---

# Introduction—Section 1

---

1.1	PURPOSE . . . . .	1-1
1.2	GENERAL DESCRIPTION . . . . .	1-1
1.3	CONTROLS, INDICATORS, AND CONNECTORS . . . . .	1-1
1.4	ACCESSORIES . . . . .	1-1

## 1.1 PURPOSE.

The 1658 Digibridge (TM) is a digital impedance meter and limit comparator embodying use of a microprocessor and other LSI circuitry to provide convenience, speed, accuracy, and reliability at low cost. With the interface option, this Digibridge can control other equipment and respond to remote control.

The versatile built-in test fixture, lighted keyboard, and angled display panel make this Digibridge convenient to use. Measurement results are clearly shown with decimal points and units, which are automatically presented to assure correctness. Display resolution is 5 digits for R, C, and L (4 for D or Q) and the basic accuracy is 0.1%.

Long-term accuracy and reliability are assured by the measurement system. It makes these accurate analog measurements over many decades of impedance without a single calibration or "trimming" adjustment (not even in original manufacture).

The built-in test fixture, with a pair of plug-in adaptors, receives any common component part (axial-lead or radial-lead), so easily that insertion of the device under test (DUT) is a one-hand operation. Four-terminal (Kelvin) connections are made automatically, ungrounded, with guard at ground potential. An extender cable is available for measurements at a distance from the instrument, typically for bulky components.

Bias can be applied to capacitors being measured, by connection of an external voltage source and sliding a switch. Bias levels from 0 to 60 V are suitable.

The interface option provides full "talker/listener" and "talker only" capabilities consistent with the standard IEEE-488 Bus. [1] A separate connector also interfaces with component handling and sorting equipment.

## 1.2 GENERAL DESCRIPTION.

### 1.2.1 Basic Digibridge.

Convenience is enhanced by the arrangement of test fixture and controls on the front ledge, with all controls for manual operation arranged on a lighted keyboard. Above and behind them, the display panel is inclined and recessed to enhance visibility of digital readouts and indicators. These

[1] IEEE Standard 488-1975, Standard Digital Interface for Programmable Instrumentation. (See para 2.8, below.)

indicators and those at the keyboard serve to inform and guide the operator as he manipulates the simple controls, or to indicate that remote control is in effect.

The instrument stands on a table or bench top. The sturdy metal cabinet is durably finished, in keeping with the long-life circuitry inside. Glass-epoxy circuit boards interconnect and support high-quality components to assure years of dependable performance.

Adaptability to any common ac power line is assured by the removable power cord and the convenient line-voltage switch. Safety is enhanced by the fused, isolating power transformer and the 3-wire connection.

### 1.2.2 Interface Option.

The interface option adds capabilities to the instrument, enabling it to control and respond to parts handling/sorting equipment. Also (via separate connector) this option can be connected in a measurement system using the IEEE-488 Bus. Either "talker/listener" or "talker only" roles can be performed by the Digibridge, by switch selection.

### 1.2.3 References.

A functional description is given in Theory, Section 4. Electrical and physical characteristics are listed in Specifications at the front of this manual; dimensions, in Installation, Section 2. Controls are described below; their use, in Operation, Section 3.

## 1.3 CONTROLS, INDICATORS, AND CONNECTORS.

Figure 1-1 shows the controls and indicators on the front of the instrument. Table 1-1 identifies them with descriptions and functions. Similarly, Figure 1-2 shows the controls and connectors on the rear; Table 1-2 identifies them.

## 1.4 ACCESSORIES.

GenRad makes several accessories that enhance the usefulness of this Digibridge. The extender cable facilitates making connection to those devices and impedance standards that do not readily fit the built-in test fixture. The cable branches into 5 parts, each with a stackable banana plug, for true 4-terminal connections (and guard) to the device being measured, without appreciable reduction in measurement accuracy. Other useful accessories are offered, such

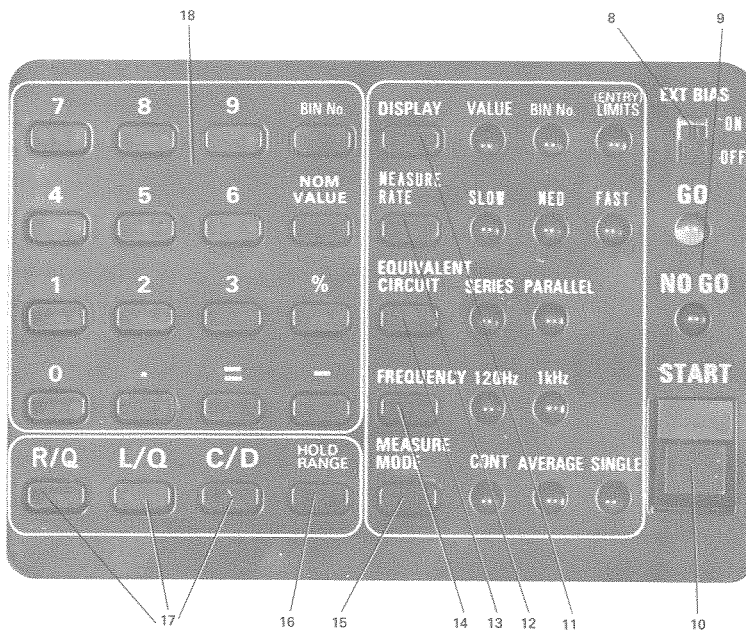
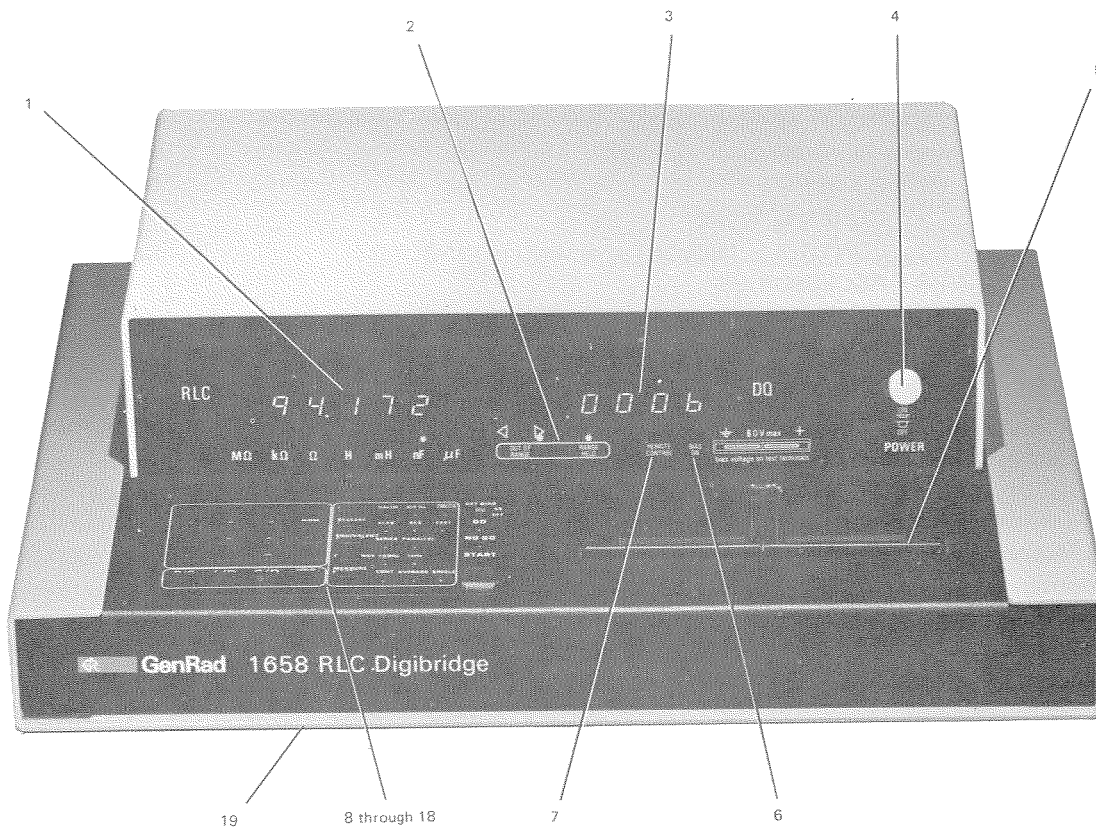

Figure 1-1. Front controls and displays. Upper, whole instrument. Lower, keyboard, detail.

Table 1-1  
FRONT CONTROLS AND INDICATORS

Figure 1-1 Item	Name	Description	Function
1	RLC display	Digital display, 5 numerals with decimal points. Unit labels M $\Omega$ , k $\Omega$ , $\Omega$ , H, mH, nF, $\mu$ F, with 7 lights.	Display of principal measured value. Light spot indicates units.
2	OUT OF RANGE and RANGE HELD lights.	Legend with arrows and 3 lights.	Indicates when measurement is OUT OF basic RANGE: underrange (left arrow), overrange (right arrow), or DUT not compatible with selected parameter (both arrows). For low underrange, neither arrow is lit. (However, if RLC display has less than 4 digits, the measurement was made on low underrange.) When RANGE HELD indicator is out, the range is automatically optimized.
3	DQ display	Digital display, 4 numerals with decimal points.	Display of secondary measured value, D if you select C/D, Q if you select L/Q or R/Q with item 17.
4	POWER switch	Pushbutton (push again to release).	Turns instrument ON when in, OFF when out. OFF position breaks both sides of power circuit.
5	Test fixture	Pair of special connectors; each makes dual contact with inserted wire lead of DUT.	Receives radial-lead part, making 4-terminal connection automatically. Adaptors are supplied to make similar connection with axial-lead part.
6	BIAS light	Legend with light.	Light shines when bias is applied (via EXT BIAS switch, item 8).
7	REMOTE CONTROL light	Legend with light.	Light shines when remote control is established by external command. Functions only if you have the interface option.
8	EXT BIAS switch	Slide switch, 2 positions: ON, OFF.	To connect and disconnect the external bias circuit. See item 6. Use an external switch routinely to apply bias and to discharge capacitors. Always leave OFF when bias circuit is not in use.
9	GO/NO-GO lights	LED indicator lights	GO means measured value is acceptable, based on the limits stored by item 18. NO-GO means unacceptability of basic parameter, loss factor, or both.
10	START button	Pushbutton switch.	Starts measurement sequence. (Normally used when measurement mode is either SINGLE or AVERAGE.)
11 : : : 15	(see below)	Each key has associated LED indicators at right.	Selection of indicated function, accomplished by pressing key repeatedly (causing corresponding indicators to cycle through the alternatives) until desired choice is lit.
11	DISPLAY key	Indicators: VALUE, BIN NO., ENTER LIMITS.	Two choices enable measurement, with display senses as follows: VALUE = measured parameters, BIN NO. = limit category into which value fits. When ENTER LIMITS is selected, measurements are inhibited, limit-entry keys are enabled, and display is limits or nominal value, depending on use of item 18.
12	MEASURE RATE key	Indicators: SLOW, MED, FAST	Selection of measurement speed as indicated. (Accuracy is best with SLOW.)
13	EQUIVALENT CIRCUIT key	Indicators: SERIES, PARALLEL.	Selection of equivalent circuit assumed for the DUT.
14	FREQUENCY key	Indicators: 120 Hz and 1 kHz (or 100 Hz, 1 kHz).	Selection of test-signal frequency.
15	MEASURE MODE key	Indicators: CONT, AVERAGE, SINGLE.	Mode selection: continuously repeating measurements; running average of 10 measurements and display held after the 10th; single measurement (display held). Continuous mode does not require "start."



Table 1-1 (Cont.)  
FRONT CONTROLS AND INDICATORS

Figure 1-1 Item	Name	Description	Function
16	HOLD RANGE key	Key associated with RANGE HELD light. (See item 2.)	Key action alternates state between "autorange" (indicator off) and RANGE HELD (indicator on), which holds the present range for subsequent measurements.
17	Parameter keys	Set of 3 keys, labeled: R/Q, L/Q, C/D.	Selection of basic parameter to be measured: R, L, or C. Also, during "limit entry", (see item 11), repeated pushing of any one key selects measurement units (for limits), as displayed in item 1.
18	Limit-entry keys	Group of 16 keys with numbers and other labels.	Manual entry of limits that define go/no-go categories and 10 bin assignments, and selection of limit displays on items 1 and 3. Functional only if ENTER LIMITS has been selected by item 11.
19	Reference card	Captive pull-out card.	Handy reference information for basic operation, limit entry, and programming.

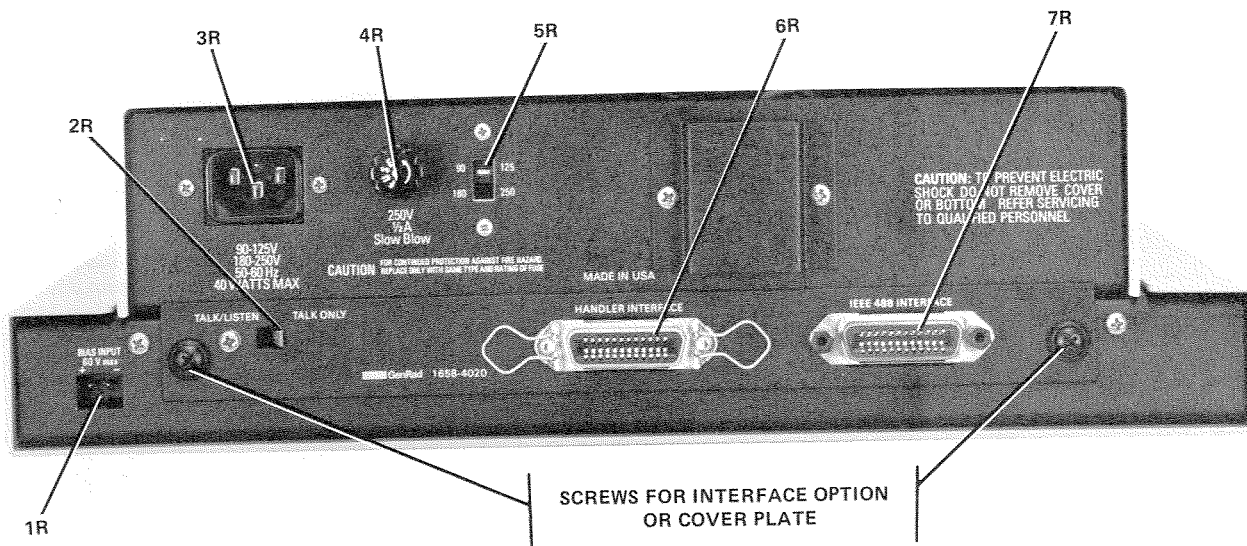

Figure 1-2. Rear controls and connectors.

as standards for checking the performance of the Digibridge. Refer to Table 1-3 in this manual and the brochure of

Impedance Standards and Precision Bridges, available from GenRad upon request.

Table 1-2  
REAR CONNECTIONS AND CONTROLS

Figure 1-2 Ref. No.	Name	Description	Function
1R	BIAS INPUT connector	Recessed plug, 2-pin, Labeled: 60 V max, +, -, (rear view).	Connection of external voltage source for biasing capacitors via test fixture. Observe instructions in para 2.6.
2R	TALK switch*	Toggle switch.	Selection of mode for IEEE-488 interface: TALK/LISTEN or TALK ONLY, as labeled.
3R	Power connector (labeled 50-60 Hz)	Safety shrouded 3-wire plug, conforming to International Electrotechnical Commission 320.	Ac power input. Use appropriate power cord, with Belden SPH-386 socket or equivalent. The GenRad 4200-9625 power cord (supplied) is rated for 125 V.
4R	Fuse (labeled 250 V, 0.5 A, SLOW BLOW)	Fuse in extraction post holder.	Short circuit protection. Use Bussman type MDL or equivalent fuse, 1/2 A, 250 V rating.
5R	Line-voltage switch	Slide switch. Upper position, 90 to 125 V; lower position, 180 to 250 V.	Adapts power supply to line-voltage ranges, as indicated. To operate, use small screwdriver, not any sharp object.
6R	HANDLER INTERFACE connector*	Socket, 24-pin; receives Amphenol "Microribbon" plug P/N 57-30240 (or equiv).	Connections to component handler (bin numbers and status, out; "start", in).
7R	IEEE-488 INTERFACE connector*	Socket, 24-pin. Receives IEEE-488 interface cable (see para 2.8).	Input/output connections according to IEEE Std 488-1978. Functions: complete remote control, output of all display values.

\*TALK switch and 24-pin connectors are supplied with the Interface Option only.

Table 1-3  
ACCESSORIES

Quantity	Description	Part Number
1 supplied	Power cord, 210 cm (7 ft) long, 3-wire, AWG No. 18, with molded connector bodies. One end, with Belden SPH-386 socket, fits instrument. Other end is stackable (hammer-head) conforming to ANSI standard C73.11-1966 (125 V max).	4200-9625
2 supplied	Test-fixture adaptors, for axial-lead parts.	1686-1910
1 supplied	Bias cable, 120 cm (4 ft) long, 2-wire. One end fits BIAS INPUT connector. Other end has stackable banana plugs (black, red).	1658-2450
1 supplied	Keyboard cover.	1687-2210
1 recommended	Extender cable for connection to multi-terminal standards and large or remote DUT's. Length 100 cm (40 in.).	1657-9600
1 available	Rack mount kit (slides forward for complete access)	1657-9000

## CONDENSED OPERATING INSTRUCTIONS

### GenRad 1658 Digibridge®

#### 1. GENERAL INFORMATION

Refer to instruction manual for details of specification, installation, operation, and service.

##### MEASUREMENT RANGES

Parameter; Frequency	Minimum (Reduced Acc)	Basic Ranges, Full Accuracy	Maximum (Reduced Acc)
R; 120 Hz*	0.0001 Ω	2 Ω to 2 MΩ	99.999 MΩ
R; 1 kHz	0.0001 Ω	2 Ω to 2 MΩ	9.9999 MΩ
Q (with R)	.0001	-----	9.999
L; 1 kHz	.00001 mH	0.2 mH to 200 H	999.99 H
L; 120 Hz*	0.0001 mH	2 mH to 2000 H	9999.9 H
Q (with L)	00.01	-----	999.9
C; 1 kHz	.00001 nF	0.2 nF to 200 μF	999.99 μF
C; 120 Hz*	0.0001 nF	2 nF to 2000 μF	99999 μF
D (with C)	.0001	-----	9.999

\*120 Hz or 100 Hz, depending on model.

#### 2. EXTENDER CABLE

Available from GenRad (P/N 1657-9600).

##### COLOR CODE OF EXTENDER CABLE

Colors	Signal	DUT	Digibridge
Red	I+	"High" end	Signal source (hi)
Red and white	P+	"High" end	Potential sense (hi)
Black	I-	"Low" end	Current sense (lo)
Black and white	P-	"Low" end	Potential sense (lo)
Black and green	GND	Shield only	Guard

#### 3. EXT BIAS SWITCH

Keep this switch OFF (regardless of whether any bias source is connected) for all measurements except when applying dc bias to capacitors. (Refer to manual, para 3.7.)

#### 4. OPERATION

- Select VALUE mode with [DISPLAY] key.
- Select measurement conditions with keys at right. Repeat keying advances selection as indicated nearby.
- With [HOLD RANGE] key, select autorange (no indication) or RANGE HELD (indicator on panel).
- Select parameter with R/Q, L/Q, or C/D key; note confirmation by type of unit, on panel. (Repeat keying has no effect except in entry mode; see para 6.)
- Refer to manual for details of test fixture connections. Keep EXT BIAS switch generally OFF (see above).
- Use START button for AVERAGE or SINGLE MEASURE MODE.
- Read RLC and DQ displays. Observe range lights:

Underrange:  (both arrows lighted) Overrange;  
better accuracy is available on a lower range.\* | WRONG PARAMETER | RLC value is too large for basic range of the currently used range.\*

\*Select autorange (avoid RANGE HELD) to obtain best available accuracy and minimize the number of under- and over-range measurements.

h. If limits have been entered and enabled (para 6), observe GO/NO-GO lights.

i. If limits have been entered and enabled (para 6), to see display of bin number instead of measured values, use [DISPLAY] key to select BIN No. and remeasure the DUT.

#### 5. INTERFACE OPTION, USE OF IEEE-488 BUS

Set the TALK switch (rear panel) as follows:

TALK ONLY — whenever bus is not in use and while communicating only with "listen-only" devices.

TALK/LISTEN — to enable use in a system with a controller device, e.g., calculator. Refer to table below for device-dependent messages to control Digibridge.

##### PROGRAMMING COMMANDS

Command	Code	Command	Code	Command	Code
Display		Measure mode		Data output**	
Entry*	D0	Single	L0	None	X0
Bin	D1	Average	L1	Bin number	X1
Value	D2	Continuous	L2	DQ	X2
Measurement rate		Parameter		DQ, bin no.	X3
Fast	S0	L/Q	M0	RLC	X4
Medium	S1	C/D	M1	RLC, bin no.	X5
Slow	S2	R/Q	M2	RLC, DQ	X6
Equivalent circuit		Range control		RLC, DQ, bin	X7
Parallel	C0	Hold range	R0	Initiation	
Series	C1	Hold rng 1	R1	Start***	G0
Frequency		Hold rng 2	R2	Manual start	
120 Hz (100)	F0	Hold rng 3	R3	Enable switch	E0
1 kHz	F1	Autorange	R4	Disable sw	E1

\*Enables entry of bin limits, which must be entered via keyboard.

\*\*Must be specified before initiation of measurement.

\*\*\*An alternative command is given in manual.

#### 6. ENTRY MODE

Entry-mode keys (left rear block of 16 keys) are effective only when selected DISPLAY is ENTER LIMITS.

##### LIMIT ENTRY PROCEDURE

With [FREQUENCY] select:  
With [DISPLAY] select:  
Use [R/Q] [L/Q] or [C/D] to select units by repeat keying (X) [=] [BIN No.] [0] (X is the desired DQ limit)\* (Y) [=] [NOM VALUE] (Y = number; above units)\* (S) [%] [=] [BIN No.] (Z) (for symmetrical limit pair) (S is number up to 100.00)\* (Z is 1, 2, 3, ... 8). (H) [%] [-] (L) [%] [=] [BIN No.] (Z) (for unsymmetrical limit pair) (H is number up to 10000)\* (L is number up to 100.00)\* To change nom val, reenter.\*\* To change bin limits, reenter. To close a bin, use zero for S. To see, press [NOM VALUE] To see, key in [BIN No.] (Z) Inhibit: [0] [=] [NOM VALUE] Enable: (Y) [=] [NOM VALUE]

##### DISPLAY

120 Hz (100 Hz) or 1 kHz.  
ENTER LIMITS.  
MΩ, kΩ, Ω, H, mH, nF, or μF.  
(X) in DQ display area; max 4 digits and dec pt.  
(Y) in RLC display area; max 5 digits and dec pt.  
Upper limit in RLC area, lower limit in DQ area, (values, not percents).  
Upper limit in RLC area, lower limit in DQ area, (values, not percents.)  
(Y) in RLC display area. Both limit values. Identical limit values. (Y) in RLC display area. Limit values (as above). 0 in RLC display area. (Y) in RLC display area.

##### BIN No.

##### GENERAL ASSIGNMENT

Bin 0	DQ failure
Bin 1	RLC pass, tightest tolerance
Bin 2	RLC pass, next looser tolerance (progressively looser tolerances)
Bin 8	RLC pass, last available bin
Bin 9	RLC fail (default bin)

\*Use numerical and decimal-point keys in sequence to enter number; max of 5 digits and decimal pt valid, even if display is limited to 4.

\*\*New nominal value does not affect bins already set up.

To resume operation using limits entered as above, press [DISPLAY] key (see para 4); do not change frequency.

# Installation—Section 2

2.1	UNPACKING AND INSPECTION . . . . .	2-1
2.2	DIMENSIONS . . . . .	2-1
2.3	POWER-LINE CONNECTION . . . . .	2-1
2.4	LINE-VOLTAGE REGULATION . . . . .	2-2
2.5	TEST-FIXTURE CONNECTIONS . . . . .	2-2
2.6	EXTERNAL BIAS . . . . .	2-2
2.7	HANDLER INTERFACE (OPTION) . . . . .	2-3
2.8	IEEE-488 INTERFACE (OPTION) . . . . .	2-4
2.9	ENVIRONMENT . . . . .	2-8

## 2.1 UNPACKING AND INSPECTION.

If the shipping carton is damaged, ask that the carrier's agent be present when the instrument is unpacked. Inspect the instrument for damage (scratches, dents, broken parts, etc.). If the instrument is damaged or fails to meet specifications, notify the carrier and the nearest GenRad field office. (See list at back of this manual.) Retain the shipping carton and the padding material for the carrier's inspection.

## 2.2 DIMENSIONS.

Figure 2-1.

The instrument is supplied in a bench configuration, i.e., in a cabinet with resilient feet for placement on a table. The overall dimensions are given in the figure.

## 2.3 POWER-LINE CONNECTION.

The power transformer primary windings can be switched, by means of the line voltage switch on the rear panel, to accommodate ac line voltages in either of 2 ranges, as labeled, at a frequency of 50 or 60 Hz, nominal. Using a small screwdriver, set this switch to match the measured voltage of your power line.

If your line voltage is in the lower range, connect the 3-wire power cable (P/N 4200-9625) to the power connector on the rear panel (Figure 1-2) and then to the power line.

The instrument is fitted with a power connector that is in conformance with the International Electrotechnical Commission publication 320. The 3 flat contacts are surrounded by a cylindrical plastic shroud that reduces the possibility of electrical shock whenever the power cord is being unplugged from the instrument. In addition, the center ground pin is longer, which means that it mates first and disconnects last, for user protection. This panel connector is a standard 3-pin grounding-type receptacle, the design of which has been accepted world wide for electronic instrumentation. The connector is rated for 250 V at 6 A. The receptacle accepts power cords fitted with the Belden type SPH-386 connector.

The associated power cord for use with that receptacle, for line voltages up to 125 V, is GenRad part no. 4200-9625. It is a 210-cm (7 ft), 3-wire, 18-gage cable with connector bodies molded integrally with the jacket. The connector at the power-line end is a stackable hammerhead design that conforms to the "Standard for Grounding Type Attachment Plug Caps and Receptacles," ANSI C73.11-1966, which specifies limits of 125 V and 15 A. This power cord is listed by Underwriters Laboratories, Inc., for 125 V, 10 A.

If the fuse must be replaced, be sure to use a "slow blow" fuse of the current and voltage ratings shown on the rear panel, regardless of the line voltage.

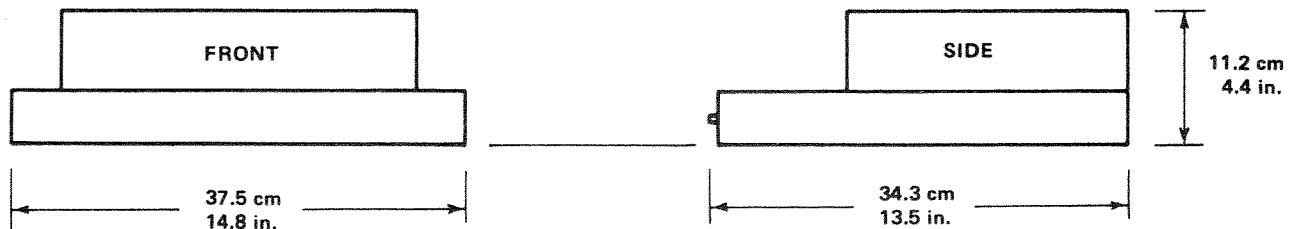

Figure 2-1. Overall dimensions

If your line voltage is in the higher range selectable by the line voltage switch, use a power cord of the proper rating (250 V, 15 A) that mates with both instrument and your receptacle. It is possible to replace the "hammerhead" connector on the power cord that is supplied with a suitable connector. Be sure to use one that is approved for 250 V, 15 A. A typical configuration is shown in Figure 2-2.

## 2.4 LINE-VOLTAGE REGULATION.

The accuracy of measurements accomplished with precision electronic test equipment operated from ac line sources can often be seriously degraded by fluctuations in primary input power. Line-voltage variations of  $\pm 15\%$  are commonly encountered, even in laboratory environments. Although most modern electronic instruments incorporate some degree of regulation, possible power-source problems should be considered for every instrumentation setup. The use of line-voltage regulators between power lines and the test equipment is recommended as the only sure way to rule out the effects on measurement data of variations in line voltage.

## 2.5 TEST-FIXTURE CONNECTIONS.

Because an unusually versatile test fixture is provided on the front shelf of the instrument, no test-fixture connection is generally required. Simply plug the device to be measured (DUT) into the test fixture, with or without its adaptors. For details, refer to para 3.2.

The accessory extender cable 1657-9600 is needed to connect to a DUT that is multiterminal, physically large, or otherwise unsuited for the built-in test fixture. (Refer to Table 1-3.) This cable is needed also to connect impedance standards for

accuracy checks. Use the following procedure to install the extender cable on the instrument.

- Remove the adaptors, if present, from the test fixture. (See para 3.1.)
- Plug the single-connector end of the extender cable into the test fixture, so that its blades enter both slots. Then lock the connector with the 2 captive thumb screws (which also provide a ground connection).
- Notice the color coding of the 5 banana plugs. (I+ is "current source"; I- is "current sense"; both P are "potential sense".)

I+ = RED P+ = RED/WHITE Guard = BLACK/GREEN  
I- = BLACK P- = BLACK/WHITE.

## 2.6 EXTERNAL BIAS

### WARNING

- Maximum bias voltage is 60 V. Do NOT exceed.
- Bias voltage is present at connectors, test fixtures, and on capacitors under test.
- Capacitors remain charged after measurement.
- Do not leave instrument unattended with bias applied.

Full bias voltage appears on test leads, bias-voltage-source terminals, and on the leads of the DUT. Capacitors that have been measured with bias applied can be dangerous until properly discharged, if several of them become connected in series by chance contact. For safety, all personnel operating the instrument with bias must be aware of the hazards, follow safe procedures, and remove bias before leaving the equipment unattended. Refer to para 3.7.

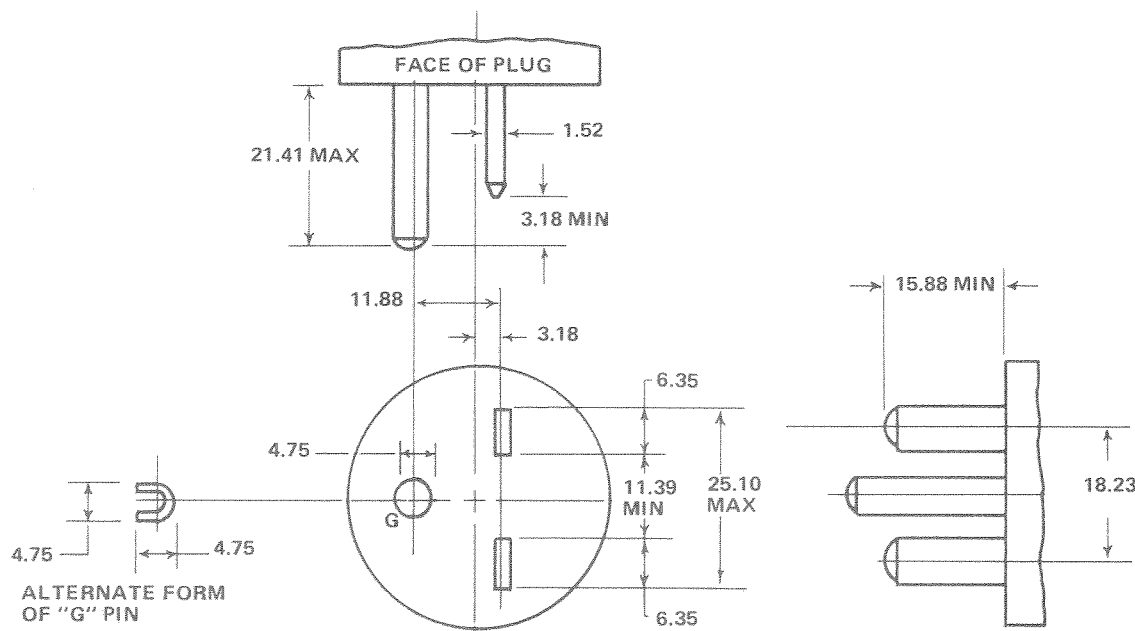

Figure 2-2 Configuration of 250-V 15-A plug. Dimensions in mm. This is listed as NEMA 6-15P. Use for example Hubbell plug number 5666.

In order to measure a capacitor with dc bias voltage applied, connect an external voltage source as follows.

a. Plug the bias cable, supplied, into the BIAS connector, at the rear. Be sure to orient the plug so that the red-tipped wire connects to the + pin. (Refer to the label at the BIAS connector.)

b. Connect the black and red tips to the external bias supply – and + terminals, respectively. The bias voltage source must satisfy several criteria:

1. Supply the desired terminal voltage (dc).
2. Serve as source for charging current; but have current limiting, set to 200 mA.
3. Serve as source and sink for the measuring current (ac), which is 50 mA peak.
4. Present a low, linear terminal impedance ( $\ll 10 \Omega$ ) at measuring frequency.

If the bias voltage source is a regulated power supply with the usual characteristic that it functions properly only as a source, not a sink, then the following test setup is recommended. Connect across the power supply a bleeder resistor that draws dc current at least as great as the peak measuring current (50 mA). In parallel with the bleeder, connect a 100- $\mu$ F capacitor. (If the power supply has exceptionally good transient response, the capacitor is not necessary.)

No single bleeder resistor will suffice for all bias conditions; so it may be necessary to switch among several. Each resistance must be small enough to keep the power supply regulator current unidirectional (as mentioned above) for the smallest bias voltage in its range of usefulness. Also, the resistance and dissipation capacity must be large enough so that neither the power supply is overloaded nor the resistor itself damaged, for the highest bias voltage in its range of application.

#### NOTE

For convenience, a suitable active current sink can be used in lieu of bleeder resistors.

A discharge circuit is also required. (Do not depend on the switch on the Digibridge, nor on the above-mentioned bleeder resistor.) If more than 30 V is sometimes used, a dual discharge circuit is recommended, as follows. One (to be used first) should have a 10- $\Omega$  resistor in series; the other (as a backup) should make a direct connection across the bias circuit.

If the measurement program warrants the expense of a remote test fixture (perhaps in conjunction with a handler), for biased capacitor measurements, it should be provided with the kind of circuit described above. It should have convenient switching to remove the bias source, to discharge through 10  $\Omega$ , and finally to short out the capacitor after measurement. For automated test setups, it is also feasible to precharge the capacitors before attachment to the test fixture and to discharge them after they have been removed.

The equipment should be designed to safeguard personnel from electrical shock and adjusted to avoid the passage of large transient currents through the test fixture.

## 2.7 HANDLER INTERFACE (OPTION).

If you have the interface option, connect from the HANDLER INTERFACE on the rear panel to a handler, printer, or other suitable peripheral equipment as follows. (The presence of the 24-pin connectors shown in Figure 1-2 verifies the interface option.) Refer to Table 1-2 for the appropriate connector. Refer to Table 2-1 for the key to signal names, functions, and pin numbers.

As indicated in the Specifications at the front of this manual, the output signals come from open-collector drivers that pull each signal line to a low voltage when that signal is active and let it float when inactive. Each external circuit must be powered by a positive voltage, up to 30 V (max), with sufficient impedance to limit the active-signal (logic low) current to 40 mA (max).

#### CAUTION

Provide protection from voltage spikes over 30 V.

The cautionary note above means typically that each relay or other inductive load requires a rectifier across it (cathode connected to the power-supply end of the load).

The input signal is also active low and also requires a positive-voltage external circuit, which must pull the signal line down below +0.4 V, but not less than 0.0 V (i.e., not negative). The logic-low current is 0.4 mA (max). For the inactive state (logic high), the external circuit must pull the signal line above +2.4 V but not above +5.0 V.

Table 2-1  
HANDLER INTERFACE KEY

Signal Name	Pin No.	Function (All signals "active low")
-----	5, 6, 7	Ground connection.
-----	10	Plus 5 V, if internal jumper in place. (Limit current to 250 mA.)
		INPUT:
START	1	Initiates measurement (single or avg).
		OUTPUTS:
EOT	18	"End of test"; bin signals are valid.
ACQ OVER	22	"Data acquisition over"; DUT removal OK.
BIN 0	15	No-go because of D or Q limit.
BIN 1	17	Go, bin 1.
BIN 2	19	Go, bin 2.
BIN 3	21	Go, bin 3.
BIN 4	23	Go, bin 4.
BIN 5	14	Go, bin 5.
BIN 6	16	Go, bin 6.
BIN 7	20	Go, bin 7.
BIN 8	24	Go, bin 8.
BIN 9	13	No-go by default (suits no other bin).

Refer to Figure 2-2A for timing guidelines. Notice that START must have a duration of 1  $\mu$ s (minimum) in each state (high and low). If START is provided by a mechanical switch without debounce circuitry, the Digibridge will make many false starts; but these will not cause extraneous test-result signals if START is made to settle down (low) within

20 ms (maximum) of the first transition to high. After completion of the measurement, ACQ OVER goes low, indicating that the DUT can be changed. Then after 10 to 50 ms, measurement results are available for sorting, i.e., one of the BIN lines goes low. A few microseconds later, EOT goes low (can be used to set a latch holding the bin assignment). ACQ OVER, the selected BIN line, and EOT then stay low until the next start command.

Be sure the TALK switch is set to TALK ONLY, if the IEEE-488 bus is not used.

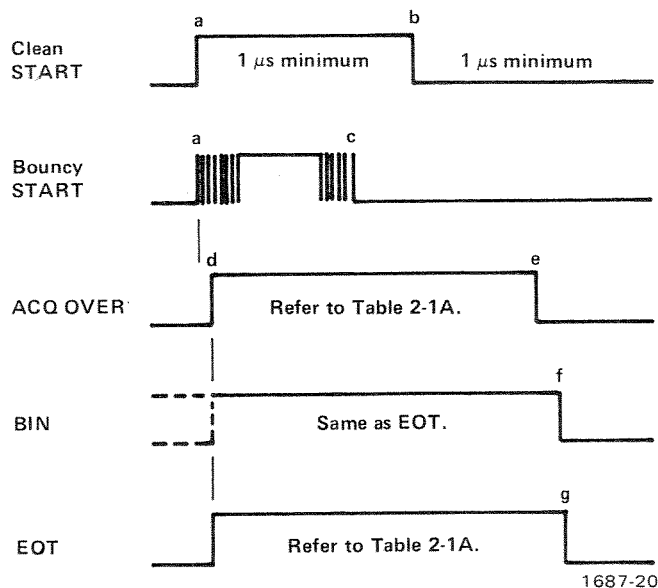

Figure 2-2A. Handler interface timing diagram. External circuitry must keep a-b > 1  $\mu$ s, b-a > 1  $\mu$ s, and (if START is not "debounced") a-c < 20 ms. The DUT can be disconnected after "e." The selected "BIN" line goes low at "f"; the others stay high. Refer to Table 2-1A for the values of ACQ OVER and EOT.

## 2.8 IEEE-488 INTERFACE (OPTION).

### 2.8.1 Purpose.

Figure 2-3.

If you have the interface option, you can connect this instrument into a system (containing a number of devices such as instruments, apparatus, peripheral devices, and generally a controller or computer) in which each component meets IEEE Standard 488-1978, Standard Digital Interface for Programmable Instrumentation. A complete understanding of this Standard (about 80 pages) is necessary to understand in detail the purposes of the signals at the IEEE-488 INTERFACE connector at the rear panel of this instrument. Commendable introductions to the Standard and its application have been published separately, for example: "Standard Instrument Interface Simplifies System Design", by Ricci and Nelson, *Electronics*, Vol 47, No. 23, November 14, 1974.

### NOTE

For copies of the Standard, order "IEEE Std 488-1978, IEEE Standard Digital Interface for Programmable Instrumentation", from IEEE Service Center, Department PB-8, 445 Hoes Lane, Piscataway, N. J. 08854.

Table 2-1A  
HANDLER INTERFACE TIMING DATA

Test Frequency	Line Frequency	Measurement Speed	Time from START signal to	
			ACQ OVER	EOT
1 kHz	50 Hz	FAST	160 ms	185 ms
		MEDIUM	335	370
		SLOW	635	660
1 kHz	60 Hz	FAST	145 ms	170 ms
		MEDIUM	310	335
		SLOW	585	610
120 Hz	60 Hz	FAST	240 ms	265 ms
		MEDIUM	400	425
		SLOW	660	685
100 Hz	50 Hz	FAST	255 ms	280 ms
		MEDIUM	425	450
		SLOW	710	735

Each device is connected to a system bus, in parallel, usually by the use of several stackable cables. Refer to the figure for a hypothetical system. A full set of connections is 24 (16 signals plus shield and ground returns), as tabulated below and also in the Standard. Suitable cables, stackable at each end, are available from Component Manufacturing Service, Inc., West Bridgewater, MA 02379; U.S.A. (Their part number 2024/1 is for a 1-meter-long cable.)

This instrument will function as either a TALK/LISTEN or a TALK ONLY device in the system, depending on the position of the TALK switch. "TALK/LISTEN" denotes full programmability and is suited for use in a system that has a controller or computer to manage the data flow. The "handshake" routine assures the active talker proceeds slowly enough for the slowest listener that is active, but is not limited by any inactive (unaddressed) listener. TALK ONLY is suited to a simpler system — e.g. Digibridge and printer — with no controller and no other talker. Either mode provides measurement results to the active listeners in the system.

### 2.8.2 Interface Functions.

The following functions are implemented. Refer to the Standard for an explanation of the function subsets, represented by the identifications below. For example, T5 represents the most complete set of talker capabilities, whereas P0 means the absence of a capability.

- SH1, source handshake (talker)
- AH1, acceptor handshake (listener)
- T5, talker (full capability, serial poll)
- L4, listener (but not listen-only)

- SR1, service request (request by device for service from controller)
- RL2, remote control (no local lockout, no return-to-local switch)
- PP0, no parallel poll
- DC0, no device clear
- DT1, device trigger (typically starts measurement)
- C0, no controller functions.

The handshake cycle is the process whereby digital signals effect the transfer of each data byte by means of status and control signals. The cycle assures, for example, that the data byte has settled and all listeners are ready before the talker signals "data valid". Similarly, it assures that all listeners have accepted the byte before the talker signals "data not valid" and makes the transition to another byte. Three signal lines are involved, in addition to the 8 that convey the byte itself. Refer to Figure 2-4.

### 2.8.3 Signal Identification.

Refer to Table 2-2 for a key to signal names, functions, and pin numbers. Further explanation is found in the Standard. The first 3 signals listed take part in the "handshake" routine, used for any multiline message via the data bus; the next 5 are used to manage the flow of information; the last 8 constitute the multiline message data bus.

### 2.8.4 Codes and Addresses.

The device-dependent messages, such as instrument programming commands and measurement data (which the digital interface exists to facilitate), have to be coded in a way that

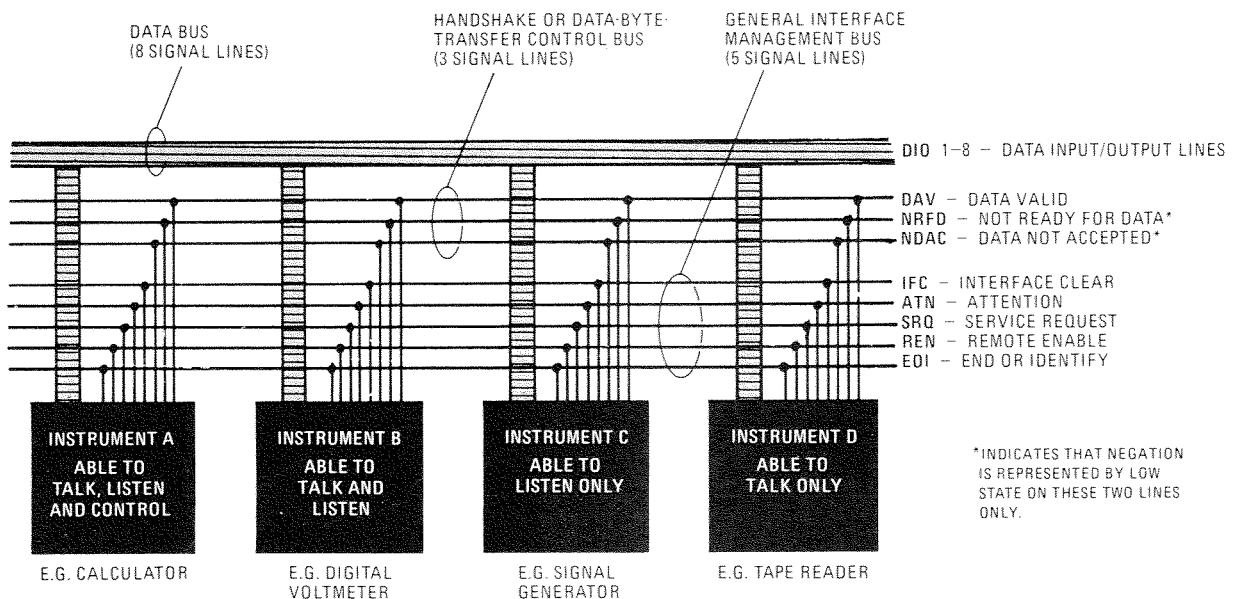

Figure 2-3. Block diagram of a generalized system interconnected by the 16-signal-line bus specified in the IEEE Standard 488. Reprinted from *Electronics*, November 14, 1974; copyright McGraw-Hill, Inc., 1974.



Table 2-2  
IEEE-488 INTERFACE KEY

Pin No.	Signal Name	Function or Significance
6	DAV	Low state: "data is available" and valid on the DI01 . . . DI08 lines.
7	NRFD	Low state: at least 1 listener on the bus is "not ready for data."
8	NDAC	Low state: at least one listener on the bus is "not done accepting data."
11	ATN	"Attention", specifies 1 of 2 uses for the DI01 . . . DI08 lines, as follows. Low state: controller command messages. High state: data bytes from the talker device.
9	IFC	"Interface clear." Low state: returns portions of interface system to a known quiescent state.
10	SRQ	"Service request." Low state: a talker or listener signals (to the controller) need for attention in the midst of the current sequence of events.
17	REN	"Remote enable." Low state: enables each device to enter remote mode when addressed to listen; (Remote-control commands are conveyed while ATN is high.) High state: all devices revert to local control.
5	EOI	"End or Identify." "END" if ATN is in high state, then, low state of EOI indicates end of a multiple-byte data transfer sequence.* "IDY" if ATN is in low state; then, low state of EOI activates a parallel poll.**
1	DI01	The 8-line data bus, which conveys interface messages (ATN low state) or device-dependent messages (ATN high state), such as remote-control commands from the controller or from a talker device.
2	DI02	
3	DI03	
4	DI04	
13	DI05	
14	DI06	
15	DI07	
16	DI08	

\* "END" is typically sent concurrently with the delimiter "linefeed" character that terminates the string(s) of data output from the Digibridge (1, 2, or 3 lines; see para 2.4.8). \*\* IDY is not implemented in the 1658 Digibridge.

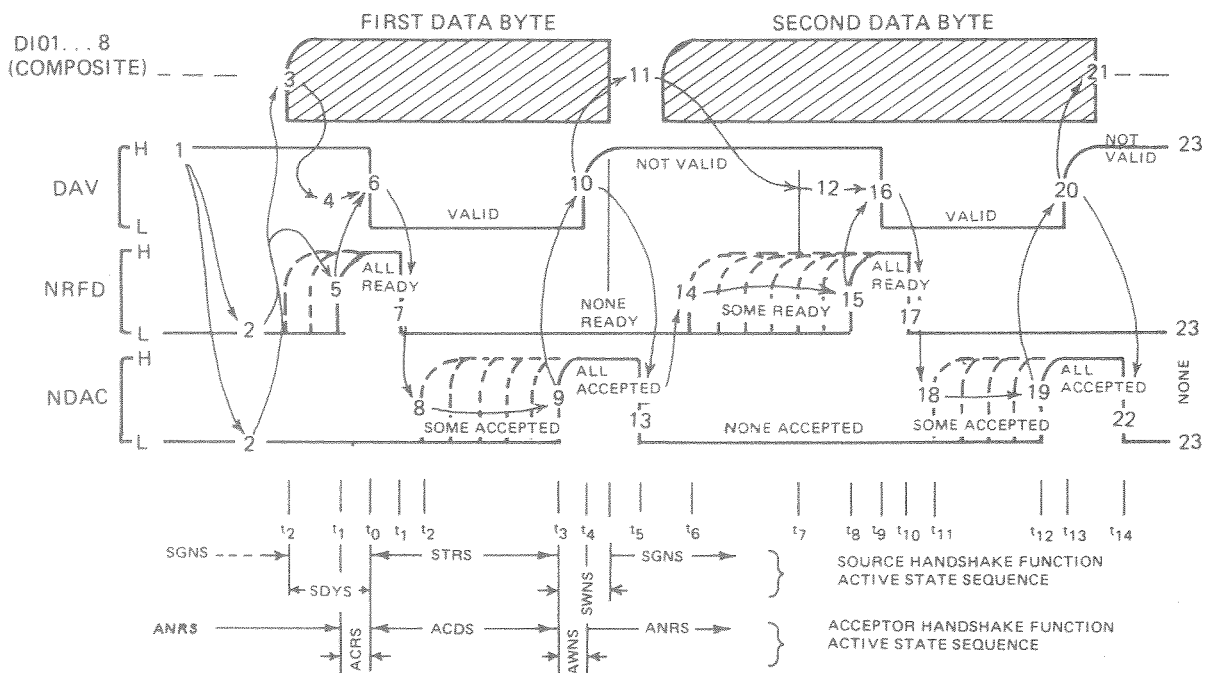

Figure 2-4. The handshake process, illustrated by timing diagrams of the pertinent signals for a system with one talker and several listeners. For details, refer to the Standard.

Table 2-3  
INSTRUMENT PROGRAM COMMANDS

Category	Selection	Command
Display	Enter limits*	D0
	Bin	D1
	Value	D2
Measurement rate	Fast	S0
	Medium	S1
	Slow	S2
Equivalent circuit	Parallel	C0
	Series	C1
Frequency	120 (100) Hz	F0
	1 kHz	F1
Measurement mode	Single	L0
	Average	L1
	Continuous	L2
Range control	Hold range	R0
	Hold range 1	R1
	Hold range 2	R2
	Hold range 3	R3
	Auto-range	R4
Parameter	Inductance (L/Q)	M0
	Capacitance (C/D)	M1
	Resistance (R/Q)	M2
Data output**	None	X0
	Bin number	X1
	DQ	X2
	DQ, bin number	X3
	RLC	X4
	RLC, bin number	X5
	RLC, DQ	X6
	RLC, DQ, bin no.	X7
Initiation***	Start	G0
START switch	Enable	E0
	Disable	E1

\*Enables entry of limits, which must be entered manually (para 3.6).

\*\*Must be specified before initiation of measurement.

\*\*\*An alternative "start" command is GET (group execute trigger), which is binary 0 001 000 in conjunction with ATN in the low state.

is compatible between talkers and listeners. They have to use the same language. Addresses have to be assigned, except in the case of a single "talker only" with one or more "listeners" always listening. The Standard sets ground rules for these codes and addresses.

In this instrument, codes for input and output data have been chosen in accordance with the rules. The address (for both talker and listener functions) is user selectable, as explained below.

*Instrument Program Commands.* Refer to Table 2-3. This input data code is a set of commands to which the instrument will respond as a "talker/listener", after being set to a remote code and addressed to listen to device-dependent command strings.

Notice that the set includes all the keyboard functions except entry of limits, which are not remotely programmable. Also, some of the remote-control commands have no manual-control equivalents. Range control includes the option of selecting specific ranges. Data output commands enable selection of specific classes of measurement results, independently from the actual displays.

Each command is 2 bytes; each byte is coded according to the 7-bit ASCII code, [1] using the DI01 . . . DI07 lines. The most significant bit is DI07, as recommended by the Standard. Thus, for example, the command for "1-kHz test frequency" is F1, having octal code 106 061. The 7-bit binary bytes are therefore: 1 000 110 and 0 110 001. (The ASCII code can be written out as follows. For the numerals 0, 1, 2 . . . 9, write the series of octal numbers 060, 061, 062 . . . 071; for the alphabet A, B, C . . . Z, write the series 101, 102, 103 . . . 132. Refer also to the table in the paragraph about "Address", below. The ASCII code conforms to the 7-bit code ISO 646 used internationally.) Notice that the 8th bit (DI08) is ignored.

*Address.* The initial setting of address, provided by the factory, is binary 00011. Consequently, the talk-address command (MTA) is C in ASCII code and, similarly, the listen-address command (MLA) is #. If a different address pair is desired, set it manually using the following procedure.

#### WARNING

**Because of shock hazard and presence of electronic devices subject to damage by static electricity (conveyed by hands or tools), disassembly is strictly a "service" procedure.**

a. Take the instrument to a qualified electronic technician who has the necessary equipment; refer to para 5.6. Have him remove the interface option assembly, as described in that paragraph. (There is no need to remove the top cover first.)

b. Have him set the switches in "DIP" switch assembly S2 to the desired address, which is a 5-bit binary number. (Refer to the comments below.)

c. Have him replace the interface option assembly in its former place.

Notice that S2 is located at the end of the interface option board, about 3 cm (1 in.) from the TALK switch S1. If S2 is covered, lift the cover off, exposing the "DIP" switch, which has 2 rows of 6 tiny square pads with numbers 1 . . . 6 between the rows. To enter logical 1's, depress pads nearest the end of the board. To enter logical 0's, depress pads on the other side of the "DIP" switch, the side marked with a + sign. The address is read from 5 to 1 (not using 6). Thus,

[1] "X3.4 - 1968, Code for Information Interchange", available from American National Standards Institute, 1430 Broadway, New York, N.Y. 10018.

Table 2-4  
ADDRESS PAIRS AND SETTINGS FOR SWITCH S2

Talk address Symbol	Binary	Listen address Symbol	Binary	Switch setting*				
				5	4	3	2	1
@	1 000 000	(space)	0 100 000	0	0	0	0	0
A	1 000 001	!	0 100 001	0	0	0	0	1
B	1 000 010	"	0 100 010	0	0	0	1	0
C	1 000 011	#	0 100 011	0	0	0	1	1
D	1 000 100	\$	0 100 100	0	0	1	0	0
E	1 000 101	%	0 100 101	0	0	1	0	1
F	1 000 110	&	0 100 110	0	0	1	1	0
G	1 000 111	'	0 100 111	0	0	1	1	1
H	1 001 000	(	0 101 000	0	1	0	0	0
I	1 001 001	)	0 101 001	0	1	0	0	1
J	1 001 010	*	0 101 010	0	1	0	1	0
K	1 001 011	+	0 101 011	0	1	0	1	1
L	1 001 100	,	0 101 100	0	1	1	0	0
M	1 001 101	--	0 101 101	0	1	1	0	1
N	1 001 110	.	0 101 110	0	1	1	1	0
O	1 001 111	/	0 101 111	0	1	1	1	1
P	1 010 000	0	0 110 000	1	0	0	0	0
Q	1 010 001	1	0 110 001	1	0	0	0	1
R	1 010 010	2	0 110 010	1	0	0	1	0
S	1 010 011	3	0 110 011	1	0	0	1	1
T	1 010 100	4	0 110 100	1	0	1	0	0
U	1 010 101	5	0 110 101	1	0	1	0	1
V	1 010 110	6	0 110 110	1	0	1	1	0
W	1 010 111	7	0 110 111	1	0	1	1	1
X	1 011 000	8	0 111 000	1	1	0	0	0
Y	1 011 001	9	0 111 001	1	1	0	0	1
Z	1 011 010	:	0 111 010	1	1	0	1	0
[	1 011 011	;	0 111 011	1	1	0	1	1
\	1 011 100	<	0 111 100	1	1	1	0	0
]	1 011 101	=	0 111 101	1	1	1	0	1
^	1 011 110	>	0 111 110	1	1	1	1	0

\* Do NOT set the switch to 11111, because a listen address of "?" would be confused with an "attention" command. (ASCII code for "underscore" is 1 011 111, and for "?" is 0 111 111.)

for example, to set up the address 00011, enter 0's at positions 5, 4, 3; enter 1's at positions 2, 1. (This makes the talk address "C" and the listen address "#".) Strictly speaking, the address includes more; S2 determines only the device-dependent bits of the address. You cannot choose talk and listen addresses separately, only as a pair. The list of possible pairs is shown in Table 2-4.

In the above example, the remote message codes MLA and MTA are X0100011 and X1000011, respectively. Thus the listen address and the talk address are distinguished, although they contain the same set of device-dependent bits, which you set into S2.

**Data Output.** Data (results of measurements) are provided on the DI01 . . . DI07 lines as serial strings of characters. Each character is a byte, coded according to the 7-bit ASCII code, as explained above. The alphanumeric characters used are appropriate to the data, for convenience in reading printouts. The character strings are always provided in the same sequence as that shown in Table 2-3; for example: RLC value, DQ value, bin number — if all 3 were selected (by the X7 command). The carriage-return and line-feed characters at the end of each string provide a printer (for example) with the basic commands to print each string on a separate line.

For example, if the measurement was .00325 kΩ (range 2), the character string for RLC value is:

U(space)R(space)kO(space)(space)0.00325(CR)(LF).

If a dissipation-factor measurement was .2345, the character string for DQ value is:

(space)(space)D(6 spaces)0.2345(CR)(LF).

If the measurement falls into bin 9, the character string for bin number is:

F(space)BIN(space) (space)9(CR)(LF).

The character string for RLC value has the length of 17 characters; for DQ value, 17 characters; for bin number, 10 characters — including spaces, carriage-return, and line-feed characters. Refer to Tables 2-5, 2-6, and 2-7 for details.

**Status.** The Digibridge responds with a status byte when the bus is in the serial poll mode and the Digibridge is addressed to talk. The status is encoded as shown in Table 2-8 and sent on the data lines DI01 . . . DI08.

### 2.8.5 Programming Guidelines.

If the Digibridge is to be programmed (TALK switch set to TALK/LISTEN), keep the following suggestions in mind.

1. An "unlisten" command is required before measurement is possible.
2. If not addressed to talk, the Digibridge sends a service request (SRQ low) when it has data ready to send.
3. Then SRQ will not go false (high) until the Digibridge has been addressed to talk or has been serially polled.

A typical program might include these features:

- Initial setup: with ATN true, "untalk, unlisten, my listen address (of Digibridge), my talk address (of CPU)"; then with ATN false, measurement conditions (Table 2-3).
- Measurement-enabling sequence, for example: untalk the Digibridge, send a GET, unlisten the Digibridge.
- After CPU receives the SRQ, necessary enabling of data transfer: with ATN true, "untalk, unlisten, my listen address (of CPU), my talk address (of Digibridge)"; then ATN false.

## 2.9 ENVIRONMENT.

The Digibridge can be operated in nearly any environment that is comfortable for the operator. Keep the instrument and all connections to the parts under test away from electro-magnetic fields that may interfere with measurements.

Refer to the Specifications at the front of this manual for temperature and humidity tolerances. To safeguard the instrument during storage or shipment, use protective packaging. Refer to Section 5.

Table 2-5  
RLC-VALUE DATA OUTPUT FORMAT

Character sequence	Purpose	Allowed characters	Meaning
1	Status	(space) U O W	Normal operation Underrange Overrange Wrong parameter or other invalidity
2	Format	(space)	----
3	Parameter	R L C	Resistance Inductance Capacitance
4	Format	(space)	----
5, 6	Units	(space)O kO MO (space)H mH uF nF	Ohms Kilohms Megohms Henries Millihenries Microfarads Nanofarads
7, 8	Format	(space)	----
9...15	Number	012345 6789. (space)	Measured number, right justified in format field; like the RLC display except the zero before the decimal point is explicitly provided and this number can be as long as 7 characters.
16	----	(CR)	The customary "carriage-return" and "line-feed" characters, end of string.
17	Delimiter	(LF)	

Table 2-6  
DQ-VALUE DATA OUTPUT FORMAT

Character sequence	Purpose	Allowed characters	Meaning
1, 2	Format	(space)	----
3	Parameter	D Q	Dissipation factor Quality factor
4...9	Format	(space)	----
10...15	Number	012345 6789. (space)	Measured number, right justified in format field, like the DQ display except the zero before the decimal point is explicitly provided and this number can be as long as 6 characters.
16	----	(CR)	The customary "carriage-return" and "line-feed" characters, end of string.
17	Delimiter	(LF)	

**Table 2-7**  
BIN-NUMBER DATA OUTPUT FORMAT

Character sequence	Purpose	Allowed characters	Meaning
1	Pass/fail	(space) F	GO (bins 1 . . . 8) NO-GO (bin 0 or 9)
2	Format	(space)	----
3	Label	B	The word "BIN".
4		I	
5		N	
6, 7	Format	(space)	----
8	Category	01234 56789	Bin number assignment.
9	----	(CR)	The customary "carriage-return" and "line-feed" characters,
10	Delimiter	(LF)	end of string.

**Table 2-8**  
STATUS CODE

Line	Significance of a "1"	Significance of a "0"
DI08	Remote	Local
DI07	Request for service, RQS. (This device asserted SRQ.)	No request by this Digibridge for service
DI06	Wrong parameter	Normal operation
DI05	Busy, measurement in process	Measurement completed
DI04	Limits were tested.	Limits were not tested.
DI03	RLC measured value is available.	RLC value is not available.
DI02	DQ measured value is available.	DQ value is not available.
DI01	Bin-no. assignment is available.	Bin-no. assignment is not available.

# Operation—Section 3

3.1	BASIC PROCEDURE . . . . .	3-1
3.2	CONNECTION OF DUT . . . . .	3-2
3.3	ACCURACY AND SPEED . . . . .	3-3
3.4	TEST FREQUENCY AND EQUIVALENT CIRCUIT . . . . .	3-5
3.5	PARAMETER, RANGE HOLDING, AND MODE . . . . .	3-7
3.6	LIMIT-COMPARISON BINS . . . . .	3-9
3.7	BIAS . . . . .	3-11
3.8	OPERATION WITH HANDLER . . . . .	3-12
3.9	SYSTEM CONSIDERATIONS . . . . .	3-12

## 3.1 BASIC PROCEDURE.

For initial familiarization, follow this procedure carefully. After that, use this as a ready reference and refer to later paragraphs in Operation for details.

Refer also to the Operation Reference Information, found stored in a pocket under the instrument. Reach under the front edge and pull the card forward as far as it slides easily. After use, slide it back in the pocket, for protection.

### CAUTION

Set the line voltage switch properly (rear panel) before connecting the power cord.

a. Before connecting the power cord, slide the line-voltage switch (rear panel) to the position that corresponds to your power-line voltage. Power must be nominally 50 or 60 Hz ac, in either range: 90 to 125 V or 180 to 250 V. Connect the power cord to the rear-panel connector, and then to your power line.

*Power.* Depress the POWER button so that it stays in the depressed position. (To turn the instrument off, push and release this button so that it remains in the released position.)

b. Connect a typical device, whose impedance is to be measured, as follows. (This device under test is denoted DUT.)

### NOTE

Clean the leads of the DUT if they are noticeably dirty, even though the test-fixture contacts will usually bite through a film of wax to provide adequate connections.

*Radial-lead DUT.* Insert the leads into the test-fixture slots as shown in Figure 1-1. For details of wire size and spacing limits, refer to para 3.2.

*Axial-lead DUT.*

Figure 3-1A.

Install the test-fixture adaptors, supplied, one in each slot of the test fixture, as shown in the accompanying figure.

Slide the adaptors together or apart so the body of the DUT will fit easily between them. Press the DUT down so that the leads enter the slots in the adaptors as far as they go easily. For details of wire size and DUT size limits, refer to para 3.2.

### NOTE

To remove each adaptor, lift with a gentle tilt left or right. For a DUT with very short leads, it is important to orient each adaptor so its internal contacts (which are off center) are close to the DUT.

*Any other DUT or test fixture.* Use the accessory extender cable. Refer to para 3.2.

c. Choose the conditions of measurement. For the first 6 selections, below, the recommended choice is automatically provided when you switch the POWER ON. (To obtain another choice, press the corresponding key in the keyboard as many times as necessary, watching the indicator lights.)

*Display:* VALUE

*Measurement Rate:* MEDIUM

*Equivalent Circuit:* SERIES

*Frequency:* 1 kHz

*Measurement Mode:* CONTINUOUS

*Hold Range:* NOT selected; autorange is indicated by having the RANGE HELD light out

*External Bias switch:* OFF

*Talk switch:* TALK ONLY (rear panel). [1]

*Parameter.* For resistance, press R/Q; for inductance, press L/Q; for capacitance, press C/D. The choice is confirmed by illumination of appropriate unit label in the RLC display.

d. Read the measurement on the main displays. The RLC display is the principal measurement, complete with decimal point and units which are indicated by the light spot behind  $M\Omega$ ,  $k\Omega$ ,  $\Omega$ , H, mH, nF, or F. [2] The DQ display is D if the selected parameter is C/D; it is Q if the selected parameter is L/Q or R/Q.

[1] This switch is provided only if you have the Interface Option.

[2] If the extender cable is used, it may be necessary to correct for its capacitance.

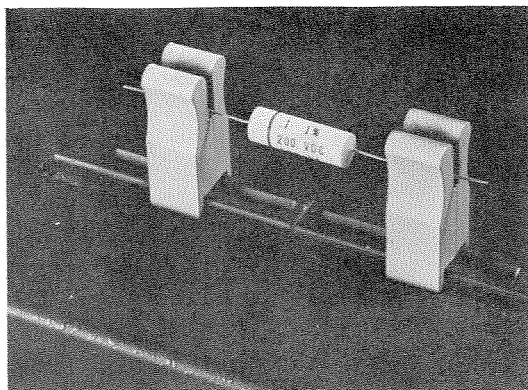

Figure 3-1A. Use of the test fixture adaptors.

#### NOTE

The following actions or conditions will abort measurements in progress or prevent measurement.

1. Pressing any key listed in step c above *except HOLD RANGE*, will abort the current measurement.
2. If there is no proper IEEE-488 system connection and the TALK switch on the rear panel is switched to TALK/LISTEN, continuous measurement is inhibited. (If you have the Interface Option, generally keep this switch set to TALK ONLY.)

### 3.2 CONNECTION OF THE DUT.

#### 3.2.1 The Integral Test Fixture.

The test fixture provided on the front ledge of the Digi-bridge provides convenient, reliable, guarded 4-terminal connection to any common radial-lead or axial-lead component part.

The slots in the test fixture accommodate wires of any diameter from 0.25 mm (.01 in., AWG 30) to 1 mm (.04 in., AWG 18), spaced from 6 to 98 mm apart (0.23 to 3.9 in.) or equivalent strip conductors. Each "radial" wire must be at least 1 cm long (0.4 in.). The divider between the test slots contains a shield, at guard potential, with its edges exposed. The adaptors accommodate wires of any diameter up to 1.5 mm (.06 in., AWG 15). The body of the DUT that will fit between these adaptors can be 80 mm long and 44 mm diameter (3.1 x 1.7 in.) maximum. Each "axial" wire must be at least 3 mm long (0.12 in.).

For radial-lead parts, remove each adaptor from the test fixture by a gentle pull upward, made easier by tilting the adaptor left or right (never forward or back). For axial-lead parts, insert the adaptors, one in the left slot and the other in the right slot of the test fixture, by pushing vertically downward. Each adaptor can be slid left and right to match the length of DUT to be measured. Notice that the contacts inside the adaptor are off center; be sure to orient the adaptors so the contacts are close to the body of the DUT, especially if it has short or fragile leads.

### 3-2 OPERATION

Insert the DUT so one lead makes connection on the left side of the test fixture, the other lead on the right side. Insertion and removal are smooth, easy operations and connections are reliable if leads are reasonably clean and straight.

Be sure to remove any obvious dirt from leads before inserting them. The test-fixture contacts will wipe through a film of wax, but will become clogged and ineffectual if you are careless about cleanliness. Be sure the contact pair inside each half of the test fixture is held open by a single item **ONLY**, whether that is one lead of an axial-lead DUT or one adaptor. (Otherwise you will not obtain true "Kelvin" connections to the DUT.)

#### 3.2.2 The Extender Cable.

Figure 3-1B.

The accessory extender cable described in Table 1-3 is needed to connect any DUT that is multiterminal, physically large, or otherwise unsuited for the built-in test fixture. This cable is needed, for example, to connect impedance standards or a remote test fixture. Make connections as follows.

- a. Remove the adaptors from the test fixture. Plug the extender cable into the basic test fixture and lock the connection with the 2 captive thumb screws.
- b. Using the branched end of the cable, connect to the DUT with careful attention to the following color code. The cable tips are stackable banana plugs (adaptable with slip-on alligator clips, supplied). Notice that the 2 red tips must connect to the same end of the DUT. Connect both black and black/white tips to the other end.

#### EXTENDER CABLE COLOR CODE

- RED: I+, current connection to "high" end of DUT.
- RED & WHITE: P+, potential connection to same.
- BLACK: I-, current connection to "low" end of DUT.
- BLACK & WHITE: P-, potential connection to same.
- BLACK & GREEN: G, guard connection to shield or case (if isolated from the preceding terminals). Do not connect G to the case of a capacitor if the case serves as (or is connected to) one of its 2 main terminals.

#### 3.2.3 Correction for Cable Capacitance.

The extender cable adds capacitance in parallel with the DUT (because shielding of the leads is imperfect). The 1657-9600 cable adds about 0.5 pF. Because the physical arrangement and spacing of the cable branches and connectors is significant, a correction should be determined for each measurement setup. The following procedure applies to connection with a precision 3-terminal capacitor, GR 1404 or 1413, for example.

- a. Install an adaptor, GR 874-Q2, on each of the two coaxial connectors, L and H, of the capacitor.
- b. Connect cable branch G to the ground post of the "low" terminal adaptor. With a clip lead or plain wire, connect this point to the ground post of the "high" adaptor.
- c. Connect cable branch P- to the main post of the "low" adaptor and stack I- on top of P-.



Figure 3-1B. Extender cable, attached to test fixture.

- d. Similarly, connect P+, with I+ stacked on top of it, to the main post of the "high" adaptor.
- e. Measure this total capacitance, the sum of the desired measurement and the cable capacitance,  $C_x + C_c$ .
- f. Carefully lift the stacked pair of cable tips, I+/P+, from the "high" adaptor and hold them about 0.5 cm (1/4 in.) above the binding post where they were connected. DO NOT rearrange the cable branches or change their spacing more than is absolutely necessary to follow these directions. Hold the plastic tips (not the wires) and touch the guard (G) circuit firmly with a couple of fingers, to minimize the effect of capacitance in your body.
- g. Measure the cable capacitance,  $C_c$ .
- h. Subtract the result of step g from that of step e, to obtain the desired measurement,  $C_x$ .

### 3.3 ACCURACY AND SPEED.

The basic accuracy of this Digibridge is 0.1% of reading R, L, or C, over wide ranges of values, for suitable measurement conditions. Outside of these ranges and conditions,

accuracy drops off in known ways, which should be understood by the operator. For example, selection of a faster measurement rate leads to less accurate measurements. To facilitate choice of conditions (if optional) and determination of accuracy for any particular results, refer to the accuracy statement in the specifications at the front of this manual, as well as the following graphs.

#### 3.3.1 RLC Basic Accuracy.

Figure 3-2.

This graph shows that the basic accuracy extends for 6 decades (for example  $2 \Omega$  to  $2 M\Omega$ ), over the 3 basic ranges. In high overrange and low underrange, the best available accuracy rises a factor of 10 for each decade of impedance ( $45^\circ$  lines on graph). If a range is "held", the basic accuracy is valid for only 2 decades, beyond which there are similar overrange conditions.

*Measurement Rate.* The same graph shows the effects of choosing rate. To obtain 0.1% accuracy, select SLOW MEASUREMENT RATE. Lower accuracies (higher percentage) are obtained at higher rates, as shown by the alternative scales at the left.



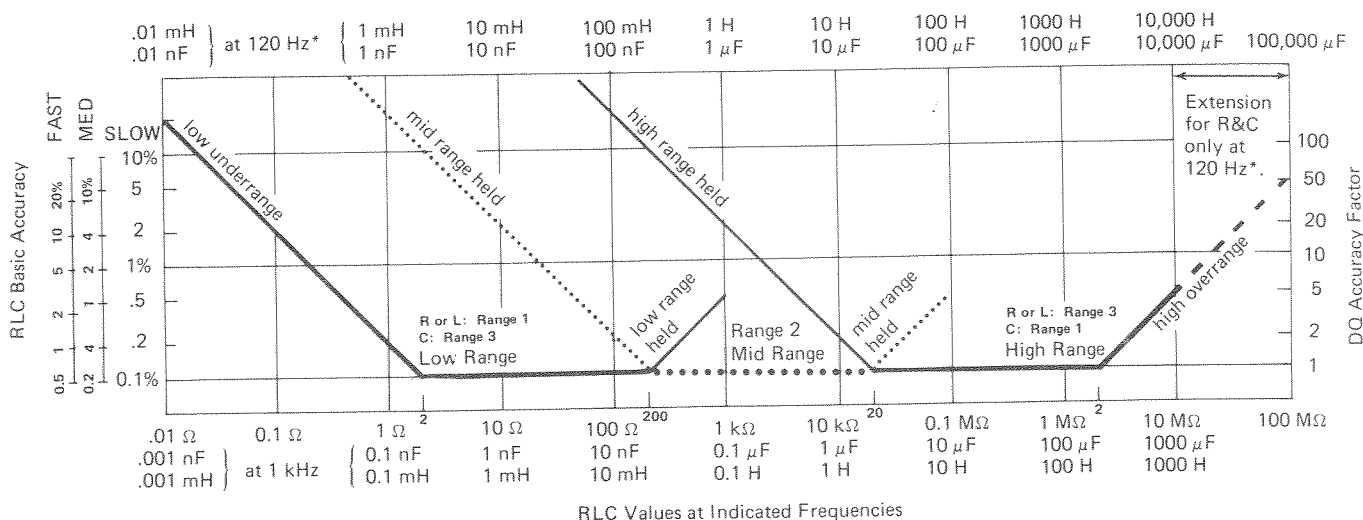

Figure 3-2. RLC basic accuracy as a percent of reading. Heavy lines (solid and dotted) represent auto-ranging (range not held). Lighter lines represent reduced-accuracy operation due to a range being held. Range 2 is dotted. Notice that L and C scales above graph are for 120 Hz (\*equally valid for 100 Hz) and the 2 below graph are for 1 kHz. The DQ accuracy factor (right-hand scale) is the multiplier that, applied to the DQ basic accuracy, yields complete DQ accuracy, for range extensions as well as the basic ranges. (Range extensions are all represented by slanted lines.)

This basic RLC accuracy is valid only for "pure" R, L, or C. For the effect of quadrature impedance, multiply each basic accuracy value by the RLC accuracy factor; see below.

### 3.3.2 RLC Accuracy Factor.

Figure 3-3.

This graph shows the effect of D (or Q) on the accuracy of R, L, and C measurements. Multiply the RLC basic accuracy by this factor. For example, suppose a resistor is measured at SLOW MEASUREMENT RATE to be 1.0 Ω, with Q = 0.5. The RLC basic accuracy is 0.2% and the RLC accuracy factor is 1.5; so the accuracy of the R measurement is 0.3%.

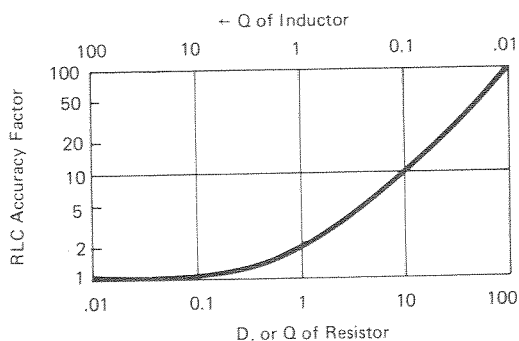

Figure 3-3. RLC accuracy factor (or cross term), as a function of D or Q. Multiply the RLC basic accuracy by this factor to obtain complete RLC accuracy. Notice that for nearly "pure" resistance or reactance, this factor is unity.

### 3.3.3 D and Q Accuracy.

Figures 3-4, 3-5.

These graphs show the basic accuracy of each D and Q measurement directly for impedances in the basic ranges (the main, horizontal line in the RLC basic accuracy graph). For the above-mentioned example (Q = 0.5) the graph shows a basic accuracy of 0.25%. However, for any overrange or underrange measurement (45° lines on RLC basic accuracy graph), use the following correction factor.

**DQ Accuracy Factor.** This factor is directly proportional to the RLC basic accuracy; refer to the scale at the right of that graph (above). For the above-mentioned example, the DQ accuracy factor is 2; therefore, the Q measurement accuracy is 0.5%.

### 3.3.4 Convenience of Logarithmic Scales.

The logarithmic scales on these figures make it very easy to apply the accuracy factors *visually*. For example, suppose a capacitor is being measured on one of the basic ranges, with the SLOW measurement rate; and the D display is about 1. Figure 3-3 shows that the C accuracy factor is about 1/3 of a decade on the logarithmic scale. On Figure 3-2, find the heavy horizontal line and point to the basic C accuracy (0.1%) at the left. Now apply the C accuracy factor by moving the pointer up about 1/3 of a decade. The pointer now shows the corrected C accuracy, 0.2%.

### 3.3.5 Insignificant Digits.

One or more of the digits at the right end of the RLC and/or DQ displays may be insignificant. This is particularly

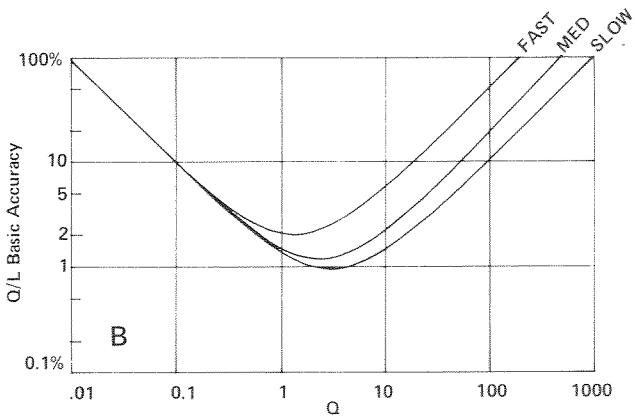
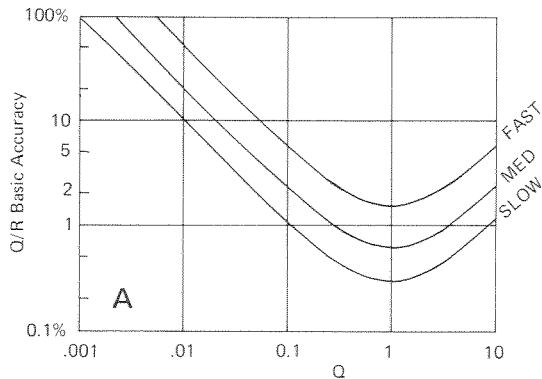

Figure 3-4. Q basic accuracy as a percent of reading. Each curve applies for one measurement rate, as labeled. For measurements on any of the range extensions, multiply by the DQ accuracy factor, shown in Figure 3-2. A. Q of resistors. B. Q of inductors.

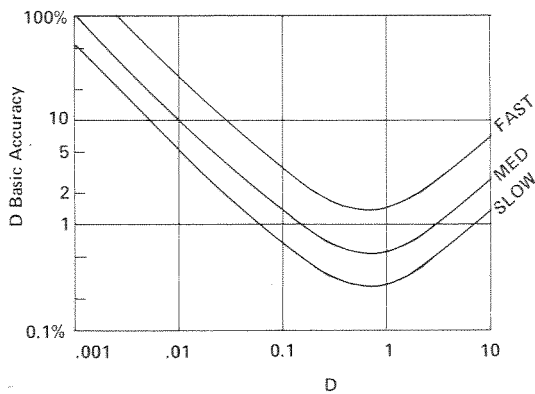

Figure 3-5. D basic accuracy as a percent of reading (for capacitors). Each curve applies to one measurement rate, as labeled. For measurements on any of the range extensions, multiply by the DQ accuracy factor, shown in Figure 3-2.

true at the upper extension of a range. If there are more than one insignificant digits in a display, the least significant is typically noisy. That is, it will appear to flicker at random over a range of values and should be ignored.

For example, if you measure a 4-M $\Omega$  resistor, the display might ideally be 4.1234 M $\Omega$ ; but the one or two final digits

might be changing at random. This flickering is entirely normal. The specified accuracy ( $\pm 0.4\%$ ) is the key to expected performance; in this example, the last 2 digits are insignificant and the last digit is quite unnecessary. Typically, one would record this measurement as 4.12 M $\Omega \pm .02$  M $\Omega$ .

### 3.3.6 Measurement Rate.

Choose one of 3 rates with the MEASURE RATE key: SLOW, MEDIUM, or FAST. The continuous-mode rates are respectively about 2, 3, and 7 measurements per second. Range changes introduce some delays. For details, refer to the following specifics.

For CONTINUOUS measurement mode, steady state, each measurement requires a *base period* of about 570, 310, or 145 ms, depending on whether the measurement rate is SLOW, MEDIUM, or FAST, respectively. To that base period, add approximately 25 ms (for test frequency 1 kHz) or 100 ms (for 120 or 100 Hz) for *startup* following each press of the START button. If the Digibridge is autoranging and a given measurement is out of range, the next measurement requires as much time as *startup plus base period* (the same total as for SINGLE measurement initiated by START). In AVERAGE measurement mode, the time required for an entire measurement sequence, initiated by START, is *startup plus 10 base periods*.

## 3.4 TEST FREQUENCY AND EQUIVALENT CIRCUIT.

### 3.4.1 General.

Except for very large values of the principal measurement, you can select either measurement frequency: 1 kHz or 120 (100) Hz. The lower frequency is required to measure above 10 M $\Omega$ , 1000  $\mu$ F, or 1000 H. There is no such restriction on the choice of equivalent circuit, although there are rules to follow, as explained below.

The value of the principal measurement (R, L, or C) of a certain DUT depends on which of 2 equivalent circuits is chosen to represent it. (Many impedance measuring instruments provide no choice in the matter, but this one allows selection). The more nearly "pure" the resistance or reactance, the more nearly identical are the "series" and "parallel" values. However, for D or Q near unity, the difference is substantial. Also, the principal measurement often depends on measurement frequency. The more nearly "pure" the resistance or reactance, the less is this dependence. However, for D or Q near unity and/or for measuring frequency near the self-resonant frequency of the DUT, this dependence is quite substantial. We first give general rules for selection of measurement parameters, then some of the theory.

### 3.4.2 Rules.

*Specifications.* The manufacturer or principal user of the DUT probably specifies how to measure it. (Usually "series" is specified for C, L, and low values of R.) Select "parallel" or "series" and 1 kHz or 120 Hz (100 Hz) according to the applicable specifications. If there are none known,

be sure to specify with your results whether they are "parallel" or "series" and what the measurement frequency was.

**Resistors, below about 1 kΩ: Series, 120 Hz (100 Hz).**

Usually the specifications call for dc resistance, so select a low test frequency to minimize ac losses. Select "series" because the reactive component most likely to be present in a low resistance resistor is series inductance, which has no effect on the measurement of series R. If the Q is less than 0.1, the measured Rs is probably very close to the dc resistance.

**Resistors, above about 1 kΩ: Parallel, 120 Hz (100 Hz).**

As explained above, select a low test frequency. Select "parallel" because the reactive component most likely to be present in a high-resistance resistor is shunt capacitance, which has no effect on the measurement of parallel R. If the Q is less than 0.1, the measured Rp is probably very close to the dc resistance.

**Capacitors below 2 nF: Series, 1 kHz.** Unless otherwise specified or for special reasons, always select "series" for capacitors and inductors. This has traditionally been standard practice. Select a high measurement frequency for best accuracy.

**Capacitors above 200 μF: Series, 120 Hz (100 Hz).**

Select "series" for the reasons given above. Select a low measurement frequency for best accuracy and to enable measurement of capacitors larger than 1000 F.

**Inductors below 2 mH: Series, 1 kHz.** Select "series" as explained above. Select a high measurement frequency for best accuracy.

**Inductors above 200 H: Series, 120 Hz (100 Hz).** Select "series" as explained before. Select a low measurement frequency for best accuracy and to enable measurement of inductors larger than 1000 H.

### 3.4.3 Series and Parallel Parameters.

Figure 3-6.

An impedance that is neither pure reactance nor a pure resistance can be represented at any specific frequency by either a series or a parallel combination of resistance and reactance. Keeping this concept in mind will be valuable in operation of the instrument and interpreting its measurements. The values of resistance and reactance used in the equivalent circuit depend on whether a series or parallel combination is used. The equivalent circuits are shown in the accompanying figure, together with useful equations relating them. Notice that the Digibridge measures only Rs, Ls, or Cs, if you select **SERIES EQUIVALENT CIRCUIT**. It measures only Rp, Lp, or Cp if you select **PARALLEL**.

### 3.4.4 Equivalent Series R for Capacitors.

The total loss of a capacitor can be expressed in several ways, including D and "ESR", which stands for "equivalent series resistance". To obtain ESR, one can measure directly; push the R/Q parameter key and select **SERIES EQUIVALENT CIRCUIT**.

Both C and ESR should be measured on the same range. If D is below 1, depress the C/D key and measure Cs first,

### Resistance and Inductance

$$Z = R_s + j\omega L_s \quad Z = \frac{j\omega L_p R_p}{R_p + j\omega L_p} \quad Z = \frac{R_p + jQ^2\omega L_p}{1 + Q^2}$$

$$Q = \frac{1}{D} \quad Q = \frac{\omega L_s}{R_s} \quad Q = \frac{R_p}{\omega L_p}$$

$$L_s = \frac{Q^2}{1 + Q^2} L_p \quad L_s = \frac{1}{1 + D^2} L_p$$

$$L_p = \frac{1 + Q^2}{Q^2} L_s \quad L_p = (1 + D^2) L_s$$

$$R_s = \frac{1}{1 + Q^2} R_p \quad R_p = (1 + Q^2) R_s$$

$$R_s = \frac{\omega L_s}{Q} \quad R_p = Q\omega L_p \quad R_p = \frac{1}{G_p}$$

### Resistance and Capacitance

$$Z = R_s + \frac{1}{j\omega C_s} \quad Z = \frac{R_p}{1 + j\omega R_p C_p} \quad Z = \frac{D^2 R_p + 1/(j\omega C_p)}{1 + D^2}$$

$$D = \frac{1}{Q} \quad D = \omega R_s C_s \quad D = \frac{1}{\omega R_p C_p}$$

$$C_s = (1 + D^2) C_p \quad C_p = \frac{1}{1 + D^2} C_s$$

$$R_s = \frac{D^2}{1 + D^2} R_p \quad R_p = \frac{1 + D^2}{D^2} R_s$$

$$R_s = \frac{D}{\omega C_s} \quad R_p = \frac{1}{\omega C_p D} \quad R_p = \frac{1}{G_p}$$

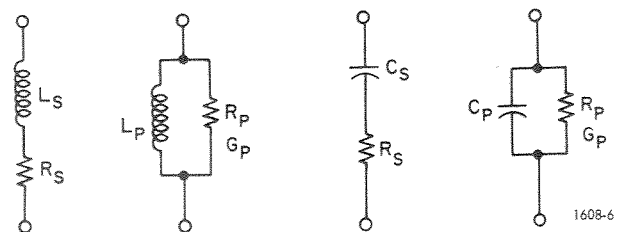

Figure 3-6. Equivalent circuits and mathematical relationships for lossy inductors and capacitors.

select HOLD RANGE, depress the R/Q key, and measure Rs. On the other hand, if D is above 1, measure Rs first, select HOLD RANGE, and then measure Cs.

"Equivalent series resistance" is larger than the actual resistance of the wire leads and foils that are physically in series with the heart of a capacitor. ESR includes also the effect of dielectric loss. Generally, measured ESR is closer to actual series resistance for capacitors with lower reactance (larger capacitance and/or higher test frequency).

### 3.4.5 Parallel Equivalent Circuits for Inductors.

Even though it is customary to measure series inductance of inductors, there are situations in which the parallel equivalent circuit better represents the physical device. At low frequencies, the significant loss mechanism is usually "ohmic" or "copper loss" in the wire; and the series circuit is appropriate. If there is an iron core, at higher frequencies the significant loss mechanism may be "core loss" (related to eddy currents and hysteresis); and the parallel equivalent circuit is appropriate. Whether this is true at 1 kHz should be determined by an understanding of the DUT, but probably it is so if the following is true: that measurements of Lp at 1 kHz and at 120 Hz (100 Hz) are more nearly in agreement than measurements of Ls at the same 2 frequencies.

## 3.5 PARAMETER, RANGE HOLDING, AND MODE.

### 3.5.1 Parameter — R, L, or C.

The selection of the parameter to be measured is almost self-explanatory. Depress the appropriate button: R/Q, L/Q, or C/D to measure resistance, inductance, or capacitance. The instrument will tolerate, to some degree, a poor choice of parameter, but accuracy is thereby reduced. The readout will indicate a completely wrong choice, as explained below. Notice that the appearance of a device can be misleading. (For example, a faulty inductor can be essentially capacitive or resistive; a component part can be mislabeled or unlabeled.)

Incorrect choice of parameter, for the measured DUT, is best avoided by watching for indications such a simultaneous lighting of both OUT OF RANGE arrows or an extreme DQ display. Refer to Table 3-1, which shows conditions of poor choice of parameter (sometimes useful) as well a wrong choice (measurement generally useless). Another possible indication of wrong choice of parameter is repeated autoranging between 2 ranges, with meaningless measurements being made in each (with or without a display). It is also possible to have a zero RLC display that results from trying to measure a very large L or small C, but erroneously selecting C/D or L/Q respectively.

### 3.5.2 Ranges and Range Holding.

Descriptions of ranges, extensions, and subranges are explained below. Refer to the RLC basic accuracy graph (Figure 3-2) for illustration.

**Basic Ranges.** The 3 basic ranges together cover the 6 decades of basic accuracy (such as  $2\ \Omega$  to  $2\ M\Omega$ ). The 3 are distinguished as low, mid, high, in order of increasing parameter value or 1, 2, 3, in order of increasing impedance. Mid range is the same as range 2.

Each basic range is slightly more than 2 decades wide, from an RLC display of  $\emptyset 1900$ , with an automatic decimal-point change between the decades, to 19999. (The symbol  $\emptyset$  represents a blanked zero. Initial zeroes to the left of the decimal point are always blanked out of the RLC display.)

**Extensions.** Each of the 3 ranges goes beyond its basic range, with both upper and lower range extensions (shown by lighter lines in the RLC basic accuracy graph). Most of these extensions are seldom used because they overlap basic portions of other ranges.

**Underrange.** The "low" extension of each range goes from  $\emptyset 1999$  down to  $\emptyset 0000$ , with reduced accuracy. The low extension of each high and mid range has the decimal point unchanged from its position in the lower decade of the

Table 3-1  
INDICATIONS OF PARAMETER MISMATCH TO DUT

Parameter selected*	Indication	Significance	Correct parameter
R/Q	OUT OF RANGE, both arrows	Wrong parameter	C/D or L/Q
L/Q	OUT OF RANGE, both arrows	Wrong parameter	C/D or R/Q
C/D	OUT OF RANGE, both arrows	Wrong parameter	L/Q or R/Q
R/Q	Q = 1.001 to 9.999 Q = blank	R accuracy reduced Wrong parameter	(L/Q or C/D) L/Q or C/D
L/Q	Q = 00.01 to 00.99 Q = 00.00	L accuracy reduced Wrong parameter	(R) R
C/D	D = 1.001 to 9.999 D = blank	C accuracy reduced Wrong parameter	(R) R
R/Q	R = blank, units changing	Wrong parameter	C/D or L/Q

\*The unit designation ( $M\Omega$  . . .  $\mu F$ ) under the RLC display indicates which parameter has been selected.

basic range. However, the low extension of the low range is displayed with the decimal one place farther left than the basic low range, thus providing fine resolution for small values of RLC. If the measured value is small enough to reduce accuracy by a factor of 20, the operator is alerted by the reduced number of digits displayed. (For example, an RLC display of 0.0999, having only 3 significant digits, is recognizable in this way.)

**Overrange.** The "high" extension of each range is a factor of 5 (with 2 exceptions), going from 19999 up to 99999, and finally to blank, without any change in decimal point, but with reduced accuracy. The high overrange (above 2 M $\Omega$  for example) is always used for the very large values of RLC that exceed the basic high range. The operator is alerted to the accuracy reduction by seeing the right-hand OUT OF RANGE arrow lighted, the "overrange indication."

The high overrange for R and C only, at 120 Hz (100 Hz) only, is a factor of 50, going from 19999, with an automatic decimal-point change, up to 99999, and finally to blank, with reduced accuracy. For high overrange, there is an overrange indication, as described above.

**Subranges.** Each range includes 2 or 3 subranges, distinguished by the automatic decimal-point shift. The operator can NOT control them. Subranges are detailed in Table 3-2. Notice, for example, on C, 1 kHz, RANGE 1, there are 2 subranges: 19- $\mu$ F and 999- $\mu$ F. If a series of measurements is made with C increasing slowly above 19  $\mu$ F, the automatic subrange change takes place at 21. But with C decreasing, the change takes place at 20. This hysteresis eliminates a possible cause of flickering of the display.

**Autoranging.** Autoranging is normal; it is inhibited only if you select RANGE HELD. There is a slight hysteresis in the changeover (at 20 as the value increases, at 19 as it decreases) to eliminate a possible cause of display flickering.

**Range Holding.** To inhibit autoranging, select this mode with the HOLD RANGE button, and verify that the RANGE HELD light is on. Whatever range the instrument is using for current or previous measurements will be held. For example, if a 100- $\Omega$  resistor is being measured when you select HOLD range, then the operation of the instrument is locked to the low range, Range 1, including the regularly unused over-range portion (labeled "low range held" on the RLC basic accuracy graph).

An advantage of holding a range is time saved. For example, if a large number of resistors are being measured in values below 900  $\Omega$ , one might "hold" range 1. Some accuracy of measurement would be sacrificed for values above 200  $\Omega$ . But the system would save the time that would be required to change to range 2 and perhaps (for open-circuited parts) to range 3. For details of the time required to make typical measurements, refer to para 3.3.6.

The OUT OF RANGE arrows will indicate whenever a measurement is made on a range extension (except for the low underrange). Thus:

- Neither arrow = all basic ranges and low underrange
- Left arrow = underrange (except low underrange)
- Right arrow = overrange
- Both arrows = wrong parameter selected.

#### NOTE

The OUT OF RANGE and RANGE HELD indicators alert the operator to unusual measurement conditions that could be selected by mistake. Be watchful for these indicators.

### 3.5.3 Measurement Modes

**Continuous.** Select CONT for automatically repeating measurements, at one of 3 rates (approx. 2, 3, or 7 per second)

Table 3-2  
FULL SCALE READOUTS ON EACH SUBRANGE

Range	Automatic subrange	R		L		C	
		1 kHz	120 (100) Hz	1 kHz	120 (100) Hz	1 kHz	120 (100) Hz
1 (Z <sub>o</sub> = 10 $\Omega$ )	1A†	1.9999 $\Omega$	1.9999 $\Omega$	.19999 mH	1.9999 mH	-----	-----
	1B	19.999 $\Omega$	19.999 $\Omega$	1.9999 mH	19.999 mH	19.999 $\mu$ F	199.99 $\mu$ F
	1C*	999.99 $\Omega$	999.99 $\Omega$	99.999 mH	999.99 mH	999.99 $\mu$ F	9999.9 $\mu$ F
	1D**	-----	-----	-----	-----	-----	99999. $\mu$ F
2 (Z <sub>o</sub> = 1 k $\Omega$ )	2B	1.9999 k $\Omega$	1.9999 k $\Omega$	.19999 H	1.9999 H	.19999 $\mu$ F	1.9999 $\mu$ F
	2C*	99.999 k $\Omega$	99.999 k $\Omega$	9.9999 H	99.999 H	9.9999 $\mu$ F	99.999 $\mu$ F
3 (Z <sub>o</sub> = 100 k $\Omega$ )	3A†	-----	-----	-----	-----	.19999 nF	1.9999 nF
	3B	.19999 M $\Omega$	.19999 M $\Omega$	19.999 H	199.99 H	1.9999 nF	19.999 nF
	3C*	9.9999 M $\Omega$	9.9999 M $\Omega$	999.99 H	9999.9 H	99.999 nF	999.99 nF
	3D**	-----	99.999 M $\Omega$	-----	-----	-----	-----

† Each "A" subrange is the low extension of the lowest range (example 0.0001 to 2  $\Omega$ ).

\* Each "C" subrange covers a full decade (example, 20 to 200  $\Omega$ ) in the basic range and an upper range extension (example 200 to 999+  $\Omega$ ), in which accuracy is reduced and the overrange light is on (the right-hand OUT OF RANGE indicator).

\*\* Each "D" subrange is a further extension of the highest range (example 10 to 99.9+ M $\Omega$ ).

as you choose SLOW, MED, or FAST. The displays will NOT be held after the DUT is removed or changed. Although there may be some annoyance due to changeability of the least significant digits in the displays, this mode provides a rapidly updated "current" measurement automatically. So it is the normal mode.

**Single.** Select SINGLE for a measurement to be made with each depression of the START button. The resulting RLC and DQ displays are held until a subsequent measurement is made, regardless of changing the DUT. This mode is suitable for many kinds of "production" testing programs.

**Average.** Select AVERAGE for a string of 10 measurements to be made after each depression of the START button. A running average is displayed, that is, each time a measurement is completed, the RLC and DQ displays are updated to be the average of all measurements made since "start". After the 10th measurement (6 or 7 s after "start", if selected RATE is SLOW), the displays are held, as described above. This mode provides smoothing of any possible "noise" or slight variation from one measurement to another theoretically identical measurement, in a particularly convenient way.

### 3.6 LIMIT-COMPARISON BINS.

#### 3.6.1 Introduction.

If a group of similar DUT's are to be measured, it is often convenient to use the limit-comparison capability of the Digibridge to categorize the parts. This can be done *in lieu of or in addition to* recording the measured value of each part. For example, the instrument can be used to sort a group of nominally 2.2- $\mu$ F capacitors into bins of 2%, 5%, 10%, 20%, lossy rejects, and other rejects. Or it can assign DUT's to bins of (for example) a 5% series such as 1.8, 2.0, 2.2, 2.4, 2.7  $\mu$ F, etc. The bin assignments can be displayed, for guidance in hand sorting, or (with the interface option) output automatically to a handler for mechanized sorting.

Up to 8 regular bins are provided for, in addition to a bin for DQ rejects and a bin for all other rejects; total = 10 bins. To set up the desired categories, use the 16 limit-entry keys in the left corner of the keyboard, as described below.

Limits are normally entered in pairs (defining the upper and lower limits of a bin), in the form of "nominal value" and "percent" above and below that nominal. If only one "percent" value is entered for a bin, the limit pair is symmetrical (such as  $\pm 2\%$ ). Two "percent" values must be entered, the higher one first, to set up a non-symmetrical pair of limits. Any overlapping portion of 2 bins is automatically assigned to the lower-numbered bin.

For simple GO/NO-GO testing, set up a DQ limit and 1 regular bin. Entry of limits in additional bins will define additional GO conditions. Be sure the unused bins are closed. (Bins 1 . . . 8 are initially closed, at power-up.)

#### 3.6.2 Limit Entry Methods

Figures 3-7, 3-8.

The figures illustrate 2 basic methods of limit entry: nested and sequential. Nested limits are the natural choice for sorting by tolerance around a single nominal value. The lower numbered bins must be narrower than the higher numbered ones. Symmetrical limit pairs are shown; but unsymmetrical ones are possible. (For example, range AB could be assigned to bin 3 and range FG to bin 4 by use of unsymmetrical limit pairs for these bins.)

Sequential limits, on the other hand, are the natural choice for sorting by nominal value. Any overlap is assigned to the lower numbered bin; any gap between bins defaults to bin 9. The usual method of entry uses a redefined nominal value for each bin, with a symmetrical pair of limits. If it is necessary to define bins without overlap or gaps, use a single nominal value and unsymmetrical limit pairs. It is possible to set up one or more tighter-tolerance bins within each member of a sequence.

USE BIN 0

#### 3.6.3 Limit Entry Procedure.

- With FREQUENCY key, select test frequency.
- With DISPLAY key, select ENTER LIMITS.
- With parameter key R/Q, L/Q, C/D, (by repeat keying) select convenient units as shown in the RLC display.



- Enter the desired DQ limit by keying:

[X] [=] [BIN No.] [0],

in which X represents 1 to 5 numerical keys and (optionally) the decimal-point key, depressed in sequence. Confirmation is shown on the DQ display, up to 4 significant digits.

- Enter a nominal value for limits by keying:

[Y] [=] [NOM VALUE],

in which Y represents 1 to 5 numerical keys and (optionally) the decimal-point key, depressed in sequence. Confirmation is shown on the RLC display.

- For a symmetrical pair of limits (centered on the nominal value just entered), enter one percentage, by keying:

[S] [%] [=] [BIN No.] [Z];

in which S represents 1 to 5 numerical keys and (optionally) the decimal-point key, depressed in sequence, forming a number not exceeding 100.00; and Z represents one key for the chosen bin: 1, 2, 3, 4, 5, 6, 7, or 8. Confirmation is shown, upper limit on the RLC display, lower limit (4 significant digits) on the DQ display. Notice that these displays are actual R, L, or C values, not percentages.



- For an unsymmetrical pair of limits, similarly, key in:  
[H] [%] [-] [L] [%] [=] [BIN No.] [Z];

in which H represents a number not exceeding 10000 and L a number not exceeding 100.00. Both H and L (or neither) may have a negative-sign prefix; but H must always yield a higher limit (absolute value) than L.

- To enter another pair of limits based on the established nominal value, repeat step f or g, choosing another bin number.

- 10 + 50

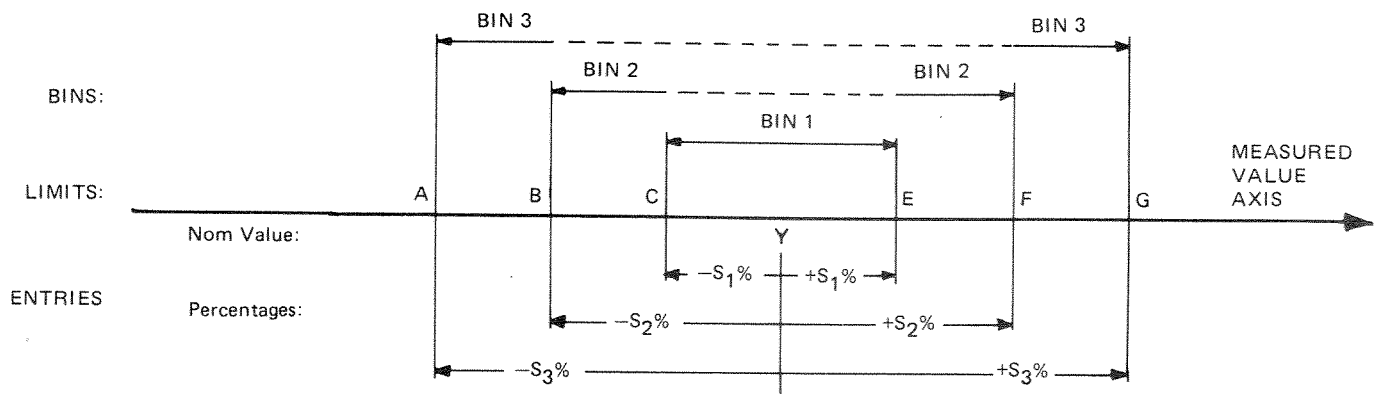

Figure 3-7. Nested limits. A single nominal value Y is used and all limit pairs are symmetrical in this basic plan.

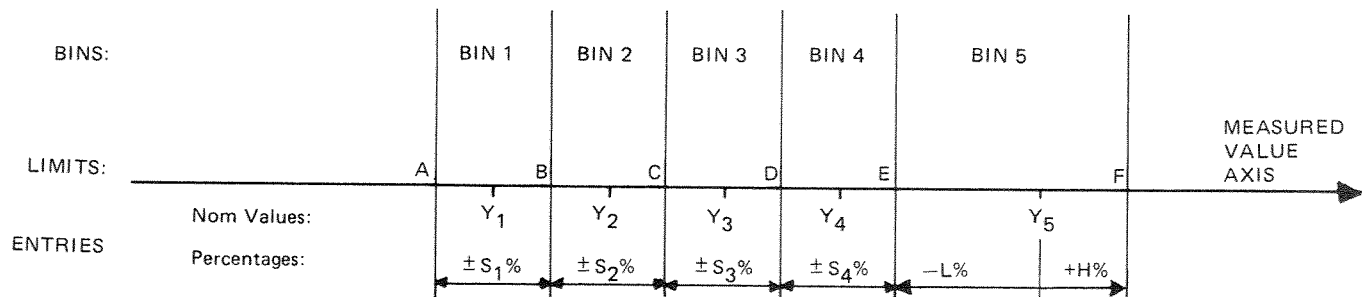

Figure 3-8. Sequential limits. A different nominal value is entered for each bin and all limit pairs are symmetrical except for the unsymmetrical pair shown for example in bin 5.

- i. To enter another pair of limits based on a different nominal value, repeat step e and then step f or g, similarly.
- j. To change the limits in any of the 8 bins, reenter the pair, as above.
- k. To close a bin that has limits entered in it, repeat step f with zero for S. Confirmation is shown by 2 identical numbers appearing in the RLC and DQ displays.
- l. To resume operation of the Digibridge, using the limits entered as above, press the DISPLAY key. The display will be either measured VALUE, or BIN No., whichever you select. In either case, if you have the Interface Option, the available output data are not limited to the display selection.

### 3.6.4 Examples of Limit Entry.

**Nested Limits.** To enter a set of nested limits, operate the keyboard as described below for the example of resistors having  $Q < .001$ ,  $R = 33 \text{ k}\Omega \pm 0.35\%, \pm 1\%, \pm 5\%, +7 -9\%$ .

- a. With FREQUENCY key, select the desired test frequency.
- b. With DISPLAY key, select ENTER LIMITS.
- c. With parameter key R/Q, select RLC units:  $M\Omega$ .
- d. Enter Q limit thus: [.] [0] [0] [1] [=] [BIN No.] [0].
- e. Enter nominal RLC value: [.] [0] [3] [3] [=] [NOM VALUE].
- f. Set bin 1 limits: [.] [3] [5] [%] [=] [BIN No.] [1].
- g. Set bin 2 limits: [1] [%] [=] [BIN No.] [2].

- h. Set bin 3 limits: [5] [%] [=] [BIN No.] [3].
  - i. Set bin 4 limits: [7] [%] [=] [BIN No.] [4].
  - j. Close bin 5, by keying: [0] [%] [=] [BIN No.] [5].
  - k. Close bins 6, 7, and 8, similarly, if used before.
- Sequential Limits.** To enter a set of sequential limits, operate the keyboard as described below for the following capacitor sorting example:  $D < .005$ ,  $C = 0.91, 1.0, 1.1, 1.2, 1.3 \mu\text{F}$  (the standard 5% series).
- a. With FREQUENCY key, select the desired test frequency.
  - b. With DISPLAY key, select ENTER LIMITS.
  - c. With parameter key C/D, select RLC units:  $\mu\text{F}$ .
  - d. Enter D limit: [.] [0] [0] [5] [=] [BIN No.] [0].
  - e. Enter nominal RLC value: [.] [9] [1] [=] [NOM VALUE].
  - f. Set bin 1 limits: [5] [%] [=] [BIN No.] [1].
  - g. Redefine nominal: [1] [=] [NOM VALUE].
  - h. Set bin 2 limits: [5] [%] [=] [BIN No.] [2].
  - i. Redefine nominal: [1] [.] [1] [=] [NOM VALUE].
  - j. Set bin 3 limits: [5] [%] [=] [BIN No.] [3].
  - k. Redefine nominal: [1] [.] [2] [=] [NOM VALUE].
  - l. Set bin 4 limits: [5] [%] [=] [BIN No.] [4].
  - m. Redefine nominal: [1] [.] [3] [=] [NOM VALUE].
  - n. Set bin 5 limits: [5] [%] [=] [BIN No.] [5].
  - o. Close bin 6: [0] [%] [=] [BIN No.] [6].
  - p. Close bins 7 and 8, similarly, if used before.

### 3.6.5 Entries in General.

For additional detail, refer to the condensed instructions on the reference card under the Digibridge, and to the following notes.

**Frequency.** Select the test frequency first. Comparison results are liable to error if the test frequency is changed later in the entry/measurement procedure.

**Bin 0.** The limit entered in bin 0 is always DQ. For R it is Q; for C it is D, both upper limits. For L it is Q, a lower limit.

**Unsymmetrical Limit Pairs.** Enter 2 percentages for the bin. One or both may be + (unspecified sign) or -. Enter first the one that yields the larger absolute value of RLC. (Examples are shown above.)

**Unused Bins.** Initially, at power-up, bins 1 . . . 8 are closed so that unused ones can be ignored. Every unused bin that has previously been used (except 9) must be closed by entering 0%, as in the above examples. Once closed, it will stay closed until non-zero percent limits are inserted.

**Allowable Limits.** Positive limits up to 10 000%, negative limits down to -100%, maximum of 5 significant figures (for example: 38.671%).

**Bin Order.** Optional except for nested bins; be sure the narrower limit pairs go into lower numbered bins (because all overlap goes to the lower bin).

**Inhibiting Comparisons.** To inhibit DQ comparisons, set bin 0 to the "all pass" extreme, i.e., to 0000 for Q or 9999 for D. To inhibit all comparisons, set NOM VALUE to zero. (Then GO/NO-GO indicators stay off.) Subsequent setting of NOM VALUE to any number except zero enables all comparisons as previously set up.

When POWER is switched ON, "nominal value" is initialized at zero. (Comparisons are inhibited.)

**Changing Entries.** Enter new value(s) — or a zero — to delete obsolete or erroneous nominal value or bin limits. Do not attempt to change or enter a single separate limit in a bin; any single percentage entered for a bin will be interpreted as a symmetrical pair of limits. Changing "nominal value" does not change any limits, but does determine the base for subsequent limit entries for specific bins.

**RLC Unit Selection.** No distinction is made between the 2 ranges that display in units of H or between the 2 ranges that display in units of  $\mu F$ , in limits entry procedures. It is NOT necessary to select (for limit entry) the range that the Digibridge will use in measuring. For example (see para 3.6.4), it is equally valid to enter a nominal value of .033 M $\Omega$ , 33 k $\Omega$ , or 33000  $\Omega$ .

### 3.6.6 Verification of Nominal and Limit Values.

While the DISPLAY selection is ENTER LIMITS, the exact values entered into the Digibridge can be seen by either of 2 methods, as follows:

**During the Entry Process.** A confirming display is automatically provided immediately after the final keystroke of each entry step. For example, after the [NOM VALUE] keystroke, the entered value appears on the RLC display.

After the [BIN No.] and number keystrokes, the actual limits of RLC value (not percentages) appear across the full display area: upper limit on the regular RLC display, lower limit (minus the least significant digit) in the regular DQ display area. For bin 0, the DQ limit appears in the DQ area.

**Upon Demand.** To see the current "nominal value", depress the [NOM VALUE] key (while ENTER LIMITS is lit. To see the limits in any particular bin (or to verify that it has been closed), depress [BIN No.] and the desired number, similarly. Displays selected in this way are limited by the units that are shown on the panel. For example, if the bin-3 limits are 162 and 198 k $\Omega$ , but the display units are  $\Omega$ , when you press the [BIN No.] [3] keys, the display will go blank. Select either k $\Omega$  or M $\Omega$  (instead of  $\Omega$ ) to obtain a display of these limits.

However, any "nominal values" previous to the current one are lost and cannot be displayed (unless entered again). Bin limits are not lost until replaced by new entries in the particular bin; but they *are* lost when POWER is switched OFF.

### 3.6.7 Value, Bin, and Go/No-Go Displays.

The Digibridge measurement will be presented either of 2 ways; VALUE or BIN, but not both ways for a single measurement. This distinction is unimportant for most measurements, in the continuous mode. But for single or average-mode operation, select the desired display before pushing START.

**Value.** Select VALUE with the DISPLAY button. When measurement is completed, the value will be shown on the RLC and DQ displays.

**Bin.** Alternatively, select BIN with the DISPLAY button. When measurement is completed, the bin assignment will be shown on the RLC display (a single digit), with the following significance:

- 0 = No-Go because of D or Q limit
- 1 = Go, bin 1
- 2 = Go, bin 2
- . . . Go, bin 3, 4, 5, 6, 7 or 8, as indicated.
- 9 = No-go by default (suits no other bin).

**GO/NO-GO.** If comparison is enabled, by a non-zero entry for "nominal value" (see para 3.6.5), this indication is provided. The DISPLAY selection can be either VALUE or BIN. GO means the measurement falls in bin 1 . . . 8; NO-GO means bin 0 or 9.

### 3.7 BIAS.

#### WARNING

- Maximum bias voltage is 60 V. Do NOT exceed.
- Bias voltage is present at connectors, test fixtures and on capacitors under test.
- Capacitors remain charged after measurement.
- Do not leave instrument unattended with bias "on".