



Advanced Test Equipment Rentals
 www.atecorp.com 800-404-ATEC (2832)

YOKOGAWA ◆

signal *X* plorer™

Digital Oscilloscopes **DL9000 Series**



- **Fast acquisition rate**
 - Up to 25,000 frames/sec/channel in continuous mode (when the Accumulate function is used)
 - Up to 2.5 million frames/sec/channel in N Single mode
- **History Memory function**
 - With a partitioned large-capacity memory, the DL9000 can automatically accumulate and display up to 2,000 waveform frames.
- **Bandwidth and Sampling Rate**

	DL9040/DL9040L	DL9140 /DL9140L	DL9240 /DL9240L
Analog frequency bandwidth	500 MHz	1.0 GHz	1.5 GHz
Maximum sampling rate	5 GS/s	5 GS/s	10 GS/s



www.yokogawa.com/tm/
 ... and subscribe to "Newswave,"
 our free e-mail newsletter

Bulletin 7013-00E

Compact digital oscilloscopes with up to 1.5 GHz bandwidth and a 10 GS/s sampling rate. History Memory function dramatically increases the performance of the large-capacity memory. The enhanced performance and functionality make the DL9000 series the perfect signal measurement solution.



History Memory

Capture only the desired data for long periods of time. Make full use of the large-capacity memory to increase development efficiency without acquiring useless data.

Efficient Waveform Measurement

Collective measurement with large-capacity memory

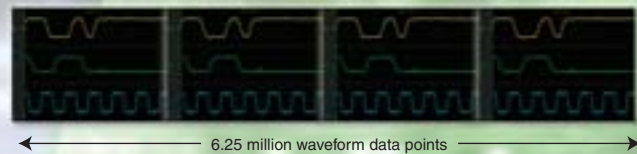

Waveform comparison using memory partitioned into up to 2,000 areas

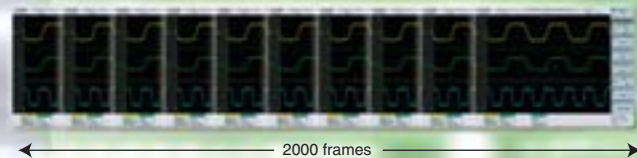

The DL9000 series allows you to measure waveforms for long periods of time using its large-capacity memory. In addition, the memory can be partitioned to capture only the necessary waveforms (History Memory function). The History Memory function retains up to 2,000 waveforms in its internal memory while constantly updating them. Now suppose an abnormal signal occurs. You can view it even if some time has elapsed since the occurrence, as long as the signal is included in the previous 2,000 waveforms. This feature is effective in capturing anomalies that may occasionally occur. Furthermore, you can compare all 2000 waveforms by overlaying them or view them with (different brightness levels) depending on their frequency of occurrence. This feature displays waveforms similar to how they would appear on analog oscilloscopes.

Isolate Abnormal Waveforms

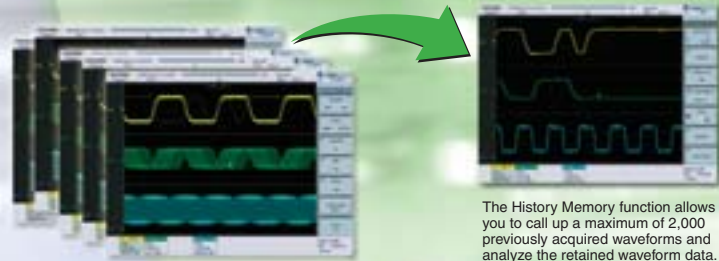

The History Memory function allows you to call up a maximum of 2,000 previously acquired waveforms and analyze the retained waveform data.

History Replay Function

You can go back to previously-captured waveforms in History Memory and view them one by one, just like browsing address book entries. Furthermore, you can use the new History Replay function to continuously play back, stop, fast-forward, and rewind captured waveforms like a video recording.

Replay!



High Speed Response

Fast display updates, even when processing mega-words of data

Yokogawa's proprietary signal-processing IC (Advanced Data Stream Engine [ADSE]) has made the History Memory function and display functions far more advanced than those of conventional scopes. High-speed data processing is achieved using this hardware-based computation.

Maximum update rate in math mode:

60 frames/sec (1 MW, when adding channels)
12 frames/sec (5 MW, when adding channels)

Maximum update rate in parameter measurement mode:

60 frames/sec (1 MW, when measuring a channel's maximum value)
16 frames/sec (5 MW, when measuring a channel's maximum value)

Note: The above rates can vary depending on the oscilloscope settings.



Advanced Data Stream Engine (ADSE)

Enjoy the combination of dramatically enhanced performance and functionality!



Dot Density Display

Displays waveforms like an analog oscilloscope

The dot density display function varies the brightness of each display pixel, depending on how often waveforms pass through it. The DL9000 can rapidly capture waveforms at an acquisition rate of up to 25,000 waveforms/sec. Thus the oscilloscope can show eye patterns and perform real-time display processing even when capturing repetitive signals. ADSE-driven high-speed signal processing enables the digital oscilloscope to provide analog oscilloscope-like waveform displays.

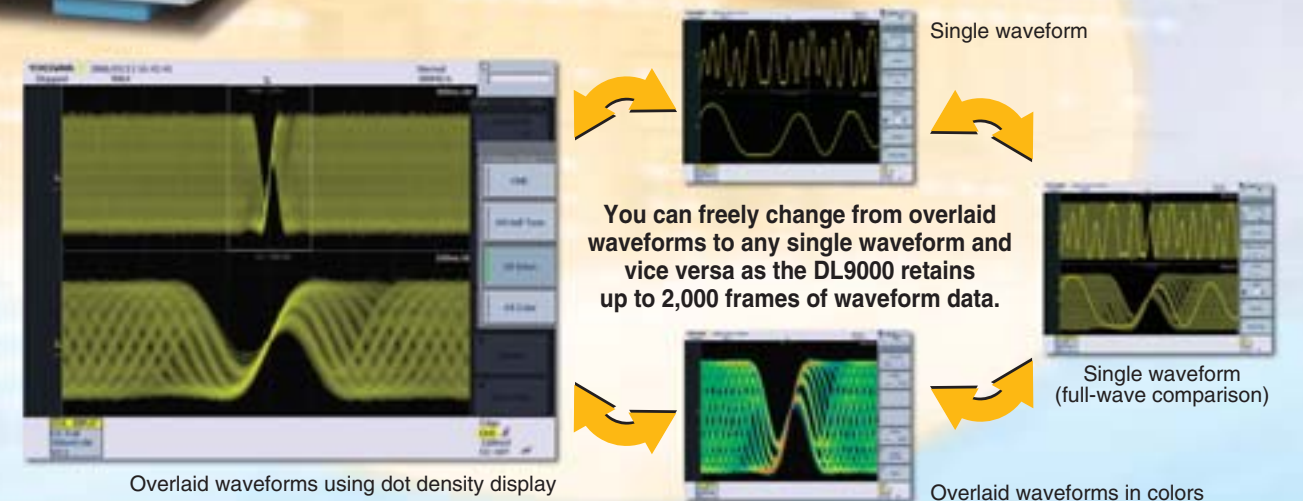

You can freely change from overlaid waveforms to any single waveform and vice versa as the DL9000 retains up to 2,000 frames of waveform data.

Overlaid waveforms using dot density display

Overlaid waveforms in colors



Waveform Capture – Filter functions –

To be able to observe signals after filtering out unnecessary components is extremely useful during circuit design. The DL9000 series is equipped with two types of filters, the input stage filters and filters based on high-speed computation. You can filter out unnecessary signal components during signal capture or apply high-speed filtering afterwards.

Filters in the input stage : Analog filters: 200 MHz/20 MHz
Real-time digital filters: 8 MHz/4 MHz/2 MHz/1 MHz/500 kHz/200 kHz/125 kHz/62.5 kHz/32 kHz/16 kHz/8 kHz

Filters based on computation : **Select low pass or high pass filters with variable cutoff frequencies**
Display filtered waveforms in real time at up to 60 frames/sec.
Simultaneously display both pre-filtered and post-filtered waveforms.
Desired filter setting: The lowpass/highpass filter frequencies and cutoff frequency can be set to values from 0.01 Hz to 1.0 GHz.

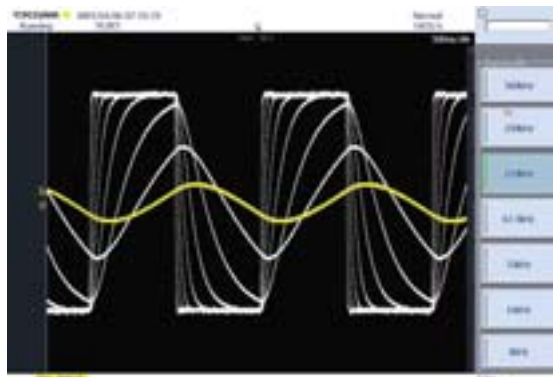

Example of input stage filtering

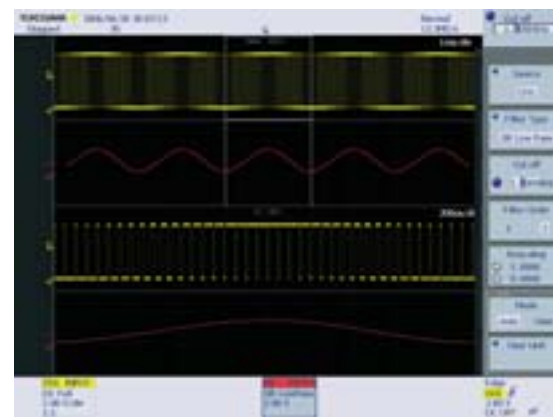

Example of computation filtering: PWM waveform analysis
Yellow: PWM waveform
Red: Filtering-based trend display of pulse widths

Waveform Capture – Advanced trigger functions –

The DL9000 series can be triggered using two or more channels in addition to an edge trigger or TV trigger. You can capture only the desired signals by combining various trigger types and thereby predetermining trigger conditions. Effective filtering helps to shorten the time needed to evaluate and troubleshoot a design.

DL9000 Series' Trigger Functions

Edge/state triggers	Pulse width triggers	Enhanced triggers	Event interval triggers
<ul style="list-style-type: none"> Edge Edge (Qualified: conditional) Edge OR State 	<ul style="list-style-type: none"> Pulse width Pulse width (Qualified) Pulse state <p>(Triggered using the length of period during which the conditions are true)</p>	<ul style="list-style-type: none"> TV (NTSC/PAL (SECAM)/HDTV) I²C SPI CAN Serial pattern (define patterns up to 128 bits long) 	<ul style="list-style-type: none"> Event cycle Event delay Event sequence

Examples of Trigger Application

Trigger-based gating – Edge (Qualified): conditional trigger –
The valid/invalid state of an edge trigger or pulse width trigger can be controlled according to the conditions of any other channel's state (high/low).

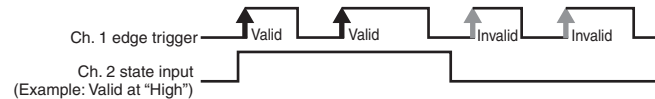

Setup and hold time triggers

To derive setup time/hold time conditions, event delay/event sequence triggers are set as shown in the following figure.

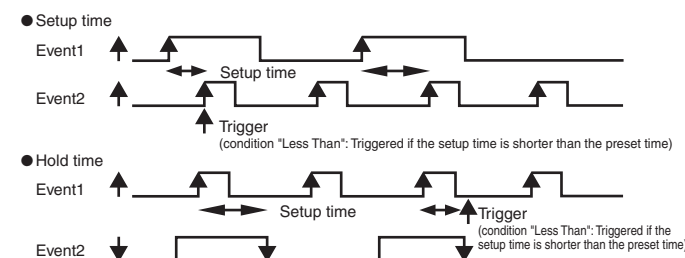

Slew rate trigger – Window comparator and pulse state –

The time taken to pass through the voltage level range specified for the window comparator is used to detect the pulse rise/fall time. With pulse state triggers, it is possible to derive trigger conditions, such as "More Than," "Less Than" and "Between," by specifying the ranges of rise time/fall time.

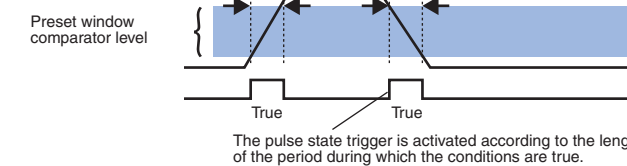

Runt pulse trigger

Runt pulses (pulses with levels lower than those of normal pulses) can also be captured in the same way as explained above. A runt pulse stays too long within the range set by the window comparator, as shown in the following figure. It is therefore possible to capture the runt pulse by setting the trigger conditions to a rise time longer than those of normal pulses.

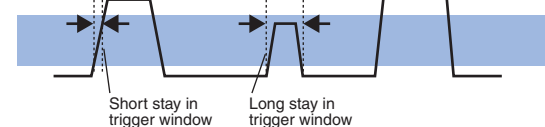

Waveform Search and Display – Searching for and displaying selected waveforms from the large-capacity memory –

Dual-window Zoom function simultaneously zooms in on two areas

The DL9000 series allows the zooming magnification and position to be set separately for two different areas of a waveform. Thus you can change the timebase scale and view the two windows simultaneously. The waveform on the right shows a measurement example of the time taken from the point of power-on to the point of gate array oscillation. The DL9000 measures the time length from the rising edge occurring immediately after power-on (cursor 1 of Zoom 1), to the start of oscillation (cursor 2 of Zoom 2).

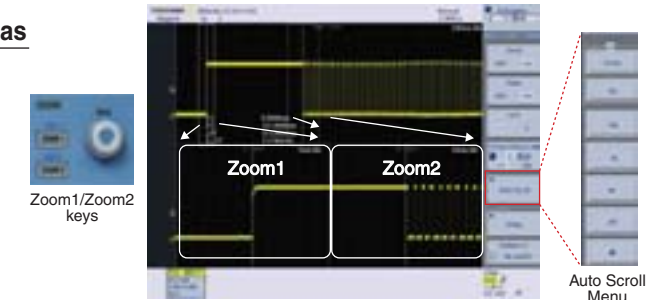

Auto Scroll function for observing the entire waveform

Use the auto scroll function to automatically move the zoom windows through a long acquisition. Selecting the area to be zoomed-in on can be done easily by scrolling forward, backward, fast forwarding or pausing.

A variety of search functions

The DL9000 series has a variety of waveform search functions, enabling you to detect abnormal signals or find specific serial or parallel data patterns.

- Data search types include:
- State search (based on high/low states of one or more channels)
 - Serial pattern search (I²C/SPI/CAN/general-purpose pattern)
 - Zone search
 - Waveform window search
 - Waveform parameter search (measured parameters, FFT, etc.)



Example: Search for serial pattern A5 (1010 0101)



Display of up to 2,000 Overlaid Waveforms using History Memory



Zone search
Define 1 to 4 zones and search for waveforms that fall inside or outside the zone (s).



Waveform window search
Select a waveform in History Memory and create a window around the waveform by moving up/down/left/right from the waveform. Search for waveforms that fall inside or outside the window.



Waveform parameter search
Select a waveform parameter and define a range for the parameter. Search for waveforms with parameter values inside or outside the set range.

Waveform Analysis – Serial bus analysis I²C/SPI/CAN –

The DL9000 can perform I²C, SPI and CAN bus analysis with the different available options (/F5, /F7 and /F8). Triggers for these bus types are standard features. These functions make it easy to discriminate between partial software failures and physical-layer waveform problems when troubleshooting systems by observing the physical-layer characteristics of signals.

Real-time bus analysis-up to 15 updates/sec

The DL9000 displays protocol analysis results while concurrently capturing bus signals.

Simultaneous analysis of different buses

With the Dual-window Zoom function, the DL9000 can simultaneously analyze and display the waveform of buses running at different speeds.

Serial data bus trigger functions

A variety of trigger conditions can be set, including triggers based on ID-Data combinations and combinations of a serial bus trigger and a regular edge trigger.



Example of High-speed/Low-speed CAN Bus Analysis Display
CAN 500kbps
CAN 125kbps



Example of I²C Bus Analysis Display

Advanced Analysis and Math Functions



Automatic Waveform Parameter Measurements

You can automatically measure waveform parameters, including max., min., peak-peak, pulse width, period, frequency, rise time, fall time, and duty ratio. You can also calculate the statistics of waveform parameters, such as the average, max., min., and standard deviation, over multiple cycles within an acquisition or over multiple acquisitions.

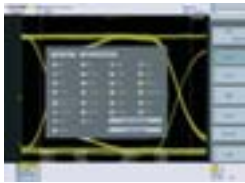

Trend Displays

The DL9000 graphs the long-term trends of data items obtained by automatic waveform parameter measurements. With the Trend display, you can observe short-term cyclic waveform fluctuations within a single frame, or medium to long-term waveform fluctuations by plotting frame-by-frame periods.



Histogram Displays

Histograms show waveform behavior, over an extended period time, relative to time (jitter) and voltage (noise). According to an on-screen histogram, you can analyze statistics, including max., min., average, and standard deviation. You can also display waveform parameter histograms, such as voltage P-P, frequency etc., to see how parameters vary over time.

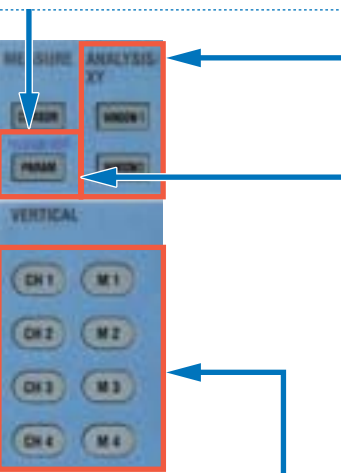
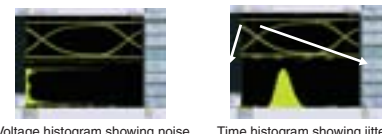

Eye Pattern Analysis and Mask Testing

◆ **Eye Pattern Analysis**
This function automatically measures the waveform parameters of an eye pattern. Unlike the waveform parameter measurement of earlier DL series oscilloscopes, the DL9000 can calculate parameters based on the eye pattern formed by the crossings of two or more waveforms.

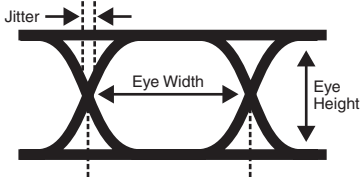

◆ **Mask Testing**
This function is used to evaluate the signal quality of high-speed data communication. Using Mask Editor software, a mask pattern is generated and loaded into the DL9000. (The Mask Editor software can be downloaded from Yokogawa Electric's web page.)

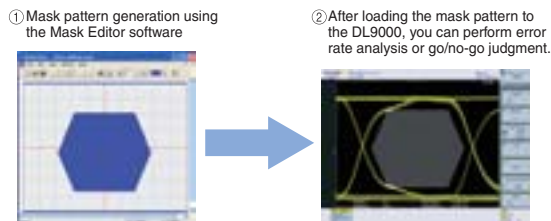

Math Functions (Addition, Subtraction, Integration, Edge Count, and Rotary Count)

You can calculate and display up to 8 math traces. The functions to choose from include: Filtering, +, -, x, /, Integration, Edge Count and Rotary Count. Since basic arithmetic operations are performed using hardware, the DL9000 can display results in real time.

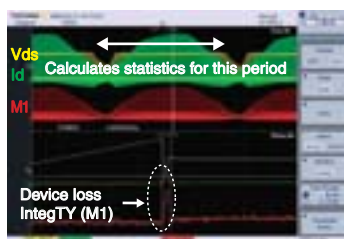

The figure on the right shows the voltage and current waveforms of a switching power supply. The red math trace M1 has been calculated under the following conditions:
M1 = Ch. 1 (voltage) × Ch. 2 (current)
Ch. 1: Differential voltage probe (yellow)
Ch. 2: Current probe (green)

Example of a Switching Power Supply's Waveform Obtained by the Multiplication "Voltage × Current"

◆ **Real-time Math Traces (Rotary Count)**
This function counts and displays the number of edges between 2 input signals (Phases A and B). E.g., if Phase B leads (negative phase sequence), this function counts down. This function can be used to check the rotational angle of a motor.

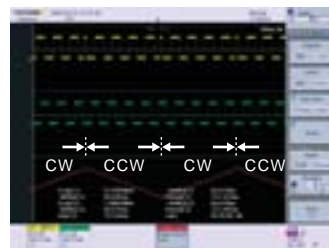
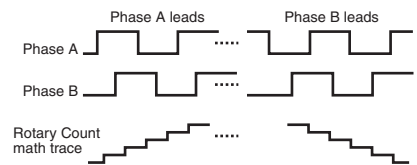

Calculation of Phase A and Phase B (Ch. 1 and Ch. 2) Parameters and "Rotary Count" Math Traces

Versatile Connectivity

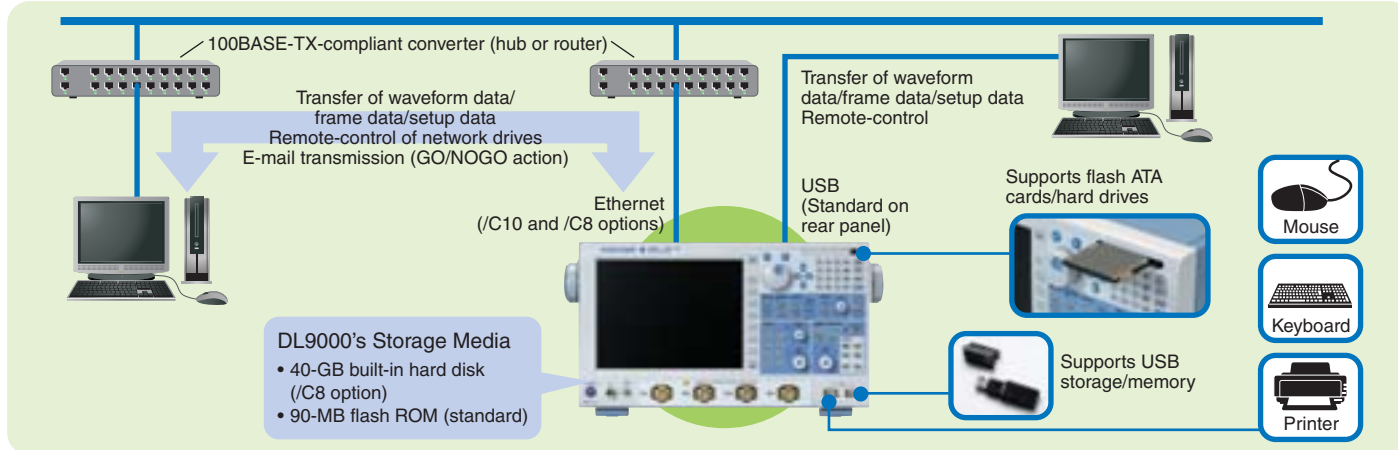
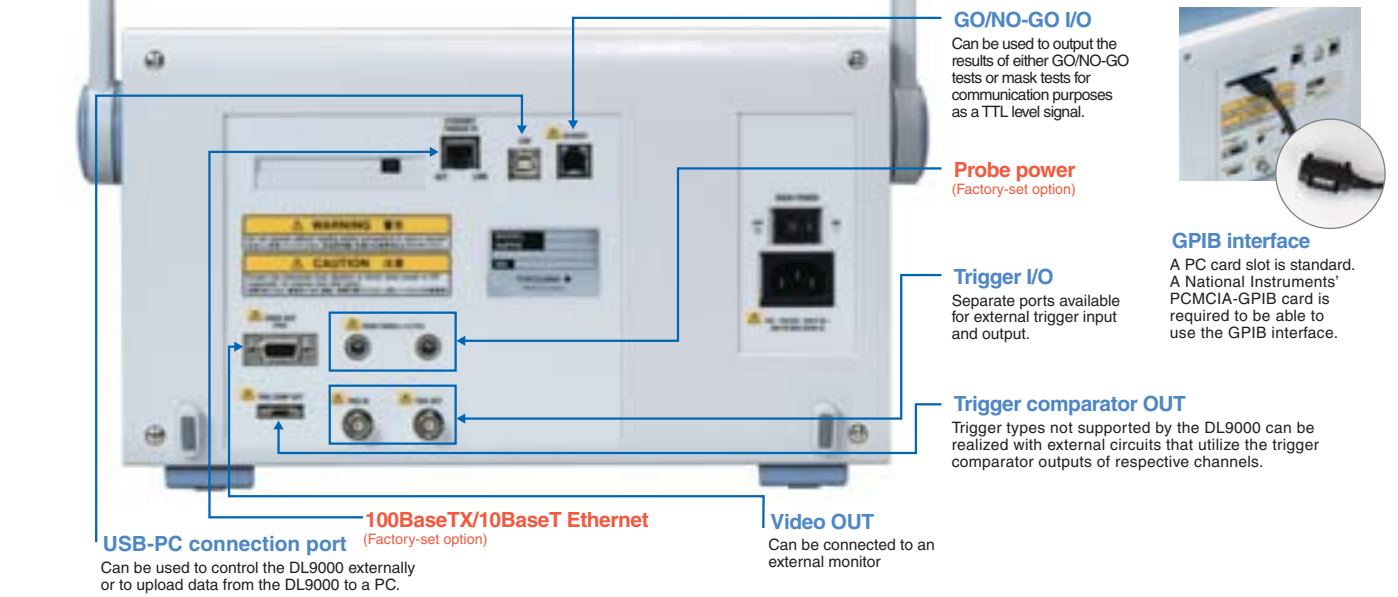

USB Compliance Test Solution

Flexible System Configuration

A DL9240 or DL9240L together with the USB test fixture, test software and probes, allow you to test a USB device, host or hub for compliance to USB-IF specifications.

User-friendly Operability based on PC Software

The test software shows connection methods and test procedures in a wizard form for each tests item. It shows connections, settings and operations necessary for carrying out each test enabling even first-time users to perform test easily.

Collaboration with Xviewer

You can output waveform data from a test result window to analyze failed signals using the Xviewer waveform analysis software.

Example of System Configuration

- DL9240 or DL9240L digital oscilloscope (with Ethernet option)
- PBD2000 differential probe (one or two)
- PBA2000 active probe (two or three)
- 701933 current probe (one)
- Test bed PC (English Windows XP)
- 3 1/2-digit or greater DMM
- Pulse generator
- 701985 USB test fixture and software (one)

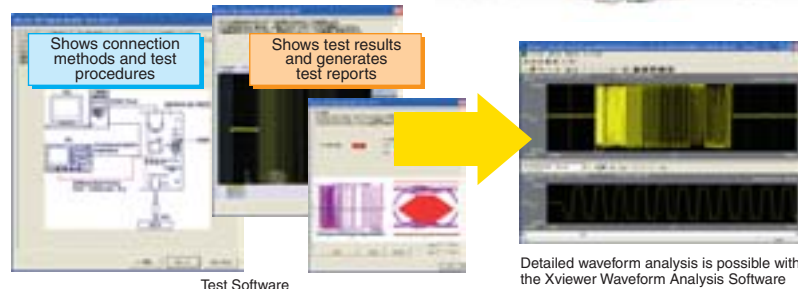

For more information, see Bulletin 7019-85E, "USB 2.0-compliant Test Solutions."

Software Tools

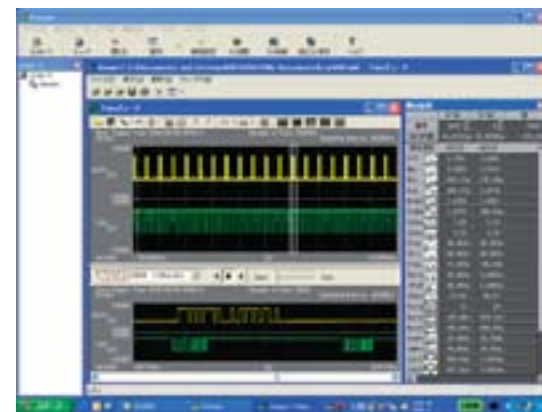

Xviewer (optional software)

Xviewer runs on a PC and can be used to view waveforms captured with the DL9000 and to convert binary waveform data to ASCII data. Adding the Math option to Xviewer enables you to freely define computational expressions and to perform waveform math. This software supports FFT calculations with a maximum record length of 2 M words.

Additional details about Yokogawa's software tools and information for downloading free software and trial versions of nonfree software can be found at:
<http://www.yokogawa.com/tm/tm-softdownload.htm>



MATLAB Control Tool Kit (Optional software)

With the MATLAB tool kit, you can easily deal with waveform data captured using the DL series oscilloscope in a MATLAB environment. The software can be used to control the DL series' panel settings or to transfer data from the DL series to MATLAB.



DL Series Library (freeware)

This API lets you control the DL9000 series from an external program or to transfer the DL9000 series' data to the external program. The API is available as a DLL and can be accessed from your program.

Optional Accessories

PBA2500 2.5 GHz active probe



This active probe can be used in combination with the DL9000 series to measure signals with an analog bandwidth up to 1.5 GHz.

Bandwidth: DC to 2.5 GHz (-3 dB)
Attenuation and DC accuracy: 10:1 (±2%)
Input resistance: 100 kΩ (±2%)
Input capacitance: Approx. 0.9 pF (typ.)
Dynamic range: ±7 V

PB500 500 MHz passive probe

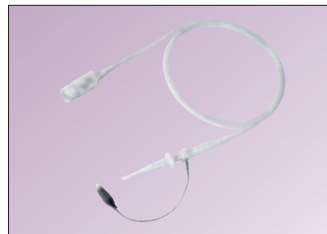

Input resistance: 10 MΩ ±2% (when used with the DL9000)
Input capacitance: Approx. 14 pF (typ.) (when used with the DL9000)
Attenuation: Fixed to 1/10
Bandwidth: DC to 500 MHz (within -3 dB)
Max. input voltage: ±600 V DC + AC peak

701920 ±12 V/500 MHz differential probe

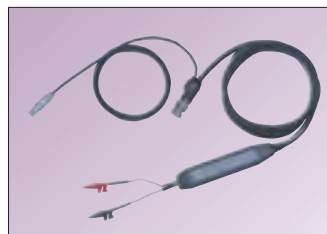

Bandwidth: DC to 500 MHz (within -3 dB)
Attenuation: 1/10 (fixed)
Input impedance (typ.): 100 kΩ/2.5 pF
Max. allowable differential voltage: ±12 V (DC + ACpeak)
Max. common mode input voltage: ±30 V (DC + ACpeak) (Output impedance: 50 Ω)

701921 ±700 V/100 MHz differential probe



Bandwidth: DC to 100 MHz (-3 dB)
Attenuation: 1/10 or 1/100 (selectable)
Max. allowable differential voltage: ±700 V (DC + ACpeak)
Max. common mode input voltage: ±700 V (DC + ACpeak) (common to both 1/10 and 1/100 attenuation ratios)

701922 ±20 V/200 MHz differential probe



Bandwidth: DC to 200 MHz (-3 dB)
Attenuation: 1/10 (fixed)
Max. allowable differential voltage: ±20 V (DC + ACpeak)
Max. common mode input voltage: ±60 V (DC + ACpeak)
Output impedance: 50 Ω

PBD2000 2.0 GHz differential probe

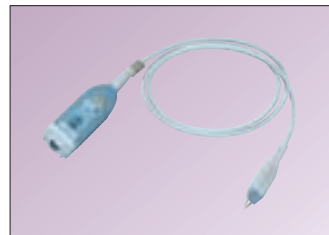

This differential probe is suited for observation of fast differential signals, such as LVDS. Using this probe in combination with the DL9000 series, you can observe differential signals with an analog bandwidth up to 1.5 GHz.

Bandwidth: DC to 2.0 GHz (-3 dB)
Attenuation and DC accuracy: 10:1 (50 Ω)
Input capacitance: Approx. 1.1 pF (typ.)
Max. differential input voltage: ±5 V

PBL5000 5 GHz low capacitance probe

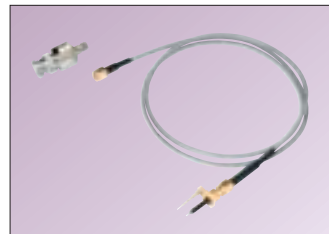

This wideband low capacitance probe can be used with the 50 ohm input setting.

Connector type: SMA
Input resistance: 450 Ω or 950 Ω
Input capacitance: Approx. 0.25 pF (typ. 450 Ω), 0.4 pF (typ. 950 Ω)
Attenuation: 10:1 or 20:1
Bandwidth: DC to 5 GHz (-3 dB)
Max. input voltage: 20 Vrms, 40 V ACpeak

701975 50 ohm DC block



This DC block is used to remove bias voltage occurring when the PBL5000 probe is used.

Overall length: Approx. 25 mm
Connector type: SMA
Input impedance: 50 Ω
Frequency range: 20 MHz to 6 GHz
Max. input voltage: ±10 V (DC + ACpeak)

701932 DC to 100 MHz 30 Arms current probe



Bandwidth: DC to 100 MHz (-3 dB)
Max. continuous input range: 30 Arms
Amplitude accuracy: 0 to 30 Arms: ±1% of rdg ±1 mV
Up to 50 Apeak: ±2.0% of rdg (DC, 45 to 66 Hz)
Weight: Approx. 240 g

701931 DC to 20 MHz 500 Arms current probe

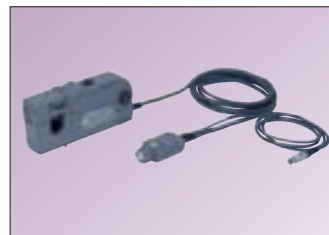

Bandwidth: DC to 20 MHz (-3 dB)
Max. continuous input range: 500 Arms
Amplitude accuracy: 0 to 500 Arms: ±1% of rdg ±5 mV
Up to 700 Apeak: ±2.0% of rdg (DC, 45 to 66 Hz)
Weight: Approx. 520 g

Main Specifications



Models

Model name (No.)	Max. sampling rate	Freq. BW	Max. record length
DL9040 (701307)	5 GS/s	500 MHz	2.5 MW
DL9040L (701308)	5 GS/s	500 MHz	6.25 MW
DL9140 (701310)	5 GS/s	1 GHz	2.5 MW
DL9140L (701311)	5 GS/s	1 GHz	6.25 MW
DL9240 (701312)	10 GS/s	1.5 GHz	2.5 MW
DL9240L (701313)	10 GS/s	1.5 GHz	6.25 MW

Basic Specifications

Input channels:	4 (CH1 to CH4)		
Input coupling:	AC, DC, GND, DC50Ω		
Input impedance:	1 MΩ ±1.0% approx. 20 pF (when using PB500 probe, 10 MΩ ±2.0%, approx. 14 pF) 50 Ω ±1.5%		
Voltage axis sensitivity:	For 1 MΩ input : 2 mV/div to 5 V/div (steps of 1-2-5) ranges For 50 Ω input : 2 mV/div to 500 mV/div (steps of 1-2-5) For 1 MΩ input : 5 Vrms or less and 10 Vpeak or less		
Maximum input voltage:	For 1 MΩ input 2 mV/div to 50 mV/div : ±1 V 100 mV/div to 500 mV/div : ±10 V 1 V/div to 5 V/div : ±100 V For 50 Ω input 2 mV/div to 50 mV/div : ±1 V 100 mV/div to 500 mV/div : ±5 V		
DC offset max. setting range: (When probe attenuation set to 1:1)	For 1 MΩ input : ±1.5% of 8 div + offset voltage accuracy For 50 Ω input : ±1.5% of 8 div + offset voltage accuracy		
Offset voltage axis accuracy ¹ :	2 mV/div to 50 mV/div : ±(1% of setting + 0.2 mV) 100 mV/div to 500 mV/div : ±(1% of setting + 2 mV) 1 V/div to 5 V/div : ±(1% of setting + 20 mV)		
Voltage standing-wave ratio (VSWR): Frequency characteristics ^{1,2} (Attenuation point of -3 dB when inputting a sine wave of amplitude ±2 div or equivalent)	1.5 or less within frequency bandwidth (typical value) ³		
For 50 Ω input	DL9040/9040L	DL9140/9140L	DL9240/9240L
0.5 V/div to 10 mV/div:	DC to 500 MHz	DC to 1 GHz	DC to 1.5 GHz
5 mV/div:	DC to 400 MHz	DC to 750 MHz	DC to 1 GHz
2 mV/div:	DC to 400 MHz	DC to 600 MHz	DC to 750 MHz
For 1 MΩ input (from the probe tip when using the PB500 dedicated passive probe)	5 V/div to 10 mV/div:	DC to 500 MHz	DC to 500 MHz
5 mV/div to 2 mV/div:	DC to 400 MHz	DC to 400 MHz	DC to 400 MHz
Residual noise level ¹ :	0.4 mV rms or 0.05 div rms, whichever is larger (typical value) ⁴		
A/D conversion resolution:	8-bit (25 LSB/div)		
Bandwidth limit:	For each channel, select from FULL, 200 MHz, 20 MHz, 8 MHz, 4 MHz, 2 MHz, 1 MHz, 500 kHz, 250 kHz, 125 kHz, 62.5 kHz, 32 kHz, 16 kHz, and 8 kHz (separately configurable on each of channels CH1 to CH4); Limit implemented with analog (200 MHz, 20 MHz) and digital filters (IR+ FIR).		
Max. sampling rate:	DL9040/9040L/9140/9140L	DL9240/9240L	
Real time sampling mode:	Interleave mode ON: 5 GS/s, 10 GS/s Interleave mode OFF: 2.5 GS/s, 5 GS/s		
Repetitive sampling mode:	2.5 TS/s, 2.5 TS/s		
Maximum record length:	DL9040/9140/9240	DL9040L/9140L/9240L	
2.5 MW	6.25 MW		
Time axis setting range:	500 ps/div to 50 s/div (steps of 1-2-5)		
Time base accuracy ¹ :	±0.001%		
Time axis measurement accuracy ¹ :	± (0.01% + 10 ps + 1 sample interval)		
Max. acquisition rate ⁵ :	When using 1.25 MW, 60 waveforms/sec/ch When using 12.5 kW, 9000 waveforms/sec/ch When using 2.5 kW, 25000 waveforms/sec/ch 400 ns or less (equivalent to 2.5 M waveforms/sec)		
Min. dead time (N single) ⁶ :	400 ns or less (equivalent to 2.5 M waveforms/sec)		

Trigger Section

Trigger modes:	Auto, Auto Level, Normal, Single, and N Single
Trigger source:	CH1 to CH4: Signals applied to measurement input terminals LINE: Connected commercial power signal (only available with Edge trigger) EXT: Signal input from EXT TRIG IN terminal
Trigger level range:	CH1 to CH4: ±4 divisions from the screen center EXT: ±2 V (1:1), ±20 V (10:1 when used with a probe)
Trigger level setting resolution:	CH1 to CH4: 0.01 div EXT: 5 mV (1:1), 50 mV (10:1 when used with a probe)
Window comparator:	Separately configurable on each of channels CH1 to CH4
Center:	±4 divisions from the screen center
Width:	±4 divisions from Center

Trigger level accuracy:	CH1 to CH41: ±(0.2 div + 10% of trigger level) EXT ⁷ : ±(50 mV + 10% of trigger level)
Trigger sensitivity:	DL9040/DL9040L DL9140/DL9140L DL9240/DL9240L CH1 to CH41 1 div/p-p DC to 500 MHz DC to 1 GHz DC to 1 GHz EXT ⁷ 100 mV/p-p DC to 100 MHz DC to 100 MHz DC to 100 MHz where Edge OR1 1 div/p-p DC to 50 MHz DC to 50 MHz DC to 50 MHz
Trigger types:	Edge/State: Trigger occurs on the edge of a single trigger source. Edge (Qualified): Trigger occurs on the edge of a single trigger source when Qualification condition is true. Edge OR: Trigger occurs on the OR logic of the edge conditions set to multiple trigger sources. State: Trigger occurs on ENTER/EXIT when the state condition is true.
Width:	Pulse: Trigger occurs on a width of a single trigger source. Pulse (Qualified): Trigger occurs on a width of a single trigger source when Qualification condition is true. Pulse State: Trigger occurs on a width when the state condition is true.
Time width setting mode:	More than: Trigger occurs upon change in condition when the condition remains true longer than time T1. Less than: Trigger occurs upon change in condition when the condition remains true shorter than time T1. Between: Trigger occurs upon change in condition when the condition remains true longer than time T1 and shorter than time T2. Out of Range: Trigger occurs upon change in condition when the condition remains true shorter than time T1 and longer than time T2. Time out: Trigger occurs when the condition is true for duration longer than time T1.
Specified time (T1/T2):	1 ns to 10 s, 500 ps resolution
Time accuracy:	±(0.2% of setting + 1 ns)
Event Interval:	Trigger occurs when the event cycle is within the specified time range.
Event Cycle:	After Event 1 occurs, trigger occurs on 1st occurrence of Event 2 that satisfies the timing constraints. The trigger process is reset if Event 1 or Event 2 occurs before the timing constraints are satisfied.
Event Delay:	After Event 1 occurs, trigger occurs on 1st occurrence of Event 2 that satisfies the timing constraints. The trigger process is reset if Event 1 occurs before the timing constraints are satisfied.
Event Sequence:	Function identical to the time width setting mode for Width
Time width setting mode:	Specified time (T1/T2): 1.5 ns to 10 s, 500 ps resolution Time accuracy: ±(0.2% of setting + 1 ns)
Event types:	Events can be selected from Edge, Edge Qualified, State, Pulse, Pulse Qualified, Pulse State, I ² C, CAN, SPI, and Serial trigger types.
Enhanced:	TV: Trigger occurs on video signals of various broadcasting system formats Mode: NTSC, PAL, HDTV, USER Input CH: CH1-CH4 Sync Guard: Hsync 60 to 90% (increments of 1%) Line: 5-1054 (NTSC), 2-1251 (PAL), 2-1251 (HDTV), 2-2048 (USER) Field: 1/2/X Frame Skip: 1/2/4/8 I ² C: Triggers on I2C bus signals Mode: NON ACK, Every Start, General Call, (Start byte/HS Mode), ADR&DATA SPI: Triggers on SPI (serial peripheral interface) bus signals Mode: 3 wire, 4 wire CAN: Bit rate: 1 Mbps, 500 kbps, 250 kbps, 125 kbps, 83.3 kbps User (freely settable in 100 bps increments) Input channel: CH1 to CH4: Input through differential probe Mode: SOF, Frame ID, Data field, Remote Frame, Error Frame, Ack etc. Serial pattern: Triggers on general-purpose serial communication signals. Max. bit rate: 50 Mbps Max. bit length: 128 bits

Display

Display:	8.4-inch (21.3 cm) color TFT liquid crystal display
Display screen size:	170.5 mm (width) × 127.9 mm (height)
Total number of pixels:	1024 × 768 (XGA)
Waveform display resolution:	800 × 640

Main Specifications



Functions

Waveform Acquisition/Display Functions:	
Acquisition modes:	Selectable from three acquisition modes – Normal, Average and Envelope
High resolution mode:	Vertical resolution is increased to max. 13 bits.
Repetitive sampling mode:	Allows switching between realtime and repetitive sampling in certain time axis settings.
Interpolate function:	Interpolates actual sampled data by up to 1000 times (or up to 2000 times in High-Res. mode) and increases the time resolution (up to 2.5 TS/s)
Roll mode:	Roll-mode display is enabled during the following time axis range when the trigger mode is Auto, Auto Level or Single: 100 ms/div to 50 s/div
Record length:	
DL9040L/9140L/9240L:	2.5 kW, 62.5 kW, 12.5 kW, 25 kW, 62.5 kW, 125 kW, 250 kW, 625 kW, 1.25 MW, 2.5 MW, 6.25 MW
DL9040/9140/9240:	2.5 kW, 62.5 kW, 12.5 kW, 25 kW, 62.5 kW, 125 kW, 250 kW, 625 kW, 1.25 MW, 2.5 MW
Accumulation:	Accumulates waveforms on the display. Choose Count/Time and Inten/Color.
Snapshot:	Retains the current displayed waveform on the screen.

Analysis Functions

Search and Zoom function:	Zooms the displayed waveform along the time (Horizontal Zoom) and voltage (Vertical Zoom) axes. Independent zooming factors can be applied to two zoom areas.
Voltage axis zoom factor:	1 to 10 times
Time axis zoom factor:	1 time to 1data/div
Auto scroll function:	Automatically scrolls the zoom window along the time axis
Search function:	Searches the currently displayed waveform for a specified portion occurring beyond a specified time, and displays the zoomed result on the screen.
Search types:	Edge, Edge Qualified, State, Pulse, Pulse Qualified, Pulse, State, Serial Pattern, I ² C (optional), SPI (optional)
History memory:	
Max data:	DL9040L/9140L/9240L: 2000 (2.5 kW), when using history 1600 (2.5 kW), when in N single mode DL9040/9140/9240: 1000 (2.5 kW), when using history 800 (2.5 kW), When in N single mode
History search:	Searches for and displays waveforms from the history memory that meet specified conditions.
Search types:	Rect, WAVE, Polygon, Parameter (Measure/FFT/XY)
Replay:	Automatically replays history waveforms.
Display:	Selected acquisition (#) or Average (Avg)
Cursor measurements:	The following five cursors can be selected: Vertical, Horizontal, VT, Marker, Serial
Automatic measurement of waveform parameters:	Performs automated measurement of the following waveform parameters.
Items unrelated to cycle which will be derived out of all data in the range.	MAX, MIN, HIGH, LOW, P-P, HIGH-LOW, +OVER, -OVER, RMS, MEAN, Sdev, IntegTY
Items related to cycle which will be derived out of all data in the range.	C.rms, C.mean, C.Sdev, C.IntegTY, (1/FREQ), FREQ, COUNT, BURST
Items which will be derived from the beginning of the specified range.	+WIDTH, -WIDTH, PERIOD, DUTY, RISE, FALL, DELAY
Telecom test:	Performs mask test and eye pattern measurement
Mask test items:	Wave Count, Wave Count%, Sample Point Count, Sample Point Count%
Eye pattern items:	Vtop, Vbase, stop, sbase, Tcrossing1, Tcrossing2, Vcrossing, Crossing%, Eye Height, Eye Width, Q Factor, Jitter, Duty Cycle Distortion%, Ext Rate dB, Rise, Fall
Computation functions:	Computes up to eight traces (CH1-CH4/M1-M4) +, -, /, INTEG, COUNT (EDGE), COUNT (ROTARY), Through, Delay, Moving Avg, LowPass, High Pass, Stuff Bit (CAN option)
Reference functions:	Display and analysis (computation and cursors) of up to four traces (M1-M4) of the saved waveform data. Waveforms including history can also be loaded for history searches or replay. Various parameters can be changed (however waveforms are not affected by T/Div changes).
Action-on-trigger:	Automatically measured waveform parameters and waveform zones are determined, and the selected action is carried out each time conditions are met.
Modes:	OFF, All Condition, (GO/NOGO Zone/Param), GO/NOGO Telecom Test)
Actions:	Buzzer, Print, Save, Mail
All conditions:	After EXEC is pressed, the specified action is performed upon each acquisition
GO/NOGO zone:	Determines whether or not the acquired waveform passes through the specified area
Zone types:	RECT, Polygon, WAVE
GO/NOGO parameter:	Determines whether or not the specified parameter of the acquired waveform is within the specified range

Param:	Choose Measure, FFT, or XY
GO/NOGO telecom test:	Performs judgment using the conditions specified in the telecom test.
ANALYSIS:	Selectable from XY, FFT, Wave Parameter, Accum Histogram and Serial Bus
X-Y:	displays XY1, XY2 and T-Y simultaneously
FFT:	supports up to 250 k points FFT
Wave parameter:	Single wave parameters can be viewed in one of the following formats. (Histogram, Trend and List)
Accum histogram:	A histogram of the selected area can be displayed for a continuous signal.
Serial bus:	I ² C, SPI and CAN buses can be analyzed and the analysis results displayed (optional).

I²C Bus Analysis Functions (optional)

•Applicable bus:	I ² C bus: Bus speed : Max. 3.4 Mbit/s Address mode : 7 bit/10 bit SM bus: complies with System Management bus
•Trigger function (standard):	Source : SCL : CH1 to CH4 : SDA : CH1 to CH4
Type:	Selectable from the following five options: - Address & data: trigger on combination of assigned address & data pattern - Non-Ack: trigger on non acknowledge condition - Every start: trigger on start condition - General call: trigger on general call and the following byte - Start byte / HS mode: trigger on Start byte and HS mode
•Analysis function:	Signal input: CH1 to CH4, M1 to M4 can be configured Detailed data display mode: Time from the reference point, data (simultaneous binary and hex representations), presence/absence of ACK, R/W, address or data, start condition
Simple display mode:	Data (hex representation), R/W, start condition, presence/absence of ACK, address or data
Analyzable number of data items:	40,000 bytes max.
•Search function:	Pattern search: Searches data that agrees with the preset address pattern, data pattern and acknowledge bit condition.
•Analysis result save function:	Storage of analysis list data: The data can be saved to CSV-format files.

SPI Bus Analysis Functions (optional)

•Trigger function:	Mode: 3 wire/4 wire Bit order: MSB/LSB Source: Clock signal (SCK) CH1 to CH4 Data 1 (MOSI) CH1 to CH4 Data 2 (MISO) CH1 to CH4 CS signal (SS) CH1 to CH4
•Analysis function:	Analyzable number of data items: 40,000 bytes max. Display of analysis results: Analysis results can be displayed using the following 2 methods - Simple analysis result list: Data (hex representation), CS signal status - Detailed analysis result display: Detailed analysis result list, time from the reference point, data (select and show either Binary or Hex data), and CS signal status can be displayed.
•Search function:	- Pattern search: Waveforms can be searched by specifying data pattern. When a waveform that agrees with the pattern is found, the zoom box moves to the position of that waveform to show the specified waveform.
•Analysis result save function:	Storage of analysis list data: The data can be saved to CSV-format files.

CAN Bus Analysis Functions (optional)

•Applicable bus:	CAN version 2.0 A/B High-speed CAN (ISO11898) Low-speed CAN (ISO11519-2)
•Bit rate:	1 Mbps, 500 kbps, 500 kbps, 250 kbps, 125 kbps, 83.3 kbps, user-defined
•Trigger function (standard):	Source: CH1 to CH4, Input through differential probe Type: SOF trigger Frame ID trigger Data field trigger: Selectable up to 8 bytes Remote Frame trigger Error Frame trigger Ack trigger

Frame ID, Data OR trigger, (Specify up to four ID, Data or Ack trigger conditions to set triggers on a logical OR condition.)	Event Interval trigger
•Analysis function:	Analyzable number of frames: 3,000 max. Analysis result display: Waveform and analysis list display Detailed analysis list display (Analysis display items: Frame type, time from trigger point, frame ID, DLC, Data, CRC, presence/absence of ACK)
•Analysis support functions:	Data search Field jump Stuff bit calculation
•Analysis result save function:	Storage of analysis list data: The data can be saved to CSV-format files.

Built-in Printer (/B5 Option)

Printing method	Thermal line-dot
Paper width	112 mm
Effective print width	104 mm (832 dots)

Auxiliary I/O Section

Rear panel I/O signal:	Ext. trigger input, ext. trigger output, trigger comparator output, GO/NO-GO I/O, video output
Probe interface terminal (front panel)	No. of terminals: 4 Supported probes: PBA2500, PBD2000, PB500
Probe power terminal (/P2 option, rear panel):	No. of terminals: 2 Supported probes: FET probe (700939), current probes (701930, 701931, 701932, 701933), and differential probes (701920, 701921, 701922)

Storage

Internal storage media:	Capacity: 90 MB (Flash ROM) Usage: Saving and loading of waveforms and panel settings
-------------------------	--

Internal Hard Drive (/C8 Option)

Capacity/file system:	40 GB FAT32
File name:	Supports long file names of up to 256 ASCII characters

USB Peripheral Connection Ports

Connector:	USB-type A connector × 2
Supported transmission standards:	LS (Low Speed) mode (1.5 Mbps), FS (Full Speed) mode (12 Mbps)
Supported devices:	USB HID Class Ver1.1-compliant mouse/109 keyboard USB Printer Class Ver.1.0-compliant printers EPSON: Ink Jet Printers HP: PCL Ink Jet Printers USB Mass Storage Class Ver.1.1-compliant mass storage device USB hub device (1 unit only) * Please contact your local Yokogawa sales office for model names of verified devices
Max. No. of devices:	4

PC Card Interfaces

Number of slots:	2 (front panel (1), rear panel (1))
Supported cards:	GPIO card (National Instruments NI PCMCIA-GPIB card), Flash ATA memory card (PC card TYPE II), CF card + adapter card, and various hard disk type PC cards * Please contact your local Yokogawa sales office for model names of verified devices

USB-PC Connection Ports

Connector:	USB-type B connector × 1
Supported transmission standards:	HS (High Speed) mode, FS (Full Speed) mode
Supported class:	Operates as a multifunctional device simultaneously supporting the following two protocols: USBTMC-USB488 (USB Test and Measurement Class Ver.1.0) A USB bus can be employed to use GPIB commands. Mass Storage Class Ver.1.1 The DL9000's internal storage media, hard disk, PC card, and USB mass storage device can be accessed (read/write) from a PC (formatting is not supported).

Ethernet Communication (/C10 and /C8 Options)

Connector type:	RJ-45 connector × 1
Transmission method:	Ethernet (100BASE-TX/10BASE-T)
Supported services:	DHCP, DNS, Microsoft network file sharing server & client, FTP server, SNMP client, SMTP client, Firewall functions (network printers will be supported in the near future)

General Specifications

Rated supply voltage:	100 to 120 V AC/200 to 240 V AC (automatically selected)
Allowable supply voltage fluctuation range:	90 to 132 V AC/180 to 264 V AC
Rated supply frequency:	50/60 Hz
Allowable power supply frequency variation:	48 to 63 Hz
Maximum power consumption:	300 VA
Withstanding voltage (between power supply and case):	1.5 kV AC for one minute.
External dimensions:	350 (W) × 200 (H) × 178 (D) mm (when printer cover is closed; excluding handle and protrusions) Approx. 6.5 kg (including printer)
Weight:	
Battery backup:	Setup data and clock are backed up by an internal lithium battery
Battery life:	Approximately 5 years (at an ambient temperature of 25°C)
Operating temperature range:	5–40°C

- Measured value under standard operating conditions after a 30-minute warm-up followed by calibration.
Standard operating conditions:
Ambient temperature: 23 ±5°C
Ambient humidity: 55 ±10%
Error in supply voltage and frequency: Within 1% of rating
- Value in the case of a repetitive signal
The frequency bandwidth of a single-shot phenomenon is the smaller of the two values, DC to sampling frequency/2.5 or the frequency bandwidth of the repetitive phenomenon.
- When the input section is shorted, the acquisition mode is set to normal, the interleave mode is OFF, accumulation is OFF, and the probe attenuation is set to 1:1.
- Typical value denotes a representative or average value and is not strictly guaranteed.
- The parallel acquisition architecture of the DL9000 series ensures no decrease in acquisition rate for multi-channel use.

External Dimensions (Common to All Models)

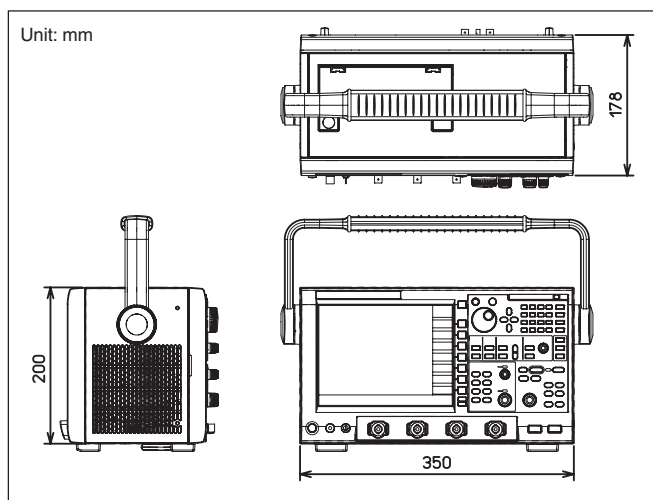

For detailed specifications, visit our homepage at <http://www.yokogawa.com/tm/DL9000>

Model and Suffix Codes of DL9040/9140/9240

Model	Suffix Code	Description
701307		DL9040 digital oscilloscope 500 MHz max. 5 GS/s (2.5 GS/s/ch), 2.5 Mword/ch
701308		DL9040L digital oscilloscope 500 MHz max. 5 GS/s (2.5 GS/s/ch), 6.25 Mword/ch
701310		DL9140 digital oscilloscope 1 GHz max. 5 GS/s (2.5 GS/s/ch), 2.5 Mword/ch
701311		DL9140L digital oscilloscope 1 GHz max. 5 GS/s (2.5 GS/s/ch), 6.25 Mword/ch
701312		DL9240 digital oscilloscope 1.5 GHz max. 10 GS/s (5 GS/s/ch), 2.5 Mword/ch
701313		DL9240L digital oscilloscope 1.5 GHz max. 10 GS/s (5 GS/s/ch), 6.25 Mword/ch
Power cable	-D	UL/CSA standard
	-F	VDE standard
	-Q	BS standard
	-R	AS standard
	-H	GB standard
Help menu language	-HE	English Help
	-HC	Chinese Help
	-HK	Korean Help
Options	/B5	Built-in printer
	/P2 ¹	Probe power connections on rear panel (2 outputs for 900 MHz FET probe and current probe)
	/C8 ²	Built-in HDD + Ethernet Interface
	/C9 ²	Built-in HDD + LXI Compliant Ethernet Interface
	/C10 ²	Ethernet Interface
	/C12 ²	LXI Compliant Ethernet Interface
	/G2 ³	User-defined math function
	/G4 ³	Power Supply Analysis Function
	/F5 ⁴	UART + I ² C + SPI bus analyzer
	/F7 ⁴	UART + CAN + SPI bus analyzer
/F8 ⁴	UART + I ² C + CAN + SPI bus analyzer	

1: Please specify this /P2 option if you use either current probes or differential probes such as 701920 or 701922.

2: Choose either one.

3: Choose either one.

4: Choose either one. UART, I²C, CAN and SPI bus signal triggers are standard.

[signal explorer™ is a registered trademark of Yokogawa Electric Corporation.]

Microsoft, MS, Windows, and Internet Explorer are registered trademarks or trademarks of Microsoft Corporation in the US and other countries.
This product's TCP/IP software and documentation on TCP/IP software were developed/manufactured by Yokogawa based on BSD Networking Software, Release1, under license from the University of California.
Other company names and product names appearing in this document are the registered trademarks or trademarks of their respective companies.

Yokogawa's Approach to Preserving the Environment

- Yokogawa's electrical products are developed and produced in facilities that have received ISO14001 approval.
- In order to protect the global environment, Yokogawa's electrical products are designed in accordance with Yokogawa's Environmentally Friendly Product Design Guideline and Product Design Assessment Criteria.

Standard Accessories

Name	Qty
Power cable	1
3 prong-to-2 prong adapter	1
PB500 passive probe	4
Printer roll paper (when option /B5 is specified)	3
User's manual (1 set)	1
Front panel cover	1
Rubber leg cap	6
Soft case	1

Accessories (Optional)

Name	Model	Specifications
PB500 (10:1 passive probe)	701943	10 MΩ (10:1), 500 MHz, 1.5 m (one per order)
Mini-clip converter	700971	For use with PB500
BNC adapter	700972	For use with PB500
Grounding lead	700973	For use with PB500
PBA2500 (2.5 GHz active probe)	701913	2.5 GHz BW
PBL5000 (5 GHz probe)	701974	5 GHz BW
DC block	701975	For 50 Ω input, SMA connector
FET probe*	700939	900 MHz BW
100:1 probe	700978	100 MHz BW
Differential probe	701921	DC to 100 MHz BW/±700V Max.
Differential probe*	701922	DC to 200 MHz BW/±20 V Max.
PBD2000 (2 GHz differential probe)	701923	2 GHz BW
Differential probe	700924	DC to 100 MHz BW/±1400 V Max.
Differential probe*	701920	DC to 500 MHz BW/±30 V Max.
Current probe*	701933	DC to 50 MHz BW, 30 Arms
Current probe*	701932	DC to 100 MHz BW, 30 Arms
Printer roll paper	B9988AE	10 m roll, 10 rolls/order
Rack mount kit	701984-01	EIA standard-compliant
	701984-02	JIS standard-compliant

* requires /P2 option on the DL9000.

Related Products



Note



• Before operating the product, read the user's manual thoroughly for proper and safe operation.

YOKOGAWA

YOKOGAWA ELECTRIC CORPORATION

Communication & Measurement Business Headquarters /Phone: (81)-422-52-6768, Fax: (81)-422-52-6624

E-mail: tm@cs.jp.yokogawa.com

YOKOGAWA CORPORATION OF AMERICA

Phone: (1)-770-253-7000, Fax: (1)-770-251-6427

YOKOGAWA EUROPE B.V.

Phone: (31)-33-4641858, Fax: (31)-33-4641859

YOKOGAWA ENGINEERING ASIA PTE. LTD.

Phone: (65)-62419933, Fax: (65)-62412606

Subject to change without notice.

[Ed : 03/b] Copyright ©2005

Printed in Japan, 608(KP)

MS-16E