



Advanced Test Equipment Rentals
www.atecorp.com 800-404-ATEC (2832)

G Series

AC Power Systems

6 to 90 kVA
45 to 5,000 Hz

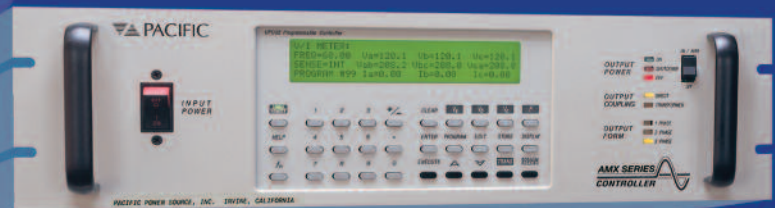

Solid State AC Power Conversion

- Programmable AC test power, 45 to 5,000 Hz.
- Power line susceptibility tests: spike, sag, surge.
- Flexible, expandable lab power.
- Precision frequency conversion.
- High reliability UPS.

**ONE PHASE/THREE PHASE
SWITCH SELECTABLE AC POWER
FOR THE MOST DEMANDING APPLICATIONS**

The Power of Expertise



www.pacificpower.com

Precision Performance Design Excellence Unmatched Flexibility

The simple basic design concepts used in Pacific Power G Series equipment have resulted in continuous application expansion since product inception. Exceptional reliability and serviceability are a hallmark of G Series equipment and have placed G Series in the most demanding applications for AC Power in the world.

Controller Options provide for applications ranging from simple manually controlled frequency conversion to very sophisticated BUS programmable transient simulations.

Power modules provide output frequencies up to 5,000 Hz. Modules have **Excellent Peak Current** capability and are short circuit protected with auto recovery.

Power modules utilize linear power amplifier technology to provide **High Quality Power and Microsecond Response** to controller stimulus and load power demand.

Output Autotransformers provide a broad range of output power forms with exceptionally high performance for faithful transient simulation.

Power modules operate in **Single or Three Phase Mode** as driven by the controller.

Power modules contain **Redundant Output Devices** which are electronically disconnected from system output if failed. Identification of suspect module is made through service lamps and diagnostic meter on each power module. Power modules themselves are redundant and can be replaced “on-line” without shutting down output power.

G Series Systems are **Easily Paralleled** in the field. Systems may vary in power from 6 to 90 kVA.

Universal, Wide Range Input magnetics include tap options for common power forms found throughout the world.

If you are unwilling to compromise your power quality and reliability, consider the power source that has proven itself in thousands of demanding applications – Pacific Power G Series.



System Configuration

G Series Systems are readily configurable as frequency converters, line conditioners, programmable test systems and uninterruptible power systems.



The basic building block of a G Series AC Power System is the mainframe. The mainframe consists of the cabinet and AC-to-DC power supply. Up to five mainframes may be paralleled to increase system output power up to 90 kVA.

Each Pacific power source is burned in and meticulously tested before it can leave the Pacific factory. With close attention to detail, handcrafted workmanship comes through with every system delivered.

Due to its modular design, failed device disconnect circuitry, and on-line module replacement, Pacific G Series Systems are unmatched in reliability and ease of service.

390-GRC, 18 kVA Mainframe with 301-C Manual Controller

301-F Universal Control Module

SCU/UPC-32 Programmable Controller

3, 6, or 9 120-GR Power Modules

Mainframe Power Supply

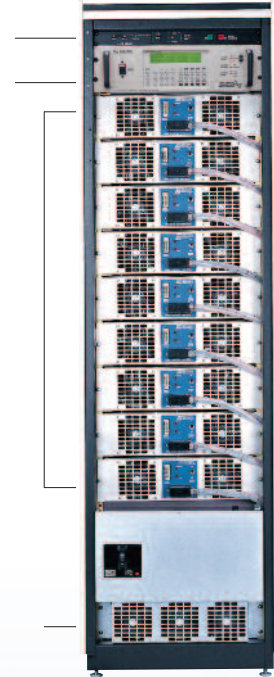

390-GRS, 18 kVA Mainframe with SCU/UPC-32 Programmable Controller

Shown is a simple block diagram that illustrates input power isolation, control module options, single phase/three phase select mechanisms, as well as optional output magnetics.

G Series Output Transformers are designed for operation as an auto-transformer with windings in series or parallel. Carefully interleaved, these transformers provide excellent regulation from 45 to 500 Hz (2,000 Hz with SCU and 5,000 Hz option installed).

Some useful secondary output configurations include:

- 0–120 V L-L 3Ø DELTA 0–277/480 V L-L 3Ø WYE
- 0–240/416 V L-L 3Ø WYE 0–240 V L-L DELTA
- 0–220/380 V L-L 3Ø WYE 0–120/240 V Split 1Ø

When output voltages other than the “direct coupled” 0–125/216 VAC are required, add the suffix “T” to the model number. This option adds three high performance autotransformers within the mainframe. As the diagram shows, the transformer primaries are activated with the direct coupled output by the main output contactor. Output magnetics may be connected to the single phase output contactor when specified at the time of order. Transformers are carefully balanced to ensure load sharing when multiple cabinets are in parallel.

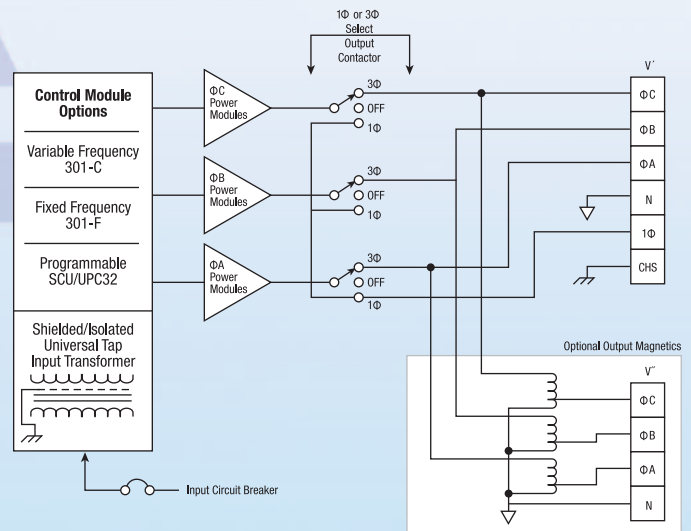

Model Number Information

Standard Models are complete systems ready for use, including cabinets, oscillators, input circuit breakers and output contactors. Use model designations below to design the system that is right for your application.

MODEL	OUTPUT POWER (kVA)	1 PHASE OUTPUT			3 PHASE OUTPUT			CABINETS	
		VOLTS (RMS)	AMPS (RMS)	AMPS (PEAK)	VOLTS (RMS)	AMPS/LEGS (RMS)	AMPS/LEGS (PEAK)		
390-GR □□ - 6	6	120	48	144	120/208 WYE or 208 DELTA	16	48	1 ea. 390-G	Fixed and/or Variable Frequency 1 phase or 3 phase User Switch Selectable Models
390-GR □□ -12	12	120	96	288	120/208 WYE or 208 DELTA	32	96	1 ea. 390-G	
390-GR □□ -18	18	120	144	432	120/208 WYE or 208 DELTA	48	144	1 ea. 390-G	
3120-GR □□	24	120	192	576	120/208 WYE or 208 DELTA	64	192	2 ea. 390-G	
3150-GR □□	30	120	240	720	120/208 WYE or 208 DELTA	80	240	2 ea. 390-G	
3180-GR □□	36	120	288	864	120/208 WYE or 208 DELTA	96	288	2 ea. 390-G	
3210-GR □□	42	120	336	1008	120/208 WYE or 208 DELTA	112	336	3 ea. 390-G	
3240-GR □□	48	120	384	1152	120/208 WYE or 208 DELTA	128	384	3 ea. 390-G	
3270-GR □□	54	120	432	1296	120/208 WYE or 208 DELTA	144	432	3 ea. 390-G	
3360-GR □□	72	-	-	-	120/208 WYE or 208 DELTA	192	576	4 ea. 390-G	
3450-GR □□	90	-	-	-	120/208 WYE or 208 DELTA	240	720	5 ea. 390-G	

A Power System is assembled using the options defined by the following model designations:

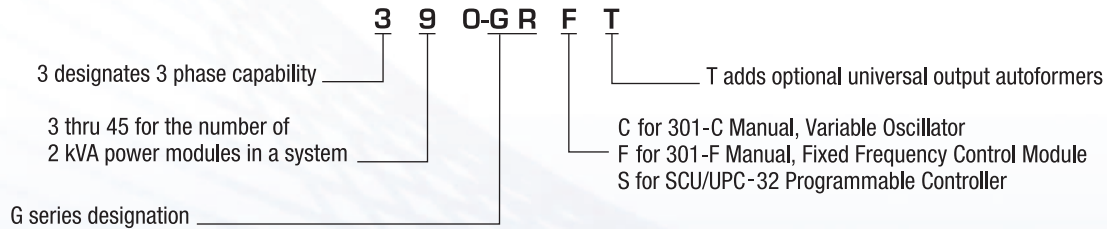

Control and Power Options

301-C Variable Control Module (Manual)

- Provides for selection of three different control options:
 - Internal fixed frequencies of 50, 60 and 400 Hz.
 - Continuously variable oscillator from 47 to 500 Hz.
 - External signal generator inputs.
- Provides for selection of the output power form:
 - Single phase operation.
 - Three phase operation.
- Provides control of the mainframe output contactor to turn power on and off.

301-F Universal Control Module (Manual)

- Provides for selection of three different control options:
 - Internal fixed frequencies of 50, 60 and 400 Hz.
 - External signal generator inputs.
 - Input from the SCU/UPC-32 Programmable Controller from 45 to 5,000 Hz.
- Provides for selection of the output power form:
 - Single phase operation.
 - Three phase operation.
- Provides control of the mainframe output contactor to turn power on and off.

SCU/UPC-32 Programmable Controller

- Provides total control of the output signal from either the front panel keypad or from a remote computer via the IEEE or RS-232 (optional) BUS.

Programmable parameters include:

- Frequency.
- Frequency transients.
- Phase angle separation.
- Voltage amplitude.
- Voltage amplitude transients.
- Transient phase (any combination of phases).
- Transient starting phase angle.
- Waveform generation.

- Requires 301-F universal control module.

Power Modules (Standard)

120-GR Enhanced power modules for applications requiring motor starting, high short circuit current, frequencies from 45 to 5,000 Hz and fast transient and harmonic reproduction.

Output Magnetics

- Standard internally mounted output autoformers provide many popular output voltage options. See partial listing under System Block Diagram on page 3.
- Other special magnetics options are available.

Special Features Available with the SCU/UPC-32 Programmable Controller

Continuous Self Calibration

Provides for exceptional accuracy of the AC Output Voltage. When enabled, accuracy improves to $\pm 0.03\%$ referenced to the power source internal voltmeter.

Programmable Dynamic Output Impedance (Optional)

Provides positive or negative output impedance. The output voltage waveform at the right is flattened as a result of a high peak load current drawn by an electronic load at the peak of the sine wave.

Engaging the dynamic output impedance (Z_o) feature dynamically compensates, as shown at the right, for the distribution or transformer losses up to $\pm 10\%$ of the output voltage.

Waveform Edit

Provides the ability to modify a stored waveform by specifying the waveform amplitude desired at each specific phase angle. This method can be used to quickly create spikes, dropouts, notches and other sub-cycle wave conditions. The resulting modified waveform can be stored for execution.

Waveform Library

Up to 99 different waveforms may be stored in the waveform library for execution as part of a steady state test program or for substitution in any output phase as part of a transient test program. Memory location #1 is a non-editable high resolution sine wave. Locations 2–16 are editable and may be substituted in any output phase.

Waveform Analysis (Optional)

Provides numeric display of the harmonic structure of a voltage or current waveform. The waveform is sampled at 512 samples per cycle using a 12-bit A/D converter. The resulting high fidelity waveform is analyzed for its harmonic structure up through the 51ST harmonic. Data presented includes the magnitude of each harmonic in percent, the total harmonic distortion, and the odd and even harmonic distortion in percent. Displays V_{rms} , I_{rms} , I_{pk} , Power, VA and PF.

Waveform Synthesis (Optional)

Provides the ability to quickly create virtually any AC Test Waveform that may be required by building it out of harmonics. The process is as simple as keying in the harmonic multiple, the amplitude, and the phase angle for each desired harmonic up through the 51ST. If desired, waveforms may also be created in the time domain by making entries from the front panel or by downloading from a host PC.

Time-Based Transients

Provides the ability to create and execute, on command, transients that occur linearly over a specified time segment to modify output voltage or frequency.

Cycle-Based Transients

Provides the ability to create and execute, on command, transients that substitute a selected waveform in the output for 1 to 100 cycles. The waveform being substituted can be selected and/or modified from the waveform library. Substitution is for an integer number of cycles, regardless of frequency.

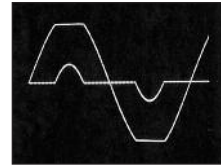

Oscilloscope of voltage and current waveform at load due to distribution losses. THD=6.6%

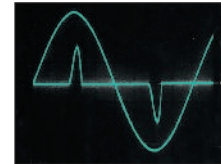

Same conditions as above with programmable Z_o engaged. THD=0.25%

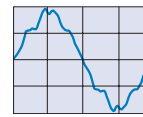

THD=8.7%

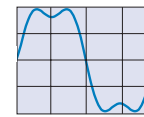

THD=22.2%

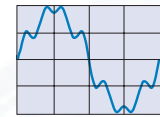

THD=18.1%

EDIT WAVEFORM: NUMBER=16	RANGE=2-16
STARTING PHASE ANGLE=0	0-359.5°
ENDING PHASE ANGLE=0	0-359.5°
VOLTAGE IN PERCENT=-100	(+/-)0-100%

WAVEFORM EDIT

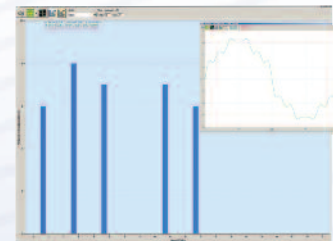

HARMONIC CONTENT OF METERED WAVEFORM

WAVEFORM SYNTHESIS: WAVEFORM #2					
HARMONIC:	2nd	3rd	4th	5th	6th
CONTENT:	.1%	0%	0%	0%	0%
Ø ANGLE:	0°	0°	0°	0°	0°

WAVEFORM SYNTHESIS

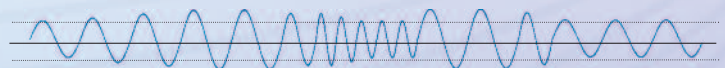

TIME-BASED TRANSIENTS



CYCLE-BASED TRANSIENTS

SCU/UPC-32 Controller Specifications

The UPC controller is a 3Ø AC arbitrary waveform generator and precision AC metering system. Each waveform stored in the UPC is encoded with 12-bit amplitude and 10-bit time resolution for each cycle. The waveform for each phase may be independently selected and varied in amplitude and phase angle with respect to phase A.

The UPC output metering samples the output volts and amps at 512 samples per measurement using a 12-bit A/D converter. This technique provides exceptional metering accuracy and resolution (20 bits), and delivers a high-fidelity waveform back to a host computer for analysis.

The UPC includes a remote GPIB interface compatible with IEEE-488.2 and SCPI. An available option is an RS-232 serial port that operates up to 38.4 kBaud.

Frequency	45.00 to 5,000 Hz $\pm 0.01\%$.	Voltmeter	Range 0–354 V L-N. 0–708 V L-L.
Voltage Direct	Programmable, 0– V_{MAX} , in 0.1 V steps (see table on page 4).		Resolution 0.10V _{AC} to front panel. 0.001V _{AC} to remote interface.
Voltage Transformer	Multi-range units are equipped with output transformers. When alternate range is selected, voltage at transformer output is programmable in steps of 0.5 V.		Accuracy $\pm 0.25\%$ of reading $\pm 0.1\%$ of range (50–500 Hz).
Accuracy Command Voltages	Executive voltage is within ± 50 mV (0.03%) of command voltage, referenced to the internal voltmeter with CSC engaged.	Ammeter	Range 300% of system current rating. Resolution 0.01A _{AC} to front panel. 0.001A _{AC} to remote interface.
Accuracy Command Frequency	$\pm 0.01\%$, 45–5,000 Hz.		Accuracy $\pm 0.25\%$ of reading $\pm 0.1\%$ of range (50–500 Hz).
Output Z_o (Optional)	Dynamic output impedance (Z_o) is programmable, 0 to $\pm Z_o$ max. in 0.1% steps. Z_o value in milliohms varies with different models but usually results in a $\pm 10\%$ change in output voltage at maximum load amps.	Power Meter	Range Based on ammeter range. Resolution 1.0 watts or VA to front panel. 0.001 Watts or VA to remote interface. Accuracy $\pm 0.30\%$ of reading $\pm 0.14\%$ of range.
Phase Angle	Phase Angle (\emptyset) of Phases B and C relative to Phase A is programmable from 0°–359° in 1° increments $\pm 0.5^\circ$.	Power Factor/Crest Factor	Calculated and displayed to three significant digits.
Current Limit	Current limit is programmable from 0 to I_{peak} maximum of the power source. Accuracy is $\pm 1\%$, resolution $\pm 0.05\%$.	Ext. Input	Each phase is algebraically summed with UPC waveform and amplified 25 \times to the direct output.
Library Steady State Programs	Stores up to 99 steady state parameter sets consisting of waveform, voltage, frequency, \emptyset angle and current limit. Can be executed by program number from the front panel or the bus.	Amplitude Mod. Input	± 10 V input for each phase modulates the output $\pm 100\%$.
Library Transient Programs	Stores up to 99 transient programs – one associated with each steady state program. Allows for changes in volts and frequency vs. time, or waveform changes by cycle count.	Sync Outputs	1) Zero crossing, Phase A. 2) Transient start-stop. 3) True when Transient is enabled. 4) Clock – 1024 times the output frequency
Library Waveforms	Stores up to 99 waveforms that can be edited and executed in any manner and in any output phase.	Command Response Time	Average time to start of parameter change from bus command (end of string character) is 50 ms. Ramp transition time to final value is settable from 200 μ s to 300 sec.
		Waveform Synthesis	Permits waveform creation by entering % amplitude and phase angle for the 2nd through the 51 ST harmonics.
		Waveform Analysis	Reports voltage and current waveform Analysis harmonic content in % and phase angle for the 2nd through the 51 ST harmonics. Displays THD, OHD, EHD in %.

Electrical Specifications

Output Power

See model listings for appropriate full power ratings.

Output Voltage

Nominal system voltage is 125 V L-N three phase or single phase. Output voltage is fully adjustable from 0–125 V L-N. Three phase forms are configured as WYE and are capable of being loaded either DELTA or WYE.

Alternate Output Voltage

For output forms other than the nominal 125 V L-N refer to System Configuration, page 3.

Output Frequency

Determined by control options.

- 47–500 Hz – Standard with 301-C or 301-E Controller.
- 45–2,000 Hz – Standard with SCU/UPC 32 Programmable Controller.
- 45–5,000 Hz – Optional.

Output Current

See model listings. Peak currents listed are available at the crest of the voltage sine wave for driving inverter or power supply loads without distortion or limiting.

Load Power Factor

Output will drive loads of any power factor leading or lagging. (see P.F. Performance Curve).

Line Regulation

0.1% maximum for $\pm 10\%$ line change.

Load Regulation

$\pm 0.1\%$ at the voltage sense point. May vary due to contactor and cabling losses after the sense point. $\pm 0.25\%$ at system output terminals (3 \emptyset direct-coupled outputs).

Load Balance Restriction

None – all performance specifications apply with any amount of load imbalance.

Load Transient Response

120-GR, 10 microseconds maximum. Applies to a 100% step change in load, any phase, or any combination of phases.

Output Distortion

0.75% total harmonic distortion maximum (0.50% typical).

Output Protection

Integral electronic current limiting with auto recovery.

Output Isolation

Output is fully isolated from input and frame ground.

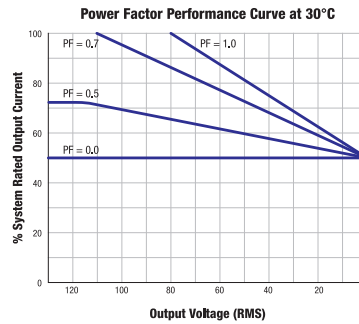

Output Storage (Ride-Through)

Output undisturbed by line interrupts of several milliseconds-load dependent.

Output DC Offset

DC offset is less than ± 10 mV DC.

Phase Separation

“C” Type Systems $-3\emptyset$ WYE $120^\circ \pm 1.0^\circ$ regardless of load balance.

3 \emptyset DELTA $60^\circ \pm 1.0^\circ$ regardless of load balance.

Control Characteristics

“C” Type Systems variable frequency, 1 \emptyset or 3 \emptyset switch selectable operation.

Output frequency – 1 continuous variable range of 47–500 Hz, dial accuracy $\pm 1\%$, stability 0.25%, 3 pushbuttons select preset frequencies of 50, 60, 400 Hz. Accuracy $\pm 0.1\% \pm 0.5$ Hz. Stability $\pm 0.1\%$. NOTE: Pushbutton switches are equipped with a lockout feature to prevent accidental changes. External Input – one per phase, fully isolated. Allows system to operate as 3 independent amplifiers (3 phase mode).

Amplitude Control – master control varies all phase(s). 0–full scale amplitude. 3 phase systems have $\pm 10\%$ trim adjustments on B & C phases.

Metering – $4\frac{1}{2}$ ” meter movement capable of measuring V L-N and V L-L via a six-position pushbutton switch (1 \emptyset system V L-N only). “S” Type Systems (see page 6 for control capabilities).

1 Phase/3 Phase Operation

A manual switch allows conversion from 1 phase power forms to 3 phase power forms, instantly. 3 phase systems may be loaded either as WYE or DELTA.

Input Power Forms

The G Series power source is capable of operating from any of the listed input forms:

Form A: 240 VAC, 3 \emptyset DELTA, 47–63 Hz.

Form C: 120/208 VAC, 3 \emptyset WYE, 47–63 Hz.

Form D: 460 VAC, 3 \emptyset DELTA, or 3 \emptyset Ungrounded WYE, 47–63 Hz. Other power forms are available; consult factory.

Failure Isolation System

Any failed output device, multiple devices or power module is electronically disconnected from system output. Failure location is identified by service lamps and diagnostic meter on each power module. Service can be provided when convenient by replacing power modules. Power modules can be replaced WITHOUT system shutdown and without disturbances to system operation.

UPS Option

When performance, maintenance and logistics cannot be compromised, choose Pacific Power Source systems.

Pacific Power’s UG Series Uninterruptible Power Source (UPS) Systems are configured from standard G Series AC Sources and UG-18 Battery Support Cabinets. The UG-18 Battery Support Cabinet is a complete battery back-up system that supports any of the G Series AC Power Source Systems (6, 12 or 18 kVA). One UG-18 cabinet is provided with each G Series mainframe offering paralleled systems up to 90 kVA.

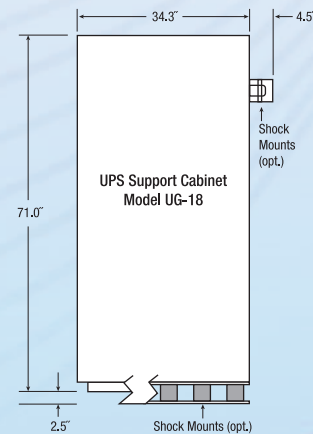
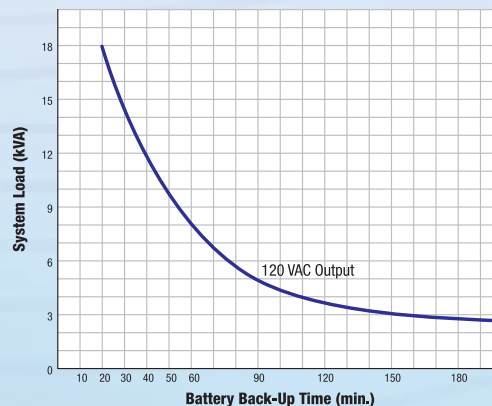

Environmental Characteristics

Efficiency (EFF)

Varies with type of load attached to the power source as follows:

EFF = 70–90% with predominantly power supply type loads.

EFF = 70% at maximum (125 V) output.

EFF = 65% at nominal (120 V) output.

EFF = 60% at low line (105 V) output.

Ambient Temperature

0 to 55°C Operating.

–40° to 85°C Nonoperating.

Humidity

0–95% relative humidity, noncondensating.

Cooling

Self contained fans provide forced air cooling. All air inlets are filtered. Filters are replaceable and reusable.

Heat Dissipation

If system location is to be air conditioned, allow 800 BTU/hour per kVA for a typical electronic load (higher for mixed or linear loads).

NOTE: One ton of cooling = 12,000 BTU/hour.

Ventilation required to maintain less than a 10°C rise in the ambient temperature for a typical electronic load:

390-G – approximately 600 CFM.

Input/Output Service Connections

Input and output connections are made via a heavy duty terminal block mounted inside NEMA-approved junction boxes that are located on the lower rear panel of the mainframe.

Allow an additional 3.25" to overall depth for junction box clearance, or 5.25" when "T" output option is specified.

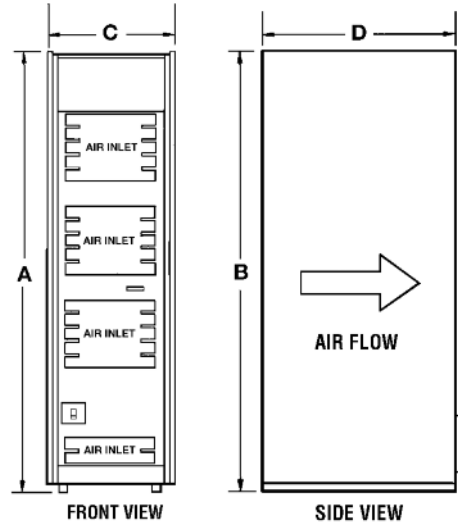

Mechanical Specifications

Dimensions	390-G
A. Height w/caster base	78"
B. Height w/forklift base	78.5"
C. Width	23"
D. Depth	34.5"

Weight 1,000 Lbs.

Air Flow 2,000 CFM

Each G Series mainframe is provided on a caster base with leveling feet for ease of installation.

Forklift or shock mount base is optionally available. Consult the factory for details.

The Leader in Power Technology

As a privately held, leading manufacturer of high-quality AC Power Conversion Equipment, Pacific Power Source, Inc. offers standard catalog products that range in power from 500 VA to >625 kVA. Low-power products include line conditioners, frequency converters and Programmable AC Power Sources. High-power systems include programmable power test equipment, power line conditioners, frequency converters and uninterruptible AC Power Sources.

Founded in 1971, the Irvine, California, company was an early pioneer in the development of linear solid-state power conversion for use in high-reliability applications. The company now manufactures both advanced linear and broadband switching types of AC Power Sources.

For Application Engineering Assistance

Contact the factory directly



17692 Fitch, Irvine, CA 92614 USA

Call direct: +1 949-251-1800 • Fax: +1 949-756-0756

US: 800-854-2433

E-mail: sales@pacificpower.com • www.pacificpower.com

Consult your local PPS Representative