



Errata

Title & Document Type: 83554A Millimeter-Wave Source Module System Manual

Manual Part Number: 83554-90001

Revision Date: April 1986

HP References in this Manual

This manual may contain references to HP or Hewlett-Packard. Please note that Hewlett-Packard's former test and measurement, semiconductor products and chemical analysis businesses are now part of Agilent Technologies. We have made no changes to this manual copy. The HP XXXX referred to in this document is now the Agilent XXXX. For example, model number HP8648A is now model number Agilent 8648A.

About this Manual

We've added this manual to the Agilent website in an effort to help you support your product. This manual provides the best information we could find. It may be incomplete or contain dated information, and the scan quality may not be ideal. If we find a better copy in the future, we will add it to the Agilent website.

Support for Your Product

Agilent no longer sells or supports this product. You will find any other available product information on the Agilent Test & Measurement website:

www.tm.agilent.com

Search for the model number of this product, and the resulting product page will guide you to any available information. Our service centers may be able to perform calibration if no repair parts are needed, but no other support from Agilent is available.

**HP 83554A
SOURCE MODULE
26.5 to 40 GHz**

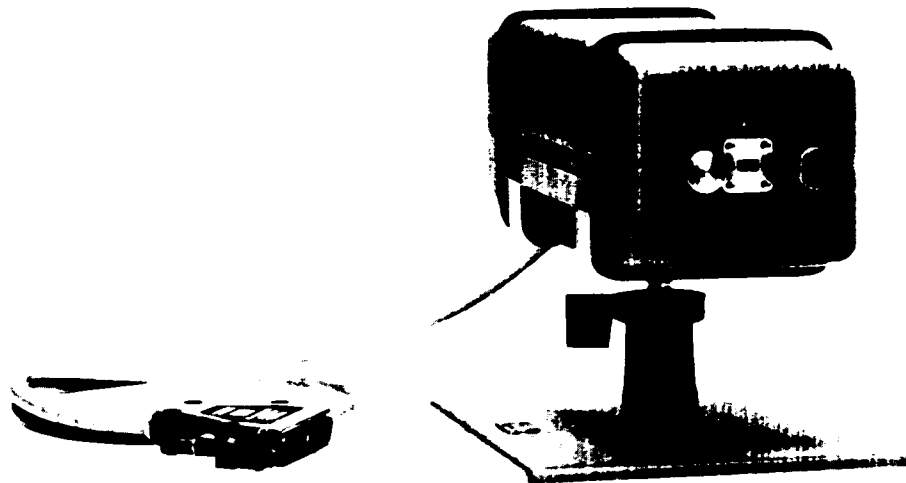

MANUAL CHANGES

NOTE

Manual change supplements are revised as often as necessary to keep manuals as current and accurate as possible. Hewlett-Packard recommends that you periodically request the latest edition of this supplement. Free copies are available from all HP offices. When requesting copies, quote the manual identification information from your supplement, or the model number and print date from the title page of the manual.

MANUAL IDENTIFICATION

HP Number: HP 83554A
Date Printed: April 1986
Part Number: 83554-90019

This supplement contains important information for correcting manual errors and for adapting the manual to instruments containing improvements made after the printing of the manual.

Two types of information are included:

UPDATES - APPLY TO ALL SERIAL NUMBERS.

NUMBERED CHANGES - UPDATES THAT ARE SERIAL NUMBER PREFIX RELATED.

The information is in the following order: UPDATES, NUMBERED CHANGES in sequential order with applicable illustrations as close as possible to each numbered change.

To use this supplement, make all UPDATES and all appropriate serial number related CHANGES indicated in the following tables.

■ indicates new item or changed material.

HP Part No. 83554-90023
MAY 17, 1988



**HEWLETT
PACKARD**

■ UPDATES

In the HP 83554A Operating and Service Manual (HP Part No. 83554-90001), update the following changes.

Replacement pages supersede the existing manual pages.

Replace the title page with the following title page in this document.

HP 83554A MILLIMETER-WAVE SOURCE MODULE

SERIAL NUMBERS

This manual applies directly to HP 83554A Millimeter-wave source modules having serial prefixes 2612A and 2636A.

For additional information about serial numbers, refer to INSTRUMENTS COVERED BY MANUAL in System General Information.

- Manual Changes Supplement Print Date: MAY 1988, Revision 3.

©Copyright HEWLETT-PACKARD COMPANY 1986
1400 FOUNTAINGROVE PARKWAY, SANTA ROSA, CA 95401 U.S.A.

MANUAL PART NO. 83554-90001
Microfiche Part Number 83554-90002

Printed: APRIL 1986



**HEWLETT
PACKARD**

SAFETY CONSIDERATIONS

GENERAL

This product and related documentation must be reviewed for familiarization with safety markings and instructions before operation. This product has been designed and tested in accordance with international standards.

SAFETY SYMBOLS



Instruction manual symbol: the product will be marked with this symbol when it is necessary for the user to refer to the instruction manual (refer to Table of Contents).



Indicates hazardous voltages.



Indicates earth (ground) terminal.

WARNING

The WARNING sign denotes a hazard. It calls attention to a procedure, practice, or the like, which, if not correctly performed or adhered to, could result in personal injury. Do not proceed beyond a WARNING sign until the indicated conditions are fully understood and met.



The CAUTION sign denotes a hazard. It calls attention to an operating procedure, practice, or the like, which, if not correctly performed or adhered to, could result in damage to or destruction of part or all of the product. Do not proceed beyond a CAUTION sign until the indicated conditions are fully understood and met.

BEFORE APPLYING POWER

Verify that the product is configured to match the available main power source per the input power configuration instructions provided in this manual.

If this product is to be energized via an auto-transformer make sure the common terminal is connected to the neutral (grounded side of the mains supply).

SERVICING

WARNING

Any servicing, adjustment, maintenance, or repair of this product must be performed only by qualified personnel.

Adjustments described in this manual may be performed with power supplied to the product while protective covers are removed. Energy available at many points may, if contacted, result in personal injury.

Capacitors inside this product may still be charged even when disconnected from their power source.

To avoid a fire hazard, only fuses with the required current rating and of the specified type (normal blow, time delay, etc.) are to be used for replacement.

UPDATES

In the HP 83550A Source System Guide (HP Part No. 83554-90004), update the following changes:

Page 1, **SYSTEM DESCRIPTION:**

Replace the sentence with the following sentence:

NOTE: With Option 002 (50 dB programmable attenuator), the HP 83550A may not drive the source module to full specified output power. Refer to the HP 83550A Operating and Service Manual for detailed specifications.

Page 2, Table 2-1 (*HP 83550A/83554A System Specifications*), **Output Characteristics:**

Change the System Harmonics specification from >30 dBc to >50 dBc.

Change the Typical specification from >35 dBc to >55 dBc.

Page 15, **SYSTEM HARMONICS, Specification:**

Change the number >30 dBc to >50 dBc.

Page 16, Figure 2-10 (*Spurious Signals Test Setup*):

Replace with Figure 2-10 in the “Updates Apply to All Serials” section for the HP 83550A Source System Guide in this document.

Page 17, **Measurement Uncertainty, Step 5:**

Change the number <30 dBc to <50 dBc.

Page 18, **Signal Identification, Step 10:**

Change the number >30 dBc to >50 dBc.

Page 18, **Signal Identification, Step 12:**

Replace the second instruction with the following instruction:

Press **DISPLAY LINE [ENTER] [4] [3] [-dBm]**, setting the 50 dBc reference.

Page 19, Table 2-2 (*Performance Test Record*):

Change the System Harmonics specification from >30 dBc to >50 dBc.

Page 23/24, Figure 2-11 (*Harmonic Check Points*):

Replace with Figure 2-11 in the “Updates Apply to All Serials” section for the HP 83550A Source System Guide in this document.

Page 23/24, **Troubleshooting System Harmonics, Step 1:**

Replace the sentence with the following sentence:

If the harmonic related spurious output from the HP 83554A is less than 50 dBc, check the harmonic output of the HP 83550A and ensure that it is greater than 50 dBc.

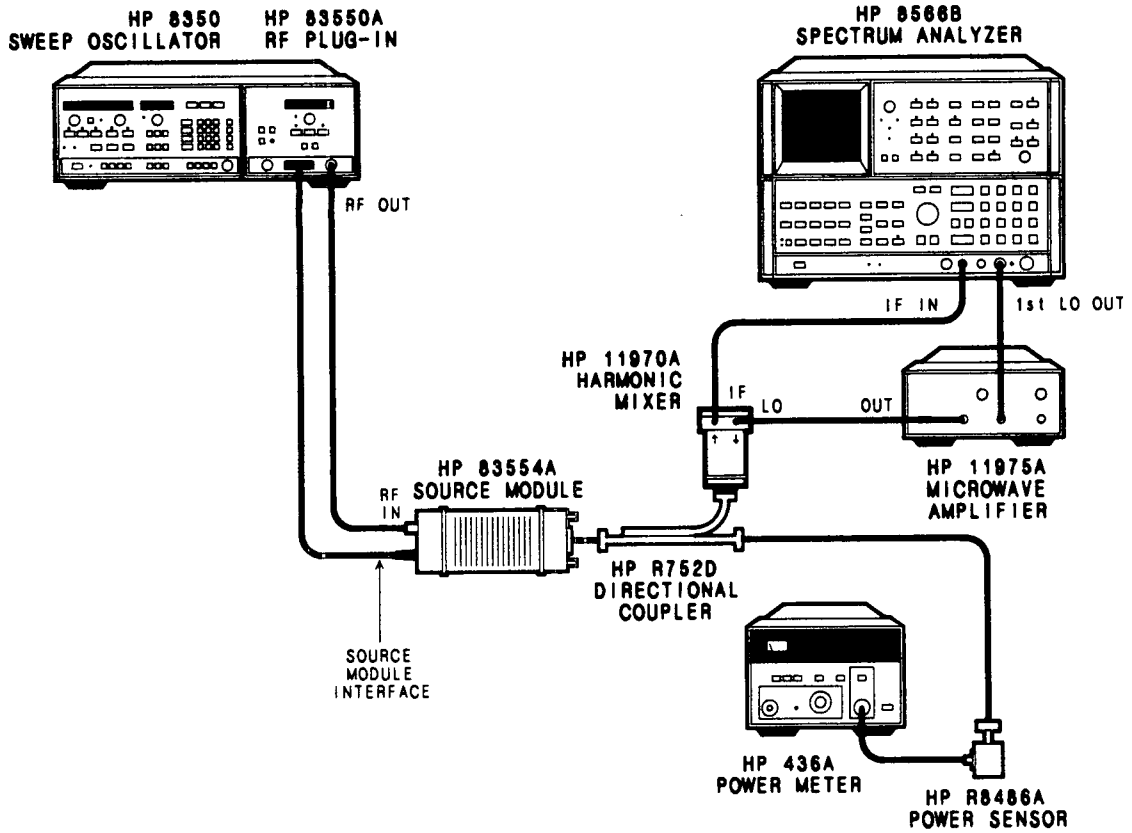

Figure 2-10. Spurious Signals Test Set-up

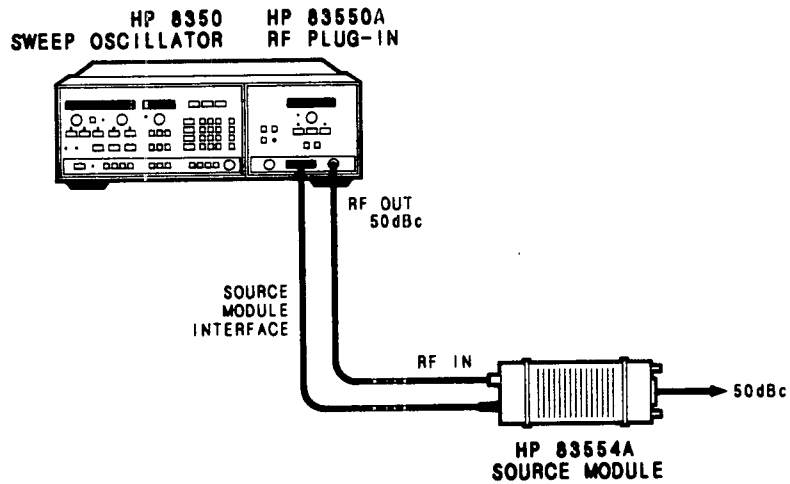

Figure 2-11. Harmonic Check Points

UPDATES

In the HP 83590 Series Source System Guide (HP Part No. 83554-90005), update the following changes:

Page 2, Table 2-1 (*HP 83590 Series/83554A System Specifications*), Footnote 3:

Change the number >30 dBc to >45 dBc.

Page 17, **SYSTEM HARMONICS, Specification:**

Change the number >30 dBc to >45 dBc.

Page 18, Figure 2-10 (*Spurious Signals Test Setup*):

Replace with Figure 2-10 in the "Updates Apply to All Serials" section for the HP 83590 Series Source System Guide in this document.

Page 21, **Measurement Uncertainty**, Step 14:

Change the number + 0.5 dB to + 2.0 dB.

Page 22, Table 2-3 (*Performance Test Record*), Footnote 2:

Change the number >30 dBc to >45 dBc.

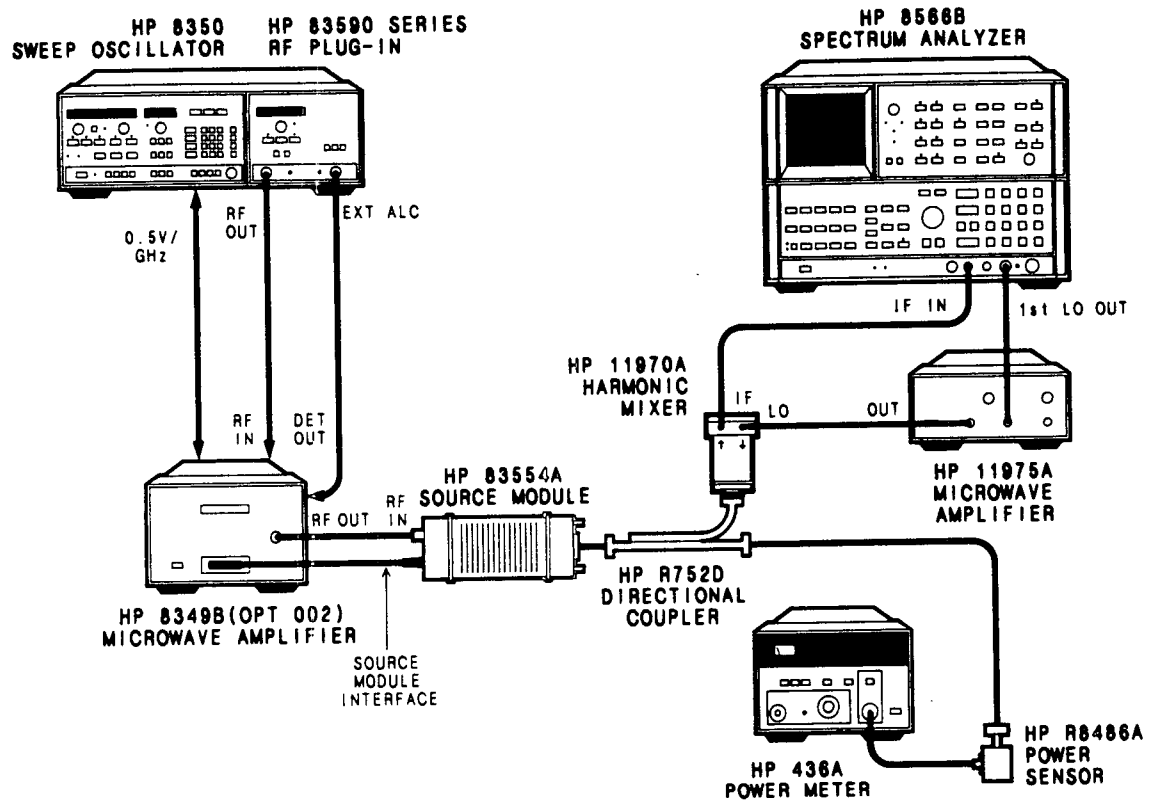

Figure 2-10. Spurious Signals Test Set-up

UPDATES

In the HP 8340A Series Source System Guide (HP Part No. 83554-90007), update the following changes:

Page 2, Table 2-1 (*HP 8340A/41A/83554A System Specifications*):

Replace with Table 2-1 (Updates Apply to All Serials) in this document.

Page 16, Figure 2-9 (*Spurious Signals Test Setup*):

Replace with Figure 2-9 in the "Updates Apply to All Serials" section for the HP 8340 Series Source System Guide in this document.

Page 19, **Measurement Uncertainty**, Step 14:

Change the number + 0.5 dBm to + 2.0 dBm.

Page 20, Table 2-3 (*Performance Test Record*):

Replace with Table 2-3 (Updates Apply to All Serials section) in this document.

Table 2-1. HP 8340A/41A/83554A System Specifications

<p>Frequency Characteristics Range 26.5 to 40.0 GHz Accuracy¹ (25°C ± 5°C) CW Mode Same as time base. Time Base² .. Internal 10 MHz time base. Aging rate: less than 1 x 10⁻⁹/day and 2 x 10⁻⁷/year after 30-day warmup. Temperature effect: <1 x 10⁻¹⁰/°C. Line Voltage Effect: <1 x 10⁻¹¹/±10%. All Sweep Modes (for sweep time >100 msec)³ $\Delta F \leq (n) 10 \text{ MHz} \dots +1\% \text{ of } \Delta F$ $\pm \text{ time base accuracy}$ $(n) 10 \text{ MHz} > \Delta F \leq 600 \text{ MHz} \dots \pm 2\% \text{ of } \Delta F$ $\Delta F \geq 600 \text{ MHz} \dots \pm 1\% \text{ of } \Delta F$ or ±100 MHz, whichever is less n = harmonic band (1-4) of the HP 8340B/41B CW Resolution 6 Hz</p> <p>Output Characteristics⁴ System Harmonics >20 dBc Typically >25 dBc</p>	<p>Modulation Characteristics External AM Bandwidth, typically DC to 30 KHz Sensitivity, typically 100%/V External Pulse Modulation Rise/Fall Time, typically 50 ns Minimum RF Pulse Width System Unleveled 100 ns On/off ratio, typically >80 dB Pulse Repetition Frequency System Unleveled ... 100 Hz to 5 MHz HP 8756A and 8757A AC Detection Mode Compatibility No</p> <p>1. Specifications referenced are source driver specific (HP 8340A/41A) and do not indicate the doubling effect of the source module. 2. Overall accuracy of internal timebase is a function of timebase calibration ± aging rate ± temperature effects ± line effects. 3. After one hour warmup at selected CW frequency. 4. For output characteristics, see Source Module Specifications and Service Section.</p>
---	--

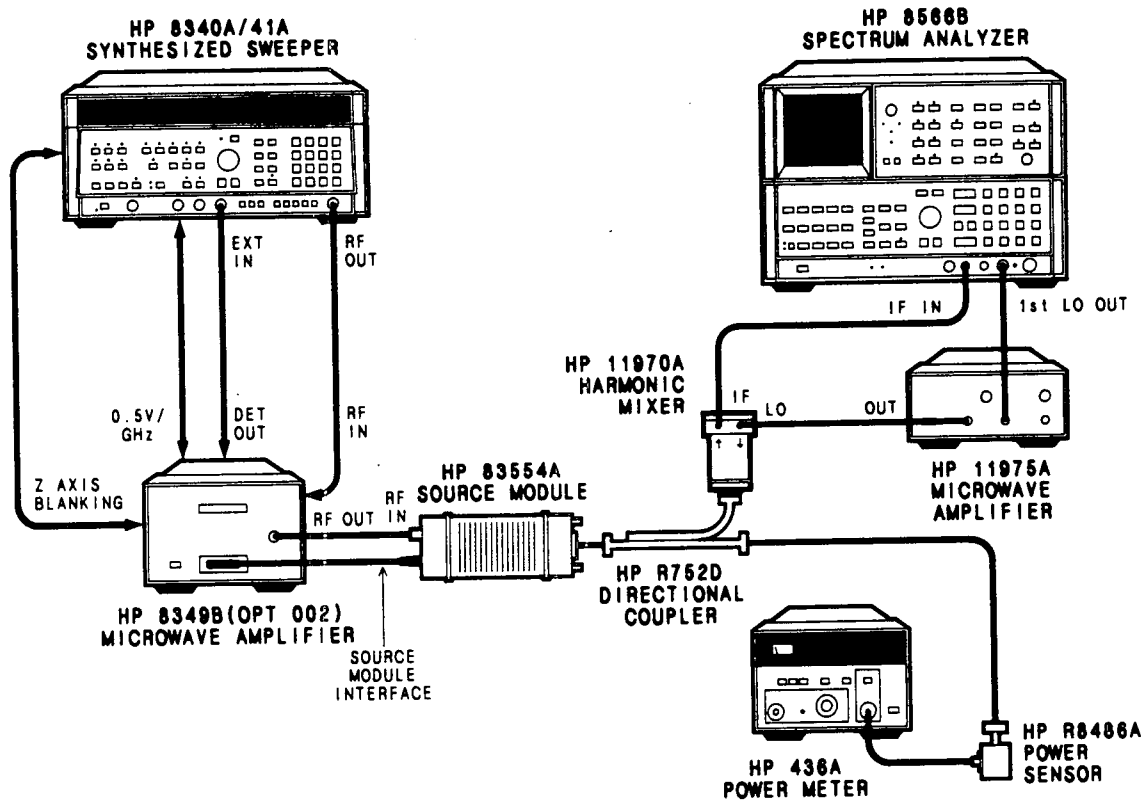

Figure 2-9. Spurious Signals Test Set-up

Table 2-3. Performance Test Record

HP 8340A/41A Series System				
Serial Number _____		Date _____		
Humidity* _____		Tested By _____		
(Optional)		Temperature _____		
Specification Tested	Test Conditions	Specification	Test Results	
			Pass	Fail
FREQUENCY Range ¹ Accuracy (25°C ± 5°C) CW Mode Time Base	_____	26.5 to 40.0 GHz ¹	_____	_____
	_____	Same as time base Internal 10 MHz time base Aging rate: less than 1 x 10 ⁻⁹ / day and 2 x 10 ⁻⁷ /year after 30-day warmup.	_____	_____
All Sweep Modes (for sweep time > 100 msec)	_____	Temperature effect < 1 x 10 ⁻¹⁰ /°C	_____	_____
	_____	Line Voltage effect < 1 x 10 ⁻¹¹ /± 10%	_____	_____
CW Resolution ¹	_____	ΔF ≤ (n) 10 MHz ± 1% of ΔF ± time base accuracy	_____	_____
	_____	(n) 10 MHz > ΔF > 600 MHz: ± 2% of ΔF ΔF ≥ 600 MHz: ± 1% of ΔF or ± 100 MHz which- ever is less n = harmonic band (1 - 4) of the HP 8340A/41A	_____	_____
OUTPUT	_____	6 Hz ¹	_____	_____
System Harmonics	_____	> 20 dBc	_____	_____

1. These specifications are referenced from the appropriate HP 8340A/41A synthesized sweeper manuals and have been multiplied by a factor of 2 because the HP 83554A is a frequency doubler.

■ UPDATES

In the **HP 8340B Series Source System guide (HP Part No. 83554-90025)**, make the following changes:

Page 2, Table 2-1 (*HP 8340B/41B System Specifications*):

Replace with Table 2-1 (Updates Apply to All Serials) in this document.

Page 17, Step 3 (System Harmonics):

Change the first key sequence to read: Press **[SH] [XTAL] EXT ALC MODE**.

Page 20, Table 2-3 (*Performance Test Record*):

Replace with Table 2-3 (Updates Apply to All Serials) in this document.

Table 2-1. HP 8340B/41B/83554A System Specifications

<p>Frequency Characteristics Range 26.5 to 40.0 GHz Accuracy¹ (25°C ± 5°C) CW Mode Same as time base. Time Base² . Internal 10 MHz time base. Aging rate: less than 1×10^{-9}/day and 2×10^{-7}/year after 30 day warmup. Temperature effect: $<1 \times 10^{-10}$/°C. Line Voltage Effect: $<1 \times 10^{-11}/\pm 10\%$. All Sweep Modes (for sweep time >100 msec)³ $\Delta F \leq (n) 10 \text{ MHz} \dots +1\% \text{ of } \Delta F$ \pm time base accuracy (n) 10 MHz $>\Delta F \leq 600 \text{ MHz} \dots \pm 2\% \text{ of } \Delta F$ $\Delta F \geq 600 \text{ MHz} \dots \pm 1\% \text{ of } \Delta F$ or $\pm 100 \text{ MHz}$, whichever is less n = harmonic band (1–4) of the HP 8340B/41B CW Resolution 6 Hz</p> <p>Output Characteristics⁴ System Harmonics >20 dBc Typically >25 dBc</p>	<p>Modulation Characteristics External FM Bandwidth 50 kHz to 10 MHz Deviation the lesser of 20 MHz or 20 x fmod from 26.5 to 27.0 GHz, 30 x fmod from 27.0 to 40.0 GHz Sensitivity 2 MHz/V or 20 MHz/V External AM Bandwidth, typically DC to 100 kHz Sensitivity, typically 100%/V External Pulse Modulation Rise/Fall Time, typically 50 ns Minimum RF Pulse Width System Leveled 1us System Unleveled 100 ns On/off ratio, typically >80 dB Pulse Repetition Frequency System Leveled .. 100 Hz to 500 kHz System Unleveled .. 100 Hz to 5 MHz HP 8756A and 8757A AC Detection Mode Compatibility .. Yes</p>
<p>1. Specifications referenced are source driver specific (HP 8340B/41B) and do not indicate the doubling effect of the source module. 2. Overall accuracy of internal timebase is a function of timebase calibration \pm aging rate \pm temperature effects \pm line effects. 3. After one hour warmup at selected CW frequency. 4. For output characteristics, see Source Module Specifications and Service Section.</p>	

Table 2-3. Performance Test Record

HP 8340B/41B Series System				
Serial Number _____		Date _____		
Humidity* _____		Tested By _____		
(Optional)		Temperature _____		
Specification Tested	Test Conditions	Specification	Test Results	
			Pass	Fail
FREQUENCY				
Range ¹		26.5 to 40.0 GHz ¹		
Accuracy (25°C ± 5°C)		Same as time base		
CW Mode		Internal 10 MHz time base		
Time Base		Aging rate: less than 1 x 10 ⁻⁹ /day and 2 x 10 ⁻⁷ /year after 30-day warmup.		
		Temperature effect < 1 x 10 ⁻¹⁰ /°C		
		Line Voltage effect < 1 x 10 ⁻¹¹ /± 10%		
All Sweep Modes (for sweep time > 100 msec)		ΔF ≤ (n) 10 MHz ± 1% of ΔF ± time base accuracy		
		(n) 10 MHz > ΔF ≤ 600 MHz: ± 2% of ΔF		
		ΔF ≥ 600 MHz: ± 1% of ΔF or ± 100 MHz whichever is less.		
		n = harmonic band (1-4) of the HP 8340B/41B		
CW Resolution ¹		6 Hz ¹		
MODULATION				
External FM				
Bandwidth		50 kHz to 10 MHz		
Deviation		the lesser of 20 MHz or 20 x fmod from 26.5 to 27.0 GHz, 30 x fmod from 27.0 to 40.0 GHz		
Sensitivity		2 MHz/V or 20 MHz/V		
OUTPUT				
System Harmonics		> 20 dBc		

1. These specifications are referenced from the appropriate HP 8340B/41B synthesized sweeper manuals and have been multiplied by a factor of 2 because the HP 83554A is a frequency doubler.

UPDATES

In the HP 8670 Series Source System Guide (HP Part No. 83554-90008), update the following changes:

Page 2, Table 2-1 (*8673B/C/D/83554A System Specifications*), **Output Characteristics:**

Change the System Harmonic specification from < -20 dBc to > 20 dBc.

Change the Typical specification from < -25 dBc to > 25 dBc.

Page 2, Table 2-1 (*8673B/C/D/83554A System Specifications*), **Modulation Characteristics:**

Change the External Pulse Modulation Rise/Fall Time typical specification from 25 ns to 50 ns.

Page 2, Table 2-1 (*8673B/C/D/83554A System Specifications*), Footnote 6:

Change the number > 30 dBc to > 50 dBc.

Page 15, **SYSTEM HARMONICS, Specification:**

Change the number > 30 dBc to > 50 dBc.

Page 16, Figure 2-9 (*Spurious Signals Test Setup*)

Replace with Figure 2-9 in the "Updates Apply to All Serials" section of the HP 8670 Series Source System Guide in this document.

Page 20, Table 2-4 (*Performance Test Record*), Footnote 3:

Change the number > 30 dBc to > 50 dBc.

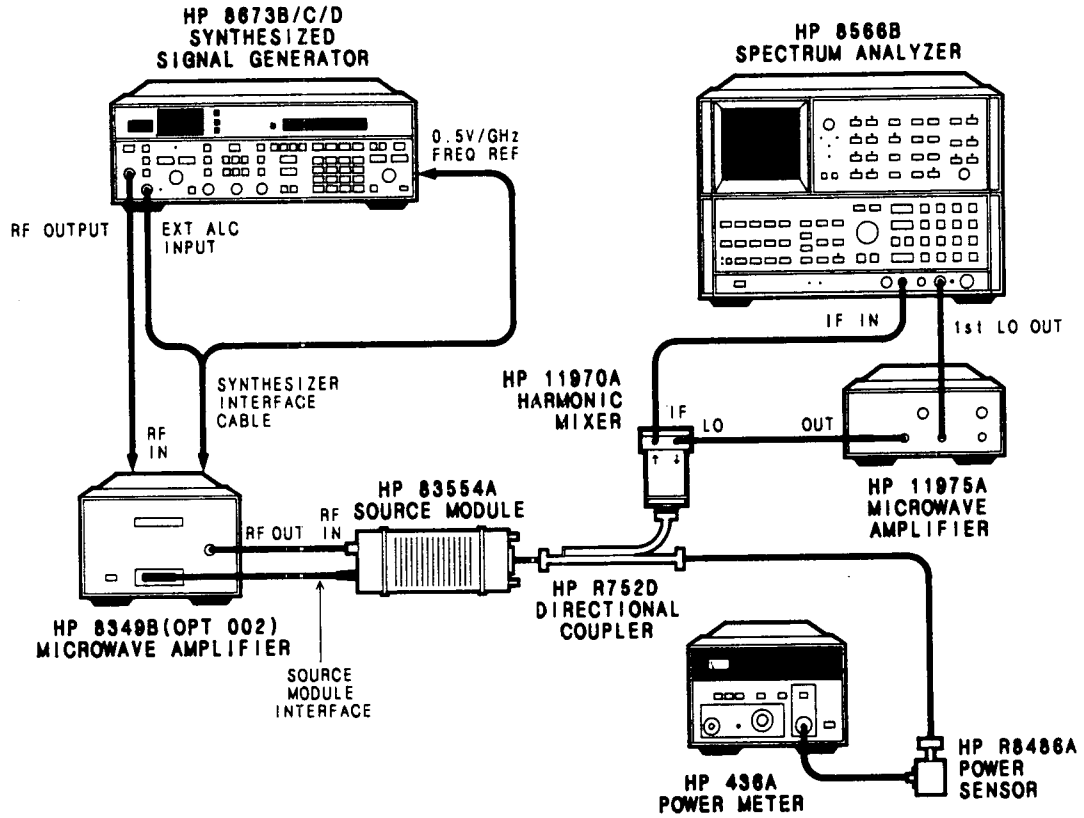

Figure 2-9. Spurious Signals Test Set-up

UPDATES

In the Specifications and Service Section (HP Part Number 83554-90001), update the following changes:

Replacement pages supersede the existing manual pages. Replace the following pages with the replacement pages given in this document:

Page 1, 2

Page 17, 18

Page 19, 20

Page 21, 22

Page 25, 26

■ Page 29/30

Source Module Specifications and Service

INTRODUCTION

This section contains information that is specific to the HP 83554A source module: instrument specifications, theory of operation, procedures for performance tests, procedures for troubleshooting, and a replaceable parts list. For detailed instructions regarding the operation or troubleshooting of an individual instrument other than the source module, refer to that particular instrument's operating and service manual.

SPECIFICATIONS

Source module specifications are divided into two categories:

- Source driver dependent specifications (system specifications).
- Source module specifications independent of signal source.

Because the HP 83554A source module uses frequency multiplication to generate millimeter-wave frequencies, source module frequency specifications are directly proportional to those of the external signal source driving the source module. The specifications that are an extension of the external signal source are detailed in the Source System Guide (Table 2-1) for that particular source system configuration.

Specifications for the source module that are independent of the source driver are listed in Table 3-1 of this section. These performance standards together with the performance standards listed in the Source System Guide that describes the system you are using, are the limits against which the instrument can be tested.

If source system conformance to specifications is required, BOTH (source system and source module) sets of performance tests must be performed to completely verify instrument conformance to the specifications.

Table 3-1. Specifications of the HP 83554A Source Module (Independent)

Model Number	HP 8350, HP 83550A	HP 8350, 83590 Series, HP 8349B	HP 8340A/40B, HP 8349B HP 8341A/41B, HP 8349B	HP 8673B/C/D, HP 8349B
Frequency Characteristics Range	26.5 to 40.0 GHz	26.5 to 40.0 GHz	26.5 to 40.0 GHz	26.5 to 40.0 GHz (8673B/D) 26.5 to 37.2 GHz (8673C)
Output Characteristics (25°C ± 5°C) Maximum Leveled Power	+ 8 dBm, 26.5 to 37.2 GHz + 7 dBm, 37.2 to 40.0 GHz	+ 8 dBm, 26.5 to 37.2 GHz + 7 dBm, 37.2 to 40.0 GHz	+ 8 dBm, 26.5 to 37.2 GHz + 7 dBm, 37.2 to 40.0 GHz	+ 8 dBm, 26.5 to 40.0 GHz + 7 dBm, 37.2 to 40.0 GHz
Minimum Settable Power	- 5 dBm	- 5 dBm	- 5 dBm	- 5 dBm
Power Level Accuracy (25°C ± 5°C) System Leveled	± 2.00 dB	± 2.00 dB	± 2.00 dB	± 2.00 dB ¹
Power Flatness (at max leveled power) System Leveled	± 1.50 dB	± 1.50 dB ²	± 1.50 dB ²	± 1.50 dB ²
Source Input SWR System unleveled Typically	<7.0	<7.0	<7.0	<7.0
Source Output SWR System Leveled System Unleveled Typically	<2.0 <3.0	<2.0 <3.0	<2.0 <3.0	<2.0 <3.0
Spectral Purity Specifications Spurious Signals expressed in dB relative to the carrier level (dBc). 26.5 to 27.0 GHz 27.0 to 40.0 GHz	> 25 dBc > 50 dBc	> 25 dBc > 20 dBc ³	> 25 dBc > 20 dBc ⁵	> 25 dBc > 20 dBc ⁴
General Specifications Input frequencies: 13.25 to 20.00 GHz Minimum input power level into HP 83554A RF input cable: + 17 dBm (50mW) Maximum input power level into HP 83554A RF input cable: + 27 dBm (500 mW) Waveguide output connector: EIA size WR 28 waveguide. Mates with JAN UG-599 flange. Weight: Net, 1.7 kg (4 lb.). Furnished with each HP 83554A: Operating and Service Manual, RF cable (also available as HP Part No. 5061-5359), Module Base Assembly (also available as HP Part No. 83556-60010).	Dimensions: 			
<ol style="list-style-type: none"> When remotely programmed; when power is referenced to front panel add ± 0.75 dB Must have 0.5 V/GHz modification. With the exception of the HP 83592C which is > 45 dBc. With the exception of the HP 8673C/D which is > 50 dBc. With the exception of the HP 8340B/41B option 003 which is > 40 dBc. 				

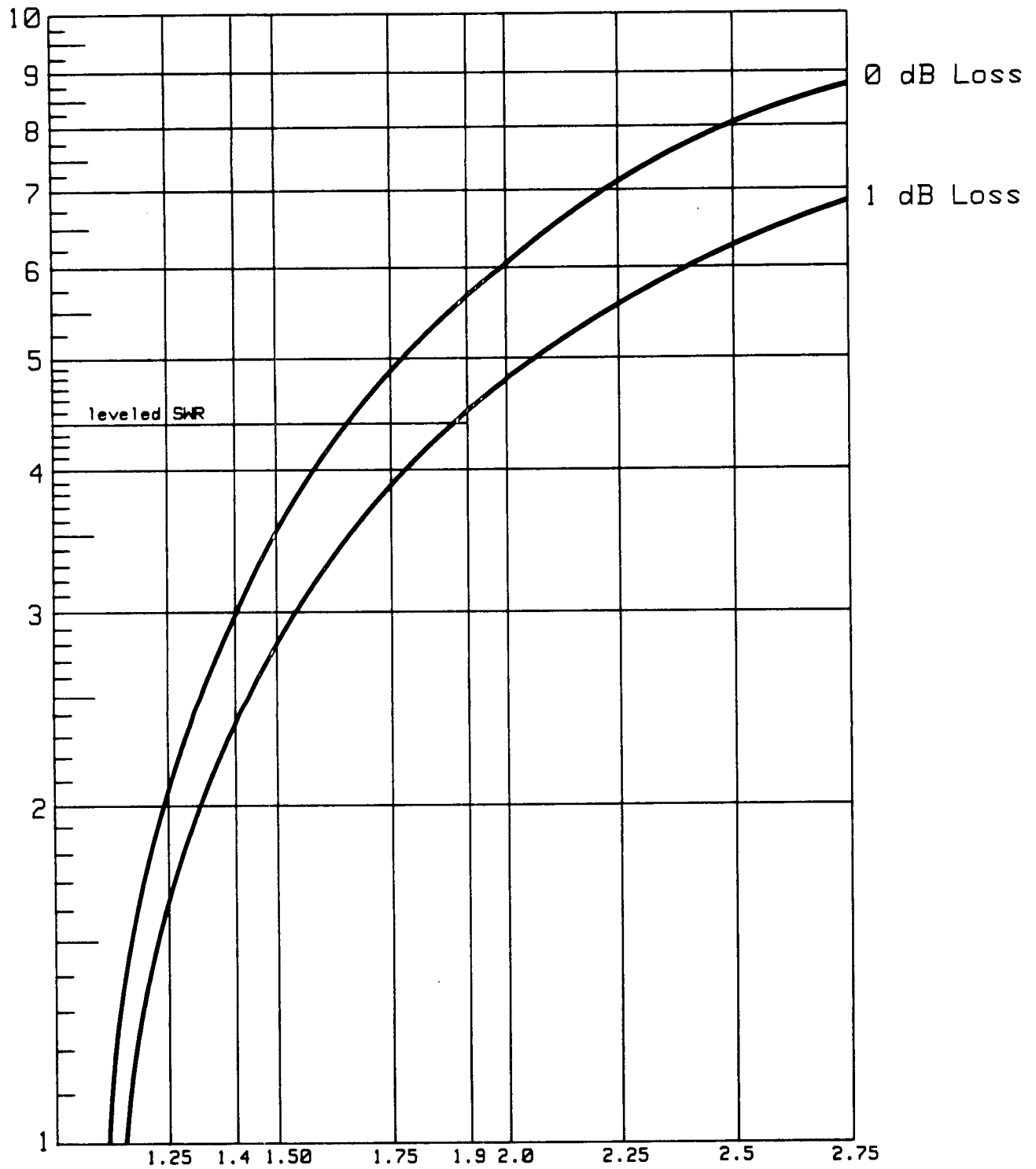

Figure 3-6. Conversion Chart

MULTIPLIER HARMONIC TEST (26.5 to 27.0 GHz)

Specification

Harmonic Related > 25 dBc

Description

The following procedure addresses the 3/2 multiplier harmonic response. The location of the 3/2 harmonic can be calculated by using the equation in the procedure of this test. For any CW output signal between 26.5 and 27.0 GHz from the HP 83554A mm-wave source module, an accompanying 3/2 harmonic response may be present within the R-band frequency band.

The RF output signal from the source module is tuned from 26.5 to 27.0 GHz and 3/2 harmonics are displayed on a spectrum analyzer to verify that any harmonic spurious signals are at or below their specified levels. The test configuration in Figure 3-7 uses an external harmonic mixer to extend the frequency range of the spectrum analyzer. When this technique is used, the response is not pre-selected and multiple signals are displayed. Each response is examined not only for power level, but whether or not the signal is truly in band by using the spectrum analyzer's signal identification function.

Equipment

Source Driver	Any source in Figure 3 of System General Information
Spectrum Analyzer	HP 8566B
Waveguide Coupler	HP R752D
Harmonic Mixer	HP 11970A
RF Cables (3)	HP Part No. 5061-5458
Microwave Amplifier	HP 11975A
Power Meter	HP 436A
Power Sensor	HP R8486A

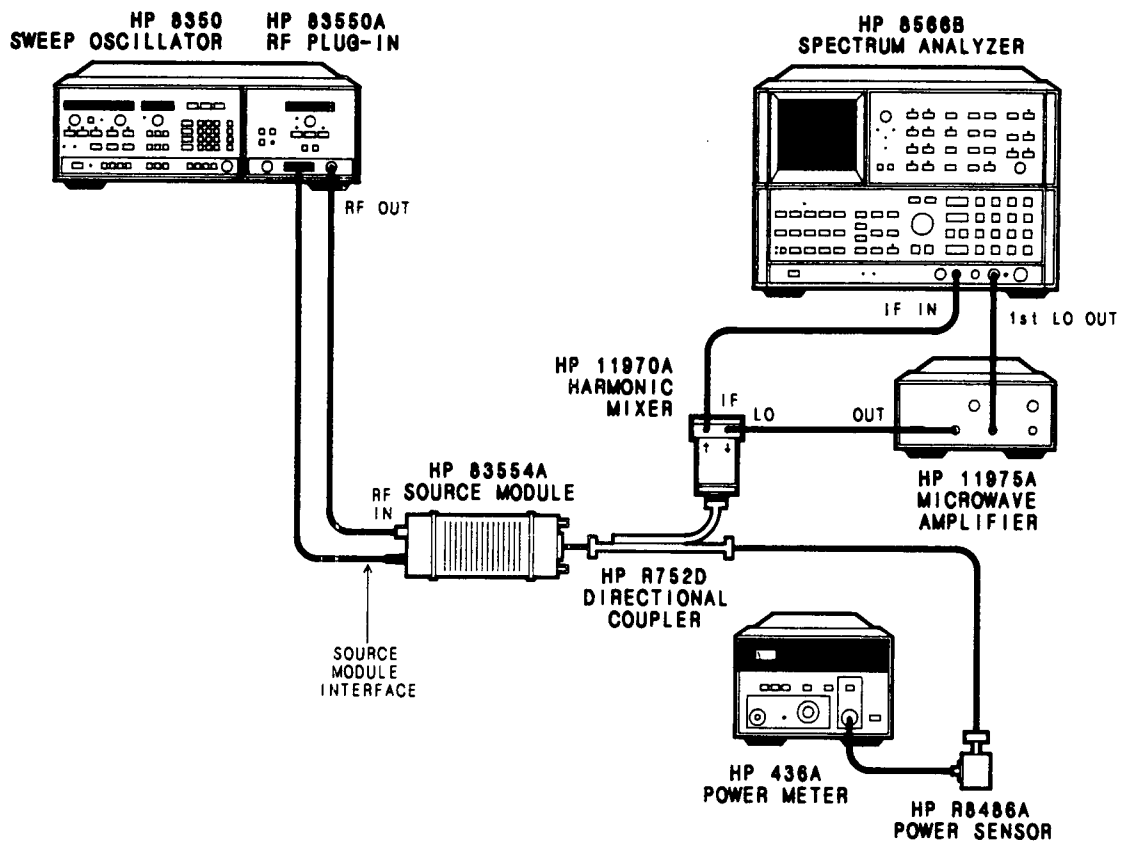

Figure 3-7. Multiplier 3/2 Harmonic Signals Typical Test Setup

Procedure

1. Connect the equipment as shown in Figure 3-7. Turn on all system components.

Multiplier Harmonic Signals

The 3/2 multiplier harmonic signals are determined from the calculation below.

Fundamental Frequencies	Harmonics
$F_2 = 26.5 \text{ to } 27 \text{ GHz}$	$3/2 \times F_2$

2. On the source driver set up a CW frequency of 26.5 GHz. Select the external leveling mode and set the power for +8.0 dBm.
3. Measure the source module output power with the power meter to ensure the power is +8.0 dBm.

4. On the HP 8566B:

Press **[INSTR PRESET]**

Press **[SHIFT] [▲] [▲]** until the **FULL BAND K (A)** annotation appears. This places the analyzer into an external mixing mode allowing R-band frequency range capability. Note the start/stop frequency at the bottom of the screen and ensure that the start frequency is 26.5 GHz and the stop frequency is 40.0 GHz.

Press **[REF LEVEL] [8] [.] [0] [+dBm]**

Press **DISPLAY LINE [ENTER] [1] [7] [-dBm]**, for setting the 25 dBc reference.

Amplitude Calibration of the HP 8566B

The HP 8566B spectrum analyzer can make amplitude calibrated measurements of millimeter-wave frequencies when configured with the HP 11970 mixers. A calibration graph that shows conversion loss and reference level offset is provided with each mixer so that the analyzer can be corrected to that mixer. The following explanation illustrates how this offset is entered into the spectrum analyzer.

In the external mixing mode, the HP 8566B gain is automatically set to 30 dB to compensate for the conversion loss of an external mixer. Using the information from the graph supplied with the mixer, you can offset the reference level to obtain precise amplitude calibration for point by point frequency measurements.

If more general measurements are required, averaging the conversion loss graph on the HP 11970 can be accomplished by averaging the graph's maximum and minimum power points resulting in an overall conversion loss for the entire band. By using this method, an increase of measurement uncertainty is introduced into the test. Reference level offset is determined by the following equation:

$$\text{Conversion Loss} - 30 \text{ dB} = \text{Reference Level Offset}$$

Because the test configuration in Figure 3-7 specifies that the external mixer be connected to the coupled arm of a 20 dB directional coupler, the coupled power must also be taken into account when calculating reference level offset. The new equation is as follows:

$$\text{Conversion Loss} + \text{Coupled Power (20 dB)} - 30 \text{ dB} = \text{Reference Level Offset}$$

For example, if the calibration table on the external mixer indicates a conversion loss of 22 dB for a frequency of 26.5 GHz and a 20 dB directional coupler is used, then the reference level offset is calculated below:

$$\begin{aligned} \text{Conversion Loss} + \text{Coupled Power (20 dB)} - 30 &= \text{Reference Level Offset} \\ 22 \text{ dB} + 20 \text{ dB} - 30 &= +12 \text{ dB} \end{aligned}$$

Enter this reference level offset by pressing:

[SHIFT] [REF LEVEL] [1] [2] [+dBm]

Note that the left hand side of the display will read:

CNVLOSS
42.0
dB

5. On the source driver:

Manually tune the source driver frequency from 26.5 to 27.0 GHz while watching for 3/2 harmonic responses (39.75 – 40.5 GHz) that are higher than the display line (< 25 dBc) on the HP 8566B display.

Signal Identification

6. If a multiplier harmonic signal is found, verify whether or not it is a true in band-signal by using the spectrum analyzer's signal identification feature. This is performed as follows:
7. Tune the signal under observation to center screen on the HP 8566B display.
8. Press **[SHIFT] [FREE RUN]**.
9. If the signal is a false response, the annotation **IDENTIFIED OUT OF BAND** will appear on the display.
10. Ensure that all multiplier harmonic signals observed are within the specified level of > 25 dBc.

Measurement Uncertainty

Measurement uncertainty within the test configuration will affect the accuracy of this performance test. To obtain optimum accuracy, amplitude calibrate the spectrum analyzer by entering the conversion loss at each frequency signal under observation as explained under **Amplitude Calibration of the HP 8566B**. Any multiplier harmonic signals that are close to or at 30 dBc should be given an allowable margin of ± 1.5 dB to compensate for all other measurement uncertainties within the test configuration.

HARMONIC SPURIOUS TEST (27.0 to 40.0 GHz)

Specification

See Table 3-1.

Description

The following procedure uses two tone measurement techniques to test the HP 83554A's spurious harmonic response. The test combines two independently controlled sources to simulate the output products of a source that utilizes harmonics to generate output frequencies such as the HP 83590 Series RF plug-in. The two sources used in this performance test that simulate such a source are listed below:

HP 83550A (source #1)

HP 83590 Series (source #2) (except the 83592C)

Source # 1

The purpose of source #1 is to provide a clean, harmonic free, fundamental signal to the input of the HP 83554A under test. Since this source produces a frequency range of 8 to 20 GHz with only a fundamental oscillator, it is free of unwanted sub harmonic products for the 13.25 to 20 GHz frequency range.

Source # 2

The purpose of source # 2 is to produce a controlled 15 dBc or 35 dBc harmonic spurious signal (depending on the spurious signal under test) for any fundamental output frequency of the HP 83550A (source #1). This, in effect, allows the operator to simulate a worst case harmonic signal level to the input of the HP 83554A for any CW fundamental frequency he desires from source #1.

To better understand how the harmonics are created, a basic understanding of a harmonic generated source such as the HP 83590 Series RF plug-in is needed.

RF sources such as the HP 83590 Series produce output frequencies from 2 to 20 GHz in three separate bands. A YIG oscillator is used as the tunable RF frequency source of all bands. The YIG oscillator's fundamental frequency is used in Band 1 (2.0 to 7.0 GHz) and a YIG Tuned Multiplier (YTM) is used to multiply the YIG oscillator frequency for Bands 2 and 3 (7.0 to 13.5 GHz and 13.5 to 20.0 GHz respectively).

This test simulates all the harmonic characteristics associated with the HP 83590 Series RF plug-ins and HP 8349B amplifier. By simulating a worst case harmonic level at the input of the HP 83554A, the output harmonic level of the HP 83554A can be analyzed to ensure it is within the specified level of > 20 dBc. Because the HP 83554A is source driven, its output contains not only its fundamental frequency but also the source driver's harmonic related products as well. The following procedure tests for these responses and explains further how these products are related and in what ways they interact with one another.

The operating input frequencies of the HP 83554A are 13.25 to 20 GHz, so the HP 83590 Series RF plug-in operates within Bands 2 and 3, therefore using the 2nd and 3rd harmonics of the fundamental. The RF plug-in's fundamental frequency (f_0) as well as its multiples ($2f_0$, and $3f_0$) can mix in several ways within the HP 83554A to create in-band spurious harmonic responses.

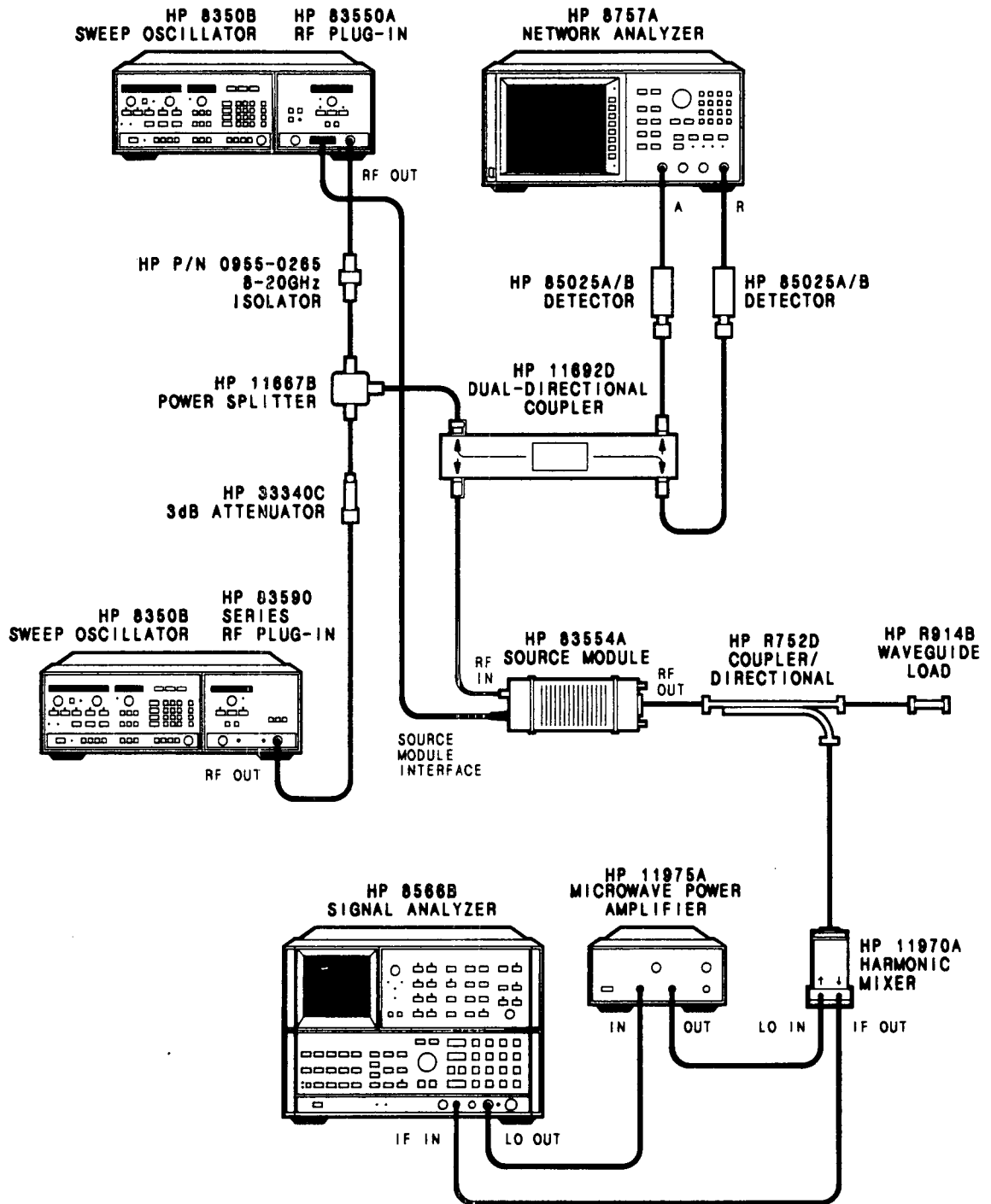

Figure 3-8. Harmonics Spurious Test Setup

1. Connect the equipment as shown in in Figure 3-8.

Turn on all system components except for source #2.

2. Source #1:

On the HP 8350:

Tune the sweeper for a 13.25 GHz CW output signal.

On the HP 83550A:

Tune the RF plug-in for an INT leveled output power of 8.0 dBm on the HP 83550A display.

3. On the HP 8757A:

Normalize the inputs and note the signal level from source #1.

4. Turn source #1 off.

5. Turn source #2 on.

6. On source # 2:

Since the input frequency to the HP 83554A is 13.25 GHz (band 2 of the HP 83590 Series plug-in), the YIG fundamental frequency (fo) of an HP 83590 Series RF plug-in is 6.625 GHz and 3fo is 19.875 GHz.

On the HP 8350:

Tune the sweeper for an fo frequency of 6.625 GHz CW output frequency.

On the RF plug-in:

Press **[POWER LEVEL]**

While observing the HP 8757A display, adjust the power level rotary knob for a power level that is 15 dB less than the power level noted in step 3.

To simulate 3fo: repeat step 6 using a power level of 35 dB less than the power level noted in step 3.

7. Turn on source # 1.

8. On the HP 8566B:

Press **[INSTR PRESET]**

Press **[SHIFT] [▲] [▲]** until the **FULL BAND K (A)** annotation appears. This places the analyzer into an external mixing mode allowing R-band frequency range capability. Note the start/stop frequency at the bottom of the screen and ensure that the start frequency is 26.5 GHz and the stop frequency is 40.0 GHz.

Press **[REF LEVEL] [8] [.] [0] [+dBm]**

Press **DISPLAY LINE [ENTER] [1] [2] [-dBm]**

This sets a 20 dBc reference line.

Table 3-4. Performance Test Record

HP 83554A Millimeter-Wave Source Module Serial Number _____ Date _____ Humidity* _____ Tested By _____ *(Optional) Temperature* _____			
Specification Tested Limits	Lower Limit	Measured Value	Upper Limit
Maximum Leveled Power 26.5 to 37.2 GHz 37.2 to 40.0 GHz	+8.0 dBm +7.0 dBm	_____ _____	
Power Level Flatness² 26.5 to 37.2 GHz, Displayed Power +8 dBm 26.5 to 40.0 GHz, Displayed Power +7 dBm		_____ _____	3 dB p-p 3 dB p-p
Power Level Accuracy¹ Displayed Power +7 dBm Displayed Power +4 dBm Displayed Power +1 dBm Displayed Power -2 dBm Displayed Power -5 dBm	$\geq +5.00$ dBm $\geq +2.00$ dBm ≥ -1.00 dBm ≥ -4.00 dBm ≥ -7.00 dBm	Min/Max _____/_____ _____/_____ _____/_____ _____/_____ _____/_____	$\leq +9.00$ dBm $\leq +6.00$ dBm $\leq +3.00$ dBm ≤ 0.00 dBm < -3.00 dBm
Output SWR		_____	≤ 2.0
Multiplier Harmonic Test 26.5 to 26.7 GHz	≥ 25 dBc	_____	
Harmonic Spurious Test³ 26.5 to 40 GHz	> 20 dBc ³	_____	

1. HP 8673 only; when remotely programmed; when power is referenced to front panel add ± 0.75 dB.
2. Must have 0.5 V/GHz modification.
3. With the exception of the HP 83592C which is > 45 dBc, the HP 8340B/41B Option 003 which is > 40 dBc, and the HP 83550A and HP 8673C/D which are > 50 dBc.

CHANGE 1

This change implements a redesigned Board Assembly-Interface.

In the Source Module Specifications and Service Section (HP Part Number 83554-90001), make the following change:

Page 49, Figure 3-12:

Change Item 5 to HP Part Number 83554-60031, CD 2.

HP 83554A SOURCE MODULE

For use with
HP 8340B Series
HP 8349B

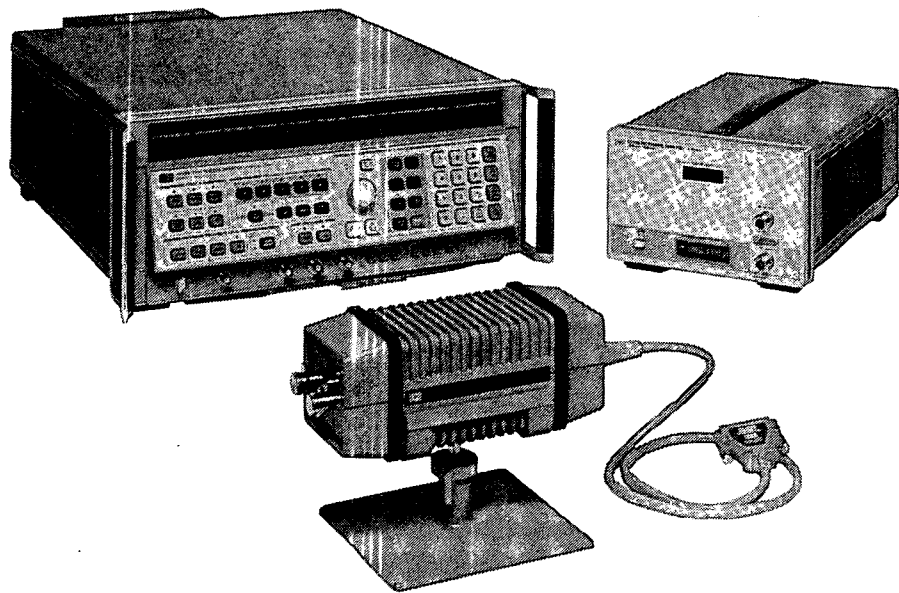

CERTIFICATION

Hewlett-Packard Company certifies that this product met its published specifications at the time of shipment from the factory. Hewlett-Packard further certifies that its calibration measurements are traceable to the United States National Institute of Standards and Technology (NIST, formerly NBS), to the extent allowed by the Bureau's calibration facility, and to the calibration facilities of other International Standards Organization members.

WARRANTY

This Hewlett-Packard system product is warranted against defects in materials and workmanship for a period corresponding to the individual warranty periods of its component products. Computer and computer peripherals are warranted for a period of 90 days. Instruments are warranted for a period of one year. During the warranty period, Hewlett-Packard Company will, at its option, either repair or replace products which prove to be defective.

Warranty service for products installed by HP and certain other products designated by HP will be performed at Buyer's facility at no charge within HP service travel areas. Outside HP service travel areas, warranty service will be performed at Buyer's facility only upon HP's prior agreement and Buyer shall pay HP's round trip travel expenses. In all other areas, products must be returned to a service facility designated by HP.

For products returned to HP for warranty service, Buyer shall prepay shipping charges to HP and HP shall pay shipping charges to return the product to Buyer. However, Buyer shall pay all shipping charges, duties, and taxes for products returned to HP from another country.

HP warrants that its software and firmware designated by HP for use with an instrument will execute its programming instructions when properly installed on that instrument. HP does not warrant that the operation of the instrument, or software, or firmware will be uninterrupted or error free.

LIMITATION OF WARRANTY

The foregoing warranty shall not apply to defects resulting from improper or inadequate maintenance by Buyer, Buyer-supplied software or interfacing, unauthorized modification or misuse, operation outside of the environmental specifications for the product, or improper site preparation or maintenance.

NO OTHER WARRANTY IS EXPRESSED OR IMPLIED. HP SPECIFICALLY DISCLAIMS THE IMPLIED WARRANTIES OR MERCHANTABILITY AND FITNESS FOR A PARTICULAR PURPOSE.

EXCLUSIVE REMEDIES

THE REMEDIES PROVIDED HEREIN ARE BUYER'S SOLE AND EXCLUSIVE REMEDIES. HP SHALL NOT BE LIABLE FOR ANY DIRECT, INDIRECT, SPECIAL, INCIDENTAL, OR CONSEQUENTIAL DAMAGES, WHETHER BASED ON CONTRACT, TORT, OR ANY OTHER LEGAL THEORY.

ASSISTANCE

Product maintenance agreements and other customer assistance agreements are available for Hewlett-Packard products.

For any assistance, contact your nearest Hewlett-Packard Sales and Service Office. Addresses are provided at the back of this manual.

**HP 83554A
MILLIMETER-WAVE
SOURCE MODULE**

**For use with
HP 8340B Series
HP 8349B**

SERIAL NUMBERS

This manual applies directly to HP 83554A Millimeter-wave source modules having serial prefix 2612A.

For additional information about serial numbers, refer to INSTRUMENTS COVERED BY MANUAL in System General Information.

©Copyright HEWLETT-PACKARD COMPANY 1986
1400 FOUNTAINGROVE PARKWAY, SANTA ROSA, CA 95401 U.S.A.

MANUAL PART NO. 83554-90025
Microfiche Part Number 83554-90026

Printed: AUGUST 1986



**HEWLETT
PACKARD**

TABLE of CONTENTS
HP 8340B/41B SERIES SOURCE SYSTEM GUIDE

Introduction
System Specifications
Operation
Operator's Check
System Performance Tests
 Introduction
 Frequency Characteristics
 System Harmonics
Troubleshooting

HP 8340B/41B Series Source System Guide

INTRODUCTION

This source system guide is intended to provide you with mm-wave system operating information for the HP 8340B/41B Series synthesizers. It contains an operator's check, connection diagrams, system specifications, system performance tests, and system level troubleshooting. For detailed instructions regarding the operation or troubleshooting of the individual instruments, refer to the instrument's operating and service manual.

SYSTEM DESCRIPTION

The HP 8340B (10 MHz to 26.5 GHz) and 8341B (10 MHz to 20 GHz) synthesized sweepers (unless otherwise stated will be hereafter referred to as the HP 8340B/41B) operate over the frequency range required by the HP 83554A millimeter-wave source module.

The HP 8340B/41B synthesized sweeper combines with an HP 8349B microwave amplifier (with the built-in source module interface) to deliver the required 13.25 to 20 GHz input frequency and >20 dBm of output power for driving the HP 83554A source module.

NOTE: The HP 8340B/41B synthesized sweepers require a synthesizer interface cable for operation in a mm-wave system. The cable is available as HP Part No. 5061-5391.

WARNING

This equipment is capable of radiating millimeter-wave energy from the end of unterminated waveguide. Do not look directly into the open end of any waveguide when it is connected to a source of millimeter-wave energy.

Take precautions consistent with ANSI C95.1 - 1982, a study performed by the American National Standards Institute that sets limits for human exposure to microwave and millimeter-wave energy. Copies of this publication are available from:

American National Standards Institute
1430 Broadway
New York, N. Y. 10018

SYSTEM SPECIFICATIONS

Table 2-1 provides specifications for the HP 8340B/41B synthesized sweeper/83554A system configuration. These are the performance standards against which the system is tested.

Table 2-1. HP 8340B/41B/83554A System Specifications

<p>Frequency Characteristics</p> <p>Range 26.5 to 40.0 GHz</p> <p>Accuracy¹ (25°C ± 5°C)</p> <p> CW Mode Same as time base.</p> <p> Time Base² . Internal 10 MHz time base.</p> <p> Aging rate: less than 1×10^{-9}/day and 2×10^{-7}/year after 30 day warmup.</p> <p> Temperature effect: $<1 \times 10^{-10}/^{\circ}\text{C}$.</p> <p> Line Voltage Effect: $<1 \times 10^{-11}/\pm 10\%$.</p> <p>All Sweep Modes</p> <p>(for sweep time > 100 msec)³</p> <p> $\Delta F \leq (n) 10 \text{ MHz} \dots +1\% \text{ of } \Delta F$ \pm time base accuracy</p> <p>(n) 10 MHz $>\Delta F \leq 600 \text{ MHz} \dots \pm 2\% \text{ of } \Delta F$</p> <p> $\Delta F \geq 600 \text{ MHz} \dots \pm 1\% \text{ of } \Delta F$ or $\pm 100 \text{ MHz}$, whichever is less</p> <p> n = harmonic band (1-4) of the HP 8340B/41B</p> <p>CW Resolution 6 Hz</p> <p>Output Characteristics⁴</p> <p>System Harmonics >20 dBc</p> <p>Typically >25 dBc</p>	<p>Modulation Characteristics</p> <p>External FM</p> <p> Bandwidth 50 kHz to 10 MHz</p> <p> Deviation the lesser of 20 MHz or 20 x fmod from 26.5 to 27.0 GHz, 30 x fmod from 27.0 to 40.0 GHz</p> <p> Sensitivity 2 MHz/V or 20 MHz/V</p> <p>External AM</p> <p> Bandwidth, typically DC to 100 kHz</p> <p> Sensitivity, typically 100%/V</p> <p>External Pulse Modulation</p> <p> Rise/Fall Time, typically 50 ns</p> <p> Minimum RF Pulse Width</p> <p> System Leveled 1us</p> <p> System Unleveled 100 ns</p> <p> On/off ratio, typically >80 dB</p> <p> Pulse Repetition Frequency</p> <p> System Leveled .. 100 Hz to 500 kHz</p> <p> System Unleveled .. 100 Hz to 5 MHz</p> <p>HP 8756A and 8757A</p> <p> AC Detection Mode Compatibility .. Yes</p>
<p>1. Specifications referenced are source driver specific (HP 8340B/41B) and do not indicate the doubling effect of the source module.</p> <p>2. Overall accuracy of internal timebase is a function of timebase calibration \pm aging rate \pm temperature effects \pm line effects.</p> <p>3. After one hour warmup at selected CW frequency.</p> <p>4. For output characteristics, see Source Module Specifications and Service Section.</p>	

OPERATION

INTRODUCTION

This section is intended for operator's familiar with the HP 8340B/41B instruments. If you are unfamiliar with this system, refer to the Operator's check at the end of this section for more specific instructions.

In the operation instructions, any instrument setting or function key is defined by [] symbols around it.

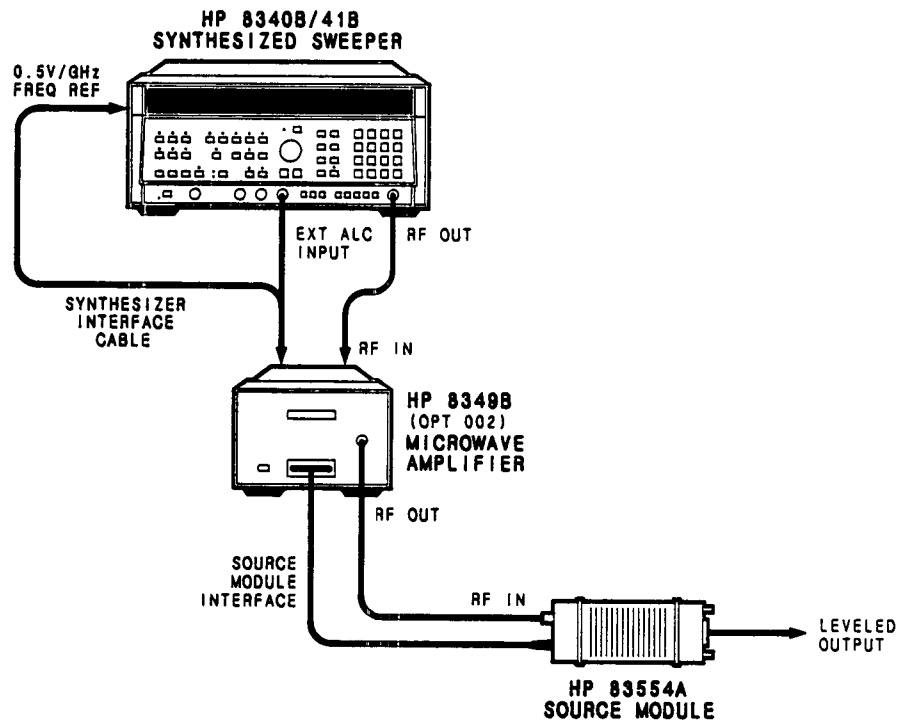

Figure 2-1. HP 8340B/41B/83554A Source System Configuration



Turn off the ac power on the HP 8349B prior to connecting or disconnecting the source module interface cable.

Connect the system as shown in Figure 2-1.

FREQUENCY CONTROL

After the connections have been made, turn on the system, and press **[INSTR PRESET]** on the HP 8340B/41B. Allow instruments to warm-up 30 minutes. Next, enter a display multiplier on the HP 8340B/41B so that the multiplied output frequency will be correctly displayed. A multiplication factor of two should be entered by pressing:

[SHIFT] [START] [2] [Hz]

Once the multiplication factor is entered you can now directly set the frequency range of interest on the HP 8340B/41B front panel.

NOTE: Entering frequencies outside 26.5 to 40.0 GHz (13.25 to 20.0 GHz) are invalid and the system will not work properly.

The multiplication factor may be reset to one by pressing:

[INSTR PRESET]

or by entering a multiplication factor of one by pressing:

[SHIFT] [START] [1] [Hz]

The multiplication factor may be "locked" by pressing:

[SHIFT] [ALT]

This eliminates having to re-enter the multiplication factor each time **INSTR PRESET** is pressed.

The lock may be removed and the multiplication factor may be reset to one by pressing:

[SHIFT] [INSTR PRESET]

POWER LEVEL CONTROL



Before performing any power level calibrations, ensure that the HP 8340B/41B synthesizer is not at maximum power.

Power is controlled by pressing **[POWER LEVEL]**. The step keys, rotary knob or keypad controls the output power from the synthesizer. The actual output power from the mm-wave source module is read on the HP 8340B/41B PWR dBm display in the system leveled mode. To activate system leveling, press **[SHIFT] [XTAL]**. Once activated, the display will read "EXT MODULE POWER: - XX.XX dBm" and the internal attenuator is automatically set at 0 dB. The HP 8340B/41B internal attenuator is controlled by pressing **[SHIFT] [SLOPE]** and should normally be set to 0 dB.

POWER LEVELING

System Leveling

System leveling provides calibrated, flat power from the output of the mm-wave source module. The HP 8340B/41B/83554A configuration shown in Figure 2-1 provides leveled source module output power with corrected power level flatness. With the SHIFT XTAL key on, a portion of the source module power output is coupled out of a directional coupler and detector internal to the source module. This signal is processed and fed through the HP 8349B synthesizer interface and applied to the HP 8340B/41B ALC circuit.

External Crystal Detector Leveling

Figure 2-2 illustrates a typical crystal detector leveling setup. Directional couplers and crystal detectors are used to level the source module output power. A portion of the HP 83554A source module output signal is sampled and applied to the HP 8340B/41B external ALC circuit.

Set the LEVELING mode to [XTAL]. Power is controlled by pressing XTAL or POWER LEVEL. The entry display will read "ATN: - XX dB, REF: XX.XX dBv". When the UNLEV and the OVERMOD annunciators are not lit, use the rotary knob or keypad to control the output power from the source module which is displayed on the HP 8349B. Set the attenuator (via the step keys) to zero dB. The REF entry displays the HP 8340B/41B ALC voltage from the detector. If the detector characteristics are unknown, start with -40 dBv. The REF value is in dBv.

The HP 8340B/41B output power is displayed on the HP 8340B/41B front panel as PWR dBm. If the display reads "— — — .—" or the OVERMOD annunciator is lit, the ALC level is operating below acceptable range. Insert additional input attenuation with the step keys to force the ALC level into proper operating range and for the PWR dBm display to be active.

Maximum specified power and flatness may not be achieved when using an external leveling technique as a result of leveling coupler losses.

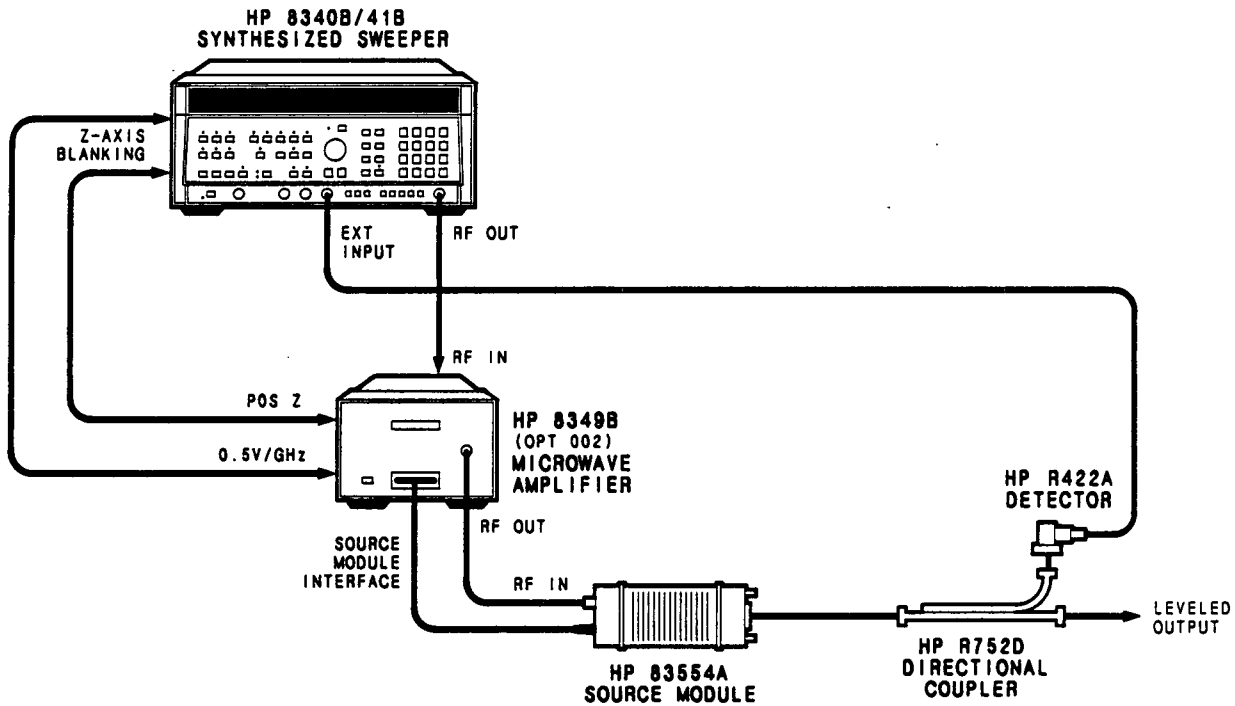

Figure 2-2. External Crystal Detector Leveling at the HP 83554A Source Module Output

External Power Meter Leveling

Output power may also be leveled with a power meter and a directional coupler as shown in Figure 2-3. Power meter leveling at the source module output is possible using the power meters referenced in Table 1 (System General Information).

Set the ALC mode to **[METER]** on the HP 8340B/41B. The sweep time is limited to 100 seconds when this leveling method is used. A portion of the mm-wave output signal from the source module is coupled/detected and routed to the power meter. The DC voltage from the power meter recorder output is then applied to the HP 8340B/41B external ALC circuit.

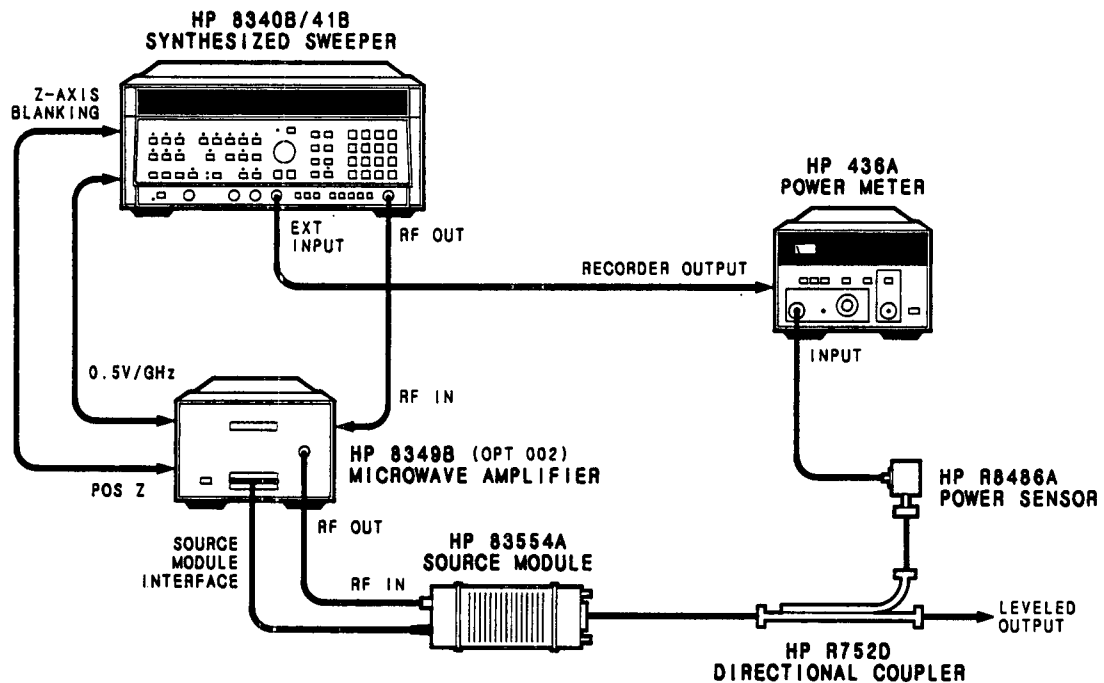

Figure 2-3. External Power Meter Leveling at the HP 83554A Source Module Output

MODULATION

For complete specifications on all modulation modes described below refer to Table 2-1 (HP 8340B/41B/83554A System Specifications).

Frequency Modulation (FM Connector on HP 8340B/41B)

With the FM key activated, the source module may be frequency modulated from an external input signal. The FM deviation is doubled by the HP 83554A source module but the displayed FM sensitivity remains correct as long as the frequency multiplication factor remains at two.

FM sensitivities of 2 MHz/V or 20 MHz/V are available over a bandwidth of 50 kHz to 10 MHz.

Amplitude Modulation (AM Connector on HP 8340B/41B)

When the AM key is activated, the AM input is used for linear, DC-coupled amplitude modulation. The small signal – 3dB bandwidth extends from DC to 100 kHz.

The sensitivity is 100% per volt. This means that +1.0 volt doubles the output voltage (+6 dB), while –1.0 volt shuts the output completely off.

For maximum modulation index, the HP 83554A source module should be set to a power level 6 dB below maximum power.

Pulse Modulation (PULSE Connector on HP 8340B/41B)

With the PULSE key activated, and the HP 8340B/41B system leveled, the application of a pulsed or square wave signal to the PULSE connector provides a pulsed or square wave modulated signal at the output of the HP 83554A. This input provides an ON/OFF power ratio of greater than 80 dB. The PULSE IN input is normally at a TTL HIGH (approximately +3 volts DC). When a TTL LOW signal (approximately 0 volts DC) is applied, the mm-wave output signal is turned off.

OPERATING SUGGESTIONS

When using an HP 8340B/41B synthesizer as the source driver, you can optimize the ALC loop performance by using fixed attenuator(s). For example, typical HP 8340B/41B/83554A system power levels (not optimized) over the specified range, are as follows:

SYNTHESIZER (dBm)		HP 83554A (dBm)
DISPLAY	OUTPUT	OUTPUT
+8.0	-12.0	+8.0
-5.0	-23.0	-5.0

The RF synthesizer power output levels are quite low and can possibly reach the lower limit of the ALC modulator range. By adding a fixed attenuator(s) between the RF synthesizer and the HP 8349B amplifier the overall system power level will decrease. A corresponding change in ALC drive signal will cause the RF synthesizer to increase output power to correct for the apparent power loss and thereby operate at a more desirable ALC level.

OPERATOR'S CHECK

DESCRIPTION

The following procedure will enable you to verify the proper operation of your HP 8340B/41B/83554A system by determining the system's output power and flatness performance over the R-band frequency range of 26.5 to 40.0 GHz at maximum leveled output power. Maximum leveled output power is split into two specifications across the band, +8.0 dBm (26.5 to 37.2 GHz) and +7.0 dBm (37.2 to 40.0 GHz). Therefore, the subsequent procedure will test the power flatness at both power levels.

EQUIPMENT

Ensure that all the instruments below meet their own performance standards and have been recently calibrated to proper specifications before configuring them into the setup.

RF Signal Source	HP 8340B/41B Synthesized Sweeper
Microwave Amplifier	HP 8349B
Power Meter	HP 436A
Power Sensor	HP R8486A

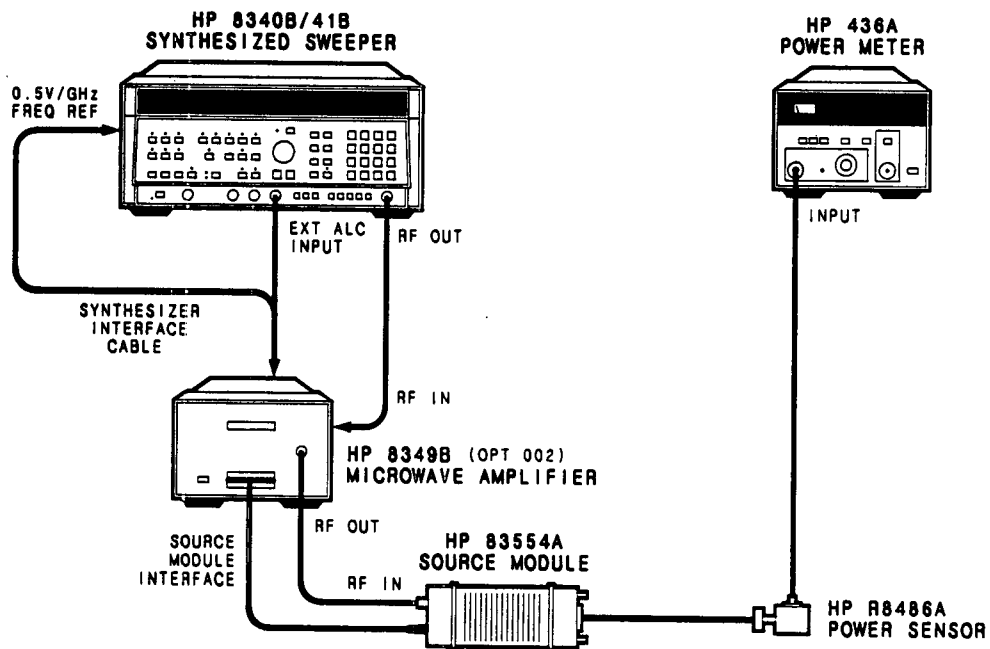

Figure 2-4. System Configuration

PROCEDURE

1. Connect the equipment as shown in Figure 2-4. Do not connect the HP R8486A power sensor to the HP 83554A output.
2. Turn on all system components.
3. On the HP 436A:

Press [dBm] mode.

Zero and calibrate the power meter. Set the CAL FACTOR at 100%. The CAL FACTOR will **not** be changed for the rest of the procedure. By leaving the CAL FACTOR at 100%, it ensures minimum specifications will be met.

4. On the HP 8340B/41B:

Press [SHIFT] [INSTR PRESET]

Press [SHIFT] [START] [2] [Hz]

Press [SHIFT] [ALT]

Press [SH] [XTAL] EXT INPUT leveling

Press [CW] [2] [6] [.] [5] [GHz]

Connect the HP R8486A power sensor to the HP 83554A output.

Press [POWER LEVEL] and adjust rotary knob for an 8.0 dBm reading on the HP 436A display. Ensure that the HP 436A power meter display is within ± 2.0 dB of the HP 8340B/41B display.

NOTE: Ensure that the [AM MOD] button is in the off state or it will affect the accuracy of this test.

5. Press [CW]

While observing the HP 436A display, find the minimum power point between 26.5 to 37.2 GHz by slowly adjusting the rotary knob. Note at what frequency the minimum power point is. See Figure 2-5.

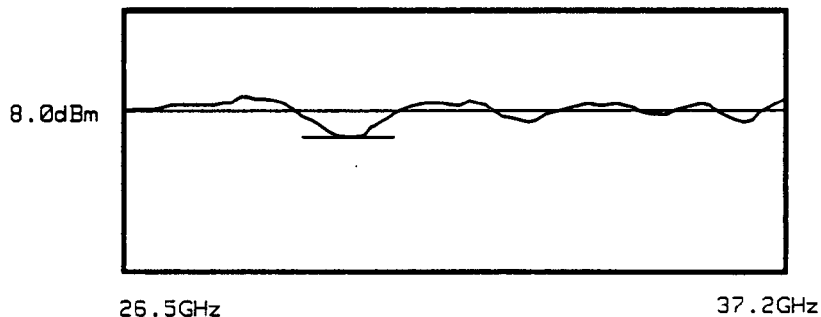

Figure 2-5. Minimum Power Point (26.5 to 37.2 GHz)

Enter the frequency at the minimum power point by pressing [CW] XX.XX [GHz]

6. Press [POWER LEVEL] and adjust the rotary knob until you obtain an 8.0 dBm reading on the HP 436A display.

7. Press **[CW] [2] [6] [.] [5] [GHz]**

Tune the rotary knob from 26.5 to 37.2 GHz and ensure that the power level displayed on the HP 436A never exceeds 10.5 dBm. This ensures that from 26.5 to 37.2 GHz, the system's power flatness is within ± 1.25 dB of maximum leveled power, 8.0 dBm. See Figure 2-6.

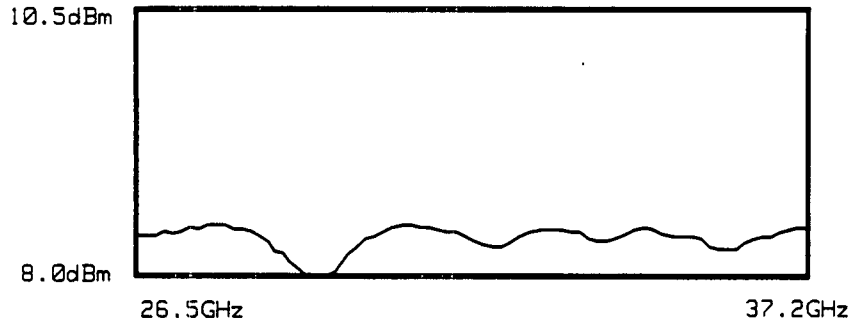

Figure 2-6. Power Flatness Response (26.5 to 37.2 GHz)

The foregoing procedure completes the operator's check from 26.5 GHz to 37.2 GHz. To test the remaining portion of the R-band (37.2 to 40.0 GHz), follow the proceeding steps.

8. On the HP 8340B/41B:

Press **[RECALL] [1]**

Press **[POWER LEVEL]** and adjust the rotary knob for a 7.0 dBm reading on the HP 436A display.

Find the minimum power point between 26.5 to 40.0 GHz by slowly adjusting the rotary knob from 26.5 to 40.0 GHz. Note at what frequency the minimum power point is. See Figure 2-7.

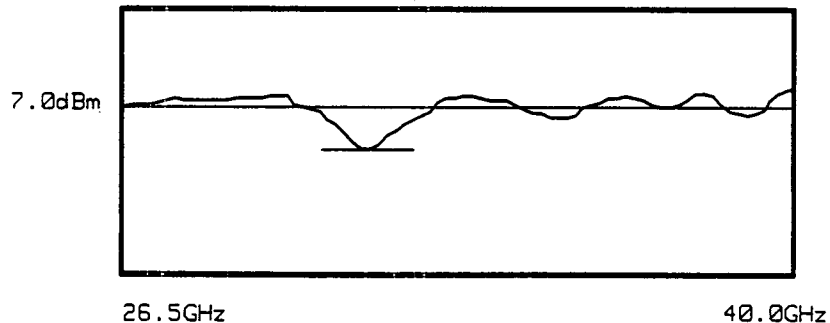

Figure 2-7. Minimum Power Point

Enter the frequency of the minimum power point by pressing **[CW] XX.XX [GHz]**

Press **[POWER LEVEL]** and adjust the rotary knob for a 7.0 dBm reading on the HP 436A display.

Press **[CW] [2] [6] [.] [5] [GHz]**

Slowly rotate the rotary knob from 26.5 to 40.0 GHz. Observe the HP 436A display through the entire band making sure that the power level displayed never exceeds 9.5 dBm. This ensures that the system's power flatness is within ± 1.25 dB of maximum leveled power. See Figure 2-8.



Figure 2-8. Power Flatness Response (26.5 to 40.0 GHz)

This completes the Operator's Check. If your system fails this functional check, refer to the paragraph titled TROUBLESHOOTING.

SYSTEM PERFORMANCE TESTS

INTRODUCTION

The procedures in this section test the performance of the HP 8340B/41B/83554A source system using the specifications of Table 2-1 as the performance standards. All tests can be performed without access to the interior of the instrument. The performance test procedures must be performed in the sequence given since some procedures rely on satisfactory test results in the foregoing steps. In order to fully verify the performance specifications of the HP 83554A, the performance tests in the Source Module Specifications and Service Section must also be performed. None of the tests require access to the interior of the instrument.

Under the paragraph, TROUBLESHOOTING, you will find information on what to do if your system fails to meet specifications.

EQUIPMENT REQUIRED

Equipment required for the performance tests are listed in the Recommended Test Equipment tables in the Source System Guides, and in the Specifications and Service Section of the manual. Any equipment that satisfies the critical specifications given in the table may be substituted for the recommended models. Ensure also that the test equipment used is currently calibrated to proper specifications.

NOTE: Use only the connectors and cables that are specified in the following test setups to ensure accurate test results.

OPERATION VERIFICATION

The Operation Verification consists of performing the source module specific performance tests (Source Module Specifications and Service Section) which include, Maximum Leveled Power (verifies frequency range), Power Flatness, and Power Level Accuracy. These tests provide reasonable assurance that the source module is functioning properly and should meet the needs of an incoming inspection (80% verification).

TEST RECORD

Results of the performance tests may be recorded in the Test Record at the end of the procedures. The Test Record lists all of the tested specifications and their acceptable limits. Test results recorded at incoming inspection can be used for comparison in periodic maintenance and troubleshooting and after repairs or adjustments.

FREQUENCY CHARACTERISTICS

Range
Accuracy
CW Resolution
Stability

MODULATION

The performance tests listed above are source dependent and can be found in the Performance tests of the appropriate HP 8340B/41B synthesized sweeper Operating and Service Manual.

NOTE: When specifying the output frequency and modulation characteristics of the HP 8340B/41B/83554A system, all frequency specifications are referenced from the sources used and must be doubled because the HP 83554A is a frequency doubler. For special information about the doubler, refer to the A4 Multiplier Assembly theory of operation found in the Source Module Specifications and Service Section of this manual.

SYSTEM HARMONICS

Specification

Harmonic related > 20 dBc

Description

The RF output signal from the HP 8340B/41B/83554A system is tuned from 26.5 to 40.0 GHz and is displayed on a spectrum analyzer to verify that any harmonic spurious signals are at or below their specified levels. The test configuration in Figure 2-9 uses an external harmonic mixer to extend the frequency range of the spectrum analyzer. When this technique is used, the response is not pre-selected and multiple signals are displayed. Each response is examined not only for power relative to the fundamental frequency but whether or not it is a true in-band spurious signal by using the spectrum analyzer's signal identification function.

The following procedure addresses harmonic related spurious responses. The potential problem locations of harmonic related responses can be calculated by using the equations in Table 2-2. For any CW output signal from the HP 83554A mm-wave source module, accompanying harmonic responses may be present.

Equipment

RF Signal Source	HP 8340B/41B Synthesizer Sweeper
Microwave Amplifiers	HP 8349B and HP 11975A
Spectrum Analyzer	HP 8566B
Directional Coupler	HP R752D
Harmonic Mixer	HP 11970A
RF Cables (3)	HP 5061-5458
Power Meter	HP 436A
Power Sensor	HP R8486A

Procedure

1. Connect the equipment as shown in Figure 2-9.

Turn on all system components.

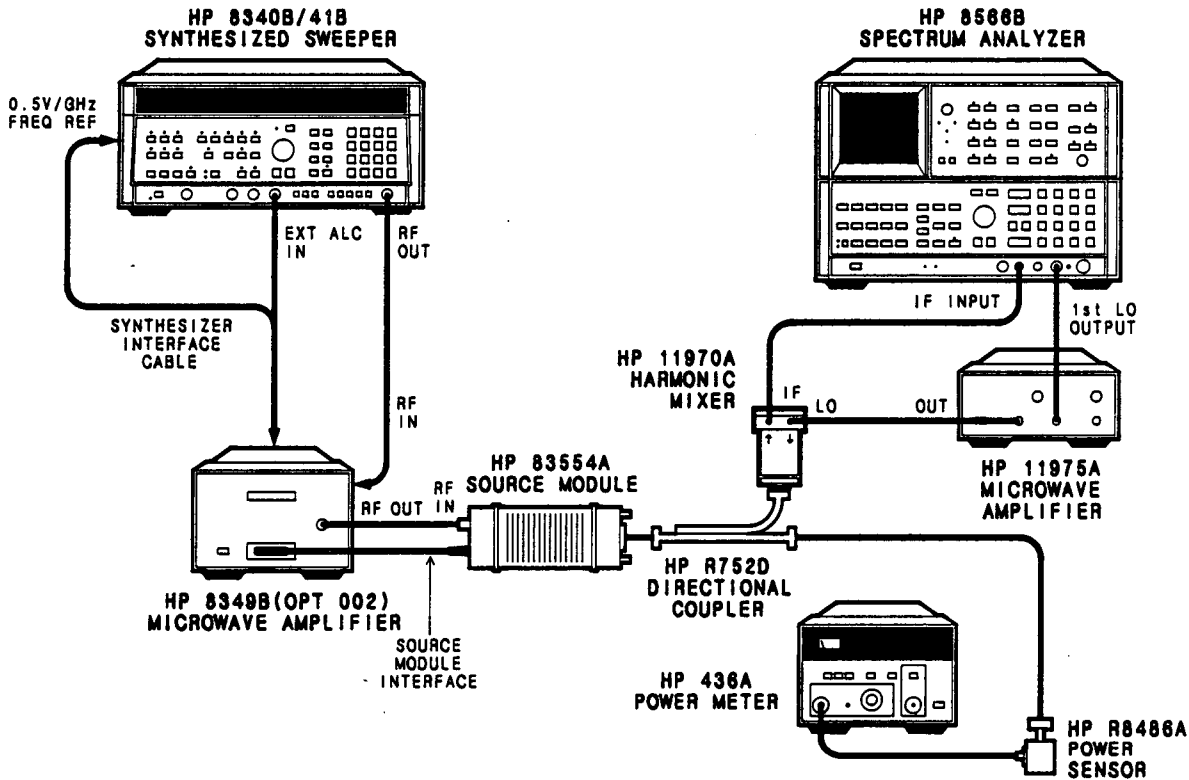

Figure 2-9. Spurious Signals Test Setup

Harmonic Related Spurious Signals

Harmonic related spurious signals are determined from the calculations in Table 2-2 below. The table is split into two frequency ranges, 26.5 to 27.0 GHz and 27.0 to 40.0 GHz. This frequency range split is determined from band switch points in the HP 8340B/41B synthesizer. Between 26.5 and 27.0 GHz, two possible harmonics of F₂ (HP 83554A output frequency) may appear. Also, between 27.0 and 40.0 GHz, four possible harmonics may appear.

Table 2-2. Calculated Harmonic Frequencies

Fundamental Frequency	Fundamental Frequency
26.5 – 27.0 GHz	27.0 – 40.0 GHz
Harmonics	Harmonics
$5/4 \times F_2$	$4/6 \times F_2$
$6/4 \times F_2$	$5/6 \times F_2$
	$7/6 \times F_2$
	$8/6 \times F_2$

If the desired CW frequency output of the HP 83554A is between 26.5 to 27.0 GHz, the HP 8340B/41B synthesizer is in band 2. If the desired CW output frequency of the HP 83554A is between 27.0 to 40.0 GHz, the HP 8340B/41B Series synthesizer is in band 3. With the synthesizer in band 2, all HP 83554A output frequencies (26.5 to 27.0 GHz) can be accompanied by two possible harmonic related spurs within the R-band frequency range, the 5/4 and 6/4 harmonic responses. For example, if the output frequency of the HP 83554A is 26.5 GHz, there may be accompanying harmonic spurs at 33.125 and 39.750 GHz. These are calculated as follows:

$$5/4 \times (26.5 \text{ GHz}) = 33.125 \text{ GHz}$$

$$6/4 \times (26.5 \text{ GHz}) = 39.750 \text{ GHz}$$

With the RF synthesizer in band 3, all HP 83554A output frequencies (27.0 to 40.0 GHz) may be accompanied by four harmonic related spurs, the 4/6, 5/6, 7/6, and 8/6 harmonic responses, three of which may be present within the R-band frequency range at one time. For example, if the output frequency of the HP 83554A is 30.0 GHz, there will be accompanying harmonic spurs at 20.000, 25.000, 35.000, and 40.000 GHz. Since the harmonic spur at 20.000 GHz is not within the R-band frequency range, it will not appear at the output of the HP 83554A. The above harmonic spurs are calculated as follows:

$$4/6 \times (30.0 \text{ GHz}) = 20.000 \text{ GHz}$$

$$5/6 \times (30.0 \text{ GHz}) = 25.000 \text{ GHz}$$

$$7/6 \times (30.0 \text{ GHz}) = 35.000 \text{ GHz}$$

$$8/6 \times (30.0 \text{ GHz}) = 40.000 \text{ GHz}$$

2. On the HP 8340B/41B:

Press **[SHIFT] [INSTRUMENT PRESET]**

Press **[SHIFT] [START] [2] [Hz]**

Press **[SHIFT] [ALT]**

Press **[CW] [2] [6] [.] [5] [GHz]**

3. Press **[XTAL] EXT ALC MODE**
Press **[POWER LEVEL]**

Adjust the power level rotary knob for an 8.0 dBm reading on the HP 8340B/41B display.

4. Ensure that the HP 436A display reads 8.0 dBm \pm 2.00 dB.

5. On the HP 8566B:

Press **[INSTR PRESET]**

Press **[SHIFT] [▲] [▲]** until the **FULL BAND K (A)** annotation appears. This places the analyzer into an external mixing mode allowing R-band frequency range capability. Note the start/stop frequency at the bottom of the screen and ensure that the start frequency is 26.5 GHz and the stop frequency is 40.0 GHz.

Press **[REF LEVEL] [8] [.] [0] [+dBm]**

Press **DISPLAY LINE [ENTER] [1] [2] [-dBm]**, setting the 20 dBc reference.

Amplitude Calibration of the HP 8566B

The HP 8566B spectrum analyzer can make amplitude calibrated measurements of millimeter signals when configured with the HP 11970 mixers. A calibration graph that shows conversion loss and reference level offset is provided with each mixer so that the analyzer can be normalized to that mixer. The following explanation illustrates how this offset is entered into the spectrum analyzer.

In the external mixing mode, the HP 8566B gain is automatically increased 30 dB to compensate for the conversion loss of an external mixer. Using the information from the graph supplied with the mixer, you can offset the reference level to obtain precise amplitude calibration for point by point frequency measurements. For example, if the calibration table indicates the Reference Level Offset for a frequency of 30.0 GHz is -6.8 dB, this offset would be entered by pressing:

[SHIFT] [REF LEVEL] [6] [.] [8] [-dBm]

With this offset entered, the HP 8566B is amplitude calibrated at 30.0 GHz. If less accurate measurements can be tolerated, normalizing the conversion loss graph on the HP 11970 can be accomplished by averaging the graph's maximum and minimum power points resulting in an overall conversion loss for the entire band. By using this method, an increase of measurement uncertainty is introduced into the test. Reference level offset is determined by the following equation:

$$\text{Conversion Loss} - 30 \text{ dB} = \text{Reference Level Offset}$$

Because the test configuration in Figure 2-9 specifies that the external mixer be connected to the coupled arm of a 20 dB directional coupler, the coupled power must also be taken into account when calculating reference level offset. The new equation is as follows:

$$\text{Conversion Loss} + \text{coupled power (20 dB)} - 30 \text{ dB} = \text{Reference Level Offset}$$

6. On the HP 8340B/41B:

Manually tune the HP 8340B/41B from 26.5 to 37.2 GHz while watching for harmonic responses that are higher than the display line (< 20 dBc) on the HP 8566B display.

Signal Identification

7. If a harmonic related spurious signal is found, verify whether or not it is a true in-band signal by using the spectrum analyzer's signal identification feature. This is performed as follows:
8. Tune the signal under observation to center screen on the HP 8566B display.
9. Press **[SHIFT] [FREE RUN]**
10. If the signal is a false response, the annotation **IDENTIFIED OUT OF BAND** will appear on the display.
11. Ensure that any harmonic-related spurious signals observed are within the specified level of > 20 dBc.

Measurement Uncertainty

Measurement uncertainty within the test configuration will affect the accuracy of this performance test. To obtain optimum accuracy, amplitude calibrate the spectrum analyzer by entering the conversion loss at each frequency signal under observation as explained under **Amplitude Calibration of the HP 8566B**. Any harmonic-related spurious signals that are close to or at 20 dBc should be given an allowable margin of ± 1.5 dB to compensate for all other measurement uncertainties within the test configuration.

12. The foregoing steps performed a harmonic related spurious test from 26.5 to 37.2 GHz at a specified maximum leveled power of 8.0 dBm. The proceeding steps will continue this test covering the remaining frequency range of the R-band (37.2 to 40.0 GHz) at a maximum leveled power of 7.0 dBm.

13. On the HP 8340B/41B:

Press **[POWER LEVEL]**

Adjust the power level rotary knob for a 7.0 dBm reading on the HP 8349B/41B display.

14. Ensure that the HP 436A display reads 7.0 dBm \pm 0.5 dB.

15. On the HP 8566B:

Press **[REF LEVEL] [7] [.] [0] [+dBm]**

Press **DISPLAY LINE [ENTER] [1] [3] [-dBm]**, setting the 20 dBc reference.

16. Repeat steps 6 through 11 except this time tune the HP 8340B/41B from 37.2 to 40.0 GHz.

This concludes the performance test for harmonic related spurious signals. Performance of this test ensures that all potential problem harmonic related spurious locations have been thoroughly tested for the HP 8340B/41B/83554A system.

If your system fails to meet these specifications, refer to the paragraph titled TROUBLESHOOTING.

Table 2-3. Performance Test Record

HP 8340B/41B Series System				
Serial Number _____		Date _____		
Humidity* _____		Tested By _____		
(Optional)		Temperature _____		
Specification Tested	Test Conditions	Specification	Test Results	
			Pass	Fail
FREQUENCY				
Range ¹	_____	26.5 to 40.0 GHz ¹	_____	_____
Accuracy (25°C ± 5°C)	_____	Same as time base	_____	_____
CW Mode	_____	Internal 10 MHz time base	_____	_____
Time Base	_____	Aging rate: less than 1 x 10 ⁻⁹ /day and 2 x 10 ⁻⁷ /year after 30-day warmup.	_____	_____
	_____	Temperature effect	_____	_____
	_____	< 1 x 10 ⁻¹⁰ /°C	_____	_____
	_____	Line Voltage effect	_____	_____
	_____	< 1 x 10 ⁻¹¹ /± 10%	_____	_____
All Sweep Modes (for sweep time > 100 msec)	_____	ΔF ≤ (n) 10 MHz	_____	_____
	_____	± 1% of ΔF ± time base accuracy	_____	_____
	_____	(n) 10 MHz > ΔF ≤ 600 MHz:	_____	_____
	_____	± 2% of ΔF	_____	_____
	_____	ΔF ≥ 600 MHz:	_____	_____
	_____	± 1% of ΔF or ± 100 MHz whichever is less.	_____	_____
	_____	n = harmonic band (1-4) of the HP 8340B/41B	_____	_____
CW Resolution ¹	_____	6 Hz ¹	_____	_____
MODULATION				
External FM Bandwidth	_____	50 kHz to 10 MHz	_____	_____
Deviation	_____	the lesser of 20 MHz or	_____	_____
	_____	20 x fmod from 26.5 to 27.0 GHz,	_____	_____
	_____	30 x fmod from 27.0 to 40.0 GHz	_____	_____
Sensitivity	_____	2 MHz/V or 20 MHz/V	_____	_____
OUTPUT				
System Harmonics	_____	> 20 dBc	_____	_____

1. These specifications are referenced from the appropriate HP 8340B/41B synthesized sweeper manuals and have been multiplied by a factor of 2 because the HP 83554A is a frequency doubler.

TROUBLESHOOTING

Specification Failures

Failures are divided into two categories:

Category one describes systems that are meeting specifications in some areas, while failing in others. If this is the case, do the following:

- Inspect the connectors and ensure that all connections are making good electrical contact.

- Inspect all cabling for breaks.

- Test again.

If your system is still failing at the SAME points, your instrument(s) or cable(s) could be defective and should be returned for repair. If, however, your system fails at DIFFERENT points, there is probably a loose connection or a mechanical failure somewhere in the setup.

Remember, it is possible the system may fail the performance test(s) because of measurement uncertainties. If you suspect this to be the case, contact your nearest HP office for more information.

Category two failures are total specification failures. If your system fails any of these tests completely, do the following:

- Check the TEST SETUP for correct configuration of the instruments and connections.

- Inspect the connectors.

- Inspect the cables.

- Repeat the failed test(s).

If your system is still failing, the system is probably defective and needs repair.

Also, for the best accuracy in measurement, use only calibrated instruments.

Troubleshooting System Harmonics

If the HP 8340B/41B/83554A system fails to meet the specifications mentioned in step 6 of the System Harmonics test, the failure may be occurring from either the HP 8340B/41B synthesized sweeper, the HP 8349B, or the HP 83554A mm-wave source module. The following steps will help to isolate the origin of the failure. See Figure 2-10 for harmonic power check points.

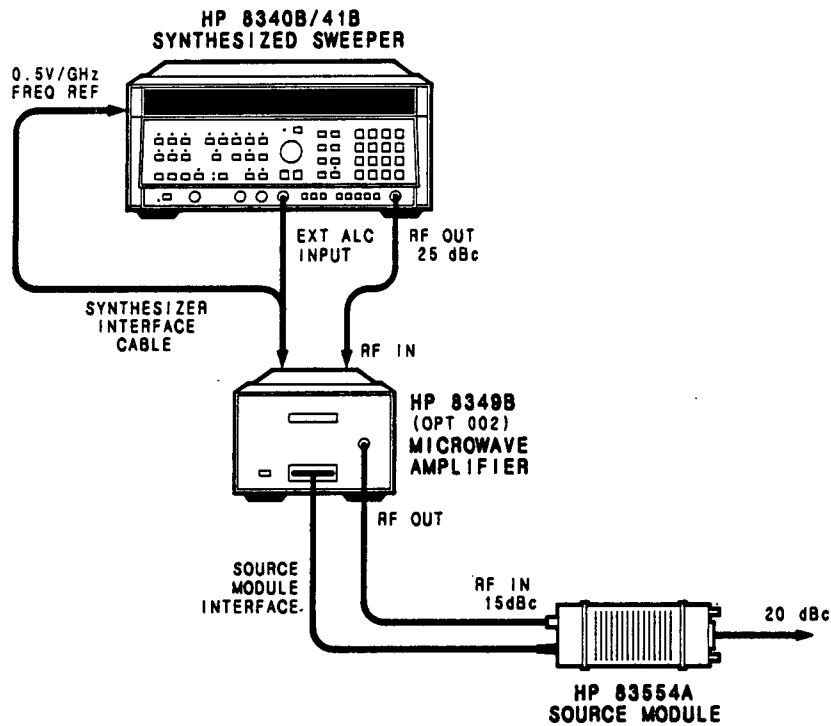

Figure 2-10. Harmonic Check Points

1. If the harmonic related spurious output from the HP 83554A is less than 20 dBc, check the harmonic output of the HP 8349B and ensure that it is >15 dBc.
2. If the HP 8349B harmonic output is within specifications, refer to the Source Module Specifications and Service section of this manual and perform the Harmonics Spurious performance test to verify that the HP 83554A is at fault. If the HP 83554A is at fault, refer to the Source Module Specifications and Service Section for repair or replacement of the instrument.
3. If the HP 8349B harmonic output is <15 dBc, continue to step 4.
4. Check the spurious signal output level of the HP 8340B/41B synthesizer by referring to the appropriate HP 8340B/41B Operating and Service manual for the Spurious Signals performance test to verify whether or not the RF synthesizer is at fault. The specified harmonic related spurious output level should be >25 dBc. If the spurious signals are within specification, repair or replace the HP 8349B.
5. If the HP 8340B/41B synthesizer exceeds harmonic output specifications, repair or replace the synthesizer.

REGIONAL SALES AND SUPPORT OFFICES

For information relating to Sales or Support of Hewlett-Packard products first contact your local Hewlett-Packard office listed in the white pages of your telephone directory. If none is listed locally, contact one of the addresses listed below to obtain the address or phone number of the Hewlett-Packard Sales or Support office nearest you.

ASIA

Hewlett-Packard Asia Ltd.
47/F, 26 Harbour Road,
Wanchai, **HONG KONG**
G.P.O. Box 863, Hong Kong
Tel: (852) 5-8330833
Telex: 76793 HPA HX
Cable: HPASIAL TD

AUSTRALASIA

Hewlett-Packard Australia Ltd.
31-41 Joseph Street
BLACKBURN, Victoria 3130
Australia
Tel: (61) 895-2895
Telex: 31-024
Cable: HEWARD Melbourne

CANADA

Hewlett-Packard (Canada) Ltd.
6877 Goreway Drive
MISSISSAUGA, Ontario L4V 1M8
Tel: (416) 678-9430
Telex: 069-8644

JAPAN

Yokogawa-Hewlett-Packard Ltd.
29-21 Takaido-Higashi, 3 Chome
Suginami-ku **TOKYO** 168
Tel: 03 (331) 6111
Telex: 232-2024 YHPTOK

MEDITERRANEAN AND MIDDLE EAST

Hewlett-Packard S.A.
Mediterranean and Middle East
Operations
Atrina Centre
32 Kifissias Avenue
Paradissos-Amarousion, **ATHENS**
Greece
Tel: (30) 682 88 11
Telex: 21-6588 HPAT GR
Cable: HEWPACKSA Athens

BENELUX & SCANDINAVIA

Hewlett-Packard S.A.
Uilenstede 475
P.O. Box 999
NL-1183 AG AMSTELVEEN
The Netherlands
Tel: (31) 20/43 77 71
Telex: 18 919 hpner nl

SOUTH & EAST EUROPE, AFRICA

Hewlett-Packard S.A.
7, rue du Bois-du-Lan
CH-1217 MEYRIN 2, Geneva
Switzerland
Tel: (41) 22/83 12 12
Telex: 27835 hmea
Cable: HEWPACKSA Geneve

FRANCE

Hewlett-Packard France
Parc d'activités du Bois Briard
2, avenue du Lac
91040 EVRY Cedex
Tel: 1 6/077 83 83
Telex: 6923 15F

GERMAN FEDERAL REPUBLIC

Hewlett-Packard GmbH
Hewlett-Packard-Strasse
Postfach 1641
D-6380 BAD HOMBURG
West Germany
Tel: 06172/400-0
Telex: 410 844 hpbhg

ITALY

Hewlett-Packard Italiana S.p.A.
Via G. Di Vittorio 9
**1-20063 CERNUSCO SUL
NAVIGLIO**
(Milano)
Tel: 02/92 36 91
Telex: 334632

UNITED KINGDOM

Hewlett-Packard Ltd.
King Street Lane
Winnersh, **WOKINGHAM**
Berkshire RG11 5AR
Tel: 734/78 47 74
Telex: 847178

EASTERN USA

Hewlett-Packard Co.
4 Choke Cherry Road
ROCKVILLE, MD 20850
Tel: (301) 670-4300

MIDWESTERN USA

Hewlett-Packard Co.
5201 Tollview Drive
ROLLING MEADOWS, IL 60008
Tel: (312) 255-9800

SOUTHERN USA

Hewlett-Packard Co.
2000 South Park Place
P.O. Box 105005
ATLANTA, GA 30348
Tel: (404) 955-1500

WESTERN USA

Hewlett-Packard Co.
5161 Lankershim Blvd.
P.O. Box 3919
NO. HOLLYWOOD, CA 91609
Tel: (818) 506-3700

OTHER INTERNATIONAL AREAS

Hewlett-Packard Co.
Intercontinental Headquarters
3495 Deer Creek Road
PALO ALTO, CA 94304
Tel: (415) 857-1501
Telex: 034-8300
Cable: HEWPACK

February, 1986



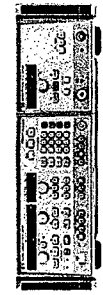

HP 8350 Series Sweep Oscillators

The HP 8350 combines a versatile microprocessor-controlled mainframe with an extensive selection of state-of-the-art RF plug-ins to yield an outstanding swept source. For the ultimate in plug-in flexibility, the HP 8350 mainframe accepts the HP 83500 series plug-ins and also the HP 86200 series plug-ins (through the HP 11869A adapter). The HP 83500 series plug-ins offer a calibrated output power range of at least 10 dB (80 dB optional) with 0.1 dB of digitally displayed resolution. Internal leveling, power sweep, and slope control are also standard features on the HP 83500 series plug-ins. All front panel functions on the HP 8350 and 83500 series plug-ins are computer-controllable via the Hewlett-Packard Interface Bus (HP-IB) for simple integration into automatic systems.

HP 8350 Series Plug-In Summary

HP Model Number	Frequency Range (GHz)	Levelled Output Power	Frequency Accuracy (MHz)
83577A	0.01-40	1 mW	±20
83586A	0.1-26.5	1 mW	±20
83594A	0.1-26.5	2.5 mW	±12
83597A	0.01-20.0	2.5 mW	±10
83592A	0.01-20.0	20 mW	±10
83592C	0.01-20.0	4 mW	±10
83592D	2.0-20.0	10 mW	±10
83595A	0.01-8.4	20 mW	±12
83595B	0.01-8.4	10 mW	±12
83592E	0.01-2.4	20 mW	±5
83590A	2.0-8.4	40 mW	±12
83590B	2.0-8.4	20 mW	±12
83590C	6.0-20.0	100 mW	±20
83545A	5.9-12.4	50 mW	±20
83570A	18.0-26.5	10 mW	±100
83572A	26.5-40.0	2 mW	±100
83573A	26.5-40.0	2 mW	±100

HP 8350B sweep oscillator mainframe
HP 11869A adapter for HP 86200 series plug-ins

¹The HP 8350, with appropriate plug-in driving the HP 8349B microwave amplifier module, > 100 mW of output power from 2 to 18.6 GHz.
²The HP 8352B, 83540B, and 8340B with < -45 dBc harmonics from 2 to 8.4 GHz, and the HP 83592C with < -55 dBc from 3.2 to 20 GHz, and the HP 83596A and 83597A with < -50 dBc from 2.4 to 20 GHz, and < -40 dBc from 20 to 40 GHz, offer excellent harmonic and subharmonic suppression.
³> 43 mW of output power from 18.6 to 20 GHz.
⁴Minimum unlevelled output power.
⁵All sample programs in the Introductory Operating Guides for the HP 8350A are applicable to the HP 8350B with the exception of the STATUS BYTE sample programs.

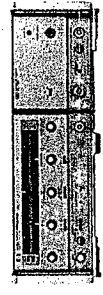

HP 8620 Series Sweep Oscillators

The HP 8620 series offers the flexibility of the HP 8620 mainframe in addition to a choice of single-band, straddle-band, and broadband plug-ins. Combined with the HP 11869A adapter the entire line of 86200 series plug-ins can be used in the 8350 sweep oscillator mainframe with no degradation in performance. Internal leveling is a standard feature on the HP 86200 series plug-ins. The HP 8620C Option 011 adds HP-IB programmability to this sweeper. HP 86200 series plug-ins are also available with upconverter simulation options for use in microwave link analysis (MLA). These options ensure compatibility with the HP 3700 series microwave link analyzers to permit accurate RF-RF, RF-IF, and RF-BB distortion measurements.

HP 86200 Series Plug-In Summary

HP Model Number	Frequency Range (GHz)	Levelled Output Power	Frequency Accuracy (MHz)	MLA Options
86200B	2.0-18.6	10 mW	±80	
86200C	2.0-18.6	20 mW	±80	H80 (5-2.4 GHz)
86222A/B	0.01-2.4	20 mW	±10	
86240A	2.0-8.4	40 mW	±20	
86240B	2.0-8.4	20 mW	±20	
86240C	3.6-8.6	40 mW	±20	STD (3.6-8.6 GHz)
86251A	7.5-18.8	10 mW	±20	
86235A	1.7-4.3	40 mW	±20	008 (1.7-4.3 GHz)
86240D	3.7-8.5	32 mW	±35	
86245A	5.9-12.4	50 mW	±40	008 (5.9-12.4 GHz)
86250D	8.0-12.4	10 mW	±50	008 (8.0-12.4 GHz)
86250B	10.0-15.5	10 mW	±50	H82 (10.0-15.5 GHz)
86250A	12.4-18.0	10 mW	±50	H82 (12.0-18.0 GHz)
86260C	17.0-22.0	10 mW	±50	

HP 8620C sweep oscillator mainframe

Reference Literature

Title*	Subject	HP Literature No.
—	8620C Sweep Oscillator Data Sheet	5952-9317
PN 8620C-1	Using the HP 8620C Sweep Oscillator with the Wiltron 560 Scalar Network Analyzer	5952-9327
AN 187-6	Frequency Performance of the 8620C Sweep Oscillator Under Remote Programming	5952-9271
AN 312-1	Configuration of a Two-Tone Sweeping Generator	5952-9016

*PG = Programming note
PN = Product note
AN = Application note

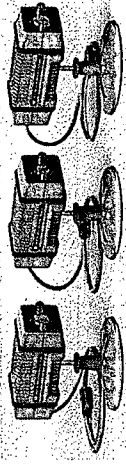

HP 83550-Series Millimeter-Wave Source Modules

The HP 83550-series millimeter-wave source modules provide wide millimeter-wave test signals from 26.5 to 60 GHz when driven by 11 to 20 GHz microwave sources. The source modules offer internally-leveled high output power, full waveguide-band frequency coverage, and frequency accuracy and resolution proportional to the driving microwave source.

As shown in the diagram, most HP microwave sources can serve as microwave drivers for the source modules via the HP 8349B amplifier. Users of the HP 8350B sweeper can also choose to drive the source modules directly via the HP 83550A 8.0 to 20.0 GHz RF plug-in.

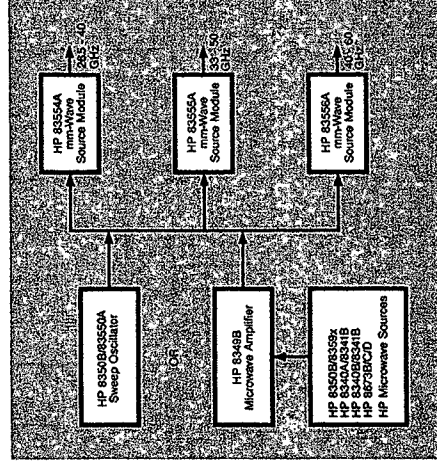

HP 83550-Series Millimeter-Wave Source Modules Summary

HP Model Number	Frequency Range (GHz)	Levelled Output Power
83554A	26.5 - 40.0	5 mW
83555A	33.0 - 50.0	2 mW
83556A	40.0 - 60.0	2 mW

Reference Literature

Title	Subject	HP Literature No.
—	HP 83550-Series Millimeter-Wave Source Modules Data Sheet	5954-1620

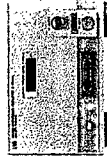

HP 8349B Microwave Amplifier

The HP 8349B is a Class A instrumentation amplifier of advanced GaAs FET design that delivers > +20 dBm of output power with > 15 dB of gain and < 13 dB typical noise figure across a 2.0 to 18.6 GHz frequency range and > +18 dBm of output power with > 13 dB of gain from 18.6 to 20.0 GHz. Externally-leveled operations are greatly simplified by the built-in directional detector of the HP 8349B. The HP 8349B also combines with most HP microwave sources to form the microwave driver for HP's 83550-series millimeter-wave source modules.

HP 8349B Microwave Amplifier

Reference Literature

Title*	Subject	HP Literature No.
—	HP 8349B microwave amplifier Data Sheet	5954-1616
—	Microwaves & RF article reprint — "Broadband Amplifier Aids Test Equipment"	5953-8895
PN 8349-1	Achieving Calibrated Output Power with the HP 8350 Sweep Oscillator/8349 Broadband Amplifier Combination	5954-1616
AN 327-1	Extended Dynamic Range of Scalar Truncation Measurements Using the HP 8757A, HP 8756A, and HP 8755C Scalar Network Analyzers	5953-8882

*PG = Programming note
PN = Product note
AN = Application note

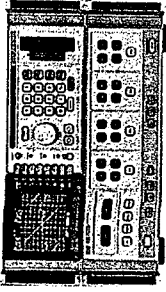

Complementary Equipment

HP 8510 Network Analyzer
The HP 8510 network analyzer is capable of making error-corrected magnitude, phase and group delay measurements in real time from 45 MHz to 100 GHz. The HP 8340, 8341 and 8350B sweepers are designed to work with the HP 8510 system. Without an external computer, the HP 8510 acts as the system controller for the sweeper and other accessories.

When using the HP 8350B Sweep Oscillator, the HP 83500 series plug-ins are the only ones compatible with the HP 8510 system.

For 8350A/B compatibility with the HP 8510 please consult the back page of this document.

HP 8757 Scalar Network Analyzers
The HP 8757A scalar network analyzer has a built-in normalizer and complete HP-IB programmability to measure insertion loss, gain, return loss, and absolute power quickly and accurately. Without an external controller, it can act as the system controller for the HP 8340, 8341, or HP 8350B sweepers. The HP 8757A has such features as a large nine-inch display, AC/DC detection modes, built-in limit testing, adaptive calibration, and an n-dB cursor search.

HP 86220A, 86241A, and 86260A/B/C plug-ins will require the HP 11665B modulator to work with the HP 8757A when operated in AC detection mode.

For HP 8350A/B compatibility with the HP 8757 please consult the back page of this document.

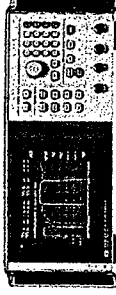

HP 5343A Microwave Frequency Counter

The HP 5343A Microwave Frequency Counter operates over a 500 MHz to 26.5 GHz frequency range. In addition, the HP 5343A has the capability of "handshaking" with the HP 8350 to count, start, stop and marker frequencies while sweeping.

HP 5343A interface cables:
Permit the HP 8350 to interface with the HP 5343A microwave frequency counter for making frequency measurements while in sweep mode (order HP 8350 option 803, or HP p/n 08350-60039 and 08350-60040).

HP 8970B Noise Figure Meter
When combined with the HP 8970B Noise Figure Meter, the HP 346A/B/C Noise Source, and a suitable mixer, the HP 8340, the HP 8341 or the HP 8350 and an HP 83500 or HP 86200 series plug-in can be used as the local oscillator to make noise figure measurements on devices from 1.5 to 26.5 GHz. The HP 8970B can step the sweeper across the frequency range of interest via HP-IB without the use of an external controller.

HP 8971B Noise Figure Test Set:
Combines all of the components necessary for microwave down-conversion into one box. The HP 8971B, used with the HP 8970B and an external synthesized local oscillator such as the HP 8340B or 8341B, allows convenient and repeatable noise figure measurements.

Network Analyzer Systems and Source Compatibility

HP 8350A/B sources with HP 8510A/B, HP 8757A, HP 8756A compatibility matrix for network analyzer systems with both firmware revision and hardware assembly requirements. Rev numbers refer to compatible firmware revisions, and the "A" numbers refer to hardware assembly numbers. Kit numbers are indicated in bold type and include the latest revision firmware and/or board assemblies as applicable.

Instrument	Firmware-Hardware Reqs. for use with the HP 8510A/B	Firmware-Hardware Reqs. for use with the HP 8757A	Firmware-Hardware Reqs. for use with the HP 8757A
HP 8350A	Rev 6, 7 (see note 4) AS 08350-60065 AS 08350-60077 AS 08350-60086 AS 08350-60100 08350-60100	Rev 3, 6, 7 (see note 4) AS 08350-60065 AS 08350-60077 AS 08350-60086 AS 08350-60100	Rev 3, 6, 7 (see note 4) AS 08350-60065 AS 08350-60077 AS 08350-60086 AS 08350-60100
HP 8350B	Rev 6, 7, 08350-60101	Rev 3, 6, 7, 08350-60101	Rev 3, 6, 7, 08350-60101
HP 83522A	Rev 6 83525-60074	Rev 3, 6 83525-60074	Rev 3, 6 83525-60074
HP 83525A	Rev 6 83525-60074	Rev 3, 6 83525-60074	Rev 3, 6 83525-60074
HP 83525B	Rev 6 83525-60074	Rev 3, 6 83525-60074	Rev 3, 6 83525-60074
HP 83540A	Rev 6 83525-60074	Rev 3, 6 83525-60074	Rev 3, 6 83525-60074
HP 83540B	Rev 6 83525-60074	Rev 3, 6 83525-60074	Rev 3, 6 83525-60074
HP 83545A	Rev 6 83525-60074	Rev 3, 6 83525-60074	Rev 3, 6 83525-60074
HP 83550A	Rev 6 83550-60041	Rev 3, 6 83550-60041	Rev 3, 6 83550-60041
HP 83570A	Rev 6 83572-60074	Rev 3, 6 83572-60074	Rev 3, 6 83572-60074
HP 83572A	AG 83572-60051 83572-60053	Rev 6 83572-60074	Rev 6 83572-60074
HP 83572B	Rev 6 83572-60074	Rev 6 83572-60074	Rev 6 83572-60074
HP 83590A	Rev 7, 8, 9 83590-60074	Rev 6, 7, 8, 9 83590-60074	Rev 6, 7, 8, 9 83590-60074
HP 83592A	Rev 7, 8, 9 83592-60074	Rev 6, 7, 8, 9 83592-60074	Rev 6, 7, 8, 9 83592-60074
HP 83592B	Rev 7, 8, 9 83592-60100	Rev 6, 7, 8, 9 83592-60100	Rev 6, 7, 8, 9 83592-60100
HP 83592C	Rev 7, 8, 9 83592-60102	Rev 6, 7, 8, 9 83592-60102	Rev 6, 7, 8, 9 83592-60102
HP 83594A	Rev 7, 8, 9 83594-60074	Rev 6, 7, 8, 9 83594-60074	Rev 6, 7, 8, 9 83594-60074
HP 83595A	Rev 7, 8, 9 83595-60074	Rev 6, 7, 8, 9 83595-60074	Rev 6, 7, 8, 9 83595-60074

- NOTES:
- Revision numbers can be determined as follows: Mainframe [SHIFT] [4] [9] RF Plug-in [SHIFT] [9] [9]
 - Service notes are included in all kits and provide modification, description and installation/adjustment procedures.
 - If a kit is not indicated, the board assembly can be ordered independently and does not require a service note.
 - The latest firmware revision is included in the hardware retrofit kit 08350-60100 for the HP 8350A.

For more information, call your local HP sales office listed in your telephone directory.



Date Subject to Change
March 1, 1986
Printed in U.S.A.
5954-4350

HP 8340, 8350, 8620 Series Swept Microwave Sources 10 MHz to 60 GHz

Product line summary

- NEW Lower HP 8340 Series Prices
- NEW 10 MHz to 40 GHz RF Sweeper Plug-in

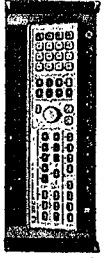

HP 8340B/8341B Synthesized Sweepers

The HP 8340B and 8341B Synthesized Sweepers generate synthesized output frequencies from 10 MHz to 26.5 GHz and 10 MHz to 20 GHz respectively. Their broadband coverage, combined with a high-performance pulse modulator, de-coupled AM, FM, and extremely high frequency resolution (1 to 4 Hz), makes them an excellent choice for many signal simulation applications. Now a new 1 Hz frequency resolution option allows you to tailor the HP 8340B for only the performance you require while making it a better value. The HP 8341B option 003 features < -50 dBc of harmonic and subharmonic suppression from 1.4 to 20 GHz for those applications that require excellent harmonic performance. The versatility of the HP 8340B and 8341B as both a synthesizer and a sweeper, combined with complete programmability, makes them outstanding sources for many network analyzer and automatic test systems.

HP 11877A Test Software for the HP 8340/8341 Series
The HP 11877A test software reduces the test time of the HP 8340/8341 series by greater than 10 hours and accomplishes 90% of the performance tests required to fully calibrate the instrument. In addition, it provides test results in tabular or graphic form. This capability allows you to save valuable cal lab time and resources.

- HP 8340B Synthesized Sweeper (0.01-26.5 GHz)
Option 001 (front panel RF output without attenuator)
Option 004 (rear panel RF output with attenuator)
Option 005 (rear panel RF output without attenuator)
Option 008 (1 Hz frequency resolution)
HP 8341B Synthesized Sweeper (0.01-20 GHz)
Option 003 (low harmonics)
Option 004 (rear panel RF output with attenuator)
HP 11877A Test Software
Option 042 (5.25" double-sided disc)
Option 044 (3.5" single-sided disc)
Option 045 (3.5" double-sided disc)

Reference Literature

Title*	Subject	HP Literature No.
HP 8340B/8341B Synthesized Sweeper Data Sheet		5954-1581
HP 8340B Synthesized Sweeper Flyer		5954-8383
Quick Reference Guide for the HP 8340A Synthesized Sweeper		5953-8877
Introductory Operating Guide for the HP 8340A/8341A Synthesized Sweepers with the HP 9000 Series 200/300 Desktop Computers (BASIC)		5954-1563
Increasing the Frequency Switching Speed on the HP 8340A Synthesized Sweeper		5953-8870
Generating Phase Coherent Microwave Signals with the HP 8340 and 8341 Synthesized Sweepers		5954-1595
Typical Performance of the HP 8340 and 8341 Synthesized Sweepers		5954-8389
Reduced Harmonic Distortion Using the Integra TMS-1800H Tracking Filter with the HP 8340A Synthesized Sweeper		5952-8343
Microwave Noise Figure Measurements Using the HP 8340 or 8341 Synthesized Sweeper with the HP 8970A Noise Figure Meter		5954-4345
Spectral Purity Characteristics of HP Microwave Signal Sources		5953-8349

*FC = Programming note
PN = Product note
AN = Application note

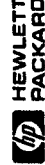

MILLIMETER-WAVE SYSTEM COMPATIBILITY

HP 8340 SERIES / HP 83590 SERIES

0.5V/GHz MODIFICATION

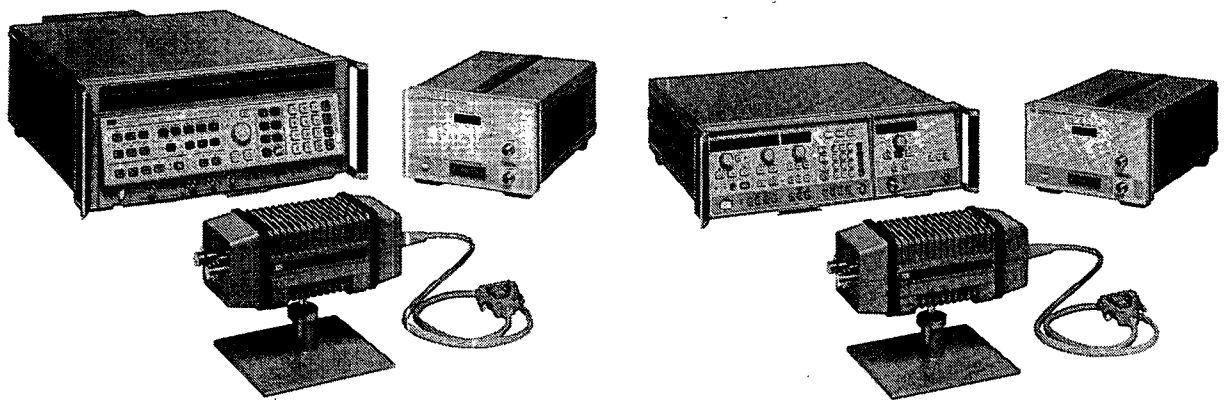

HP Part No. 83554-90016
Printed: MARCH 1986



For more information, call your local HP sales office listed in the telephone directory white pages. Ask for the Electronic Instruments Department. Or write to Hewlett-Packard: **U.S.A.** - P. O. Box 10301, Palo Alto, CA 94303-0690. **Europe** - P.O. Box 999, 1180 AZ Amstelveen, The Netherlands. **Canada** - 6877 Goreway Drive, Mississauga L4V 1M8, Ontario. **Japan** - Yokogawa-Hewlett-Packard Ltd., 3-29-21, Takaide-Higashi, Suginami-ku, Tokyo 168. **Elsewhere** in the world, write to Hewlett-Packard Intercontinental, 3495 Deer Creek Road, Palo Alto, CA 94304.

Printed in U.S.A.

NETWORKS MEASUREMENTS DIVISION SWEEPERS 0.5V/GHz MODIFICATIONS

Description

The HP 83550 Series millimeter-wave source modules require 0.5V/GHz output from the HP 8340A/41A synthesized sweepers and the HP 83590 Series RF plug-ins. The 0.5V/GHz output properly shapes the bias voltages for the multiplier diodes and amplifier internal to the HP 83550 Series millimeter-wave source modules. The following instructions are provided in order to modify your instruments for millimeter-wave operation.

HP 8340A/41A Synthesized Sweeper

The HP 8340A/41A 1.0V/GHz output can be modified to provide 0.5V/GHz by clipping two jumpers (W1, W2) on the A28 SYTM board assembly. Refer to the following figures for the A28 board assembly and jumper locations. Remove the A28 board assembly from the instrument and clip the two jumpers. Ensure the rear panel output is approximately 0.5V/GHz using a DVM.

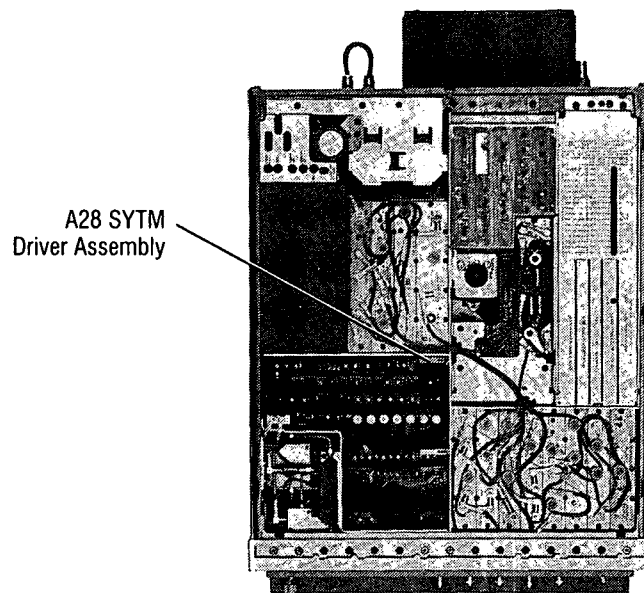

Figure 1. A28 SYTM Driver Assembly Location

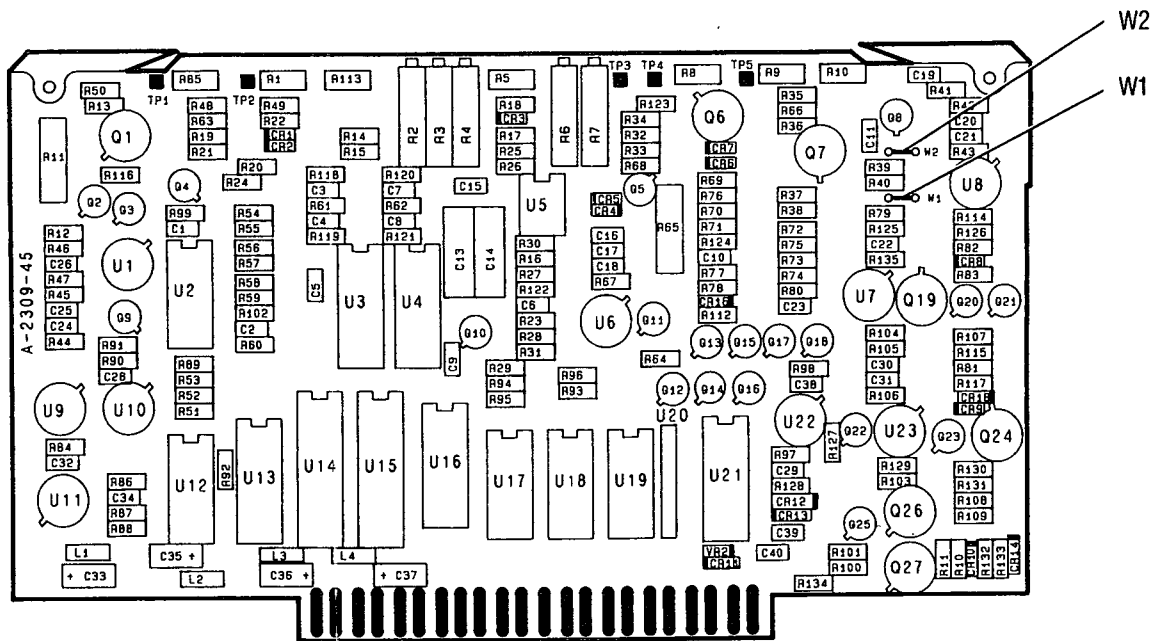

Figure 2. A28 SYTM Driver Assembly Component Locations

HP 83590 Series RF plug-ins

The HP 83590 Series RF plug-ins with serial prefix 2602A and below can be modified to provide 0.5V/GHz by replacing three resistors on the A2 board assembly. If the serial prefix is above 2602A, the frequency reference (0.5V or 1.0V/GHz) is switch selectable. Refer to the following figures for the A2 assembly and components location diagrams. Remove the A2 board assembly from the instrument and replace the required components as follows:

- A2R10 - Replace with HP Part Number 0757-0289, 13.3 KOhm 1.0%
- A2R11 - Replace with HP Part Number 0757-0447, 16.2 KOhm 1.0%
- A2R28 - Replace with HP Part Number 8159-0005, Jumper

Install the label provided (HP Part Number 83595-80013) on the rear panel of the instrument. Ensure the rear panel output is approximately 0.5V/GHz with a DVM.

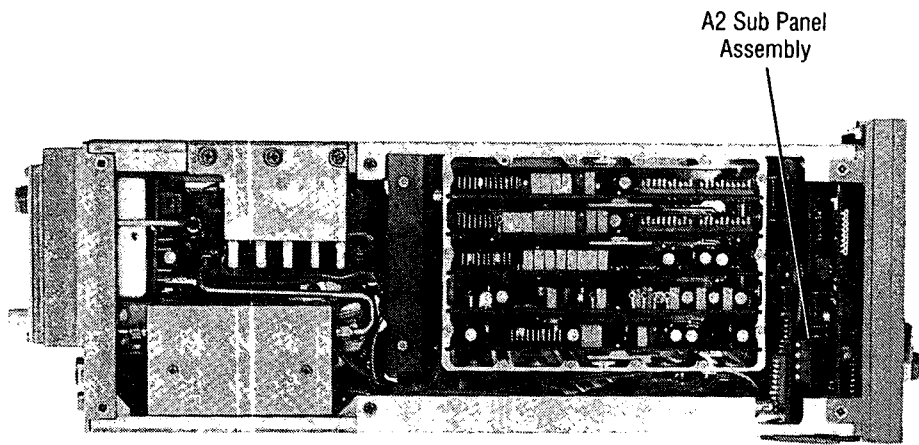

Figure 3. A2 Sub Panel Assembly Location

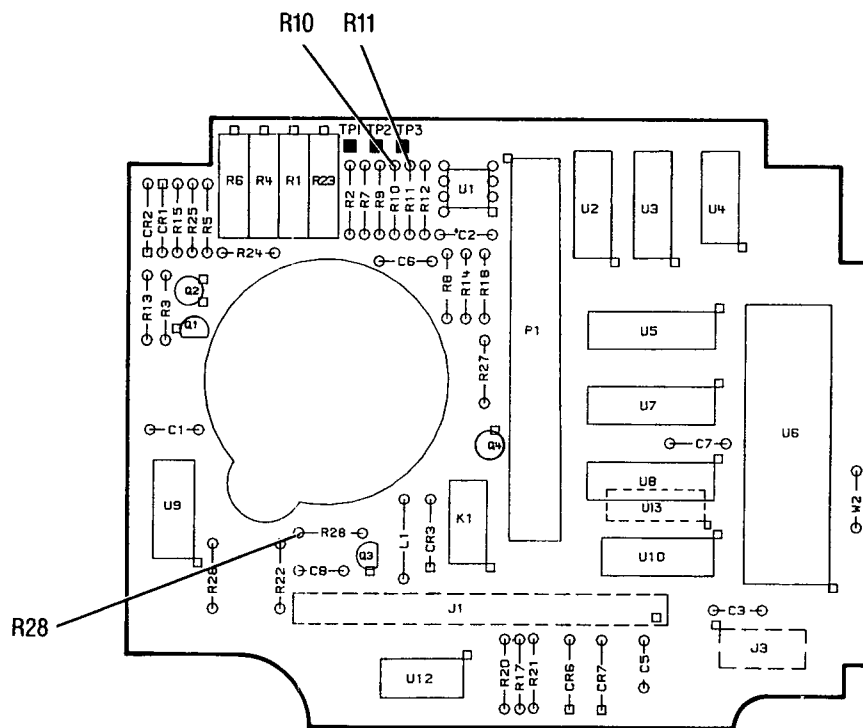

Figure 4. A2 Sub Panel Assembly, Component Locations.



HP 83554A MILLIMETER-WAVE SOURCE MODULE

SERIAL NUMBERS

This manual applies directly to HP 83554A Millimeter-wave source modules having serial prefix 2612A.

For additional information about serial numbers, refer to INSTRUMENTS COVERED BY MANUAL in System General Information.

©Copyright HEWLETT-PACKARD COMPANY 1986
1400 FOUNTAINGROVE PARKWAY, SANTA ROSA, CA 95401 U.S.A.

MANUAL PART NO. 83554-90001
Microfiche Part Number 83554-90002

Printed: APRIL 1986



**HEWLETT
PACKARD**

SAFETY CONSIDERATIONS

GENERAL

This product and related documentation must be reviewed for familiarization with safety markings and instructions before operation. This product has been designed and tested in accordance with international standards.



The CAUTION sign denotes a hazard. It calls attention to an operating procedure, practice, or the like, which, if not correctly performed or adhered to, could result in damage to or destruction of part or all of the product. Do not proceed beyond a CAUTION sign until the indicated conditions are fully understood and met.

SAFETY SYMBOLS



Instruction manual symbol: the product will be marked with this symbol when it is necessary for the user to refer to the instruction manual (refer to Table of Contents).



Indicates hazardous voltages.



Indicates earth (ground) terminal.

WARNING

The WARNING sign denotes a hazard. It calls attention to a procedure, practice, or the like, which, if not correctly performed or adhered to, could result in personal injury. Do not proceed beyond a WARNING sign until the indicated conditions are fully understood and met.

BEFORE APPLYING POWER

Verify that the product is configured to match the available main power source per the input power configuration instructions provided in this manual.

If this product is to be energized via an auto-transformer make sure the common terminal is connected to the neutral (grounded side of the mains supply).

SERVICING

WARNING

Any servicing, adjustment, maintenance, or repair of this product must be performed only by qualified personnel.

Adjustments described in this manual may be performed with power supplied to the product while protective covers are removed. Energy available at many points may, if contacted, result in personal injury.

Capacitors inside this product may still be charged even when disconnected from their power source.

To avoid a fire hazard, only fuses with the required current rating and of the specified type (normal blow, time delay, etc.) are to be used for replacement.

TABLE OF CONTENTS

SYSTEM GENERAL INFORMATION

INTRODUCTION	1
SPECIFICATIONS	1
INSTRUMENTS COVERED BY MANUAL	2
SYSTEMS COVERED BY MANUAL	2
SYSTEM DESCRIPTIONS	3
SYSTEM COMPONENTS AVAILABLE	3
Accessories	3
COMPLETE MEASUREMENT SYSTEMS	7
Millimeter-wave Vector Network Analysis	7
Millimeter-wave Scalar Network Analysis	7
Signal Analysis	8
Reference Literature	9
SAFETY CONSIDERATIONS	10
General	10
Safety Symbols	10
SITE PREPARATION	10
Introduction	10
Site Selection and Site Preparation	10
Receiving Shipment and Initial Inspection	11
SYSTEM INSTALLATION	13
Introduction	13
Installation	15
Storage and Shipment	15
MANUAL CHANGES	17

SOURCE SYSTEM GUIDES

INTRODUCTION	1
RECOMMENDED TEST EQUIPMENT	1
SPECIFICATIONS	1
OPERATION	1
PERFORMANCE TESTS	1
SYSTEM LEVEL TROUBLESHOOTING	2

HP 83550A SOURCE SYSTEM GUIDE

INTRODUCTION	1
SYSTEM DESCRIPTION	1
SYSTEM SPECIFICATIONS	2
OPERATION	3
INTRODUCTION	3
FREQUENCY CONTROL	3
POWER LEVEL CONTROL	4
POWER LEVELING	4
System Leveling	4
External Crystal Detector Leveling	4
External Power Meter Leveling	5

MODULATION	5
Frequency Modulation	6
Amplitude Modulation	6
Pulse Modulation	6
OPERATOR'S CHECK	7
DESCRIPTION	7
EQUIPMENT	7
PROCEDURE	8
SYSTEM PERFORMANCE TESTS	13
INTRODUCTION	13
EQUIPMENT REQUIRED	13
OPERATION VERIFICATION	13
TEST RECORD	13
FREQUENCY CHARACTERISTICS	14
MODULATION CHARACTERISTICS	14
SYSTEM HARMONICS	15
Specification	15
Description	15
Equipment	15
Procedure	16
TROUBLESHOOTING	20
Specification Failures	20
Error Codes	20
Troubleshooting System Harmonics	23

HP 83590 SERIES SOURCE SYSTEM GUIDE

INTRODUCTION	1
SYSTEM DESCRIPTION	1
SYSTEM SPECIFICATIONS	2
OPERATION	3
INTRODUCTION	3
FREQUENCY CONTROL	4
POWER LEVEL CONTROL	4
POWER LEVELING	5
System Leveling	5
External Crystal Detector Leveling	5
External Power Meter Leveling	6
MODULATION	7
Frequency Modulation	7
Amplitude Modulation	8
Pulse Modulation	8
OPERATING SUGGESTIONS	9
OPERATOR'S CHECK	11
DESCRIPTION	11
EQUIPMENT	11
PROCEDURE	12

SYSTEM PERFORMANCE TESTS	15
INTRODUCTION	15
EQUIPMENT REQUIRED	15
OPERATION VERIFICATION	15
TEST RECORD	15
FREQUENCY CHARACTERISTICS	16
MODULATION CHARACTERISTICS	16
SYSTEM HARMONICS	17
Specification	17
Description	17
Equipment	17
Procedure	18
TROUBLESHOOTING	23
Specification Failures	23
Troubleshooting System Harmonics	23

**HP 8340A/41A SERIES
SOURCE SYSTEM GUIDE**

INTRODUCTION	1
SYSTEM DESCRIPTION	1
SYSTEM SPECIFICATIONS	2
OPERATION	3
INTRODUCTION	3
FREQUENCY CONTROL	3
POWER LEVEL CONTROL	4
POWER LEVELING	4
System Leveling	4
External Crystal Detector Leveling	5
External Power Meter Leveling	5
MODULATION	6
Amplitude Modulation	6
Pulse Modulation	7
OPERATING SUGGESTIONS	7
OPERATOR'S CHECK	9
DESCRIPTION	9
EQUIPMENT	9
PROCEDURE	10
SYSTEM PERFORMANCE TESTS	13
INTRODUCTION	13
EQUIPMENT REQUIRED	13
OPERATION VERIFICATION	13
TEST RECORD	13
FREQUENCY CHARACTERISTICS	14
MODULATION CHARACTERISTICS	14
SYSTEM HARMONICS	15
Specification	15
Description	15
Equipment	15
Procedure	16
TROUBLESHOOTING	21
Specification Failures	21
Troubleshooting System Harmonics	21

INTRODUCTION	21
Specification Failures	21
Troubleshooting System Harmonics	21

**HP 8670 SERIES
SOURCE SYSTEM GUIDE**

INTRODUCTION	1
SYSTEM DESCRIPTION	1
SYSTEM SPECIFICATIONS	2
OPERATION	3
INTRODUCTION	3
FREQUENCY CONTROL	4
POWER LEVEL CONTROL	4
POWER LEVELING	4
System Leveling	4
External Crystal Detector Leveling	5
External Power Meter Leveling	5
MODULATION	6
Frequency Modulation	6
Amplitude Modulation	7
Pulse Modulation	7
OPERATOR'S CHECK	9
DESCRIPTION	9
EQUIPMENT	9
PROCEDURE	10
SYSTEM PERFORMANCE TESTS	13
INTRODUCTION	13
EQUIPMENT REQUIRED	13
OPERATION VERIFICATION	13
TEST RECORD	13
FREQUENCY CHARACTERISTICS	14
MODULATION CHARACTERISTICS	14
SYSTEM HARMONICS	15
Specification	15
Description	15
Equipment	15
Procedure	16
TROUBLESHOOTING	21
Specification Failures	21
Troubleshooting System Harmonics	21

SPECIFICATIONS AND SERVICE

INTRODUCTION	1
SPECIFICATIONS	1
DESCRIPTION	3
EQUIPMENT REQUIRED BUT NOT SUPPLIED	3
RECOMMENDED TEST EQUIPMENT	3
INITIAL INSPECTION	4

MATING CONNECTORS	4	HARMONIC SPURIOUS TEST	22
PREPARATION FOR USE	4	Specification	22
SOURCE MODULE PERFORMANCE TESTS	7	Description	22
INTRODUCTION	7	Equipment	24
EQUIPMENT REQUIRED	7	Procedure	24
OPERATION VERIFICATION	7	SERVICE	31
TEST RECORD	8	INTRODUCTION	31
CALIBRATION CYCLE	8	SAFETY CONSIDERATIONS	31
MAXIMUM LEVELED POWER TEST	9	SERVICE PROCEDURE	31
Specification	9	ADJUSTMENTS	32
Description	9	THEORY OF OPERATION	33
Equipment	9	Introduction	33
Procedure	10	Amplifier/Bias Assembly	33
POWER LEVEL FLATNESS TEST	11	Multiplier/Bias Assembly	34
Specification	11	Interface Assembly	34
Description	11	Power Supplies and Grounds	35
Equipment	11	Disassembly Procedure	35
Procedure	12	TROUBLESHOOTING	36
POWER LEVEL ACCURACY TEST	13	Introduction	36
Specification	13	Operational Checks	36
Description	13	Caution Notes	37
Equipment	13	Recommended Test Equipment	37
Procedure	13	Equipment Setup	37
OUTPUT SWR TEST	15	ISOLATION PROCEDURES	38
Specification	15	Power Supplies	38
Description	15	RF Power/Harmonics	38
Equipment	15	Analog Interface	39
Procedure	16	Digital Interface	41
MULTIPLIER HARMONIC TEST	18	REPLACEABLE PARTS	45
Specification	18	Introduction	45
Description	18	Replaceable Parts List	45
Equipment	18	Ordering Information	45
Procedure	19	Exchange Program	46

CERTIFICATION

Hewlett-Packard Company certifies that this product met its published specifications at the time of shipment from the factory. Hewlett-Packard further certifies that its calibration measurements are traceable to the United States National Bureau of Standards, to the extent allowed by the Bureau's calibration facility, and to the calibration facilities of other International Standards Organization members.

WARRANTY

This Hewlett-Packard instrument product is warranted against defects in material and workmanship for a period of one year from date of delivery. During the warranty period, Hewlett-Packard Company will, at its option, either repair or replace products which prove to be defective.

For warranty service or repair, this product must be returned to a service facility designated by HP. Buyer shall prepay shipping charges to HP and HP shall pay shipping charges to return the product to Buyer. However, Buyer shall pay all shipping charges, duties, and taxes for products returned to HP from another country.

HP warrants that its software and firmware designated by HP for use with an instrument will execute its programming instructions when properly installed on that instrument. HP does not warrant that the operation of the instrument, or software, or firmware will be uninterrupted or error free.

LIMITATION OF WARRANTY

The foregoing warranty shall not apply to defects resulting from improper or inadequate maintenance by Buyer, Buyer-supplied software or interfacing, unauthorized modification or misuse, operation outside of the environmental specifications for the product, or improper site preparation or maintenance.

NO OTHER WARRANTY IS EXPRESSED OR IMPLIED. HP SPECIFICALLY DISCLAIMS THE IMPLIED WARRANTIES OF MERCHANTABILITY AND FITNESS FOR A PARTICULAR PURPOSE.

EXCLUSIVE REMEDIES

THE REMEDIES PROVIDED HEREIN ARE BUYER'S SOLE AND EXCLUSIVE REMEDIES. HP SHALL NOT BE LIABLE FOR ANY DIRECT, INDIRECT, SPECIAL, INCIDENTAL, OR CONSEQUENTIAL DAMAGES, WHETHER BASED ON CONTRACT, TORT, OR ANY OTHER LEGAL THEORY.

ASSISTANCE

Product maintenance agreements and other customer assistance agreements are available for Hewlett-Packard products.

For any assistance, contact your nearest Hewlett-Packard Sales and Service Office. Addresses are provided at the back of this manual.

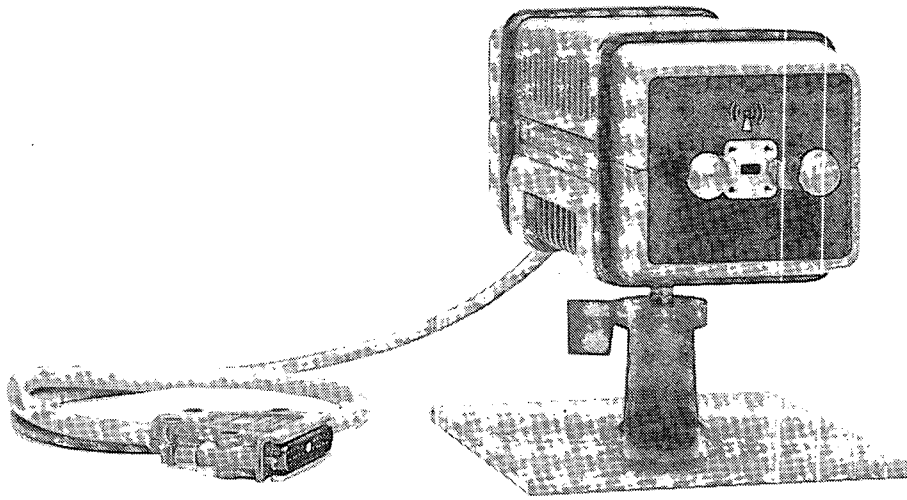

TABLE of CONTENTS

SYSTEM GENERAL INFORMATION

Introduction
Specifications
Instruments Covered by Manual
Systems Covered by Manual
System Descriptions
System Components Available
Complete Measurements Systems
Safety Considerations
Site Preparation
System Installation
Manual Changes

**SOURCE MODULE
HP 83554A**



**CRADLE/STAND
HP Part Number 83556-60010**

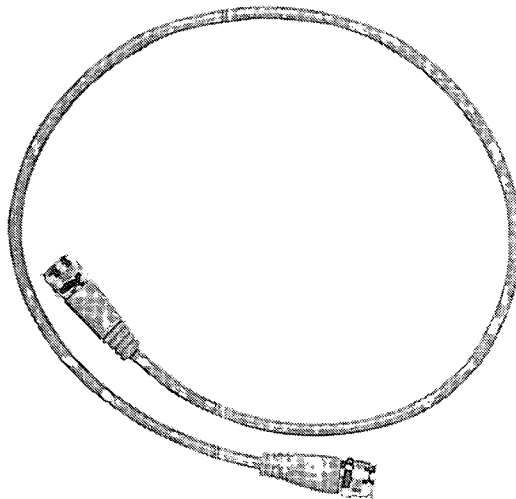

**RF CABLE
HP Part Number 5061-5359**

Figure 1. HP 83554A Source Module and Accessories

System General Information

INTRODUCTION

This system manual contains information required to install, operate, test, adjust and service the Hewlett-Packard 83554A R-band millimeter-wave source module. Figure 1 shows the HP 83554A and its accessories.

Because the HP 83554A source module requires the use of an external signal source to operate, discussion of other HP instruments compatible with the source module is necessary. This manual will only describe the operation of these other instruments as they affect the use of the HP 83554A. For detailed instructions on any of these other HP instruments refer to the individual instrument operating and service manual.

This manual is divided into three major headings which provide the following information:

SYSTEM GENERAL INFORMATION, provides a brief description of the systems covered by this manual, safety considerations, site preparation, system installation, accessories and operating supplies available. All of the information in this portion of the manual applies to overall maintenance of the R-band source module systems.

SOURCE SYSTEM GUIDES, contains the external signal source configurations and the recommended equipment list. This portion is further divided into different source guides. Each source guide contains: connection diagrams, external signal source driven specifications, operating information, performance tests, and system level troubleshooting.

SOURCE MODULE SPECIFICATIONS AND SERVICE, provides information that is source module specific, such as the: description, specifications, equipment required but not supplied, performance tests and service.

SPECIFICATIONS

The HP 83554A source module specifications are divided into two categories:

- External signal source dependent specifications (system specifications).
- Source module specifications independent of signal source.

External signal source dependent specifications are found in each of the source system guides. Refer to the source system guide that describes the source system you are using.

Source module specifications are found under major heading **SOURCE MODULE SPECIFICATIONS AND SERVICE**.

INSTRUMENTS COVERED BY MANUAL

This manual applies specifically to HP 83554A millimeter-wave source modules. Attached to the rear panel of the HP 83554A is a serial number plate. A typical serial number plate is shown in Figure 2. The serial number is in two parts. The first four digits followed by a letter comprise the serial number prefix. The last five digits form the sequential suffix that is unique to each instrument. The content of this manual applies directly to instruments having the same serial number prefix as listed on the title page of this manual under SERIAL NUMBER.

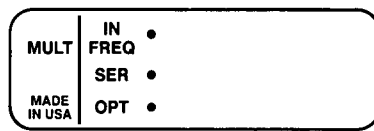

Figure 2. Typical Serial Number Plate

An instrument manufactured after the printing of this manual may have a serial prefix that is not listed on the title page. An unlisted serial prefix indicates that the instrument is different from those documented in this manual. The manual for that instrument is then supplied with a *Manual Changes* supplement that documents the differences.

In addition to change information, the *Manual Changes* supplement contains information for correcting errors in the manual. To keep this manual as current as possible, Hewlett-Packard recommends that you periodically request the latest *Manual Changes* supplement. The supplement for this manual is keyed to the manual's print date and part number (see title page). Complimentary copies of the *Manual Changes* supplement are available upon request from Hewlett-Packard.

For information concerning a serial number prefix that is not listed on the title page of this document or in the *Manual Changes* supplement, contact your nearest Hewlett-Packard Sales/Service Office.

SYSTEMS COVERED BY MANUAL

Different millimeter-wave (mm-wave) source systems are detailed in this manual under major heading SOURCE SYSTEM GUIDES. Refer to the source system guide that describes the source system you are using for specific serial number prefix information.

SYSTEM DESCRIPTIONS

The R-band millimeter-wave source system consists of an HP 83554A together with a microwave source driver (external signal source) that delivers a minimum of +17 dBm of output power to the RF cable input of the source module at frequencies between 13.25 and 20 GHz. Refer to Figure 3 for a block diagram of the different configurations.

A source driver can consist of any of the HP models listed in block A together with the HP 8349B, block B. The HP 8349B provides the block A microwave sources the power amplification and source module interface needed to drive the HP 83554A.

Another mm-wave source system configuration is the HP 83550A/8350, block C, directly driving the HP 83554A. The HP 83550A is a high power RF plug-in with the source module interface designed into the front panel.

For detailed descriptions and connection diagrams of these source systems refer to the source system guides.

SYSTEM COMPONENTS AVAILABLE

A complete R-band mm-wave measurement system is composed of several instruments and accessories called system components. Refer to Table 1 for a list of compatible instruments.

Accessories

Refer to Table 2 for a list of compatible accessories.

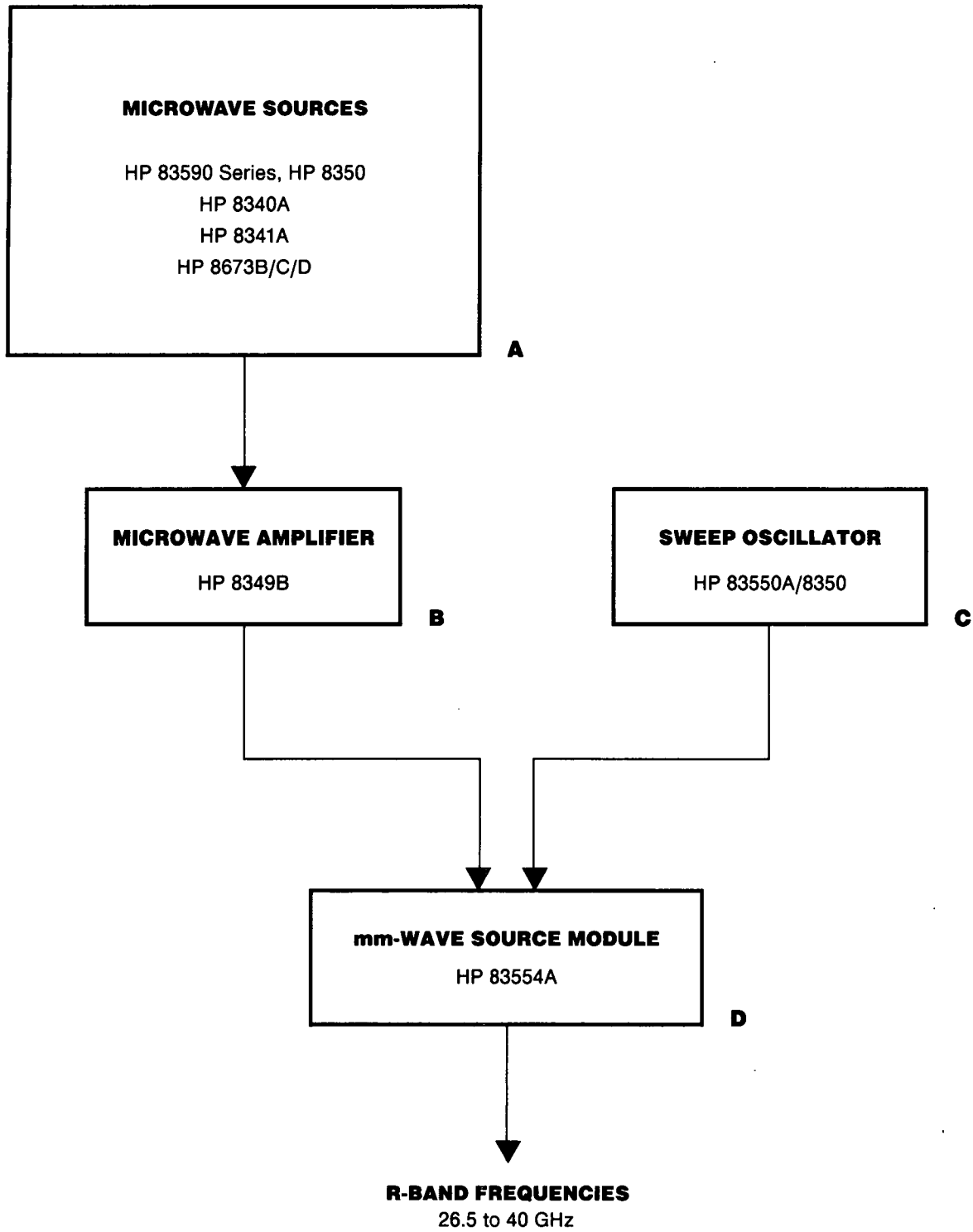

Figure 3. R-Band Millimeter-Wave System Configurations

Table 1. Compatible Source System Instruments (Accessories listed are required for mm-wave applications)

Instrument	Frequency Range (GHz)	Model
SCALAR NETWORK ANALYZER	26.5 to 40	HP 8757A with HP 85025C Detector Adapter or HP 11664C Detector Adapter or HP R85026A Detector or HP R422A Detector
	26.5 to 40	HP 8756A with HP 11664C Detector Adapter or HP 11664D Detector or HP R422A Detector
MICROWAVE COUNTER	10 Hz to 40	HP 5352A
SPECTRUM ANALYZERS	26.5 to 40	HP 8566B with HP 11975A Amplifier and HP 11970A Mixer
	26.5 to 40	HP 71300A with HP 11970A Mixer
	26.5 to 40	HP 8569B with HP 11975A Amplifier and HP 11971A Mixer
	26.5 to 40	HP 8569B Option 003 with HP 11971A Mixer
VECTOR NETWORK ANALYZER	26.5 to 40	HP 8510 with HP R11643A Test Set Kit and HP R11644A Calibration Kit and HP 85100A LO/IF Interface Kit and HP 85129A Software
POWER METERS	26.5 to 40	HP 432A/B with HP R486A Thermistor Mount
	26.5 to 40	HP 436A with HP R8486A Power Sensor
	26.5 to 40	HP 438A with HP R8486A Power Sensor

Table 2. Compatible Source System Accessories

Frequency Range (GHz)	Model
33 to 40	HP RQ292A Waveguide Adapter
26.5 to 40	HP 11516A Waveguide Adapter
26.5 to 40	HP R362A Low-Pass Filter
26.5 to 40	HP R382A Variable Attenuator
26.5 to 40	HP R422A Detector
26.5 to 40	HP R85026A Detector
26.5 to 40	HP 11664D Waveguide Detector
*	HP 85025C Detector Adapter
*	HP 11664C Detector Adapter
26.5 to 40	HP R532A Frequency Meter
26.5 to 40	HP R752A/C/D Directional Coupler (3,10,20 dB)
26.5 to 40	HP R910A Load
26.5 to 40	HP R914B Sliding Load
26.5 to 40	HP R920B Sliding Short
26.5 to 40	HP 11970A Mixer
26.5 to 40	HP 11971A Mixer
26.5 to 40	HP 11548A Waveguide Holder
*	HP 11540A Waveguide Stand

* not frequency dependent

COMPLETE MEASUREMENT SYSTEMS

There are several Hewlett-Packard instruments that can be used as mm-wave receivers. Such receivers include the HP 8510 network analyzer, HP 8757A scalar network analyzer, HP 71000 Series spectrum analyzer, and HP power meters.

Millimeter-wave Vector Network Analysis

The HP 8510 network analyzer can be configured to make high-speed, wide-dynamic range vector measurements at millimeter-wave frequencies. HP Product Note 8510-1A completely documents how to configure systems in waveguide operating over the 26.5 to 40 GHz, 33 to 50 GHz, and 40 to 60 GHz bands. A simplified block diagram for a generic system, applicable to all waveguide bands, is shown in Figure 4.

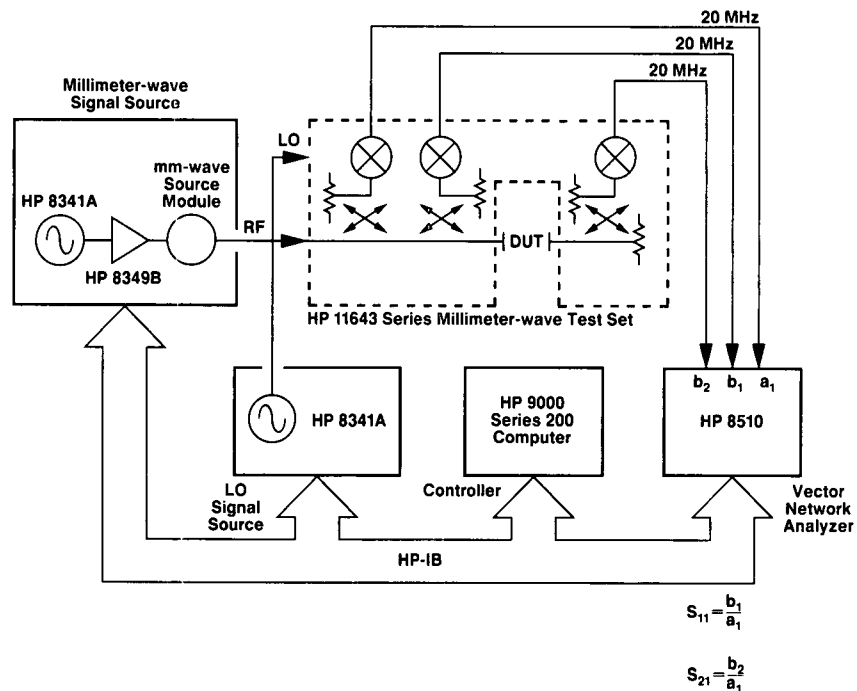

Figure 4. A Simplified Block Diagram of the Millimeter-wave Vector Network Analyzer

Millimeter-wave Scalar Network Analysis

HP millimeter-wave source systems can be used for broadband scalar measurements utilizing the HP 8756A or the 8757A scalar network analyzers. Figure 5 shows a typical system that can make scalar transmission and reflection measurements.

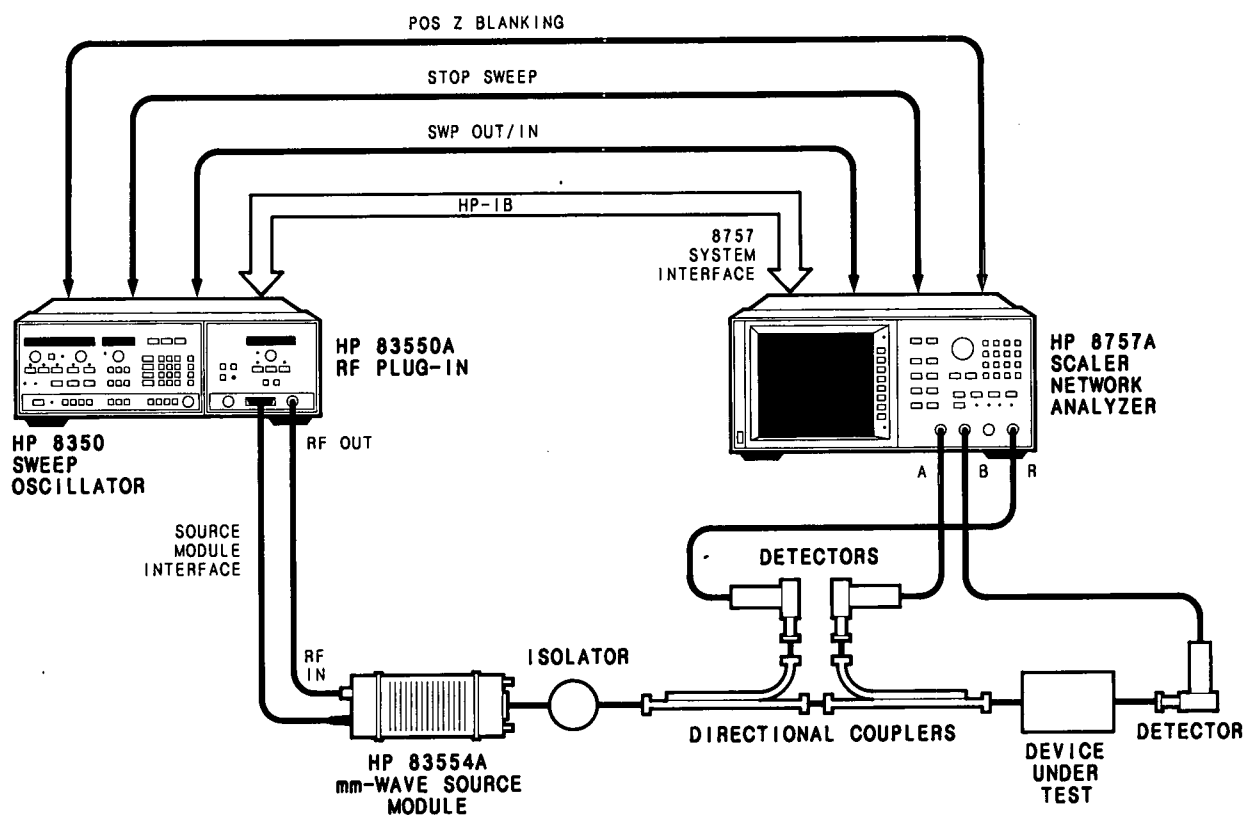

Figure 5. Typical Scalar Transmission and Reflection Millimeter-wave Measurement System

Signal Analysis

Signal analysis measurements can be made using the HP 11970 Series waveguide harmonic mixers for the HP 8566A/B or 8569A/B spectrum analyzers or the HP 71000 Series modular spectrum analyzer to cover waveguide bands from 18 to 110 GHz.

Reference Literature

Data Sheet	<i>HP 8510 network analyzer</i>
HP Product Note 8510-1A	<i>Millimeter-wave Vector Measurements Using the HP 8510A Network Analyzer</i>
Data Sheet	<i>HP 8757A scalar network analyzer</i>
Data Sheet	<i>HP 8756A scalar network analyzer</i>
Data Sheet	<i>HP 11664D waveguide detector</i>
Data Sheet	<i>HP Q85026A and U85026A detectors and 85025C detector adapter</i>
HP Product Note 8756-2	<i>Using the HP 11664C Detector Adapter to Make Millimeter-wave Scalar Measurements</i>
Data Sheet	<i>HP 436A power meter</i>
Data Sheet	<i>HP 438A power meter</i>
Data Sheet	<i>HP 8486A Series power sensor</i>
Data Sheet	<i>HP 71000 Series modular spectrum analyzer</i>
Data Sheet	<i>HP 8566B spectrum analyzer</i>
HP Product Note 8569B-1	<i>Extending the HP 8569B Spectrum Analyzer Above 22 GHz with External Mixers</i>
HP Product Note 8566A-1	<i>Using the HP 8566A Spectrum Analyzer for Signal Analysis Above 22 GHz with External Mixers</i>
HP Product Note 8566A-2	<i>Extending the HP 8566A Spectrum Analyzer Above 22 GHz with External Mixers</i>
HP Operating Note	<i>Operating Guide for the HP 83550 Series Millimeter-wave Source Modules</i>

SAFETY CONSIDERATIONS

General

The individual instruments have been manufactured and tested in accordance with international safety standards. Before operation, this system and related documentation must be reviewed for familiarization with safety marking and instructions. For a listing of safety considerations and symbols used in each system component, refer to individual system component operating and service manuals.

Safety Symbols

A complete listing of the safety symbols used in this manual is given on the page preceding Figure 1. Included are descriptions of symbols that refer the operator to the manual from the instrument, protective Earth ground, frame or chassis terminals, Warning and Caution symbols.

WARNING

This equipment is capable of radiating millimeter-wave energy from the end of unterminated waveguide. Do not look directly into the open end of any waveguide when it is connected to a source of millimeter-wave energy.

Take precautions consistent with ANSI C95.1 - 1982, a study performed by the American National Standards Institute that sets limits for human exposure to microwave and millimeter-wave energy. Copies of this publication are available from:

**American National Standards Institute
1430 Broadway
New York, N. Y. 10018**

SITE PREPARATION

Introduction

This section provides site preparation instructions for the mm-wave source systems. It also includes information about initial inspection and damage claims.

Site Selection and Site Preparation

NOTE: It is the customer's responsibility to select and prepare a site suitable for the mm-wave source system. This includes space, power, and environmental requirements.

Space Requirements. Because the mm-wave source system does not include any tables or mounting racks, a table must be provided. The table should be at least 1.8 metres (6 ft) long, 0.9 metres (3 ft) wide and able to support 136 kg (300 lbs). A table with a power distribution strip along the back edge is preferred.

Power Outlets. A complete mm-wave measurement system (scalar or vector) contains more than the source equipment generating the mm-wave frequencies. Besides the power outlet needed for the source driver (two power outlets, if an HP 8349B is used), add one for each instrument as required, plus three more outlets for service equipment. Provide a local power distribution strip or multiple outlet box for this purpose. The power line should be capable of providing uninterrupted current. Avoid connecting the mm-wave source system to power lines serving equipment that will disturb the line voltage (e.g. air conditioning equipment, electrical welders, copying machines, large motors, etc.). Refer to the individual instrument manuals for power consumption ratings. Add each rating to figure the total power consumption of the system.

Environmental Requirements. The optimum operating environmental conditions are:

Temperature	+25 ± 5°C (+77 ± 9°F)
Humidity	50% to 80%
RFI, EMI Susceptibility	VDE 0730, CISPR Publication 11, and FCC Class B Standards

The mm-wave source system can be operated in environments outside this range with possible degradation in performance and a higher risk of failure. The mm-wave source system can be shipped and stored at temperatures and humidities outside these optimum operating conditions. Refer to the Installation Section of the operating and service manuals of each system component.

Telephone Considerations. A telephone near the mm-wave source system is recommended, especially if on site service is desired.

Receiving Shipment and Initial Inspection

System components are shipped separately, from several different points of origin, and will not arrive together in a single shipment. Every effort is made to coordinate ship dates so that all system components ordered arrive within two weeks of each other.

Before unpacking **any** millimeter-wave source system components, verify that **all** components ordered have arrived by comparing the shipping forms with each carton to the purchase order. Refer to System Components Available for a list of instruments and accessories.

Initial Inspection. Before unpacking any system components, visually inspect all shipping crates and boxes for damage. If there is any evidence of damage or mishandling, notify both the shipping carrier and the nearest Hewlett-Packard office. The carrier is liable for repair and/or replacement of any damaged components.

When unpacking components, retain all packing materials and hardware for future use. If it becomes necessary to reship any of the components, repack them in the original packing materials and shipping cartons. See the paragraph titled Packaging under section heading System Installation for further details.

If an incoming inspection or incoming calibration is to be performed on any system component, do so at this point. Refer to the individual component operating and service manual for instructions.

NOTE: If you already own instruments that will be used in a mm-wave source system, verify the operation and/or calibration before integrating them into the system. Further, certain instruments require modification before they can be used in a mm-wave source system. Refer to the appropriate source system guide for details.

SITE PREPARATION CHECKLIST R-Band Millimeter-Wave Source System

Check each item off as it is completed.

- | | |
|--|--------------------------|
| All Components at Installation Site | <input type="checkbox"/> |
| System Table
Support: 135 kg (300 lb)
Size: 1.8 m (6 ft) x 0.9 m (3 ft) | <input type="checkbox"/> |
| Power Outlets
System: minimum 2
Service: 3 | <input type="checkbox"/> |
| Temperature
$+25 \pm 5^{\circ}\text{C}$ ($+77 \pm 9^{\circ}\text{F}$) | <input type="checkbox"/> |
| Humidity
50% to 80% | <input type="checkbox"/> |
| Telephone | <input type="checkbox"/> |
| Inventory System Components | <input type="checkbox"/> |
| Incoming Inspection/Calibration | <input type="checkbox"/> |
| Verify Calibration of Instruments
(instruments already owned) | <input type="checkbox"/> |

SYSTEM INSTALLATION

Introduction

This section provides installation instructions for the mm-wave source system in general terms only. For specific information on any instrument refer to the individual operating and service manual.

Power Requirements. Each instrument obtains power through its own line voltage cord. The two exceptions are:

- the RF plug-in (when applicable), which receives power from the HP 8350 sweep oscillator main-frame.
- the source module, which receives power from the source (HP 83550A or HP 8349B).



To prevent instrument damage, make the correct line voltage and fuse selection for each system component prior to connecting line power to the system.



Line Voltage and Fuse Selection. Each system component must be set to operate with the available AC line voltage, and have the correct line fuse installed. Because system component fuse values for different line voltage settings are not identical, take care to ensure that the proper voltage range and corresponding fuse is selected. Line voltage ranges and fuse rating for system components are given in Section I of each component manual (and are often specified on the instrument rear panel). The procedure for determining the correct line voltage setting and fuse value is as follows:

1. Determine the available line voltage.
2. Refer to the installation section of each instrument manual. Match the correct line voltage and fuse as specified in the manual to the determined AC line voltage. If the measured AC voltage does not fall within the acceptable limits for any range, an auto transformer must be used between the power source and the mm-wave source system.
3. Change the line voltage selector according to the instructions given in the installation section of each instrument manual.
4. Insert the proper value fuse for the line voltage range selected.

Power Cables. In accordance with international safety standards, each instrument in this mm-wave source system is equipped with a three-wire power cable. When connected to an appropriate power line outlet, the cable grounds the instrument system. Table 3 shows the plug styles available on power cables supplied with HP instruments. The HP part numbers given for the plugs are the part numbers for complete power cables. The type of power cable/plug shipped with the instrument depends upon the country of destination.

System Connections. System connections are discussed in all of the Source System Guides. Refer to the guide that details the source driver you are using.

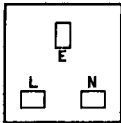
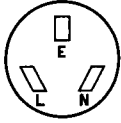
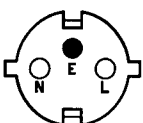
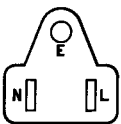
Table 3. AC Power Cables Available

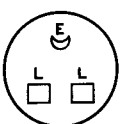
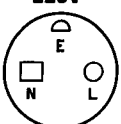
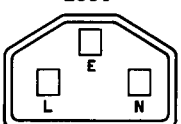
Plug Type ¹	Cable HP Part Number ²	CD ³	Plug Description ²	Cable Length (inches)	Cable Color	For Use in Country
250V 	8120-1351 8120-1703	0 6	Straight BS1363A 90°	90 90	Mint Gray Mint Gray	United Kingdom, Cyprus, Nigeria, Zimbabwe, Singapore
250V 	8120-1369 8120-0696	0 4	Straight ZNSS198/ASC112 90°	79 87	Gray Gray	Australia, New Zealand
250V 	8120-1689 8120-1692	7 2	Straight CEE7-VII 90°	79 79	Mint Gray Mint Gray	East and West Europe, Saudi Arabia, Egypt, Republic of So. Africa, India (unpolarized in many nations)
125V 	8120-1348 8120-1398 8120-1754 8120-1378 8120-1521 8120-1676	5 5 7 1 6 2	Straight NEMA5-15P 90° Straight NEMA5-15P Straight NEMA5-15P 90° Straight NEMA5-15P	80 80 36 80 80 36	Black Black Black Jade Gray Jade Gray Jade Gray	United States, Canada, Japan (100V or 200V), Mexico, Philippines, Taiwan
250V 	8120-2104	3	Straight SEV1011.1959 24507, Type 12	79	Gray	Switzerland
250V 	8120-0698	6	Straight NEMA6-15P			United States, Canada
220V 	8120-1957 8120-2956	2 3	Straight DHCK 107 90°	79 79	Gray Gray	Denmark
250V 	8120-1860	6	Straight CEE22-VI (System Cabinet Use)			

1. E = Earth Ground; L = Line; N = Neutral
2. Part number shown for plug is industry identifier for plug only. Number shown for cable is HP Part Number for complete cable including plug.
3. The Check Digit (CD) is a coded digit that represents the specific combination of numbers used in the HP Part Number. It should be supplied with the HP Part Number when ordering any of the power assemblies listed above, to expedite speedy delivery.

Mating Connectors. Mating connectors for each instrument's externally mounted connections are given in the installation section of the individual operating and service manuals. Given with each mating connector is an HP part number (when available), an industry identification number, and the part number from an alternate source.

Installation

Refer to the SITE PREPARATION CHECKLIST.

1. Place the source at least six inches back from the front edge of the table (install the plug-in if required).
2. Place the source module in its cradle stand. Secure the cradle stand to the source module.
3. Check voltage/fuse selection.
4. Check power cables.
5. Refer to one of the source system guides for a specific source connection diagram.

Storage and Shipment

Each system component has specific environmental limits for storage and shipment. Refer to the installation section of the individual operating and service manual for details. The following are general guidelines that apply to all components.

Environment. The components may be stored or shipped in environments within the following limits:

Temperature: -25°C to $+75^{\circ}\text{C}$.

Humidity: Up to 95%. Provide protection from temperature extremes. Condensation may occur within the component if exposed to temperature extremes or higher humidity levels.

Altitude: Up to 7,620 metres (25,000 feet).

Packaging. Package each system component separately for maximum protection. Containers and materials identical to those used in factory packaging are available through Hewlett-Packard offices. If, however, you choose to package the individual component with commercially available materials, follow these instructions:

1. Wrap the component in heavy paper.
2. Use a strong shipping container. A double-wall carton made out of 159-kg (350-lb) test material is adequate.
3. Use shock-absorbing material, 76 to 102 mm (3 to 4 in) layer, around all sides of the instrument to provide a firm cushion and prevent movement inside the container.
4. Seal the container securely.
5. Mark the shipping container **FRAGILE**.

For more specific packaging instructions pertaining to individual instruments refer to the individual operating and service manual.

Returning for Service. If you are shipping any component to a Hewlett-Packard office or service center please include the following information:

1. Your company name and address.
2. A technical contact person within your company, and their complete phone number.
3. The complete model and serial number of the component (accessories have serial number suffixes only).
4. The type of service required (calibration vs. repair).
5. Any other information that may expedite service.

When making inquiries, either by correspondence or by telephone, please refer to the instrument by model number and full serial number.

Manufacturer's Declaration

NOTE

This is to certify that this product meets the radio frequency interference requirements of Directive FTZ 1046/1984. The German Bundespost has been notified that this equipment was put into circulation and has been granted the right to check the product type for compliance with these requirements.

Note: If test and measurement equipment is operated with unshielded cables and/or used for measurements on open set-ups, the user must insure that under these operating conditions, the radio frequency interference limits are met at the border of his premises.

Model HP 83554A

NOTE

Hiermit wird bescheinigt, dass dieses Gerät/System in Übereinstimmung mit den Bestimmungen von Postverfügung 1046/84 funkentstört ist.

Der Deutschen Bundespost wurde das Inverkehrbringen dieses Gerätes/Systems angezeigt und die Berechtigung zur Überprüfung der Serie auf Einhaltung der Bestimmungen eingeräumt.

Zusatzinformation für Mess- und Testgeräte:

Werden Mess- und Testgeräte mit ungeschirmten Kabeln und/oder in offenen Messaufbauten verwendet, so ist vom Betreiber sicherzustellen, dass die Funk-Entstörbestimmungen unter Betriebsbedingungen an seiner Grundstücksgrenze eingehalten werden.

MANUAL CHANGES

Ordering Manuals/Microfiche

On the title page of this manual is a manual part number and a "microfiche" part number. Both can be used to order extra copies of the manual. Microfiche are 10 x 15 cm (4 x 6 in) microfilm transparencies. Each microfiche contains reduced photocopies of the manual pages. Also included in the microfiche package are the latest manual changes supplement and pertinent service notes.

Each source system guide has its own part number, which appears on the back cover in the lower left hand corner. Use this part number to order extra copies of that particular guide.

HP 83554A SOURCE MODULE

For use with
HP 83550A
HP 8350

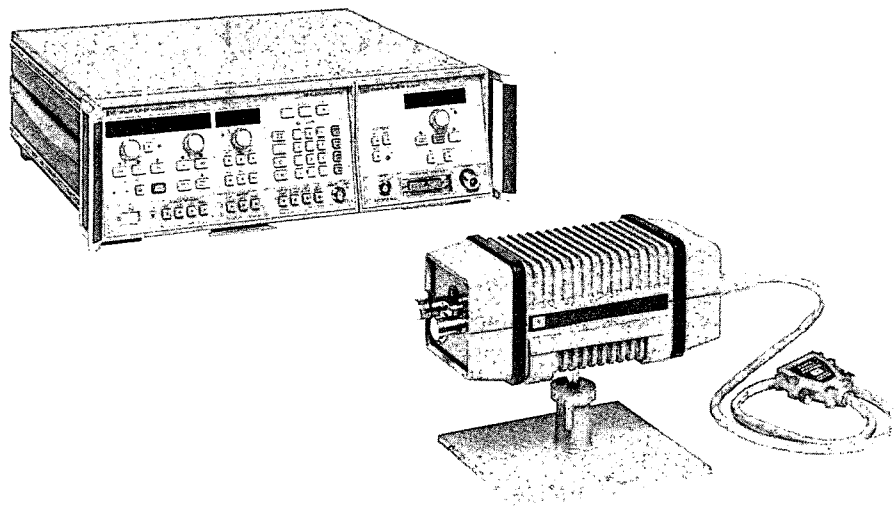

**HEWLETT
PACKARD**

CERTIFICATION

Hewlett-Packard Company certifies that this product met its published specifications at the time of shipment from the factory. Hewlett-Packard further certifies that its calibration measurements are traceable to the United States National Bureau of Standards, to the extent allowed by the Bureau's calibration facility, and to the calibration facilities of other International Standards Organization members.

WARRANTY

This Hewlett-Packard system product is warranted against defects in materials and workmanship for a period corresponding to the individual warranty periods of its component products. Computer and computer peripherals are warranted for a period of 90 days. Instruments are warranted for a period of one year. During the warranty period, Hewlett-Packard Company will, at its option, either repair or replace products which prove to be defective.

Warranty service for products installed by HP and certain other products designated by HP will be performed at Buyer's facility at no charge with HP service travel areas. Outside HP service travel areas, warranty service will be performed at Buyer's facility only upon HP's prior agreement and Buyer shall pay HP's round trip travel expenses. In all other areas, products must be returned to a service facility designated by HP.

For products returned to HP for warranty service, Buyer shall prepay shipping charges to HP and HP shall pay shipping charges to return the product to Buyer. However, Buyer shall pay all shipping charges, duties, and taxes for products returned to HP from another country.

HP warrants that its software and firmware designated by HP for use with an instrument will execute its programming instructions when properly installed on that instrument. HP does not warrant that the operation of the instrument, or software, or firmware will be uninterrupted or error free.

LIMITATION OF WARRANTY

The foregoing warranty shall not apply to defects resulting from improper or inadequate maintenance by Buyer, Buyer-supplied software or interfacing, unauthorized modification or misuse, operation outside of the environmental specifications for the product, or improper site preparation or maintenance.

NO OTHER WARRANTY IS EXPRESSED OR IMPLIED. HP SPECIFICALLY DISCLAIMS THE IMPLIED WARRANTIES OR MERCHANTABILITY AND FITNESS FOR A PARTICULAR PURPOSE.

EXCLUSIVE REMEDIES

THE REMEDIES PROVIDED HEREIN ARE BUYER'S SOLE AND EXCLUSIVE REMEDIES. HP SHALL NOT BE LIABLE FOR ANY DIRECT, INDIRECT, SPECIAL, INCIDENTAL, OR CONSEQUENTIAL DAMAGES, WHETHER BASED ON CONTRACT, TORT, OR ANY OTHER LEGAL THEORY.

ASSISTANCE

Product maintenance agreements and other customer assistance agreements are available for Hewlett-Packard products.

For any assistance, contact your nearest Hewlett-Packard Sales and Service Office. Addresses are provided at the back of this manual.

**HP 83554A
MILLIMETER-WAVE
SOURCE MODULE**

**For use with
HP 83550A
HP 8350**

SERIAL NUMBERS

This manual applies directly to HP 83554A Millimeter-wave source modules having serial prefix 2612A.

For additional information about serial numbers, refer to INSTRUMENTS COVERED BY MANUAL in System General Information.

©Copyright HEWLETT-PACKARD COMPANY 1986
1400 FOUNTAINGROVE PARKWAY, SANTA ROSA, CA 95401 U.S.A.

MANUAL PART NO. 83554-90004
Microfiche Part Number 83554-90011

Printed: APRIL 1986



**HEWLETT
PACKARD**

TABLE of CONTENTS
HP 83550A SOURCE SYSTEM GUIDE

Introduction
System Specifications
Operation
Operator's Check
System Performance Tests
 Introduction
 Frequency Characteristics
 System Harmonics
Troubleshooting

HP 83550A Source System Guide

INTRODUCTION

This source system guide is intended to provide you with mm-wave system operating information for the HP 83550A/8350/83554A system (unless otherwise stated will be hereafter referred to as the HP 83550A/83554A system). It contains an operator's check, connection diagrams, system specifications, system performance tests, and system level troubleshooting. For detailed instructions regarding the operation or troubleshooting of the individual instruments, refer to the instrument's operating and service manual.

SYSTEM DESCRIPTION

The HP 83550A is an 8 to 20 GHz RF plug-in used with the HP 8350 sweep oscillator. It provides a minimum of +17 dBm of internally leveled calibrated output power and a built-in mm-wave source module interface to serve as a direct microwave source driver for the HP 83554A source module.

NOTE: With Option 002 (50 dB programmable attenuator), the HP 83550A may not drive the source module to full specified output power over part of the band (18.6 to 20.0 GHz). Refer to the HP 83550A Operating and Service Manual for detailed specifications.

For proper display accuracy, leveling flatness, and harmonic suppression, the HP 83550A 1.0/0.5V/GHz frequency reference output switch must be set to 0.5V/GHz. For further information, refer to the HP 83550A Operating and Service Manual.

WARNING

This equipment is capable of radiating millimeter-wave energy from the end of unterminated waveguide. Do not look directly into the open end of any waveguide when it is connected to a source of millimeter-wave energy.

Take precautions consistent with ANSI C95.1 - 1982, a study performed by the American National Standards Institute that sets limits for human exposure to microwave and millimeter-wave energy. Copies of this publication are available from:

**American National Standards Institute
1430 Broadway
New York, N. Y. 10018**

SYSTEM SPECIFICATIONS

Table 2-1 provides system specifications for the HP 83550A/83554A system configuration. These are the performance standards against which the system is tested.

Table 2-1. HP 83550A/83554A System Specifications

<p>Frequency Characteristics</p> <p>Range 26.5 to 40.0 GHz</p> <p>Accuracy (25°C +5°C)¹</p> <p> CW Mode ±40 MHz</p> <p>All Sweep Modes</p> <p> (for sweep time > 100 msec) ±100 MHz</p> <p>CW Resolution 52 kHz</p> <p>Stability</p> <p> With Temperature, typically ±2 MHz/°C</p> <p> With 10% Line Voltage Change ±300 kHz</p> <p> With Time (in a 10-minute period)¹ < ±2 MHz</p> <p>Residual FM. Peak (20 Hz to 15 KHz bandwidth),(CW mode) <50 kHz</p> <p>Modulation Characteristics</p> <p>External FM</p> <p>Maximum Deviations for Modulation Frequencies</p> <p> Crossover Coupled</p> <p> DC to 100 Hz ±150 MHz</p> <p> 100 Hz to 6 MHz ±27 MHz</p> <p>Sensitivity</p> <p> FM Mode, typically -40 MHz/V</p> <p> Phase-Lock Mode, typically -12 MHz/V</p>	<p>Modulation Characteristics (Cont'd)</p> <p>External AM</p> <p> Bandwidth, typically DC to 100 kHz</p> <p> Sensitivity, typically 1 dB/V</p> <p>External Pulse Modulation</p> <p> Rise/Fall Time, typically 25 ns</p> <p> Minimum RF Pulse Width</p> <p> System Leveled, typically 1 us</p> <p> System Unleveled, typically 100 ns</p> <p> On/off ratio, typically >60 dB</p> <p> Pulse Repetition Frequency</p> <p> System Leveled 10 Hz to 500 kHz</p> <p> System Unleveled DC Hz to 5 MHz</p> <p>HP 8756A, 8757A</p> <p> AC Detection Mode Compatibility Yes</p> <p>Output Characteristics²</p> <p> System Harmonics >30 dBc</p> <p> Typically >35 dBc</p>
	<p>¹ After one hour warmup at selected CW frequency.</p> <p>² For Output Characteristics, see Source Module Specifications and Service Section.</p>

OPERATION

INTRODUCTION

This section is intended for operators familiar with the HP 83550A. If you are unfamiliar with this system, refer to the Operator's Check at the end of this section for verification of system operation.

In the operation instructions, any instrument setting or function key is defined by the [] symbols around it.

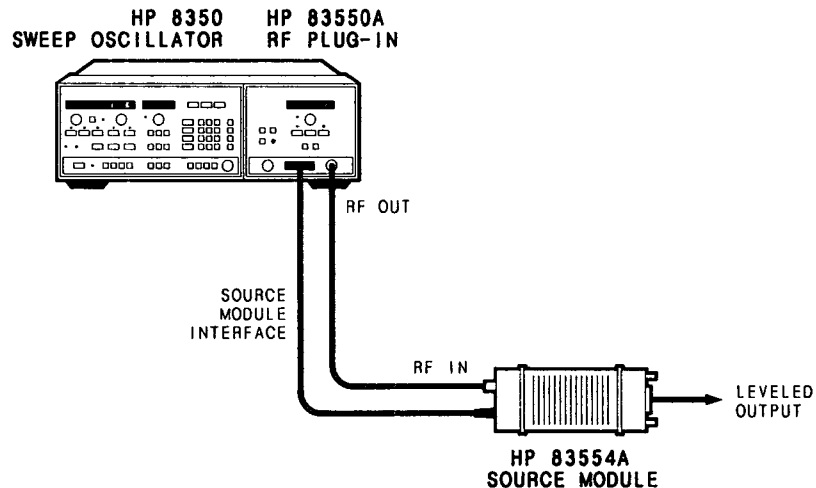

Figure 2-1. HP 83550A/83554A Source System Configuration



Turn HP 8350 ac power OFF before connecting or disconnecting the source module interface cable.

Connect the system as shown in Figure 2-1.

FREQUENCY CONTROL

Turn on the HP 8350 and press [INSTR PRESET]. The HP 8350 will be automatically initialized to the frequency range of the HP 83554A. You can then choose the appropriate mm-wave frequency you desire from the front panel of the HP 8350.

Both the HP 8350 and 83550A have built-in self diagnostic and mm-wave source module related error codes to help the user. These error codes will be displayed on the HP 8350 START frequency or RF plug-in POWER level displays should an error occur. For a complete list of these codes, refer to the section titled TROUBLESHOOTING in this guide.

If the HP 83550A is to be used only as an RF plug-in with a frequency range of 8 to 20 GHz, turn off the system, remove the mm-wave source module, then turn the system on again. Otherwise, the HP 83550A will still perform as if connected to the millimeter-wave source module.

POWER LEVEL CONTROL



Before performing any power level calibrations, ensure that the HP 83550A is not at maximum power.

The RF output power of the mm-wave source module is read on the HP 83550A RF plug-in display in this configuration. The output power is controlled by the Power Level Control on the RF plug-in front panel.

POWER LEVELING

System Leveling

The HP 83550A/83554A system configuration shown in Figure 2-1 provides source module leveled output power with corrected power level flatness. When the HP 83550A INT key is active, a portion of the mm-wave power output is sampled using a directional coupler and detector internal to the mm-wave source module. This signal is applied to the HP 83550A automatic leveling control circuitry (ALC). The source module output level is displayed on the HP 83550A power display.

External Crystal Detector Leveling

Figure 2-2 illustrates a typical crystal detector leveling setup. Set the Leveling mode to [EXT] on the RF plug-in. A portion of the HP 83554A source module output signal is sampled and applied to the HP 83550A external ALC circuit. In this mode there is no correction provided for the coupler and detector flatness characteristics external to the source module. A power meter may be used to measure the source module output power and adjust the HP 83550A front panel CAL so the plug-in displays the approximate correct leveled power. See Figure 2-3 for EXT CAL adjustment location.

Maximum specified power may not be achievable when using an external leveling technique as a result of leveling coupler losses.

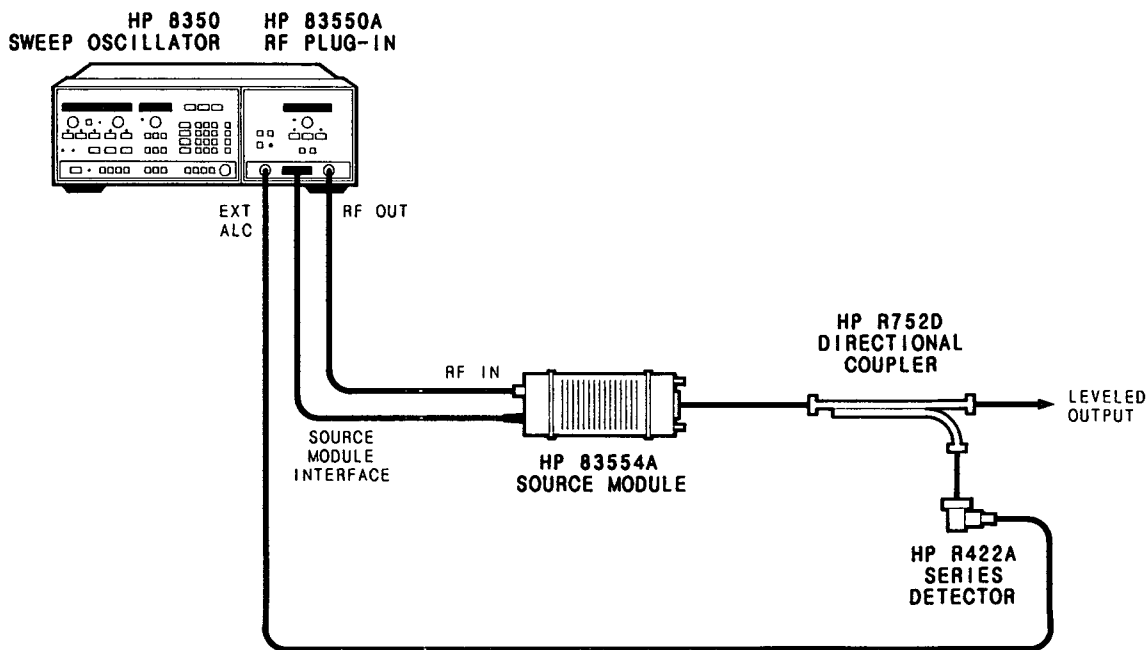

Figure 2-2. External Crystal Detector Leveling at the HP 83554A Output

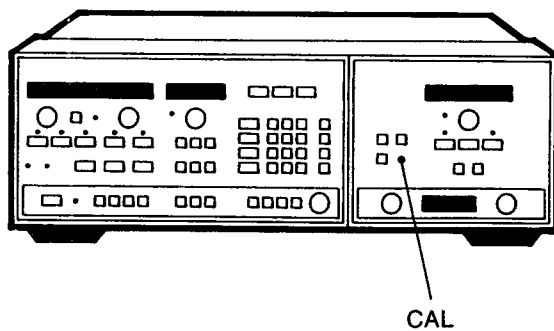

Figure 2-3. EXT CAL Adjustment Location

External Power Meter Leveling

Output power may also be leveled with a power meter and a directional coupler as shown in Figure 2-4. Power meter leveling at the mm-wave source module output is possible using the power meters referenced in Table 1 (System General Information).

Set the ALC mode to [MTR] on the HP 83550A. For best swept accuracy, set the sweep time to 100 seconds when this leveling method is used. A portion of the mm-wave output signal from the source module is coupled/detected and routed to the power meter. The DC voltage from the power meter's recorder output is applied to the HP 83550A ALC input.

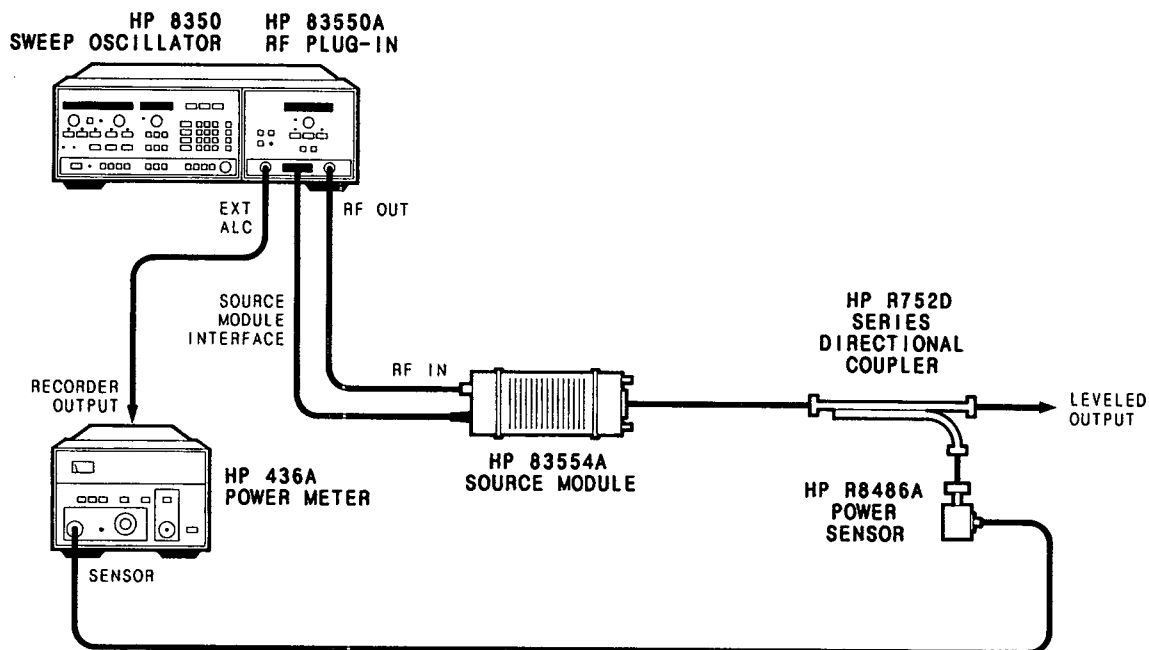

Figure 2-4. External Power Meter Leveling at the HP 83554A Output

MODULATION

For complete specifications on all three modulation modes described below, refer to Table 2-1 (HP 83550A/83554A System Specifications).

Frequency Modulation (FM INPUT Connector on HP 8350)

The HP 83550A/83554A system configuration output signal can be frequency modulated using an external modulating signal applied to the HP 8350 rear panel FM INPUT connector.

The sensitivity and maximum deviations of the HP 83550A are multiplied by a factor of two since the HP 83554A source module is a frequency doubler. The sensitivity of the modulating signal may be set via configuration switch A3S1 on the HP 83550A RF plug-in. The following configuration switch settings override HP 8350 non-volatile memory settings at instrument preset. If the configuration switch is changed, you must press Instrument Preset again to load the memory with the new sensitivity settings.

The following is an example of the HP 83550A RF plug-in configuration switch settings. Refer to the HP 83550A Operating and Service manual for further details. The sensitivity setting for the overall system will be doubled, -12 MHz/V and -40 MHz/V.

Description	A3S1 Switch Number	
	5	6
-6 MHz/V FM Sensitivity	1	1
-20 MHz/V FM Sensitivity	0	X
Cross-over Coupled	X	X

NOTE: 1 = High
0 = Low
X = Don't Care

Amplitude Modulation (AM INPUT Connector on HP 8350)

The AM INPUT provides amplitude changes (up to approximately 13 dB) proportional to the modulating voltage. The sensitivity is typically 1 dB/V. The AM is typically limited to a frequency response of DC to 100 kHz.

Maximum depth of modulation can be achieved by starting at the maximum power, and decreasing down to the minimum power level possible from the source module. For maximum modulation index, the HP 83554A source module should be set to a power level such that the peak of the modulation waveform does not exceed the maximum specified power level.

Pulse Modulation (PULSE IN Connector)

The application of a pulsed or square wave signal to the PULSE IN connector provides a pulse or square wave modulated signal at the output of the HP 83554A. This input provides an ON/OFF power ratio of typically greater than 60 dB. The PULSE IN input is normally at a TTL HIGH (approximately +3 volts DC). When a TTL LOW signal (approximately 0 volts DC) is applied, the source module output signal is turned off.

With system leveled power, pulse repetition rates from 10 Hz to 500 kHz are achievable.

OPERATOR'S CHECK

DESCRIPTION

The following procedure will enable you to verify the proper operation of your HP 83550A/83554A system by determining the system's output power and flatness performance over the R-band frequency range of 26.5 to 40.0 GHz at maximum leveled output power. Maximum leveled output power is split into two specifications across the band, +8.0 dBm (26.5 to 37.2 GHz) and +7.0 dBm (37.2 to 40.0 GHz). Therefore, the subsequent procedure will test the power flatness at both power levels.

EQUIPMENT

Ensure that all the instruments below meet their own performance standards and have been recently calibrated to proper specifications before configuring them into the setup.

RF Signal Source	HP 8350/HP 83550A RF Plug-in
Power Meter	HP 436A
Power Sensor	HP R8486A

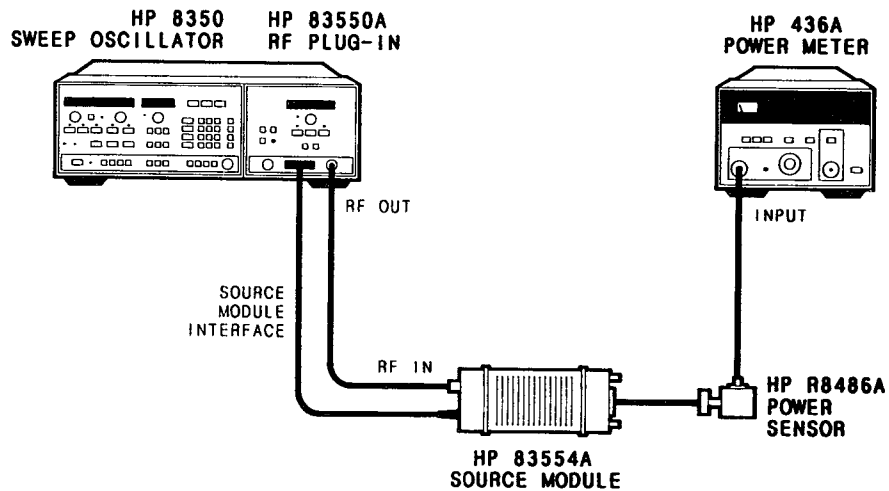

Figure 2-5. System Configuration

PROCEDURE

1. Connect the equipment as shown in Figure 2-5. Do not connect the HP R8486A power sensor to the HP 83554A output.



Turn off the ac power on the HP 8350 prior to connecting or disconnecting from the source module interface connector.

2. Turn on all system components.
3. On the power meter:

Press **[dBm]** mode.

Zero and calibrate the power meter. Set the CAL FACTOR at 100%. The CAL FACTOR will **not** be changed for the rest of the procedure. By leaving the CAL FACTOR set at 100% it ensures testing for worst case errors.

4. On the HP 8350:

Press **[SHIFT] [INSTRUMENT PRESET]**

NOTE: The HP 83550A RF plug-in has built in self diagnostic and source module related error codes to help the user. These error codes are displayed on the HP 8350 START frequency or RF plug-in POWER level displays should an error occur. For a complete list of these codes, refer to the section titled TROUBLESHOOTING in this guide.

Press **[START] [2] [6] [.] [5] [GHz]**

Press **[STOP] [3] [7] [.] [2] [GHz]**

Press **[MAN] SWEEP** and adjust the FREQUENCY/TIME rotary knob for a 26.5 GHz frequency reading.

NOTE: Ensure that the **[MOD]** button is off or it will affect the power level indication on the power meter.

5. On the HP 83550A:

Press **[INT] ALC MODE** to put the system in the system leveled mode.

Press **[POWER LEVEL]**

Adjust the power level rotary knob for a 8.0 dBm reading on the RF plug-in display.

Connect the HP R8486A power sensor to the HP 83554A output

Adjust the power level rotary knob for an 8.0 dBm reading on the HP 436A display.

6. On the HP 8350:

Find the minimum power point between 26.5 GHz and 37.2 GHz by slowly adjusting the FREQUENCY/TIME rotary knob from 26.5 GHz to 37.2 GHz and reading the power meter display. Note at what frequency the minimum power point occurs. See Figure 2-6.

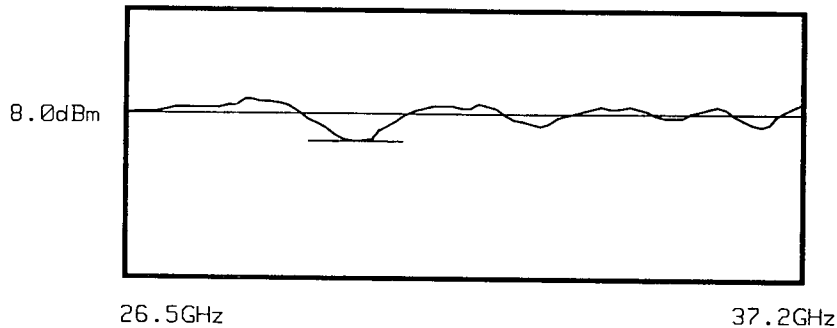

Figure 2-6. Minimum Power Point (26.5 to 37.2 GHz)

Enter the frequency of the minimum power point by pressing **[CW] XX.XX [GHz]**

7. On the HP 83550A:

Adjust the power level rotary knob until the HP 436A display reads 8.0 dBm, thus ensuring the minimum power point is at maximum specified output power.

8. On the HP 8350:

Press **[START] [2] [6] [.] [5] [GHz]**

Press **[STOP] [3] [7] [.] [2] [GHz]**

Slowly adjust the FREQUENCY/TIME rotary knob from 26.5 to 37.2 GHz on the FREQUENCY/TIME display. Observe the HP 436A display through the entire manual sweep making sure that the power level displayed never exceeds 10.5 dBm. This ensures that from 26.5 to 37.2 GHz, the system's power flatness is within ± 1.25 dB of maximum leveled power, 8.0 dBm. See Figure 2-7.

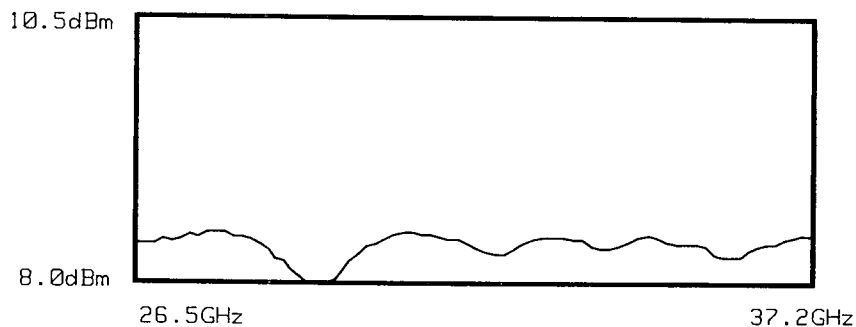

Figure 2-7. Power Flatness Response (26.5 to 37.2 GHz)

The foregoing procedure completes the operator's check from 26.5 GHz to 37.2 GHz. To test the remaining portion of the R-band (37.2 to 40.0 GHz), the entire R-band (26.5 to 40.0 GHz) will be manually swept at a maximum leveled power of 7.0 dBm, with the following steps.

9. On the HP 8350:

Press **[START] [2] [6] [.] [5] [GHz]**

Press **[STOP] [4] [0] [.] [0] [GHz]**

Press **[MAN] SWEEP** and adjust the **FREQUENCY/TIME** rotary knob for a 26.5 GHz reading.

10. On the HP 83550A:

Press **[POWER LEVEL]**

Adjust the power level rotary knob for a 7.0 dBm reading on the HP 436A display.

11. On the HP 8350:

Find the minimum power point between 26.5 GHz and 40.0 GHz by slowly adjusting the **FREQUENCY/TIME** rotary knob from 26.5 GHz to 40.0 GHz. Note at what frequency the minimum power point is. See Figure 2-8.

Enter the frequency at the minimum power point by pressing **[CW] XX.XX [GHz]**

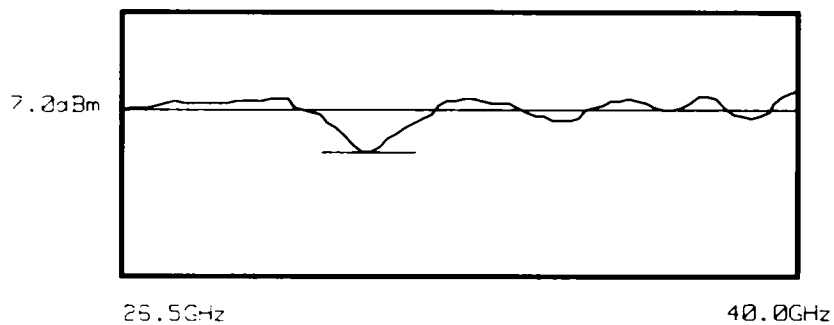

Figure 2-8. Minimum Power Point (26.5 to 40.0 GHz)

12. On the HP 83550A:

Adjust the power level rotary knob for a 7.0 dBm reading on the HP 436A display.

13. On the HP 8350:

Press **[START] [2] [6] [.] [5] [GHz]**

Press **[STOP] [4] [0] [.] [0] [GHz]**

Slowly adjust the FREQUENCY/TIME rotary knob from 26.5 to 40.0 GHz on the FREQUENCY/TIME display. Observe the HP 436A display through the entire manual sweep making sure that the power level displayed never exceeds 9.5 dBm. This ensures that for the remaining portion of the R-band 37.2 to 40.0 GHz, the system's power flatness is within +1.25 dB of maximum leveled power, 7.0 dBm. See Figure 2-9.

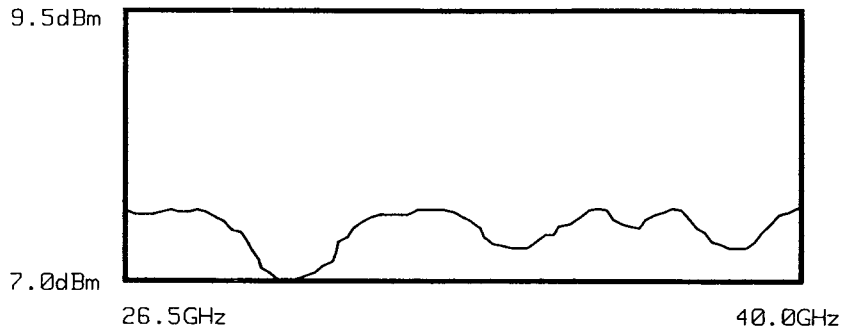

Figure 2-9. Power Flatness Response (26.5 to 40.0 GHz)

This completes the Operator's Check. If your system fails this functional check refer to the paragraph titled TROUBLESHOOTING.

SYSTEM PERFORMANCE TESTS

INTRODUCTION

The procedures in this section test the performance of the HP 83550A/83554A System using the specifications of Table 2-1 as the performance standards. All tests can be performed without access to the interior of the instrument. The performance test procedures must be performed in the sequence given since some procedures rely on satisfactory test results in the foregoing steps. In order to fully verify the performance specifications of the HP 83554A, the performance tests in the Source Module Specifications and Service section must also be performed. None of the tests require access to the interior of the instrument.

Under the paragraph, TROUBLESHOOTING, you will find information on what to do if your system fails to meet specifications.

EQUIPMENT REQUIRED

Equipment required for the performance tests is listed in the Recommended Test Equipment tables in the Source System Guides and the Source Module Specifications and Service Section. Any equipment that satisfies the critical specifications given in the table may be substituted for the recommended models. Ensure also that the test equipment used is currently calibrated to proper specifications.

NOTE: Use only the connectors and cables that are specified in the following test setups to ensure accurate test results.

OPERATION VERIFICATION

The Operation Verification consists of performing the source module specific performance tests (Source Module Specifications and Service Section) which include, Maximum Leveled Power (verifies frequency range), Power Flatness, and Power Level Accuracy. These tests provide reasonable assurance that the source module is functioning properly and should meet the needs of an incoming inspection (80% verification).

TEST RECORD

Results of the performance tests may be recorded in the Test Record at the end of the procedures. The Test Record lists all of the tested specifications and their acceptable limits. Test results recorded at incoming inspection can be used for comparison in periodic maintenance and troubleshooting or after repairs.

FREQUENCY CHARACTERISTICS

Range
Accuracy
CW Resolution
Stability

MODULATION CHARACTERISTICS

External FM

The performance tests listed above are source dependent and can be found in the Performance Tests of the HP 83550A RF plug-in Operating and Service manual.

NOTE: When specifying the output frequency and modulation characteristics of the HP 83550A/83554A system, all specifications will be referenced from the source and must be doubled because the HP 83554A is a frequency doubler. For special information about the doubler, refer to the A4 Multiplier Assembly's theory of operation found in the Source Module Specifications and Service section of this manual.

SYSTEM HARMONICS

Specification

Harmonic related > 30 dBc

Description

The RF output signal from the HP 83550A/83554A system is tuned from 26.5 to 40 GHz and is displayed on a spectrum analyzer to verify that any harmonic spurious signals present are at or below their specified levels. The test configuration in Figure 2-10 uses an external harmonic mixer to extend the frequency range of the spectrum analyzer. When this technique is used, the response is not preselected and multiple signals are displayed. Each response is examined not only for power level but whether or not it is a true in-band spurious signal by using the spectrum analyzer's signal identification function.

Equipment

RF Signal Source	HP 8350/HP 83550A RF plug-in
Microwave Amplifier	HP 11975A
Spectrum Analyzer	HP 8566B
Directional Coupler	HP R752D
Harmonic Mixer	HP 11970A
RF Cables (3)	HP Part No. 5061-5458
Power Meter	HP 436A
Power Sensor	HP R8486A

Procedure

1. Connect the equipment as shown in Figure 2-10.

Turn on all system components.

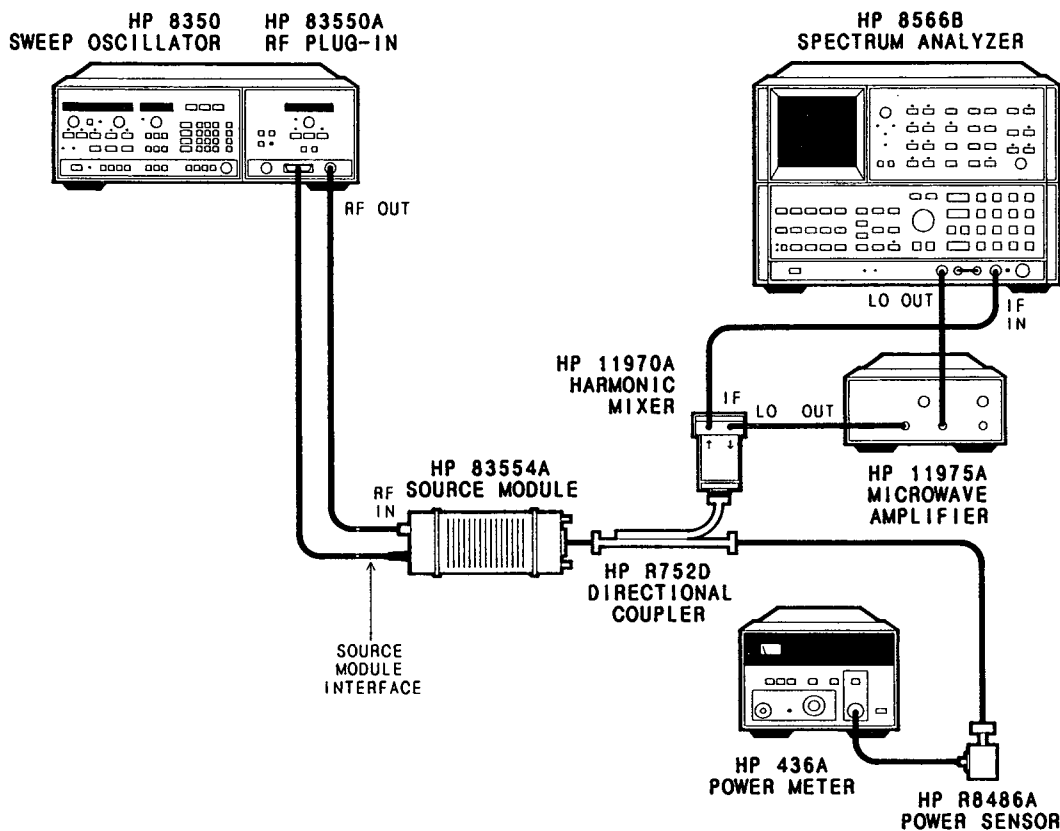

Figure 2-10. Spurious Signals Test Setup

2. On the HP 8350:

Press **[SHIFT] [INSTRUMENT PRESET]**
Press **[CW] [2] [6] [.] [5] [GHz]**

3. On the HP 83550A:

Press **[INT] ALC MODE**
Press **[POWER LEVEL]**
Adjust the power level rotary knob for an 8.0 dBm reading on the HP 436A power meter display.

4. On the HP 8566B:

Press **[INSTR PRESET]**
Press **[SHIFT] [▲] [▲]** until the **FULL BAND K (A)** annotation appears. This places the analyzer into an external mixing mode allowing R-band frequency range capability. Note the start/stop frequency at the bottom of the screen and ensure that the start frequency is 26.5 GHz and the stop frequency is 40.0 GHz.
Press **[REF LEVEL] [8] [.] [0] [+ dBm]**
Press **DISPLAY LINE [ENTER] [2] [2] [- dBm]**, setting the 30 dBc reference.

Amplitude Calibration of the HP 8566B

The HP 8566B spectrum analyzer can make amplitude calibrated measurements of millimeter-wave frequencies when configured with the HP 11970 mixers. A calibration graph that shows conversion loss and reference level offset is provided with each mixer so that the analyzer can be calibrated to that mixer. The following explanation illustrates how this offset is entered into the spectrum analyzer.

In the external mixing mode, the HP 8566B IF gain has been factory adjusted for +30 dB to compensate for the conversion loss of an external mixer. Since the millimeter-wave mixer conversion efficiency is not 30 dB, the user must enter a correction factor to amplitude calibrate the display. These correction factors are supplied with each millimeter-wave mixer in the form of a reference level offset graph. Using the information from the graph supplied with the mixer, you can offset the reference level to obtain precise amplitude calibration for point by point frequency measurements.

If less accurate measurements can be tolerated, normalizing the conversion loss graph on the HP 11970 can be accomplished by averaging the graph's maximum and minimum power points (Max + Min/2) resulting in an overall conversion loss for the entire band. By using this method, an increase of measurement uncertainty is introduced into the test. Reference level offset is determined by the following equation:

$$\text{Conversion Loss} - 30 \text{ dB} = \text{Reference Level Offset}$$

Because the test configuration in Figure 2-10 specifies that the external mixer be connected to the coupled arm of a 20 dB directional coupler, the coupled power must also be taken into account when calculating reference level offset. The new equation is as follows:

$$\text{Conversion Loss} + \text{Coupled Power (20 dB)} - 30 \text{ dB} = \text{Reference Level Offset}$$

For example, if the calibration table on the external mixer indicates a conversion loss of 22 dB for a frequency of 26.5 GHz and a 20 dB directional coupler is used, then the reference level offset is calculated below:

$$\text{Conversion Loss} + \text{Coupled Power (20 dB)} - 30 \text{ dB} = \text{Reference Level Offset}$$

$$22 \text{ dB} + 20 \text{ dB} - 30 \text{ dB} = +12 \text{ dB}$$

Enter this reference level offset by pressing:

[SHIFT] [REF LEV] [1] [2] [+dBm]

Note that the left hand side of the display now reads:

```
CNVLOSS
42.0
dB
```

Measurement Uncertainty

Measurement uncertainty within the test configuration will affect the accuracy of this performance test. To obtain optimum accuracy, amplitude calibrate the spectrum analyzer by entering the conversion loss at each frequency signal under observation as explained under **Amplitude Calibration of the HP 8566B**. Any harmonic-related spurious signals that are close to or at 30 dBc should be given an allowable margin of ± 1.5 dB to compensate for all other measurement uncertainties within the test configuration.

5. On the HP 8350:

Manually tune the sweeper from 26.5 to 37.2 GHz while watching for harmonic responses that are higher than the display line (<30 dBc) on the HP 8566B display.

Signal Identification

6. If a harmonic related spurious signal is found, verify whether or not it is a true in-band signal by using the spectrum analyzer's signal identification feature. This is performed as follows:
7. Tune the signal under observation to center screen on the HP 8566B display.
8. Press **[SHIFT] [FREE RUN]**
9. If the signal is a false response, the annotation **IDENTIFIED OUT OF BAND** will appear on the display.
10. Ensure that any harmonic-related spurious signals observed are within the specified level of >30 dBc.

The foregoing steps performed a harmonic related spurious test from 26.5 to 37.2 GHz at a specified maximum leveled output power of 8.0 dBm. The proceeding steps will continue this test covering the remaining frequency range of the R-band (37.2 to 40.0 GHz) at a maximum leveled output power of 7.0 dBm.

11. On the HP 83550A:

Press **[POWER LEVEL]**

Adjust the power level rotary knob for a 7.0 dBm reading on the HP 436A display.

12. On the HP 8566B:

Press **[REF LEVEL] [7] [.] [0] [+dBm]**

Press **DISPLAY LINE [ENTER] [2] [3] [-dBm]**, setting the 30 dBc reference.

13. Repeat steps 5 through 10 except this time tune the HP 8350 from 37.2 to 40.0 GHz.

This concludes the performance test for harmonic related spurious signals. Performance of this test ensures that all potential problem harmonic related spurious locations have been thoroughly tested for the HP 83550A/83554A system.

If your system fails to meet these specifications, refer to the paragraph titled TROUBLESHOOTING.

Table 2-2. Performance Test Record

HP 83550A System				
Serial Number _____		Date _____		
Humidity* _____		Tested By _____		
(Optional)		Temperature _____		
Specification Tested	Test Conditions	Specification	Test Results	
			Pass	Fail
FREQUENCY				
Range ¹	_____	26.5 to 40.0 GHz ¹	_____	_____
Accuracy ¹	_____	± 40 MHz ¹	_____	_____
Resolution ¹	_____	52 kHz ¹	_____	_____
Stability ¹				
With Temperature, typically	_____	± 2 MHz/°C ¹	_____	_____
With 10% Line Voltage Change	_____	± 300 kHz ¹	_____	_____
With Time (in a 10 min period)	_____	< ± 2 MHz ¹	_____	_____
Residual FM, Peak (20 Hz to 15 kHz BW, CW Mode)	_____	< 50 kHz ¹	_____	_____
MODULATION				
External FM Maximum Deviations for Modulation				
Frequencies Crossover Coupled DC to 100 Hz	_____	± 150 MHz ¹	_____	_____
100 Hz to 6 MHz	_____	± 27 MHz ¹	_____	_____
OUTPUT				
System Harmonics	_____	> 30 dBc	_____	_____

1. These specifications are twice those of the HP 83550A specifications because the HP 83554A is a frequency doubler.

TROUBLESHOOTING

Specification Failures

Failures are divided into two categories:

Category one describes systems that are meeting specifications in some areas, while failing in others. If this is the case, do the following:

- Inspect the connectors and ensure that all connections are making good electrical contact.

- Inspect all cabling for breaks.

- Test again.

If your system is still failing at the SAME points, your instrument(s) or cable(s) could be defective and should be returned for repair. If, however, your system fails at DIFFERENT points, there is probably a loose connection or a mechanical failure somewhere in the setup.

Remember, it is possible the system may fail the performance test(s) because of measurement uncertainties. If you suspect this to be the case, contact your nearest HP office for more information.

Category two failures are total specification failures. If your system fails any of these tests completely, do the following:

- Check the TEST SETUP for correct configuration of the instruments and connections.

- Inspect the connectors.

- Inspect the cables.

- Repeat the failed test(s).

If your system is still failing, the system is probably defective and needs repair.

Also, for the best accuracy in measurement, use only calibrated instruments.

Error Codes

The HP 8350 sweep oscillator and the HP 83550A RF plug-in have a series of internal power-on self tests which will indicate an error code on either the HP 8350 frequency or HP 83550A power displays should a failure occur.

Error codes E001 through E016 are specific to the HP 8350 and indicate a possible failure in the sweep oscillator. Refer to the HP 8350 Operating and Service Manual for information and troubleshooting procedures.

Error codes E050 through E079 are specific to the HP 83550A and indicate a possible failure in the RF plug-in. Refer to the HP 83550A Operating and Service Manual for information and troubleshooting procedures.

Error codes E080 through E086 are specific to the HP 83554A and indicate a possible failure in the source module. Table 2-3 lists the error codes with descriptions and possible error location.

Table 2-3. HP 83550A/83554A System Error Codes (1 of 2)

Error Code Displayed	Error Code Description	Possible Location	Cause
E080	Source Module Digital Interface	HP 83554A-A5	On power-up and instrument preset the HP 83550A will attempt to read known constants in predefined source module NOVRAM addresses. If these constants are not returned correctly, the error indicates a problem with the module interface cable or the digital interface assembly in the source module.

This interface error can be isolated to either the HP 83550A RF plug-in or to the HP 83554A source module by initiating a Source Module Digital Interface Cycle Test. This test verifies that the digital signals necessary for proper source module operation are propagating from the HP 83550A RF plug-in source module digital interface connector. This can be performed as follows:

Turn off the HP 8350 ac power and disconnect the source module from the HP 83550A.

On the HP 8350:
 Switch the ac power to on.
 Press [SHIFT] [8] [0]

Using an oscilloscope, compare the digital interface lines out of the RF plug-in interface connector to the following waveforms. If all the waveforms are present, the error location is either in the source module interface cable or within the source module itself. Should the problem lie in the HP 83550A, refer to the HP 83550A Operating and Service Manual for further troubleshooting information.

Test Pin Location
HP 83550A A3TP7
Source Module Interface Connector
pin 18
pin 19
pin 10
pin 20
pin 8
pin 9

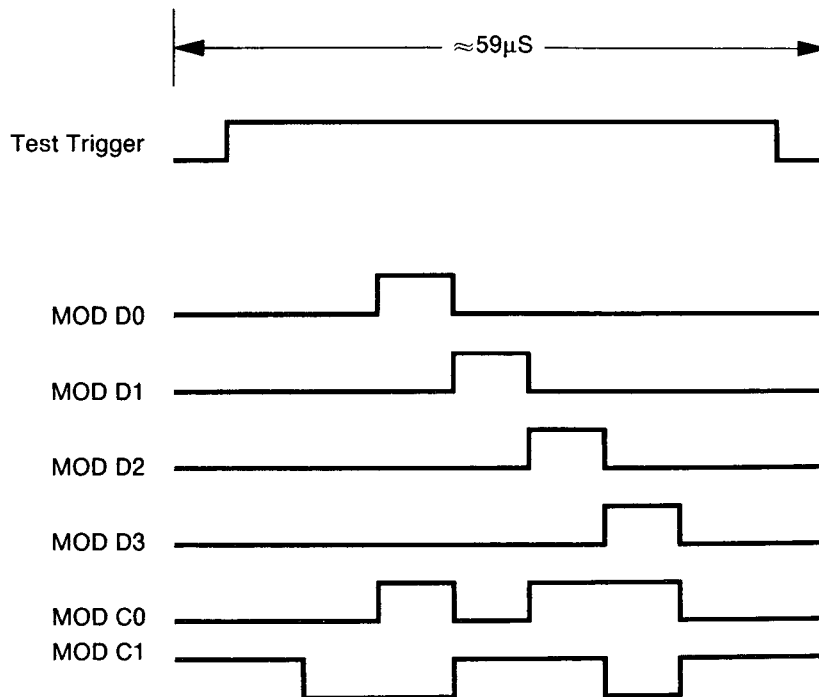

Table 2-3. HP 83550A/83554A System Error Codes (2 of 2)

Error Code Displayed	Error Code Description	Possible Location	Cause
E081	Source Module NOVRAM Checksum Error	HP 83554A-A5	On power-up and instrument preset, a checksum test is performed on the source module NOVRAM data. If the test fails the error will be displayed.
E082	Source Module +8 VDC Supply Failure	HP 83550A-A3	The +8 VDC power supply is used exclusively for source module operation and this error is indicated when the HP 83550A self-test board measurement of the +8 VDC supply is not within the allowed tolerance.
NOTE: This test is not performed upon power-up or instrument preset unless a source module is connected to the RF plug-in.			
E083	Source Module 0.5 V/GHz Failure	HP 83550A-A5	This error code is indicated when a failure in the 0.5 V/GHz signal has been detected. The test presets the RF plug-in to two known states where the 0.5 V/GHz voltage is at known values. The error is indicated if the measurements do not match the known values.
NOTE: This test is not performed upon power-up or instrument preset unless a source module is connected to the RF plug-in.			
E084	Source Module ALC Failure	HP 83554A-A5	<p>This test measures the logged detector voltage from the source module interface connector. The general integrity of the ALC circuitry and the RF chain is checked when the RF plug-in is in the system leveling mode of operation. This voltage is approximately 0 VDC with the power offset value in the source module memory (0 dBm for the HP 83554A) with a slope of 30 mv/dB.</p> <p>The self test sets the RF plug-in to the minimum settable power for the source module. The power should be leveled at this ALC voltage. The error is indicated if the measured voltage is not within tolerances.</p>
NOTE: This test is not performed upon power-up or instrument preset unless a source module is connected to the RF plug-in. Also, this test is not performed if the RF plug-in is configured for NO RF power at instrument power-up.			

Troubleshooting System Harmonics

If the HP 83550A/83554A system fails to meet the specifications mentioned in step 5 of the System Harmonics test, the failure may be occurring from either the HP 83550A RF plug-in or the HP 83554A mm-wave source module. The following steps will help to isolate the origin of the failure. See Figure 2-11 for harmonic check points.

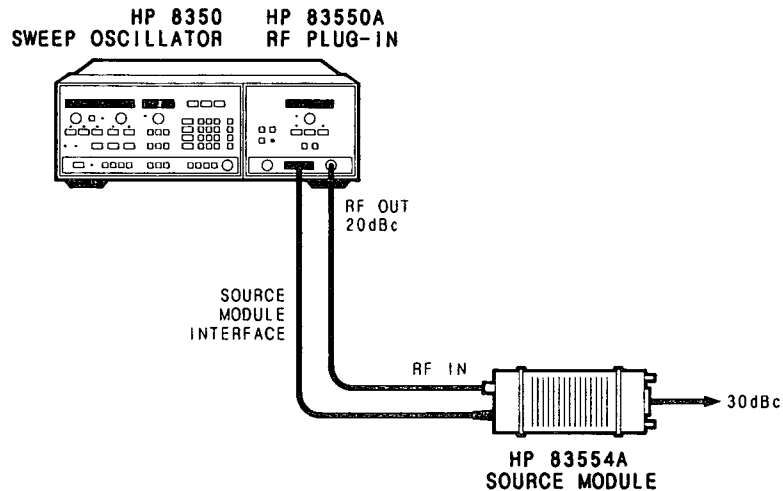

Figure 2-11. Harmonic Check Points

1. If the harmonic related spurious output from the HP 83554A is less than 30 dBc, check the harmonic output of the HP 83550A and ensure that it is greater than 20 dBc.
2. If the HP 83550A harmonic output is within specifications, refer to the Source Module Specifications and Service Section of this manual and perform the Two-tone Harmonics performance test to verify that the HP 83554A is at fault. If the HP 83554A is at fault, refer again to the Source Module Specifications and Service Section for instrument repair or replacement.
3. If the HP 83550A RF plug-in exceeds the harmonic output specifications, repair or replace the RF plug-in. For troubleshooting information, refer to the HP 83550A Operating and Service Manual.

REGIONAL SALES AND SUPPORT OFFICES

For information relating to Sales or Support of Hewlett-Packard products first contact your local Hewlett-Packard office listed in the white pages of your telephone directory. If none is listed locally, contact one of the addresses listed below to obtain the address or phone number of the Hewlett-Packard Sales or Support office nearest you.

ASIA

Hewlett-Packard Asia Ltd.
47/F, 26 Harbour Road,
Wanchai, **HONG KONG**
G.P.O. Box 863, Hong Kong
Tel: (852) 5-8330833
Telex: 76793 HPA HX
Cable: HPASIAL TD

AUSTRALASIA

Hewlett-Packard Australia Ltd.
31-41 Joseph Street
BLACKBURN, Victoria 3130
Australia
Tel: (61) 895-2895
Telex: 31-024
Cable: HEWPARD Melbourne

CANADA

Hewlett-Packard (Canada) Ltd.
6877 Goreway Drive
MISSISSAUGA, Ontario L4V 1M8
Tel: (416) 678-9430
Telex: 069-8644

JAPAN

Yokogawa-Hewlett-Packard Ltd.
29-21 Takaido-Higashi, 3 Chome
Suginami-ku **TOKYO** 168
Tel: 03 (331) 6111
Telex: 232-2024 YHPTOK

MEDITERRANEAN AND MIDDLE EAST

Hewlett-Packard S.A.
Mediterranean and Middle East
Operations
Atrina Centre
32 Kifissias Avenue
Paradissos-Amarousion, **ATHENS**
Greece
Tel: (30) 682 88 11
Telex: 21-6588 HPAT GR
Cable: HEWPACKSA Athens

BENELUX & SCANDINAVIA

Hewlett-Packard S.A.
Uilenstede 475
P.O. Box 999
NL-1183 AG **AMSTELVEEN**
The Netherlands
Tel: (31) 20/43 77 71
Telex: 18 919 hpner nl

SOUTH & EAST EUROPE, AFRICA

Hewlett-Packard S.A.
7, rue du Bois-du-Lan
CH-1217 **MEYRIN** 2, Geneva
Switzerland
Tel: (41) 22/83 12 12
Telex: 27835 hmea
Cable: HEWPACKSA Geneve

FRANCE

Hewlett-Packard France
Parc d'activités du Bois Briard
2, avenue du Lac
91040 **EVRY** Cedex
Tel: 1 6/077 83 83
Telex: 6923 15F

GERMAN FEDERAL REPUBLIC

Hewlett-Packard GmbH
Hewlett-Packard-Strasse
Postfach 1641
D-6380 **BAD HOMBURG**
West Germany
Tel: 06172/400-0
Telex: 410 844 hpbhg

ITALY

Hewlett-Packard Italiana S.p.A.
Via G. Di Vittorio 9
1-20063 **CERNUSCO SUL
NAVIGLIO**
(Milano)
Tel: 02/92 36 91
Telex: 334632

UNITED KINGDOM

Hewlett-Packard Ltd.
King Street Lane
Winnersh, **WOKINGHAM**
Berkshire RG11 5AR
Tel: 734/78 47 74
Telex: 847178

EASTERN USA

Hewlett-Packard Co.
4 Choke Cherry Road
ROCKVILLE, MD 20850
Tel: (301) 670-4300

MIDWESTERN USA

Hewlett-Packard Co.
5201 Tollview Drive
ROLLING MEADOWS, IL 60008
Tel: (312) 255-9800

SOUTHERN USA

Hewlett-Packard Co.
2000 South Park Place
P.O. Box 105005
ATLANTA, GA 30348
Tel: (404) 955-1500

WESTERN USA

Hewlett-Packard Co.
5161 Lankershim Blvd.
P.O. Box 3919
NO. HOLLYWOOD, CA 91609
Tel: (818) 506-3700

OTHER INTERNATIONAL AREAS

Hewlett-Packard Co.
Intercontinental Headquarters
3495 Deer Creek Road
PALO ALTO, CA 94304
Tel: (415) 857-1501
Telex: 034-8300
Cable: HEWPACK



**HP 83590 Series
Source System Guide**

HP 83554A SOURCE MODULE

For use with
HP 83590 Series
HP 8349B
HP 8350

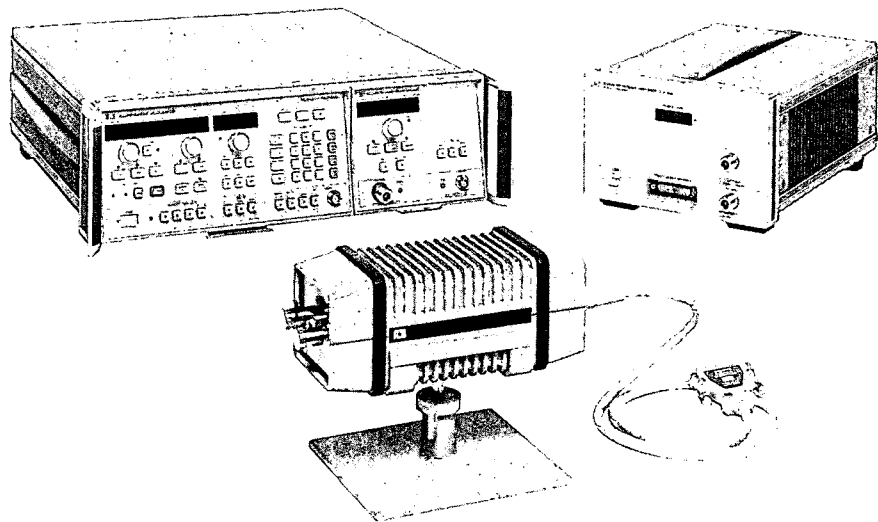

**HEWLETT
PACKARD**

CERTIFICATION

Hewlett-Packard Company certifies that this product met its published specifications at the time of shipment from the factory. Hewlett-Packard further certifies that its calibration measurements are traceable to the United States National Bureau of Standards, to the extent allowed by the Bureau's calibration facility, and to the calibration facilities of other International Standards Organization members.

WARRANTY

This Hewlett-Packard system product is warranted against defects in materials and workmanship for a period corresponding to the individual warranty periods of its component products. Computer and computer peripherals are warranted for a period of 90 days. Instruments are warranted for a period of one year. During the warranty period, Hewlett-Packard Company will, at its option, either repair or replace products which prove to be defective.

Warranty service for products installed by HP and certain other products designated by HP will be performed at Buyer's facility at no charge with HP service travel areas. Outside HP service travel areas, warranty service will be performed at Buyer's facility only upon HP's prior agreement and Buyer shall pay HP's round trip travel expenses. In all other areas, products must be returned to a service facility designated by HP.

For products returned to HP for warranty service, Buyer shall prepay shipping charges to HP and HP shall pay shipping charges to return the product to Buyer. However, Buyer shall pay all shipping charges, duties, and taxes for products returned to HP from another country.

HP warrants that its software and firmware designated by HP for use with an instrument will execute its programming instructions when properly installed on that instrument. HP does not warrant that the operation of the instrument, or software, or firmware will be uninterrupted or error free.

LIMITATION OF WARRANTY

The foregoing warranty shall not apply to defects resulting from improper or inadequate maintenance by Buyer, Buyer-supplied software or interfacing, unauthorized modification or misuse, operation outside of the environmental specifications for the product, or improper site preparation or maintenance.

NO OTHER WARRANTY IS EXPRESSED OR IMPLIED. HP SPECIFICALLY DISCLAIMS THE IMPLIED WARRANTIES OR MERCHANTABILITY AND FITNESS FOR A PARTICULAR PURPOSE.

EXCLUSIVE REMEDIES

THE REMEDIES PROVIDED HEREIN ARE BUYER'S SOLE AND EXCLUSIVE REMEDIES. HP SHALL NOT BE LIABLE FOR ANY DIRECT, INDIRECT, SPECIAL, INCIDENTAL, OR CONSEQUENTIAL DAMAGES, WHETHER BASED ON CONTRACT, TORT, OR ANY OTHER LEGAL THEORY.

ASSISTANCE

Product maintenance agreements and other customer assistance agreements are available for Hewlett-Packard products.

For any assistance, contact your nearest Hewlett-Packard Sales and Service Office. Addresses are provided at the back of this manual.

**HP 83554A
MILLIMETER-WAVE
SOURCE MODULE**

**For use with
HP 83590 Series
HP 8350
HP 8349B**

SERIAL NUMBERS

This manual applies directly to HP 83554A Millimeter-wave source modules having serial prefix 2612A.

For additional information about serial numbers, refer to INSTRUMENTS COVERED BY MANUAL in System General Information.

©Copyright HEWLETT-PACKARD COMPANY 1986
1400 FOUNTAINGROVE PARKWAY, SANTA ROSA, CA 95401 U.S.A.

MANUAL PART NO. 83554-90005
Microfiche Part Number 83554-90012

Printed: APRIL 1986



**HEWLETT
PACKARD**

TABLE of CONTENTS
HP 83590 SERIES SOURCE SYSTEM GUIDE

Introduction

System Specifications

Operation

Operator's Check

System Performance Tests

Introduction

Frequency Characteristics

System Harmonics

Troubleshooting

HP 83590 Series Source System Guide

INTRODUCTION

This source system guide is intended to provide you with mm-wave system operating information for the HP 83590 Series RF plug-ins. It contains an operator's check, connection diagrams, system specifications, system performance tests, and system level troubleshooting. For detailed instructions regarding the operation or troubleshooting of the individual instruments refer to the instrument's operating and service manual.

SYSTEM DESCRIPTION

The HP 83590 Series RF plug-ins cover the frequency range of 10 MHz to 26.5 GHz. The combination of the HP 83590 Series RF plug-ins/8350 sweep oscillator with an HP 8349B microwave amplifier delivers the required input power of +17 dBm from 13.25 to 20 GHz for the HP 83554A millimeter-wave source module.

For proper display accuracy, leveling flatness, and harmonic suppression, the 83590 Series plug-in's 1V/GHz output will have to be modified for a 0.5V/GHz output. Modification instructions and parts are provided with your mm-wave source module. If the serial number prefix of your plug-in matches or exceeds 2602A, the 0.5V, 1.0V/GHz frequency reference output is switch selectable on the A2 interface assembly. Refer to the proper HP 83590 Series RF plug-in Operating and Service manual or the latest manual change sheet.

Also, for best ALC and pulse performance and the ability to externally power meter level with the HP 436A/438A power meters, it is a requirement that the HP 83590 Series RF plug-ins have the latest version of the A4-ALC assembly. Another requirement is the sweep control assembly. It must be the latest revision to allow external leveling at lower RF plug-in output powers when used in millimeter-wave applications. If the serial number prefix of your plug-in matches or exceeds any of the prefixes listed in the box below, the latest version of the A4-ALC and A6-sweep control assemblies are already installed.

RF Plug-in	Lowest Serial Number Prefix with the Required A4 and A6 Assemblies
83590A	2411A
83592A	2411A
83592B	2410A
83592C	2412A
83594A	2409A
83595A	2411A

WARNING

This equipment is capable of radiating millimeter-wave energy from the end of unterminated waveguide. Do not look directly into the open end of any waveguide when it is connected to a source of millimeter-wave energy.

Take precautions consistent with ANSI C95.1 - 1982, a study performed by the American National Standards Institute that sets limits for human exposure to microwave and millimeter-wave energy. Copies of this publication are available from:

American National Standards Institute
1430 Broadway
New York, N. Y. 10018

SYSTEM SPECIFICATIONS

Table 2-1 provides specifications for the HP 83590 Series RF plug-in/83554A system configuration. These are the performance standards against which the system is tested.

Table 2-1. HP 83590 Series/83554A System Specifications

<p>Frequency Characteristics</p> <p>Range 26.5 to 40.0 GHz</p> <p>Accuracy (25°C ± 5°C)</p> <p> CW Mode ± 20 MHz</p> <p>All Sweep Modes</p> <p> (for sweep time > 100 msec) ± 60 MHz</p> <p>CW Resolution 52 kHz</p> <p>Stability</p> <p> With Temperature, typically ± 1.2 MHz/°C</p> <p> With 10% Line Voltage Change ± 300 kHz</p> <p> With Time (in a 10-minute period)¹ < ± 600 kHz</p> <p> Residual FM. Peak (20 Hz to 15 kHz bandwidth) (CW mode) < 18 kHz</p> <p>Modulation Characteristics</p> <p>External FM</p> <p>Maximum Deviations for Modulation Frequencies</p> <p> Crossover Coupled</p> <p> DC to 100 Hz ± 150 MHz</p> <p> 100 Hz to 1 MHz ± 14 MHz</p> <p> 1 MHz to 2 MHz ± 10 MHz</p> <p> 2 MHz to 10 MHz ± 2 MHz</p>	<p>Modulation Characteristics (Cont'd)</p> <p>Direct Coupled</p> <p> DC to 100 Hz ± 24 MHz</p> <p> 100 Hz to 1 MHz ± 14 MHz</p> <p> 1 MHz to 2 MHz ± 10 MHz</p> <p> 2 MHz to 10 MHz ± 2 MHz</p> <p>Sensitivity</p> <p> FM Mode, typically -40 MHz/V</p> <p> Phase-Lock Mode, typically -12 MHz/V</p> <p>External AM</p> <p> Bandwidth, typically DC to 100 kHz</p> <p> Sensitivity, typically 1 dB/V</p> <p>External Pulse Modulation</p> <p> Rise/Fall Time, typically 1 μs</p> <p> Minimum RF Pulse Width</p> <p> System Leveled, typically 1 μs²</p> <p> System Unleveled, typically 100 ns²</p> <p> On/Off Ratio, typically > 80 dB</p> <p> Pulse Repetition Frequency</p> <p> System Leveled 100 Hz to 500 kHz²</p> <p> System Unleveled 100 Hz to 5 MHz</p> <p> HP 8756A, 8757A</p> <p> AC Detection Mode Compatibility yes</p> <p>Output Characteristics⁴</p> <p>System Harmonically related spurious > 20 dBc³</p> <p> Typically > 25 dBc</p>
<p>1. After one hour warmup at selected CW frequency.</p> <p>2. Pulse modulation characteristics of HP 83592A/B/C or 83595A based source configuration only.</p> <p>3. With the exception of the HP 83592C which is > 30 dBc.</p> <p>4. For output characteristics, see Source Module Specifications and Service Section.</p>	

OPERATION

INTRODUCTION

This section is intended for operators familiar with the HP 8350/83590 series instruments. If you are unsure, refer to the Operators Check at the end of this section for more specific instructions.

In the operation instructions, any instrument setting or function key is defined by the [] symbols around it.

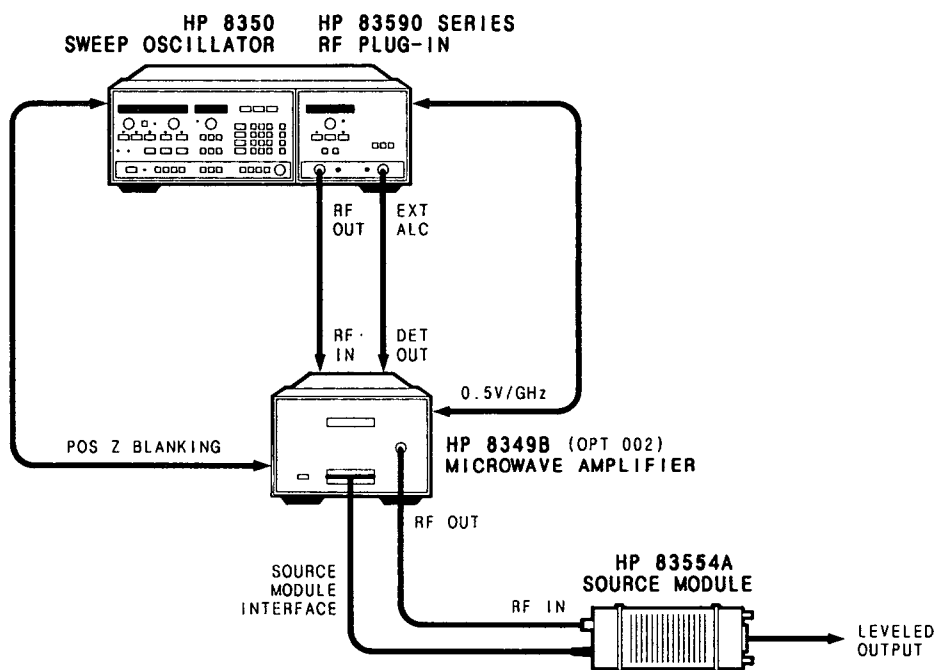

Figure 2-1. HP 83590 Series RF plug-in/83554A Source System Configuration



Turn off the ac power on the HP 8349B prior to connecting or disconnecting the source module interface cable.

Connect the system as shown in Figure 2-1.

FREQUENCY CONTROL

After the connections have been made, turn on the system instruments, and press **[INSTR PRESET]** on the HP 8350. Allow the instruments to warm-up for 30 minutes. Next, enter a display multiplier on the HP 8350 so that the multiplied output frequency will be correctly displayed. A multiplication factor of two is entered by pressing:

[SHIFT] [START] [2] [MHz]

Once the multiplication factor is entered, you can now directly set the frequency range of interest on the HP 8350 front panel.

NOTE: Entering frequencies outside the 26.5 to 40 GHz (13.25 to 20 GHz) are invalid and the system will not work properly.

The multiplication factor may be reset to one by pressing:

[INSTR PRESET]

or by entering a multiplication factor of one by pressing:

[SHIFT] [START] [1] [MHz]

The multiplication factor may be "locked" by pressing:

[SHIFT] [ALT]

This eliminates having to re-enter the multiplication factor each time **INSTR PRESET** is pressed.

The lock may be removed and the multiplication factor may be reset to one by pressing:

[SHIFT] [INSTR PRESET]

POWER LEVEL CONTROL



Before performing any power level calibrations, ensure that the plug-in is not at maximum power.

The RF output power of the mm-wave source module is read on the HP 8349B display in this configuration. However, the output power level is controlled by the Power Level Control on the RF plug-in front panel. The power display of the HP 83590 Series plug-in can be adjusted to match the display on the HP 8349B with the following steps:

Activate the **[EXT]** leveling key on the RF plug-in.

Set the power level of the HP 83590 Series RF plug-in to 8.0 dBm using the rotary knob (plug-in) or keypad of the HP 8350.

Set the frequency of the HP 8350 to a CW frequency within the desired frequency range.

Turn the CAL (Calibration adjustment) shown in Figure 2-2 until the power output display of the HP 8349B reads 8.0 dBm.

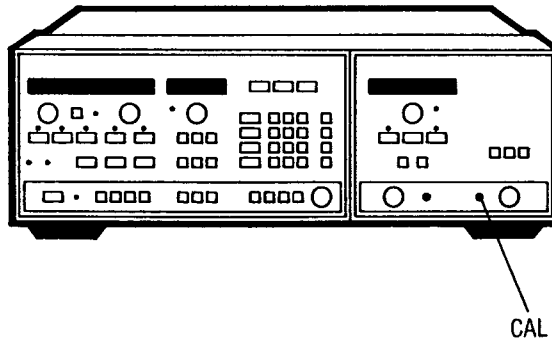

Figure 2-2. HP 83590 Series RF plug-in CAL Adjustment Location

POWER LEVELING

System Leveling.

The source system configuration shown in Figure 2-1, provides leveled source module output power with corrected power level flatness. With the EXT key on and the RF plug-in active, a portion of the source module output power is coupled out of a directional coupler and detector internal to the source module. This signal is processed and fed through the HP 8349B DET OUT and connected to the RF plug-in external ALC input.

External Crystal Detector Leveling

Figure 2-3 illustrates a typical crystal detector leveling setup. Directional couplers and crystal detectors are used to level the source module output power. The RF output power at the waveguide output of the source module is read on the HP 8349B display. Use the following steps to match the power display of the HP 83590 Series RF plug-in to the HP 8349B display.

Set the RF plug-in ALC mode to [EXT] on the RF plug-in. Maximum specified power and flatness may not be achieved when using an external leveling technique as a result of leveling coupler losses.

Set the power level of the HP 83590 Series RF plug-in to 8.0 dBm using the rotary knob (plug-in) or keypad of the HP 8350.

Set the frequency of the HP 8350 to a CW frequency within the desired frequency range.

Turn the CAL (Calibration adjustment) shown in Figure 2-2 until the power output display of the HP 8349B reads 8.0 dBm.

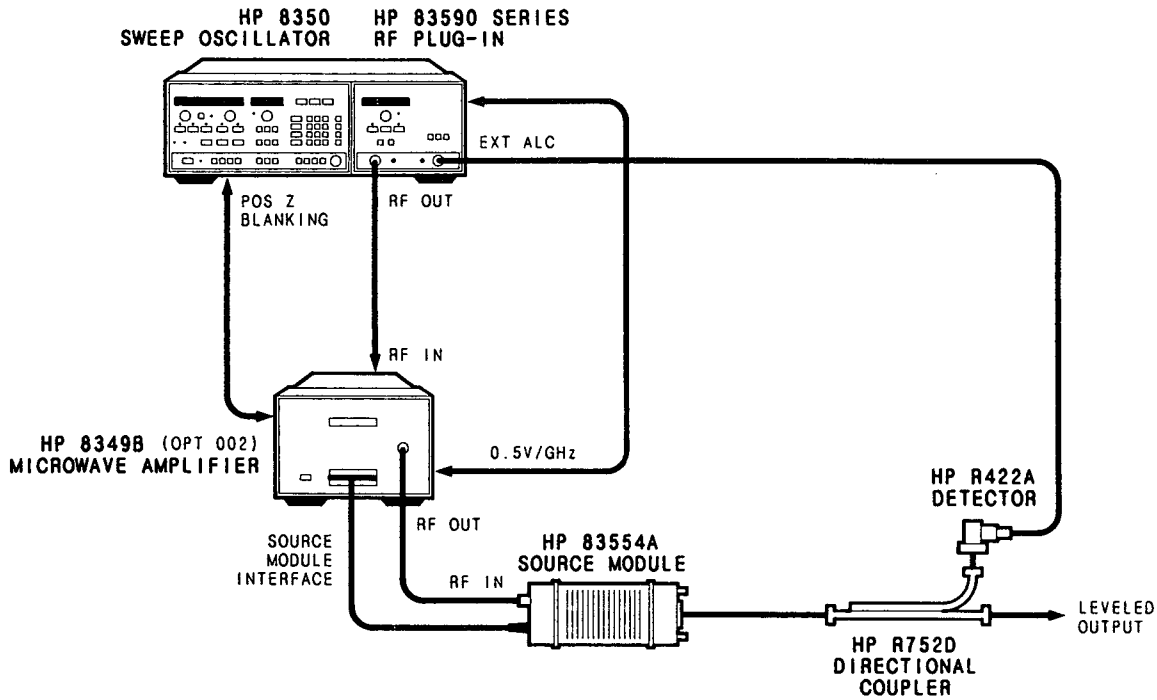

Figure 2-3. External Crystal Detector Leveling at the HP 83554A Output

External Power Meter Leveling

Output power may also be leveled with a power meter and a directional coupler as shown in Figure 2-4. Power meter leveling at the mm-wave source module output is possible using the power meters referenced in Table 1 (System General Information).

Set the plug-in ALC mode to **[MTR]**. For best accuracy, limit the sweep time to 100 seconds when this leveling method is used. A portion of the output power from the source module is coupled/detected and routed to the power meter. The DC voltage from the power meter recorder output is then applied to the RF plug-in external ALC input.

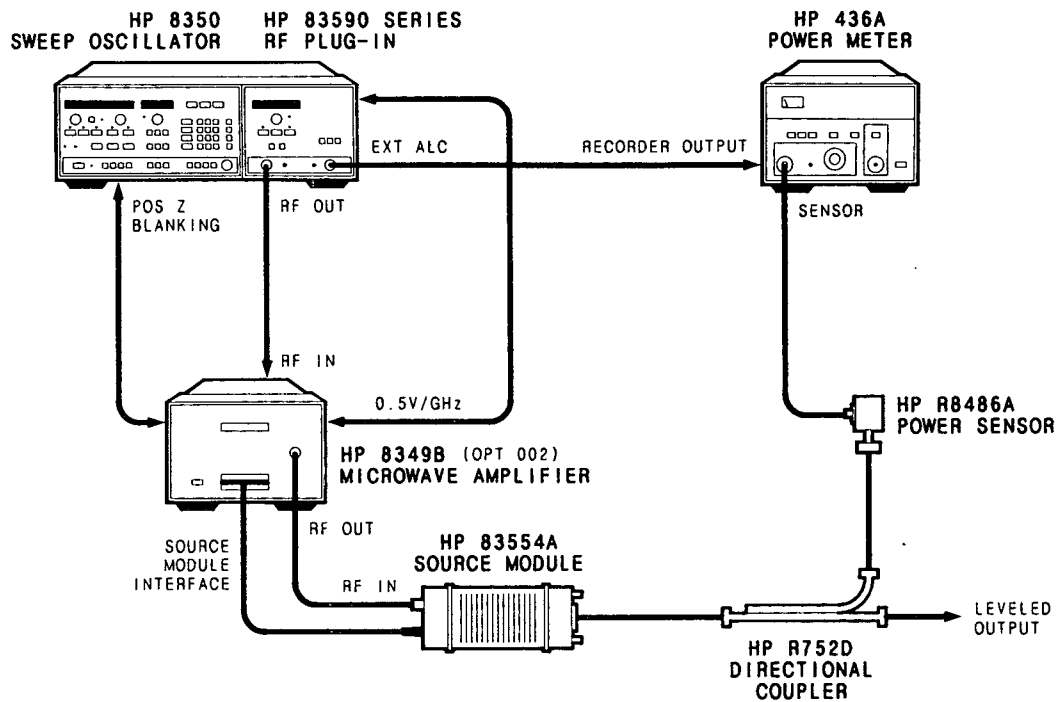

Figure 2-4. External Power Meter Leveling at the HP 83554A Output

MODULATION

For complete specifications on all modulation modes described below, refer to Table 2-1 (HP 83590 Series/83554A System Specifications).

Frequency Modulation (FM INPUT Connector on HP 8350)

The HP 83590 Series/83554A system output signal can be frequency modulated using an external modulating signal applied to the HP 8350 rear panel FM INPUT connector.

The sensitivity and maximum deviations of the RF plug-in are multiplied by a factor of two because the HP 83554A source module is a frequency doubler. On the HP 83590 Series RF plug-ins, the sensitivity and coupling may be set via a configuration switch A3S1. The following configuration switch settings override the HP 8350 non-volatile memory settings at instrument preset. If the configuration switch settings are changed, you must press Instrument Preset again to load the memory with the new sensitivity and coupling settings.

The following is an example of the HP 83592A RF plug-in configuration switch settings. Refer to the specific RF plug-in operating and service manual for further details. The sensitivity setting for the overall system will be doubled, -12MHz/V and -40MHz/V .

Description	A3S1 Switch Number	
	5	6
-6MHz/V FM Sensitivity	1	1
-20MHz/V FM Sensitivity	0	X
Direct-Coupled	**	0
Cross-over Coupled	X	1

NOTE: 1 = High
0 = Low
X = Don't Care

** When direct-coupled FM is selected (switch number 6), -20MHz/V is automatically selected.

Amplitude Modulation (AM INPUT Connector on HP 8350)

On this source system configuration, the AM INPUT provides amplitude changes (up to approximately 13 dB) proportional to the modulating voltage. The sensitivity is typically 1 dB/V. The AM is typically limited to a frequency response of DC to 100 kHz.

Maximum depth of modulation can be achieved by starting at the maximum power and decreasing down to the minimum power level possible from the source module. For maximum modulation index, the HP 83554A source module should be set to a power level such that the peak of the modulation waveform does not exceed the maximum specified power level.

Pulse Modulation (PULSE IN Connector)

The application of a pulse or square wave signal to the PULSE IN connector provides a pulse or square wave modulated signal at the output of the HP 83554A. This input provides an ON/OFF power ratio of typically greater than 80 dB. The PULSE IN input is normally at a TTL HIGH (approximately +3 volts DC). When a TTL LOW signal (approximately 0 volts DC) is applied, the source module output signal is turned off.

With system leveled power, pulse repetition rates from 100 Hz to 500 kHz are achievable. The pulse specifications given in Table 2-1, apply to HP 83592A/B/C or HP 83595A plug-in based configurations only.

OPERATING SUGGESTIONS

When using an HP 83590 Series RF plug-in as the source driver, you can optimize the ALC loop performance by using fixed attenuator(s). For example, typical HP 83590/83554A system power levels (not optimized) over the specified range, are as follows:

RF Plug-in (dBm)		HP 8349B (dBm)		HP 83554A (dBm)
Display	Output	Display	Output	Output
+8.0	-10.0	+8.0	+12.0	+8.0
-5.0	-23.0	-5.0	-1.0	-5.0

The RF plug-in power output levels are quite low and can possibly reach the lower limit of the ALC modulator range. By adding a fixed attenuator(s) between the RF plug-in and the HP 8349B amplifier the overall system power level will decrease. A corresponding change in ALC drive signal will cause the RF plug-in to increase output power to correct for the apparent power loss. Thereby, avoiding ALC loop performance problems without overall system performance degradation.

Optimization of the system leveling loop is especially important in scalar network applications when square wave modulation is used. The square wave modulation performance of the RF plug-in is significantly better between maximum output power (depends upon which plug-in) and 15 db lower. By forcing an increase in power with an attenuator(s) the performance improvement is noticeable.

OPERATOR'S CHECK

DESCRIPTION

The following procedure will enable you to verify the proper operation of your HP 83590 Series/83554A system by determining the system's output power and flatness performance over the R-band frequency range of 26.5 to 40.0 GHz at maximum leveled output power. Maximum leveled output power is split into two specifications across the band, +8.0 dBm (26.5 to 37.2 GHz) and +7.0 dBm (37.2 to 40.0 GHz). Therefore, the subsequent procedure will test the power flatness at both power levels.

EQUIPMENT

Ensure that all the instruments below meet their own performance standards and have been recently calibrated to proper specifications before configuring them into the setup.

RF Signal Source	HP 8350/HP 83590 Series RF Plug-in
Microwave Amplifier	HP 8349B
Power Meter	HP 436A
Power Sensor	HP R8486A

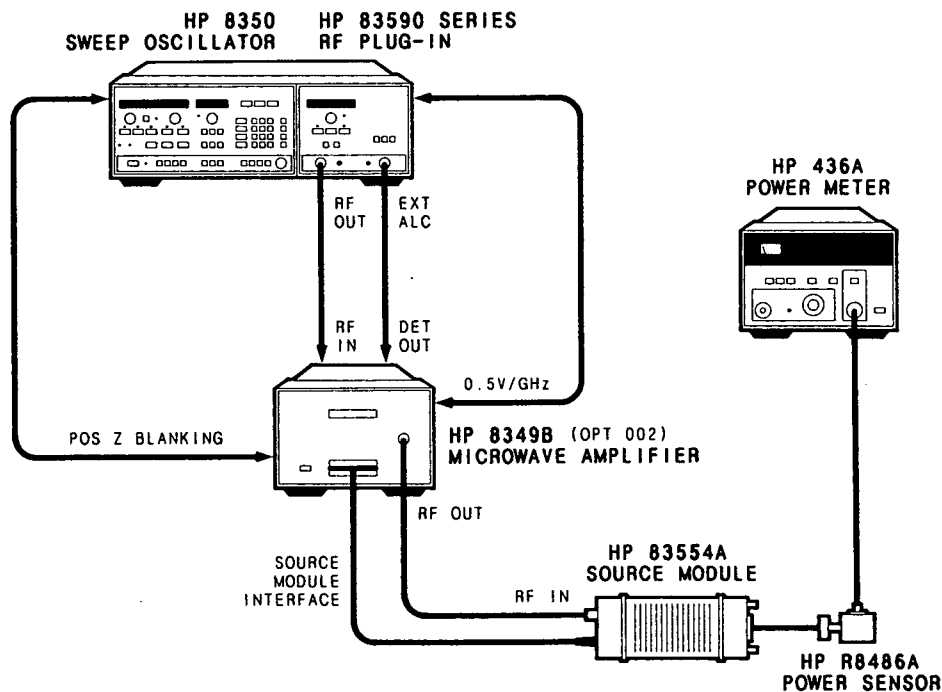

Figure 2-5. System Configuration

PROCEDURE

1. Connect the equipment as shown in Figure 2-5. Do not connect the HP R8486A power sensor to the HP 83554A output.



Turn off the AC power on the HP 8349B prior to connecting or disconnecting from the source module interface connector.

2. Turn on all system components.
3. On the power meter:

Press **[dBm]** mode.

Zero and calibrate the power meter. Set the CAL FACTOR at 100%. The CAL FACTOR will **not** be changed for the rest of the procedure. By leaving the CAL FACTOR set at 100% it ensures minimum specifications will be met.

4. On the HP 8350:

Press **[SHIFT] [INSTRUMENT PRESET]**

Press **[SHIFT] [START] [2] [MHz]**

Press **[SHIFT] [ALTr]**

Press **[START] [2] [6] [.] [5] [GHz]**

Press **[STOP] [3] [7] [.] [2] [GHz]**

Press **[MAN] SWEEP** and adjust the FREQUENCY/TIME rotary knob for a 26.5 GHz frequency reading.

NOTE: Ensure that the **[MOD]** button is off or it will affect the power level indication on the power meter.

5. On the RF Plug-in:

Press **[EXT] ALC MODE** to put the system in the system leveled mode.

Press **[POWER LEVEL]**

Adjust the power level rotary knob for a 8.0 dBm reading on the RF plug-in display.

Connect the HP R8486A power sensor to the HP 83554A output.

Adjust the RF plug-in EXT ALC CAL potentiometer for a 8.0 dBm reading on the HP 436A. The displays of the RF plug-in, amplifier and power meter should all read 8.0 dBm (within the power level accuracy).

6. On the HP 8350:

Press **[SAVEr] [1]**

Find the minimum power point between 26.5 GHz and 37.2 GHz by slowly adjusting the FREQUENCY/TIME rotary knob from 26.5 GHz to 37.2 GHz and reading the power meter display. Note at what frequency the minimum power point occurs. See Figure 2-6.

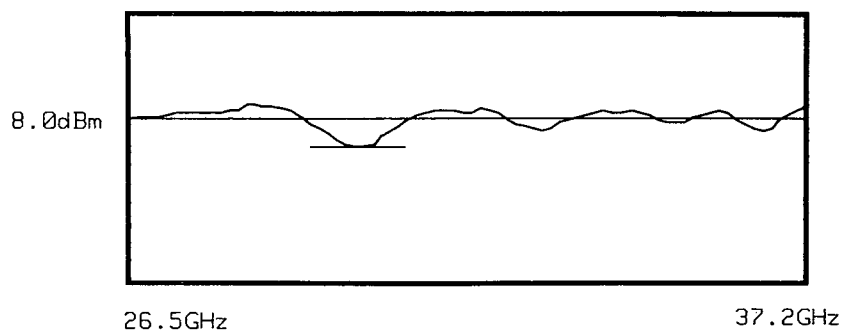

Figure 2-6. Minimum Power Point (26.5 to 37.2 GHz)

Enter the frequency of the minimum power point by pressing **[CW] XX.XX [GHz]**

7. On the RF Plug-in:

Adjust the EXT ALC CAL potentiometer until the HP 436A display reads 8.0 dBm, thus ensuring the minimum power point is at maximum specified output power.

8. On the HP 8350:

Press **[RECALL] [1]**

Slowly adjust the FREQUENCY/TIME rotary knob from 26.5 to 37.2 GHz on the FREQUENCY/TIME display. Observe the HP 436A display through the entire manual sweep making sure that the power level displayed never exceeds 10.5 dBm. This ensures that from 26.5 to 37.2 GHz, the system's power flatness is within ± 1.25 dB of maximum leveled power, 8.0 dBm. See Figure 2-7.

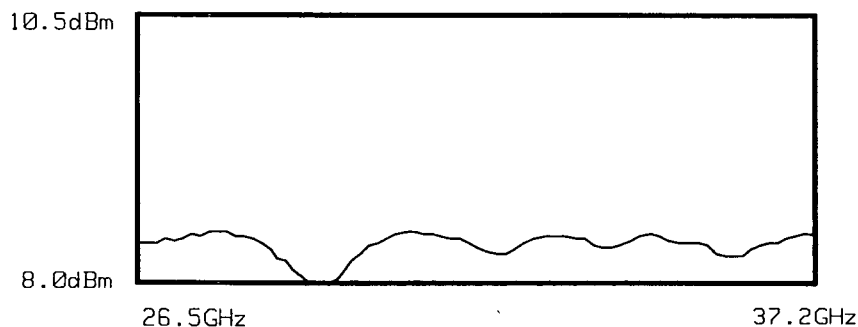

Figure 2-7. Power Flatness Response (26.5 to 37.2 GHz)

9. The foregoing procedure completes the operator's check from 26.5 GHz to 37.2 GHz. To test the remaining portion of the R-band (37.2 to 40.0 GHz), the entire R-band (26.5 to 40.0 GHz) will be manually swept at a maximum leveled power of 7.0 dBm, with the following steps.

10. Disconnect the HP R8486A power sensor from the HP 83554A output.

11. On the HP 8350:

Press **[START] [2] [6] [.] [5] [GHz]**

Press **[STOP] [4] [0] [.] [0] [GHz]**

Press **[MAN] SWEEP** and adjust the FREQUENCY/TIME rotary knob for a 26.5 GHz reading.

12. On the RF Plug-in:

Press **[EXT] ALC MODE**

Press **[POWER LEVEL]**

Adjust the power level rotary knob for a 7.0 dBm reading on the RF plug-in display.

Connect the HP R8486A power sensor to the HP 83554A output.

Adjust the RF plug-in EXT ALC CAL potentiometer for a 7.0 dBm reading on the HP 436A. The displays of the RF plug-in, amplifier and power meter should all read 7.0 dBm (within the display tolerances).

13. On the HP 8350:

Press **[SAVE_n] [1]**

Find the minimum power point between 26.5 GHz and 40.0 GHz by slowly adjusting the FREQUENCY/TIME rotary knob from 26.5 GHz to 40.0 GHz. Note at what frequency the minimum power point is. See Figure 2-8.

Enter the frequency at the minimum power point by pressing **[CW] XX.XX [GHz]**

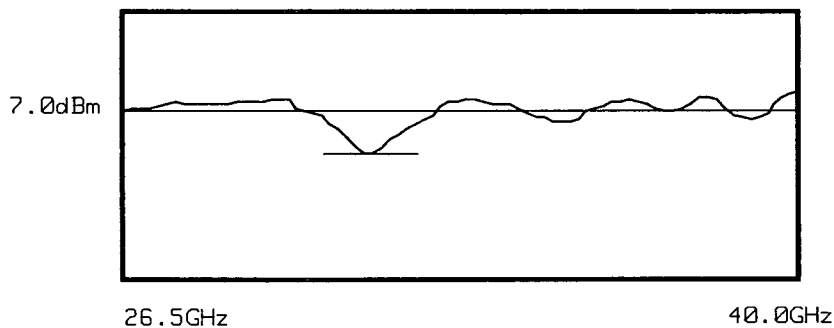

Figure 2-8. Minimum Power Point (26.5 to 40.0 GHz)

14. On the RF Plug-in:

Adjust the EXT ALC CAL potentiometer until the HP 436A display reads 7.0 dBm.

15. On the HP 8350:

Press **[RECALL] [1]**

Slowly adjust the FREQUENCY/TIME rotary knob from 26.5 to 40.0 GHz on the FREQUENCY/TIME display. Observe the HP 436A display through the entire manual sweep making sure that the power level displayed never exceeds 9.5 dBm. This ensures that for the remaining portion of the R Band 37.2 to 40.0 GHz, the system's power flatness is within ± 1.25 dB of maximum leveled power, 7.0 dBm. See Figure 2-9.

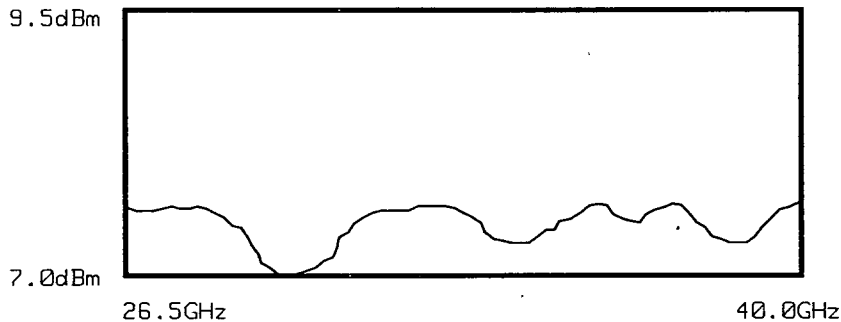

Figure 2-9. Power Flatness Response (26.5 to 40.0 GHz)

This completes the Operator's Check. If your system fails this functional check refer to the paragraph titled TROUBLESHOOTING.

SYSTEM PERFORMANCE TESTS

INTRODUCTION

The procedures in this section test the performance of the HP 83590 Series/83554A System using the specifications of Table 2-1 as the performance standards. All tests can be performed without access to the interior of the instrument. The performance test procedures must be performed in the sequence given since some procedures rely on satisfactory test results in the foregoing steps. In order to fully verify the performance specifications of the HP 83554A, the performance tests in the Source Module Specifications and Service section must also be performed. None of the tests require access to the interior of the instrument.

Under the paragraph, TROUBLESHOOTING, you will find information on what to do if your system fails to meet specifications.

EQUIPMENT REQUIRED

Equipment required for the performance tests are listed in the Recommended Test Equipment tables under the tab Source System Guides, and Source Module Specifications and Service. Any equipment that satisfies the critical specifications given in the table may be substituted for the recommended models. Ensure also that the test equipment used is currently calibrated to proper specifications.

NOTE: Use only the connectors and cables that are specified in the following test setups to ensure accurate test results.

OPERATION VERIFICATION

The Operation Verification consists of performing the source module specific performance tests (Source Module Specifications and Service Section) which include, Maximum Leveled Power (verifies frequency range), Power Flatness, and Power Level Accuracy. These tests provide reasonable assurance that the source module is functioning properly and will meet the needs of an incoming inspection (80% verification).

TEST RECORD

Results of the performance tests may be recorded in the Test Record at the end of the procedures. The Test Record lists all of the tested specifications and their acceptable limits. Test results recorded at incoming inspection can be used for comparison in periodic maintenance and troubleshooting or after repairs.

FREQUENCY CHARACTERISTICS

Range
Accuracy
CW Resolution
Stability

MODULATION CHARACTERISTICS

External FM

The performance tests listed above are source dependent and can be found in the Performance Tests of the appropriate HP 83590 Series RF plug-in Operating and Service manual.

NOTE: When specifying the output frequency and modulation characteristics of the HP 83590 Series/83554A system, all frequency specifications will be referenced from the sources used and must be doubled because the HP 83554A is a frequency doubler. For special information about the doubler, refer to the A4 Multiplier Assembly theory of operation found in the Source Module Specifications and Service section of this manual.

SYSTEM HARMONICS

Specification

Harmonic related > 20 dBc (except for the HP 83592C which is >30dBc).

Description

The RF output signal from the HP 83590 Series/83554A system is tuned from 26.5 to 40.0 GHz and is displayed on a spectrum analyzer to verify that any harmonic spurious signals are at or below their specified levels. The test configuration in Figure 2-10 uses an external harmonic mixer to extend the frequency range of the spectrum analyzer. When this technique is used, the response is not pre-selected and multiple signals are displayed. Each response is examined not only for power level but whether or not it is a true in-band spurious signal by using the spectrum analyzer's signal identification function.

The following procedure addresses harmonic related spurious responses. The potential problem locations of harmonic related responses can be calculated by using the equations in Table 2-2. For any CW output signal from the HP 83554A mm-wave source module, accompanying harmonic responses may be present.

Equipment

RF Signal Source	HP 8350/HP 83590 Series RF Plug-in
Microwave Amplifiers	HP 8349B and HP 11975A
Spectrum Analyzer	HP 8566B
Directional Coupler	HP R752D
Harmonic Mixer	HP 11970A
RF Cables (3)	HP 5061-5458
Power Meter	HP 436A
Power Sensor	HP R8486A

Procedure

1. Connect the equipment as shown in Figure 2-10.

Turn on all system components.

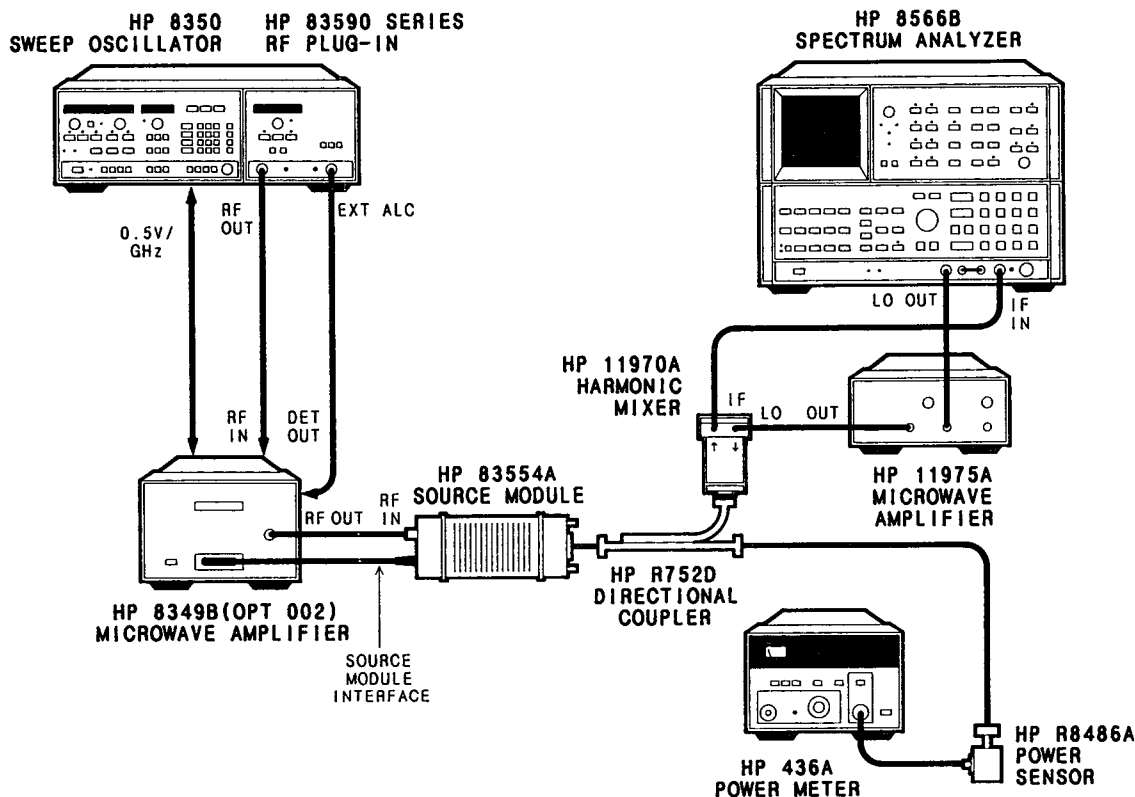

Figure 2-10. Spurious Signals Test Setup

Harmonic Related Spurious Signals

Harmonic related spurious signals are determined from the calculations in Table 2-2 below. The table is split into two frequency ranges, 26.5 to 27.0 GHz and 27.0 to 40.0 GHz. This frequency range split is determined from band switch points in the HP 83590 Series RF plug-in. Between 26.5 and 27.0 GHz, two possible harmonics of F2 (HP 83554A output frequency) may appear. Also, between 27.0 and 40.0 GHz, four possible harmonics may appear.

Table 2-2. Calculated Harmonic Frequencies

Fundamental Frequency	Fundamental Frequency
26.5 to 27.0 GHz	27.0 to 40.0 GHz
Harmonics	Harmonics
$5/4 \times F2$	$4/6 \times F2$
$6/4 \times F2$	$5/6 \times F2$
	$7/6 \times F2$
	$8/6 \times F2$

If the desired CW frequency output of the HP 83554A is within 26.5 to 27.0 GHz, the HP 83590 Series RF plug-in is in band 2. If the desired CW output frequency of the HP 83554A is within 27.0 to 40.0 GHz, the HP 83590 Series RF plug-in is in band 3. With the RF plug-in in band 2, all HP 83554A output frequencies (26.5 to 27.0 GHz) can be accompanied by two possible harmonic related spurs within the R-band frequency range, the 5/4 and 6/4 harmonic responses. For example, if the output frequency of the HP 83554A is 26.5 GHz, there may be accompanying harmonic spurs at 33.125 and 39.750 GHz. These are calculated as follows:

$$5/4 \times (26.5 \text{ GHz}) = 33.125 \text{ GHz}$$

$$6/4 \times (26.5 \text{ GHz}) = 39.750 \text{ GHz}$$

With the RF plug-in in band 3, all HP 83554A output frequencies (27.0 to 40.0 GHz) may be accompanied by four harmonic related spurs, the 4/6, 5/6, 7/6, and 8/6 harmonic responses, three of which may be present within the R-band frequency range at one time. For example, if the output frequency of the HP 83554A is 30.0 GHz, there will be accompanying harmonic spurs at 20.000, 25.000, 35.000, and 40.000 GHz. Since the harmonic spur at 20.000 GHz is not within the R-band frequency range, it will not appear at the output of the HP 83554A. The above harmonic spurs are calculated as follows:

$$4/6 \times (30.0 \text{ GHz}) = 20.000 \text{ GHz}$$

$$5/6 \times (30.0 \text{ GHz}) = 25.000 \text{ GHz}$$

$$7/6 \times (30.0 \text{ GHz}) = 35.000 \text{ GHz}$$

$$8/6 \times (30.0 \text{ GHz}) = 40.000 \text{ GHz}$$

2. On the HP 8350:

Press **[SHIFT] [INSTRUMENT PRESET]**

Press **[SHIFT] [START] [2] [MHz]**

Press **[SHIFT] [ALT]**

Press **[CW] [2] [6] [.] [5] [GHz]**

3. On the RF plug-in:

Press **[EXT] ALC MODE**

Press **[POWER LEVEL]**

Adjust the power level rotary knob for an 8.0 dBm reading on the RF plug-in display.

Adjust the EXT ALC CAL pot for an 8.0 dBm reading on the HP 8349B display.

4. Ensure that the HP 436A display reads 8.0 dBm \pm 2.00 dB.

5. On the HP 8566B:

Press **[INSTR PRESET]**

Press **[SHIFT] [▲] [▲]** until the **FULL BAND K (A)** annotation appears. This places the analyzer into an external mixing mode allowing R-band frequency range capability. Note the start/stop frequency at the bottom of the screen and ensure that the start frequency is 26.5 GHz and the stop frequency is 40.0 GHz.

Press **[REF LEVEL] [8] [.] [0] [+dBm]**

Press **DISPLAY LINE [ENTER] [1] [2] [-dBm]**, setting the 20 dBc reference.

Amplitude Calibration of the HP 8566B

The HP 8566B spectrum analyzer can make amplitude calibrated measurements of millimeter signals when configured with the HP 11970 mixers. A calibration graph that shows conversion loss and reference level offset is provided with each mixer so that the analyzer can be normalized to that mixer. The following explanation illustrates how this offset is entered into the spectrum analyzer.

In the external mixing mode, the HP 8566B gain is automatically increased 30 dB to compensate for the conversion loss of an external mixer. Using the information from the graph supplied with the mixer, you can offset the reference level to obtain precise amplitude calibration for point by point frequency measurements. For example, if the calibration table indicates the Reference Level Offset for a frequency of 30.0 GHz is -6.8 dB, this offset would be entered by pressing:

[SHIFT] [REF LEVEL] [6] [.] [8] [-dBm]

With this offset entered, the HP 8566B is amplitude calibrated at 30.0 GHz. If less accurate measurements are tolerated, normalizing the conversion loss graph on the HP 11970 can be accomplished by averaging the graph's maximum and minimum power points resulting in an overall conversion loss for the entire band. By using this method, an increase of measurement uncertainty is introduced into the test. Reference level offset is determined by the following equation:

$$\text{Conversion Loss} - 30 \text{ dB} = \text{Reference Level Offset}$$

Because the test configuration in Figure 2-10 specifies that the external mixer be connected to the coupled arm of a 20 dB directional coupler, the coupled power must also be taken into account when calculating reference level offset. The new equation is as follows:

$$\text{Conversion Loss} + \text{coupled power (20 dB)} - 30 \text{ dB} = \text{Reference Level Offset}$$

6. On the HP 8350:

Manually tune the HP 8350 from 26.5 to 37.2 GHz while watching for harmonic responses that are higher than the display line (< 20 dBc) on the HP 8566B display.

Signal Identification

7. If a harmonic related spurious signal is found, verify whether or not it is a true in-band signal by using the spectrum analyzer's signal identification feature. This is performed as follows:
8. Tune the signal under observation to center screen on the HP 8566B display.
9. Press **[SHIFT] [FREE RUN]**
10. If the signal is a false response, the annotation **IDENTIFIED OUT OF BAND** will appear on the display.
11. Ensure that any harmonic-related spurious signals observed are within the specified level of > 20 dBc.

Measurement Uncertainty

Measurement uncertainty within the test configuration will affect the accuracy of this performance test. To obtain optimum accuracy, amplitude calibrate the spectrum analyzer by entering the conversion loss at each frequency signal under observation as explained under **Amplitude Calibration of the HP 8566B**. Any harmonic-related spurious signals that are close to or at 20 dBc should be given an allowable margin of ± 1.5 dB to compensate for all other measurement uncertainties within the test configuration.

12. The foregoing steps performed a harmonic related spurious test from 26.5 to 37.2 GHz at a specified maximum leveled power of 8.0 dBm. The proceeding steps will continue this test covering the remaining frequency range of the R-band (37.2 to 40.0 GHz) at a maximum leveled power of 7.0 dBm.

13. On the RF plug-in:

Press **[POWER LEVEL]**

Adjust the power level rotary knob for a 7.0 dBm reading on the HP 8349B display.

14. Ensure that the HP 436A display reads 7.0 dBm \pm 0.5 dB.

15. On the HP 8566B:

Press **[REF LEVEL] [7] [.] [0] [+dBm]**

Press **DISPLAY LINE [ENTER] [1] [3] [-dBm]**, setting the 20 dBc reference.

16. Repeat steps 6 through 11 except this time tune the HP 8350 from 37.2 to 40.0 GHz.

This concludes the performance test for harmonic related spurious signals. Performance of this test ensures that all potential problem harmonic related spurious locations have been thoroughly tested for the HP 83590 Series/83554A system.

If your system fails to meet these specifications, refer to the paragraph titled TROUBLESHOOTING.

Table 2-3. Performance Test Record

HP 83590 Series System				
Serial Number _____		Date _____		
Humidity* _____		Tested By _____		
(Optional)		Temperature _____		
Specification Tested	Test Conditions	Specification	Test Results	
			Pass	Fail
FREQUENCY				
Range ¹	_____	26.5 to 40.0 GHz ¹	_____	_____
Accuracy ¹	_____	± 20 MHz ¹	_____	_____
CW Resolution ¹	_____	52 kHz ¹	_____	_____
Stability ¹				
With Temperature, typically	_____	± 1.2 MHz/°C ¹	_____	_____
With 10% Line Voltage Change	_____	± 300 kHz ¹	_____	_____
With Time (in a 10 min period)	_____	< ± 600 kHz ¹	_____	_____
Residual FM, Peak (20 Hz to 15 kHz BW, CW Mode)	_____	< 18 kHz ¹	_____	_____
MODULATION				
External FM Maximum Deviations for Modulation				
Frequencies				
Crossover Coupled				
DC to 100 Hz	_____	± 150 MHz ¹	_____	_____
100 Hz to 1 MHz	_____	± 14 MHz ¹	_____	_____
1 MHz to 2 MHz	_____	± 10 MHz ¹	_____	_____
2 MHz to 10 MHz	_____	± 2 MHz ¹	_____	_____
Direct Coupled (– 40 MHz/V only)				
DC to 100 Hz	_____	± 24 MHz ¹	_____	_____
100 Hz to 1 MHz	_____	± 14 MHz ¹	_____	_____
1 MHz to 2 MHz	_____	± 10 MHz ¹	_____	_____
2 MHz to 10 MHz	_____	± 2 MHz ¹	_____	_____
OUTPUT				
System Harmonics	_____	> 20 dBc ²	_____	_____

1. These specifications are referenced from the appropriate HP 83590 Series RF plug-in manuals and have been multiplied by a factor of 2 because the HP 83554A is a frequency doubler.
 2. Applies to all HP 83590 Series plug-ins except for the HP 83592C which is > 30 dBc.

TROUBLESHOOTING

Specification Failures

Failures are divided into two categories:

Category one describes systems that are meeting specifications in some areas, while failing others. If this is the case, do the following:

- Inspect the connectors and ensure that all connections are making good electrical contact.

- Inspect all cabling for breaks.

- Test again.

If your system is still failing at the SAME points, your instrument(s) or cable(s) could be defective and should be returned for repair. If, however, your system fails at DIFFERENT points, there is probably a loose connection or a mechanical failure somewhere in the setup.

Remember, it is possible the system may fail the performance test(s) because of measurement uncertainties. If you suspect this to be the case contact your nearest HP office for more information.

Category two failures are total specification failures. If your system fails any of these tests completely, do the following:

- Check the TEST SETUP for correct configuration of the instruments and connections.

- Inspect the connectors.

- Inspect the cables.

- Repeat the failed test(s).

If your system is still failing, the system is probably defective and needs repair.

Remember for the best accuracy in measurement, use only calibrated instruments.

Troubleshooting System Harmonics

If the HP 83590 Series/83554A system fails to meet the specifications mentioned in step 6 of the System Harmonics test, the failure may be occurring from either the HP 83590 Series RF plug-in, the HP 8349B, or the HP 83554A mm-wave source module. The following steps will help to isolate the origin of the failure. See Figure 2-11 for harmonic power check points.

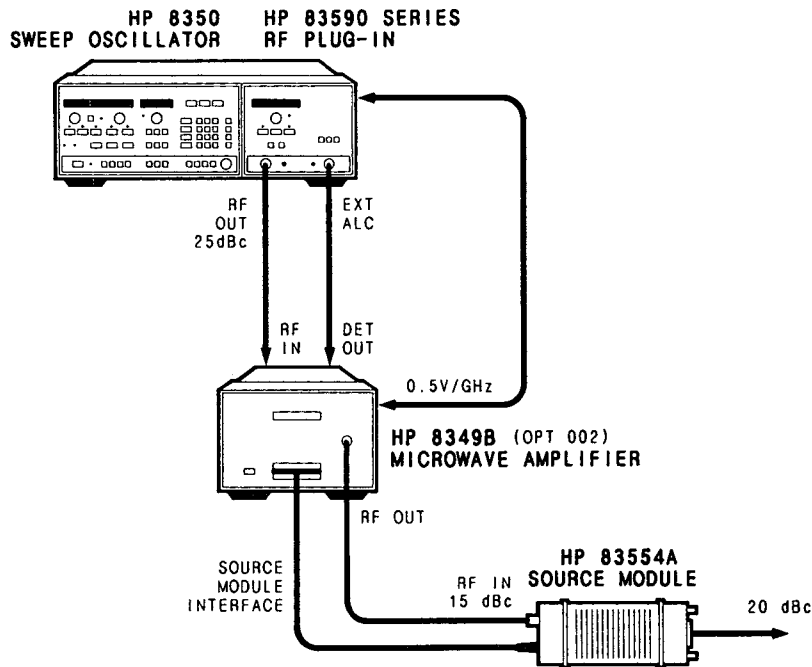

Figure 2-11. Harmonic Check Points

1. If the harmonic related spurious output from the HP 83554A is less than 20 dBc, check the harmonic output of the HP 8349B and ensure that it is > 15 dBc.
2. If the HP 8349B harmonic output is within specifications, refer to the Source Module Specifications and Service section of this manual and perform the Harmonics Spurious performance test to verify that the HP 83554A is at fault. If the HP 83554A is at fault, refer to the Source Module Specifications and Service Section for repair or replacement of the instrument.
3. If the HP 8349B harmonic output is < 15 dBc, continue to step 4.
4. Check the spurious signal output level of the HP 83590 Series RF plug-in by referring to the appropriate HP 83590 Series Operating and Service manual for the Spurious Signals performance test to verify whether or not the RF plug-in is at fault. The specified harmonic related spurious output level should be > 25 dBc. If the spurious signals are within specification, repair or replace the HP 8349B.
5. If the HP 83590 Series RF plug-in exceeds harmonic output specifications, repair or replace the RF plug-in.

REGIONAL SALES AND SUPPORT OFFICES

For information relating to Sales or Support of Hewlett-Packard products first contact your local Hewlett-Packard office listed in the white pages of your telephone directory. If none is listed locally, contact one of the addresses listed below to obtain the address or phone number of the Hewlett-Packard Sales or Support office nearest you.

ASIA

Hewlett-Packard Asia Ltd.
47/F, 26 Harbour Road,
Wanchai, **HONG KONG**
G.P.O. Box 863, Hong Kong
Tel: (852) 5-8330833
Telex: 76793 HPA HX
Cable: HPASIAL TD

AUSTRALASIA

Hewlett-Packard Australia Ltd.
31-41 Joseph Street
BLACKBURN, Victoria 3130
Australia
Tel: (61) 895-2895
Telex: 31-024
Cable: HEWPARD Melbourne

CANADA

Hewlett-Packard (Canada) Ltd.
6877 Goreway Drive
MISSISSAUGA, Ontario L4V 1M8
Tel: (416) 678-9430
Telex: 069-8644

JAPAN

Yokogawa-Hewlett-Packard Ltd.
29-21 Takaido-Higashi, 3 Chome
Suginami-ku **TOKYO** 168
Tel: 03 (331) 6111
Telex: 232-2024 YHPTOK

MEDITERRANEAN AND MIDDLE EAST

Hewlett-Packard S.A.
Mediterranean and Middle East
Operations
Atrina Centre
32 Kifissias Avenue
Paradissos-Amarousion, **ATHENS**
Greece
Tel: (30) 682 88 11
Telex: 21-6588 HPAT GR
Cable: HEWPACKSA Athens

BENELUX & SCANDINAVIA

Hewlett-Packard S.A.
Uilenstede 475
P.O. Box 999
NL-1183 AG AMSTELVEEN
The Netherlands
Tel: (31) 20/43 77 71
Telex: 18 919 hpner nl

SOUTH & EAST EUROPE, AFRICA

Hewlett-Packard S.A.
7, rue du Bois-du-Lan
CH-1217 MEYRIN 2, Geneva
Switzerland
Tel: (41) 22/83 12 12
Telex: 27835 hmea
Cable: HEWPACKSA Geneve

FRANCE

Hewlett-Packard France
Parc d'activités du Bois Briard
2, avenue du Lac
91040 **EVRY** Cedex
Tel: 1 6/077 83 83
Telex: 6923 15F

GERMAN FEDERAL REPUBLIC

Hewlett-Packard GmbH
Hewlett-Packard-Strasse
Postfach 1641
D-6380 **BAD HOMBURG**
West Germany
Tel: 06172/400-0
Telex: 410 844 hpbhg

ITALY

Hewlett-Packard Italiana S.p.A.
Via G. Di Vittorio 9
1-20063 **CERNUSCO SUL
NAVIGLIO**
(Milano)
Tel: 02/92 36 91
Telex: 334632

UNITED KINGDOM

Hewlett-Packard Ltd.
King Street Lane
Winnersh, **WOKINGHAM**
Berkshire RG11 5AR
Tel: 734/78 47 74
Telex: 847178

EASTERN USA

Hewlett-Packard Co.
4 Choke Cherry Road
ROCKVILLE, MD 20850
Tel: (301) 670-4300

MIDWESTERN USA

Hewlett-Packard Co.
5201 Tollview Drive
ROLLING MEADOWS, IL 60008
Tel: (312) 255-9800

SOUTHERN USA

Hewlett-Packard Co.
2000 South Park Place
P.O. Box 105005
ATLANTA, GA 30348
Tel: (404) 955-1500

WESTERN USA

Hewlett-Packard Co.
5161 Lankershim Blvd.
P.O. Box 3919
NO. HOLLYWOOD, CA 91609
Tel: (818) 506-3700

OTHER INTERNATIONAL AREAS

Hewlett-Packard Co.
Intercontinental Headquarters
3495 Deer Creek Road
PALO ALTO, CA 94304
Tel: (415) 857-1501
Telex: 034-8300
Cable: HEWPACK



**HP 8340 Series
Source System Guide**

HP 83554A SOURCE MODULE

For use with
HP 8340A Series
HP 8349B

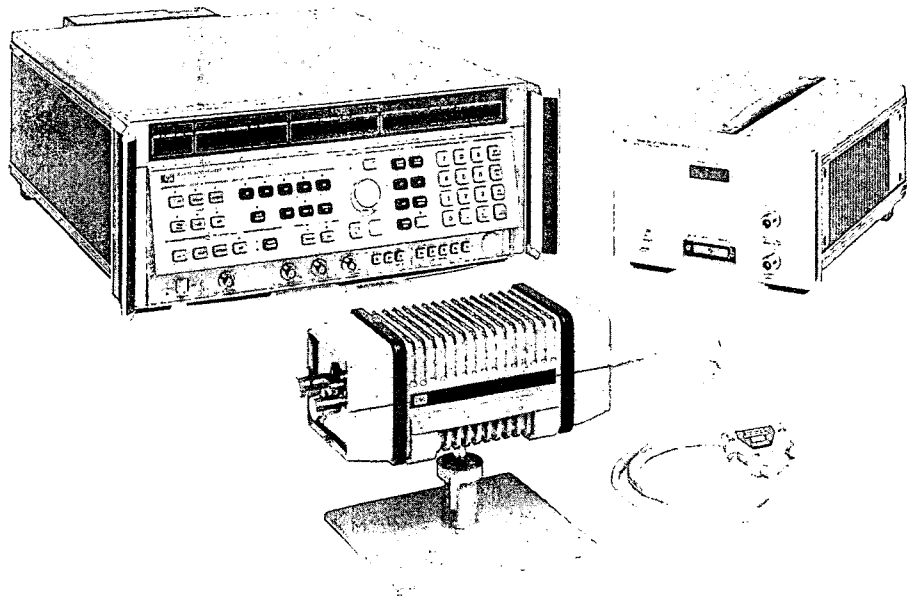

**HEWLETT
PACKARD**

CERTIFICATION

Hewlett-Packard Company certifies that this product met its published specifications at the time of shipment from the factory. Hewlett-Packard further certifies that its calibration measurements are traceable to the United States National Bureau of Standards, to the extent allowed by the Bureau's calibration facility, and to the calibration facilities of other International Standards Organization members.

WARRANTY

This Hewlett-Packard system product is warranted against defects in materials and workmanship for a period corresponding to the individual warranty periods of its component products. Computer and computer peripherals are warranted for a period of 90 days. Instruments are warranted for a period of one year. During the warranty period, Hewlett-Packard Company will, at its option, either repair or replace products which prove to be defective.

Warranty service for products installed by HP and certain other products designated by HP will be performed at Buyer's facility at no charge with HP service travel areas. Outside HP service travel areas, warranty service will be performed at Buyer's facility only upon HP's prior agreement and Buyer shall pay HP's round trip travel expenses. In all other areas, products must be returned to a service facility designated by HP.

For products returned to HP for warranty service, Buyer shall prepay shipping charges to HP and HP shall pay shipping charges to return the product to Buyer. However, Buyer shall pay all shipping charges, duties, and taxes for products returned to HP from another country.

HP warrants that its software and firmware designated by HP for use with an instrument will execute its programming instructions when properly installed on that instrument. HP does not warrant that the operation of the instrument, or software, or firmware will be uninterrupted or error free.

LIMITATION OF WARRANTY

The foregoing warranty shall not apply to defects resulting from improper or inadequate maintenance by Buyer, Buyer-supplied software or interfacing, unauthorized modification or misuse, operation outside of the environmental specifications for the product, or improper site preparation or maintenance.

NO OTHER WARRANTY IS EXPRESSED OR IMPLIED. HP SPECIFICALLY DISCLAIMS THE IMPLIED WARRANTIES OR MERCHANTABILITY AND FITNESS FOR A PARTICULAR PURPOSE.

EXCLUSIVE REMEDIES

THE REMEDIES PROVIDED HEREIN ARE BUYER'S SOLE AND EXCLUSIVE REMEDIES. HP SHALL NOT BE LIABLE FOR ANY DIRECT, INDIRECT, SPECIAL, INCIDENTAL, OR CONSEQUENTIAL DAMAGES, WHETHER BASED ON CONTRACT, TORT, OR ANY OTHER LEGAL THEORY.

ASSISTANCE

Product maintenance agreements and other customer assistance agreements are available for Hewlett-Packard products.

For any assistance, contact your nearest Hewlett-Packard Sales and Service Office. Addresses are provided at the back of this manual.

**HP 83554A
MILLIMETER-WAVE
SOURCE MODULE**

**For use with
HP 8340A Series
HP 8349B**

SERIAL NUMBERS

This manual applies directly to HP 83554A Millimeter-wave source modules having serial prefix 2612A.

For additional information about serial numbers, refer to INSTRUMENTS COVERED BY MANUAL in System General Information.

©Copyright HEWLETT-PACKARD COMPANY 1986
1400 FOUNTAINGROVE PARKWAY, SANTA ROSA, CA 95401 U.S.A.

MANUAL PART NO. 83554-90007
Microfiche Part Number 83554-90014

Printed: APRIL 1986



**HEWLETT
PACKARD**

TABLE of CONTENTS
HP 8340A/41A SERIES SOURCE SYSTEM GUIDE

Introduction
System Specifications
Operation
Operator's Check
System Performance Tests
 Introduction
 Frequency Characteristics
 System Harmonics
Troubleshooting

HP 8340A/41A Series Source System Guide

INTRODUCTION

This source system guide is intended to provide you with mm-wave system operating information for the HP 8340A/41A Series synthesizers. It contains an operator's check, connection diagrams, system specifications, system performance tests, and system level troubleshooting. For detailed instructions regarding the operation or troubleshooting of the individual instruments, refer to the instrument's operating and service manual.

SYSTEM DESCRIPTION

The HP 8340A (10 MHz to 26.5 GHz) and 8341A (10 MHz to 20 GHz) synthesized sweepers (unless otherwise stated will be hereafter referred to as the HP 8340A/41A) operate over the frequency range required by the HP 83554A millimeter-wave source module.

The HP 8340A/41A synthesized sweeper combines with an HP 8349B microwave amplifier (with the built-in source module interface) to deliver the required 13.25 to 20 GHz input frequency and > 17 dBm of output power for driving the HP 83554A source module.

For proper display accuracy, leveling flatness, and harmonic suppression, the 1.0V/GHz output on your HP 8340A/41A will have to be modified for a 0.5V/GHz output. Provided with your mm-wave source module is a set of modification instructions. This modification procedure will apply to your source, enabling you to properly convert your instrument to 0.5V/GHz output operation.

WARNING

This equipment is capable of radiating millimeter-wave energy from the end of unterminated waveguide. Do not look directly into the open end of any waveguide when it is connected to a source of millimeter-wave energy.

Take precautions consistent with ANSI C95.1 - 1982, a study performed by the American National Standards Institute that sets limits for human exposure to microwave and millimeter-wave energy. Copies of this publication are available from:

**American National Standards Institute
1430 Broadway
New York, N. Y. 10018**

OPERATION

INTRODUCTION

This section is intended for operators familiar with the HP 8340A/41A instruments. If you are unfamiliar with this system, refer to the Operator's check at the end of this section for more specific instructions.

In the operation instructions, any instrument setting or function key is defined by [] symbols around it.

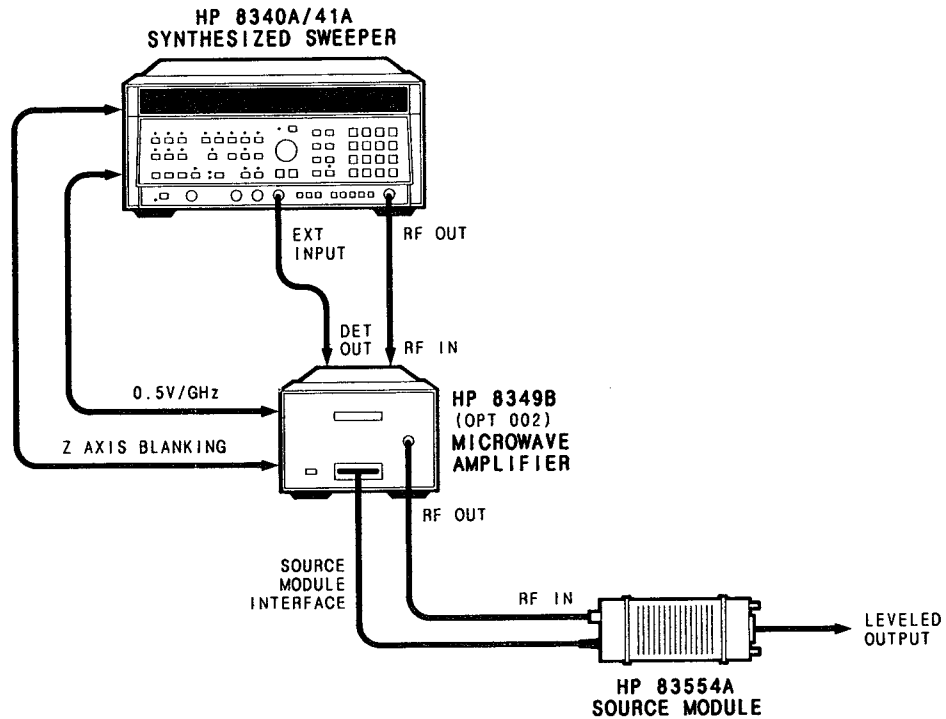

Figure 2-1. HP 8340A/41A/83554A Source System Configuration



Turn off the ac power on the HP 8349B prior to connecting or disconnecting the source module interface cable.

Connect the system as shown in Figure 2-1.

FREQUENCY CONTROL

After the connections have been made, turn on the system, and press [INSTR PRESET] on the HP 8340A/41A. Allow instruments to warm-up 30 minutes. Next, enter a display multiplier on the HP 8340A/41A so that the multiplied output frequency will be correctly displayed. A multiplication factor of two should be entered by pressing:

[SHIFT] [START] [2] [Hz]

Once the multiplication factor is entered you can now directly set the frequency range of interest on the HP 8340A/41A front panel.

NOTE: Entering frequencies outside 26.5 to 40.0 GHz (13.25 to 20.0 GHz) are invalid and the system will not work properly.

The multiplication factor may be reset to one by pressing:

[INSTR PRESET]

or by entering a multiplication factor of one by pressing:

[SHIFT] [START] [1] [Hz]

The multiplication factor may be "locked" by pressing:

[SHIFT] [ALT]

This eliminates having to re-enter the multiplication factor each time INSTR PRESET is pressed.

The lock may be removed and the multiplication factor may be reset to one by pressing:

[SHIFT] [INSTR PRESET]

POWER LEVEL CONTROL



Before performing any power level calibrations, ensure that the HP 8340A/41A synthesizer is not at maximum power.

To activate external leveling, **[XTAL]** must be pressed, therefore power is controlled by pressing **[XTAL]** or **[POWER LEVEL]**. Once activated, the display will read "ATTN: - XX dB REF: - XX.XX dBv". The HP 8340A/41A internal attenuator is controlled by the step keys and should be set to 0 dB. The rotary knob or keypad controls the output power from the synthesizer. The actual output power from the mm-wave source module is read on the HP 8349B microwave amplifier's display in dBm.

POWER LEVELING

System Leveling

The HP 8340A/41A/83554A configuration shown in Figure 2-1 provides leveled source module output power with corrected power level flatness. With the XTAL key on, a portion of the source module output power is coupled out of a directional coupler and detector internal to the source module. This signal is processed and fed through the HP 8349B DET OUT and applied to the HP 8340A/41A ALC circuit.

External Crystal Detector Leveling

Figure 2-2 illustrates a typical crystal detector leveling setup. Directional couplers and crystal detectors are used to level the source module output power. The RF output power at the waveguide output of the source module is read on the HP 8349B display.

Set the LEVELING mode to **[XTAL]**. A portion of the HP 83554A source module output signal is sampled and applied to the HP 8340A/41A external ALC circuit.

Maximum specified power and flatness may not be achieved when using an external leveling technique as a result of leveling coupler losses.

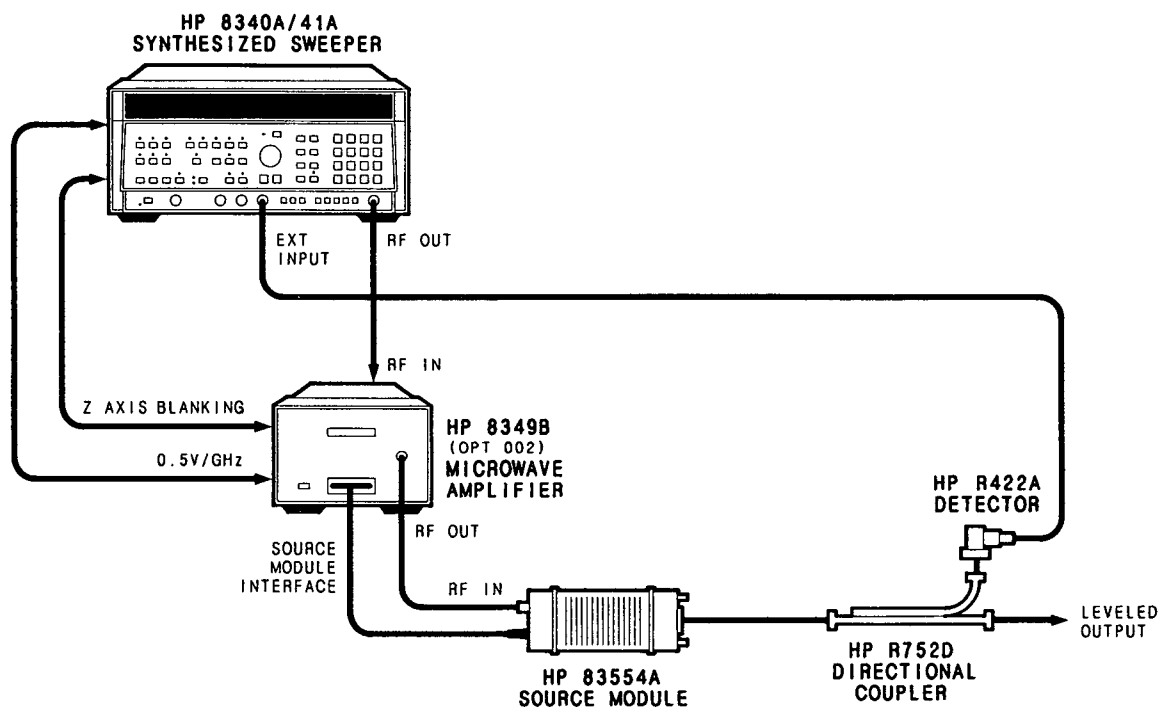

Figure 2-2. External Crystal Detector Leveling at the HP 83554A Source Module Output

External Power Meter Leveling

Output power may also be leveled with a power meter and a directional coupler as shown in Figure 2-3. Power meter leveling at the source module output is possible using the power meters referenced in Table 1 (System General Information).

Set the ALC mode to **[METER]** on the HP 8340A/41A. The sweep time is limited to 100 seconds when this leveling method is used. A portion of the mm-wave output signal from the source module is coupled/detected and routed to the power meter. The DC voltage from the power meter recorder output is then applied to the HP 8340A/41A external ALC circuit.

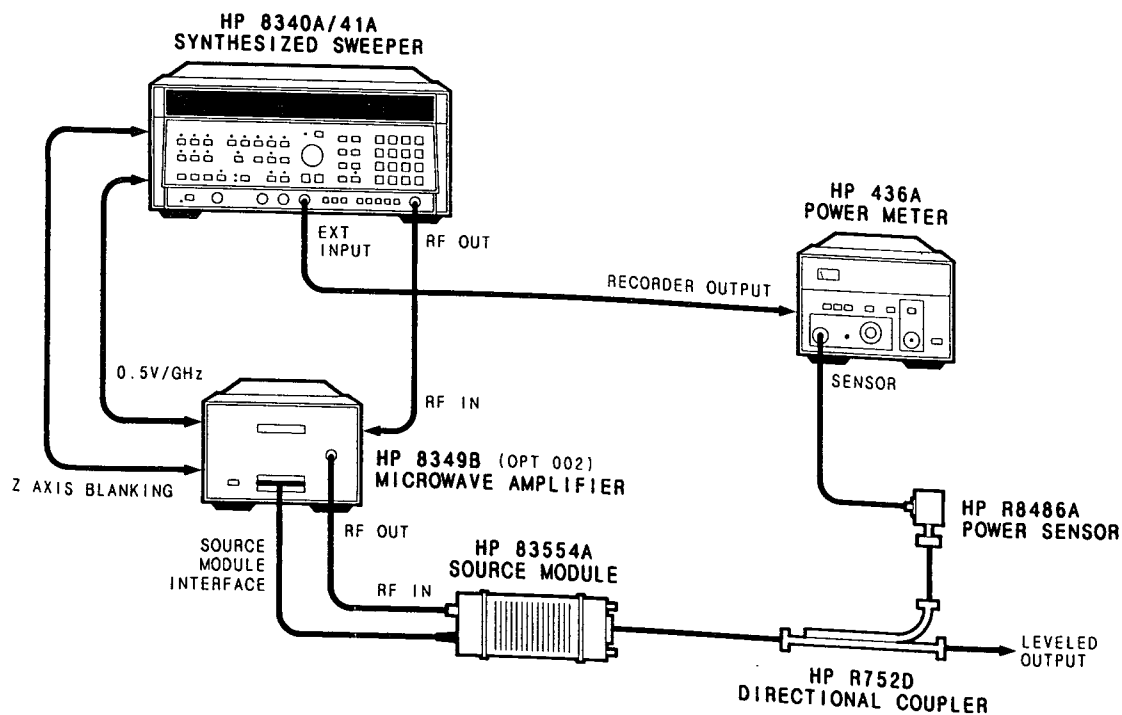

Figure 2-3. External Power Meter Leveling at the HP 83554A Source Module Output

MODULATION

For complete specifications on all modulation modes described below, refer to Table 2-1 (HP 8340A/41A/83554A System Specifications).

NOTE: The modulation characteristics described below are performed with the HP 8340A/41A in the internally leveled mode providing unleveled output power from the HP 83554A, defined as the system unleveled mode of operation.

Amplitude Modulation (AM Connector on HP 8340A/41A)

When the AM key is activated, the AM input is used for linear, DC-coupled amplitude modulation. The small signal – 3dB bandwidth extends from DC to 100 kHz.

The sensitivity is 100% per volt. This means that +1.0 volt doubles the output voltage (+6 dB), while –1.0 volt shuts the output completely off.

For maximum modulation index, the HP 83554A source module should be set to a power level 3 dB below maximum power.

Pulse Modulation (PULSE Connector on HP 8340A/41A)

With the PULSE key activated, and the HP 8340A/41A internally leveled (system unleveled mode), the application of a pulsed or square wave signal to the PULSE connector provides a pulsed or square wave modulated signal at the output of the HP 83554A. This input provides an ON/OFF power ratio of typically greater than 80 dB. The PULSE IN input is normally at a TTL HIGH (approximately +3 volts DC). When a TTL LOW signal (approximately 0 volts DC) is applied, the mm-wave output signal is turned off.

OPERATING SUGGESTIONS

When using an HP 8340A/41A synthesizer as the source driver, you can optimize the ALC loop performance by using fixed attenuator(s). For example, typical HP 8340A/41A/83554A system power levels (not optimized) over the specified range, are as follows:

SYNTHESIZER (dBm)		HP 8349B (dBm)		HP 83554A (dBm)
DISPLAY	OUTPUT	DISPLAY	OUTPUT	OUTPUT
-12.0	-12.0	+8.0	+12.0	+8.0
-22.0	-22.0	-5.0	-1.0	-5.0

The RF synthesizer power output levels are quite low and can possibly reach the lower limit of the ALC modulator range. By adding a fixed attenuator(s) between the RF synthesizer and the HP 8349B amplifier, the overall system power level will decrease. A corresponding change in ALC drive signal will cause the RF synthesizer to increase output power to correct for the apparent power loss and thereby operate at a more desirable ALC level.

OPERATOR'S CHECK

DESCRIPTION

The following procedure will enable you to verify the proper operation of your HP 8340A/41A/83554A system by determining the system's output power and flatness performance over the R-band frequency range of 26.5 to 40.0 GHz at maximum leveled output power. Maximum leveled output power is split into two specifications across the band, +8.0 dBm (26.5 to 37.2 GHz) and +7.0 dBm (37.2 to 40.0 GHz). Therefore, the subsequent procedure will test the power flatness at both power levels.

EQUIPMENT

Ensure that all the instruments below meet their own performance standards and have been recently calibrated to proper specifications before configuring them into the setup.

RF Signal Source	HP 8340A/41A Synthesized Sweeper
Microwave Amplifier	HP 8349B
Power Meter	HP 436A
Power Sensor	HP R8486A

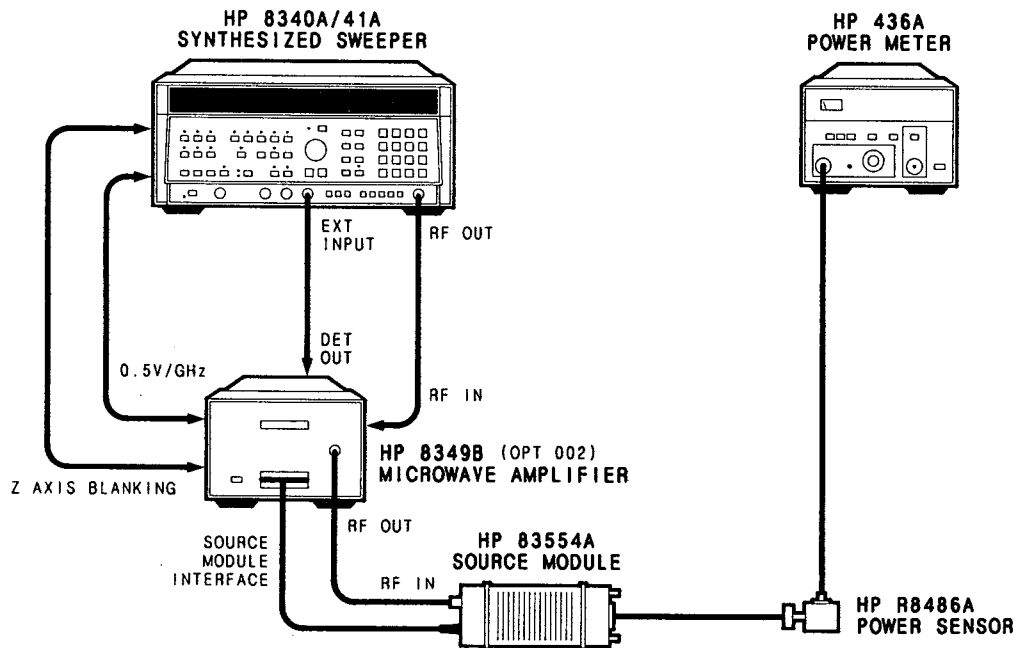

Figure 2-4. System Configuration

PROCEDURE

1. Connect the equipment as shown in Figure 2-4. Do not connect the HP R8486A power sensor to the HP 83554A output.



Turn off the AC power on the HP 8349B prior to connecting or disconnecting from the source module interface connector.

2. Turn on all system components.

3. On the power meter:

Press **[dBm]** mode.

Zero and calibrate the power meter. Set the CAL FACTOR at 100%. The CAL FACTOR will **not** be changed for the rest of the procedure. By leaving the CAL FACTOR at 100%, it ensures minimum specifications will be met.

4. On the HP 8340A/41A:

Press **[SHIFT] [INSTR PRESET]**

Press **[SHIFT] [START] [2] [Hz]**

Press **[SHIFT] [ALT]**

Press **[XTAL] EXT INPUT** leveling

Press **[CW] [2] [6] [.] [5] [GHz]**

Connect the HP R8486A power sensor to the HP 83554A output.

Press **[POWER LEVEL]** and adjust rotary knob for an 8.0 dBm reading on the HP 436A display. Ensure that the HP 436A power meter display is within 2.00 dB of the HP 8349B display.

NOTE: Ensure that the **[AM MOD]** button is in the **off** state or it will affect the accuracy of this test.

5. Press **[CW]**

While observing the HP 436A display, find the minimum power point between 26.5 to 37.2 GHz by slowly adjusting the rotary knob. Note at what frequency the minimum power point is. See Figure 2-5.

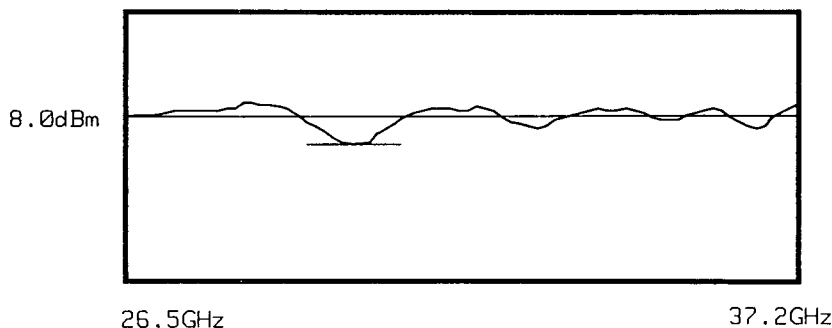

Figure 2-5. Minimum Power Point (26.5 to 37.2 GHz)

Enter the frequency at the minimum power point by pressing **[CW] XX.XX [GHz]**

6. Press **[POWER LEVEL]** and adjust the rotary knob until you obtain an 8.0 dBm reading on the HP 436A display.

7. Press **[CW] [2] [6] [.] [5] [GHz]**
Press **[SAVE] [1]**

Tune the rotary knob from 26.5 to 37.2 GHz and ensure that the power level displayed on the HP 436A never exceeds 10.5 dBm. This ensures that from 26.5 to 37.2 GHz, the system's power flatness is within ± 1.25 dB of maximum leveled power, 8.0 dBm. See Figure 2-6.

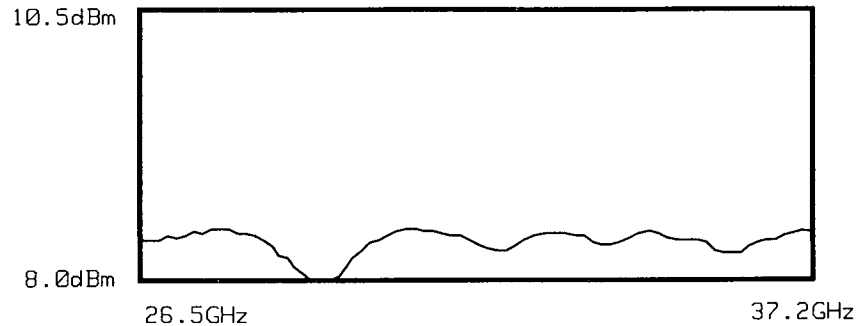

Figure 2-6. Power Flatness Response (26.5 to 37.2 GHz)

The foregoing procedure completes the operator's check from 26.5 GHz to 37.2 GHz. To test the remaining portion of the R Band (37.2 to 40.0 GHz), follow the proceeding steps.

8. On the HP 8340A/41A:

Press **[RECALL] [1]**

Press **[POWER LEVEL]** and adjust the rotary knob for a 7.0 dBm reading on the HP 436A display.

Find the minimum power point between 26.5 to 40.0 GHz by slowly adjusting the rotary knob from 26.5 to 40.0 GHz. Note at what frequency the minimum power point is. See Figure 2-7.

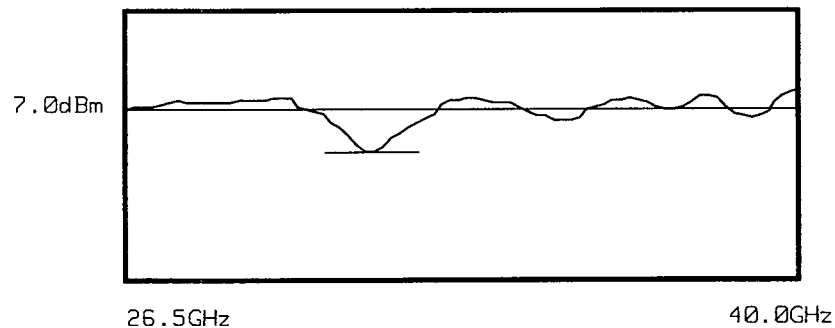

Figure 2-7. Minimum Power Point

Enter the frequency of the minimum power point by pressing **[CW] XX.XX [GHz]**

Press **[POWER LEVEL]** and adjust the rotary knob for a 7.0 dBm reading on the HP 436A display.

Press **[CW] [2] [6] [.] [5] [GHz]**

Slowly rotate the rotary knob from 26.5 to 40.0 GHz. Observe the HP 436A display through the entire band making sure that the power level displayed never exceeds 9.5 dBm. This ensures that the system's power flatness is within ± 1.25 dB of maximum leveled power. See Figure 2-8.

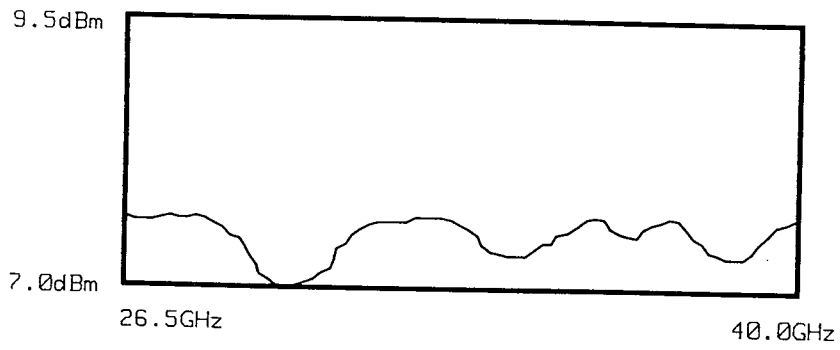

Figure 2-8. Power Flatness Response (26.5 to 40.0 GHz)

This completes the Operator's Check. If your system fails this functional check, refer to the paragraph titled TROUBLESHOOTING.

SYSTEM PERFORMANCE TESTS

INTRODUCTION

The procedures in this section test the performance of the HP 8340A/41A/83554A source system using the specifications of Table 2-1 as the performance standards. All tests can be performed without access to the interior of the instrument. The performance test procedures must be performed in the sequence given since some procedures rely on satisfactory test results in the foregoing steps. In order to fully verify the performance specifications of the HP 83554A, the performance tests in the Source Module Specifications and Service Section must also be performed. None of the tests require access to the interior of the instrument.

Under the paragraph, TROUBLESHOOTING, you will find information on what to do if your system fails to meet specifications.

EQUIPMENT REQUIRED

Equipment required for the performance tests are listed in the Recommended Test Equipment tables under the tabs Source System Guides, and Source Module Specifications and Service. Any equipment that satisfies the critical specifications given in the table may be substituted for the recommended models. Ensure also that the test equipment used is currently calibrated to proper specifications.

NOTE: Use only the connectors and cables that are specified in the following test setups to ensure accurate test results.

OPERATION VERIFICATION

The Operation Verification consists of performing the source module specific performance tests (Source Module Specifications and Service Section) which include, Maximum Leveled Power (verifies frequency range), Power Flatness, and Power Level Accuracy. These tests provide reasonable assurance that the source module is functioning properly and should meet the needs of an incoming inspection (80% verification).

TEST RECORD

Results of the performance tests may be recorded in the Test Record at the end of the procedures. The Test Record lists all of the tested specifications and their acceptable limits. Test results recorded at incoming inspection can be used for comparison in periodic maintenance and troubleshooting or after repairs.

FREQUENCY CHARACTERISTICS

Range
Accuracy
CW Resolution
Stability

The performance tests listed above are source dependent and can be found under the following performance tests in the appropriate HP 8340A/41A synthesized sweeper Operating and Service Manual: Internal Time Base Aging Rate, Frequency Range and CW Mode Accuracy, Sweep Time Accuracy, and Swept Frequency Accuracy. Only by performing these specific tests can the frequency characteristics of the HP 8340A/41A/83554A system be verified.

NOTE: When specifying the output frequency characteristics of the HP 8340A/41A/83554A system, all frequency specifications are referenced from the sources used and must be doubled because the HP 83554A is a frequency doubler. For special information about the doubler, refer to the A4 Multiplier Assembly theory of operation found in the Source Module Specifications and Service Section of this manual.

SYSTEM HARMONICS

Specification

Harmonic related > 20 dBc

Description

The RF output signal from the HP 8340A/41A/83554A system is tuned from 26.5 to 40.0 GHz and is displayed on a spectrum analyzer to verify that any harmonic spurious signals are at or below their specified levels. The test configuration in Figure 2-9 uses an external harmonic mixer to extend the frequency range of the spectrum analyzer. When this technique is used, the response is not pre-selected and multiple signals are displayed. Each response is examined not only for power relative to the fundamental frequency but whether or not it is a true in-band spurious signal by using the spectrum analyzer's signal identification function.

The following procedure addresses harmonic related spurious responses. The potential problem locations of harmonic related responses can be calculated by using the equations in Table 2-2. For any CW output signal from the HP 83554A mm-wave source module, accompanying harmonic responses may be present.

Equipment

RF Signal Source	HP 8340A/41A Synthesizer Sweeper
Microwave Amplifiers	HP 8349B and HP 11975A
Spectrum Analyzer	HP 8566B
Directional Coupler	HP R752D
Harmonic Mixer	HP 11970A
RF Cables (3)	HP 5061-5458
Power Meter	HP 436A
Power Sensor	HP R8486A

Procedure

1. Connect the equipment as shown in Figure 2-9.

Turn on all system components.

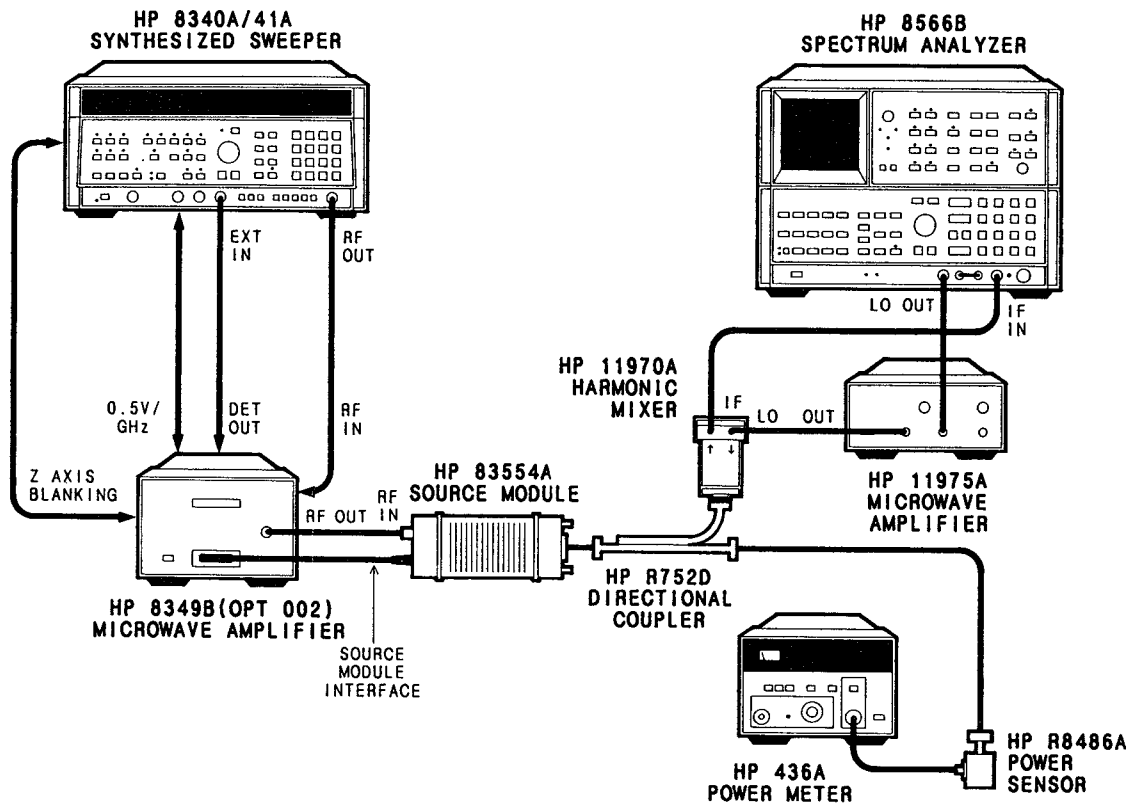

Figure 2-9. Spurious Signals Test Setup

Harmonic Related Spurious Signals

Harmonic related spurious signals are determined from the calculations in Table 2-2 below. The table is split into two frequency ranges, 26.5 to 27.0 GHz and 27.0 to 40.0 GHz. This frequency range split is determined from band switch points in the HP 8340A/41A synthesizer. Between 26.5 and 27.0 GHz, two possible harmonics of F₂ (HP 83554A output frequency) may appear. Also, between 27.0 and 40.0 GHz, four possible harmonics may appear.

Table 2-2. Calculated Harmonic Frequencies

Fundamental Frequency	Fundamental Frequency
26.5 – 27.0 GHz	27.0 – 40.0 GHz
Harmonics	Harmonics
$5/4 \times F_2$	$4/6 \times F_2$
$6/4 \times F_2$	$5/6 \times F_2$
	$7/6 \times F_2$
	$8/6 \times F_2$

If the desired CW frequency output of the HP 83554A is between 26.5 to 27.0 GHz, the HP 8340A/41A synthesizer is in band 2. If the desired CW output frequency of the HP 83554A is between 27.0 to 40.0 GHz, the HP 8340A/41A Series synthesizer is in band 3. With the synthesizer in band 2, all HP 83554A output frequencies (26.5 to 27.0 GHz) can be accompanied by two possible harmonic related spurs within the R-band frequency range, the 5/4 and 6/4 harmonic responses. For example, if the output frequency of the HP 83554A is 26.5 GHz, there may be accompanying harmonic spurs at 33.125 and 39.750 GHz. These are calculated as follows:

$$5/4 \times (26.5 \text{ GHz}) = 33.125 \text{ GHz}$$

$$6/4 \times (26.5 \text{ GHz}) = 39.750 \text{ GHz}$$

With the RF synthesizer in band 3, all HP 83554A output frequencies (27.0 to 40.0 GHz) may be accompanied by four harmonic related spurs, the 4/6, 5/6, 7/6, and 8/6 harmonic responses, three of which may be present within the R-band frequency range at one time. For example, if the output frequency of the HP 83554A is 30.0 GHz, there will be accompanying harmonic spurs at 20.000, 25.000, 35.000, and 40.000 GHz. Since the harmonic spur at 20.000 GHz is not within the R-band frequency range, it will not appear at the output of the HP 83554A. The above harmonic spurs are calculated as follows:

$$4/6 \times (30.0 \text{ GHz}) = 20.000 \text{ GHz}$$

$$5/6 \times (30.0 \text{ GHz}) = 25.000 \text{ GHz}$$

$$7/6 \times (30.0 \text{ GHz}) = 35.000 \text{ GHz}$$

$$8/6 \times (30.0 \text{ GHz}) = 40.000 \text{ GHz}$$

2. On the HP 8340A/41A:

Press **[SHIFT] [INSTRUMENT PRESET]**

Press **[SHIFT] [START] [2] [Hz]**

Press **[SHIFT] [ALT]**

Press **[CW] [2] [6] [.] [5] [GHz]**

3. Press **[XTAL] EXT ALC MODE**
Press **[POWER LEVEL]**

Adjust the power level rotary knob for an 8.0 dBm reading on the HP 8349B display.

4. Ensure that the HP 436A display reads 8.0 dBm \pm 2.00 dB.

5. On the HP 8566B:

Press **[INSTR PRESET]**

Press **[SHIFT] [▲] [▲]** until the **FULL BAND K (A)** annotation appears. This places the analyzer into an external mixing mode allowing R-band frequency range capability. Note the start/stop frequency at the bottom of the screen and ensure that the start frequency is 26.5 GHz and the stop frequency is 40.0 GHz.

Press **[REF LEVEL] [8] [.] [0] [+ dBm]**

Press **DISPLAY LINE [ENTER] [1] [2] [- dBm]**, setting the 20 dBc reference.

Amplitude Calibration of the HP 8566B

The HP 8566B spectrum analyzer can make amplitude calibrated measurements of millimeter signals when configured with the HP 11970 mixers. A calibration graph that shows conversion loss and reference level offset is provided with each mixer so that the analyzer can be normalized to that mixer. The following explanation illustrates how this offset is entered into the spectrum analyzer.

In the external mixing mode, the HP 8566B gain is automatically increased 30 dB to compensate for the conversion loss of an external mixer. Using the information from the graph supplied with the mixer, you can offset the reference level to obtain precise amplitude calibration for point by point frequency measurements. For example, if the calibration table indicates the Reference Level Offset for a frequency of 30.0 GHz is -6.8 dB, this offset would be entered by pressing:

[SHIFT] [REF LEVEL] [6] [.] [8] [-dBm]

With this offset entered, the HP 8566B is amplitude calibrated at 30.0 GHz. If less accurate measurements can be tolerated, normalizing the conversion loss graph on the HP 11970 can be accomplished by averaging the graph's maximum and minimum power points resulting in an overall conversion loss for the entire band. By using this method, an increase of measurement uncertainty is introduced into the test. Reference level offset is determined by the following equation:

$$\text{Conversion Loss} - 30 \text{ dB} = \text{Reference Level Offset}$$

Because the test configuration in Figure 2-9 specifies that the external mixer be connected to the coupled arm of a 20 dB directional coupler, the coupled power must also be taken into account when calculating reference level offset. The new equation is as follows:

$$\text{Conversion Loss} + \text{coupled power (20 dB)} - 30 \text{ dB} = \text{Reference Level Offset}$$

6. On the HP 8340A/41A:

Manually tune the HP 8340A/41A from 26.5 to 37.2 GHz while watching for harmonic responses that are higher than the display line (< 20 dBc) on the HP 8566B display.

Signal Identification

7. If a harmonic related spurious signal is found, verify whether or not it is a true in-band signal by using the spectrum analyzer's signal identification feature. This is performed as follows:
8. Tune the signal under observation to center screen on the HP 8566B display.
9. Press **[SHIFT] [FREE RUN]**
10. If the signal is a false response, the annotation **IDENTIFIED OUT OF BAND** will appear on the display.
11. Ensure that any harmonic-related spurious signals observed are within the specified level of > 20 dBc.

Measurement Uncertainty

Measurement uncertainty within the test configuration will affect the accuracy of this performance test. To obtain optimum accuracy, amplitude calibrate the spectrum analyzer by entering the conversion loss at each frequency signal under observation as explained under **Amplitude Calibration of the HP 8566B**. Any harmonic-related spurious signals that are close to or at 20 dBc should be given an allowable margin of ± 1.5 dB to compensate for all other measurement uncertainties within the test configuration.

12. The foregoing steps performed a harmonic related spurious test from 26.5 to 37.2 GHz at a specified maximum leveled power of 8.0 dBm. The proceeding steps will continue this test covering the remaining frequency range of the R-band (37.2 to 40.0 GHz) at a maximum leveled power of 7.0 dBm.

13. On the HP 8340A/41A:

Press **[POWER LEVEL]**

Adjust the power level rotary knob for a 7.0 dBm reading on the HP 8349B display.

14. Ensure that the HP 436A display reads 7.0 dBm \pm 0.5 dB.

15. On the HP 8566B:

Press **[REF LEVEL] [7] [.] [0] [+dBm]**

Press **DISPLAY LINE [ENTER] [1] [3] [-dBm]**, setting the 20 dBc reference.

16. Repeat steps 6 through 11 except this time tune the HP 8340A/41A from 37.2 to 40.0 GHz.

This concludes the performance test for harmonic related spurious signals. Performance of this test ensures that all potential problem harmonic related spurious locations have been thoroughly tested for the HP 8340A/41A/83554A system.

If your system fails to meet these specifications, refer to the paragraph titled TROUBLESHOOTING.

Table 2-3. Performance Test Record

HP 8340A/41A Series System				
Serial Number _____		Date _____		
Humidity* _____		Tested By _____		
(Optional)		Temperature _____		
Specification Tested	Test Conditions	Specification	Test Results	
			Pass	Fail
FREQUENCY				
Range ¹	_____	26.5 to 40.0 GHz ¹	_____	_____
Accuracy (25°C ±5°C)	_____	Same as time base	_____	_____
CW Mode	_____	Internal 10 MHz time base	_____	_____
Time Base	_____	Aging rate: less than 1 x 10 ⁻⁹ /day and 2 x 10 ⁻⁷ /year after 30-day warmup.	_____	_____
	_____	Temperature effect	_____	_____
	_____	< 1 x 10 ⁻¹⁰ /°C	_____	_____
	_____	Line Voltage effect	_____	_____
	_____	< 1 x 10 ⁻¹¹ /±10%	_____	_____
All Sweep Modes (for sweep time > 100 msec)	_____	ΔF ≤ 30 MHz	_____	_____
	_____	± 1% of ΔF ± time base accuracy	_____	_____
	_____	30 MHz > ΔF > 600 MHz:	_____	_____
	_____	± 2% of ΔF	_____	_____
	_____	ΔF ≥ 600 MHz:	_____	_____
	_____	± 1% of ΔF or ± 100 MHz whichever is less	_____	_____
CW Resolution ¹	_____	6Hz ¹	_____	_____
OUTPUT				
System Harmonics	_____	> 20 dBc	_____	_____

1. These specifications are referenced from the appropriate HP 8340A/41A synthesized sweeper manuals and have been multiplied by a factor of 2 because the HP 83554A is a frequency doubler.

TROUBLESHOOTING

Specification Failures

Failures are divided into two categories:

Category one describes systems that are meeting specifications in some areas, while failing in others. If this is the case, do the following:

- Inspect the connectors and ensure that all connections are making good electrical contact.

- Inspect all cabling for breaks.

- Test again.

If your system is still failing at the SAME points, your instrument(s) or cable(s) could be defective and should be returned for repair. If, however, your system fails at DIFFERENT points, there is probably a loose connection or a mechanical failure somewhere in the setup.

Remember, it is possible the system may fail the performance test(s) because of measurement uncertainties. If you suspect this to be the case, contact your nearest HP office for more information.

Category two failures are total specification failures. If your system fails any of these tests completely, do the following:

- Check the TEST SETUP for correct configuration of the instruments and connections.

- Inspect the connectors.

- Inspect the cables.

- Repeat the failed test(s).

If your system is still failing, the system is probably defective and needs repair.

Also, for the best accuracy in measurement, use only calibrated instruments.

Troubleshooting System Harmonics

If the HP 8340A/41A/83554A system fails to meet the specifications mentioned in step 6 of the System Harmonics test, the failure may be occurring from either the HP 8340A/41A synthesized sweeper, the HP 8349B, or the HP 83554A mm-wave source module. The following steps will help to isolate the origin of the failure. See Figure 2-10 for harmonic power check points.

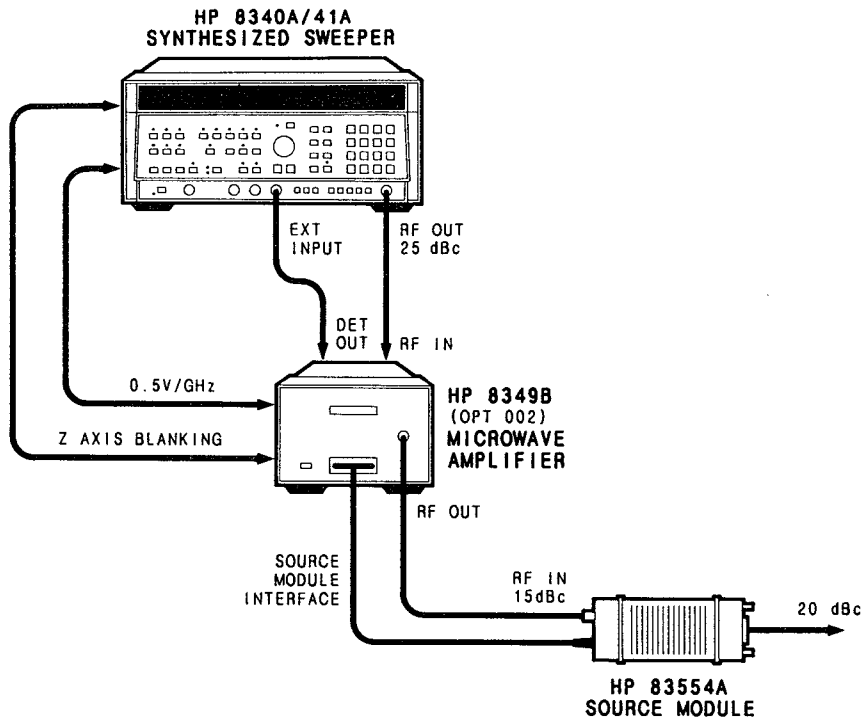

Figure 2-10. Harmonic Check Points

1. If the harmonic related spurious output from the HP 83554A is less than 20 dBc, check the harmonic output of the HP 8349B and ensure that it is >15 dBc.
2. If the HP 8349B harmonic output is within specifications, refer to the Source Module Specifications and Service section of this manual and perform the Harmonics Spurious performance test to verify that the HP 83554A is at fault. If the HP 83554A is at fault, refer to the Source Module Specifications and Service Section for repair or replacement of the instrument.
3. If the HP 8349B harmonic output is <15 dBc, continue to step 4.
4. Check the spurious signal output level of the HP 8340A/41A synthesizer by referring to the appropriate HP 8340A/41A Operating and Service manual for the Spurious Signals performance test to verify whether or not the RF synthesizer is at fault. The specified harmonic related spurious output level should be >25 dBc. If the spurious signals are within specification, repair or replace the HP 8349B.
5. If the HP 8340A/41A synthesizer exceeds harmonic output specifications, repair or replace the synthesizer.

REGIONAL SALES AND SUPPORT OFFICES

For information relating to Sales or Support of Hewlett-Packard products first contact your local Hewlett-Packard office listed in the white pages of your telephone directory. If none is listed locally, contact one of the addresses listed below to obtain the address or phone number of the Hewlett-Packard Sales or Support office nearest you.

ASIA

Hewlett-Packard Asia Ltd.
47/F, 26 Harbour Road,
Wanchai, **HONG KONG**
G.P.O. Box 863, Hong Kong
Tel: (852) 5-8330833
Telex: 76793 HPA HX
Cable: HPASIAL TD

AUSTRALASIA

Hewlett-Packard Australia Ltd.
31-41 Joseph Street
BLACKBURN, Victoria 3130
Australia
Tel: (61) 895-2895
Telex: 31-024
Cable: HEWPARD Melbourne

CANADA

Hewlett-Packard (Canada) Ltd.
6877 Goreway Drive
MISSISSAUGA, Ontario L4V 1M8
Tel: (416) 678-9430
Telex: 069-8644

JAPAN

Yokogawa-Hewlett-Packard Ltd.
29-21 Takaido-Higashi, 3 Chome
Suginami-ku **TOKYO** 168
Tel: 03 (331) 6111
Telex: 232-2024 YHPTOK

MEDITERRANEAN AND MIDDLE EAST

Hewlett-Packard S.A.
Mediterranean and Middle East
Operations
Atrina Centre
32 Kifissias Avenue
Paradissos-Amarousion, **ATHENS**
Greece
Tel: (30) 682 88 11
Telex: 21-6588 HPAT GR
Cable: HEWPACKSA Athens

BENELUX & SCANDINAVIA

Hewlett-Packard S.A.
Uilenstede 475
P.O. Box 999
NL-1183 AG **AMSTELVEEN**
The Netherlands
Tel: (31) 20/43 77 71
Telex: 18 919 hpner nl

SOUTH & EAST EUROPE, AFRICA

Hewlett-Packard S.A.
7, rue du Bois-du-Lan
CH-1217 **MEYRIN 2**, Geneva
Switzerland
Tel: (41) 22/83 12 12
Telex: 27835 hmea
Cable: HEWPACKSA Geneve

FRANCE

Hewlett-Packard France
Parc d'activités du Bois Briard
2, avenue du Lac
91040 **EVRY** Cedex
Tel: 1 6/077 83 83
Telex: 6923 15F

GERMAN FEDERAL REPUBLIC

Hewlett-Packard GmbH
Hewlett-Packard-Strasse
Postfach 1641
D-6380 **BAD HOMBURG**
West Germany
Tel: 06172/400-0
Telex: 410 844 hpbhg

ITALY

Hewlett-Packard Italiana S.p.A.
Via G. Di Vittorio 9
1-20063 **CERNUSCO SUL
NAVIGLIO**
(Milano)
Tel: 02/92 36 91
Telex: 334632

UNITED KINGDOM

Hewlett-Packard Ltd.
King Street Lane
Winnersh, **WOKINGHAM**
Berkshire RG11 5AR
Tel: 734/78 47 74
Telex: 847178

EASTERN USA

Hewlett-Packard Co.
4 Choke Cherry Road
ROCKVILLE, MD 20850
Tel: (301) 670-4300

MIDWESTERN USA

Hewlett-Packard Co.
5201 Tollview Drive
ROLLING MEADOWS, IL 60008
Tel: (312) 255-9800

SOUTHERN USA

Hewlett-Packard Co.
2000 South Park Place
P.O. Box 105005
ATLANTA, GA 30348
Tel: (404) 955-1500

WESTERN USA

Hewlett-Packard Co.
5161 Lankershim Blvd.
P.O. Box 3919
NO. HOLLYWOOD, CA 91609
Tel: (818) 506-3700

OTHER INTERNATIONAL AREAS

Hewlett-Packard Co.
Intercontinental Headquarters
3495 Deer Creek Road
PALO ALTO, CA 94304
Tel: (415) 857-1501
Telex: 034-8300
Cable: HEWPACK

February, 1986



**HEWLETT
PACKARD**

**HP 8670 Series
Source System Guide**

HP 83554A SOURCE MODULE

For use with
HP 8670 Series
HP 8349B

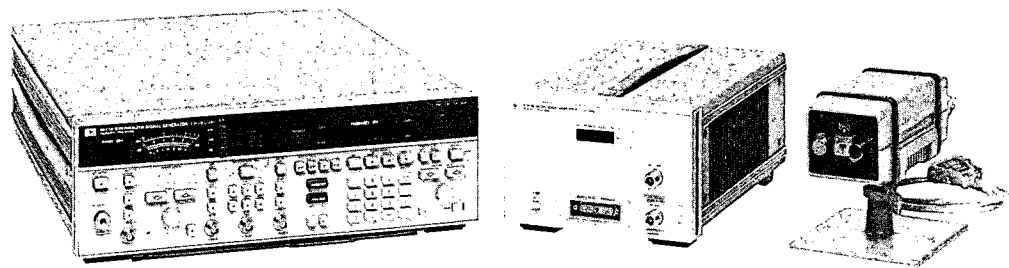

**HEWLETT
PACKARD**

CERTIFICATION

Hewlett-Packard Company certifies that this product met its published specifications at the time of shipment from the factory. Hewlett-Packard further certifies that its calibration measurements are traceable to the United States National Bureau of Standards, to the extent allowed by the Bureau's calibration facility, and to the calibration facilities of other International Standards Organization members.

WARRANTY

This Hewlett-Packard system product is warranted against defects in materials and workmanship for a period corresponding to the individual warranty periods of its component products. Computer and computer peripherals are warranted for a period of 90 days. Instruments are warranted for a period of one year. During the warranty period, Hewlett-Packard Company will, at its option, either repair or replace products which prove to be defective.

Warranty service for products installed by HP and certain other products designated by HP will be performed at Buyer's facility at no charge with HP service travel areas. Outside HP service travel areas, warranty service will be performed at Buyer's facility only upon HP's prior agreement and Buyer shall pay HP's round trip travel expenses. In all other areas, products must be returned to a service facility designated by HP.

For products returned to HP for warranty service, Buyer shall prepay shipping charges to HP and HP shall pay shipping charges to return the product to Buyer. However, Buyer shall pay all shipping charges, duties, and taxes for products returned to HP from another country.

HP warrants that its software and firmware designated by HP for use with an instrument will execute its programming instructions when properly installed on that instrument. HP does not warrant that the operation of the instrument, or software, or firmware will be uninterrupted or error free.

LIMITATION OF WARRANTY

The foregoing warranty shall not apply to defects resulting from improper or inadequate maintenance by Buyer, Buyer-supplied software or interfacing, unauthorized modification or misuse, operation outside of the environmental specifications for the product, or improper site preparation or maintenance.

NO OTHER WARRANTY IS EXPRESSED OR IMPLIED. HP SPECIFICALLY DISCLAIMS THE IMPLIED WARRANTIES OR MERCHANTABILITY AND FITNESS FOR A PARTICULAR PURPOSE.

EXCLUSIVE REMEDIES

THE REMEDIES PROVIDED HEREIN ARE BUYER'S SOLE AND EXCLUSIVE REMEDIES. HP SHALL NOT BE LIABLE FOR ANY DIRECT, INDIRECT, SPECIAL, INCIDENTAL, OR CONSEQUENTIAL DAMAGES, WHETHER BASED ON CONTRACT, TORT, OR ANY OTHER LEGAL THEORY.

ASSISTANCE

Product maintenance agreements and other customer assistance agreements are available for Hewlett-Packard products.

For any assistance, contact your nearest Hewlett-Packard Sales and Service Office. Addresses are provided at the back of this manual.

**HP 83554A
MILLIMETER-WAVE
SOURCE MODULE**

**For use with
HP 8670 Series
HP 8349B**

SERIAL NUMBERS

This manual applies directly to HP 83554A Millimeter-wave source modules having serial prefix 2612A.

For additional information about serial numbers, refer to INSTRUMENTS COVERED BY MANUAL in System General Information.

©Copyright HEWLETT-PACKARD COMPANY 1986
1400 FOUNTAINGROVE PARKWAY, SANTA ROSA, CA 95401 U.S.A.

MANUAL PART NO. 83554-90008
Microfiche Part Number 83554-90015

Printed: APRIL 1986



**HEWLETT
PACKARD**

TABLE of CONTENTS
HP 8670 SERIES SOURCE SYSTEM GUIDE

Introduction
System Specifications
Operation
Operator's Check
System Performance Tests
 Introduction
 Frequency Characteristics
 System Harmonics
Troubleshooting

HP 8670 Series Source System Guide

INTRODUCTION

This source system guide is intended to provide you millimeter-wave system operating information for the HP 8673B/C/D series synthesized signal generators (unless otherwise stated will be hereafter referred to as the HP 8673B/C/D). It contains an Operator's Check, connection diagrams, system specifications, system performance tests, and system level troubleshooting. For detailed instruction regarding the operation or troubleshooting of the individual instruments, refer to the instrument's operating and service manual.

SYSTEM DESCRIPTION

HP 8673B/C/D synthesized signal generators provide direct, factory calibrated control and display of system output frequency and level. HP 8673B/C/D synthesized signal generators with serial number prefix 2552A are fully compatible for use with a millimeter-wave system consisting of an HP 8349B microwave amplifier and an HP 83554A millimeter-wave source module. For proper display accuracy, leveling flatness, and harmonic suppression, the 1.0V/GHz output on your HP 8673B/C/D will have to be modified for a 0.5V/GHz output. Serial number prefixes previous to 2552A will require the modification for proper system operation. A retrofit kit may be ordered to implement these modifications. Refer to the table below to determine the retrofit kit number applicable to the system synthesizer. For detailed information concerning synthesizer operation, refer to the HP 8673B/C/D Operating and Service Manual.

Synthesizer	Retrofit Kit Part Number
HP 8673B	08673-60130
HP 8673C	08673-60182
HP 8673D	08673-60183

NOTE: The HP 8673B/C/D synthesized signal generators require a synthesizer interface cable for operation in a mm-wave system. The cable is available as HP Part No. 5061-5391.

WARNING

This equipment is capable of radiating millimeter-wave energy from the end of unterminated waveguide. Do not look directly into the open end of any waveguide when it is connected to a source of millimeter-wave energy.

Take precautions consistent with ANSI C95.1 - 1982, a study performed by the American National Standards Institute that sets limits for human exposure to microwave and millimeter-wave energy. Copies of this publication are available from:

**American National Standards Institute
1430 Broadway
New York, N. Y. 10018**

SYSTEM SPECIFICATIONS

Table 2-1 provides specifications for the HP 8673B/C/D/synthesized signal generator/83554A system configuration. These are the performance standards against which the system is tested.

Table 2-1. 8673B/C/D/83554A System Specifications

<p>Frequency Characteristics</p> <p>Range 8673B/D 26.5 to 40.0 GHz 8673C 26.5 to 37.2 GHz</p> <p>Accuracy¹ (25°C ± 5°C) CW Mode Same as time base. Time Base² . Internal 10 MHz time base. Aging rate less than 5×10^{-10}/day after a 24-hour warmup. Temperature effect: $< 1 \times 10^{-10}/^{\circ}\text{C}$ Line Voltage effect: $< 5 \times 10^{-10}/+5\%$ to -10%</p> <p>All Sweep modes¹ (for sweep time > 100 ms)³ Same as time base.</p> <p>CW Resolution 6 kHz⁴</p> <p>Output Characteristics⁵ System Harmonic < -20 dBc⁶ Typically < -25 dBc</p> <p>Modulation Characteristics</p> <p>External FM</p> <p>Maximum Deviations for Modulation Frequencies</p> <p>100 Hz to 10 MHz (60,200 kHz/V ranges)</p> <p>1 kHz to 10 MHz (600 kHz/V, 2,6,20 MHz/V ranges) The smaller of 20 MHz or $f_{\text{mod}} \times 30$, 26.5 – 37.2 GHz $f_{\text{mod}} \times 40$, 37.2 – 40.0 GHz</p>	<p>Modulation Characteristics (Cont'd)</p> <p>Sensitivity FM Mode, typically .. 60, 200, 600 kHz/V and 2, 6, 20 MHz/V</p> <p>External AM Bandwidth, typically 0 Hz to 80 kHz Sensitivity, typically 30%/V and 100%/V</p> <p>External Pulse Modulation Rise/Fall Time, typically 25 ns Minimum RF Pulse Width System Leveled, typically 5 μs⁷ System Unleveled, typically 50 ns On/Off Ratio, typically > 80 dB Pulse Repetition Frequency System Leveled, typically 50 Hz to 100 kHz System Unleveled, typically 50 Hz to 500 kHz</p> <p>HP 8756A and HP 8757A AC Detection Mode Compatibility .. Yes</p> <p>1. Specifications referenced are source driver specific (HP 8673B/C/D) and do not indicate the doubling effect of the source module. 2. Overall accuracy of internal timebase is a function of timebase calibration \pm aging rate \pm temperature effects \pm line effects. 3. After one hour warmup at selected CW frequency. 4. HP 8673B/D from 37.2 to 40.0 GHz, 8 kHz. 5. For output characteristics, see Source Module Specifications and Service Section. 6. Except for the HP 8673C/D which is > 30 dBc. 7. Typical pulse level accuracy: $+1.5$ dB, -0 dB relative to CW.</p>
---	---

OPERATION

INTRODUCTION

This section is intended for operators familiar with the HP 8673B/C/D instruments. If you are unfamiliar with this system, refer to the Operator's check at the end of this section for more specific instructions.

In the operation instructions, any instrument setting or function key is defined by [] symbols around it.

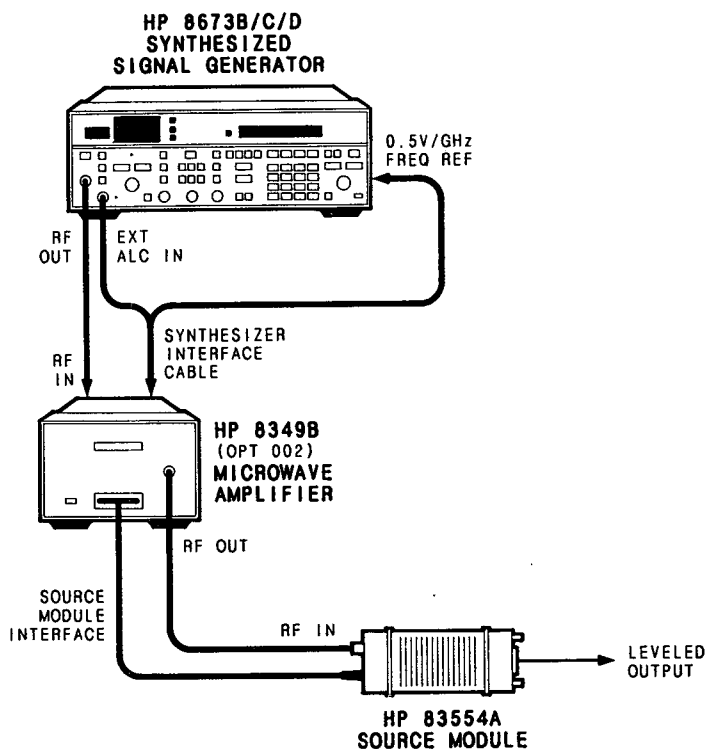

Figure 2-1. HP 8673B/C/D/83554A Source System Configuration



Turn off the ac power on the HP 8349B prior to connecting or disconnecting the source module interface cable.

Connect the system as shown in Figure 2-1.

FREQUENCY CONTROL

After the connection have been made, turn on the system. Allow instruments to warm-up 30 minutes. The synthesizer allows the user to enter and display the actual frequency of the output of the system by entering a multiplication factor into the synthesizer front panel. Preset the synthesizer by pressing:

[RCL] [BACKSPACE]

Enter the multiplication factor by pressing:

[SHIFT] [MULT] [2] [XFREQ]

The actual system output frequency is now shown on the synthesizer display. Once the multiplication factor is entered, the system output frequency can be controlled directly using the synthesizer. The multiplication factor can be reset to one by pressing:

[SHIFT] [MULT] [1] [XFREQ]

POWER LEVEL CONTROL



Before performing any power level calibrations, ensure that the HP 8673B/C/D synthesizer is not at maximum power.

The system output power can be entered, displayed, and controlled directly with the synthesizer. Power level can be controlled by activating the ALC DIODE key and adjusting the OUTPUT LEVEL VERNIER knob.

POWER LEVELING

System Leveling

To activate system leveling mode, connect the equipment as shown in Figure 2-1 and press:

[SHIFT] [DIODE/SYS]

NOTE: When using system leveling mode, use only the +20, +10, or 0 dBm range when setting system output level.

When in system leveling mode, both the DIODE/SYS key and the INTERNAL ALC key will light. The power output of the system is detected in the millimeter-wave source module. The detected signal is fed back to the HP 8349B which converts it to a voltage that is proportional to the system output power in volts per dB. This voltage is fed back to the synthesizer through the EXT ALC IN connector. Power level corrections are made by the synthesizer. The actual system output power is shown on the synthesizer display. System output power can also be remotely programmed and read over HP-IB.

External Crystal Detector Leveling

Figure 2-2 illustrates a typical crystal detector leveling setup.

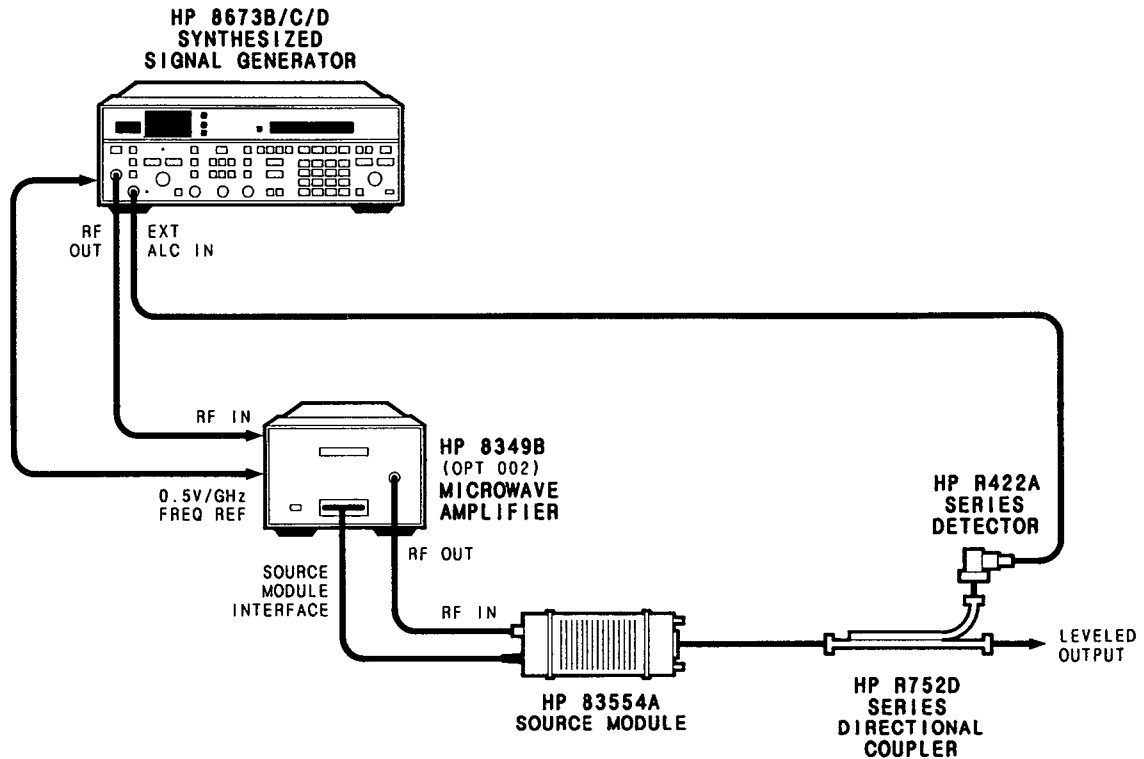

Figure 2-2. External Crystal Detector at the HP 83554A Source Module Output.

To activate the external crystal detector leveling mode, connect the equipment as shown in Figure 2-2 and press the **[DIODE]** key on the synthesizer front panel. The output power of the millimeter-wave source module is detected by a crystal detector. The detected signal is fed back to the synthesizer through the **EXT ALC IN** connector on the front panel. Power level corrections are made by the synthesizer. The actual system output power is shown on the HP 8349B microwave amplifier display. The synthesizer output level meter can be calibrated to the microwave amplifier display by adjusting the **CAL** control on the synthesizer front panel. Set **[RANGE]** to 0 dBm and the **[VERNIER]** to 0 dBm. Adjust the **[CAL]** control for a system output level of 0 dBm as indicated on the HP 8349B display.

Maximum specified power and flatness may not be achieved when using an external leveling technique as a result of leveling coupler losses.

External Power Meter Leveling

This power leveling method has a slow settling time but has the advantage of high sensitivity and temperature compensation. Figure 2-3 illustrates a typical external power meter leveling setup.

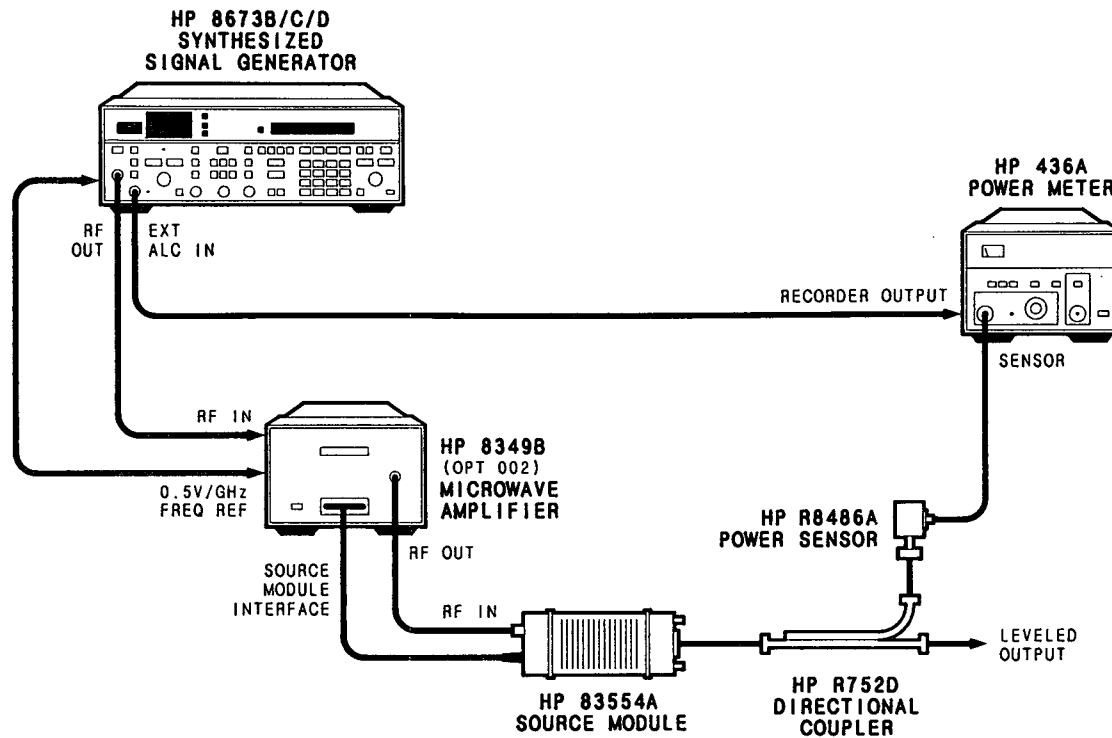

Figure 2-3. External Power Meter at the HP 83554A Source Module Output.

To activate the external power meter leveling mode, connect the equipment as shown in Figure 2-3 and press the **[PWR MTR]** key on the HP 8673B/C/D front panel. The output of the millimeter-wave source module is detected by the power meter. A linearly proportional voltage is fed back to the synthesizer through the EXT ALC IN connector on the front panel. Power level corrections are made by the synthesizer. The actual system output power is shown on the microwave amplifier display. The synthesizer output level meter can be calibrated to the microwave amplifier display by adjusting the CAL control on the synthesizer front panel. Set **[RANGE]** to 0 dBm and the **[VERNIER]** to 0 dBm. Adjust the **[CAL]** control for a system output level of 0 dBm as indicated on the microwave amplifier display.

MODULATION

For complete specifications on all modulation modes described below, refer to Table 2-1 (HP 8673B/C/D/83554A System Specifications).

Frequency Modulation

The millimeter-wave system's output signal can be frequency modulated by applying an external modulating signal to the synthesizer FM IN connector. FM deviation range is chosen by the FM DEVIATION MHz keys on the synthesizer front panel. The amount of deviation varies linearly with the input signal level; 1 volt peak develops full scale modulation. Due to the frequency doubling of the millimeter-wave source module, the sensitivity and maximum deviation of the synthesizer is multiplied by a factor of two. See Table 2-2.

Table 2-2. Synthesizer and System Sensitivities

Sensitivity of Synthesizer	Sensitivity of System
30,100,300 kHz per volt 1,3,10 MHz per volt	60,200,600 kHz per volt 2,6,20 MHz per volt

Amplitude Modulation

The millimeter-wave system's output signal can be amplitude modulated by applying an external modulating signal to the synthesizer AM IN connector. The modulation range is selected using the AM keys on the synthesizer front panel. The depth of modulation varies linearly with the input signal; 1 volt peak develops full scale modulation. The AM bandwidth extends from 20 Hz to 80 kHz.

Pulse Modulation

The source module's output signal can be pulse modulated by applying a TTL compatible pulse waveform to the PULSE IN connector on the synthesizer front panel. This input provides an on/off power ratio of greater than 80 dB at the system output. The PULSE IN input is normally at a TTL high (approximately +3 volts DC). When a TTL low signal (approximately 0 volts DC) is applied, the source module's output signal is turned off. Leveled pulse repetition rates from 50 Hz to 100 kHz are achievable in system leveling mode with pulse widths as narrow as 5 microseconds. Level accuracy is comparable to CW accuracy down to 5 microsecond pulse widths.

OPERATOR'S CHECK

DESCRIPTION

This procedure allows verification of proper operation of the millimeter-wave system by determining the system's output power and flatness performance at maximum leveled output power over the entire frequency range. Maximum leveled output power is split into two specifications across the band +8.0 dBm (26.5 GHz to 37.2 GHz), and +7.0 dBm (37.2 GHz to 40.0 GHz). This procedure will test the power flatness at these two power levels.

EQUIPMENT

Ensure that all the instruments listed below meet their own performance standards and have recently been calibrated to proper specifications before configuring them into the test setup.

RF Signal Source	HP 8673B/C/D Synthesized Signal Generator
Microwave Amplifier	HP 8349B
Power Meter	HP 436A
Power Sensor	HP R8486A

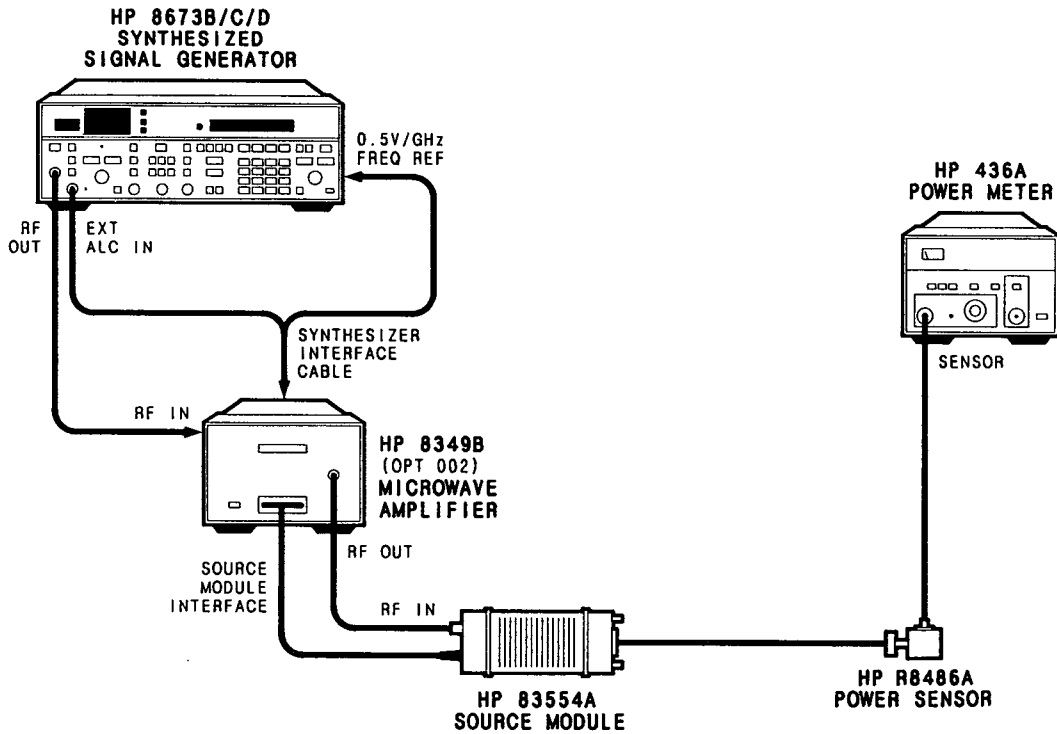

Figure 2-4. System Configuration

PROCEDURE

1. Connect the equipment as shown in Figure 2-4. Do not connect the HP R8486A power sensor to the HP 83554A output.

CAUTION

Turn off the ac power on the HP 8349B prior to connecting or disconnecting the source module interface connector. Before performing any power level calibrations, ensure that the HP 8673B/C/D synthesizer is not at maximum power.

2. Turn on all system components.
3. On the HP 436A:
Press [dBm] mode.
Zero and calibrate the power meter. Set the CAL FACTOR at 100%. The CAL FACTOR will not be changed for the rest of the procedure. By leaving the CAL FACTOR at 100%, it ensures minimum specifications will be met.
4. On the HP 8673B/C/D:
Press [SHIFT] [MULT] [2] [xFREQ]
Press SWEEP FREQ [START] [2] [6] [.] [5] [GHz]
Press SWEEP FREQ [STOP] [3] [7] [.] [2] [GHz]
Press SWEEP RATE [STEP] [2] [0] [0] [MHz]
Press SWEEP MODE [MANUAL]
Press RANGE [▲] for a +10 dBm reading on the RANGE dBm display.
5. Adjust the synthesizer VERNIER for a reading of +8.0 dBm on the HP 436A.
6. Find the minimum power point between 26.5 GHz and 37.2 GHz by slowly adjusting the TUNE knob from 26.5 GHz to 37.2 GHz and noting at which frequency minimum power occurs. See Figure 2-5.

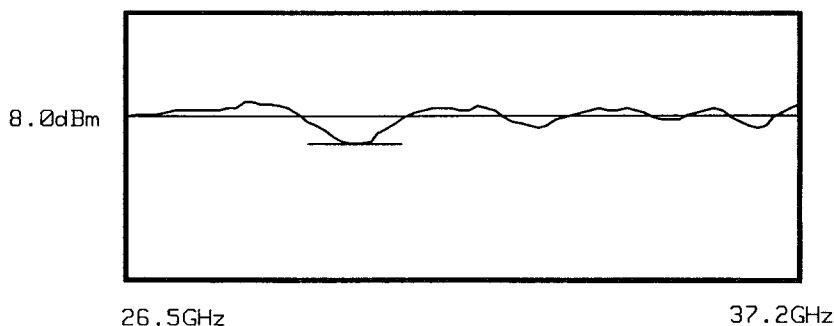

Figure 2-5. Minimum Power Point (26.5 to 37.2 GHz)

7. Tune the frequency to the minimum power point.
8. Adjust the VERNIER until the power meter display reads +8.0 dBm.
9. Tune the synthesizer frequency to 26.5 GHz.
10. Slowly tune the frequency from 26.5 GHz to 37.2 GHz while watching the power level readings on the power meter. The power level displayed should not exceed +10.5 dBm. See Figure 2-6.

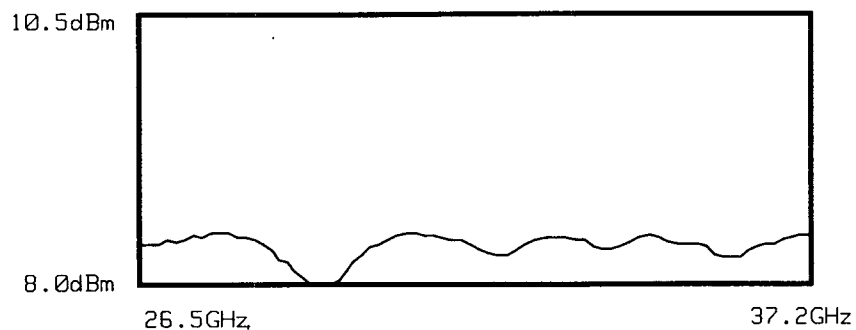

Figure 2-6. Power Flatness Response (26.5 to 37.2 GHz)

11. Set the synthesizer STOP frequency to 40.0 GHz.
12. Set FREQUENCY to 26.5 GHz.
13. Adjust the VERNIER for a reading of +7.0 dBm on the power meter display.
14. Find the minimum power point between 26.5 GHz and 40.0 GHz by slowly adjusting the TUNE knob from 26.5 GHz to 40.0 GHz while watching the power level readings on the power meter and noting at which frequency minimum power occurs. See Figure 2-7.

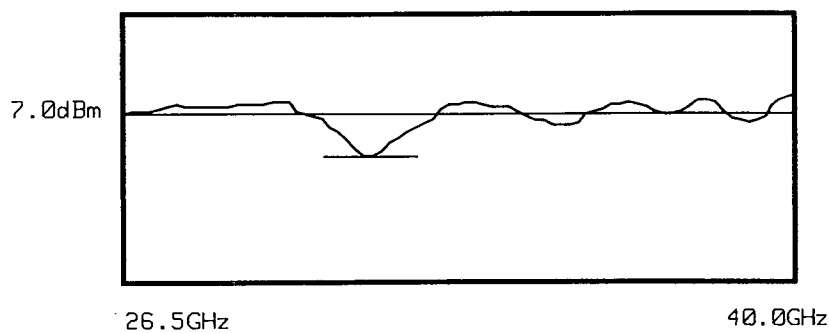

Figure 2-7. Minimum Power Point (26.5 to 37.2 GHz)

15. Tune the frequency to the minimum power point.
16. Adjust the VERNIER until the power meter display reads +7.0 dBm.
17. Tune the synthesizer frequency to 26.5 GHz.
18. Slowly tune the frequency from 26.5 GHz to 40.0 GHz while watching the power level readings on the power meter. The displayed power level should not exceed +9.5 dBm. See Figure 2-8.

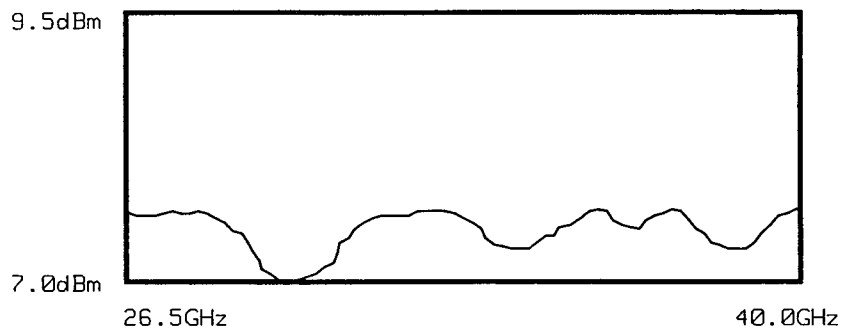

Figure 2-8. Power Flatness Response (26.5 to 40 GHz)

SYSTEM PERFORMANCE TESTS

INTRODUCTION

The procedures in this section test the performance of the HP 8673B/C/D/83554A source system using the specifications of Table 2-1 as the performance standards. All tests can be performed without access to the interior of the instrument. The performance test procedures must be performed in the sequence given since some procedures rely on satisfactory test results in the foregoing steps. In order to fully verify the performance specifications of the HP 83554A, the performance tests in the Source Module Specifications and Service Section must also be performed. None of the tests require access to the interior of the instrument.

Under the paragraph, TROUBLESHOOTING, you will find information on what to do if your system fails to meet specifications.

EQUIPMENT REQUIRED

Equipment required for the performance tests are listed in the Recommended Test Equipment tables in the Source System Guides, and Specifications and Service Sections of the manual. Any equipment that satisfies the critical specifications given in the table may be substituted for the recommended models. Ensure also that the test equipment used is currently calibrated to proper specifications.

NOTE: Use only the connectors and cables that are specified in the following test setups to ensure accurate test results.

OPERATION VERIFICATION

The Operation Verification consists of performing the source module specific performance tests (Source Module Specifications and Service Section) which include, Maximum Leveled Power (verifies frequency range), Power Flatness, and Power Level Accuracy. These tests provide reasonable assurance that the Source Module is functioning properly and should meet the needs of an incoming inspection (80% verification).

TEST RECORD

Results of the performance tests may be recorded in the Test Record at the end of the procedures. The Test Record lists all of the tested specifications and their acceptable limits. Test results recorded at incoming inspection can be used for comparison in periodic maintenance and troubleshooting and after repairs or adjustments.

FREQUENCY CHARACTERISTICS

Range
Accuracy
Resolution
Stability

MODULATION CHARACTERISTICS

External FM

The performance tests above are source dependent and can be found in the Performance Tests section of the Synthesizer Operating and Service Manual.

NOTE: When specifying the output frequency characteristics of the HP 8673B/C/D/83554A system, all frequency specifications are referenced from the sources used and must be doubled because the HP 83554A is a frequency doubler. For special information about the doubler, refer to the A4 Multiplier Assembly's theory of operation found in the Source Module Specifications and Service Section of this manual.

SYSTEM HARMONICS

Specification

Harmonic Related >20 dBc (Except the HP 8673 C/D which is >30 dBc).

Description

The RF output signal from the millimeter-wave system is tuned from 26.5 to 40.0 GHz using the HP 8673B/D or from 26.5 to 37.2 GHz using the HP 8673C. The system output frequency is displayed on a spectrum analyzer to verify that any harmonic spurious signals are at or below their specified levels. The test configuration in Figure 2-9 uses an external harmonic mixer to extend the frequency range of the spectrum analyzer. When this technique is used, the response is not preselected and multiple signals are displayed that are not necessarily in the frequency band displayed on the spectrum analyzer. Each response must be examined not only for amplitude level but also to determine whether it is a true in-band spurious signal by using the spectrum analyzer's signal identification function.

The following procedure is used to examine harmonically related spurious responses. The potential harmonic related responses can be calculated by using the equations in Table 2-3. For any CW output signal from the HP 83554A mm-wave source module, accompanying harmonic responses may be present.

Equipment

RF Signal Source	HP 8673B/C/D synthesizer
Microwave Amplifiers	HP 8349B and HP 11975A
Spectrum Analyzer	HP 8566B
Directional Coupler	HP R752D
Harmonic Mixer	HP 11970A
RF Cables (3)	HP Part No. 5061-5458
Power Meter	HP 436A
Power Sensor	HP R8486A

Procedure

1. Connect the equipment as shown in Figure 2-9.
Turn on all system components.

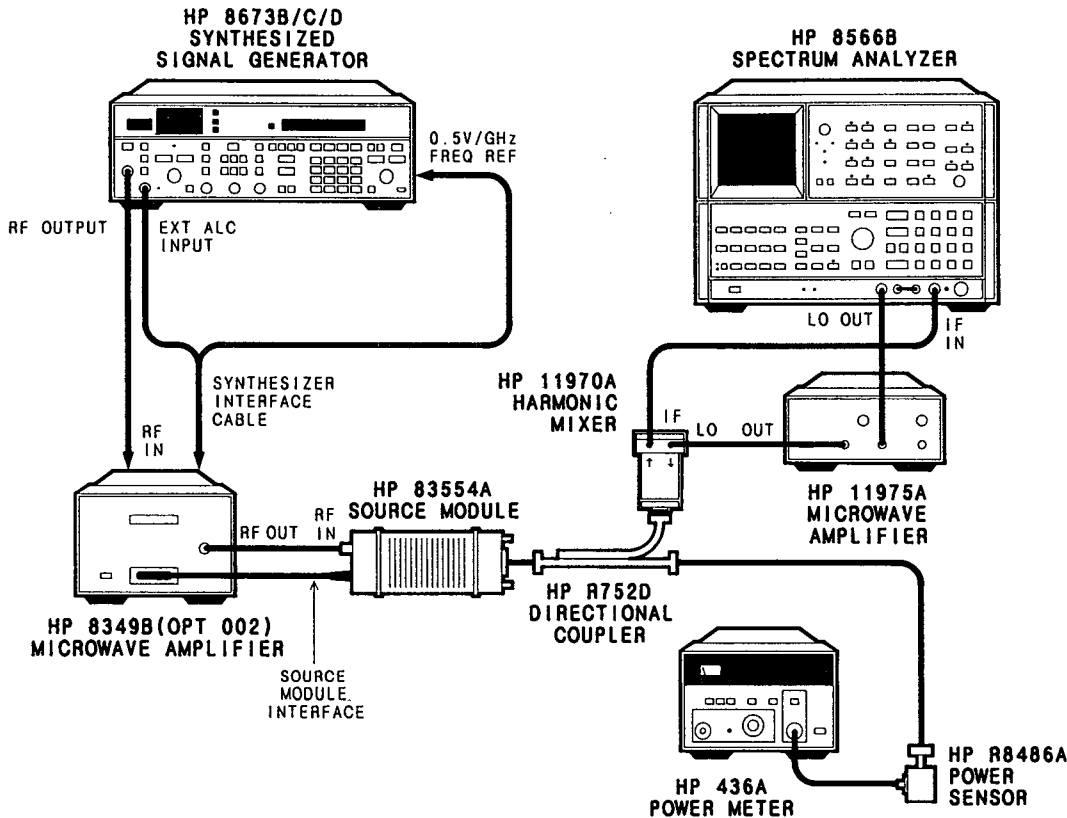

Figure 2-9. Spurious Signals Test Setup

Harmonically Related Spurious Signals

Harmonically related spurious signals are determined from the calculations in Table 2-3 below. The table is split into two frequency ranges, 26.5 to 37.2 GHz and 37.2 to 40.0 GHz. These frequency ranges are determined from band switch points in the synthesizer. Between 26.5 and 37.2 GHz, four possible harmonics of F2 (the system output frequency) may appear. Between 37.2 and 40 GHz, two possible harmonics may appear.

Table 2-3. Calculated Harmonic Frequencies

Fundamental Frequency	Fundamental Frequency
26.5 to 37.2 GHz	37.2 to 40.0 GHz
Harmonics	Harmonics
$4/6 \times F2$	$6/8 \times F2$
$7/6 \times F2$	$7/8 \times F2$
$8/6 \times F2$	
$9/6 \times F2$	

If the desired CW frequency output of the HP 83554A is between 26.5 to 37.2 GHz, the HP 8673B/C/D synthesizer is in band 3. If the desired CW output frequency of the HP 83554A is between 37.2 to 40.0 GHz, the HP 8673B/D Series synthesizer is in band 4. With the synthesizer in band 3, all HP 83554A output frequencies (26.5 to 37.2 GHz) can be accompanied by four possible harmonic related spurs, the 4/6, 7/6, 8/6, and 9/6 harmonic responses, three of which may be within the R-Band frequency range. For example, if the output frequency of the HP 83554A is 26.5 GHz, there may be accompanying harmonic spurs at 17.667, 30.917, 35.333, and 39.750 GHz. These are calculated as follows:

$$4/6 \times (26.5 \text{ GHz}) = 17.667 \text{ GHz}$$

$$7/6 \times (26.5 \text{ GHz}) = 30.917 \text{ GHz}$$

$$8/6 \times (26.5 \text{ GHz}) = 35.333 \text{ GHz}$$

$$9/6 \times (26.5 \text{ GHz}) = 39.750 \text{ GHz}$$

With the RF synthesizer (HP 8673B/D) in band 4, all HP 83554A output frequencies (37.2 to 40.0 GHz) may be accompanied by two harmonic related spurs, the 6/8 and 7/8 harmonic responses. For example, if the output frequency of the HP 83554A is 35.0 GHz, there will be accompanying harmonic spurs at 26.250 and 30.625 GHz. The above harmonic spurs are calculated as follows:

$$6/8 \times (35.0 \text{ GHz}) = 26.250 \text{ GHz}$$

$$7/8 \times (35.0 \text{ GHz}) = 30.625 \text{ GHz}$$

2. On the HP 8673B/C/D:

Press **[RCL] [BACKSPACE]**

Press **[SHIFT] [DIODE/SYS]**

Press **[SHIFT] [MULT] [2] [xFREQ]**

Press SWEEP FREQ **[START] [2] [6] [.] [5] [GHz]**

Press SWEEP FREQ **[STOP] [3] [7] [.] [2] [GHz]**

Press SWEEP RATE **[STEP] [5] [0] [0] [MHz]**

Press SWEEP MODE **[MANUAL]**

Press RANGE **[▲]** for a +10 dBm reading on the RANGE dBm display.

3. Adjust the VERNIER for a reading of +8.0 dBm on the power meter.

4. On the HP 8566B:

Press **[INSTR PRESET]**

Press **[SHIFT] [▲] [▲]** until the FULL BAND 7 (A) annotation appears. This places the analyzer into an external mixing mode allowing R-band frequency range capability. Note the start/stop frequency at the bottom of the screen and ensure the start frequency is 26.5 GHz and the stop frequency is 40.0 GHz.

Press **[REF LEVEL] [8] [.] [0] [+dBm]**

Press **DISPLAY LINE [ENTER] [1] [2] [-dBm]**, setting the 20 dBc reference.

Amplitude Calibration of the HP 8566B

The HP 8566B spectrum analyzer can make amplitude calibrated measurements of millimeter signals when configured with the HP 11970A mixer. A calibration graph that shows conversion loss and reference level offset is provided with each mixer so that the analyzer can be normalized to that mixer. The following explanation illustrates how this offset is entered into the spectrum analyzer.

In the external mixing mode, the HP 8566B gain is automatically increased 30 dB to compensate for the conversion loss of an external mixer. Using the information from the graph supplied with the mixer, you can offset the reference level to obtain precise amplitude calibration for point by point frequency measurements. For example, if the calibration table indicates the reference level offset for a frequency of 30.0 GHz is -6.8 dB, this offset would be entered by pressing:

[SHIFT] [REF LEVEL] [6] [.] [8] [- dBm]

With this offset entered, the HP 8566B is amplitude calibrated at 30.0 GHz. If more general measurements are required, normalizing the conversion loss graph on the HP 11970 can be accomplished by averaging the graph's maximum and minimum power points. This results in an overall conversion loss for the entire band. By using this method, an increase of measurement uncertainty is introduced into the test. Reference level offset is determined by the following equation:

$$\text{Conversion Loss} - 30 \text{ dB} = \text{Reference Level Offset}$$

Because the test configuration in Figure 2-9 specifies that the external mixer be connected to the coupled arm of a 20 dB directional coupler, the coupled power must also be taken into account when calculating reference level offset. The new equation is as follows:

$$\text{Conversion Loss} + \text{Coupled Power (20 dB)} - 30 \text{ dB} = \text{Reference Level Offset}$$

5. On the HP 8673B/C/D:

Manually tune the synthesizer from 26.5 to 37.2 GHz while watching for harmonic responses that are higher than the display (<20 dBc) line on the HP 8566B display.

Signal Identification

6. If a harmonically related spurious signal is out of specifications, verify that it is a true in-band signal as follows:
7. Tune the signal under observation to the center graticule of the HP 8566B display.
8. Press **[SHIFT] [FREE RUN]** on the spectrum analyzer.
9. If the signal is a false response, the annotation **IDENTIFIED OUT OF BAND** will appear on the spectrum analyzer display.
10. Ensure that any harmonic-related spurious signals observed are within the specified level of >20 dBc.

Measurement Uncertainty

Measurement uncertainty within the test configuration will affect the accuracy of this performance test. To obtain optimum accuracy, amplitude calibrate the spectrum analyzer by entering the conversion loss at each frequency signal under observation as explained under **Amplitude Calibration of the HP 8566B**. Any harmonically related spurious signals that are at 20 dBc should be given an allowable margin of ± 1.5 dB to compensate for all other measurement uncertainties within the test configuration.

11. The foregoing steps performed a harmonic related spurious test from 26.5 to 37.2 GHz at a specified maximum leveled power of 8.0 dBm. The proceeding steps will continue this test covering the remaining frequency range of the R-Band (37.2 to 40.0 GHz) at a maximum leveled power of 7.0 dBm.
12. On the HP 8673B/C/D:
Adjust the VERNIER for a reading of +7.0 dBm on the power meter display.
13. On the HP 8566B:
Press [REF LEVEL] [7] [.] [0] [+ dBm]
Press DISPLAY LINE [ENTER] [1] [3] [- dBm], setting the 20 dBc reference.
14. Repeat steps 5 through 10 except this time tune the HP 8673B/C/D from 37.2 to 40.0 GHz.

This concludes the performance test for harmonic related spurious signals. Performance of this test ensures that all potential problem harmonic related spurious locations have been thoroughly tested for the HP 8673B/C/D/83554A system.

If your system fails to meet these specifications, refer to the paragraph titled TROUBLESHOOTING.

TROUBLESHOOTING

Specification Failures

Failures are divided into two categories:

Category one describes systems that are meeting specifications in some areas, while failing others. If this is the case, do the following:

- Inspect the connectors and ensure that all connections are making good electrical contact.

- Inspect all cabling for breaks.

- Test again.

If the system fails at DIFFERENT points, there is probably a loose connection or a mechanical failure somewhere in the test setup. If the system fails at the SAME points, the instruments or cables may be defective. Refer to the appropriate operating and service manual for each individual instrument and perform the operator's checks to isolate any possible defective instrument.

Category two describes total specification failures. If the system fails any of the previous tests completely, do the following:

- Check the TEST SETUP for correct configuration of the instruments and connections.

- Inspect the connectors.

- Inspect the cables.

- Repeat the failed test.

If the system still fails to meet specifications, the millimeter-wave source module may be defective. However, it is possible that one of the other instruments is defective. Refer to the appropriate operating and service manual for each individual instrument and perform the operator's checks or abbreviated performance tests to ensure that the other instruments are working properly.

Test failures are possible due to measurement uncertainties. Also, for best accuracy in measurement, use only properly calibrated instruments.

Troubleshooting System Harmonics

If the HP 8673B/C/D/83554A system fails to meet the specifications mentioned in step 5 of the System Harmonics test, the failure may be occurring from either the HP 8673B/C/D synthesized signal generator, the HP 8349B, or the HP 83554A mm-wave source module. The following steps will help to isolate the origin of the failure. See Figure 2-10 for the harmonic check points.

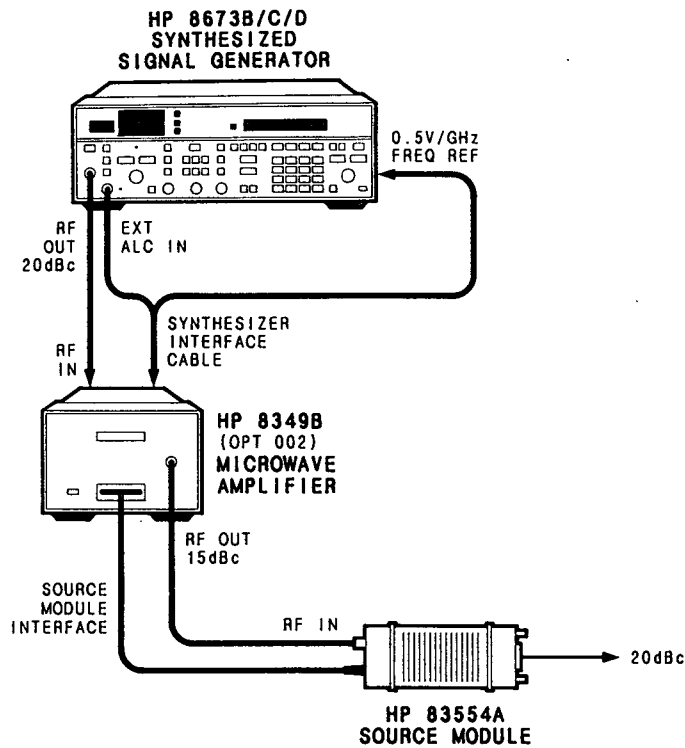

Figure 2-10. Harmonic Check Points

1. If the harmonically related spurious output from the millimeter-wave source module is less than 20 dBc, check the harmonic output of the HP 8349B. For frequencies of 26.5 to 37.2 GHz, all harmonics must be >15 dBc. For frequencies of 37.2 to 40.0 GHz, (HP 8673B and D only), the $(3/4 \times f_0)$ harmonic must be >27 dBc. All other harmonics must be >15 dBc.
2. If the HP 8349B harmonic output is within specifications, refer to the Source Module Specifications and Service section of this manual and perform the Harmonic Spurious performance test to verify that the HP 83554A is at fault. If the HP 83554A is at fault, refer to the Specifications and Service section for repair or replacement of the instrument.
3. If the HP 8349B harmonic output does not meet specifications, refer to Section 4, Performance Tests, of the HP 8673B/C/D Operating and Service manual. Perform the Harmonics test. If the synthesizer meets specifications, repair or replace the HP 8349B.
4. If the HP 8673B/C/D does not meet harmonic output specifications, repair or replace the synthesizer.

REGIONAL SALES AND SUPPORT OFFICES

For information relating to Sales or Support of Hewlett-Packard products first contact your local Hewlett-Packard office listed in the white pages of your telephone directory. If none is listed locally, contact one of the addresses listed below to obtain the address or phone number of the Hewlett-Packard Sales or Support office nearest you.

ASIA

Hewlett-Packard Asia Ltd.
47/F, 26 Harbour Road,
Wanchai, **HONG KONG**
G.P.O. Box 863, Hong Kong
Tel: (852) 5-8330833
Telex: 76793 HPA HX
Cable: HPASIAL TD

AUSTRALASIA

Hewlett-Packard Australia Ltd.
31-41 Joseph Street
BLACKBURN, Victoria 3130
Australia
Tel: (61) 895-2895
Telex: 31-024
Cable: HEWPARD Melbourne

CANADA

Hewlett-Packard (Canada) Ltd.
6877 Goreway Drive
MISSISSAUGA, Ontario L4V 1M8
Tel: (416) 678-9430
Telex: 069-8644

JAPAN

Yokogawa-Hewlett-Packard Ltd.
29-21 Takaido-Higashi, 3 Chome
Suginami-ku **TOKYO** 168
Tel: 03 (331) 6111
Telex: 232-2024 YHPTOK

MEDITERRANEAN AND MIDDLE EAST

Hewlett-Packard S.A.
Mediterranean and Middle East
Operations
Atrina Centre
32 Kifissias Avenue
Paradissos-Amarousion, **ATHENS**
Greece
Tel: (30) 682 88 11
Telex: 21-6588 HPAT GR
Cable: HEWPACKSA Athens

BENELUX & SCANDINAVIA

Hewlett-Packard S.A.
Uilenstede 475
P.O. Box 999
NL-1183 AG **AMSTELVEEN**
The Netherlands
Tel: (31) 20/43 77 71
Telex: 18 919 hpner nl

SOUTH & EAST EUROPE, AFRICA

Hewlett-Packard S.A.
7, rue du Bois-du-Lan
CH-1217 **MEYRIN 2**, Geneva
Switzerland
Tel: (41) 22/83 12 12
Telex: 27835 hmea
Cable: HEWPACKSA Geneve

FRANCE

Hewlett-Packard France
Parc d'activités du Bois Briard
2, avenue du Lac
91040 **EVRY** Cedex
Tel: 1 6/077 83 83
Telex: 6923 15F

GERMAN FEDERAL REPUBLIC

Hewlett-Packard GmbH
Hewlett-Packard-Strasse
Postfach 1641
D-6380 **BAD HOMBURG**
West Germany
Tel: 06172/400-0
Telex: 410 844 hpbhg

ITALY

Hewlett-Packard Italiana S.p.A.
Via G. Di Vittorio 9
1-20063 **CERNUSCO SUL
NAVIGLIO**
(Milano)
Tel: 02/92 36 91
Telex: 334632

UNITED KINGDOM

Hewlett-Packard Ltd.
King Street Lane
Winnersh, **WOKINGHAM**
Berkshire RG11 5AR
Tel: 734/78 47 74
Telex: 847178

EASTERN USA

Hewlett-Packard Co.
4 Choke Cherry Road
ROCKVILLE, MD 20850
Tel: (301) 670-4300

MIDWESTERN USA

Hewlett-Packard Co.
5201 Tollview Drive
ROLLING MEADOWS, IL 60008
Tel: (312) 255-9800

SOUTHERN USA

Hewlett-Packard Co.
2000 South Park Place
P.O. Box 105005
ATLANTA, GA 30348
Tel: (404) 955-1500

WESTERN USA

Hewlett-Packard Co.
5161 Lankershim Blvd.
P.O. Box 3919
NO. HOLLYWOOD, CA 91609
Tel: (818) 506-3700

OTHER INTERNATIONAL AREAS

Hewlett-Packard Co.
Intercontinental Headquarters
3495 Deer Creek Road
PALO ALTO, CA 94304
Tel: (415) 857-1501
Telex: 034-8300
Cable: HEWPACK



**HEWLETT
PACKARD**

**Source Module
Specifications and Service**



INTRODUCTION

The HP 83554A millimeter-wave source module extends the frequency range of 11 to 20 GHz sources to 26.5 to 40 GHz (R Band). This mm-wave source module is enhanced by the performance features of HP microwave source drivers such as the HP 83550A and 83590 Series RF plug-ins, the HP 8340 Series synthesized sweepers, and the HP 8670 Series synthesized signal generators.

This section of the manual provides information that will enable you to use the source module in different mm-wave source system configurations. Each system configuration is separately documented in its own Source System Guide, addressing each according to source driver and applications. The individual guides also provide system specifications, connection diagrams, operating characteristics, performance tests, and troubleshooting sections.

RECOMMENDED TEST EQUIPMENT

Test equipment required for system performance testing is given in Table 2A. If substitute equipment is used, it must meet the critical specifications shown in the table.

SPECIFICATIONS

The HP 83554A source module uses frequency multiplication to generate mm-wave frequencies. The frequency specifications are directly proportional to those of the external signal source driving the source module. Therefore, those specifications are extensions of the specified signal source and are detailed in each source system guide. The output characteristic specifications are source module specific and are detailed in the Source Module Specifications and Service Section.

OPERATION

The operation portion of the applicable source system guide will enable you to use the HP 83554A source module in a variety of applications. Included are system hookup diagrams that illustrate the source module in a systems environment, test procedures that cover the measurement system, and operational suggestions.

PERFORMANCE TESTS

The test procedures in these sections test the electrical performance of the HP 83554A with a specified source driver in a systems configuration. These tests reference the System Specifications table of each Source System Guide as the performance standards against which the system is tested.

SYSTEM LEVEL TROUBLESHOOTING

Within each Source System Guide is a System Level Troubleshooting section to help isolate system failures to an instrument level. Once an instrument is isolated as the failure, references to the specific Operating and Service manual are made for repair procedures.

Table 2A. Recommended Test Equipment

Instrument	Critical Specifications	Recommended Model	Use ¹
Spectrum Analyzer	11.0 to 20.0 GHz Coverage 2 Channel display, waveform storage and normalization	HP 8566B	P
Power Meter	-10 to +20 dBm power coverage	HP 436A	O,P,T
Power Sensor	-10 to +20 dBm power coverage with 26.5 to 40.0 GHz frequency coverage	HP R8486A	O,P,T
Microwave Amplifier	2.0 to 8.0 GHz Range	HP 11975A	P
Harmonic Mixer	26.5 to 40.0 GHz frequency coverage	HP 11970A	P
Wave Guide Directional Coupler	26.5 to 40.0 GHz frequency coverage with 40 dB directivity	HP R752D	O,P
Crystal Detector	26.5 to 40.0 GHz frequency coverage	HP R422A	O
Cables (2)	3.5 mm connectors	HP P/N 5061-5458	O,P,T
Cables (5)	BNC Connectors	HP P/N 8120-1839	
Cables (2)	Type-N male connectors 8 to 20 GHz range, SWR \leq 1.45 to 1, insertion loss \leq 2 dB.	HP P/N 5061-5359	O,P,T

1. O = Operation; P = Performance Test; T = Troubleshooting

TABLE of CONTENTS

SPECIFICATIONS AND SERVICE

- Introduction**
- Specifications**
- Description**
- Equipment Required But Not Supplied**
- Recommended Test Equipment**
- Initial Inspection**
- Mating Connectors**
- Preparation For Use**
- Performance Tests**
 - Introduction**
 - Equipment Required**
 - Operation Verification**
 - Test Record**
 - Calibration Cycle**
 - Maximum Leveled Power Test**
 - Power Level Flatness Test**
 - Power Level Accuracy Test**
 - Output SWR Test**
 - Multiplier Harmonic Test**
 - Harmonic Spurious Test**
- Service**
 - Introduction**
 - Adjustments**
 - Theory of Operation**
 - Disassembly Procedure**
 - Troubleshooting**
 - Schematic**
 - Replaceable Parts**

Source Module Specifications and Service

INTRODUCTION

This section contains information that is specific to the HP 83554A source module: instrument specifications, theory of operation, procedures for performance tests, procedures for troubleshooting, and a replaceable parts list. For detailed instructions regarding the operation or troubleshooting of an individual instrument other than the source module, refer to that particular instrument's operating and service manual.

SPECIFICATIONS

Source module specifications are divided into two categories:

- Source driver dependent specifications (system specifications).
- Source module specifications independent of signal source.

Because the HP 83554A source module uses frequency multiplication to generate millimeter-wave frequencies, source module frequency specifications are directly proportional to those of the external signal source driving the source module. The specifications that are an extension of the external signal source are detailed in the Source System Guide (Table 2-1) for that particular source system configuration.

Specifications for the source module that are independent of the source driver are listed in Table 3-1 of this section. These performance standards together with the performance standards listed in the Source System Guide that describes the system you are using, are the limits against which the instrument can be tested.

If source system conformance to specifications is required, BOTH (source system and source module) sets of performance tests must be performed to completely verify instrument conformance to the specifications.

Table 3-1. Specifications of the HP 83554A Source Module (Independent)

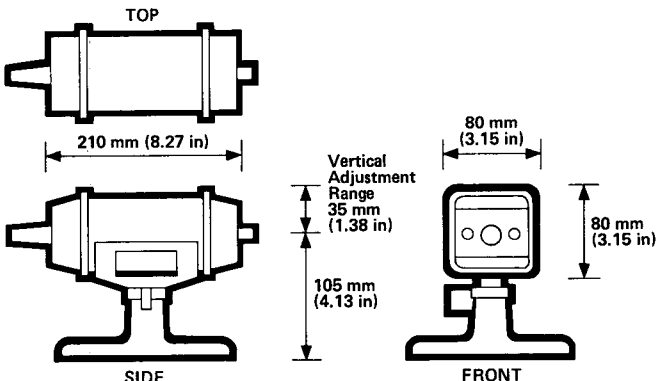
Model Number	HP 8350, HP 83550A	HP 8350, 83590 Series, HP 8349B	HP 8340A, HP 8349B HP 8341A, HP 8349B	HP 8673B/C/D, HP 8349B
Frequency Characteristics Range	26.5 to 40.0 GHz	26.5 to 40.0 GHz	26.5 to 40.0 GHz	26.5 to 40.0 GHz (8673B/D) 26.5 to 37.2 GHz (8673C)
Output Characteristics (25°C ± 5°C) Maximum Leveled Power	+8 dBm, 26.5 to 37.2 GHz +7 dBm, 37.2 to 40.0 GHz	+8 dBm, 26.5 to 37.2 GHz +7 dBm, 37.2 to 40.0 GHz	+8 dBm, 26.5 to 37.2 GHz +7 dBm, 37.2 to 40.0 GHz	+8 dBm, 26.5 to 40.0 GHz +7 dBm, 37.2 to 40.0 GHz
Minimum Settable Power	-5 dBm	-5 dBm	-5 dBm	-5 dBm
Power Level Accuracy (25°C ± 5°C) System Leveled	± 2.00dB	± 2.00dB	± 2.00dB	± 2.00dB ¹
Power Flatness (at max leveled power) System Leveled	± 1.50 dB	± 1.50 dB ²	± 1.50 dB ²	± 1.50 dB ²
Source Input SWR System unleveled Typically	<7.0	<7.0	<7.0	<7.0
Source Output SWR System Leveled	<2.0	<2.0	<2.0	<2.0
System Unleveled Typically	<3.0	<3.0	<3.0	<3.0
Spectral Purity Specifications Spurious Signals expressed in dB relative to the carrier level (dBc).				
Multiplier Harmonic	>30 dBc	>30 dBc	>30 dBc	>30 dBc
Harmonic Spurious	>30 dBc	>20 dBc ³	>20 dBc	>20 dBc ⁴
General Specifications Input frequencies: 13.25 to 20.00 GHz Minimum input power level into HP 83554A RF input cable: +17 dBm (50mW) Maximum input power level into HP 83554A RF input cable: +27 dBm (500 mW) Waveguide output connector: EIA size WR 28 waveguide. Mates with JAN UG-599 flange. Weight: Net, 1.7 kg (4 lb.). Furnished with each HP 83554A: Operating and Service Manual, RF cable (also available as HP Part No. 5061-5359), Module Base Assembly (also available as HP Part No. 83556-60010).	Dimensions:  TOP: 210 mm (8.27 in) SIDE: 105 mm (4.13 in) FRONT: 80 mm (3.15 in) width, 80 mm (3.15 in) height, Vertical Adjustment Range 35 mm (1.38 in)			
1. When remotely programmed; when power is referenced to front panel add ±0.75 dB 2. Must have 0.5 V/GHz modification. 3. With the exception of the HP 83592C which is >30 dBc. 4. With the exception of the HP 8673C/D which is >30 dBc.				

DESCRIPTION

The HP 83554A source module is a frequency multiplier that uses a 13.25 to 20.00 GHz input frequency range. The HP 83554A doubles the input frequencies to generate an output frequency range of 26.5 to 40 GHz. The RF power and control signals for the mm-wave source module are obtained from a source driver. For specified performance, the input RF energy must be between +17 dBm and +27 dBm through the RF cable provided with the source module. All the power supplies and control signals are applied to the source module through the source module interface cable.

The source module cables and connectors are detailed in Figure 3-1.

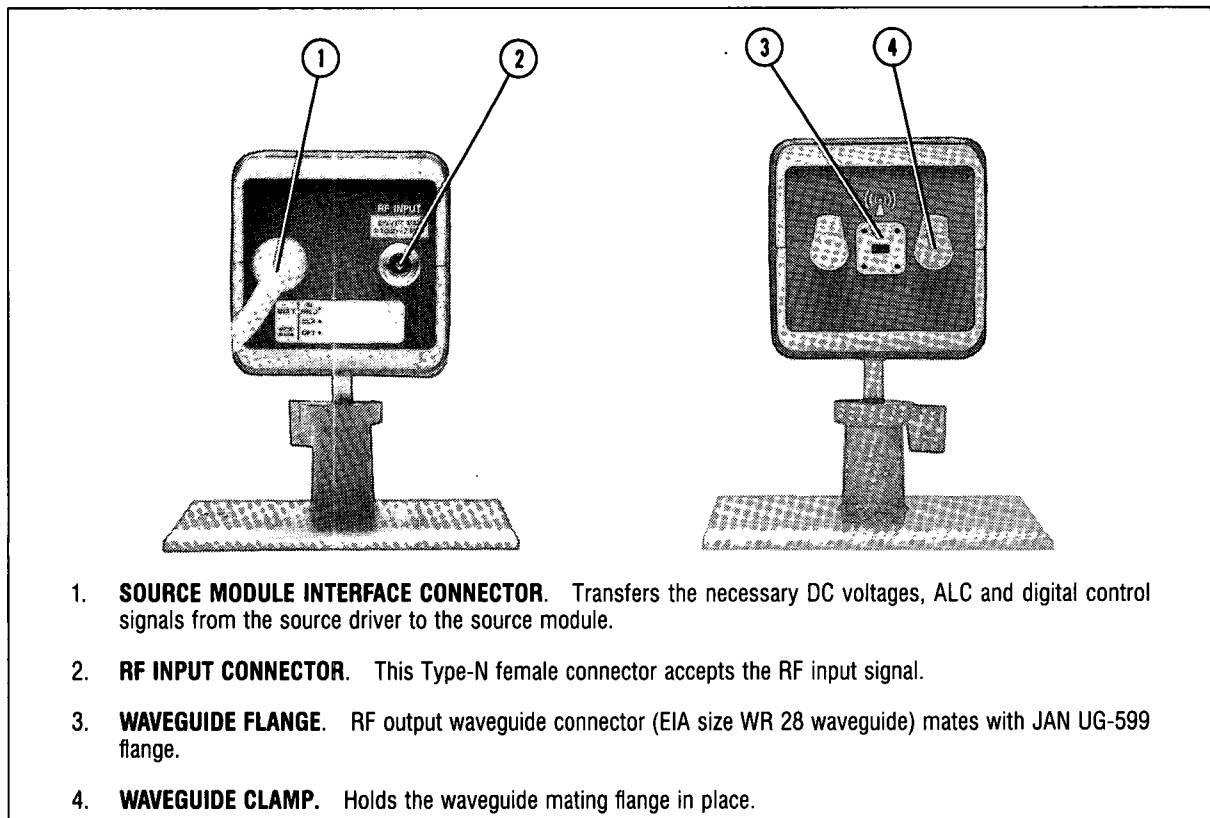

Figure 3-1. HP 83554A Features

EQUIPMENT REQUIRED BUT NOT SUPPLIED

For information on accessories and instruments used in a source module system, refer to Figure 3 and to Tables 1 and 2 in System General Information.

RECOMMENDED TEST EQUIPMENT

The equipment required for testing and/or troubleshooting the instrument is listed in Table 3-2. Other equipment may be substituted if it meets or exceeds the critical specifications indicated in the table.

INITIAL INSPECTION

If information is needed for incoming inspection, operating environment, and shipping instructions, refer to System Installation in the System General Information section. If the source module does not pass the electrical performance tests and a circuit malfunction is suspected, refer to the troubleshooting paragraphs in this section.

MATING CONNECTORS

The HP 83554A output connector is EIA size WR 28 waveguide. This waveguide should mate directly with a UG-599/U cover flange, and can be mated to a UG-381/U cover flange with the use of an HP 11516A waveguide adapter.

PREPARATION FOR USE

For information on site preparation, operating environment, and safety considerations, refer to the System General Information section of this manual.

Table 3-2. Recommended List of Test Equipment

Instrument	Critical Specifications	Recommended Model
sweep oscillator	compatible with RF plug-in	HP 8350
RF plug-in*	11 to 20 GHz coverage external leveling capability	HP 83590 Series
RF plug-in	11 to 20 GHz coverage non-harmonic spurious: >50 dBc	HP 83550A
microwave amplifier	15 dB gain to 20 GHz non-harmonic spurious: >50 dBc	HP 8349B
spectrum analyzer	2 to 20 GHz coverage two channel display, waveform storage and normalization	HP 8566B
network analyzer	76 dB dynamic range -60 dBm to -16 dBm	HP 8757A
AC/DC detector	R-band 26.5 to 40 GHz	HP R85026A
power meter	-10 to +20 dBm programming capability	HP 436A or Anritsu ML83A
power sensor	R-band 26.5 to 40 GHz maximum input: +24 dBm	HP R8486A or Anritsu MP 713A-004
power sensor	2 to 20 GHz coverage	HP 8485A
digital voltmeter	range: -50V to +50V accuracy: $\pm 0.01\%$	HP 3456A
AC/DC detector (2)	compatible with analyzer, 0.1 to 26.5 GHz coverage	HP 85025B
power splitter	0.1 to 26.5 GHz coverage	HP 11667B
isolator	8 to 20 GHz coverage	HP Part No. 0955-0265
microwave amplifier	2 to 8 GHz coverage	HP 11975A
waveguide detector	R-band 26.5 to 40 GHz	HP R422A
waveguide short	R-band 26.5 to 40 GHz	HP R920B
waveguide load	R-band 26.5 to 40 GHz	HP R914B
waveguide coupler	R-band 26.5 to 40 GHz, 10 dB	HP R752C
waveguide coupler	R-band 26.5 to 40 GHz, 20 dB	HP R752D
dual directional coupler	2 to 18 GHz	HP 11692D
harmonic mixer	R-band 26.5 to 40 GHz	HP 11970A
RF cables (3)		HP Part No. 5061-5458
attenuator	DC to 20 GHz, 3 dB attenuator	HP 33340C Option 003

* must have 0.5V/GHz modification

SOURCE MODULE PERFORMANCE TESTS

INTRODUCTION

The procedures in this section allow you to test the source module's electrical performance to the specifications in Table 3-1. Because the specifications tested in this section are not dependent on the source driver, any system configuration described in Figure 3 of the System General Information Section can be used. All of the tests in this section can be performed without access to the interior of the instrument. A simpler operational test is included in all of the Source System Guides, under Operator's Check.

In the instructions, the words "press" and "select" will be used to mean, "press key named...". The only difference is, "press" references a front panel labeled key, while "select" is used to reference softkeys.

NOTE: Ensure that all the test equipment used meets its own performance standards and has been recently calibrated to proper specifications before performance testing.

The performance test procedures must be performed in the sequence given, because some procedures rely on satisfactory test results in foregoing steps. If a test measurement is out of tolerance, refer to the troubleshooting paragraphs in this section.

NOTE: Allow the HP 83554A and system components to warm up for one hour prior to doing any performance tests.

EQUIPMENT REQUIRED

Equipment required for testing the source module is listed in Table 3-2, the Recommended Test Equipment in this section, and in Figure 3 in System General Information. Any equipment that satisfies the critical specifications given in the table may be substituted for the recommended models. All of the recommended RF sources must be equipped with the 0.5V/GHz frequency reference capability.

OPERATION VERIFICATION

Operation Verification consists of performing the first three performance tests in this section. These tests provide reasonable assurance that the source module is functioning properly and should meet the needs of an incoming inspection (80% verification).

When a major assembly is replaced, various tests must be run to verify the operation of the source module. A list of which tests must be run after replacement of specific assemblies is given below.

Assemblies Changed	Tests To Be Performed
A2 Power Amplifier Assembly	Maximum Leveled Power Power Level Flatness Power Level Accuracy
A4 Multiplier Assembly	Maximum Leveled Power Power Level Flatness Power Level Accuracy Multiplier Harmonic Test
A5 Interface Board Assembly	Maximum Leveled Power Power Level Flatness Power Level Accuracy

TEST RECORD

Results of the performance tests can be recorded in the Test Record at the end of the procedures. The Test Record lists all of the tested specifications and their acceptable limits. Test results recorded at incoming inspection can be used for comparison in periodic maintenance, in troubleshooting, or after repairs.

CALIBRATION CYCLE

The performance tests in this section should be performed every twelve months. The instruments in the source system configuration should be performance tested as indicated in the appropriate operating and service manual.

WARNING

This equipment is capable of radiating millimeter-wave energy from the end of unterminated waveguide. Do not look directly into the open end of any waveguide when it is connected to a source of millimeter-wave energy.

Take precautions consistent with ANSI C95.1 - 1982, a study performed by the American National Standards Institute that sets limits for human exposure to microwave and millimeter-wave energy. Copies of this publication are available from:

**American National Standards Institute
1430 Broadway
New York, N. Y. 10018**

MAXIMUM LEVELED POWER TEST

Specification

Maximum Leveled Power (25°C ± 5°C):

- +8.0 dBm from 26.5 to 37.2 GHz
- +7.0 dBm from 37.2 to 40.0 GHz

Description

Using the following procedure, you can verify the maximum leveled output power performance of your HP 83554A mm-wave source module. The output power of the source driver is set for maximum power out. A frequency range is manually swept while observing a power meter to locate the lowest power point. The source driver power control is adjusted at the frequency of the lowest power point until the unleveled light turns off. The frequency range is manually swept again and the power is observed on the power meter to ensure the specified power is met. The procedure is repeated for the second portion of the R-band frequency range.

Equipment

- Source Driver Any source in Figure 3 of System General Information
- Power Meter HP 436A
- Power Sensor HP R8486A

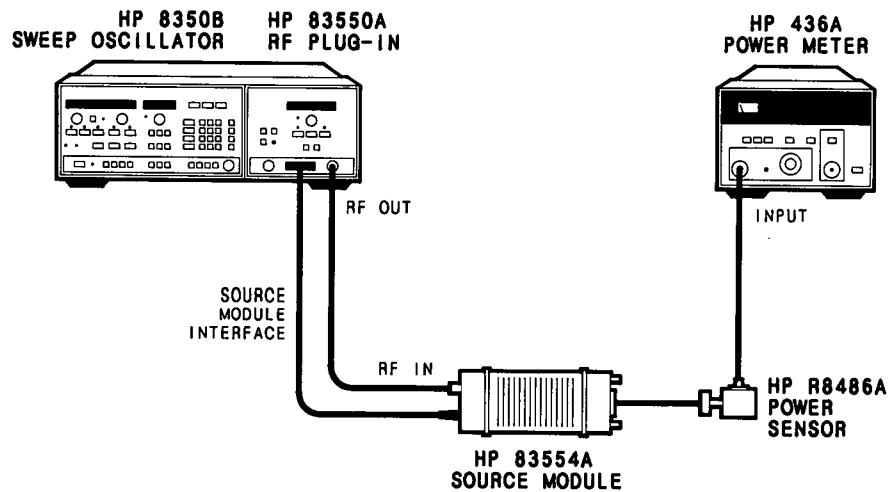

Figure 3-2. Typical Maximum Leveled Power Test Setup

Procedure

1. Connect the equipment in one of the mm-wave system configurations. (Refer to Figure 3 in System General Information.)

NOTE: Turn off the AC power when connecting to or disconnecting from any component of the mm-wave system configuration.

2. Turn on all system components.
3. On the RF source, select the external leveling mode and set the power for maximum power out. The unlevelled light should be on.
4. Select a MANUAL SWEEP from 26.5 GHz to 37.2 GHz.

NOTE: Ensure that the SQ MOD control is off or it will affect accuracy of this test.

5. Manually sweep the frequency range, observing the power meter to locate the lowest power point.
6. At the lowest power point, adjust the power control until the RF source unlevelled light turns off.
7. Manually sweep the frequency range again, watching the unlevelled light to make sure that it stays off across the entire band. If the unlevelled light turns on, stop at the frequency where this occurs, and adjust the power level until the light goes off.
8. When the unlevelled light stays off across the entire frequency band, find the minimum power point and stop at this frequency. Adjust the power meter calibration factor, as referenced on the power sensor, for the low power point frequency. Measured power should be $> +8$ dBm.
9. On the source, set the frequency range to 26.5 to 40.0 GHz and repeat steps 3 through 8 to test the remaining portion of the band. The measured power in step 8 should be $+7$ dBm.

POWER LEVEL FLATNESS TEST

Specification

Power Flatness (at maximum specified power; $25^{\circ}\text{C} \pm 5^{\circ}\text{C}$)

System Leveled ± 1.50 dB

Description

A power meter is used to check power level flatness at +8 dBm from 26.5 to 37.2 GHz and at +7 dBm from 26.5 to 40.0 GHz.

Equipment

Source Driver Any source in Figure 3 of System General Information
Power Meter HP 436A
Power Sensor HP R8486A

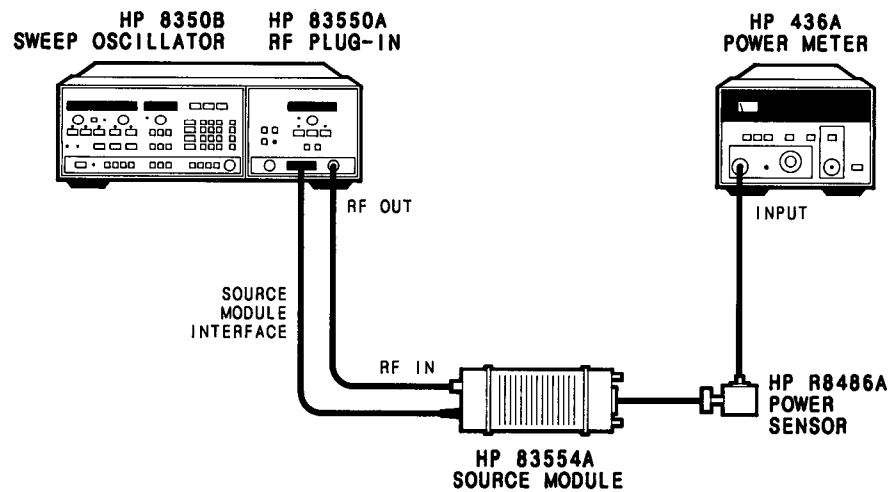

Figure 3-3. Typical Power Flatness Test Setup

Procedure

1. Connect the equipment in one of the mm-wave source module system configurations. (Refer to Figure 3 in System General Information.)

NOTE: Turn off the AC power when connecting to or disconnecting from any component of the mm-wave system configuration.

2. Turn on all system components.
3. Select MANUAL SWEEP from 26.5 GHz to 37.2 GHz on the RF source.
4. Select external leveling mode on the RF source driver and set the source module output power for +8 dBm.

NOTE: Ensure that the SQ MOD control is off or it will affect the accuracy of this test.

5. Manually sweep the frequency range and locate the lowest power point using a power meter.
6. Set the calibration factor, as referenced on the power sensor, for the low power point frequency. Set this point to a measured + 8.0 dBm with the power control on the source driver.
7. Manually sweep the frequency range again while viewing the measured output power. The power out should not exceed + 11.0 dBm.
8. On the source driver, set the frequency range to 26.5 to 40.0 GHz, and repeat steps 3 through 7 to test the remaining portion of the band. Set the power in steps 4 and 6 to +7 dBm. Measured power in step 7 should not exceed +10.0 dBm.

NOTE: This is a brief procedure of a test that appears earlier in this manual. For more detailed information on this test, refer to the Operator's Check in any of the Source System Guides.

POWER LEVEL ACCURACY TEST

Specification

Power Level Accuracy (25°C ± 5°C):

System leveled ± 2.00 dB

Description

The frequency range is manually swept at five different power settings while observing a power meter for locating the minimum and maximum power points.

Equipment

- Source Driver Any source in Figure 3 of System General Information
- Power Meter HP 436A
- Power Sensor HP R8486A

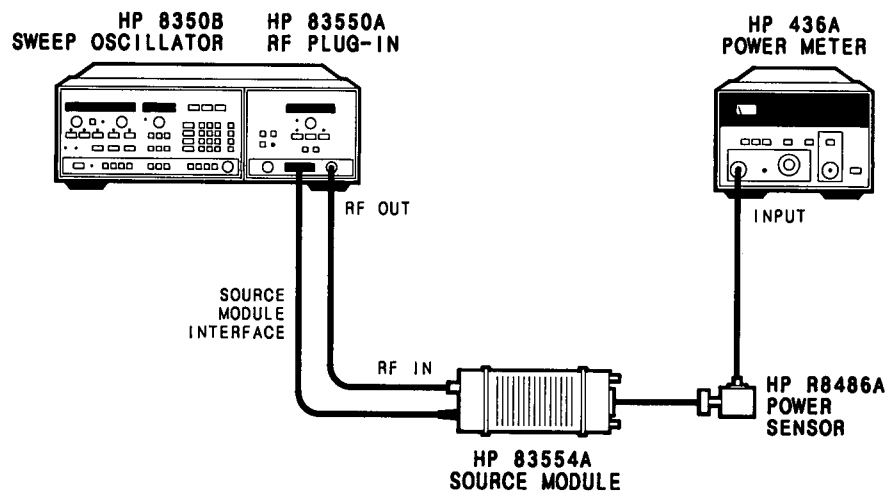

Figure 3-4. Typical Power Level Accuracy Test Setup

Procedure

NOTE: Ensure that the source module meets the power flatness performance test specifications before performing this test. If it does not, the results of this test may be invalid and may not meet specifications.

1. Connect the equipment in one of the mm-wave source module system configurations. (Refer to Figure 3 in System General Information.)

NOTE: Turn off the AC power when connecting to or disconnecting from any component of the mm-wave system configuration.

2. Turn on all system components.
3. Select a MANUAL SWEEP from 26.5 GHz to 40.0 GHz
4. Set the RF source driver for external leveling mode, and set the source module output power for +7 dBm.

NOTE: Ensure that the SQ MOD control is off or it will affect the accuracy of this test.

5. Manually sweep the frequency range while using a power meter for measurement. Locate the lowest power point. Note frequency and adjust power meter calibration factor, as referenced on the power sensor, for the frequency at the low power point. The measured power should be $> +5.00$ dBm.
6. Sweep the frequency range again while observing the power meter display and find the maximum power point. Note frequency and adjust power meter calibration factor, as referenced on the power sensor, for the frequency at the maximum power point. The measured power should be $< +9.00$ dBm.
7. Repeat steps 4, 5, and 6, using the following power settings:

Displayed Power	Minimum Power	Maximum Power
+4 dBm	≥ 2.00 dBm	$\leq +6.00$ dBm
+1 dBm	≥ -1.00 dBm	$\leq +3.00$ dBm
-2 dBm	≥ -4.00 dBm	≤ -0.00 dBm
-5 dBm	≥ -7.00 dBm	≤ -3.00 dBm

NOTE: With the HP 8673 Series, add ± 0.75 dB to the minimum and maximum values shown above.

OUTPUT SWR TEST

Specification

Output SWR ≤ 2.0

Description

The Output SWR test measures the RF output signal using a directional coupler, an AC/DC detector, and a scalar network analyzer. A load is placed on the end of the waveguide to prevent any reflections from being seen at the coupled port. The signal at the end of the coupled port is then stored into the scalar network analyzer memory. A short is then placed on the waveguide, the scalar network analyzer is set to display measurement minus memory, and the maximum change in power is measured. The dB value of the maximum point on the scalar network analyzer is determined and this value is then converted to SWR using a conversion chart.

Equipment

Source Driver	Any Source in Figure 3 of System General Information
Scalar Network Analyzer	HP 8757A
Detector	HP R85026A
Waveguide Coupler	HP R752C
Waveguide Load	HP R914B
Waveguide Short	HP R920B

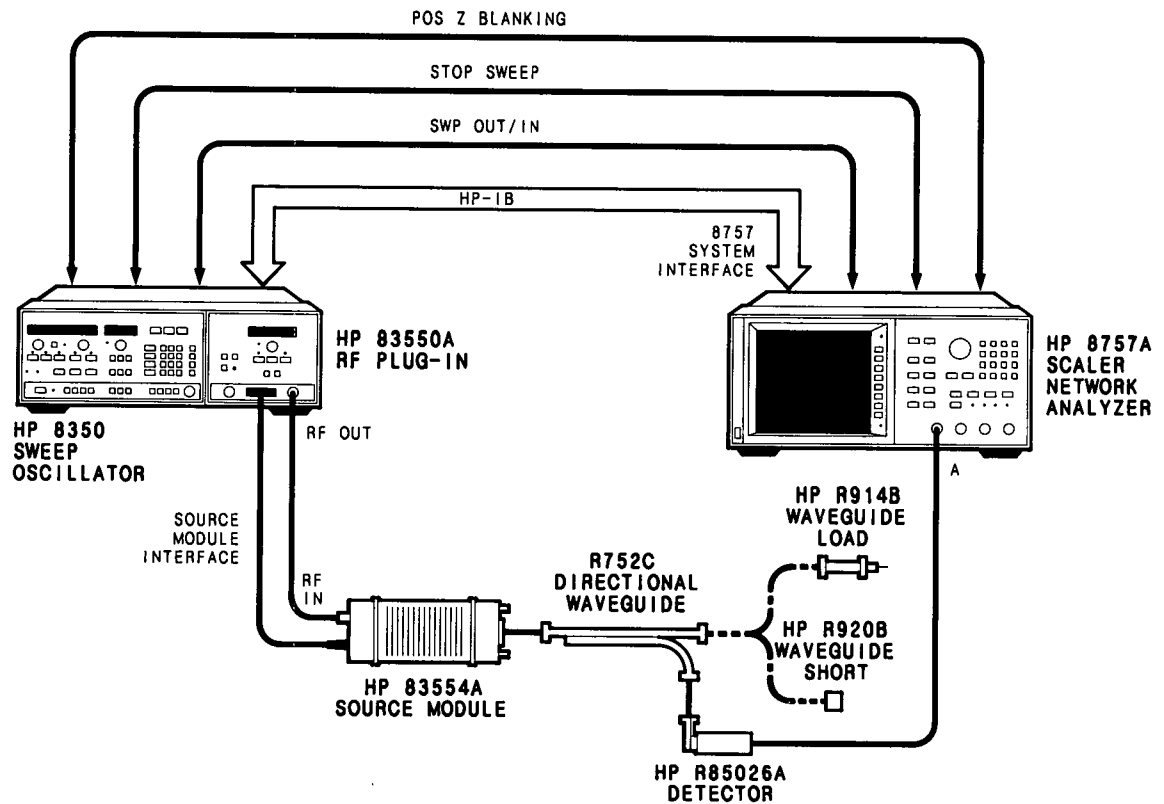

Figure 3-5. Output SWR Test Setup

Procedure

1. Connect the equipment as shown in Figure 3-5 with the load connected to the waveguide.
2. Set the source driver as follows:
 - Instr Preset
 - External Leveling Mode
 - Power Level: +7 dBm
 - Sweep Speed: 200 ms
 - SQ Mod: Off
3. Set the scalar network analyzer as follows:
 - Channel A
 - DC Det Mode (under SYSTEM menu)
 - Reference Level: Approximately -3 dBm
 - dB/Div: 1dB
 - Reference Position: Center of CRT
4. Observe a display on the scalar network analyzer of leveled power.
5. Perform a normalized calibration as follows:
 - Under the MEAS menu select channel A.
 - Under the DISPLAY menu select MEAS, then MEAS→MEM, and finally MEAS-MEM.
6. Disconnect the waveguide load and replace it with the sliding short. Adjust the sliding short through its entire range and note the largest peak-to-peak variation on the scalar network analyzer display.
7. Calculate the SWR using Figure 3-6 as follows:
 - a. Find the largest peak-to-peak variation (noted in step 6) on the left vertical scale.
 - b. Find the intersection of the peak-to-peak variation and the 1.0 dB loss curve.
 - c. Move vertically down from the intersection to read the SWR on the bottom horizontal scale. The SWR should be ≤ 2.0 .

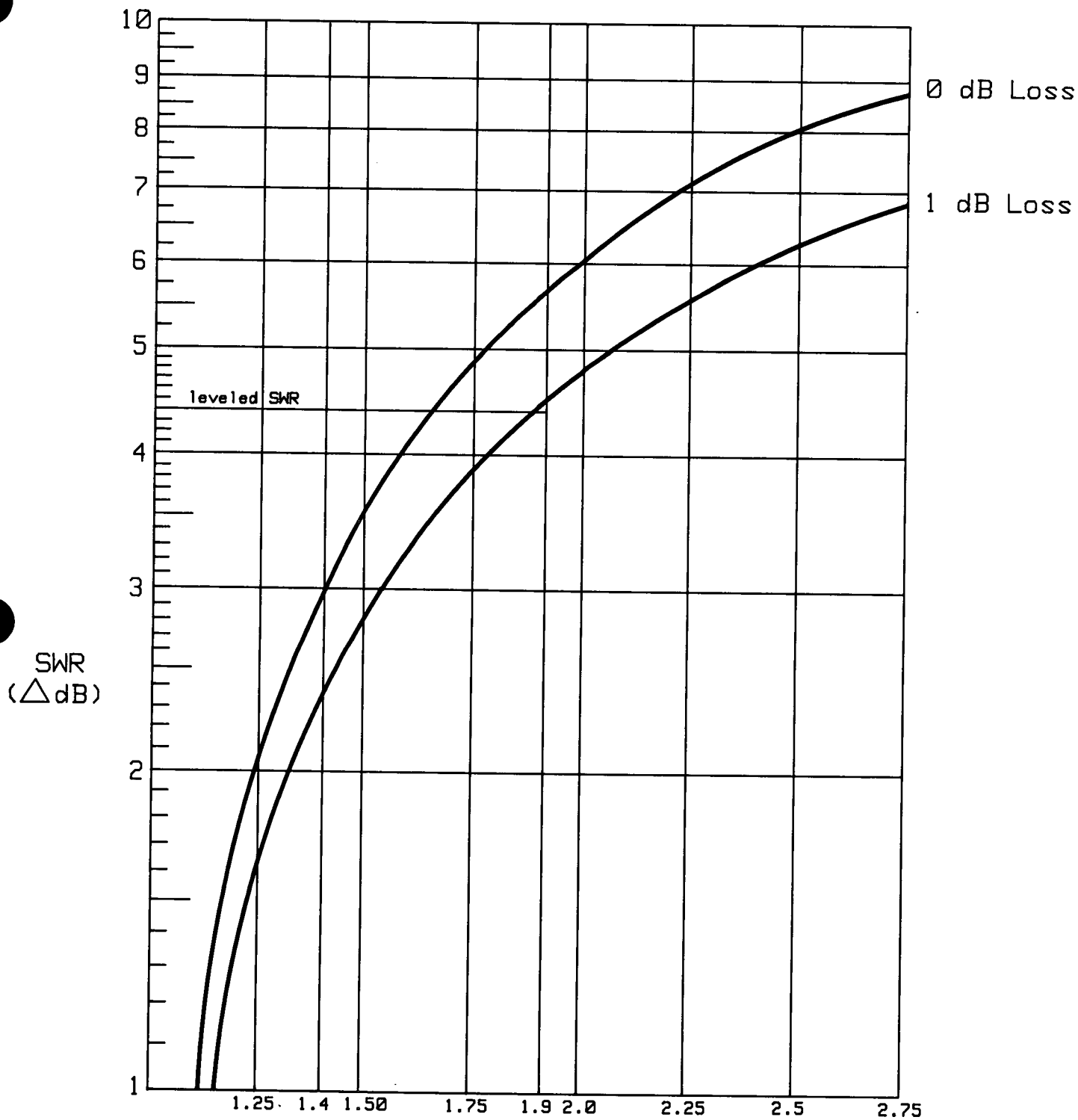

Figure 3-6. Conversion Chart

MULTIPLIER HARMONIC TEST

Specification

Harmonic Related > 30 dBc

Description

The following procedure addresses the 3/2 multiplier harmonic response. The location of the 3/2 harmonic can be calculated by using the equation in the procedure of this test. For any CW output signal between 26.5 and 27.0 GHz from the HP 83554A mm-wave source module, an accompanying 3/2 harmonic response may be present within the R-band frequency band.

The RF output signal from the source module is tuned from 26.5 to 27.0 GHz and 3/2 harmonics are displayed on a spectrum analyzer to verify that any harmonic spurious signals are at or below their specified levels. The test configuration in Figure 3-7 uses an external harmonic mixer to extend the frequency range of the spectrum analyzer. When this technique is used, the response is not pre-selected and multiple signals are displayed. Each response is examined not only for power level, but whether or not the signal is truly in band by using the spectrum analyzer's signal identification function.

Equipment

Source DriverAny source in Figure 3 of System General Information
Spectrum AnalyzerHP 8566B
Waveguide CouplerHP R752D
Harmonic MixerHP 11970A
RF Cables (3)HP Part No. 5061-5458
Microwave AmplifierHP 11975A
Power MeterHP 436A
Power SensorHP R8486A

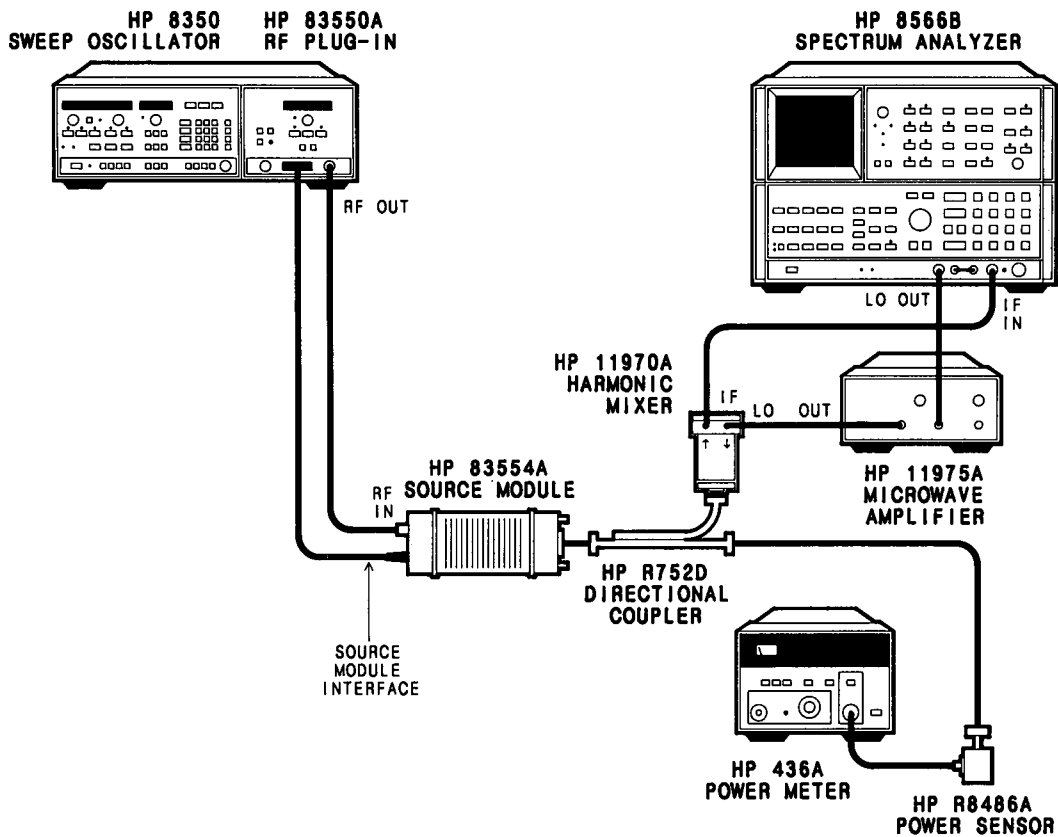

Figure 3-7. Multiplier 3/2 Harmonic Signals Typical Test Setup

Procedure

1. Connect the equipment as shown in Figure 3-7. Turn on all system components.

Multiplier Harmonic Signals

The 3/2 multiplier harmonic signals are determined from the calculation below.

Fundamental Frequencies	Harmonics
$F_2 = 26.5 \text{ to } 27 \text{ GHz}$	$3/2 \times F_2$

2. On the source driver set up a CW frequency of 26.5 GHz. Select the external leveling mode and set the power for +8.0 dBm.
3. Measure the source module output power with the power meter to ensure the power is +8.0 dBm.

4. On the HP 8566B:

Press **[INSTR PRESET]**

Press **[SHIFT] [▲] [▲]** until the **FULL BAND K (A)** annotation appears. This places the analyzer into an external mixing mode allowing R-band frequency range capability. Note the start/stop frequency at the bottom of the screen and ensure that the start frequency is 26.5 GHz and the stop frequency is 40.0 GHz.

Press **[REF LEVEL] [8] [.] [0] [+dBm]**

Press **DISPLAY LINE [ENTER] [2] [2] [-dBm]**, for setting the 30 dBc reference.

Amplitude Calibration of the HP 8566B

The HP 8566B spectrum analyzer can make amplitude calibrated measurements of millimeter-wave frequencies when configured with the HP 11970 mixers. A calibration graph that shows conversion loss and reference level offset is provided with each mixer so that the analyzer can be corrected to that mixer. The following explanation illustrates how this offset is entered into the spectrum analyzer.

In the external mixing mode, the HP 8566B gain is automatically set to 30 dB to compensate for the conversion loss of an external mixer. Using the information from the graph supplied with the mixer, you can offset the reference level to obtain precise amplitude calibration for point by point frequency measurements.

If more general measurements are required, averaging the conversion loss graph on the HP 11970 can be accomplished by averaging the graph's maximum and minimum power points resulting in an overall conversion loss for the entire band. By using this method, an increase of measurement uncertainty is introduced into the test. Reference level offset is determined by the following equation:

$$\text{Conversion Loss} - 30 \text{ dB} = \text{Reference Level Offset}$$

Because the test configuration in Figure 3-7 specifies that the external mixer be connected to the coupled arm of a 20 dB directional coupler, the coupled power must also be taken into account when calculating reference level offset. The new equation is as follows:

$$\text{Conversion Loss} + \text{Coupled Power (20 dB)} - 30 \text{ dB} = \text{Reference Level Offset}$$

For example, if the calibration table on the external mixer indicates a conversion loss of 22 dB for a frequency of 26.5 GHz and a 20 dB directional coupler is used, then the reference level offset is calculated below:

$$\text{Conversion Loss} + \text{Coupled Power (20 dB)} - 30 = \text{Reference Level Offset}$$

$$22 \text{ dB} + 20 \text{ dB} - 30 = +12 \text{ dB}$$

Enter this reference level offset by pressing:

[SHIFT] [REF LEVEL] [1] [2] [+dBm]

Note that the left hand side of the display will read:

CNVLOSS
42.0
dB

5. On the source driver:

Manually tune the source driver frequency from 26.5 to 27.0 GHz while watching for 3/2 harmonic responses (39.75 – 40.5 GHz) that are higher than the display line (< 30 dBc) on the HP 8566B display.

Signal Identification

6. If a multiplier harmonic signal is found, verify whether or not it is a true in band-signal by using the spectrum analyzer's signal identification feature. This is performed as follows:
7. Tune the signal under observation to center screen on the HP 8566B display.
8. Press **[SHIFT] [FREE RUN]**.
9. If the signal is a false response, the annotation **IDENTIFIED OUT OF BAND** will appear on the display.
10. Ensure that all multiplier harmonic signals observed are within the specified level of > 30 dBc.

Measurement Uncertainty

Measurement uncertainty within the test configuration will affect the accuracy of this performance test. To obtain optimum accuracy, amplitude calibrate the spectrum analyzer by entering the conversion loss at each frequency signal under observation as explained under **Amplitude Calibration of the HP 8566B**. Any multiplier harmonic signals that are close to or at 30 dBc should be given an allowable margin of ± 1.5 dB to compensate for all other measurement uncertainties within the test configuration.

HARMONIC SPURIOUS TEST

Specification

See Table 3-1.

Description

The following procedure uses two tone measurement techniques to test the HP 83554A's spurious harmonic response. The test combines two independently controlled sources to simulate the output products of a source that utilizes harmonics to generate output frequencies such as the HP 83590 Series RF plug-in. The two sources used in this performance test that simulate such a source are listed below:

HP 83550A (source #1)

HP 83590 Series (source #2) (except the 83592C)

Source # 1

The purpose of source #1 is to provide a clean, harmonic free, fundamental signal to the input of the HP 83554A under test. Since this source produces a frequency range of 8 to 20 GHz with only a fundamental oscillator, it is free of unwanted sub harmonic products for the 13.25 to 20 GHz frequency range.

Source # 2

The purpose of source # 2 is to produce a controlled 15 dBc or 35 dBc harmonic spurious signal (depending on the spurious signal under test) for any fundamental output frequency of the HP 83550A (source #1). This, in effect, allows the operator to simulate a worst case harmonic signal level to the input of the HP 83554A for any CW fundamental frequency he desires from source #1.

To better understand how the harmonics are created, a basic understanding of a harmonic generated source such as the HP 83590 Series RF plug-in is needed.

RF sources such as the HP 83590 Series produce output frequencies from 2 to 20 GHz in three separate bands. A YIG oscillator is used as the tunable RF frequency source of all bands. The YIG oscillator's fundamental frequency is used in Band 1 (2.0 to 7.0 GHz) and a YIG Tuned Multiplier (YTM) is used to multiply the YIG oscillator frequency for Bands 2 and 3 (7.0 to 13.5 GHz and 13.5 to 20.0 GHz respectively).

This test simulates all the harmonic characteristics associated with the HP 83590 Series RF plug-ins and HP 8349B amplifier. By simulating a worst case harmonic level at the input of the HP 83554A, the output harmonic level of the HP 83554A can be analyzed to ensure it is within the specified level of > 20 dBc. Because the HP 83554A is source driven, its output contains not only its fundamental frequency but also the source driver's harmonic related products as well. The following procedure tests for these responses and explains further how these products are related and in what ways they interact with one another.

The operating input frequencies of the HP 83554A are 13.25 to 20 GHz, so the HP 83590 Series RF plug-in operates within Bands 2 and 3, therefore using the 2nd and 3rd harmonics of the fundamental. The RF plug-in's fundamental frequency (f_0) as well as its multiples ($2f_0$, and $3f_0$) can mix in several ways within the HP 83554A to create in-band spurious harmonic responses.

NOTE: Since this performance test uses two separate sources to simulate the output products of a harmonic generated source such as the HP 83590 Series RF plug-in with the HP 8349B, the following descriptions are designed to explain harmonic generation in terms of an HP 83590 Series RF plug-in as a source driver.

Harmonic Related Spurious Signals

Harmonic related spurious signals are determined from the calculations in Table 3-3 below. The table is split into two frequency ranges, 26.5 to 27.0 GHz and 27.0 to 40.0 GHz. The frequency range split is determined by the band switch points in the HP 83590 Series RF plug-in. Between 26.5 and 27.0 GHz, one probable harmonic of F2 (HP 83554A output frequency) may appear, and between 27.0 and 40.0 GHz, four probable harmonics of F2 may appear.

Table 3-3. Calculated Harmonic Frequencies

Fundamental Frequency	Fundamental Frequency
F2 = 26.5 to 27.0 GHz	F2 = 27.0 to 40.0 GHz
Harmonics	Harmonics
5/4 x F2	4/6 x F2
	5/6 x F2
	7/6 x F2
	8/6 x F2

If the desired CW frequency output of the HP 83554A is within 26.5 to 27.0 GHz, the HP 83590 Series RF plug-in is in band 2. If the desired CW output frequency of the HP 83554A is within 27.0 to 40.0 GHz, the HP 83590 Series RF plug-in is in band 3. With the RF plug-in in band 2, all HP 83554A output frequencies (26.5 to 27.0 GHz) can be accompanied by one possible harmonic related spur within the R-band frequency range, the 5/4 harmonic response. For example, if the output frequency of the HP 83554A is 26.5 GHz, there may be accompanying harmonic spur at 33.125 GHz. This is calculated as follows:

$$5/4 \times (26.5 \text{ GHz}) = 33.125 \text{ GHz}$$

With the RF plug-in in band 3, all HP 83554A output frequencies (27.0 to 40.0 GHz) may be accompanied by four harmonic related spurs, the 4/6, 5/6, 7/6, and 8/6 harmonic responses, three of which may be present within the R-band frequency range at one time. For example, if the output frequency of the HP 83554A is 30.0 GHz, there will be accompanying harmonic spurs at 20.000, 25.000, 35.000, and 40.000 GHz. Since the harmonic spur at 20.000 GHz is below the cutoff for the R-band waveguide, it will not appear at the output of the HP 83554A. The above harmonic spurs were calculated as follows:

$$4/6 \times (30.0 \text{ GHz}) = 20.000 \text{ GHz}$$

$$5/6 \times (30.0 \text{ GHz}) = 25.000 \text{ GHz}$$

$$7/6 \times (30.0 \text{ GHz}) = 35.000 \text{ GHz}$$

$$8/6 \times (30.0 \text{ GHz}) = 40.000 \text{ GHz}$$

Equipment

RF Signal Sources (2)	HP 8350/83550A RF Plug-in HP 8350/83590 Series RF Plug-in (EXCEPT 83592C)
Spectrum Analyzer	HP 8566B
Scalar Network Analyzer	HP 8757A
Microwave Amplifier	HP 8349B
Amplifier	HP 11975A
Harmonic Mixer	HP 11970A
Waveguide Coupler	HP R752D
Dual Directional Coupler	HP 11692D
Waveguide Load	HP R914B
Power Splitter	HP 11667B
Isolator	HP Part No. 0955-0265
3 dB Attenuator	HP 33340C Option 003
Detectors (2)	HP 85025B

Procedure

The following procedure will test the HP 83554A for harmonic response. Source # 1 will be tuned to produce a source module output of 26.5 to 40.0 GHz. For each HP 83554A output CW frequency point, a harmonic calculation will have to be made to determine where the harmonic frequency response is located.

For example:

If the desired source module CW output frequency is between 27 GHz and 40 GHz, we know the following:

- a. The HP 83590 Series RF plug-in is in band 3 using the third harmonic of the fundamental frequency.
- b. If the source module output frequency is 30 GHz, then the input frequency is 15 GHz. Therefore, the YIG fundamental frequency (f_0) is 5 GHz, $2f_0$ is 10 GHz, and $4f_0$ is 20 GHz.
- c. Because of mixing action within the HP 83554A, three unwanted signals are present and will produce the four spurious signals listed in Table 3-3.
- d. Source #2 is used to simulate these unwanted subharmonics of the HP 83590 Series one at a time. Source #2 must be tuned to f_0 (5 GHz) first, then check all in-band harmonics listed in Table 3-3. Similarly, source #2 must be retuned to $2f_0$ (10 GHz) and $4f_0$ (20 GHz) and all in-band harmonics listed in Table 3-3 must be checked again.
- e. When the frequency output of the HP 83554A is between 26.5 and 27.0 GHz, the HP 83590 Series RF plug-in is in band 2. Therefore, source #2 must be tuned to f_0 , $3f_0$, and all in-band harmonics listed in Table 3-3.
- f. This calculation must be performed for each in-band harmonic at selected CW output frequencies of the HP 83554A between 26.5 to 40.0 GHz.

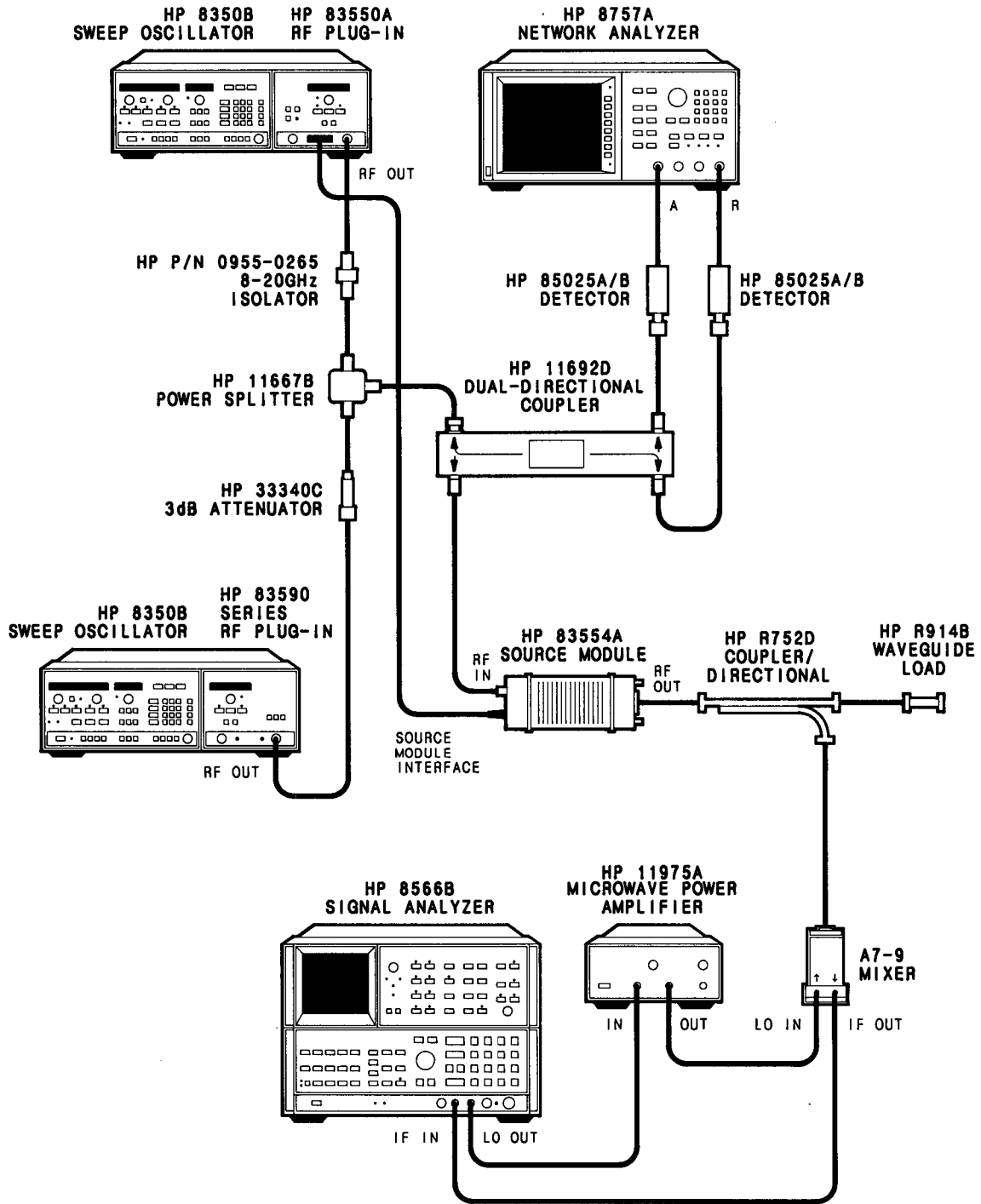

Figure 3-8. Harmonics Spurious Test Setup

1. Connect the equipment as shown in in Figure 3-8.

Turn on all system components except for source #2.

2. Source #1:

On the HP 8350:

Tune the sweeper for a 13.25 GHz CW output signal.

On the HP 83550A:

Tune the RF plug-in for an INT leveled output power of 8.0 dBm on the HP 83550A display.

3. On the HP 8757A:

Normalize the inputs and note the signal level from source #1.

4. Turn source #1 off.

5. Turn source #2 on.

6. On source # 2:

Since the input frequency to the HP 83554A is 13.25 GHz (band 2 of the HP 83590 Series plug-in), the YIG fundamental frequency (f_0) of an HP 83590 Series RF plug-in is 6.625 GHz and $3f_0$ is 19.875 GHz.

On the HP 8350:

Tune the sweeper for an f_0 frequency of 6.625 GHz CW output frequency.

On the RF plug-in:

Press **[POWER LEVEL]**

While observing the HP 8757A display, adjust the power level rotary knob for a power level that is 15 dB less than the power level noted in step 3.

To simulate $3f_0$: repeat step 6 using a power level of 35 dB less than the power level noted in step 3.

7. Turn on source # 1.

8. On the HP 8566B:

Press **[INSTR PRESET]**

Press **[SHIFT] [▲] [▲]** until the **FULL BAND K (A)** annotation appears. This places the analyzer into an external mixing mode allowing R-band frequency range capability. Note the start/stop frequency at the bottom of the screen and ensure that the start frequency is 26.5 GHz and the stop frequency is 40.0 GHz.

Press **[REF LEVEL] [8] [.] [0] [+dBm]**

Press **DISPLAY LINE [ENTER] [1] [2] [-dBm]**

This sets a 20 dBc reference line.

Amplitude Calibration of the HP 8566B

The HP 8566B spectrum analyzer can make amplitude calibrated measurements of millimeter-wave frequencies when configured with the HP 11970 mixers. A calibration graph that shows conversion loss and reference level offset is provided with each mixer so that the analyzer display can be calibrated to that mixer. The following explanation illustrates how this offset is entered into the spectrum analyzer.

In the external mixing mode, the HP 8566B IF gain has been factory adjusted for +30 dB to compensate for the conversion loss of an external mixer. Since the millimeter-wave mixer conversion efficiency is not typically +30 dB, the user must enter a correction factor to amplitude calibrate the display. These correction factors are supplied with each millimeter-wave mixer in the form of a reference level offset graph. Using the information from the graph supplied with the mixer, you can offset the reference level to obtain precise amplitude calibration for point by point frequency measurements.

If more general measurements are required, normalizing the conversion loss graph on the HP 11970 can be accomplished by averaging the graph's maximum and minimum power points $(\text{Max} + \text{Min})/2$ resulting in an overall conversion loss for the entire band. By using this method, an increase of measurement uncertainty is introduced into the test. Reference level offset is determined by the following equation:

$$\text{Conversion Loss} - 30 \text{ dB} = \text{Reference Level Offset}$$

Because the test configuration in Figure 3-8 specifies that the external mixer be connected to the coupled arm of a 20 dB directional coupler, the coupled power must also be taken into account when calculating reference level offset. The new equation will proceed as follows:

$$\text{Conversion Loss} + \text{Coupled Power (20 dB)} - 30 \text{ dB} = \text{Reference Level Offset}$$

For example, if the calibration table on the external mixer indicates a conversion loss of 22 dB for a frequency of 26.5 GHz and a 20 dB directional coupler is used, then the reference level offset is calculated below:

$$\text{Conversion Loss} + \text{Coupled Power (20 dB)} - 30 \text{ dB} = \text{Reference Level Offset}$$

$$22 \text{ dB} + 20 \text{ dB} - 30 \text{ dB} = +12 \text{ dB}$$

Enter this reference level offset by pressing:

[SHIFT] [REF LEVEL] [1] [2] [+dBm]

Note that the left hand side of the display will read:

CNVLOSS
42.0
dB

Measurement Uncertainty

Measurement uncertainty within the test configuration will affect the accuracy of this performance test. To obtain optimum accuracy, amplitude calibrate the spectrum analyzer to the frequency of the signal under observation as explained under **Amplitude Calibration of the HP 8566B**. Any harmonic related spurious signals that are close to or at 20 dBc should be given an allowable margin of ± 1.5 dB to compensate for all other measurement uncertainties within the test configuration.

9. From Table 3-3, the 5/4 harmonic of 26.5 GHz calculates to be 33.125 GHz.

Press [CENTER FREQUENCY] [3] [3] [.] [1] [2] [5] [+ dBm]

Ensure that the harmonic frequency under observation is truly the 5/4 harmonic of 26.5 GHz by using the spectrum analyzer's signal identification function. After verification is made, ensure that the harmonic power level is > 20 dBc from the 26.5 GHz fundamental.

10. On source # 2:

The previous step verified that the 5/4 harmonic resulting from the mixing action between 26.5 and fo was within the specified levels.

When output = 26.5 to 27 GHz: Check fo, 3fo
(subharmonic fo should be set to 15 dBc, and 3fo should be set to 35 dBc)

When output = 27 to 40 GHz: Check fo, 2fo, 4fo.
(subharmonics fo and 2fo should be set to 15 dBc, and 4fo should be set to 35 dBc)

11. For the remaining frequencies between 26.5 and 40.0 GHz, repeat steps 2 through 7, and steps 9 through 11, while addressing the proper harmonic response. Ensure that when between 27.0 and 40.0 GHz, the 4/6, 5/6, 7/6, and 8/6 harmonics are checked by tuning source #2 to fo, 2fo, and 4fo.

Synopsis

The foregoing procedure can be recapped as follows:

For all frequencies between 26.5 to 40 GHz, the following steps must be performed:

1. When the HP 83554A's output frequency is 26.5 to 27.0 GHz, the 5/4 harmonic response must be checked by tuning source #2 to fo and 3fo.
2. When the HP 83554A's output frequency is 27.0 to 40.0 GHz, the 4/6, 5/6, 7/6, and the 8/6 harmonic responses must be checked by tuning source # 2 to fo, 2fo, and 4fo.
3. For each harmonic response, source # 2 must be tuned for fo, 2fo, 3fo, and/or 4fo of the HP 83590 Series RF plug-in to ensure that the resultant harmonic under observation doesn't exceed specifications.

Table 3-4. Performance Test Record

HP 83554A Millimeter-Wave Source Module Serial Number _____ Date _____ Humidity* _____ Tested By _____ *(Optional) _____ Temperature* _____				
Specification Tested Limits	Test Conditions	Lower Limit	Measured Value	Upper Limit
Maximum Leveled Power				
26.5 to 37.2 GHz	_____	+8.0 dBm	_____	
37.2 to 40.0 GHz	_____	+7.0 dBm	_____	
Power Level Flatness²				
26.5 to 37.2 GHz	_____	+8.0 dBm	_____	+11.0 dBm
37.2 to 40.0 GHz	_____	+7.0 dBm	_____	+10.0 dBm
Power Level Accuracy¹				
Displayed Power +7 dBm	_____	≥ +5.00 dBm	_____	≤ +9.00 dBm
Displayed Power +4 dBm	_____	≥ +2.00 dBm	_____	≤ +6.00 dBm
Displayed Power +1 dBm	_____	≥ -1.00 dBm	_____	≤ +3.00 dBm
Displayed Power -2 dBm	_____	≥ -4.00 dBm	_____	≤ 0.00 dBm
Displayed Power -5 dBm	_____	≥ -7.00 dBm	_____	< -3.00 dBm
Output SWR	_____		_____	≤ 2.0
Multiplier Harmonic Test				
26.5 to 27 GHz	_____	≥ 30 dBc	_____	
Harmonic Spurious Test³				
26.5 to 40 GHz	_____	> 20 dBc ³	_____	

1. HP 8673 only; when remotely programmed; when power is referenced to front panel add ± 0.75 dB.
2. Must have 0.5 V/GHz modification.
3. With the exception of the HP 83592C, HP 83550A, and HP 8673C/D which is > 30 dBc.

SERVICE

INTRODUCTION

This section provides instructions for troubleshooting and repairing the HP 83554A. It begins with an overall description of field service options available from Hewlett-Packard and theory of operation. Following this is troubleshooting, a block diagram, and a list of replaceable parts with detailed instructions for ordering parts.

The HP 83554A mm-wave source module is field service depot repairable to the RF microcircuit or printed circuit assembly level. Since the two RF assemblies have bias board assemblies that are not separately replaceable due to static protection requirements, the repair level is only to the major assembly. Replaceable parts and assemblies are listed in Figures 3-11 through 3-15.

For your convenience, blue repair tags are provided for source modules being returned to Hewlett-Packard for repair. These tags are located at the end of the Systems General Information section.

SAFETY CONSIDERATIONS

The voltages present in the HP 83554A are not in the range to warrant more than normal caution, but troubleshooting and repair should be performed only by qualified personnel.



SUSCEPTIBLE TO DAMAGE FROM STATIC DISCHARGE

The best method of preventing ESD is for the technician to wear a grounding strap connected to a conductive bench mat that provides a path to ground of between 1 and 2.5 Megohms.

SERVICE PROCEDURE

The mm-wave source modules may be sent to any Hewlett-Packard service or sales office for transfer to a field service depot for repair and/or calibration.

ADJUSTMENTS

The HP 83554A has NO ADJUSTMENTS that can be performed after replacement of any defective assembly or printed circuit board. There are adjustment potentiometers on the printed circuit board and microcircuit bias assemblies that are for FACTORY adjustment only. Therefore, no adjustment procedures are given. The replacement assemblies are adjusted and tested prior to shipment from the factory and provide enough margin for instrument specifications to be met after replacement.

After replacement of any assembly, all performance tests (operational verification level) should be performed to ensure instrument specifications are met. If specifications are not met, we recommend return of the source module to the nearest field depot service center for adjustment/repair/calibration.

THEORY OF OPERATION

Introduction

The HP 83554A source module, configured with an applicable RF source driver covers the R-band frequency range of 26.5 to 40.0 GHz with up to +8 dBm of leveled output power (+7dBm between 37.2 and 40.0 GHz). In addition to system leveling (source module internal coupler/detector), external detectors or power meters can be used to level the RF power.

The HP 83554A source module is divided into three major electrical assemblies (refer to the source module block diagram and associated mechanical hardware).

- A2 Amplifier/Bias Assembly
- A4 Multiplier/Bias Assembly
- A5 Interface Assembly

The HP 83554A power supplies, bias control, and digital control signals are provided by the RF source driver and routed through the source module interface cable (W1). Since the HP 83554A source module does not have a motherboard for interconnections, signals are routed through the instrument by ribbon cables between the interface, multiplier, and amplifier assemblies.

A block level description of the three major assemblies is given below. Descriptions of the RF section (amplifier and multiplier assemblies) are followed by a description of the interface assembly. Subsections of each major assembly will be described for familiarization and troubleshooting purposes. (Refer to the source module block diagram, Figure 3-9).

Amplifier/Bias Assembly

An RF signal from a source driver is applied to the HP 83554A source module through an external cable and the Type-N input connector J1. The signal enters the amplifier assembly through an RF cable and is passed through a tuned varactor filter to eliminate unwanted RF source driver subharmonics that may accompany the desired fundamental frequency.

The varactor filter tracks the fundamental frequency since the RF input signal can be swept. Tracking is accomplished by the filter control circuitry located on the amplifier bias board assembly. The filter is biased from an exponential amplifier driven by a bias control signal, -VTUNE. The signal -VTUNE is a linear ramp voltage from 0.0 to -10.0 volts and is derived from the 0.5V/GHz frequency reference signal provided by the RF source driver. The circuitry for -VTUNE generation is located on the interface assembly.

After filtering, the RF signal is split into two separate paths and coupled to the first stage of amplification. The first stage FET amplifier pair are biased at approximately 4.75 volts through a emitter follower circuit on the bias board assembly. Bias voltage protection is provided by a zener diode at a +5.1 VDC level to ensure device protection. The first stage bias circuit regulates the +8 VDC amplifier drain bias supply to 4.75 volts. The first stage bias circuit also uses the L RF OFF control signal to turn off the input amplifiers when RF power is turned off. This provides a good on/off ratio in low frequency pulse modulation applications.

After being coupled through a DC block, the RF signal passes through two more stages of amplification and a notch filter. The second and third stage amplifier pairs are biased with the +8 VDC supply. After the third stage of amplification, the two RF paths are combined and coupled to a bias tee. The bias tee output is coupled from the amplifier assembly to the multiplier assembly through an RF cable (W4).

Multiplier/Bias Assembly

The RF signal from the amplifier assembly is coupled to the multiplier stage where doubling of the frequency takes place. The signal is doubled by two matched pairs of diodes which distort the input signal. Upon distortion, various output signals are generated as harmonics of the original input signal.

The diode bias section, located on the multiplier bias assembly, contains an emitter follower circuit for diode bias voltage regulation and current drive for the diodes. The normal RF ON bias voltage for the diodes is approximately +3.75 VDC. Similar to the amplifier's first stage bias control, the RF OFF control signal is used to improve output signal ON/OFF ratio. Although, in this application, the diodes are reverse biased (approximately -10 VDC) to turn them off. Therefore, in pulsed applications, both the amplifier and multiplier assemblies contain control circuitry to enhance the ON/OFF ratio.

The second section of the multiplier diode circuitry is the self bias section in the multiplier itself. A self bias device (capacitor) is used to improve the multiplier diodes response over different input power levels. The self bias voltage is always a reverse bias and is adjustable, thus a fixed forward bias is used at low RF input levels and a varying (self bias) negative voltage is used to compensate over the input power range. Overall, at low power levels a forward bias is applied and as power increases, a reverse bias is applied, linearizing the multiplier diodes efficiency.

After harmonic generation (multiplication), the RF signal is coupled through a FINLINE-waveguide conversion section. The output waveguide acts as a high pass filter with a lower cutoff frequency of approximately 21 GHz.

For leveled output power across the frequency sweep, an internal directional coupler directs a portion of the RF signal to a detector. The detector produces a voltage proportional to the sampled RF signal. The multiplier bias board also contains circuitry to buffer the detector output before it is applied to the log amplifier on the interface board.

Interface Assembly

The interface assembly contains two major sections, analog and digital control. Within the analog section the dual slope log amplifier receives the buffered detector voltage as the MOD DET signal. The log amplifier converts the detector output into a linear DC signal and applies the signal to a high impedance amplifier as control signal EXT LEV. Since the detector does not have the same response over the entire frequency range, detector flatness compensation is summed in with the log amplifier output prior to the last output buffer. The logged and compensated EXT LEV signal is routed to the center coaxial pin on the source module interface cable for routing to the EXT ALC input of the source driver. Both the flatness compensation and -VTUNE circuitry are referenced to the 0.5V/GHz frequency reference provided by the source driver.

The digital control section contains digital address and data line buffers, decoding and counting circuitry. The NOVRAM (non volatile, random access memory), a RAM-ROM (random access memory-read only memory) combination device, contains digital information (frequency, power and ALC information) when used with the HP 83550A RF plug-in.

Power Supplies and Grounds

Power supplies for source module operation are provided by the source driver and routed through the source module interface cable assembly. Power supplies are connected to the interface assembly and used by all three major assemblies. However, the HP 83554A has two + 10 VDC regulated power supplies, independent of each other, that are developed within the source module from the +15 VDC supplies. The +10 VDC supplies are used for local analog application where regulation and current control are critical. The +5 VDC is used only for the interface assembly digital circuitry.

Corresponding to the three independent power supplies, are three independent ground potentials that are used in the source module. The digital and analog grounds are separate to prevent noise problems. Two analog grounds are separate and used in conjunction with the two independent +10VDC supplies for the interface and amplifier/multiplier assemblies.

Disassembly Procedure



SUSCEPTIBLE TO DAMAGE FROM STATIC DISCHARGE.

Cover Removal Procedure

1. Hold the stand down on a table top with one hand while using the other to lift the source module straight up to remove from the cradle.
2. Remove the two bumpers that are around the source module.
3. With an Allen wrench, remove the top two screws on the cover.
4. If both covers need to be removed, use the Allen wrench to remove the remaining screws on the bottom cover.

Rigid Cable Removal

If you must loosen or remove one of the rigid RF cables, be very careful not to bend it. Bending one of these cables can change its electrical characteristics.

TROUBLESHOOTING

Introduction

This section contains procedures for troubleshooting the HP 83554A mm-wave source module. There are procedures described for isolating problems with power supplies, RF power/harmonic failures, analog interface, and digital interface, along with several operational checks.

Troubleshooting the HP 83554A source module is done to the RF assembly or printed circuit board level. The A2 Amplifier assembly (with attached bias board) and A4 multiplier assembly (with attached bias board) are the two major RF microcircuit assemblies. The A5 interface assembly is the only separately replaceable printed circuit board.

Before troubleshooting the source module independently, ensure that the failure of system specifications (various source system configurations) is caused by the source module. System operator's checks and system troubleshooting procedures are outlined in all Source System Guides. Determination of the specific failed system instrument is necessary prior to individual instrument troubleshooting.

Troubleshooting the source module begins by conducting the performance tests. If a problem exists, follow the procedure outlined below.

Refer to the theory of operation and block diagram for reference throughout the troubleshooting procedures.

Operational Checks

Several system operational problems may be encountered if attention is not paid to the system instruments setup (cabling, etc.). A few checks for locating operation problems in a source system configuration which includes an HP 8349B follows:

1. If the source module output power, as indicated on a power meter, is approximately 3 dB higher than the HP 8349B output display level, the most likely cause is that the 0.5V/GHz connection is not present.

The 0.5V/GHz signal supplies the varactor filter tracking and flatness compensation circuitry with a frequency reference that affects the source module output power and flatness characteristics. Refer to the source module A4 multiplier and A5 interface assemblies theory of operation for a detailed description.

2. If the system has leveling or RF power problems, the RF input cable (W2) may be the cause of this problem. The RF cable is typically specified over the frequency range of 8 to 20 GHz with a 2 to 3 dB loss. Characterization of the cable with a network analyzer may be necessary to eliminate it from any system problems encountered. If the cable has large power drops, or measures significantly different from the typical value, it should be replaced.

3. The source module input SWR should be checked in case of ALC leveling problems. A source module input connector or cable failure could lead to leveling problems. If the input SWR is appreciably larger than the typical value of 7:1, the source module should be returned for repair.

Caution Notes

The CAUTION sign denotes a possible hazard to the instrument. Do not proceed beyond a CAUTION sign until the indicated conditions are fully understood and met.



Maintenance described in this section is performed with power supplied to the instrument with the protective covers removed. Such maintenance should be performed only by service-trained personnel who are aware of the hazards involved. Where maintenance can be accomplished without power applied to the instrument, the power should be removed. When you have completed a repair, make sure all safety features are intact and functioning, and that all protective grounds are connected.

Recommended Test Equipment

The necessary equipment needed to test and maintain the source module is listed in Table 3-2 of this section, and in Figure 3 of System General Information. If the equipment listed is not available, equipment which meets the critical specifications may be used.

Equipment Setup

The troubleshooting test equipment setup is the same for all procedures (fault location). This setup is configured into a "typical" system configuration. As an example, the following is a list of equipment needed to configure an HP 8350/83590 Series/83554A millimeter-wave system (refer to applicable Source System Guide).

HP 8350Sweep Oscillator
HP 83590 Series RF Plug-In
HP 8349B Amplifier
HP 83554A Source Module

1. Connect the equipment in a system configuration (refer to the correct Source System Guide for your equipment) and power on all instruments.
2. The majority of the troubleshooting procedures are done with the source system in the system leveled mode (leveled source module output power) at maximum leveled output power. Exceptions are indicated and care should be taken to ensure proper system setup for valid measurements.

Troubleshooting procedures are done at a CW frequency of 30 GHz (15 GHz source driver output) except where noted.

ISOLATION PROCEDURES

Power Supplies

The power supplies for the source module are provided by the source driver through the source module interface cable. Ensure that all power supplies are within the indicated ranges shown below in Table 3-5.

Table 3-5. Typical Ranges of Power Supplies

+5 V	(A5TP12) – GND (A5TP1)	+5.00 VDC \pm 200 mV
+8 V	(A1TP7) – GND (A1TP8)	+8.00 VDC \pm 250 mV
+10 VA	(A5TP5) – GND (A5TP1)	+10.00 VDC \pm 10 mV
–10 VA	(A5TP6) – GND (A5TP1)	–10.00 VDC \pm 10 mV
+10 VB	(A3TP5) – GND (A3TP8)	+10.00 VDC \pm 10 mV
–10 VB	(A3TP4) – GND (A3TP8)	–10.00 VDC \pm 10 mV

RF Power/Harmonics

Source module failures are normally RF power or harmonic related. Analog and digital interface problems may arise and will be traceable to the A5 interface assembly or the source module interface cable (W2). The following sections will describe the procedures and measurement points to troubleshoot these areas.

The two major RF assemblies in the source module are the A2 amplifier and A4 multiplier. RF power or harmonic problems are normally isolated to one or both of these major assemblies.



When working inside the source module, be very careful not to touch any of the exposed pins coming from the microcircuit. The microcircuits are extremely static sensitive, and may be damaged or destroyed by charges typically carried during everyday activities.

When working near the microcircuit, always wear a static ground strap. Before handling a microcircuit, discharge your own body by touching the instrument chassis or microcircuit package. Avoid touching the center conductors of the RF connectors and bias feed-throughs at all times.

Microcircuits should be stored and transported in static-protective packaging. Never package microcircuits with Styrofoam, cellophane (unless treated for static), or adhesive tape.

No Output Power (or low output power)

Disconnect the source module from the system. Adjust the source driver RF output until the HP 8349B output display reads 15 dBm. Check the output of the detachable RF cable (W2) with a power meter to ensure a source module input power of 15 dBm.

NOTE: It may be necessary to place a 10 dB attenuator between the source driver and the HP 8349B to allow +15 dBm output.

To check the A2 amplifier output level (A4 multiplier input), disassemble the source module and remove the RF cable (W4) between the amplifier and multiplier assemblies. (Refer to the Disassembly Procedure located at the end of Theory of Operation in this section).

NOTE: It will be necessary to place a 10 dB attenuator between the A2 amplifier assembly and the power sensor (maximum input of 20 dBm). The measured power at the output of the A2 amplifier must be increased by the amount of attenuation. The A2 amplifier assembly typically has a gain of 9 to 10 dB.

A2 Amplifier Input (J1)	15.0 dBm ± 0.5 dBm
A2 Amplifier Output (W4)	24.0 dBm ± 2.0 dBm
A4 Multiplier Output (J2)	14.0 dBm *

* Output level may be saturated at high input levels, thus no tolerance levels are indicated (approximate values).

If the measured power levels are lower than those indicated, replace the faulty assembly and perform the applicable performance tests (refer to Performance Tests section).

Harmonic Failures

Two of the performance tests (Multiplier Harmonic and Harmonics Spurious Tests) will determine whether any harmonic failure is source module generated (multiplier) or source driver generated (fractional).

- a. Multiplier Harmonic Test (Multiplier Harmonics)
- b. Harmonics Spurious Test (Fractional Harmonics)

If the instrument fails the Multiplier Harmonic Test, replace the A4 multiplier assembly and perform the applicable performance tests (refer to Performance Tests section).

If the instrument fails the Harmonics Spurious Test, replace the A2 amplifier assembly and perform the applicable performance tests (refer to Performance Tests section).

Analog Interface

The troubleshooting procedure for interface problems are performed with the same system configuration as RF power or harmonics problems procedures. Although, the measurements should be done with the source system in its system leveled mode over a power range of +7.0 dBm to -5.0 dBm.

ALC (automatic leveling control)

The ALC circuitry is located on the A4 multiplier assembly (coupler and detector), A3 multiplier bias assembly (buffer), and the A5 interface assembly (dual slope log amplifier and output buffer).

The detector output voltage and buffered detector output (INT DET), can be measured on the A3 multiplier bias assembly. The following are typical voltage measurements for these two signals over differing power levels and are evidence of a functional A4 multiplier assembly.



SUSCEPTIBLE TO DAMAGE FROM STATIC DISCHARGE

DVM ground connection at A3TP8. The minimum and maximum allowable levels are as follows:

DETECTOR (−6.0 mV to −150 mV)

INT LEV (−30.0 mV to −750 mV)

LEVEL (dBm)	DETECTOR (A3TP6) (mV)	INT DET (A3TP3) (mV)
+7.0	−120	−600
+5.0	−85	−425
+3.0	−60	−300
+1.0	−40	−200
−1.0	−27	−136
−3.0	−18	−91
−5.0	−10	−50

If the measured signals are not within the indicated ranges, replace the A4 multiplier assembly and perform the applicable performance tests (refer to Performance Tests section).

If the A4 multiplier output voltages are correct, the following A5 interface assembly output signals should be checked. The following are typical voltage measurements and are indicative of an operational A5 interface assembly.



SUSCEPTIBLE TO DAMAGE FROM STATIC DISCHARGE

DVM ground connection at A5TP1. The EXT LEV signal is a linear signal at 60 mV/dB with a typical value of 0.00V at 0 dBm. The tolerance of the EXT LEV measurements is ± 75 mV which correlates to source module output flatness specification of ± 1.25 dBm.

LEVEL (dBm)	INT DET (A5TP7) (mV)	EXT LEV (A5TP3) (mV)
+7.0	Same as previous test INT DET levels (A3TP3)	+370
+5.0		+250
+3.0		+130
+1.0	If signals are absent check ribbon cable connection at A5P2	+10
−1.0		−110
−3.0		−230
−5.0		−350

If the measured signals are not within the indicated ranges, replace the A5 interface assembly and perform the applicable performance tests (refer to Performance Tests section).

Frequency Compensation

Frequency compensation is related to the swept frequency input from the source driver, thus measurements must be taken at differing CW frequencies (covering the entire R-band frequency range). These measurements are taken with the source system in its system leveled mode at an RF output of +7.0 dBm.

The frequency reference from the source driver (0.5V/GHz) is input to the A5 interface assembly and is used by two circuits: –VTUNE generation and the flatness compensation circuitry. The following are typical voltage measurements for –VTUNE and the flatness compensation circuits and are indicative of an operational A5 assembly.

DVM ground connection at A5TP1. The –VTUNE signal is a linear negative ramp from 0.00V to –10.00V which correlates to the 26.5 to 40.0 GHz R-band frequency range. The signal should vary at an approximate rate of 740 mV/GHz \pm 50 mV, there also may be an offset of approximately 200 to 300 mV to compensate for multiplier diode bias.

The flatness compensation measurements will vary between 0.00V and –10.00V (typically a maximum of –5.00V) and should never go positive. No tolerances are indicated since each source module will have different measurements. The following are typical levels measured in an operational source module.

FREQUENCY (GHz)	–VTUNE (A5TP2)(V)	FLATNESS (A5TP4)(V)
27.0	–0.210	–0.250
29.0	–1.152	–1.400
31.0	–2.610	–2.500
33.0	–4.059	–2.552
35.0	–5.530	–2.552
37.0	–6.980	–2.163
39.0	–8.843	–1.500

If the measured signals are not within the indicated ranges, replace the A5 interface assembly and perform the applicable performance tests (refer to Performance Tests section).

Digital Interface

Digital interface failures are limited to the A5 interface assembly or source module interface cable (W2), and are applicable only to the HP 83550A source system configuration. System failures relating to source module digital problems are indicated by HP 83550A error codes. Refer to the HP 83550A Source System Guide and the HP 83550A Operating and Service Manual for detailed descriptions of digital interface error codes.

If the interface error codes indicate a source module failure, replace the A5 interface assembly or source module interface cable (W2), and perform the applicable performance tests (refer to Performance Tests section).

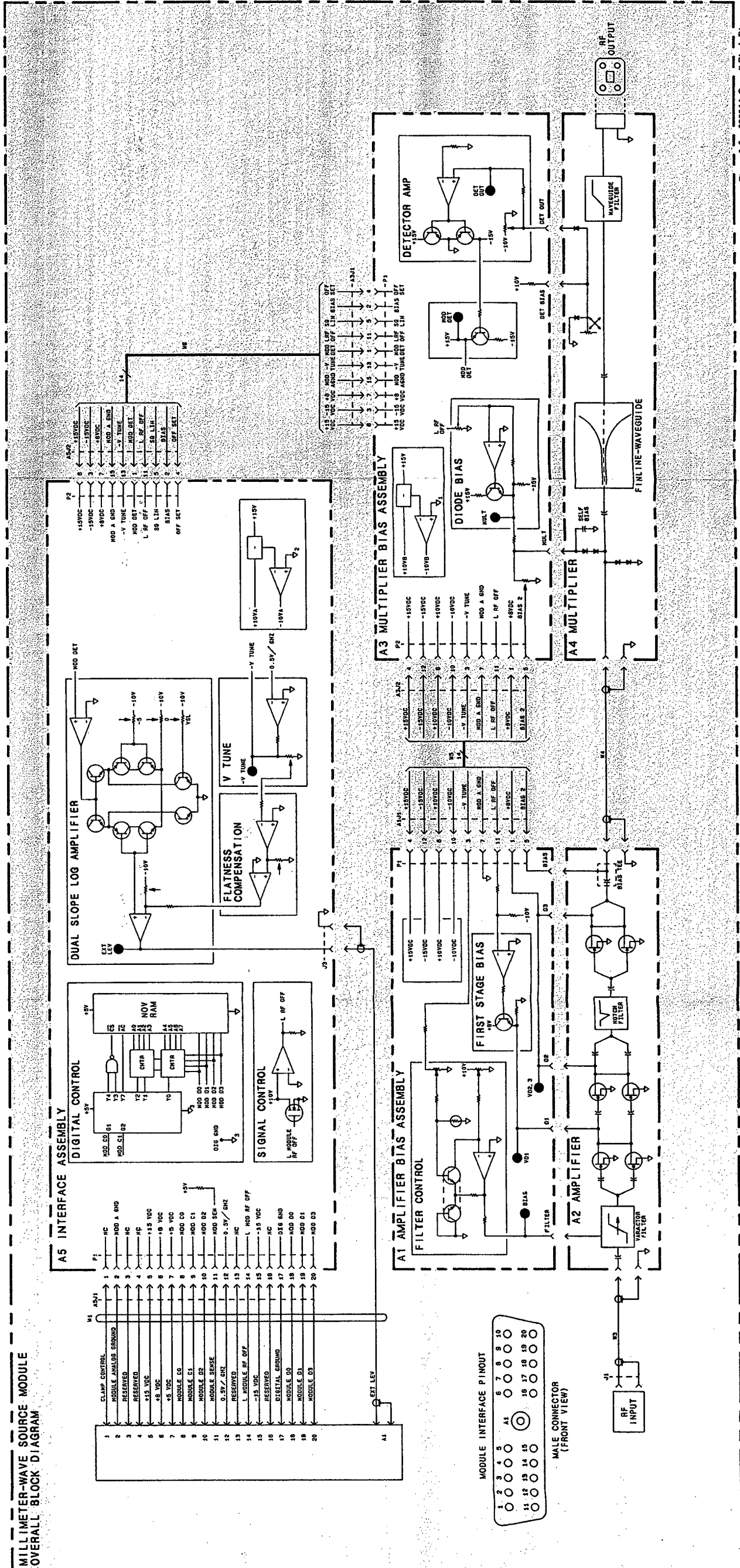

Figure 3-9. 83554A Overall Block Diagram

Specifications and Service

REPLACEABLE PARTS

Introduction

This section contains information for ordering parts. Figures 3-11 through 3-15 list the available assemblies. Table 3-7 lists abbreviations used in the parts list.

Replaceable Parts List

Figures 3-11 through 3-15 provide the locations and lists of replaceable parts.

The information given for each part consists of the following:

- a. The Hewlett-Packard part number.
- b. Part number check digit (CD).
- c. The total quantity (Qty) in the figure.
- d. The description of the part.

Ordering Information

To order a part listed in the Replaceable Parts List, quote the Hewlett-Packard part number with its check digit (CD), indicate the quantity, and address the order to the nearest Hewlett-Packard Office. The check digit will ensure accurate and timely processing of your order.

Table 3-6. Reference Designations, and Abbreviations

Reference Designators			
A	Assembly	Q	Transistor
C	Capacitor	R	Resistor
CR	Diode	S	Switch
J	Electrical Connector (Stationary Portion), Jack	TP	Test Point
L	Coil, Inductor	U	Integrated Circuit, Microcircuit
MP	Miscellaneous Mechanical Part	W	Cable, Transmission Path, Wire
P	Electrical Connector (Movable Portion), Plug	X	Socket

Exchange Program

This instrument may be quickly repaired by replacing a defective assembly with a new or restored-exchange assembly. To support the assembly repair concept, Hewlett-Packard has set up a assembly exchange program.

The procedure for using the assembly exchange program is given in Figure 3-10. When you locate the defective assembly order a replacement assembly through the nearest Hewlett-Packard sales office. The replacement assembly will be sent immediately direct from a customer service replacement parts center. When you receive the assembly, return the defective assembly in the same special carton in which the exchange assembly was received. **DO NOT** return a defective assembly to Hewlett-Packard until you receive the exchange assembly.

If you are not going to return the defective assembly to Hewlett-Packard, or if you are ordering a assembly for spare parts stock, etc., order a new assembly using the new assembly part number listed in Replaceable Parts.

The Hewlett-Packard assembly exchange program allows you to obtain a fully tested and guaranteed restored-exchange assembly at a reduced price. (The reduced price is contingent upon return of the defective assembly to Hewlett-Packard.) Assemblies available for assembly exchange are listed in Replaceable Parts after the new assembly part number.

The module exchange program described here is a fast, efficient, economical method of keeping your Hewlett-Packard instrument in service.

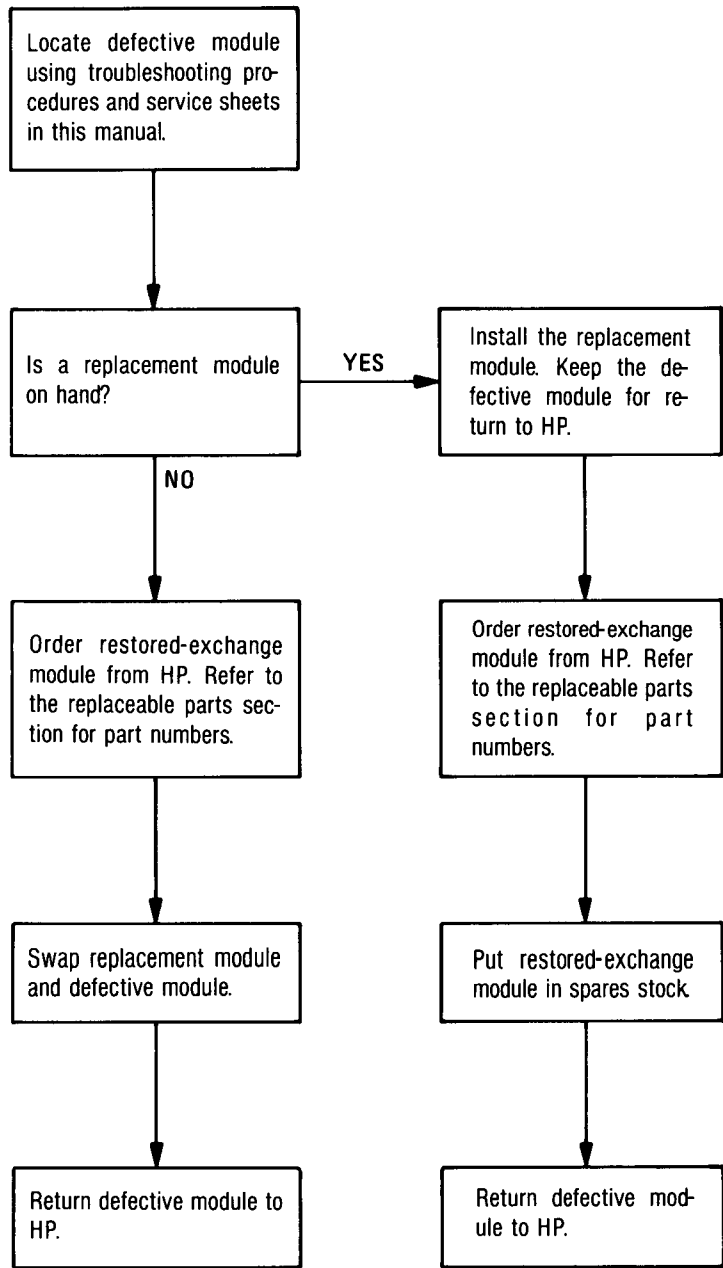

*HP pays postage on boxes mailed in U.S.A.

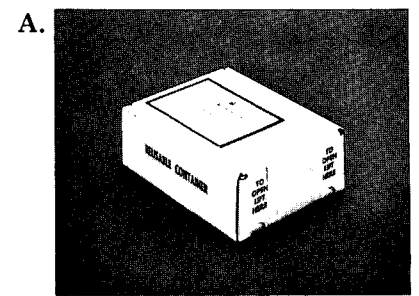

Restored-exchange modules are shipped individually in boxes like this. In addition to the circuit module, the box contains:
Exchange assembly failure report
Return address label

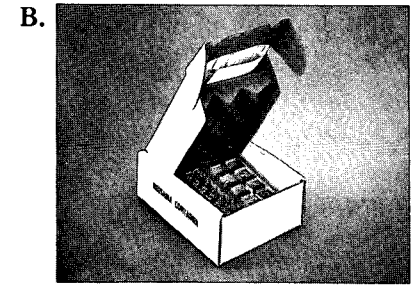

Open box carefully - it will be used to return defective module to HP. Complete failure report. Place it and defective module in box. Be sure to remove enclosed return address label.

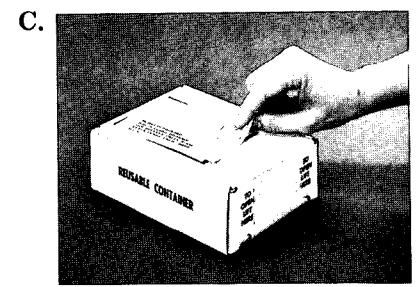

Seal box with tape. Inside U.S.A.*, stick preprinted return address label over label already on box, and return box to HP. Outside U.S.A., do not use address label: instead address box to the nearest HP office.

Figure 3-10. Module Exchange Procedure

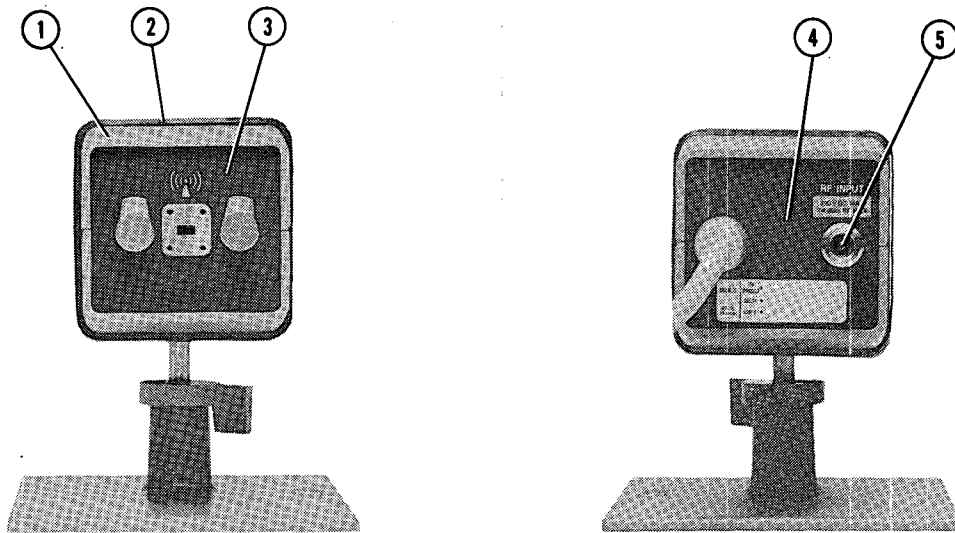

Item	Ref. Desig.	HP Part Number	CD	Qty.	Description
1		83556-20001	4	2	Housing-painted
2		83556-40001	6	2	Bumper 86×86 MM
3		83554-00001	0	1	Panel-Front
4		83556-00002	3	1	Panel-Rear
5	J1	86290-60005	7	1	Connector Assembly Type-N
		2950-0132	6		Nut
		2190-0104	0		Washer
Not Shown		0515-1336	0	6	Exterior Screws 8 mm
Not Shown		83554-80002	9	2	Label in HP Part No. 83554A

Figure 3-11. Front and Rear Views, Parts Identification

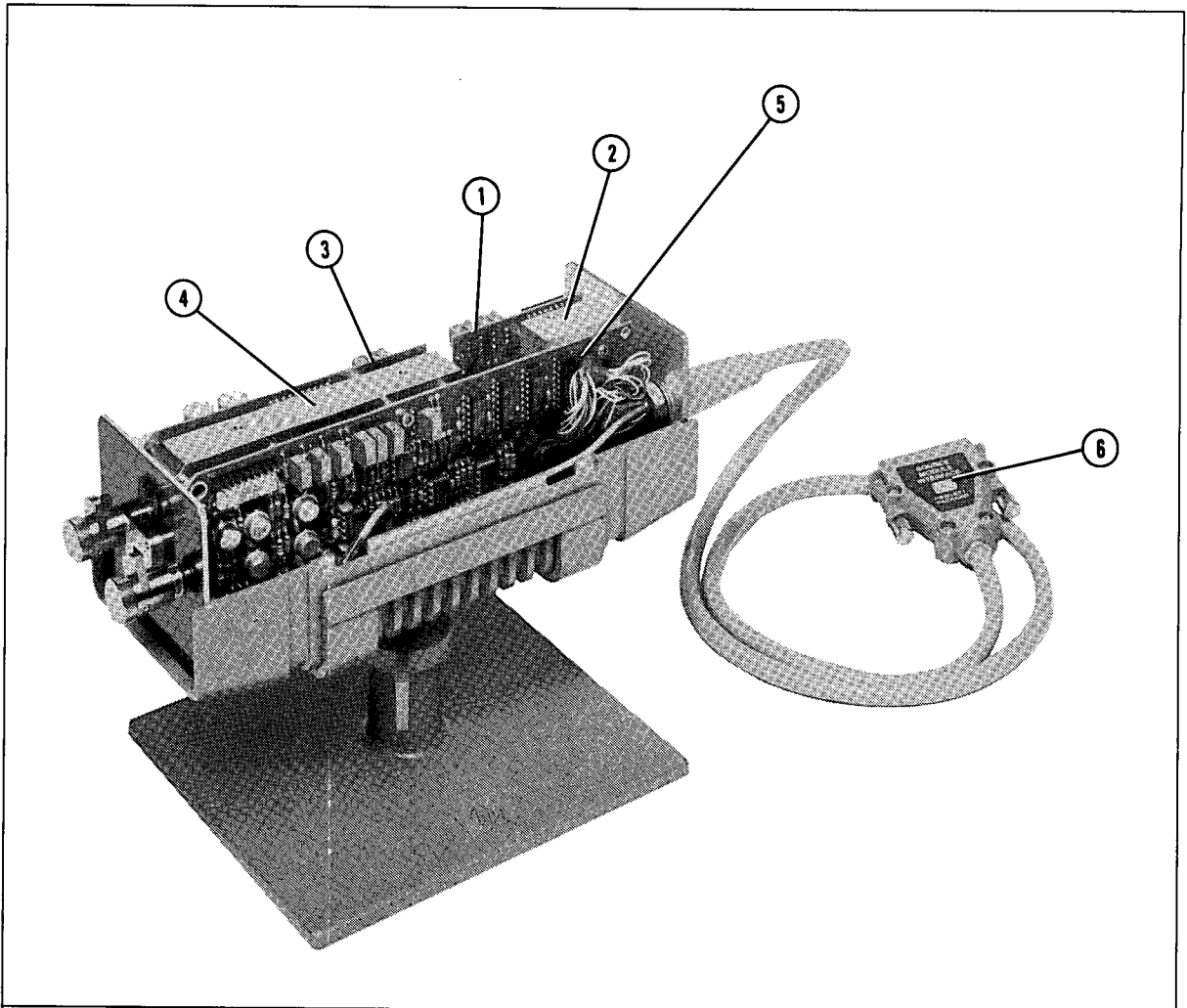

Item	Ref. Desig.	HP Part Number	CD	Qty.	Description
1	A1		0	1	Board Assembly-AMP Bias part of A2 and not separately replaceable
2	A2	83554-60021	0	1	Power Amplifier
3	A3	83554-69021	8		Exchange Amplifier
4	A4	83554-60023	2	1	Board Assembly-Multiplier Bias part of A4 and not separately replaceable
		83554-69023	0		Multiplier
5	A5	83554-60002	7	1	Exchange Multiplier
6	W1	83556-60001	8	1	Board Assembly-Interface
		1390-0431	9	2	Source Mod Interface Cable
		0624-0098	0	4	Captive Screws
		83556-80006	5	1	Screws attached to shell
		0535-0992	3	1	Label-Mod Interface
		2190-0684	1	1	Nut 10 mm
Not Shown	W5	1251-3172	7	1	Washer
Not Shown	W6	1251-3172	7	1	Ribbon Cable AMP/Interface
					Ribbon Cable AMP/Multiplier

Figure 3-12. Top View without Cover, Assemblies and Parts Identification

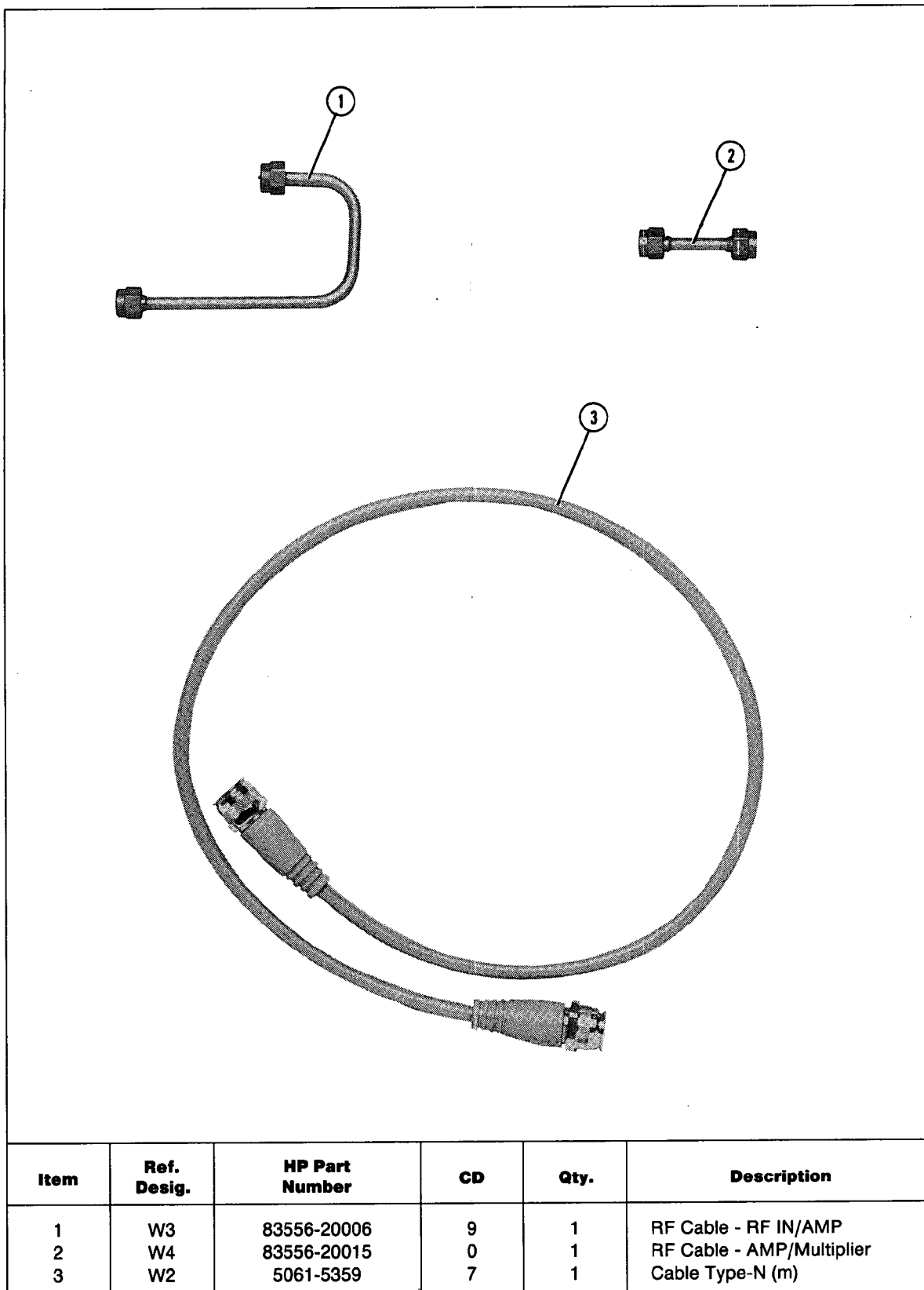

Figure 3-13. RF Cables Identification

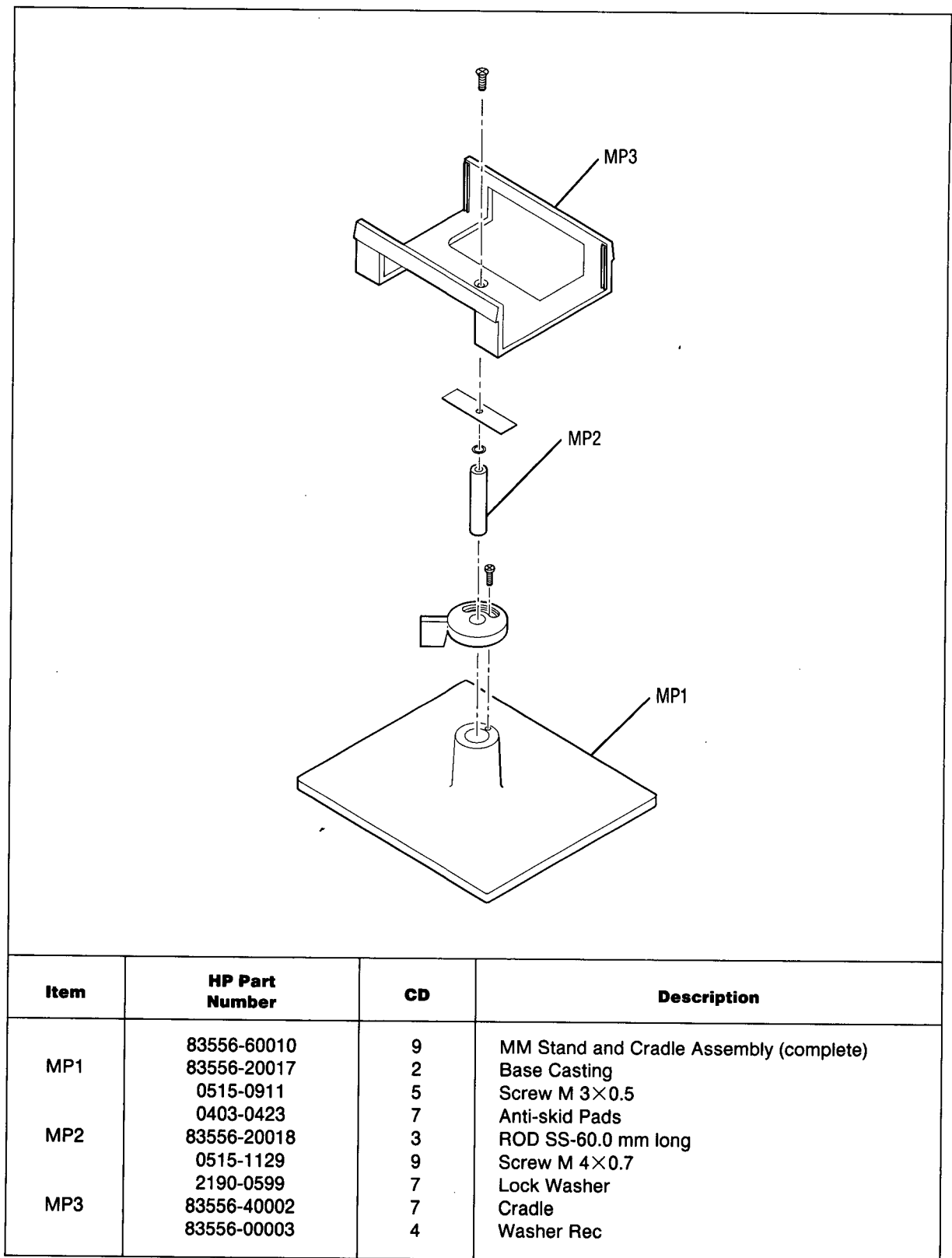
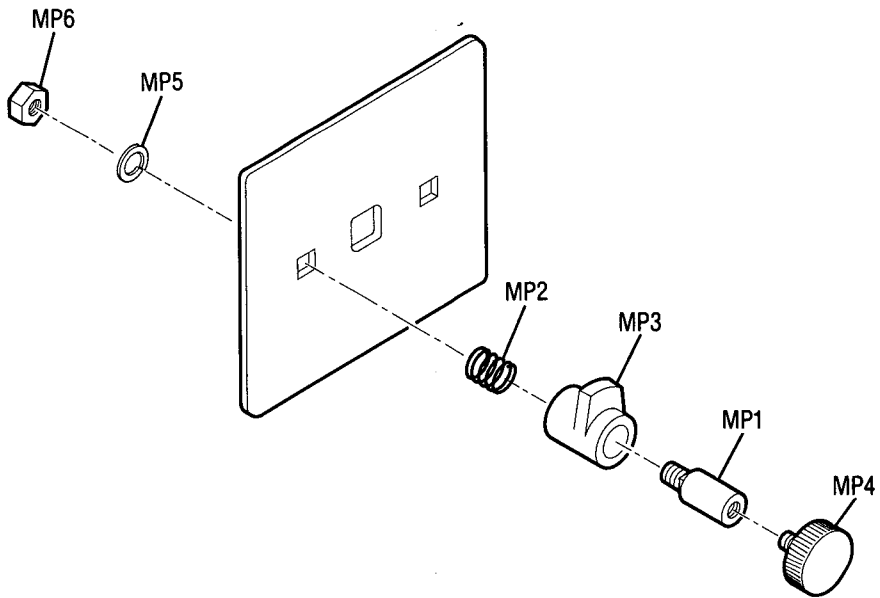

Figure 3-14. Source Module Stand, Exploded View



Item	HP Part Number	CD	Qty.	Description
MP1	83556-20003	6	2	Stud Center
MP2	1460-0019	8	4	Spring CPR
MP3	83556-20002	5	2	Wing Clamp
MP4	83556-20004	7	2	Clamp Screw
MP5	2190-0587	3	2	Lock Washer
MP6	0535-0005	5	—	Nut

Figure 3-15. Waveguide Connection Clamps, Exploded View

REGIONAL SALES AND SUPPORT OFFICES

For information relating to Sales or Support of Hewlett-Packard products first contact your local Hewlett-Packard office listed in the white pages of your telephone directory. If none is listed locally, contact one of the addresses listed below to obtain the address or phone number of the Hewlett-Packard Sales or Support office nearest you.

ASIA

Hewlett-Packard Asia Ltd.
47/F, 26 Harbour Road,
Wanchai, **HONG KONG**
G.P.O. Box 863, Hong Kong
Tel: (852) 5-8330833
Telex: 76793 HPA HX
Cable: HPASIAL TD

AUSTRALASIA

Hewlett-Packard Australia Ltd.
31-41 Joseph Street
BLACKBURN, Victoria 3130
Australia
Tel: (61) 895-2895
Telex: 31-024
Cable: HEWPARD Melbourne

CANADA

Hewlett-Packard (Canada) Ltd.
6877 Goreway Drive
MISSISSAUGA, Ontario L4V 1M8
Tel: (416) 678-9430
Telex: 069-8644

JAPAN

Yokogawa-Hewlett-Packard Ltd.
29-21 Takaido-Higashi, 3 Chome
Suginami-ku **TOKYO** 168
Tel: 03 (331) 6111
Telex: 232-2024 YHPTOK

MEDITERRANEAN AND MIDDLE EAST

Hewlett-Packard S.A.
Mediterranean and Middle East
Operations
Atrina Centre
32 Kifissias Avenue
Paradissos-Amarousion, **ATHENS**
Greece
Tel: (30) 682 88 11
Telex: 21-6588 HPAT GR
Cable: HEWPACKSA Athens

BENELUX & SCANDINAVIA

Hewlett-Packard S.A.
Uilenstede 475
P.O. Box 999
NL-1183 AG AMSTELVEEN
The Netherlands
Tel: (31) 20/43 77 71
Telex: 18 919 hpner nl

SOUTH & EAST EUROPE, AFRICA

Hewlett-Packard S.A.
7, rue du Bois-du-Lan
CH-1217 MEYRIN 2, Geneva
Switzerland
Tel: (41) 22/83 12 12
Telex: 27835 hmea
Cable: HEWPACKSA Geneve

FRANCE

Hewlett-Packard France
Parc d'activités du Bois Briard
2, avenue du Lac
91040 EVRY Cedex
Tel: 1 6/077 83 83
Telex: 6923 15F

GERMAN FEDERAL REPUBLIC

Hewlett-Packard GmbH
Hewlett-Packard-Strasse
Postfach 1641
D-6380 BAD HOMBURG
West Germany
Tel: 06172/400-0
Telex: 410 844 hpbhg

ITALY

Hewlett-Packard Italiana S.p.A.
Via G. Di Vittorio 9
**1-20063 CERNUSCO SUL
NAVIGLIO**
(Milano)
Tel: 02/92 36 91
Telex: 334632

UNITED KINGDOM

Hewlett-Packard Ltd.
King Street Lane
Winnersh, **WOKINGHAM**
Berkshire RG11 5AR
Tel: 734/78 47 74
Telex: 847178

EASTERN USA

Hewlett-Packard Co.
4 Choke Cherry Road
ROCKVILLE, MD 20850
Tel: (301) 670-4300

MIDWESTERN USA

Hewlett-Packard Co.
5201 Tollview Drive
ROLLING MEADOWS, IL 60008
Tel: (312) 255-9800

SOUTHERN USA

Hewlett-Packard Co.
2000 South Park Place
P.O. Box 105005
ATLANTA, GA 30348
Tel: (404) 955-1500

WESTERN USA

Hewlett-Packard Co.
5161 Lankershim Blvd.
P.O. Box 3919
NO. HOLLYWOOD, CA 91609
Tel: (818) 506-3700

OTHER INTERNATIONAL AREAS

Hewlett-Packard Co.
Intercontinental Headquarters
3495 Deer Creek Road
PALO ALTO, CA 94304
Tel: (415) 857-1501
Telex: 034-8300
Cable: HEWPACK



R-band System Manual
HP Part No. 83554-90019

Printed in U.S.A.