

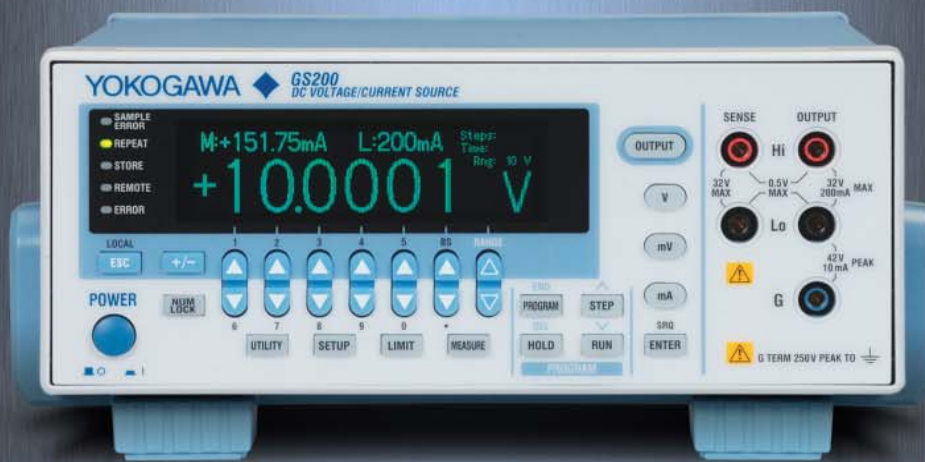

Advanced Test Equipment Rentals
www.atecorp.com 800-404-ATEC (2832)

GS200

DC Voltage / Current Source



- Voltage Source up to 32 Volts
- Current Source up to 200 mA
- Basic Voltage accuracy: 0.016%
- 100 nV, 10 nA Resolution
- GPIB and USB Interface
- Ethernet option
- Measure option

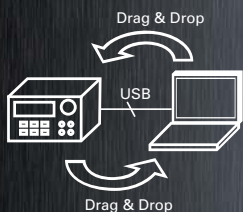

USB STORAGE

For more information, go to
tmi.yokogawa.com
Test & Measurement Instruments



Higher Accuracy— The New Advanced DC Voltage/Current Source

GS200



The GS200 is a DC voltage/current source that boasts high accuracy, high stability, and high resolution. With its excellent traceability, stability, and 5 1/2-digit resolution, the GS200 generates extremely low-noise DC voltage and current signals that are required for many applications. Additionally, the optional monitoring feature turns the GS200 into a voltage and current measuring instrument.

High accuracy
±0.016% standard*

High resolution
5 1/2 digits, ±120,000 display counts

High stability
±0.0008% / °C temperature coefficient*

Low noise
100 μVp-p*

* Standard specifications for 10 V source range



General Specifications

- Voltage source up to ±32 V and current source up to ±200 mA
- 5 1/2-digit, ±120,000-count output resolution
- Voltage and current simple monitoring feature (optional)
- Programmable output up to 10,000 points
- Built-in USB mass storage device
- Channel expansion through synchronous operation

High Accuracy and High Resolution Output

Each DC voltage/current source in the GS200 series uses two DACs to generate highly accurate voltage and current at a high resolution. It is highly stable whether it is used for a short or long period of time and features superb linearity over all the ranges. Moreover, it produces extremely low noise.

- High accuracy:
±0.016% of setting + 240 μV (at 10 V range for one year)
±0.03% of setting + 5 μA (at 100 mA range for one year)
- High stability:
±0.001% of setting 20 μV (at 10 V range for one day)
±0.004% of setting + 3 μA (at 100 mA range for one day)
- High resolution:
100 nV (VDC, 10 mV range)
10 nA (1 mA range)
- Low noise:
100 μVp-p (10 V range, DC to 10 kHz)
3 μAp-p (100 mA range, DC to 10 kHz)

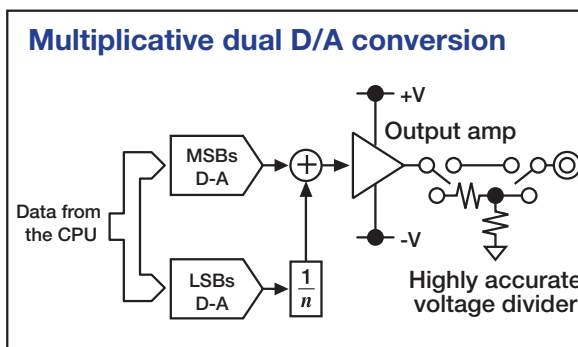

High resolution output with ±120,000 display counts and 100 nV steps minimum

Applicable Fields

Measurement sensors, ICs, consumer electronics, office appliances, communication devices, automotive parts, rechargeable battery control devices, electronic circuits, power supplies, lighting equipment, industrial light sources, small motors, x-ray measuring devices, audio amplifiers, microwave heating equipment, diagnostic imaging equipment, high pressure gas equipment, signal converters, industrial pneumatic equipment, vibration analysis equipment, plant construction, thermal-power and nuclear-power generation facility construction and maintenance, molding and machining, heat treating facilities such as vacuum furnaces and atmosphere furnaces, water quality and atmosphere measuring instruments, tea production lines, etc.

Components and materials

- Pressure sensors
- Temperature sensors
- Organic materials
- Resistors
- Varistors
- ADCs
- VCOs and PLLs
- Small motors

Information and communications

- LED lighting
- Organic ELs
- Mobile phone terminals
- Digital cameras and PDAs
- Power supply circuits and modules
- Optical interface modules

Natural resources and energy

- Rechargeable batteries
- Fuel cells
- Photovoltaics
- Maintenance and inspection
- Nuclear and thermal power generation
- Factories

Source and Sink Operations

Voltage and current source range

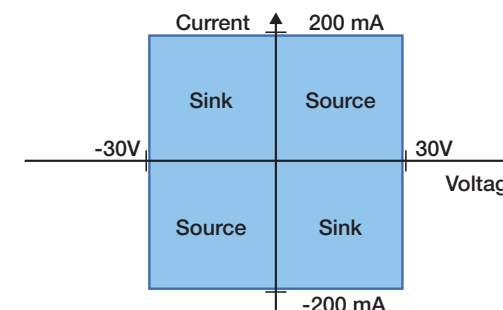

The GS200 can perform four-quadrant operation by operating as a current source or a current sink in the range of ±30 V and ±200 mA.

When the GS200 is sinking current, it can operate over the exact same range as when it is operating as a current source. You can use the GS200 not just as a highly accurate voltage source but also as a highly accurate constant-current electronic load.

- Voltage ranges: 10 mV, 100 mV, 1 V, 10 V, and 30 V
Maximum output current:
±200 mA (at 1 V, 10 V, and 30 V ranges)
(A highly accurate voltage divider is used at the 10 mV and 100 mV ranges.)
Current ranges: 1 mA, 10 mA, 100 mA, and 200 mA
Maximum output voltage: ±30 V

Source operation (highly accurate power supply)

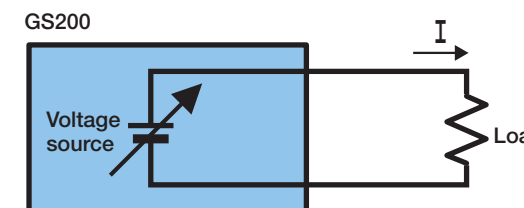

Sink operation (highly accurate load)

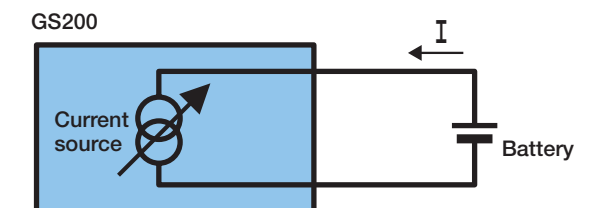

Seamless Bipolar Output

The GS200 bipolar output function inverts the signal polarity without the use of a mechanical contact. Thus, no abnormal voltage (or current) is generated when the polarity is inverted. This achieves truly continuous voltage variation from the maximum negative output to the maximum positive output. This feature is invaluable in the evaluation of zero-crossing comparators and in the output polarity inversion during program operation. Voltage or current glitches do not occur when the setting is changed within the same range.

Comparison of responses when the output polarity is inverted

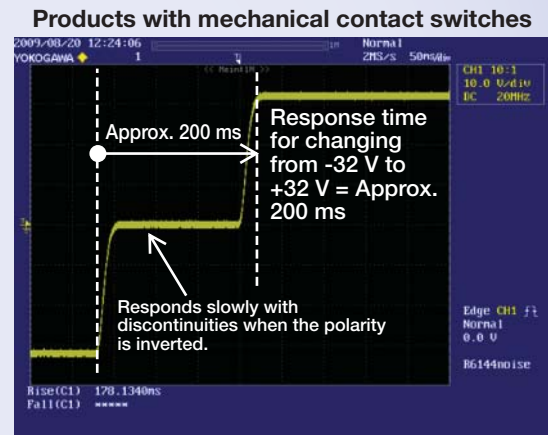
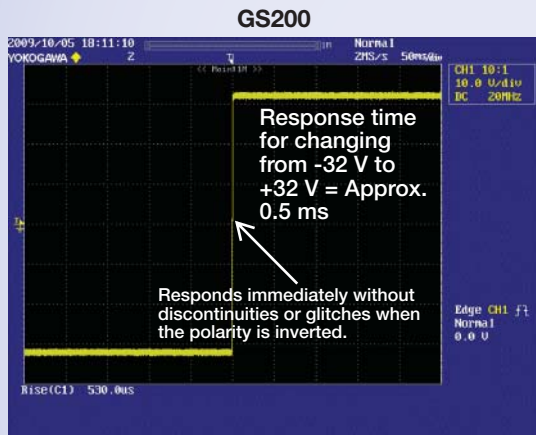

Note) The figures above are for reference only and do not represent the actual product specifications.

Simple Voltage and Current Monitoring Feature (Optional)

In addition to the GS200's high accuracy voltage and current source features, it can also be equipped with an optional simple voltage and current monitoring feature. With this option, the GS200 can function as a current monitor when it is generating voltage and as a voltage monitor when it is generating current. The display resolution is 4 1/2 digits. The measured values can be stored along with the source values in the internal memory (USB mass storage device).

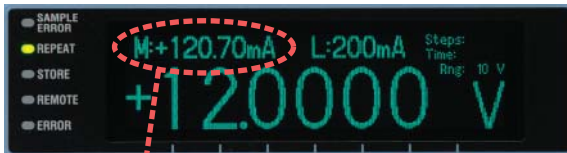

The monitoring feature can be used to:

- Check that current is flowing.
- Check and inspect current consumption.
- Log fluctuations in the load current.
- Record V-I characteristics.

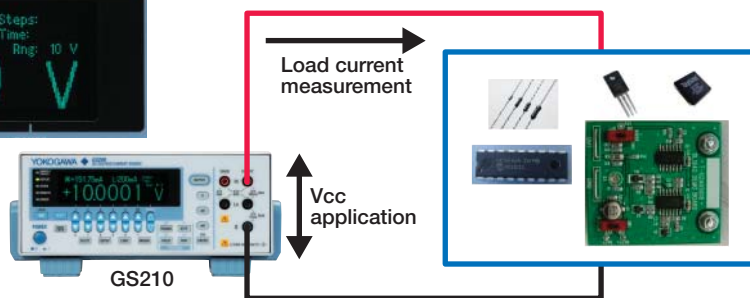

Easy to Use

An up/down key has been provided below each of the 5 1/2 digits for setting the source so that any digit can be readily changed.

Changing the source value is easy, and increment/decrement resolution can also be set freely. This feature is invaluable during threshold level detection of the DUT and during measurements of V-I characteristics. In addition, the GS200's high-resolution dot matrix VFD enables a large amount of information to be displayed. The GS200 also offers freely adjustable font sizes for improved readability and productivity. The GS200 has soft key menus for easy operation.



GS200 display and key layout



Seven segment display on conventional models

Easy Programming Using the USB Mass Storage Feature

You can define up to 10,000 steps of output values and stored these steps to USB memory. You can also set the output interval, settling time, and other settings.

If you connect the GS200 to a PC, the PC will detect the GS200 internal memory as an external storage medium (USB mass storage device). You can easily drag data from the PC to the GS200 internal memory. In addition, you can enter and edit output data using the GS200 keys.

On models with the monitoring option, the measured data is stored to the internal memory along with the output data. You can easily drag the measured data from the GS200 to the PC. You can use the GS200 as a simple V-I curve tracer or data logger.

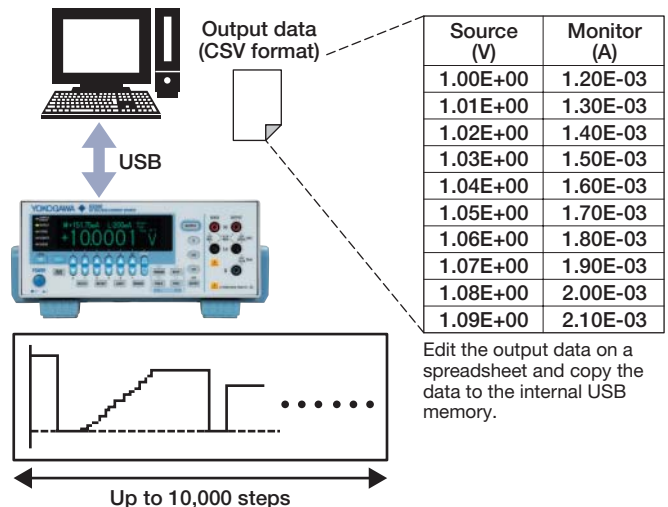

Channel Expansion through Synchronous Operation

By using multiple GS200s in synchronous operation, you can expand the number of channels that are available. It is easy to apply voltages and monitor currents simultaneously on multiple pins. There is no need for synchronous control circuits or complicated wiring. The source and monitored values are saved in CSV format to the internal memory (USB mass storage device) of each GS200. By collecting and merging these files, you can view a list of the relationships between the voltages and currents of multiple channels.

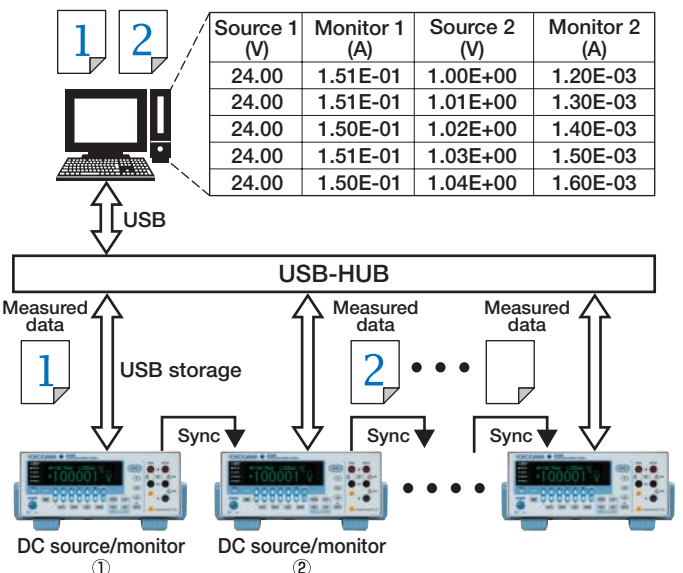
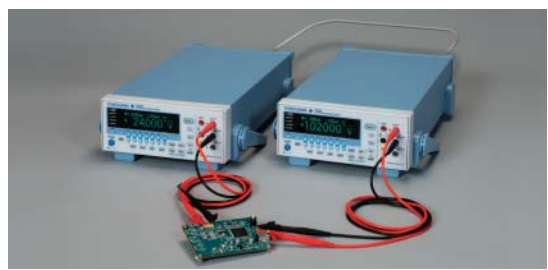

Rear Panel

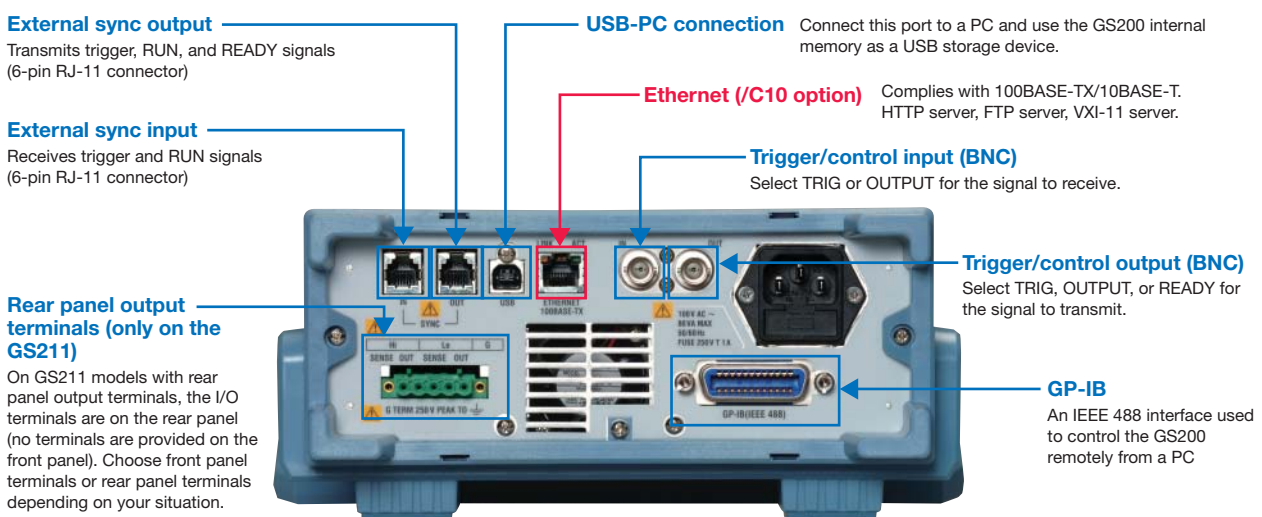

Specifications

Voltage Source Section

Range	Source Range	Resolution	24-Hour Stability ±(% of setting +μV)	90-Day Stability ±(% of setting +μV)	90-Day Accuracy ±(% of setting +μV)	1-Year Accuracy ±(% of setting +μV)	Temperature Coefficient ±(% of setting +μV) / °C
10mV	±12.0000mV	100nV	0.002 + 3	0.014 + 4	0.018 + 4	0.025 + 5	0.0018 + 0.7
100mV	±120.000mV	1μV	0.003 + 3	0.014 + 5	0.018 + 10	0.025 + 10	0.0018 + 0.7
1V	±1.20000V	10μV	0.001 + 10	0.008 + 50	0.010 + 100	0.016 + 120	0.0009 + 7
10V	±12.0000V	100μV	0.001 + 20	0.008 + 100	0.010 + 200	0.016 + 240	0.0008 + 10
30V	± 32.000V	1mV	0.001 + 50	0.008 + 200	0.010 + 500	0.016 + 600	0.0008 + 30

24-hour stability values are for 23°C ± 1°C and power fluctuation within ±5%.

90-day stability and 90-day and 1-year accuracy values are for 23°C ± 5°C.

Add the temperature coefficient for 90-day and 1-year accuracy values for 5°C to 18°C and for 28°C to 40°C.

Range	Maximum Output Current	Output Resistance	Output Noise		CMRR (50/60 Hz)
			DC to 10 Hz	DC to 10 kHz (Reference)	
10mV	----	App. 2 Ω	3μVp-p	30μVp-p	≥ 120dB
100mV	----	App. 2 Ω	5μVp-p	30μVp-p	
1 V	±200mA	≤ 2 mΩ	15μVp-p	60μVp-p	
10 V	±200mA	≤ 2 mΩ	50μVp-p	100μVp-p	
30 V	±200mA	≤ 2 mΩ	150μVp-p	200μVp-p	≥ 100dB

Current Source Section

Range	Source Range	Resolution	24-Hour Stability ±(% of setting +μA)	90-Day Stability ±(% of setting +μA)	90-Day Accuracy ±(% of setting +μA)	1-Year Accuracy ±(% of setting +μA)	Temperature Coefficient ±(% of setting +μA) / °C
1mA	±1.20000mA	10nA	0.0015+0.03	0.016+0.1	0.02+0.1	0.03 + 0.1	0.0015 + 0.01
10mA	±12.0000mA	100nA	0.0015+ 0.3	0.016+0.5	0.02+0.5	0.03 + 0.5	0.0015 + 0.1
100mA	±120.000mA	1μA	0.004+ 3	0.016+ 5	0.02+ 5	0.03 + 5	0.002 + 1
200mA	±200.000mA	1μA	0.004+ 20	0.016+ 30	0.02+ 30	0.03 + 30	0.002 + 5

24-hour stability values are for 23°C ± 1°C and power fluctuation within ±5%.

90-day stability and 90-day and 1-year accuracy values are for 23°C ± 5°C.

Add the temperature coefficient for 90-day and 1-year accuracy values for 5°C to 18°C and for 28°C to 40°C.

Range	Maximum Output Current	Output Resistance	Output Noise		CMRR (50/60 Hz)
			DC to 10 Hz	DC to 10 kHz (Reference)	
1mA	±30V	≥ 100MΩ	0.02μAp-p	0.1μAp-p	≥ 100nA/V
10mA	±30V	≥ 100MΩ	0.2μAp-p	0.3μAp-p	
100mA	±30V	≥ 10MΩ	2μAp-p	3μAp-p	
200mA	±30V	≥ 10MΩ	10μAp-p	15μAp-p	

Limiter Section

Setting	Range	Resolution
Current limiter (only during voltage generation)	1 mA to 200 mA	1mA
Voltage limiter (only during current generation)	1 V to 30 V	1 V

Response Time (Typical)

10 ms or less for all voltage source and current source ranges.

(Response time is the time from the point when the source begins to change until it reaches within 0.1% of the final value at maximum output, maximum load (pure resistive load), and with no limiter operation.)

Maximum Capacitive and Inductive Loads

Capacitive load: 10 μF

Inductive load: 1 mH

Voltage and Current Monitoring Feature (Optional)

● Voltage monitoring feature (only during current generation)

Range	Measurement Range	Resolution	Input Resistance	1-Year Accuracy (1 PLC) ±(% of reading+mV)	Temperature Coefficient ±(% of reading+mV) / °C
30 V	± 30.000 V	1mV	≥ 10MΩ	0.02+2	0.002+0.1

● Current monitoring feature (only during voltage generation)

Range	Measurement Range	Resolution	Input Resistance	1-Year Accuracy (1 PLC) ±(% of reading+μA)	Temperature Coefficient ±(% of reading+μA) / °C
200mA	± 200.00mA	10μA	≤ 2mΩ	0.03+300	0.003+30

Integration time : 1 to 25 PLC

Trigger source* : Internal timer (0.1 s to 3600.0 s), READY, communication, and immediate

Measurement delay (the delay from the trigger point):
0 to 999,999 ms (1 ms resolution)

Other features : Auto zero, NULL computation, and data storage

* Measurement trigger source

Internal timer : For monitoring. 0.1 s to 3600.0 s (0.1 s resolution)

READY : For curve tracing during program operation. The timing when READY signals are produced.

Comm. : For controlling the GS200 from a PC. Trigger generation through the *TRG command.

Immediate : Trigger generation at the end of measurement.

Programming Feature

Maximum number of steps : 10,000

Trigger : External, internal timer, step input, measurement end

Slope : 0 s to 3600.0 s (0.1 s resolution)

External Input and Output

BNC input/output

IN : TRIG IN, OUTPUT IN

OUT : TRIG OUT, OUTPUT OUT, READY OUT

External synchronization I/O

PIN No.	SYNC IN	SYNC OUT
1	OUTPUT IN	OUTPUT OUT
2	N.C.	N.C.
3	TRIG IN	TRIG OUT
4	GND	GND
5	N.C.	READY OUT
6	N.C.	N.C.

Communication Interface

· GP-IB

Electrical and mechanical specifications:

Conforms to IEEE Standard 488.2-1987

Functional specifications:

SH1, AH1, T6, L4, SR1, RL1, PP0, DC1, DT1, C0

Protocol : Conforms to IEEE Standard 488.2-1992

Addresses : 0 to 30 7651-command-compatible mode available

· USB interface

Ports : 1

Connector : Type B

Electrical and mechanical specifications : Conforms to USB 2.0

· Ethernet (optional)

Ports : 1

Connector : RJ-45

Electrical and mechanical specifications : Conforms to IEEE 802.3

Transmission system:

100BASE-TX/10BASE-T

Protocol : FTP server, HTTP server, VXI-11 server,
DHCP client, command socket

General Specifications

Display : 256 × 64 dot vacuum fluorescent display

Internal memory : 4 MB (non-volatile; stores setup files and
output pattern files)

Warm-up time : At least 60 minutes

Operating environment :
5 to 40 °C, 20 to 80% RH

Rated supply voltage:
100 VAC, 120 VAC, 230 VAC
(±10% of each rated voltage, 50/60 Hz)

Rated supply frequency: 50/60 Hz

Maximum power consumption:
Approx. 80 VA

Allowable input voltage:
32 V between the high and low terminals
42 V_{peak} between the low and ground
terminals
0.5 V between the output and sense
terminals
250 V_{peak} between the ground terminal
and the case

Weight : Approx. 5 kg

External dimensions:
Approx. 213 (W) × 88 (H) × 350 (D) mm
(excluding protrusions)

External dimensions

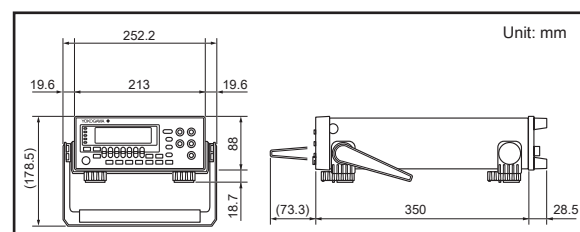

Model and Suffix Codes

Model	Suffix Code	Notes
GS210		DC voltage/current source (front panel output terminals)
GS211		DC voltage/current source (rear panel output terminals)
Supply Voltage	-1	100 VAC, 50/60 Hz
	-4	120 VAC, 50/60 Hz
	-7	230 VAC, 50/60 Hz
Power cord	-D	UL/CSA standard
	-F	VDE standard
	-R	AS standard
	-Q	BS standard
	-H	GB standard
Options	/MON	Voltage and current monitoring
	/C10	Ethernet interface

Standard Accessories

GS210, GS211	Power cord, rubber feet (4 pieces), user's manuals (1 set), fuse
GS210 only	Measurement leads 758933 (1 set of red and black leads), small alligator clip adapters 758922 (1 set of red and black leads)
GS211 only	Output terminal

Rack Mount Kits

Model	Product	Specifications
751533-E2	Rack mount kit	For EIA single mount
751533-J2	Rack mount kit	For JIS single mount
751534-E2	Rack mount kit	For EIA dual mount
751534-J2	Rack mount kit	For JIS dual mount

Related Products



Source Measure Unit GS610
Wide-range source and measurement function
Source and measurement range: ± 110 V and ± 3.2 A



Multi Channel Source Measure Unit GS820
2-channel source & sink operation
Source and measurement range: ± 7 V, ± 3.2 A and ± 18 V, ± 1.2 A



Note
"Before operating the product, read the user's manual thoroughly for proper and safe operation."



Note
Due to the nature of the product, it is possible for the user to come in contact with metal parts and receive electric shock. Exercise caution when using the product.

YOKOGAWA

YOKOGAWA ELECTRIC CORPORATION
Measurement Business Headquarters /Phone: (81)-422-52-6768, Fax: (81)-422-52-6624
E-mail: tm@cs.jp.yokogawa.com

YOKOGAWA CORPORATION OF AMERICA Phone: (1)-770-253-7000, Fax: (1)-770-251-6427
YOKOGAWA EUROPE B.V. Phone: (31)-88-4641000, Fax: (31)-88-4641111
YOKOGAWA ENGINEERING ASIA PTE. LTD. Phone: (65)-62419933, Fax: (65)-62412606

Optional Accessories

Model	Product	Specifications
758933	Measurement lead	1 m safety terminal cable with two leads (red and black), 1 set
758917	Measurement lead	0.75 m safety terminal cable with two leads (red and black), one set
701901	Safety adapter lead	1.8 m BNC-safety terminal cable
758919	Banana plug set	$\phi 4$ mm plug/ $\phi 4$ mm socket adapter
758922	Small alligator clip adapter	Safety terminal-alligator clip adapter, 1 set containing 2 pieces (red and black)
758929	Large alligator clip adapter	Safety terminal-alligator clip adapter, 1 set containing 2 pieces (red and black)
701959	Safety miniclip	Safety terminal-miniclip adapter, 1 set containing 2 pieces (red and black)
758921	Fork terminal adapter	Safety terminal-fork terminal adapter, 1 set containing 2 pieces (red and black)
758924	Conversion adapter	BNC-binding post adapter
751512	Conversion adapter	Banana male-to-binding post adapter
701902	Safety BNC cable	1 m BNC-BNC cable
701903	Safety BNC cable	2 m BNC-BNC cable
758923	Safety terminal adapter	Spring clamp type, 1 set containing 2 pieces (red and black)
758931	Safety terminal adapter	Screw-in type, 1 set containing 2 pieces (red and black)
758960	Synchronous operation cable	6-pin 1 m RJ11



758933 Measurement lead

2 pieces (red and black) in 1 set, length: 1.00 m
Used in combination with the 701959, 758921, 758922, or 758929. Rating: 1000 V CAT III/19 A



758917 Measurement lead

2 pieces (red and black) in 1 set, length: 0.75 m
Used in combination with the 701959, 758921, 758922, or 758929. Rating: 1000 V CAT II/32 A



701901 Safety adapter lead

Safety BNC (male) to safety terminal (banana, male)
Used in combination with 701959, 758921, 758922 or 758929.
Rating: 1000 V CAT II



758919 Banana plug set

$\phi 4$ -mm plug/ $\phi 4$ -mm socket adapter
Rating: 30 VAC to 60 VDC 30 A



758922 Small alligator clip adapter

Safety terminal (banana female)-to-alligator clip adapter, 2 pieces (red and black) in 1 set
Rating: 300 V CAT II
Connected to the 758933, 758917, or 701901.



758929 Large alligator clip adapter

Safety terminal (banana female)-to-alligator clip adapter, 2 pieces (red and black) in 1 set
Rating: 1000 V CAT II
Connected to the 758933, 758917, or 701901.



B9887AR measurement lead (for safety terminals)

Safety terminal-alligator clip cable



751512 conversion adapter

Banana male-to-binding post adapter



366922 conversion adapter

Banana male-BNC female conversion Used in combination with the 701901, 701902, or 701903.



701902/701903 Safety BNC-BNC cable

701902: Length 1m, 1000V CAT II
701903: Length 2m, 1000V CAT II



758923 Safety terminal adapter set

Spring clamp type (banana male)
2 pieces in 1 set
Easy attachment/detachment of the cable. *1



758931 Safety terminal adapter set

Screw-in type (banana male)
2 pieces in 1 set
Comes with a B9317WD 1.5-mm hexagonal wrench for fixing the cable in place. *1

*1 Wire diameter of cables that can connect to the adapter
758923 Core wire diameter: 2.5 mm or less, covering diameter: 5.0 mm or less
758931 Core wire diameter: 1.8 mm or less, covering diameter: 3.9 mm or less

Subject to change without notice.
[Ed : 01/b] Copyright ©2009
Printed in Japan, 911(KP)