



Agilent Technologies

Errata

Agilent E-Series E9320 Peak and Average Power Sensors Operating and Service Guide

Information provided in this supplement is to update the Operating and Service Guide for E-Series E9320 Peak and Average Power Sensors.

Updates

Accessories Shipped with the Instrument

The following items are shipped with every purchase of E9320 Series power sensors:

- Certificate of Calibration
- E9320 Series Power Sensors Operating and Service Guide

Verify that any options ordered are included with the shipment by checking the packing list included with the shipment.



E-Series E9320 Peak and Average Power Sensors

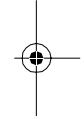
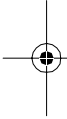

Operating and Service Guide



Agilent Technologies

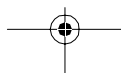



General

Information contained in this document is subject to change without notice. Agilent Technologies makes no warranty of any kind with regard to this material, including, but not limited to, the implied warranties of merchantability and fitness for a particular purpose. Agilent Technologies shall not be liable for errors contained herein or for incidental or consequential damages in connection with the furnishings, performance, or use of this material. No part of this document may be photocopied, reproduced, or translated to another language without the prior written consent of Agilent Technologies.

Copyright 2003-2011 Agilent Technologies

Agilent Technologies, Inc.
3501 Stevens Creek Blvd. Santa Clara, CA 95052 USA

Manual Part No. E9321-90001
Printed in Malaysia

April 18, 2011

Legal Information

Certification

Agilent Technologies certifies that this product met its published specifications at the time of shipment from the factory. Agilent Technologies further certifies that its calibration measurements are traceable to the United States National Institute of Standards and Technology, to the extent allowed by the Institute's calibration facility, and to the calibration facilities of other International Standards Organization members.



Safety Symbols

Safety Symbols

The following symbols on the instrument and in the documentation indicate precautions which must be taken to maintain safe operation of the instrument.



The Instruction Documentation Symbol. The product is marked with this symbol when it is necessary for the user to refer to the instructions in the supplied documentation.

Safety Notices

This guide uses warnings and cautions to denote hazards

WARNING

A warning calls attention to a procedure, practice or the like, which, if not correctly performed or adhered to, could result in injury or loss of life. Do not proceed beyond a warning until the indicated conditions are fully understood and met.

CAUTION

A caution calls attention to a procedure, practice or the like which, if not correctly performed or adhered to, could result in damage to or the destruction of part or all of the equipment. Do not proceed beyond a caution until the indicated conditions are fully understood and met.

General Safety Information

The following general safety precautions must be observed during all phases of operation, service, and repair of this instrument. Failure to comply with these precautions or with specific warnings elsewhere in this manual violates safety standards of design, manufacture, and intended use of the instrument. Agilent Technologies assumes no liability for the customer's failure to comply with these requirements.

WARNING **BEFORE CONNECTING THE POWER SENSOR TO OTHER INSTRUMENTS ensure that all instruments are connected to the protective (earth) ground. Any interruption of the protective earth grounding will cause a potential shock hazard that could result in personal injury.**

Sound Emission

Herstellerbescheinigung

Diese Information steht im Zusammenhang mit den Anforderungen der Maschinenlärminformationsverordnung vom 18 Januar 1991.

- Sound Pressure LpA < 70 dB.
- Am Arbeitsplatz.
- Normaler Betrieb.
- Nach DIN 45635 T. 19 (Typprüfung).



General Safety Information

Manufacturers Declaration

This statement is provided to comply with the requirements of the German Sound DIN 45635 T. 19 (Typprüfung).

- Sound Pressure LpA < 70 dB.
- At operator position.
- Normal operation.
- According to ISO 7779 (Type Test).

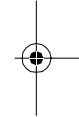
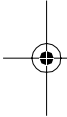

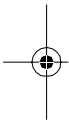

Contents

Contents

Safety Symbols	3
General Safety Information	4
Sound Emission	4
Contents	7
<hr/>	
Introduction	9
<hr/>	
General Information	10
Initial Inspection	10
Power Meter and Sensor Cable Requirements	11
Interconnections	11
Calibration	11
<hr/>	
The E-Series E9320 Power Sensors in Detail	13
<hr/>	
Specifications and Characteristics	15
<hr/>	
Introduction	16
Specifications	17
<hr/>	
Service	43
<hr/>	
General Information	44
Cleaning	44
Performance Test	45
Replaceable Parts	47
Service	51
Principles of Operation	51
Troubleshooting	54
Repair of Defective Sensor	54
Disassembly Procedure	55
Reassembly Procedure	55
Addendum	57



Contents

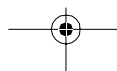
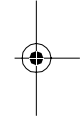
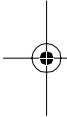



1 Introduction

What You'll Find In This Chapter

This Chapter introduces you to the E-series E9320 power sensors. It contains the following sections:

- General Information on page 10
- Initial Inspection on page 10
- Power Meter and Sensor Cable Requirements on page 11
- Interconnections on page 11
- The E-Series E9320 Power Sensors in Detail on page 13

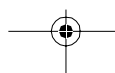
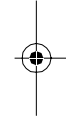

General Information

Welcome to the E-series E9320 power sensors *Operating and Service Guide*! This guide contains information about the initial inspection, connection, and specifications of the E-series E9320 power sensors. You can also find a copy of this guide on the CD-ROM supplied with the EPM-P series peak and average power meters.



To make best use of your sensor refer to the chapter “Using E-Series E9320 Sensors” in the EPM-P Series Power Meters *Operating and Service Guide*.

Initial Inspection

Inspect the shipping container for damage. If the shipping container or packaging material is damaged, it should be kept until the contents of the shipment have been checked mechanically and electrically. If there is mechanical damage, notify the nearest Agilent office. Keep the damaged shipping materials (if any) for inspection by the carrier and an Agilent representative. If required, you can find a list of Agilent Sales and Service offices on page 56.

General Information

Power Meter and Sensor Cable Requirements

The E-series E9320 power sensors are compatible ONLY with the EPM-P series power meters and with E9288 sensor cables. (The E9288 cables are color coded to help distinguish them from the 11730 series cables.)

Interconnections

Connect one end of an E9288 sensor cable to the E-series E9320 power sensor and connect the other end of the cable to the power meter's channel input. Allow a few seconds for the power meter to download the data contained in the power sensor.

Ensure power sensors and cables are attached and removed in an indoor environment.

Calibration

To carry out a zero and calibration cycle as requested by the power meter proceed as follows:

- Ensure the E-series E9320 power sensor is disconnected from any signal source. On the power meter, press **Zero Cal**, **Zero** (or **Zero A** / **Zero B**). During zeroing the wait symbol is displayed.

When the wait period is complete connect the E-series E9320 power sensor to the power meter's POWER REF output.

- Press **Cal** (or **Cal**, **Cal A** / **Cal B**). The wait symbol is again displayed during calibration.

TIP You can reduce the steps required to carry out the zero and calibration procedure as follows:

General Information

Connect the power sensor to the POWER REF output.

- Press **Zero Cal** and **Zero + Cal**. (For dual channel meters, press **Zero + Cal**, **Zero + Cal A** or **Zero + Cal B** as required.)

On completion, the power meter and sensor are ready to connect to the device under test (DUT).

WARNING

BEFORE CONNECTING THE POWER SENSOR TO OTHER INSTRUMENTS ensure that all instruments are connected to the protective (earth) ground. Any interruption of the protective earth grounding will cause a potential shock hazard that could result in personal injury.

CAUTION

The measurement connector (for connection to DUT) is Type-N (male). A torque wrench should be used to tighten these connectors. Use a 3/4-inch open-end wrench and torque to 12 in-lb (135 Ncm) for the Type-N connector.

Recommended Calibration Interval

Agilent Technologies recommends a one-year calibration cycle for the E-series E9320 peak and average power sensors.

The E-Series E9320 Power Sensors in Detail

The E-Series E9320 Power Sensors in Detail

The E-series E9320 power sensors have two frequency ranges. The E9325A, E9326A, and E9327A have a frequency range of 50 MHz to 18 GHz while the 50 MHz to 6 GHz range of the E9321A, E9322A, and E9323A covers most wireless communication applications.

The sensors have two independent measurement paths as shown in Figure 1.

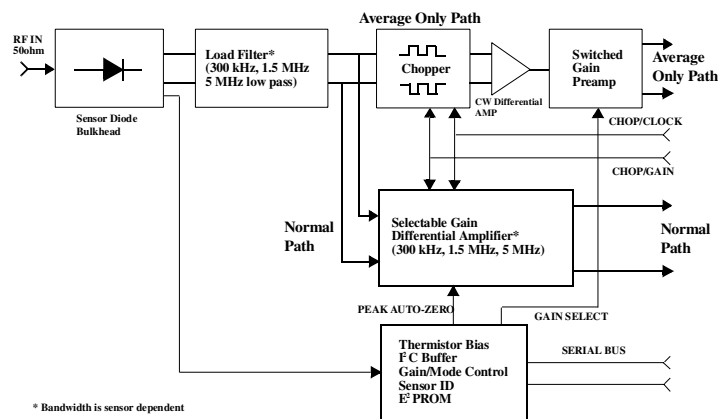

Figure 1 Simplified Sensor Block Diagram

Use the default *normal* path for continuously sampled measurements of modulated signals and time gated measurements. For each frequency range there is a choice of sensors with three video (modulation) bandwidths.

The E-Series E9320 Power Sensors in Detail

- E9321A and E9325A sensors with 300 kHz bandwidth are suitable for measuring TDMA signals such as GSM.
- E9322A and E9326A sensors with 1.5 MHz bandwidth are suitable for measuring IS-95 CDMA signals.
- E9323A and E9327A sensors with 5 MHz bandwidth are suitable for measuring W-CDMA signals.

Note however, that the sensors with widest bandwidth have the smallest dynamic range (in *normal* mode). If dynamic range is an important factor, use the sensor model with just enough video bandwidth for the measurement you want to make.

The *average-only* path is suitable for average power measurements of Continuous Wave (CW) and constant amplitude signals between -65 dBm (sensor dependent) and +20 dBm. The *average-only* path can also be used to measure true average power of any complex modulated signal below -20 dBm.

Calibration factors, linearity, temperature, and bandwidth compensation data are stored in the sensor EEPROM during the manufacturing process. All the compensation data is downloaded to the EPM-P series power meter at power-on or when the sensor is connected. You only need to enter the frequency of the RF signal you are measuring to achieve a high degree of accuracy.



2 Specifications and Characteristics

What You'll Find In This Chapter

This Chapter describes the specifications and characteristics of the E-series E9320 power sensors. It contains the following sections:

- "Introduction" on page 16
- "Specifications" on page 17

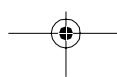
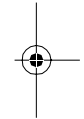
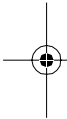

Introduction

E-series E9320 power sensors are designed for use with the Agilent EPM series power meters. The E-series E9320 power sensors have two measurement paths:

- **Normal** path: (default mode) for peak, average and time-related measurements.
- **Average-only** path: is designed primarily for average power measurements on low level signals.

These **specifications** are valid **ONLY** after zero and calibration of the power meter and sensor.

Supplemental characteristics, which are shown in italics, are intended to provide information useful in applying the power sensors by giving typical, but nonwarranted performance parameters. These characteristics are shown in *italics* or denoted as "*typical*", "*nominal*" or "*approximate*".

Specifications

Specifications

Frequency, Bandwidth, and Power Range

Table 1 Frequency, Bandwidth, and Power Range

Sensor	Maximum Video Bandwidth	Frequency Range	Power Range	
			Average only Mode	Normal Mode*
E9321A	300 kHz	50 MHz to 6 GHz	-65 dBm to +20 dBm	-50 dBm to +20 dBm
E9325A	300 kHz	50 MHz to 18 GHz	-65 dBm to +20 dBm	-50 dBm to +20 dBm
E9322A	1.5 MHz	50 MHz to 6 GHz	-60 dBm to +20 dBm	-45 dBm to +20 dBm
E9326A	1.5 MHz	50 MHz to 18 GHz	-60 dBm to +20 dBm	-45 dBm to +20 dBm
E9323A	5 MHz	50 MHz to 6 GHz	-60 dBm to +20 dBm	-40 dBm to +20 dBm
E9327A	5 MHz	50 MHz to 18 GHz	-60 dBm to +20 dBm	-40 dBm to +20 dBm

* For average power measurements, Free Run acquisition mode.

Specifications

Maximum Power, RF Connector

Table 2 Maximum Power, RF Connector

Sensor	RF Connector	Maximum Average Power	Maximum Peak Power
E9321A			
E9322A			
E9323A	N-Type (m)	+23 dBm average	+30 dBm,
E9325A			<10 μ s duration
E9326A			
E9327A			

Specifications

Measurement Ranges

The E-series E9320 power sensors have two measurement ranges (Lower and Upper) as shown in Table 3, Table 4, and Table 5.

Table 3 Lower and Upper Measurement Ranges

	<i>E9321A and E9325A</i>	
	<i>Normal mode</i>	<i>Average only mode</i>
Lower Range (Min. Power)	-50 dBm	-65 dBm
Lower Range (Max. Power)		
Lower to Upper Auto Range Point	+0.5 dBm	-17.5 dBm ¹
Upper to Lower Auto Range Point	-9.5 dBm	-18.5 dBm
Upper Range (Min. Power)	-35 dBm	-50 dBm
Upper Range (Max. Power)	+20 dBm	+20 dBm ¹

¹Applies to CW and constant amplitude signals only above -20 dBm.

Specifications

Table 4 Lower and Upper Measurement Ranges

	<i>E9322A and E9326A</i>	
	<i>Normal mode</i>	<i>Average only mode</i>
Lower Range (Min. Power)	-45 dBm	-60 dBm
<i>Lower Range (Max. Power)</i>		
<i>Lower to Upper Auto Range Point</i>	-5 dBm	-13.5 dBm ¹
<i>Upper to Lower Auto Range Point</i>	-15 dBm	-14.5 dBm
<i>Upper Range (Min. Power)</i>	-35 dBm	-45 dBm
Upper Range (Max. Power)	+20 dBm	+20 dBm ¹

¹Applies to CW and constant amplitude signals only above -20 dBm.

Specifications

Table 5 Lower and Upper Measurement Ranges

	<i>E9323A and E9327A</i>	
	<i>Normal mode</i>	<i>Average only mode</i>
Lower Range (Min. Power)	-40 dBm	-60 dBm
Lower Range (Max. Power) Lower to Upper Auto Range Point	-5 dBm	-10.5 dBm ¹
Upper to Lower Auto Range Point	-15 dBm	-11.5 dBm
Upper Range (Min. Power)	-30 dBm	-35 dBm
Upper Range (Max. Power)	+20 dBm	+20 dBm ¹

¹Applies to CW and constant amplitude signals only above -20 dBm.

Specifications

Power Sensor Maximum SWR

Table 6 Power Sensor Maximum SWR

Sensor	Maximum SWR ≤ 0 dBm
E9321A E9325A	50 MHz to 2 GHz: 1.12
	2 GHz to 10 GHz: 1.16
	10 GHz to 16 GHz: 1.23
	16 GHz to 18 GHz: 1.28
E9322A E9326A	50 MHz to 2 GHz: 1.12
	2 GHz to 12 GHz: 1.18
	12 GHz to 16 GHz: 1.21
	16 GHz to 18 GHz: 1.27
E9323A E9327A	50 MHz to 2 GHz: 1.14
	2 GHz to 16 GHz: 1.22
	16 GHz to 18 GHz: 1.26

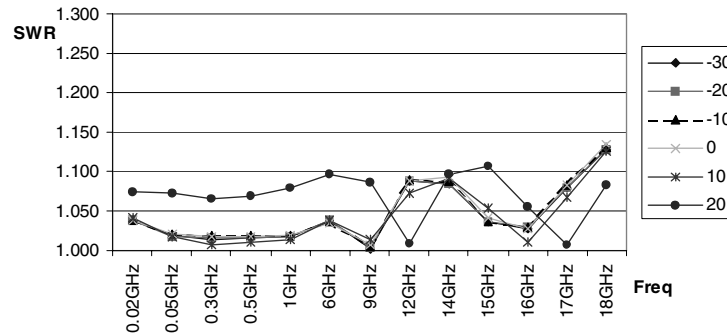

Figure 2 Typical SWR (50 MHz to 18 GHz) for the E9321A and E9325A sensors at various power levels

Specifications

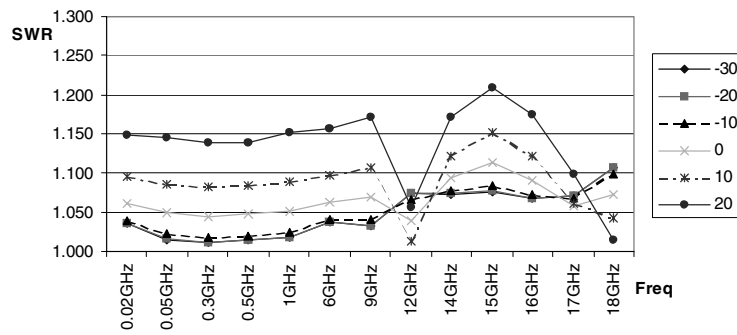

Figure 3 Typical SWR (50 MHz to 18 GHz) for the E9322A and E9326A sensors at various power levels

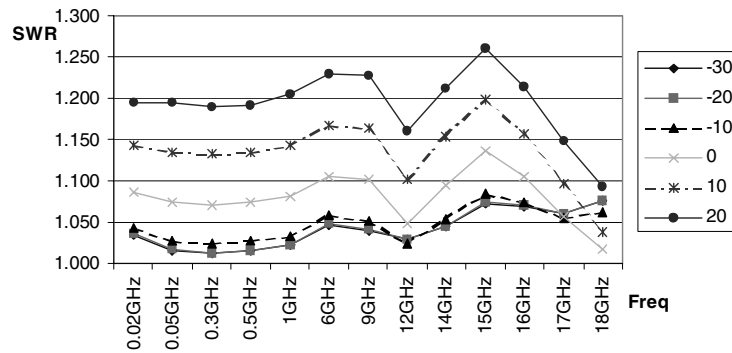

Figure 4 Typical SWR (50 MHz to 18 GHz) for the E9323A and E9327A sensors at various power levels

Sensor Linearity

**Table 7 Power Sensor Linearity Normal Mode
(upper and lower range)**

Sensor	Temperature (25 ±10°C)	Temperature (0 to 55°C)
E9321A E9325A	±4.2%	±5.0%
E9322A E9326A	±4.2%	±5.0%
E9323A E9327A	±4.2%	±5.5%

**Table 8 Power Sensor Linearity Average-Only Mode
(upper and lower range)**

Sensor	Temperature (25 ±10°C)	Temperature (0 to 55°C)
E9321A E9325A	±3.7%	±4.5%
E9322A E9326A	±3.7%	±4.5%
E9323A E9327A	±3.7%	±5.0%

If the temperature changes after calibration and the meter and sensor are NOT recalibrated, the following additional linearity errors should be added to the Power Linearity figures in Table 7 and Table 8.

Specifications

Table 9 Additional Linearity Error (normal and average-only modes)

Sensor	Temperature (25 ±10°C)	Temperature (0 to 55°C)
E9321A E9325A	±1.0%	±1.0%
E9322A E9326A	±1.0%	±1.5%
E9323A E9327A	±1.0%	±2.0%

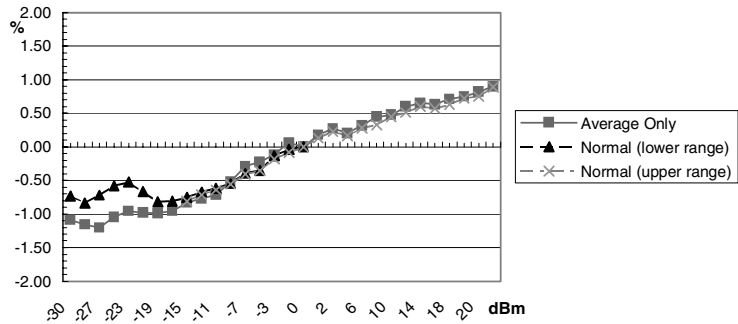

Figure 5 Typical Power Linearity at 25°C for E9323A and E9327A 5 MHz bandwidth sensors after zero and calibration, with associated measurement uncertainty

Specifications

Power Range	Measurement Uncertainty
-30 to -20 dBm	±0.9%
-20 to -10 dBm	±0.8%
-10 to 0 dBm	±0.65%
0 to +10 dBm	±0.55%
+10 to +20 dBm	±0.45%

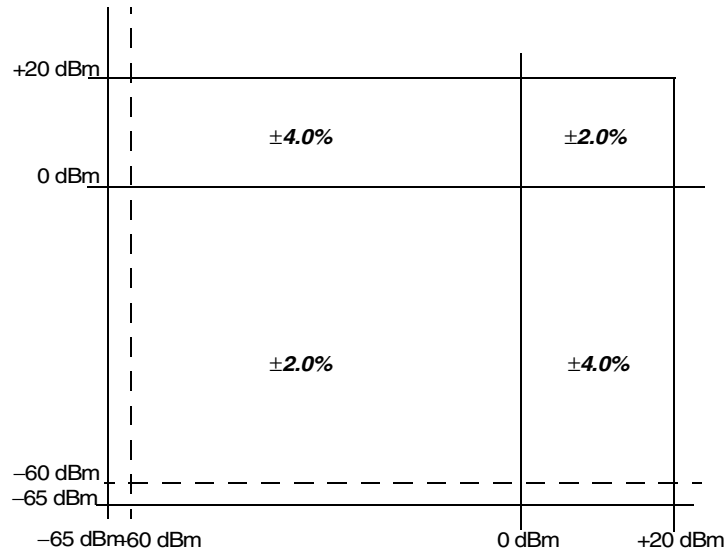

Figure 6 Relative Mode Power Measurement Linearity with an EPM-P series power meter, at 25°C (typical)



Specifications

Figure 6 shows the typical uncertainty in making a relative power measurement, using the same power meter channel and the same power sensor to obtain the reference and measured values. It also assumes that negligible change in frequency and mismatch error occurs when transitioning from the power level used as the reference to the power level measured.



Peak Flatness

The peak flatness is the flatness of a Peak-to-Average ratio measurement for various tone separations for an equal magnitude two-tone RF input. Figure 7, Figure 8, and Figure 9 refer to the relative error in Peak-to-Average measurement as the tone separation is varied. The measurements were performed at -10 dBm average power using an E9288A sensor cable.

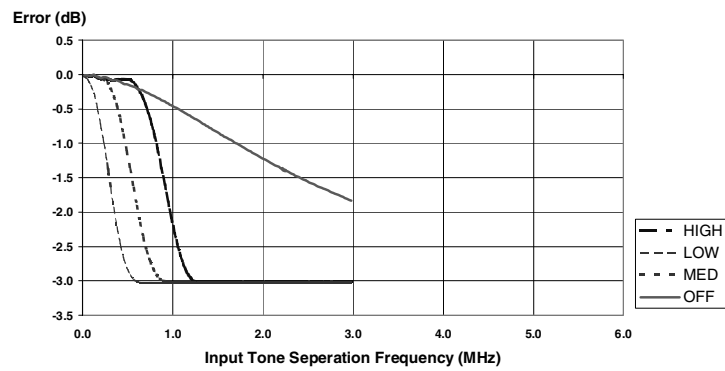

Figure 7 E9321A and E9325A Error in Peak-to-Average Measurements for a Two-tone Input (High, Medium, Low, and Off Filters)

Specifications

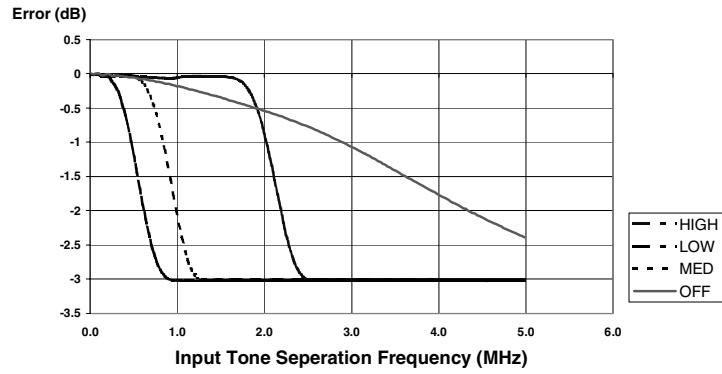

Figure 8 Filter responses for the E9322A and E9326A power sensors (High, Medium, Low, and Off)

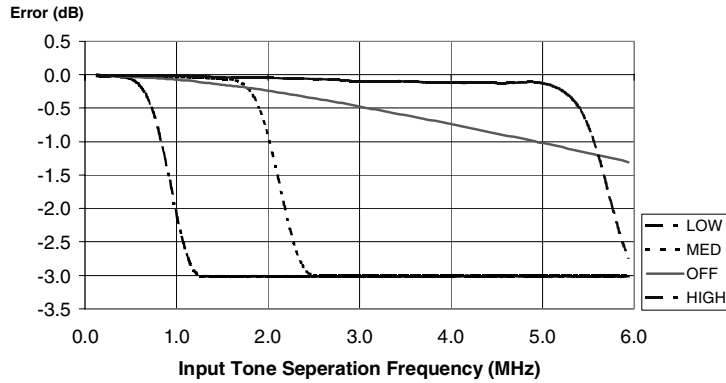

Figure 9 Filter responses for the E9323A and E9327A power sensors (High, Medium, Low, and Off)

Calibration Factor (CF) and Reflection Coefficient (Rho)

Calibration Factor and Reflection Coefficient data are provided at frequency intervals on a data sheet included with the power sensor. This data is unique to each sensor. If you have more than one sensor, match the serial number on the data sheet with the serial number of the sensor you are using. The CF corrects for the frequency response of the sensor. The EPM-P Series power meter automatically reads the CF data stored in the sensor and uses it to make corrections.

For power levels greater than 0 dBm, add to the calibration factor uncertainty specification:

±0.1% per dB for E9321A and E9325A power sensors

±0.15% per dB for E9322A and E9326A power sensors

±0.2% per dB for E9323A and E9327A power sensors

Reflection coefficient (Rho) relates to the SWR according to the formula:

$$SWR = (1 + Rho) / (1 - Rho)$$

Typical CF data are listed in Table 10.

The uncertainty analysis for the calibration of the sensors was calculated in accordance with the ISO Guide. The uncertainty data, reported on the calibration certificate, is the expanded uncertainty with a 95% confidence level and a coverage factor of 2.

Specifications

Table 10 Cal Factor Uncertainty at 0.1 mW (-10dBm)

Frequency	Uncertainty (%) (25 ±10°C)	Uncertainty(%) (0 to 55°C)
50 MHz	Reference	Reference
100 MHz	±1.8	±2.0
300 MHz	±1.8	±2.0
500 MHz	±1.8	±2.0
800 MHz	±1.8	±2.0
1.0 GHz	±2.1	±2.3
1.2 GHz	±2.1	±2.3
1.5 GHz	±2.1	±2.3
2.0 GHz	±2.1	±2.3
3.0 GHz	±2.1	±2.3
4.0 GHz	±2.1	±2.3
5.0 GHz	±2.1	±2.3
6.0 GHz	±2.1	±2.3
7.0 GHz	±2.3	±2.5
8.0 GHz	±2.3	±2.5
9.0 GHz	±2.3	±2.5
11.0 GHz	±2.3	±2.5
12.0 GHz	±2.3	±2.5
13.0 GHz	±2.3	±2.5
14.0 GHz	±2.5	±2.8
15.0 GHz	±2.5	±2.8
16.0 GHz	±2.5	±2.8
17.0 GHz	±2.5	±2.8
18.0 GHz	±2.5	±2.8

Specifications

Zero Set

This specification applies to a ZERO performed when the sensor input is not connected to the POWER REFERENCE.

Table 11 Zero Set

Sensor	Zero Set (Normal mode)	Zero Set (Average-only Mode)
E9321A E9325A	5 nW	0.17 nW
E9322A E9326A	19 nW	0.5 nW
E9323A E9327A	60 nW	0.6 nW

Specifications

Zero Drift and Measurement Noise

Table 12 Zero Drift and Measurement Noise

Sensor	Zero Drift ¹		Measurement Noise ²		
	Normal Mode	Average only Mode	Normal Mode ³	Normal Mode ⁴	Average only Mode
E9321A E9325A	<±5 nW	<±60 pW	<6 nW	<75 nW	<165 pW
E9322A E9326A	<±5 nW	<±100 pW	<12 nW	<180 nW	<330 pW
E9323A E9327A	<±40 nW	<±100 pW	<25 nW	<550 nW	<400 pW

¹ Within 1 hour after zero set, at a constant temperature, after a 24 hour warm-up of the power meter.

² Measured over a one minute interval, at a constant temperature, two standard deviations, with averaging set to 1 (*normal mode*), 16 (for *average-only mode*, normal speed) and 32 (*average-only mode*, x2 speed).

³ In Free run acquisition mode.

⁴ Noise per sample, Video bandwidth set to OFF with no averaging (i.e., averaging set to 1) - see "Effect of Video Bandwidth Settings" and Table 14.



Specifications

Effect of Averaging on Noise: Averaging over 1 to 1024 readings is available for reducing noise. Table 12 provides the Measurement Noise for a particular sensor. Use the Noise Multipliers in Table 13 for the appropriate speed (normal or x2), or measurement mode (*normal* and *average-only*), and the number of averages to determine the total Measurement Noise value.

In addition, for x2 speed (in *normal* mode) the total Measurement Noise should be multiplied by 1.2, and for fast speed (in *normal* mode) the multiplier is 3.4. Note that in fast speed no additional averaging is implemented.

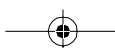

Specifications

Table 13 Noise Multipliers

Number of Averages	Noise Multiplier		
	Average-only		Normal
	Normal Speed	X 2 Speed	Normal Speed, Free run acquisition
1	5.5	6.5	1.0
2	3.89	4.6	0.94
4	2.75	3.25	0.88
8	1.94	2.3	0.82
16	1.0	1.63	0.76
32	0.85	1.0	0.70
64	0.61	0.72	0.64
128	0.49	0.57	0.58
256	0.34	0.41	0.52
512	0.24	0.29	0.46
1024	0.17	0.2	0.40

Example: E9321A power sensor, Number of Averages = 4, Free Run acquisition, normal mode, x2 speed.

Measurement Noise calculation:
 $(<6 \text{ nW} \times 0.88 \times 1.2) = <6.34 \text{ nW}$

Specifications

Effect of Video Bandwidth Setting: The noise per sample is reduced by applying the meter video bandwidth reduction filter setting (High, Medium, or Low). If averaging is implemented, this will dominate any effect of changing the video bandwidth.

Table 14 Effect of Video Bandwidth on Noise per Sample

Sensor	Noise Multipliers		
	Low	Medium	High
E9321A E9325A	0.32	0.5	0.63
E9322A E9326A	0.50	0.63	0.80
E9323A E9327A	0.40	0.63	1.0

Example: E9322A power sensor, triggered acquisition, high video bandwidth.

Noise per sample calculation:
 $(<180nW \times 0.80) = <144 nW$

Effect of Time-Gating on Measurement Noise: The measurement noise will depend on the time gate length over which measurements are made. Effectively 20 averages are carried out every 1 μ s of gate length.

Specifications

Settling Times**Average Only Mode:**

In normal and x2 speed mode, manual filter, 10 dB decreasing power step, refer to Table 15.

Table 15 Averages vs. Settling Time (Average-only mode)

Number of Averages	Settling Time (s)	
	Normal Speed Mode	X 2 Speed Mode
1	0.08	0.07
2	0.13	0.09
4	0.24	0.15
8	0.45	0.24
16	1.1	0.45
32	1.9	1.1
64	3.5	1.9
128	6.7	3.5
256	14	6.7
512	27	14
1024	57	27

In Fast mode, within the range -50 to $+20$ dBm, for a 10 dB decreasing power step, the settling time is:

E4416A: 10 ms

E4417A: 20 ms

When a power step crosses the power sensor's auto-range switch point, add 25 ms.

Specifications

Normal Mode:

In Normal, free run acquisition mode, within the range -20 to $+20$ dBm, for a 10 dB decreasing power step, the settling time is dominated by the measurement update rate and is listed in Table 16 for various filter settings.

Table 16 Settling Time vs. Averages

Number of Averages	Settling Time	
	Free Run Acquisition Mode	
	Normal Speed	X 2 Speed
1	0.1 sec	0.08 sec
2	0.15 sec	0.1 sec
4	0.25 sec	0.15 sec
8	0.45 sec	0.25 sec
16	0.9 sec	0.45 sec
32	1.7 sec	0.9 sec
64	3.3 sec	1.7 sec
128	6.5 sec	3.3 sec
256	13.0 sec	6.5 sec
512	25.8 sec	13.0 sec
1024	51.5 sec	25.8 sec

Specifications

In normal mode, measuring in continuous or single acquisition mode, the performance of rise times, fall times and 99% settled results are shown in Table 17. Rise and fall time specifications are for a 0.0 dBm pulse, with the rise time and fall time measured between 10% to 90% points and upper range selected.

Table 17 Rise and Fall Times vs. Sensor Bandwidth¹

Sensor	Parameter	Video Bandwidth Setting			
		Low	Medium	High	Off
E9321A E9325A	Rise time < μ s	2.6	1.5	0.9	0.3
	Fall time < μ s	2.7	1.5	0.9	0.5
	Settling time (rising) < μ s	5.1	5.1	4.5	0.6
	Settling time (falling) < μ s	5.1	5.1	4.5	0.9
E9322A E9326A	Rise time < μ s	1.5	0.9	0.4	0.2
	Fall time < μ s	1.5	0.9	0.4	0.3
	Settling time (rising) < μ s	5.3	4.5	3.5	0.5
	Settling time (falling) < μ s	5.3	4.5	3.5	0.9
E9323A E9327A	Rise time < μ s	0.9	0.4	0.2	0.2
	Fall time < μ s	0.9	0.4	0.2	0.2
	Settling time (rising) < μ s	4.5	3.5	1.5	0.4
	Settling time (falling) < μ s	4.5	3.5	2	0.4

¹Rise and fall time specifications are only valid when used with the E9288A sensor cable (1.5 metres).

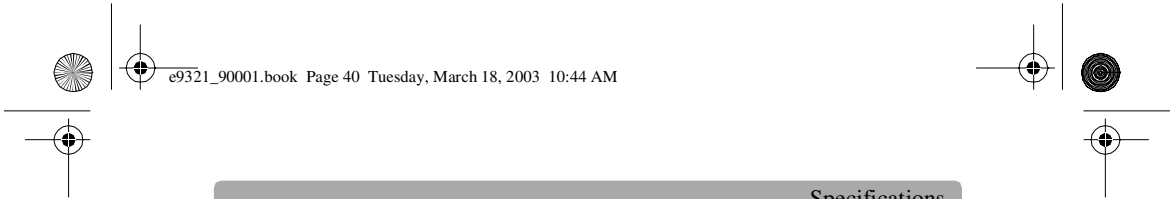

Specifications

Overshoot in response to power steps with fast rise times, i.e., less than the sensor rise time is less than 10%.
When a power step crosses the power sensor's auto-range switch point, add 10 μ s.

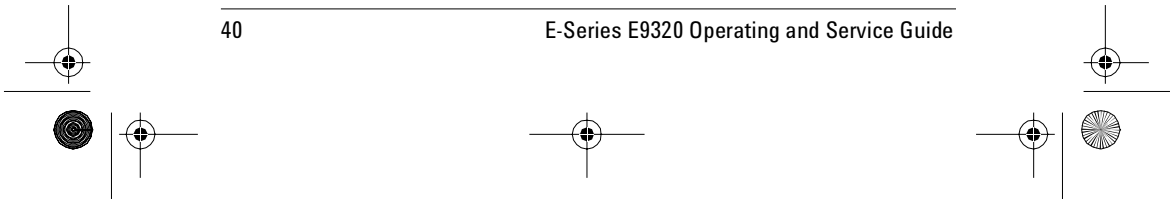

Specifications

Physical Specifications

Table 18 Physical Specifications

Physical Characteristics	
Net Weight	0.2 kg (0.45 lb)
Shipping Weight	0.55 kg (1.2 lb)
Dimensions	Length: 150 mm (5.9 in) Width: 38 mm (1.5 in) Height: 30 mm (1.2 in)





3 Service

What You'll Find In This Chapter

This Chapter introduces you to the E-series E9320 power sensors. It contains the following sections:

- General Information on page 44
- Service on page 51
- Sales and Service Offices on page 56



General Information

This chapter contains information about general maintenance, performance tests, troubleshooting and repair of E-series E9320 power sensors.

Cleaning

Use a clean, damp cloth to clean the body of the E-series E9320 power sensor.

Connector Cleaning

The RF connector beads deteriorate when contacted by hydrocarbon compounds such as acetone, trichloroethylene, carbon tetrachloride, and benzene.

Clean the connector only at a static free workstation. Electrostatic discharge to the center pin of the connector will render the power sensor inoperative.

Keeping in mind its flammable nature; a solution of pure isopropyl or ethyl alcohol can be used to clean the connector.

Clean the connector face using a cotton swab dipped in isopropyl alcohol. If the swab is too big use a round wooden toothpick wrapped in a lint free cotton cloth dipped in isopropyl alcohol.

General Information

Performance Test

Standing Wave Ratio (SWR) and Reflection Coefficient (Rho) Performance Test

This section does not establish preset SWR test procedures since there are several test methods and different equipment available for testing the SWR or reflection coefficient. Therefore, the actual accuracy of the test equipment must be accounted for when measuring against instrument specifications to determine a pass or fail condition. The test system used must not exceed the system Rho uncertainties shown in Table 19 when testing the E9325A, E9326A, and E9327A. Use Table 20 when testing the E9321A, E9322A, and E9323A.

Table 19 Reflection Coefficient for the E9321A and E9325A

Frequency	System Rho Uncertainty	Measured value	Maximum Rho
50 MHz to 2 GHz	± 0.010		0.057
2 GHz to 10 GHz	± 0.010		0.074
10 GHz to 16 GHz	± 0.010		0.103
16 GHz to 18 GHz	± 0.010		0.123

General Information

Table 20 Reflection Coefficient for the E9322A and E9326A

Frequency	System Rho Uncertainty	Measured value	Maximum Rho
50 MHz to 2 GHz	± 0.010		0.057
2 GHz to 10 GHz	± 0.010		0.083
10 GHz to 16GHz	± 0.010		0.095
16 GHz to 18GHz	± 0.010		0.119

Table 21 Reflection Coefficient for the E9323A and E9327A

Frequency	System Rho Uncertainty	Measured value	Maximum Rho
50 MHz to 2 GHz	± 0.010		0.065
2 GHz to 16GHz	± 0.010		0.099
16 GHz to 18GHz	± 0.010		0.115



General Information

Replaceable Parts

Table 22 is a list of replaceable parts. Figure 10 is the illustrated parts breakdown (IPB) that identifies all of the replaceable parts. To order a part, quote the Agilent part number, specify the quantity required, and address the order to the nearest Agilent office.

NOTE Within the USA, it is better to order directly from the Agilent Parts Center in Roseville, California. Ask your nearest Agilent office for information and forms for the "Direct Mail Order System." Also your nearest Agilent office can supply toll free telephone numbers for ordering parts and supplies



General Information

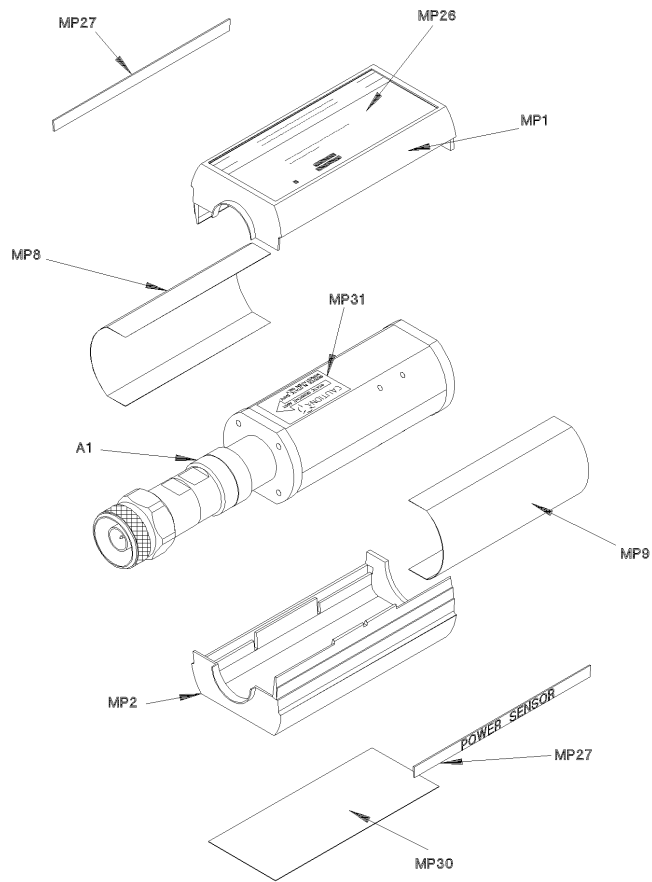

Figure 10 Illustrated Parts Break down

General Information

Table 22 Replaceable Parts List

Reference Designation	Part Number	Qty	Description
A1/A2 E9321A	E9321-60011	1	SENSOR MODULE
A1/A2 E9321A	E9321-69011	1	RESTORED SENSOR MODULE
A1/A2 E9322A	E9322-60004	1	SENSOR MODULE
A1/A2 E9322A	E9322-69004	1	RESTORED SENSOR MODULE
A1/A2 E9323A	E9323-60002	1	SENSOR MODULE
A1/A2 E9323A	E9323-69002	1	RESTORED SENSOR MODULE
A1/A2 E9325A	E9325-60002	1	SENSOR MODULE
A1/A2 E9325A	E9325-69002	1	RESTORED SENSOR MODULE
A1/A2 E9326A	E9326-60002	1	SENSOR MODULE
A1/A2 E9326A	E9326-69002	1	RESTORED SENSOR MODULE
A1/A2 E9327A	E9327-60002	1	SENSOR MODULE
A1/A2 E9327A	E9327-69002	1	RESTORED SENSOR MODULE

General Information

Table 22 Replaceable Parts List

Reference Designation	Part Number	Qty	Description
MP1 and MP2	E9321-40001	2	SHELL-PLASTIC
MP3 and MP4	E9321-20002	2	CHASSIS
MP8 and MP9	E9321-00001	2	SHIELD
MP26	E9321-80001	1	LABEL, ID E9321A
MP26	E9322-80001	1	LABEL, ID E9322A
MP26	E9323-80001	1	LABEL, ID E9323A
MP26	E9325-80001	1	LABEL, ID E9325A
MP26	E9326-80001	1	LABEL, ID E9326A
MP26	E9327-80001	1	LABEL, ID E9327A
MP27	E9321-80002	2	LABEL, POWER SENSOR
MP30	E9321-80003	1	LABEL, CAL/ESD

NOTE The A1/A2 parts are applicable only for Agilent Service Center as calibration is required.

Service

Service

Service instructions consist of principles of operation, troubleshooting, and repairs.

Principles of Operation

The Power Sensor 'bulkhead' assembly converts input RF to a low frequency voltage signal representing the RF power envelope. The input is AC coupled to a 3dB attenuator followed by a 50 ohm load resistor. Two diodes are connected to the load resistor, forming a pair of half-wave detectors with opposite polarity and complementary voltage output. The detected signal passes through a low-pass load filter. The cutoff frequency of the filter is 300 kHz, 1.5 MHz, or 5 MHz, depending on the model/ bandwidth specification of the sensor.

The detected signal can now follow one of two paths. The *average-only* signal path is optimized for high sensitivity and low drift at the expense of detector video bandwidth. This path chops the signal to a carrier frequency around 440Hz to remove sensitivity to DC offsets, then amplifies the AC signal. Amplification and chopping parameters are much the same as in previous Agilent diode sensors, with typical dynamic power range of -65 to +20 dBm.

The chopper is a switch that connects the two balanced signals to the two inputs of a differential amplifier. Thus, the small DC signal from the detector is converted to an AC signal. The output of the differential amplifier is connected to a switched gain preamplifier.

The dynamic range of the sensor is greater than 80dB in this mode, so the sensor has two power ranges. On the high power range the signal is attenuated before further amplification. The bandwidth of the chopped signal is limited to less than half the chop rate. So, this method cannot be used for wide (~5 MHz) bandwidth measurements.

The *normal* path is used to detect the instantaneous power of an RF signal and is optimized for a bandwidth of up to 5MHz. The peak path trade off includes reduced dynamic range and increased temperature sensitivity.

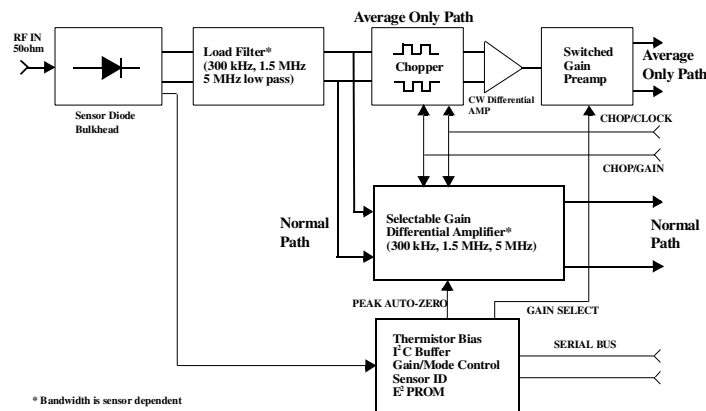

Figure 11 Simplified Sensor Block Diagram

The output of the load filter is connected to a gain selectable amplifier with a bandwidth corresponding to the sensor model/ bandwidth spec. The differential configuration minimizes sensitivity to ground noise, dc offset and drift. In *normal* mode, the amplifier provides maximum bandwidths of 300 kHz, 1.5 MHz or 5 MHz, allowing the user to match the test signal's modulation bandwidth to the sophisticated instrument data processing. This permits the meter to



Service

measure burst average and peak power, to compute peak-to-average ratios, and display other time-gated power profiles on the power meter's large LCD screen.

The three dimensional Calibration data is stored in an EEPROM on the sensor PCA. This data is unique to each sensor and consists of frequency vs. input power vs. temperature. Upon power-up, or when the sensor cable is connected, these calibration factors are downloaded into the EPM-P (E4416A/17A) series power meters. This means that the operator is not required to enter any calibration information when changing sensors, simply entering the frequency of the input signal is all that is required



Troubleshooting

Troubleshooting information is intended to first isolate the power sensor, cable, or power meter as the defective component. When the power sensor is isolated, an appropriate Sensor Module must be used for repair. See Table 22 on page 49.

If error message 241 or 310 is displayed on the power meter, suspect a power sensor failure. Error 241 will occur if the sensor is missing. An E9288 cable must be used to connect an E-series 9320A sensor to an EPM-P Series power meter.

If no error message is displayed, but a problem occurs when making a measurement, try replacing the cable from the power meter to the power sensor. If the problem still exists, try using a different power sensor to determine if the problem is in the power meter or in the power sensor.

Electrostatic discharge will render the power sensor inoperative. Do not, under any circumstances, open the power sensor unless you and the power sensor are in a static free environment.

Repair of Defective Sensor

There are no serviceable parts inside the E-series E9320 power sensors. If the sensor is defective, replace the entire "module" with the appropriate "Restored Sensor Module" listed in Table 22 on page 49.

Service

Disassembly Procedure

Disassemble the power sensor by performing the following steps:

Disassemble the power sensor only in a static free workstation. Electrostatic discharge renders the power sensor inoperative.



Figure 12 Removing Power Sensor Shell

At the rear of the power sensor, insert the blade of a screwdriver between the plastic shells (See Figure 12). To prevent damage to the plastic shells use a screwdriver blade as wide as the slot between the two shells.

Pry alternately at both sides of the connector J1 until the plastic shells are apart. Remove the shells and the magnetic shields.

Reassembly Procedure

Replace the magnetic shields and the plastic shells. Snap the plastic shells together.

Sales and Service Offices

In any correspondence or telephone conversations, refer to the power sensor by its model number and full serial number. With this information, the Agilent representative can quickly determine whether your unit is still within its warranty period.

UNITED STATES	(tel) 800 829 4444 (fax) 800 829 4433
CANADA	(tel) 877 894 4414 (fax) 800 746 4866
CHINA	(tel) 800 810 0189 (fax) 800 820 2816
EUROPE	(tel) 31 20 547 2111
JAPAN	(tel) (81) 426 56 7832 (fax) (81) 426 56 7840
KOREA	(tel) (080) 769 0800 (fax) (080) 769 0900
LATIN AMERICA	(tel) (305) 269 7500
TAIWAN	(tel) 0800 047 866 (fax) 0800 286 331
OTHER ASIA PACIFIC COUNTRIES	(tel) (65) 6375 8100 (fax) (65) 6755 0042