



Advanced Test Equipment Rentals
www.atecorp.com 800-404-ATEC (2832)

Quality is more than a word

ESPEC

Bench-Top Type Temperature (& Humidity) Chamber

SH·SU



Compact design for personal use, to network with your computer.

The Bench-top Type Temperature (& Humidity) Chamber Series features environmental testing performance in a compact design. Available in 20L and 60L capacities, these models offer temperature ranges as low as -20 , -40 , or -60°C , and as high as $+180^{\circ}\text{C}$, while achieving excellent performance rates, as well as communication interface compatibilities to collect test data. Espec offers you the best in terms of advanced testing equipment.

SH-262



SH-662





*The stands and the viewing window are optional.

Characteristics

High performance in a box



● Wide variation to select from

With its 3 temperature range patterns (to -60 , -40 or -20°C) and 2 volumes (22.5L and 64 L) selection, the Bench-top chamber offers 10 models in temperature or temperature/ humidity configuration, to fulfil customers' needs.

● Full-size chamber performance in a compact design

All our models now have a temperature range that extends up to 180°C , with a humidity range running from 30 to 95% rh, in a small and light structure that can even fit on a desk (22.5L model).



● Standard equipped instrumentation interlock input/output terminals

These terminals are installed as standard on the chamber. Use the input terminal to synchronize instrumentation, or command the start/ stop of the chamber according to set program, etc.

● Optimization of the chamber top space

The top of the chamber is rearranged with a free space, to tidy running cables, or put a measuring instrument, a notebook, or whatever equipment you need to keep close to the chamber. (Patent pending)



Instrumentation interlock terminals



Chamber top free space (SH-262)

● Improved performance to meet test severity

In addition to the extensive range of Bench-top models available, we developed a model with a heat up performance of 5k/ min., as a response to the recent demands in various industries for reliability testing.

Characteristics

● Greater cable port selection

In addition to the cable port installed as standard ($\phi 50\text{mm}$, right side) a wide selection is available for size and location of the cable ports, to meet customers' demand: $\phi 25$, $\phi 50$ or $\phi 100\text{mm}$, chamber sides or roof-top.

● Carts' variation to optimize chambers' footprint (option)

A wide selection of carts is available from the simple stand to option-mounted base.

Equipped of casters, you can use them to arrange your equipment and save space by stacking chambers and moving them whenever necessary.

(See page 19 for details)

● Selection of the water supply method (Option - SH type only)

A water tank is equipped as standard and can be accessed from the chamber front.

In addition to this tank we have also prepared other supply methods, should longer and continuous testing be necessary: continuous water supply, roof-top water tank.

● User-friendly features

The environment of the chamber is safe and quiet thanks to several options, such as the automatic water refill for the chamber humidity tray, or the noise reduction rear side cover, that also directs heat dissipation towards the ceiling for safe installation in your office.



Example of stacked chambers (H and C stands)



Example of instruments setup



Test area (SH-662)



Water supply tank

Characteristics



Viewing window (option)



Backtrace setting

● Online Diagnostics Service

(<http://www.espec.co.jp/english/support/onlinediagnosticservice.html>)



● Several choices to “observe”, “touch”, “manipulate”

Select the type of door you need for your testing: plain door or door with a viewing window (W215×H215mm for 22.5L type, W215×H315mm for 64L type). You can also complete by adding an inner door, with or without hand-in port, for the manipulation of specimen under test, or choose to install a viewing window on the roof-top.

* The inner glass door cannot be selected when the door is equipped with the viewing window

● Backtrace function

Backtrace data are created when the chamber triggers an alarm. All items required for chamber control including set temperature and humidity, measured temperature and humidity, etc. are recorded for the period before and after the alarm was triggered.

When the chamber stops because of trouble, the operation state just before the chamber stops is automatically recorded and saved. Saved data can be sent to ESPEC, by using our Online Diagnostics Service, and we will perform troubleshooting.

● Online Diagnostics Service

Online Diagnostics service is available using the backtrace data recorded by the chamber. Send the backtrace data to ESPEC via email; we will analyse the cause of the trouble and report the diagnosis back to you.

This service ensures accurately-performed diagnosis s that, in case repair work is required, appropriate troubleshooting will be prescribed ensuring reduced testing downtime.

● International standards

Complies with Safety of Machinery (ISO 12100), Low Voltage (IEC 60204), EMC (IEC 61000-6-2, IEC-61000-6-4)

All the Platinous J programming featured in a compact format

● N-instrumentation equipped with a color LCD touch panel

In the size of a smartphone screen, we replicate the easy-to-use Platinous N-instrumentation for the Bench-Top chamber.

Efficient and simple, ESPEC users will appreciate the homogeneity in our product lineup.

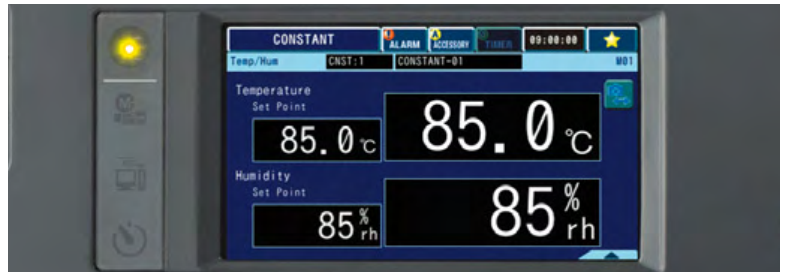

● Copy of program patterns

Transfer the programs between chambers without the need of a PC, via USB stick.

* The USB memory is not included.

● Trend graph output on USB stick

Trend graphs can be displayed on the web application or downloaded on a USB memory. It is also possible to continuously register data on the USB memory if numerous data records are needed.

* Reference: Data log with an interval of 30 sec., can be registered for 113 days and 18 hours.

● Program copy and computer editing

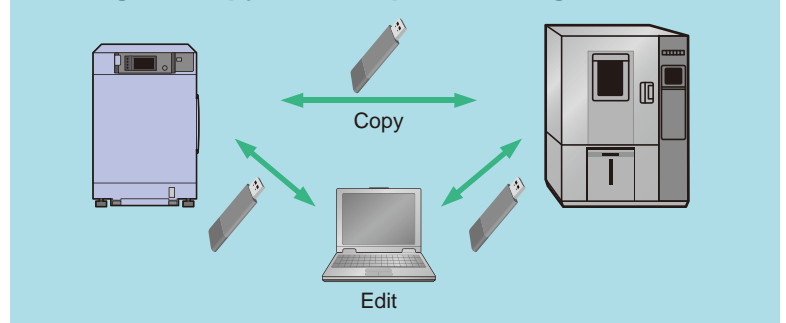

● Quick access button

The star mark (★) on the right top corner of the controller can be set to have instant access to any age you often need, either the constant operation start, on else.



USB port

● Multilingual display

A simple operation changes display text to Japanese, Chinese (simplified, traditional), or Korean. Select the language that suits your needs.

N-instrumentation

Operating mode	Constant operation, program operation, remote operation, stop
Setting range	<ul style="list-style-type: none"> • Constant setup 3 patterns Setting range: Temp.: (Lowest attainable temp. -5°C) to (Highest attainable temp. +10°C), 0.1°C unit Humidity: 0 to 100% rh, 1% unit • Program setup 8 patterns (99 steps) Setting range: (Lowest attainable temp. -5°C) to (Highest attainable temp. +10°C), 0.1°C unit Humidity: 0 to 100% rh, 1% unit Time: 0 hour and 1 min. to 9999 hours and 59 min. 1 min. unit
Language	Japanese, English, Chinese (simplified, traditional), Korean
External memory function	Interface: USB 2.0 standard compliant (A-type connector) Supported functions: <ul style="list-style-type: none"> • Write sampling data, Read/ Write program (application software: Patten Manager Lite) • Backtrace output
Web function	Interface: Ethernet port (100base-TX) Web applications: monitoring, setting, operation, maintenance setting, email alert Browser: Windows Internet Explorer 10

Remote monitoring and control thanks to a Web application



Remote monitoring and control (Ethernet connection)

A unique web application allows the user to monitor the chamber, set programs, and start and stop operation from a PC connected to the chamber LAN's port. No software required, the chamber can be accessed and controlled from any PC via a web browser (Smartphone, tablets and the like can also be used).

Wireless connection and multiple units' connection are also possible.

Email alert

When an alarm is triggered, an e-mail is sent to the registered PC or mobile address. A notification can also be sent at the time of test completion. Set the recipient mail address from the Maintenance setting screen.

*Requires an intranet environment capable of sending emails.

Login information

Privileges \ Screen	Chamber monitor	Constant Mode/ Program Setup	Run/ Stop	Device configuration
Administrator	○	○	○	○
Operator	○	○	○	×
User	○	×	×	×

Programming



Graph display

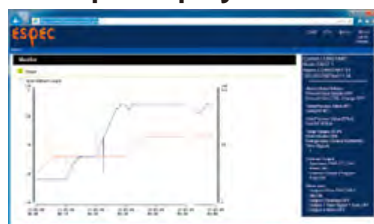

Multilingual display

The language available for the Web Manager (Japanese/ English/ Simplified Chinese/ Traditional Chinese/ Korean) can be changed without affecting the N-instrumentation language display.

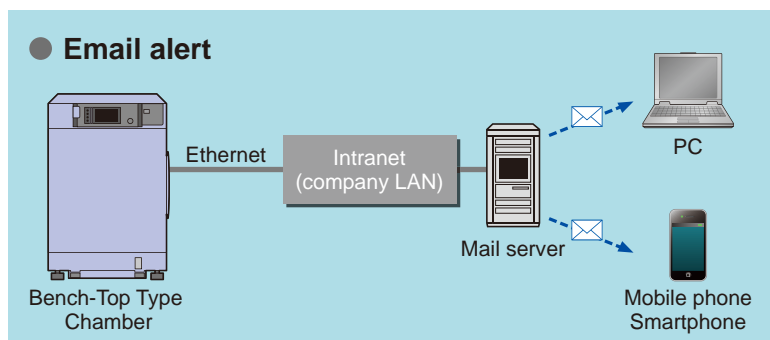

Pattern Manager Lite software: Get the most out of USB memory

Download programs online

Via the Pattern Manager Lite software installed on your PC, edit programs according to your testing needs, and upload them with a USB.

Copy and reproduce testing

You can copy the same test program in multiple chambers, provided that they have the same operation range, thanks to the USB memory. No need to program each chamber, just connect the USB and the test can start.

Edit programs

Through our online website Test Navi, dedicated to reliability and testing information, you can find most of the recognized international standard, available for download.

Charge them as is on your USB memory, or edit them and transfer to your chamber.

* Test Navi is a website dedicated to reliability testing information and technologies. <http://www.test-navi.com/eng/index.html>

The Pattern Manager Lite software allow you to edit programs for your chamber, view and edit data as graph, etc. The software can be downloaded from the Test Navi website.

Web Integrated Network (Sold separately)

Ideal for customers who needs to manage lots of testing chambers or measuring devices.

From a single screen on your browser, check and control your equipment fleet remotely. (Up to 100 devices)

You can manage test scheduling, equipment performances, and use this versatile system in many ways.

Other devices including manufacturers' chambers, or measuring equipment are compatible (LAN connection required).

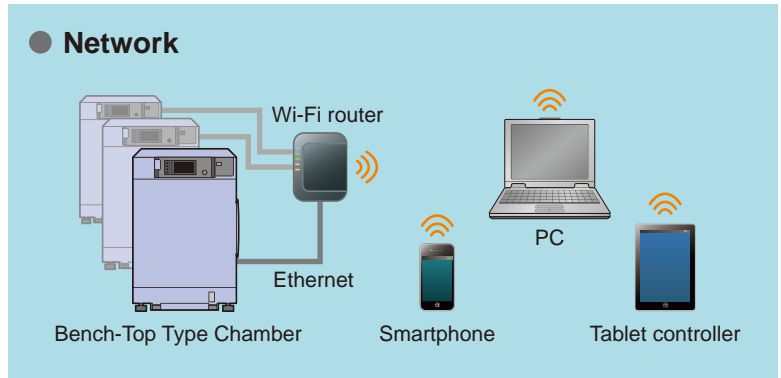

Test Navi (<http://www.test-navi.com/eng/index.html>)

This website provides practical knowledge on environmental testing that ESPEC has acquired through years of experience, as well as covering everything from the fundamentals to the latest information on environmental and reliability testing.

Product registration membership Website
Download Pattern Manager and WEB Manager information. [Download](#)

- Updates for chamber controller software
- Search for environmental test standards

Environmental Test Standards
For Pattern Manager Lite Test methods download

- Download test profiles from a list of environmental test standards

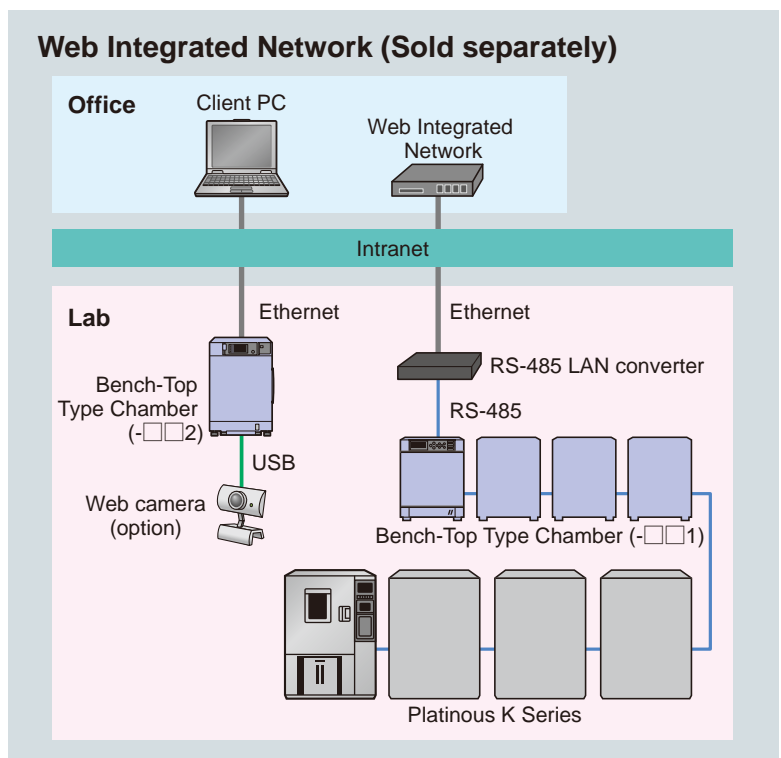

Model		SH-222	SH-242	SH-262	SH-642	SH-662	
System		Balanced Temperature & Humidity Control system (BTHC system)					
Temp. performance ^{*1}	Temp. range	-20 to +150°C (-4 to +302°F)	-40 to +150°C (-40 to +302°F)	-60 to +150°C (-76 to +302°F)	-40 to +150°C (-40 to +302°F)	-60 to +150°C (-76 to +302°F)	
	Temp. fluctuation	±0.3°C (-20 to +100°C) ±0.5°C (+100.1 to +150°C)	±0.3°C (-40 to +100°C) ±0.5°C (+100.1 to +150°C)	±0.3°C (-60 to +100°C) ±0.5°C (+100.1 to +150°C)	±0.3°C (-40 to +100°C) ±0.5°C (+100.1 to +150°C)	±0.3°C (-60 to +100°C) ±0.5°C (+100.1 to +150°C)	
	Temp. gradient / Temp. variation in space	2.5°C (-20 to +100°C) 4.0°C (+100.1 to +150°C)	2.5°C (-40 to +100°C) 4.0°C (+100.1 to +150°C)	2.5°C (-60 to +100°C) 4.0°C (+100.1 to +150°C)	2.5°C (-40 to +100°C) 4.0°C (+100.1 to +150°C)	2.5°C (-60 to +100°C) 4.0°C (+100.1 to +150°C)	
	Temp. rate of change	Heat up rate	3.2°C /min.	3.2°C /min.	3.2°C /min.	2.9°C /min.	2.9°C /min.
		Pull down rate	2.1°C /min.	2.1°C /min.	2.1°C /min.	1.7°C /min.	1.7°C /min.
	Temp. extreme achievement time Heat up time	From -20 to +150°C within 55 min.	From -40 to +150°C within 60 min.	From -60 to +150°C within 70 min.	From -40 to +150°C within 70 min.	From -60 to +150°C within 80 min.	
	Temp. extreme achievement time Pull down time	From +20 to -20°C within 20 min.	From +20 to -40°C within 50 min.	From +20 to -60°C within 70 min.	From +20 to -40°C within 60 min.	From +20 to -60°C within 90 min.	
Lowest attainable temp.	-20°C	-40°C	-60°C	-40°C	-60°C		
Humid. performance ^{*1}	Humid. range	30 to 95% rh (Refer to diagram on page 10)					
	Humid. fluctuation	±3.0% rh					
Construction	Heater	Nichrome strip wire heater					
	Humidifier	Stainless steel cartridge heater					
	Refrigeration unit	System	Mechanical single-stage refrigeration system		Mechanical cascade refrigeration system		
		Cooler	Plate fin cooler				
		Refrigerator	Hermetically sealed compressor, Air-cooled condenser, Expansion mechanism: Capillary tube system				
Refrigerator capacity		400W		[Unit 1: 400W ×1, Unit 2: 400W ×1]			
Refrigerant	R404A		R23, R404A				
Capacity	22.5 L			64 L			
Chamber total load resistance	20 kg						
Inside dimensions mm (inch) ^{*2}	W300×H300×D250 (W11.81×H11.81×D9.84)			W400×H400×D400 (W15.75×H15.75×D15.75)			
Outside dimensions mm (inch) ^{*2}	W440×H690×D695 (W17.32×H27.18×D27.36)		W440×H690×D785 (W17.32×H27.18×D30.91)	W540×H730×D920 (W21.26×H28.74×D36.22)			
Weight	83 kg (78 for 100V type)		105 kg	130 kg			
Utility requirements	Allowable ambient conditions	+5 to +35°C (+41 to +95°F)					
	Power supply ^{*3}	100V AC 1φ50/60Hz	14.5 A	18.0 A	21.0 A		
		115V AC 1φ60Hz	14.0 A	14.0 A	—		
		200V AC 1φ50/60Hz ^{*5}	—		14.5 A		
		220V AC 1φ50/60Hz ^{*4}	10.0 A	13.5 A	14.0 A		
230V AC 1φ50Hz ^{*4}	9.5 A	13.5 A	14.0 A				
Noise level ^{*6}	Between 42 and 52 dB		Between 42 and 56 dB	Between 48 and 59 dB			
Exhaust heat quantity	3500 kJ/h (836 kcal/h)		4000 kJ/h (955 kcal/h)	5040 kJ/h (1204 kcal/h)			

^{*1} The performance values are based on IEC 60068-3-5:2001, JTM K07:2007 for the temperature chamber, IEC 60068-3-6:2001, JTM K09:2009 for the humidity chamber. Performance figures are given for a +23°C ambient temperature, 65% rh, rated power supply and no specimens inside the test area. However, the lowest attainable temperature is given for a max. ambient temperature of +30°C. Heat-up time is the achieved time from lowest temperature to highest temperature within temperature range.

^{*2} Excluding protrusions.

^{*3} At ambient temperature +23°C.

^{*4} Compliance with CE Marking.

^{*5} 200V AC available with or without NEC specifications.

^{*6} Measurements are to be taken in an anechoic room at a height of 1.2m from the floor and a distance of 1m from the chamber front panel (ISO 1996-1:2003 _ A-weighted sound pressure level)

DIMENSIONS

unit:mm

● SH-222·242

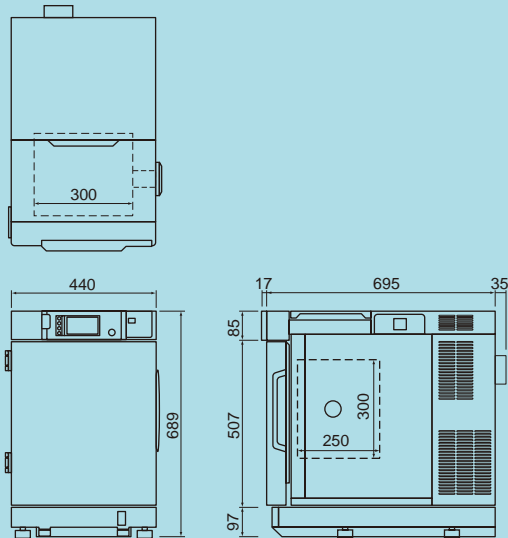

● SH-262

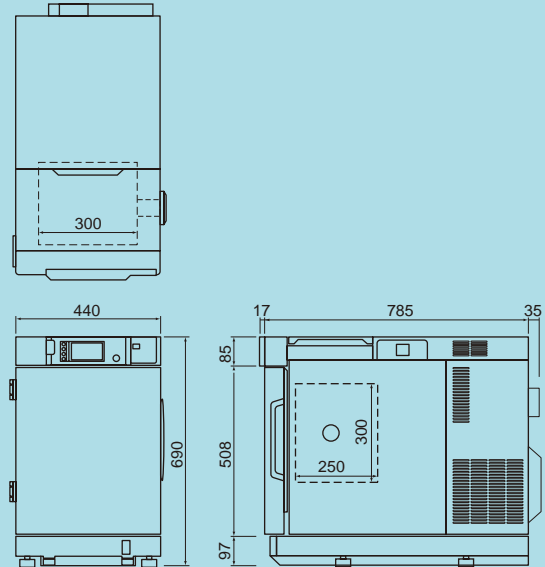

TEMPERATURE & HUMIDITY CONTROL RANGE (SH)

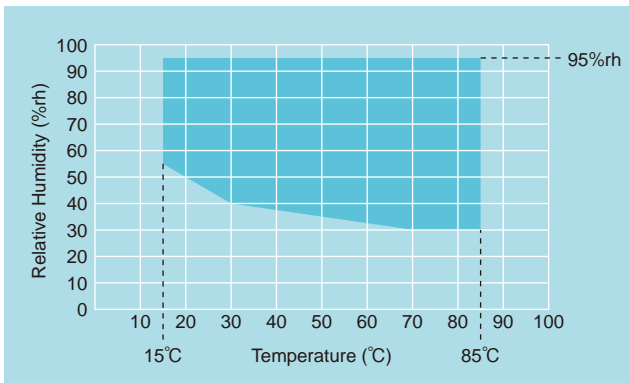

* At ambient temperature +23°C

● SH-642·662

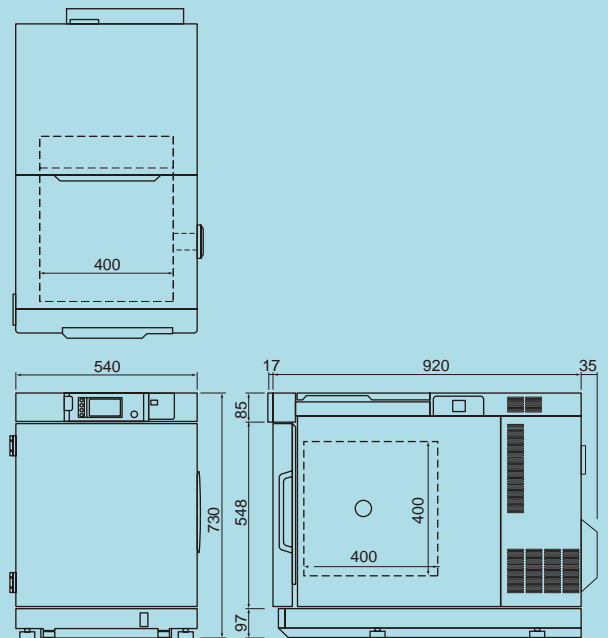

Model		SU-222	SU-242	SU-262	SU-642	SU-662	
System		Balanced Temperature Control system (BTC system)					
Temp. performance ^{*1}	Temp. range	-20 to +150°C (-4 to +302°F)	-40 to +150°C (-40 to +302°F)	-60 to +150°C (-76 to +302°F)	-40 to +150°C (-40 to +302°F)	-60 to +150°C (-76 to +302°F)	
	Temp. fluctuation	±0.3°C (-20 to +100°C) ±0.5°C (+100.1 to +150°C)	±0.3°C (-40 to +100°C) ±0.5°C (+100.1 to +150°C)	±0.3°C (-60 to +100°C) ±0.5°C (+100.1 to +150°C)	±0.3°C (-40 to +100°C) ±0.5°C (+100.1 to +150°C)	±0.3°C (-60 to +100°C) ±0.5°C (+100.1 to +150°C)	
	Temp. gradient / Temp. variation in space	2.5°C (-20 to +100°C) 4.0°C (+100.1 to +150°C)	2.5°C (-40 to +100°C) 4.0°C (+100.1 to +150°C)	2.5°C (-60 to +100°C) 4.0°C (+100.1 to +150°C)	2.5°C (-40 to +100°C) 4.0°C (+100.1 to +150°C)	2.5°C (-60 to +100°C) 4.0°C (+100.1 to +150°C)	
	Temp. rate of change	Heat up rate	3.2°C /min.	3.2°C /min.	3.2°C /min.	2.9°C /min.	2.9°C /min.
		Pull down rate	2.1°C /min.	2.1°C /min.	2.1°C /min.	1.7°C /min.	1.7°C /min.
	Temp. extreme achievement time Heat up time	From -20 to +150°C within 55 min.	From -40 to +150°C within 60 min.	From -60 to +150°C within 70 min.	From -40 to +150°C within 70 min.	From -60 to +150°C within 80 min.	
	Temp. extreme achievement time Pull down time	From +20 to -20°C within 20 min.	From +20 to -40°C within 50 min.	From +20 to -60°C within 70 min.	From +20 to -40°C within 60 min.	From +20 to -60°C within 90 min.	
	Lowest attainable temp.	-20°C	-40°C	-60°C	-40°C	-60°C	
Construction	Heater	Nichrome strip wire heater					
	Refrigeration unit	System	Mechanical single-stage refrigeration system		Mechanical cascade refrigeration system		
		Cooler	Plate fin cooler				
	Refrigerator	Hermetically sealed compressor, Air-cooled condenser, Expansion mechanism: Capillary tube system					
	Refrigerator capacity	400W		[Unit 1: 400W ×1, unit 2: 400W ×1]			
Refrigerant	R404A		R23, R404A				
Capacity	22.5 L			64 L			
Chamber total load resistance	20 kg						
Inside dimensions mm (inch) ^{*2}	W300×H300×D250 (W11.81×H11.81×D9.84)			W400×H400×D400 (W15.75×H15.75×D15.75)			
Outside dimensions mm (inch) ^{*2}	W440×H620×D695 (W17.32×H24.41×D27.36)		W440×H620×D785 (W17.32×H24.41×D30.91)	W540×H660×D920 (W21.26×H28.74×D36.22)			
Weight	78 kg (73 for 100V type)		100 kg	123 kg			
Utility requirements ^{*3}	Allowable ambient conditions	+5 to +35°C (+41 to +95°F)					
	Power supply	100V AC 1φ50/60Hz	12.5 A	18.0 A	21.0 A		
		115V AC 1φ60Hz	12.0 A	14.0 A	——		
		200V AC 1φ50/60Hz ^{*5}	——	——	14.5 A		
		220V AC 1φ50/60Hz ^{*4}	9.0 A	13.5 A	14.0 A		
230V AC 1φ50Hz ^{*4}	8.5 A	13.5 A	14.0 A				
Noise level ^{*6}	Between 42 and 52 dB		Between 42 and 56 dB	Between 48 and 59 dB			
Exhaust heat quantity	3500 kJ/h (836 kcal/h)		4000 kJ/h (955 kcal/h)	5040 kJ/h (1204 kcal/h)			

^{*1} The performance values are based on IEC 60068-3-5:2001, JTM K07:2007 for the temperature chamber, IEC 60068-3-6:2001, JTM K09:2009 for the humidity chamber. Performance figures are given for a +23°C ambient temperature, 65% rh, rated power supply and no specimens inside the test area. However, the lowest attainable temperature is given for a max. ambient temperature of +30°C. Heat-up time is the achieved time from lowest temperature to highest temperature within temperature range.

^{*2} Excluding protrusions.

^{*3} At ambient temperature +23°C.

^{*4} Compliance with CE Marking.

^{*5} 200V AC available with or without NEC specifications.

^{*6} Measurements are to be taken in an anechoic room at a height of 1.2m from the floor and a distance of 1m from the chamber front panel (ISO 1996-1:2003 _ A-weighted sound pressure level)

DIMENSIONS

unit:mm

● SU-222•242

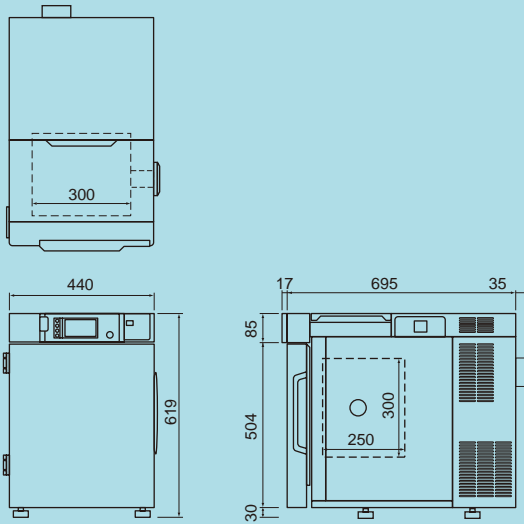

● SU-262

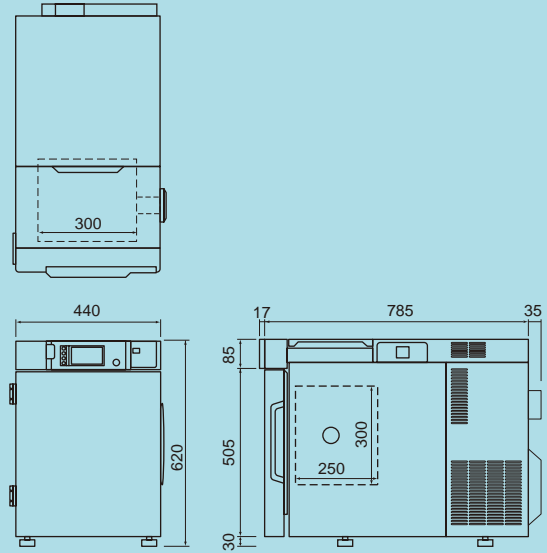

● SU-642•662

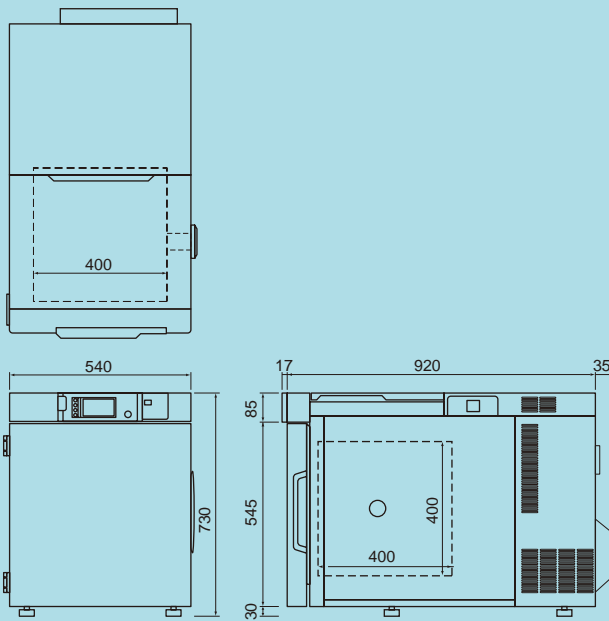

MODEL

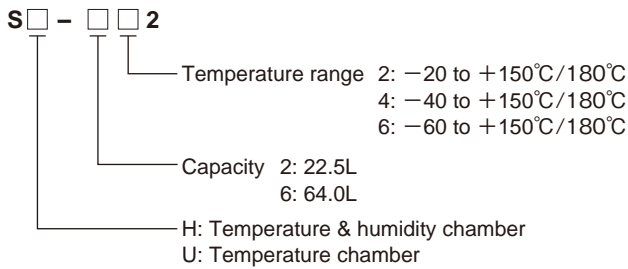

SAFETY DEVICES

- Control circuit overcurrent protection (except SH/SU-222, 242)
- Cartridge fuse for control circuit short-circuit protection
- System error (Error)
- Room temperature compensation burnout detection circuit
- Dry bulb temperature burnout detection circuit
- Absolute upper/lower temperature limit alarm (w/ built-in T/H controller)
- Temperature switch for air circulator
- Thermal fuse
- Temperature switch for condenser fan
- Overheat protector
- Wet bulb temperature burnout detection circuit (SH only)
- Refrigerator-1 error detection
- Refrigerator-2 error detection (except SH/SU-222, 242)
- Humidifier dry heat protector (SH only)
- Humidifier water level detection (SH only)
- Temperature upper limit deviation alarm (w/ built-in T/H controller)
- Absolute upper/lower humidity limit alarm (SH only) (w/ built-in T/H controller)
- System error (Alarm)
- Water tank drought switch (SH only)
- Chamber door switch
- Water tank low-level switch (SH only)
- Specimen power supply control terminal

FITTINGS

- Temperature (Humidity) recorder terminal
- Specimen power supply control terminal
- Alarm output terminal
- External output terminal
- Cable port (φ 50 mm × 1)
- Power cable
- Water supply tank (SH only)
- Humidifying tray drain plug (SH only)
- Drain hose
- Drain socket for water sensor box (SH only)
- Instrumentation interlock output terminal
- Instrumentation interlock input terminal

ACCESSORIES

- Shelf (Stainless steel)
Load capacity (evenly distributed)
SH/SU-222/242/262 0.5kg
SH/SU-642/662 5kg
- Max. number of shelves
SH/SU-222/242/262 5 stages (pitch 35mm)
SH/SU-642/662 5 stages (pitch 50mm)
- Connector (For temperature/humidity recorder terminals)
SH: 2/ SU: 1
- Cable port plug (rubber) 1 (φ 50 mm)
- Cartridge fuse
SH/SU-222, 242, 262 (B type, 250V 7A) 1
SH/SU-642, 662 (B type, 250V 7A, 6A) 1 of each
- Socket adapter
(100V, 115V 222, 242, 262 models only)
- Wet-bulb wick 1 box (SH only)
- Humidifying tray drain hose 2m 1 (SH only)
- Drain hose for water sensor box (0.3m) 1
- Operation manual 1 set



Safety precautions

- Do not use specimens which are explosive or inflammable, or which contain such substances. To do so could be hazardous, as this may lead to fire or explosion.
- Do not place corrosive materials in the chamber. If corrosive substances or liquid is used, the life of the unit may be significantly shortened specifically because of the corrosion of stainless steel, resin and silicone materials.
- Do not place life forms or substances that exceed allowable heat generation.
- Be sure to read the user's manual before operation.

OPTIONS

Viewing window



64L type

Effective view:

22.5L type: W215×H215 mm

64L type: W215×H315 mm

* Standard performance may not be met under certain conditions. Inquire for details.

Roof top viewing window

Effective view: W181×D107 mm

* Standard performance may not be met under certain conditions. Inquire for details.

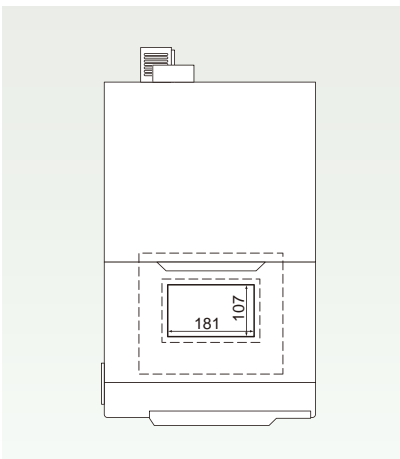

(Example) SH-242

Inner glass door

A glass door is provided between the test area and the chamber door with viewing window to observe specimens. The glass door is equipped with a wiper for models with humidity.

* Standard performance may not be met under certain conditions. Inquire for details.

Hand-in port

Equip the chamber with hand-in port to manipulate specimen under test.

<For inner glass door>

$\phi 130\text{mm} \times 1$, at the center of the inner glass door.

<For chamber side wall>

$\phi 130\text{mm} \times 1$ (select left or right side)

Any hand-in port selected comes with radial rubber seal.

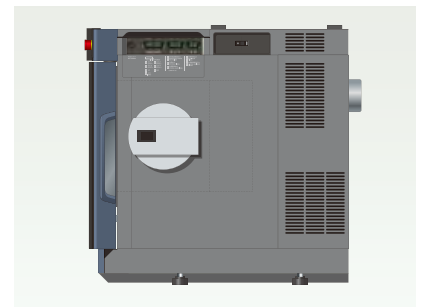

Additional cable port

Provided in addition/ replacement of the standard cable port (right side, $\phi 50\text{mm}$).

Available location:

- Left side, right side
- Ceiling

Available dimensions:

- $\phi 25\text{ mm}$
- $\phi 50\text{ mm}$
- $\phi 100\text{ mm}$
- flat cable port (W100×H25 mm)

* Comes with a rubber plug and a cap.

* Standard performance may not be met under certain conditions. Inquire for details.

● Additional cable port location

(SH/SU-222·242·262)

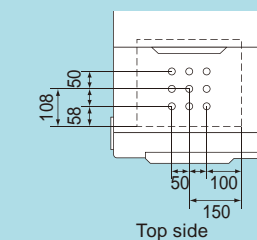

Top side

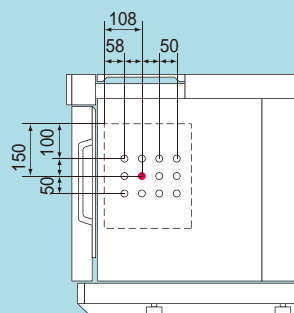

Right side

* Same location points for left side

(SH/SU-642·662)

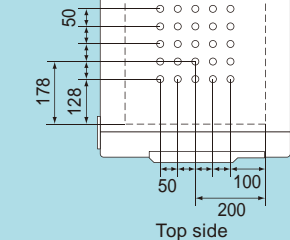

Top side

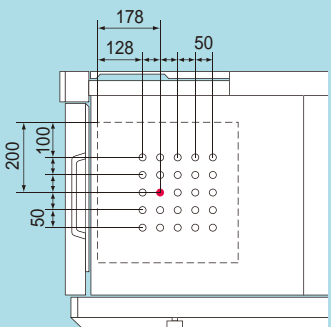

Right side

* Same location points for left side

● Standard equipped

OPTIONS

Cable port rubber plug

Comes with the cable port.

- for $\phi 25$ mm
- for $\phi 50$ mm
- for $\phi 100$ mm
- spiral-wrapped plug (5×50×2000 mm)
- for flat cable port

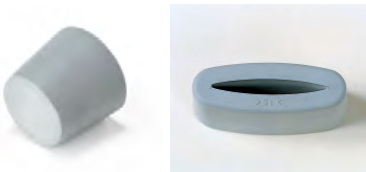

for $\phi 50$ mm

for flat cable port



spiral-wrapped plug

Cable port plug w/ embedded terminals

<Available from Jan. 2014>

Cable port plug with embedded terminals (inside and outside) to ease specimen connection to an external device.

Web camera

<Available from Jan. 2014>

Web camera installed inside the test area to observe specimen, either from the controller itself, or on a PC networked with the chamber.

Web camera connecting terminals

<Available from Jan. 2014>

Terminals prepared to receive a web camera (not provided - compatible models limited), to be displayed on controller screen or a PC networked with the chamber.

Continuous water supply

Equips the chamber with a connection for water supply system. Select either direct coupling to tap water, or a connection port, with or without pressure-reducing valve.

Roof top water tank

An additional tank that supplements the volume of the standard cartridge tank is provided to carry out continuous operation.

Effective water volume: 5L

Location: Chamber ceiling

* The connection port without pressure-reducing valve is required when selecting this option.

Automatic water refill

Automatically refill water to the humidifying tray and the wick pan periodically.

Chamber dew tray

Prevents water leaks from the chamber onto the floor.

Shelf

Same as standard shelf.

18-8 Cr-Ni Stainless steel



SH/SU-222, 242, 262



SH/SU-642, 662

	20L type	60L type
Effective dimensions	W284 H34 D231 mm	W392 H21 D378 mm
Load capacity	0.5 kg	5 kg

Specimen basket

For small specimens that cannot be placed on the shelf.

Material: 18-8 Cr-Ni Stainless steel

Dimensions: W206×H40×D156 mm

* Place the specimen on the shelf.

* Do not use when exceeding the shelf load capacity.



OPTIONS

I/O interface

Communication ports to connect the chamber to a PC.

- RS-485
- RS-232C
- GPIB

Communication cables

- RS-485 5m/10m/30m
- RS-232C 1.5m/3m/6m
- GPIB 2m/4m

Airflow adjuster

Used when tests require low airflow velocity or constant velocity.
Setting value range: 4 levels.



Specimen temperature control

Sensors are attached to the specimen to allow exposure tests that provide temperature stress to the specimen.

- Insulated type

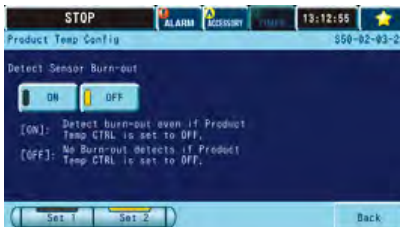

Option box

Box prepared to install additional options such as:

- Paperless recorder (stand embedded)
- External output terminal set (x3)
- Specimen temperature control
- Program-synched DC power supply

The option box can be embedded on a stand (Refer to stand configuration page 20), or standalone (for example, put on the chamber top free space, etc.)



Option box B (stand-embedded paperless recorder)

External output terminal set (×3)

The following contact signals are installed on the option box, or stand with option box.

- Time up output terminal
Enables power supply and/or temperature measurement of the specimen synchronised with the timer.
- Time signal terminal
Add up to 10 signal terminals to the 1 equipped as standard.
- Temp. & humid. SP attainment output
Sends out a contact signal when the chamber reaches temperature (humidity) set values.

* The option box is required when selecting this option.

Program-synched DC power supply

Capable of applying voltage to the specimen, used for bias testing. The DC power supply unit synchronizes with constant program operations, and can be set for each temperature and humidity program step.

- 5V
- 12V
- 15V
- 24V
- 48V



OPTIONS

Paperless recorder

Records the temperature and humidity of each section such as the temperature inside the chamber.

Sampling interval: 5 sec. (default)

Internal recording media:

Flash memory 4MB

External recording media:

CF memory card port

(Includes a 256 MB CF card)

USB memory port

< Temperature & humidity type >

No. of inputs:

Temperature 1, Humidity 1

(4 more channels can be turned ON)

< Temperature type >

No. of inputs:

Temperature 1

(5 more channels can be turned ON)

- Portable type
- Installed on the option box



Temperature (humidity) recorder

Records the temperature and humidity of each section such as the temperature inside the chamber.

Recording method: Dot

Recording paper: Effective width 100 mm

No. of inputs:

< Temperature & humidity type >

Temperature 5, Humidity 1

SRJ12 -50 to +150°C/0 to 100% rh

SRJ14 -100 to +150°C/0 to 100% rh

SRJ15 -100 to +200°C/0 to 100% rh

< Temperature type >

Temperature 6

SRJ25 -100 to +200°C

Wet-bulb temperature recorder output terminal

This terminal outputs the test area wet bulb temperature.

* SH type only.

Thermocouple

Attached to specimen to measure specimen temperature.

Thermocouple with a brass ball tip

Thermocouple type T (Copper/ Copper-Nickel)

- 2m
- 4 m
- 6 m



Wet-bulb wick

Same as the standard accessory.

1 box (24 wicks, 1 dropper)



OPTIONS

Overcool protector

If the temperature inside the chamber decreases excessively, the chamber stops operating to prevent the specimens from being damaged.

External device alarm input terminal

Equips the chamber with a terminal that is used to stop operation of the chamber in the event that an external device linked to the chamber malfunctions.

Door opening signal output terminal

Equips the chamber with a terminal that outputs the door open status. Capable of controlling an external device that operates along with door operation and records the temperature disturbance history.

Emergency stop pushbutton

Stops the chamber immediately. Available with or without guard.



With guard

Noise reduction rear side cover

A cover is added on the rear side of the chamber to help:

- lower further chamber noise
- direct exhaust air toward the ceiling
- store wires in order inside the cover

Wires cover

<Available from Jan. 2014>

Power plug

Power plug for China.
3 cores/ round type

Operation manual

- CD
- Booklet

Reports & certificates

- Testing and inspection report
- Test data
- Temperature (& humidity) uniformity measurement
- Calibration report
- Calibration certificate
- Traceability system chart
- Traceability certificate

Stand variation (option)

Stands equipped with casters for easy transfer or transportation. (leveling feet provided)
 Choose among 3 sizes: C (Dolly type), L (Low type) or H (High type)

Dimensions : mm For SH/SU-642·662 (For 222·242·262)

H type

The C type stand fits on the lower part.

Chamber with L stand can fit under the H stand.

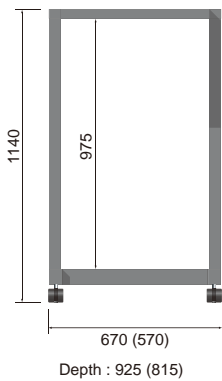

· With shelf

Move the shelf to install instrumentation or measurement devices.

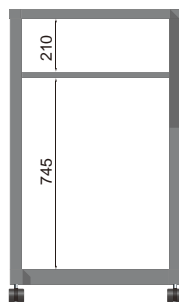

Shelf size : W577xD900
(W473xD790)

· With option box

Following options can be installed.

- Paperless recorder
- Output terminal set
- Specimen temperature control
- Program-synched DC power supply

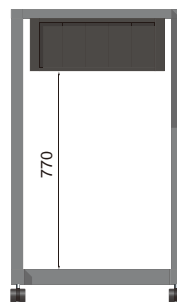

· With 19 inch rack

19 inch size instrumentation or controller can be set to the rack.

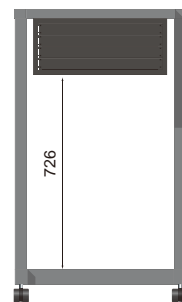

L type

· With water supply and drain port

Release in Jan.2014



· With shelf

shelf : adjustable 3 pitches

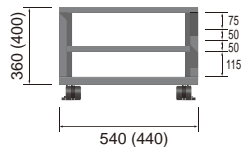

Shelf size : W480xD850 (W378xD740)
Depth : 860 (750)

· With option box

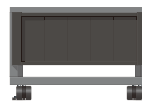

· With 19 inch rack

19 inch size instrumentation or controller can be set to the rack.

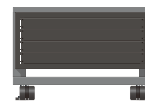

C type

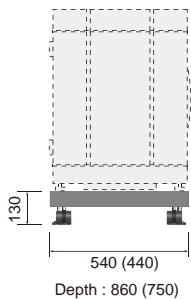

Stand configuration (example)

· H type with 19 inch rack and C type



· H type and L type with option box



* For safety reasons, make sure to secure the chamber and the stand together with anchoring fixtures. We also recommend to fix the stand itself to the floor.
 * Please inquire for 2-stage stacked chambers.

Scalability (Example)

Sub-door

Sub-door with embedded BNC connectors.

- Allow preparation of specimen beforehand. (at your desk)
- Reduce the time for specimen change.

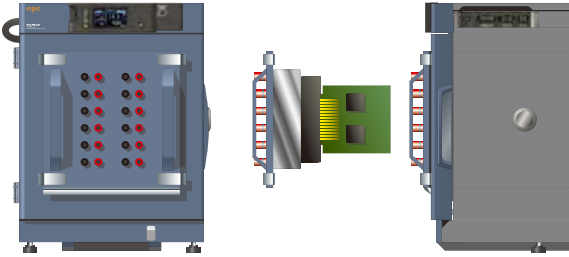

PC-less measurement system

Connect specimen for bias testing.

- Power supply for specimen in-sync with the chamber without a PC.
- Can be in-sync with temperature as well.
- Cable port plug with embedded terminals.
- Program-synched DC power supply.
- Paperless recorder.

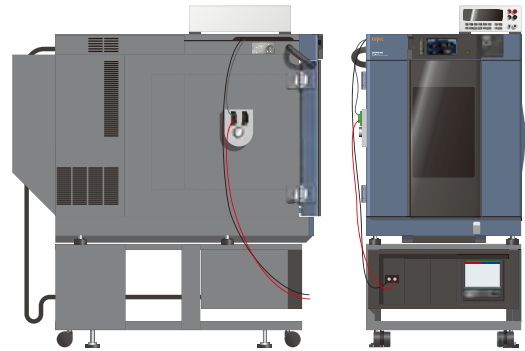

Stacked model

2-stacked chamber model

- Efficient arrangement for QA evaluation, etc., where numerous chambers are requested.
- Operation via PC or tablet, equipment networking.
- For humidity type, continuous water supply is equipped.
- Because chambers are independent, can be used for manual thermal shock testing.



Battery charge / discharge testing

- Options prepared for battery testing, like safety doorlock, pressure relief vent, heat detector, gas detector, etc.
- All necessary features are prepared as one package for all units, offering a reduced total cost.

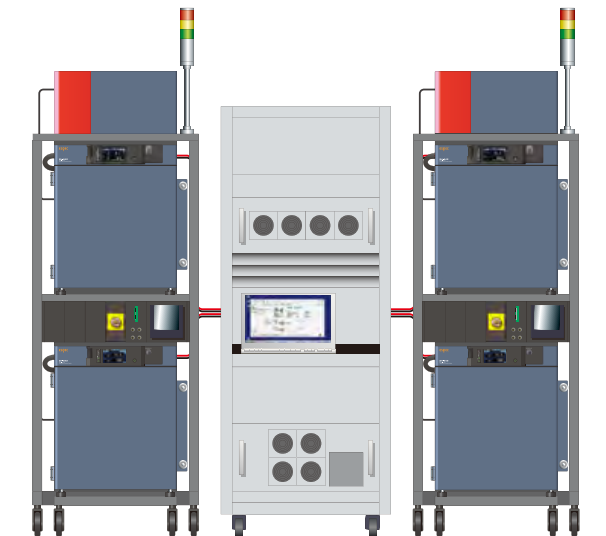

ESPEC CORP. <http://www.espec.co.jp/english>

Head Office

3-5-6, Tenjinbashi, Kita-ku, Osaka 530-8550, Japan
Tel: 81-6-6358-4741 Fax: 81-6-6358-5500

ESPEC NORTH AMERICA, INC.

Tel: 1-616-896-6100 Fax: 1-616-896-6150

ESPEC EUROPE GmbH

Tel: 49-89-1893-9630 Fax: 49-89-1893-96379

ESPEC ENVIRONMENTAL EQUIPMENT (SHANGHAI) CO., LTD.

Head Office

Tel: 86-21-51036677 Fax: 86-21-63372237

BEIJING Branch

Tel: 86-10-64627025 Fax: 86-10-64627036

TIANJIN Branch

Tel: 86-22-26210366 Fax: 86-22-26282186

GUANGZHOU Branch

Tel: 86-20-83317826 Fax: 86-20-83317825

SHENZHEN Branch

Tel: 86-755-83674422 Fax: 86-755-83674228

SUZHOU Branch

Tel: 86-512-68028890 Fax: 86-512-68028860

ESPEC TEST TECHNOLOGY (SHANGHAI) CO., LTD.

Tel: 86-21-68798008 Fax: 86-21-68798088

ESPEC SOUTH EAST ASIA SDN.BHD.

Tel: 60-3-8945-1377 Fax: 60-3-8945-1287



ISO 9001/JIS Q 9001

Quality Management System Assessed and Registered

ESPEC CORP. has been assessed by and registered in the Quality Management System based on the International Standard ISO 9001:2008 (JIS Q 9001:2008) through the Japanese Standards Association (JSA).

* Registration : ESPEC CORP.
(Overseas subsidiaries not included)

ISO 14001 (JIS Q 14001)

Environmental Management System Assessed and Registered

ESPEC CORP.