



Errata

Title & Document Type: 3326A Two Channel Synthesizer Operating Manual

Manual Part Number: 03326-90000

Revision Date: September 1984

HP References in this Manual

This manual may contain references to HP or Hewlett-Packard. Please note that Hewlett-Packard's former test and measurement, semiconductor products and chemical analysis businesses are now part of Agilent Technologies. We have made no changes to this manual copy. The HP XXXX referred to in this document is now the Agilent XXXX. For example, model number HP8648A is now model number Agilent 8648A.

About this Manual

We've added this manual to the Agilent website in an effort to help you support your product. This manual provides the best information we could find. It may be incomplete or contain dated information, and the scan quality may not be ideal. If we find a better copy in the future, we will add it to the Agilent website.

Support for Your Product

Agilent no longer sells or supports this product. You will find any other available product information on the Agilent Test & Measurement website:

www.tm.agilent.com

Search for the model number of this product, and the resulting product page will guide you to any available information. Our service centers may be able to perform calibration if no repair parts are needed, but no other support from Agilent is available.

*HP 3326A
OPERATING MANUAL
SUMMARY*

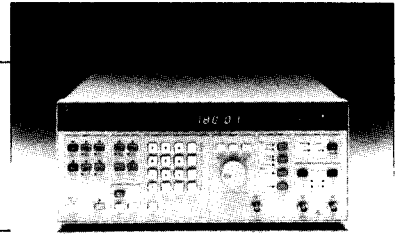

INSTALLATION *Installation Manual*—This manual contains information for preparing the HP 3326A for initial use after delivery. The information includes initial inspection procedures, selecting and setting the HP 3326A line voltage, options and accessories lists, installation procedures, HP 3326A HP-IB system installation procedures, and packing the HP 3326A for storage and shipment.

APPLICATION *Introductory Operating Guide*—This guide contains initial operating and application information. In addition to an operational and functional overview, it illustrates the usefulness and performance of the HP 3326A in making common measurements.

HP-IB INTRODUCTION *HP-IB Introductory Operating Guide*—This guide illustrates the basic techniques for operating the HP 3326A with an HP Series 200 computer.

HP-IB SUMMARY *HP-IB Quick Reference Guide*—This guide summarizes the HP 3326A HP-IB information.

HP 3326A OPERATION *Operating and Reference Manual*—This manual contains detailed operating information for the HP 3326A. Chapter I, "Operation and Reference," contains details for operating the HP 3326A with the front panel. Chapter II, "HP-IB Operation," and Chapter III, "HP 3326A HP-IB Commands," contain details for operating the HP 3326A with a controller via the HP-IB. Appendix A, "Error Messages," describes the error messages that appear in the HP 3326A display. Appendix B, "Specifications," summarizes the operating characteristics of the HP 3326A. Appendix C, "Quick Reference," contains abbreviated operating information for the HP 3326A.

Installation — Table of Contents

INITIAL INSPECTION	1
POWER REQUIREMENTS	1
LINE VOLTAGE SELECTION	1
POWER CABLE AND GROUNDING REQUIREMENTS	3
OPTIONS	4
ACCESSORIES SUPPLIED	4
ACCESSORIES AVAILABLE	5
OPERATING ENVIRONMENT	5
INSTRUMENT COOLING	5
INSTALLATION	6
HP-IB SYSTEM INTERFACE CONNECTIONS	8
HP-IB ADDRESS	10
STORAGE AND SHIPMENT	10

HP 3326A INSTALLATION MANUAL

This Installation manual contains instructions for installing and interfacing the HP 3326A Synthesizer. Included are initial inspection procedures, power and grounding requirements, operating environment, available accessories and options, installation instructions, HP-IB interfacing procedures, and instructions for repacking and shipping.

INITIAL INSPECTION

The HP 3326A was carefully inspected both mechanically and electrically before shipment. It should be free of marks or scratches and in perfect electrical order upon receipt. To confirm this, inspect the HP 3326A for physical damage incurred in transit. If the HP 3326A was damaged in transit, file a claim with the carrier. Check for supplied accessories (listed in this chapter) and test the electrical performance using the Operational Verification tests in the Service Manual. If there is damage or deficiency, see the warranty in the front of the Operating and Reference Manual.

WARNING

The integrity of the protective earth ground may be interrupted if the HP 3326A is mechanically damaged. Under no circumstances should the HP 3326A be connected to power if it is damaged.

POWER REQUIREMENTS

CAUTION

Before applying ac line power to the HP 3326A, ensure the voltage selector on the HP 3326A rear panel is set for the proper line voltage and the correct line fuse is installed in the fuse holder. Procedures for changing the line voltage selector and fuse are contained in the following section for "Line Voltage Selection."

The HP 3326A can operate from any single phase ac power source supplying 100 V, 120 V, 220 V or 240 V (– 10% to + 5%) in the frequency range from 48 to 66 Hz (see Figure 1). With all options installed, power consumption is less than 290 VA when on, and less than 100 VA in standby.

LINE VOLTAGE SELECTION

The line voltage selector is set at the factory to correspond to the most commonly used line voltage of the country of destination. The line voltage selected for the HP 3326A

is indicated on the line voltage selector. Refer to Figure 1 for the line voltage ranges and Figure 2 for setting the line voltage and selecting the appropriate fuse. To change the line voltage and fuse:

- Remove the power cord.
- Pry open the power selector cover with a small screwdriver.
- To check or replace the fuse, pull the white fuse holder out of the power selector and remove the fuse from the fuse holder.
- To reinstall the fuse, insert a fuse with the proper rating into the fuse holder. Align the white arrow on the top of the fuse holder with the two white arrows on the power selector cover. All three white arrows should point in the same direction. Push the fuse holder into the power selector.
- To change the line voltage, remove the cylindrical line voltage selector.
- Reinstall the cylindrical line voltage selector and ensure the required voltage label is facing out of the power selector.
- Close the power selector by pushing firmly on the black cover.
- Check that the correct line voltage appears through the window in the power selector cover.

Selector Voltage	Voltage Range
100	90-105V
120	108-126V
220	198-231V
240	216-252V

Figure 1. Line Voltage Ranges

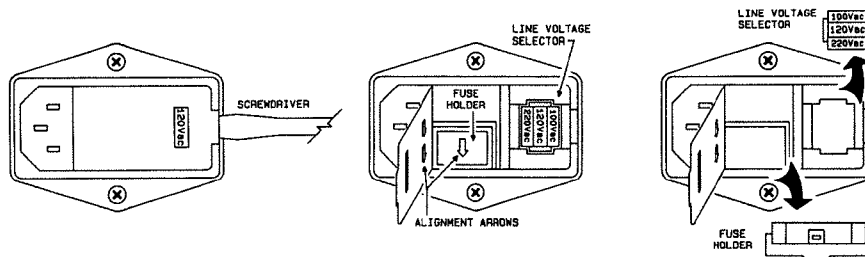

CAUTION

Remove line voltage selector to change voltage. Rotating selector without removing will damage the module.

Line Setting	Fuse Type	HP Part Number
110 V/120 V	3 A 250 V NORMAL BLOW	2110-0003
220 V/240 V	2 A 250 V NORMAL BLOW	2110-0002

Figure 2. Line Voltage and Fuse Selection

POWER CABLE AND GROUNDING REQUIREMENTS

The HP 3326A is equipped with a three-conductor power cord which, when plugged into an appropriate receptacle, grounds the HP 3326A cabinet. The type of power cable plug shipped with each instrument depends on the country of destination. Refer to Figure 3 for the part number of the power cable and plug configurations available.

WARNING

The power cable plug must be inserted into a socket outlet provided with a protective earth terminal. Defeating the protection of the grounded instrument cabinet can subject the operator to lethal voltages.

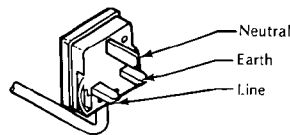

PLUG*: BS 1363A
CABLE*: HP 8120-1703

250 V
OPERATION

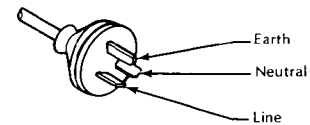

PLUG*: NZSS 198/AS C112
CABLE*: HP 8120-0696

250 V
OPERATION

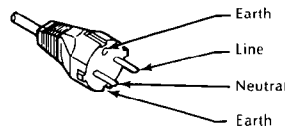

PLUG*: CEE7-V11
CABLE*: HP 8120-1692

250 V
OPERATION

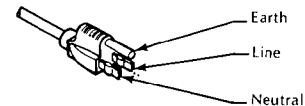

PLUG*: NEMA 5-15P
CABLE*: HP 8120-1521

125 V-6A**

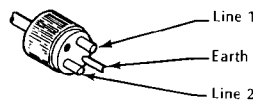

PLUG*: NEMA 5-15P
CABLE*: HP 8120-0698

250 V - 6A**

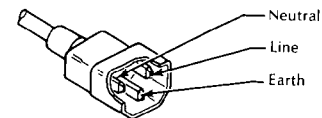

PLUG*: CEE7-V11
CABLE*: HP 8120-1692

250 V
OPERATION

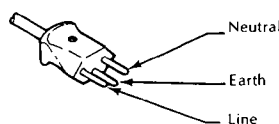

PLUG*: SEV 1011.1959-24507
TYPE 12
CABLE*: HP 8120-2104

250 V
OPERATION

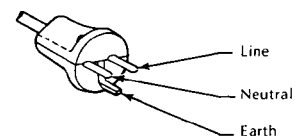

PLUG*: DHCR 107
CABLE*: HP 8120-2956

250 V
OPERATION

Figure 3. Power Cables

OPTIONS

Figure 4 lists the options available for the HP 3326A. These options are available when the instrument is ordered by specifying the option number, or are available for later installation by ordering the option part number.

HP 3326A Option	HP Part Number	Description
001	03326-91001	High Stability Frequency Reference
002	03326-91002	High Voltage Output
003	03326-91003	Rear Panel Outputs
907	5061-0090	Front Handle Kit
908	5061-0078	Rack Flange Kit
909	5061-0084	Rack Mount Flange Kit with Handles
910	03326-90000	Extra Operating Manual

Figure 4. Options

ACCESSORIES SUPPLIED

Figure 5 lists the accessories supplied with the HP 3326A. Additional Operating and Service manuals may be ordered through your HP Sales and Service Office.

NOTE

The Service Manual is not included with the HP 3326A if Option 914 is requested. Option 914 is a delete option for the service manual.

Description	Quantity	HP Part Number
Operating Manual	1 ea.	03326-90000
Service Manual	1 ea.	03326-90010

Figure 5. Accessories Supplied

The HP 3326A is also equipped with a thermal cutout switch which automatically puts the HP 3326A in standby whenever the internal temperature is excessive. The temperature at which this occurs is dependent upon line voltage and airflow. With proper airflow and operating line voltage, thermal cutout will not occur at less than a 65° C ambient temperature. The switch resets automatically when the HP 3326A cools. If a thermal cutout occurs, disconnect the power cord and check for fan stoppage, clogged fan ports, clogged filter, or other conditions that can obstruct airflow or otherwise cause excessive heating.

NOTE

The thermal cutout may operate at external temperatures below 65° C if the airflow is blocked or line voltage is near the upper voltage limits.

INSTALLATION

The HP 3326A is shipped with plastic feet in place, ready for use as a portable bench instrument. The plastic feet are shaped to make full width modular instruments self align when they are stacked. The clearances provided by the plastic feet in bench stacking and the filler strip in rack mounting allow air passage across the top and bottom cabinet surfaces.

A front handle kit can be installed for ease of handling the HP 3326A on the bench. The part number for the front handle kit is listed in Figure 6.

Option 908 (Rack Mount Flange Kit) and 909 (Rack Mount Flange Kit with Handles) enable the HP 3326A to be mounted in an equipment cabinet. The rack mount for the HP 3326A is EIA standard width of 482.6 mm (19 inches). To install the HP 3326A in an equipment cabinet:

- If installed, remove the plastic trim (Figure 8) and front handles from the HP 3326A.
- Remove the plastic feet from the bottom of the HP 3326A.
- Install the rack flange kit with or without handles according to instructions included with the kit. (Kit part numbers are listed in Figure 6.)

NOTE

The rack mount flange kit of Option 908 will not provide the space requirement for rack mounting when used with the front handle kit of Option 907. If front handles are not available, use the combination kit of Option 909 to rack mount with handles. If Option 907 front handles are available, use Rack Mount Flange Kit, HP part number 5061-2072 to add rack mounting.

- Install an instrument support rail on each side of the instrument cabinet. (The instrument support rails, used to support the weight of the instrument, are included with HP instrument cabinets.)

WARNING

The HP 3326A is heavy (approximately 27 kg, 60 lbs.). Use extreme care when lifting it to avoid personal injury. The weight of the HP 3326A must be supported by instrument support rails inside the instrument cabinet. Do not, under any circumstances, attempt to rack mount the HP 3326A using only the front flanges.

- Using two people, lift the HP 3326A to its position in the cabinet on top of the instrument support rails.
- Using the appropriate screws, fasten the HP 3326A rack mount flanges to the front of the instrument cabinet.

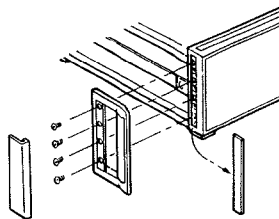

HANDLE KIT, BENCH OPERATION

5061-0090
OPTION 907

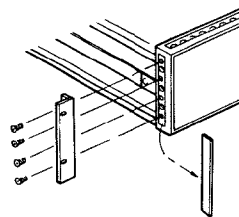

RACK MOUNT FLANGE KIT

5061-0078
OPTION 908

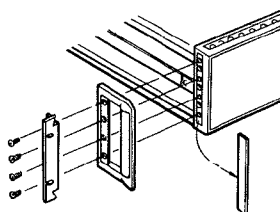

RACK MOUNT FLANGE/FRONT HANDLE KIT

5061-0084
OPTION 909

Figure 8. Rack Mount and Handle Kits

HP-IB SYSTEM INTERFACE CONNECTIONS

The HP 3326A instrument is compatible with the Hewlett-Packard Interface Bus (HP-IB). The HP-IB is Hewlett-Packard's implementation of IEEE Standard 488-1978 and ANSI Standard MC 1.1. The HP 3326A is connected to the HP-IB by connecting an HP-IB interface cable to the connector located on the rear panel. Figure 9 illustrates a typical HP-IB system interconnection.

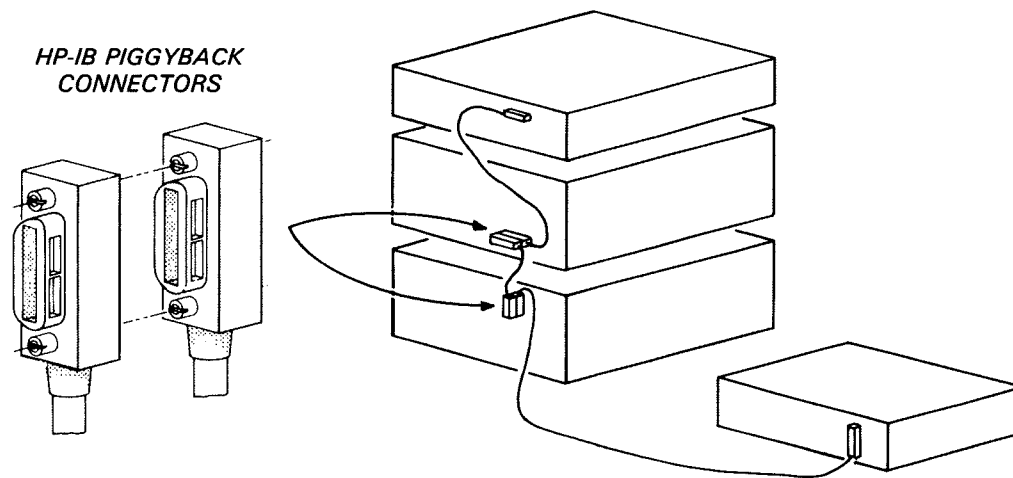
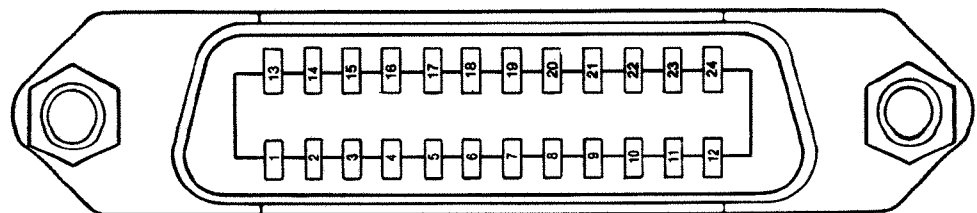

Figure 9. Typical HP-IB System Interconnection

With the HP-IB system, up to 15 HP-IB compatible instruments can be interconnected. The HP 10833 HP-IB cables have identical piggy-back connectors on each end so that several cables can be connected to a single source without special adapters or switch boxes. System components and devices can be connected in virtually any configuration. There must, of course, be a path from the controller to every device operating on the bus. As a practical matter, avoid stacking more than three or four cables on any one connector. If the stack gets too long, any force on the stack can damage the connector mounting. Be sure that each connector is firmly screwed in place to keep it from working loose during use (see CAUTION in Figure 10). The HP 3326A uses all the available HP-IB lines, therefore, any damaged connector pins may adversely affect HP-IB operation. Refer to Figure 10 for a description of the HP-IB connector.



CAUTION

The HP 3326A contains metric threaded HP-IB cable mounting studs as opposed to English threads. Metric threaded HP 10833A, B, C or D HP-IB cable lock screws must be used to secure the cable to the instrument. Identification of the two types of mounting studs and lock screws is made by their color. English threaded fasteners are colored silver and metric threaded fasteners are colored black. DO NOT mate silver and black fasteners to each other or the threads of either or both will be destroyed. Metric threaded HP-IB cable hardware illustrations and part numbers follow.

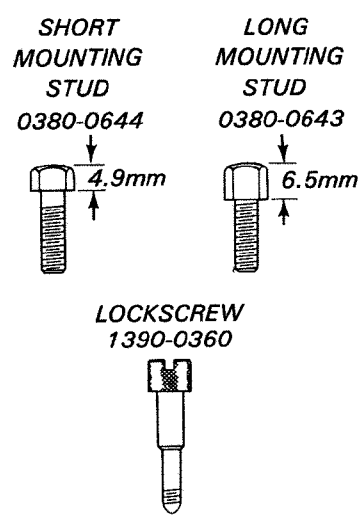

PIN	LINE
1	D101
2	D102
3	D103
4	D104
13	D105
14	D106
15	D107
16	D108
5	DO1
17	REN
6	DAV
7	NRFD
8	NDAC
9	IFC
10	SRQ
11	ATN
12	SHIELD - CHASSIS GROUND
18	P/O TWISTED PAIR WITH PIN 6
19	P/O TWISTED PAIR WITH PIN 7
20	P/O TWISTED PAIR WITH PIN 8
21	P/O TWISTED PAIR WITH PIN 9
22	P/O TWISTED PAIR WITH PIN 10
23	P/O TWISTED PAIR WITH PIN 11
24	ISOLATED DIGITAL GROUND

HP-IB Interconnect Cables	
Part Number	Length
10833A	1 m (3.3 ft)
10833B	2 m (6.6 ft)
10833C	4 m 13.2 ft)
10833D	0.5 m (1.6 ft)

Figure 10. Interfacing the HP-IB

To achieve design performance with the HP-IB, proper voltage levels and timing relationships must be maintained. If the system cable is too long, the lines cannot be driven properly and the system will fail to perform (see Figure 10 for HP-IB cable lengths). Therefore, when interconnecting an HP-IB system, it is important to observe the following rule:

Total cable length for the system must be less than or equal to 20 meters (65 feet) or 2 meters (6 feet) times the total number of devices connected to the bus, whichever is less.

HP-IB ADDRESS

The HP 3326A has a factory selected address of 18. The HP-IB address of the HP 3326A is stored in a nonvolatile memory (there are no address switches). Every device on the HP-IB must have a unique address. The HP 3326A address can be set at any address between 0 and 30, inclusive. When selecting an address, remember that the controller also has an address (usually 21). To view or change the HP-IB address:

- Press the blue SHIFT key followed by the LOCAL key in the HP-IB STATUS block to display the HP-IB address.
- Enter the address with the numeric keypad. For two digit HP-IB addresses, the address is set when the second digit is entered. For one digit HP-IB address, the address is set when any units key is pressed. Alternately, a zero can precede the single digit to form a two digit address.
- The message "Error 20 RNGE" is displayed if the HP-IB address exceeds 30.

STORAGE AND SHIPMENT

The HP 3326A should be stored in a clean, dry environment. The following are environmental limitations that apply to both storage and shipment:

Temperature -40° C to +75° C
Humidity Up to 95%
Altitude Up to 15,300 meters
(50,000 feet)

The HP 3326A should also be protected from temperatures or temperature changes which cause condensation within the instrument.

Containers and materials identical to those used in factory packaging are available through Hewlett-Packard offices. If the instrument is being returned to Hewlett-Packard for service, attach a tag indicating the type of service required, return address, model number, and full serial number. Also, mark the container FRAGILE to ensure careful handling. In any correspondence, refer to the instrument by model number and full serial number.

The following general instructions should be used for repacking with commercially available materials:

- Wrap the instrument in heavy paper or anti-static plastic. If shipping to a Hewlett-Packard office or service center, attach a tag to the instrument indicating type of service required, return address, model number, and full serial number.
- Use a strong shipping container. A double-wall carton made of 350-pound test material is adequate.
- Use a layer of shock absorbing material 70 to 100 mm (3 to 4 inch) thick around all sides of the HP 3326A to provide firm cushioning and prevent movement inside of the container. Protect the control panel with cardboard.

CAUTION

Styrene pellets in any shape should not be used as packing material. The pellets do not adequately cushion the instrument and do not prevent the instrument from shifting in the carton. The pellets also create static electricity which can damage electronic components.

- Seal shipping container securely.
- Mark shipping container FRAGILE to ensure careful handling.
- In any correspondence, refer to the instrument by model number and full serial number.



Printed in USA



**HEWLETT
PACKARD**

PIO 03325-90000

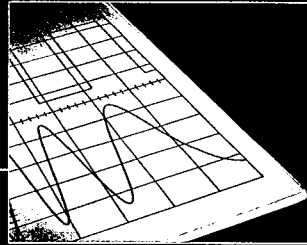
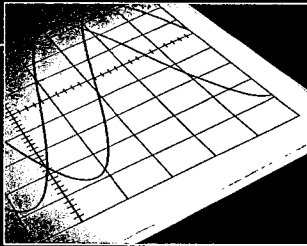
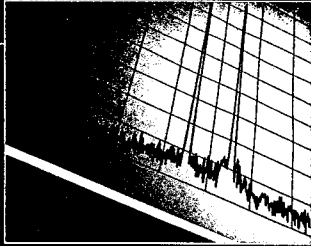
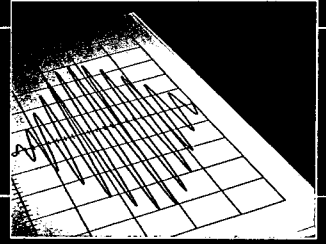

INTRODUCTION

Two or more signals are commonly required in ATE systems, intermodulation and signalling applications and for generation of a phase offset. In the past, two separate signal sources were commonly required to produce these signals. In many cases, additional equipment such as a phase meter or oscilloscope was needed if calibration was important. The use of two separate sources increased equipment complexity and added to measurement difficulty. The Hewlett-Packard 3326A is a solution to these problems in a single instrument. The HP 3326A combines two synthesized sources to form a synergistic pair that solves these problems and provides the user with a powerful set of new measurement capabilities and convenience.

This introductory operating guide describes the basic capabilities and operation of the HP 3326A, addresses many applications and illustrates ways in which this Two-Channel Synthesizer can help simplify measurements.

Chapter 1 describes the main features while Chapter 2 familiarizes the reader with the controls and connectors of the front and rear panels. Chapters 3, 4 and 5 describe basic keystrokes and applications for the Two-Channel, Two-Tone, and Two-Phase modes of operation, respectively. A complete listing of error codes can be found in Appendix A.



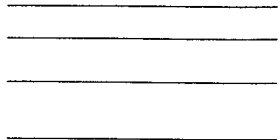

TABLE OF CONTENTS

Introduction	1
Purpose And Scope	
1. The HP 3326A	6
What Is The HP 3326A?	
The Two-Channel Mode	
The Two-Tone Mode	
The Two-Phase Mode	
The Pulse Mode	
Waveform Functions	
Modulation	
Frequency Sweep	
2. Instrument Familiarization	16
Front Panel Tour	
Rear Panel Connections	
3. Two-Channel Mode Operation And Applications	20
Getting Started	
Swept Mixer Measurements	
Phase-Locked Loop Testing	
4. Two-Tone Mode Operation and Applications	32
Getting Started	
Swept Two-Tone Intermodulation Distortion	
Sequential Tone Signaling	
5. Two-Phase Mode Operation And Applications	42
Getting Started	
Servo System Stability	
Track-And-Hold Settling Time	
Balanced Output	
Phase Detector Testing	
Phased Array Steering	
Multiple Phase Operation	
Appendix A. Error Messages	58

1. THE HP 3326A

THE HP 3326A

What Is The HP 3326A?

The HP 3326A is a Two-Channel Synthesizer, which combines two dc-to-13 MHz synthesizers into one instrument as shown in the simplified block diagram, Figure 1.1. It provides the user with a better solution to today's complex signal needs by reducing the number of instruments required while providing new high performance capabilities and measurement versatility. Microprocessor control of both synthesizers maintains simultaneous control of each source while simplifying operation. The microprocessor also provides internal and external calibration, coordinated sweeping of both outputs, and HP-IB* capabilities.

• What's Unique About The HP 3326A?

First, the HP 3326A has four modes of operation which determine the relationship between the Channel A and B outputs; Two-Channel, Two-Tone, Two-Phase and Pulse. The Channel A and B outputs can be combined into a single composite output signal at Channel A in the first three modes, or Channel B can be used to internally amplitude or phase modulate Channel A in the Two-Channel mode. The Pulse mode is derived from the Two-Phase mode and operation is similar.

Sweep capabilities include phase continuous sweep of both channels as well as a powerful new Discrete Sweep for random frequency sweeps. The HP 3326A provides 1 μ Hz resolution below 100 kHz and 1 mHz from 100 kHz to 13 MHz. Amplitude resolution is 0.01 dB. Let's look at some of these unique features in more detail.

• A Clean Signal Source

Sinusoidal signals have harmonic and spurious content of less than -80 dBc below +13 dBm and 100 kHz as shown in Figure 1.2. The spurious content is -70 dBc at maximum output level and frequency. Integrated residual phase noise (with Option 001) is specified at -66 dBc for a 30 kHz band centered on a 10 MHz carrier (excluding a ± 1 Hz band centered about the carrier). Internal sinusoidal channel isolation is -80 dB so that channel crosstalk effects are minimized for excellent signal integrity.

Figure 1.1
Simplified HP 3326A block diagram.

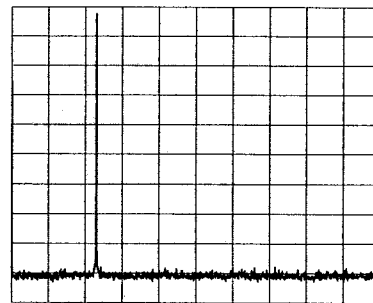
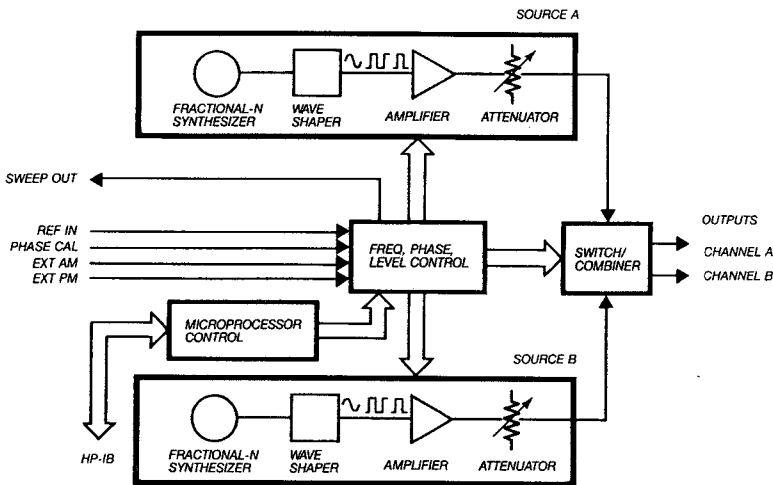

Figure 1.2
Low harmonic and spurious levels.

*HP-IB; not just IEEE-488, but the hardware, documentation and support that delivers the shortest path to a measurement solution.

The Two-Channel Mode

In the Two-Channel mode, the HP 3326A functions as two separate dc-to-13 MHz synthesized sources, with independent frequency, amplitude and waveform control for Channels A and B as shown in Figures 1.3a and 1.3b. Either or both channels can be swept separately with independent start and stop frequencies. Modulation capabilities include external AM and PM for each channel. In addition, internal AM and PM are available for Channel A using the Channel B output as a calibrated modulation source. The Two-Channel mode is particularly useful in applications requiring two independent signals with a synchronous relationship to a common frequency reference. Chapter 3 describes Two-Channel operation and applications in more detail.

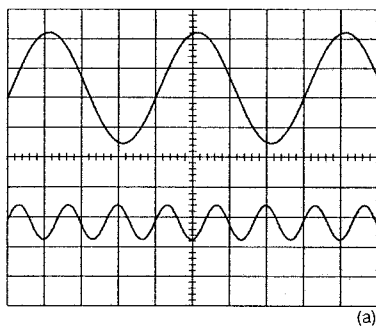

Figure 1.3
(a) Time domain and (b) frequency domain of two signals using the Two-Channel mode.

The Two-Tone Mode

The Two-Tone mode is useful for intermodulation distortion testing and signaling applications as covered in Chapter 4. In this mode, the output frequencies of both the Channel A and B signals can be set from dc to 13 MHz, but the frequency difference between the two signals must be within 100 kHz of each other.

An example is illustrated in Figure 1.4a and 1.4b. Both the Channel A and Channel B frequencies can be independently swept within this relationship. Setting the Channel A frequency (with sweep off) automatically alters the frequency of Channel B to maintain a constant offset in the Two-Tone mode.

This signal pair can be produced with one signal at each channel output, or combined into one composite signal at the Channel A output connector. Signal amplitudes and waveforms can be independently selected as in the Two-Channel mode and external modulation can be applied.

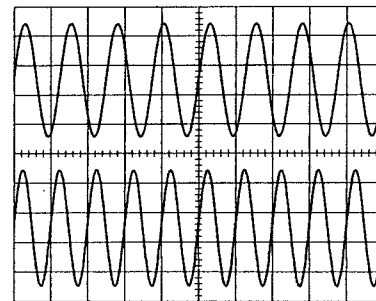

(a)

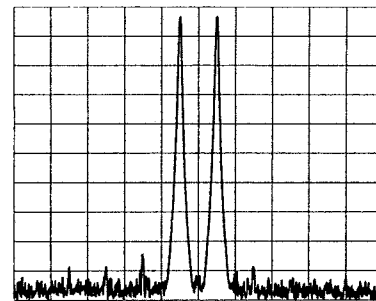

(b)

Figure 1.4
(a) Time domain and (b) frequency domain of two tracking signals using the Two-Tone mode.

The Two-Phase Mode

This mode provides a calibrated phase offset between two signals at the same frequency as illustrated in Figures 1.5a and 1.5b. As with the other HP 3326A modes, the individual signals at the Channel A and B outputs have independently selectable amplitudes and waveforms.

The phase offset is calibrated and eliminates the need for external measurement instruments such as a phase meter, counter-timer, or oscilloscope commonly required when using two single sources. Internal and external calibration is also provided for accuracies up to 0.2 degree with 0.01 degree resolution. A multiphase calibration feature allows the user to extend operation to three or more phases by adding additional HP 3326A's. Multiple phases are commonly required in phased array applications as discussed in Chapter 5.

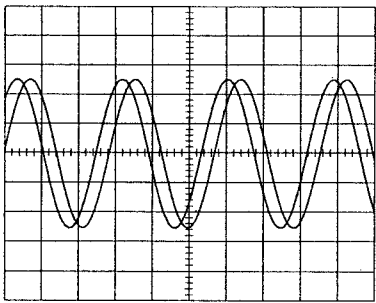

(a)

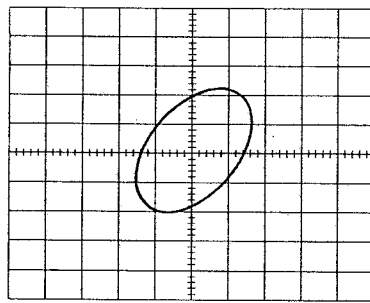

(b)

Figure 1.5

(a) Time domain and (b) Lissajous pattern representation of two signals using the Two-Phase mode.

The Pulse Mode

In the Pulse mode, the HP 3326A produces a precision pulse at the Channel A output and its complement at the Channel B output. This mode is similar to the Two-Phase mode and offers the same degree of accuracy, resolution and stability. Pulse width accuracy is 1% of the period with a resolution of 0.1% of the period.

The width of the pulse is determined by the duty cycle which can be set from 1% to 99% (minimum width 20 ns) and remains constant as the frequency is changed or swept. The HP 3326A produces pulses with $\leq 5\%$ overshoot and ≤ 15 ns rise and fall times. The amplitudes of both outputs can be individually selected for additional versatility. Examples of these capabilities are shown in Figures 1.6a and 1.6b.

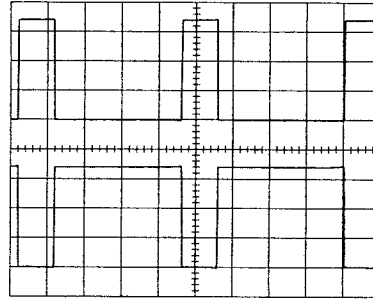

(a)

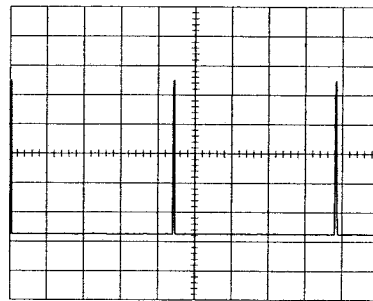

(b)

Figure 1.6

(a) A pulse and its complement in the Pulse mode, and (b) Pulses as narrow as 20 ns can be generated with the HP 3326A.

Waveform Functions

The HP 3326A allows the user to independently select sine wave or square wave functions at the Channel A and B outputs in the Two-Channel, Two-Tone and Two-Phase modes. A dc offset can be added to either of the outputs in any these modes as well as the Pulse mode. The maximum peak amplitude of the ac plus dc signal is ± 5 volts (± 20 volts with the High-Voltage Output option).

A combination of sine, square or pulse waveforms with a dc offset is convenient for interfacing directly to devices requiring a bias offset or for elevating an ac signal above ground for TTL applications. The HP 3326A can generate a dc-only output signal on either channel by simply selecting the DC Output function. In this case, the dc value will be that of the dc offset level. Figures 1.7a through 1.7d are examples of some of the waveforms possible with the HP 3326A.

• Combining Two Signals

An internal combiner can be used to sum the two output signals together to produce one composite signal at the Channel A output connector. This feature applies to the Two-Channel, Two-Tone and Two-Phase modes. With the combiner activated a dc offset is not allowed. Figures 1.8a and 1.8b show two signals before and after being combined.

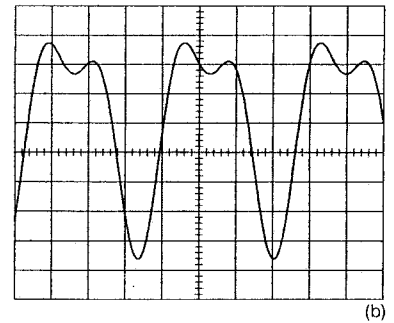
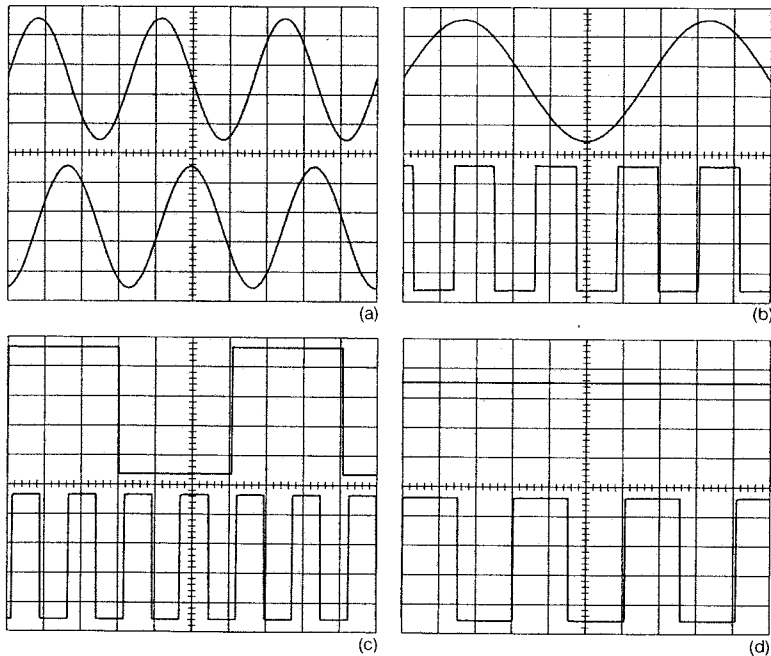

Figure 1.8
Two signals (a) can be combined into one (b) to simulate harmonic distortion at the Channel A output.

Figure 1.7
Waveform examples at the two outputs: (a) sine-sine, (b) sine-square, (c) square-square, (d) dc-square.

Modulation

The HP 3326A modulation capabilities include both amplitude and phase modulation. These capabilities are summarized in Table 1.1 for each of the four modes. Let's look at each modulation capability in more detail:

• Amplitude Modulation

Internal amplitude modulation is available in the Two-Channel mode on Channel A, while external amplitude modulation capability is provided in all modes and can be applied independently to each channel. With internal modulation, the Channel B signal functions as either a sine wave or square wave modulation source.

Amplitude modulation rates are from dc to 100 kHz. Envelope distortion as low as -46 dB is the result of the linear modulator technique used in the HP 3326A. Internal modulation depth can be set from 0 to 100 percent with 0.1 percent resolution and 5 percent accuracy. Figures 1.9a through 1.9c show examples of amplitude modulation waveforms.

Mode	Channel A		Channel B		Channel A&B		
	Internal Mod	External Mod	External Mod	External Mod	Synchronous PM	External Mod	
Two-Channel	Yes	Yes	Yes	Yes	Yes	Yes	No
Two-Tone	No	No	Yes	No	Yes	Yes	Yes
Two-Phase	No	No	Yes	No	Yes	Yes	Yes
Pulse	No	No	Yes	No	Yes	Yes	Yes

Table 1.1 Modulation capabilities in each of the four modes of the HP 3326A.

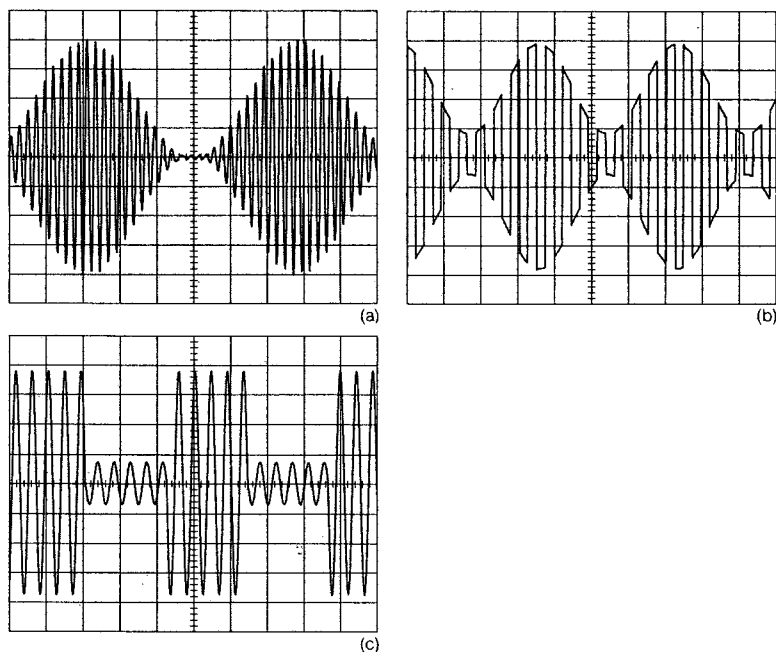

Figure 1.9 Amplitude modulation examples: sinusoidal AM of a (a) sine wave and (b) square wave carrier; (c) square wave AM of a sine wave carrier.

• **Phase Modulation**

The HP 3326A also features both internal and external phase modulation. Internal phase modulation is available in the Two-Channel mode on Channel A using Channel B as the modulation source. As shown in Table 1.1, external phase modulation capabilities depend upon the mode selected. In the Two-Channel mode, the user can externally phase modulate either or both channels, while in the other modes external PM is possible only with Channel B.

A unique synchronous phase modulation capability is available for both channels in the Two-Tone, Two-Phase and Pulse modes. This capability allows the user to simultaneously phase modulate both channels with a synchronous relationship.

Phase modulation rates can be from dc to 5 kHz with up to ± 360 degrees peak deviation and 0.5 percent linearity. Internal accuracy is 5 percent with 1 degree resolution. Figures 1.10a through 1.10c show examples of phase modulation capabilities. The HP 3326A also allows the user to apply simultaneous amplitude and phase modulation at each channel.

Frequency Sweep

The HP 3326A features phase continuous frequency sweep of both channels. The difference in sweep operation between each HP 3326A mode is primarily in the tracking of the Channel B frequency relative to that of Channel A during sweep. The relationship of the Channel B frequency to that of Channel A is summarized in Table 1.2.

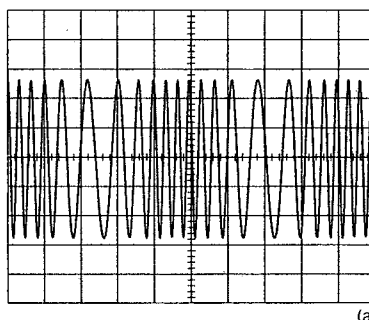

(a)

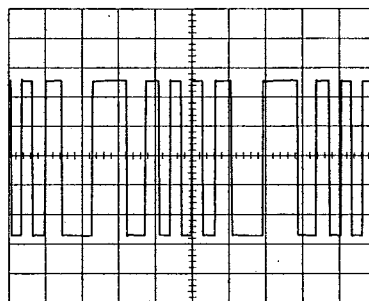

(b)

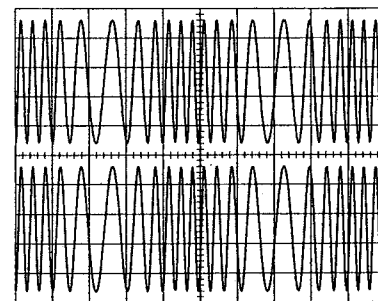

(c)

Figure 1.10
Sinusoidal phase modulation of a (a) sine wave and (b) square wave carrier; (c) synchronous phase modulation of both channels.

Mode	Channel B Tracking
Two-Channel	Channel B frequency is independent of Channel A frequency.
Two-Tone	Channel B frequency is within ± 100 kHz of Channel A frequency.
Two-Phase	Channel B frequency is identical to Channel A frequency.
Pulse	Channel B frequency is identical to Channel A frequency.

Table 1.2 The relationship of Channel B frequency to Channel A frequency during sweep.

The HP 3326A allows flexible sweep control with two sweep types—Linear and Discrete. Trigger capability is provided for both continuous and single sweeps with both sweep types. With single sweep, triggering is accomplished from a front panel keystroke, HP-IB command or a rear panel input signal. This trigger can be prearmed with the Sweep Reset function. When armed, the sweep will start within 10 μ sec of the trigger signal. Now, let's look at the two frequency sweep types:

• **Linear Frequency Sweep**

The sweep direction of either channel may be increasing or decreasing frequency by selecting the appropriate start and stop frequencies (or center frequency and span) in the Linear Ramp mode. A Triangular Sweep mode is also provided for a continuous up-down sweep. Figures 1.11 through 1.15 illustrate some of the linear sweep combinations possible. A rear panel X-drive signal allows the HP 3326A to be used with oscilloscopes and X-Y recorders. During Linear Sweep, a marker can be positioned at a precise point which identifies the corresponding frequencies at each channel. A rear panel Z-blank TTL signal goes high during retrace in the Linear Ramp and Discrete Sweep modes and when sweep is off.

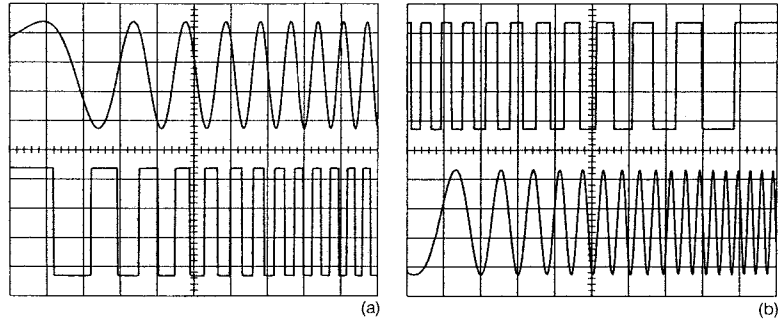

Figure 1.11
Two-Channel mode sweep examples. (a) Channels A and B increasing frequency, (b) Channel A (upper trace) decreasing frequency while Channel B (lower trace) is increasing frequency.

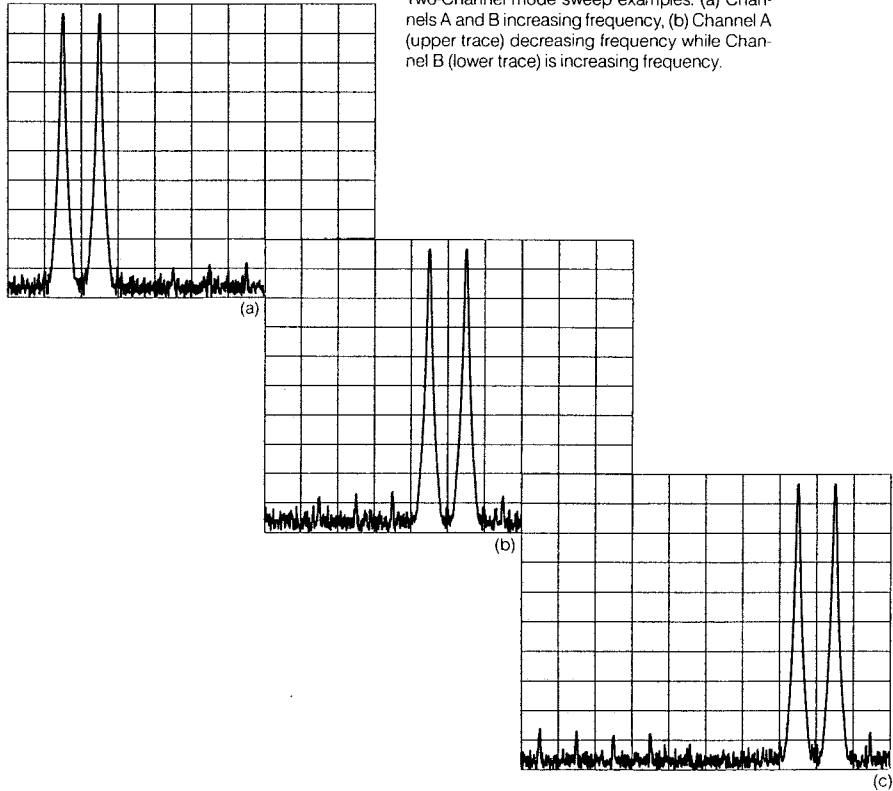

Figure 1.12
Two-Tone mode sweep example with tone pair at (a) t_1 , (b) t_2 and (c) t_3 .

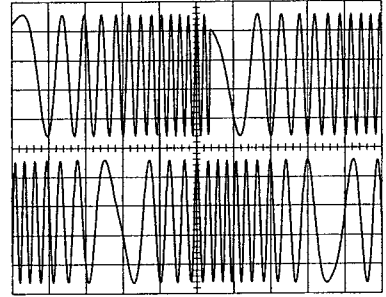
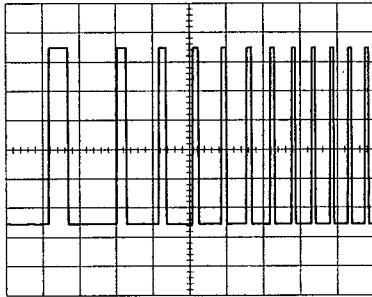
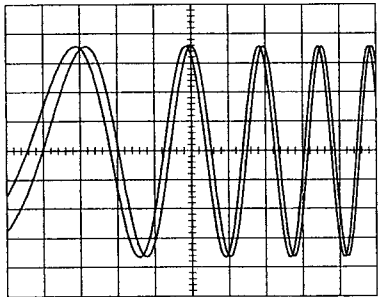

Figure 1.13
Phase difference in the Two-Phase mode is constant during sweep.

Figure 1.14
A swept pulse signal in the HP 3326A Pulse mode. The duty cycle remains constant with frequency.

Figure 1.15
Ramp (upper trace) and Triangular (lower trace) Sweep examples in the Linear Frequency Sweep mode.

• **Discrete Frequency Sweep**

This capability allows rapid switching from one frequency to another in a user-defined sequence of up to 63 pairs. Discrete Frequency Sweep takes advantage of fast hardware switching and Save-Recall Memory to provide a rapid frequency switching time.

For changes of less than 1 MHz, frequency switching takes place in typically 10 ms and linearly increases to typically 25 ms for changes of 1.0 MHz or greater. This mode is useful in sequential-tone signaling applications such as dual-tone multiple-frequency (DTMF) and pocket pagers. Figure 1.16 illustrates an example of Discrete Frequency Sweep.

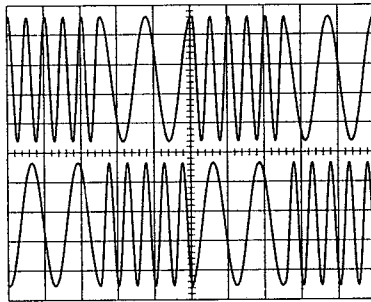

Figure 1.16
Fast frequency transitions occur on both channels in the Discrete Frequency Sweep mode.

2. INSTRUMENT FAMILIARIZATION

INSTRUMENT FAMILIARIZATION

1 Status

Display panel displays frequency (up to 11 digits), amplitude, phase offset, dc offset, sweep frequencies and time, marker frequency, HP-IB address values and error messages. CHAN key selects channel for display and modification. The A and B LEDs indicate channel selected. Channel B phase is indicated by PHASE OFFSET LED. EXT REF LED illuminates when operating with an external frequency reference or High Stability Frequency Option (Option 001).

2 HP-IB Status

LEDs indicate status of HP-IB operation. LOCAL key returns HP 3326A from remote to front panel operation unless local lockout is programmed. LOCAL preceded by blue SHIFT key displays HP-IB address.

3 Sweep

SWEEP keys set start, stop, and either a continuous or single frequency sweep. Ramp sweeps from start to stop frequency while Triangle sweeps from start to stop to start frequencies. Discrete sweep maintains a constant frequency output for a specified dwell time before stepping to the next frequency.

4 Entry

Signal frequency, amplitude, phase, or dc offset is changed by selecting appropriate ENTRY key. PHASE and DC OFFSET keys with blue SHIFT key assign a zero phase value to the signal or removes an entered phase. The blue DUTY CYCLE and % AM/PM DEV entries change the pulse duty cycle, percent AM or PM deviation.

5 Instr State

Setups are saved and recalled from nonvolatile memory registers 0 through 9. Register 0 contains the last setup prior to removing power. Discrete sweep elements are saved and recalled from memory by the SAVE/RECALL keys preceded by blue SHIFT key. Contiguous discrete elements range from 00 to 62 and consist of dwell time and Channel A and B frequencies.

6 Data

Frequency, amplitude, offset, time, memory location, and HP-IB address are entered with the numeric keypad followed by a units suffix.

7 Modify

Frequency, amplitude, offsets and time values are modified with the rotary knob. The arrow keys select display digit modified.

8 Sync A Output

1.2 Vpp square wave output with same frequency as Channel A.

9 Modulation

Internal and external AM and PM sources are selected with the modulation keys. Internal modulation uses Channel B to modulate Channel A. External modulation inputs are on the rear panel.

10 Calibration

MANUAL key initiates an HP 3326A calibration. SELECT key selects the HP 3326A phase calibration source (internal, external or multiphase). External phase calibration inputs are on the rear panel. SELECT preceded by blue SHIFT key initiates self test.

11 Mode

MODE key selects the 2 CHANNEL, 2 PHASE, 2 TONE, or PULSE operating modes. Combined operation sums Channel A and B to produce a composite output at Channel A.

12 Function

Independent function outputs include sine wave, square wave, and dc. The High Voltage Option provides outputs up to 40 Vpp.

Figure 2.1
HP 3326A Front Panel.

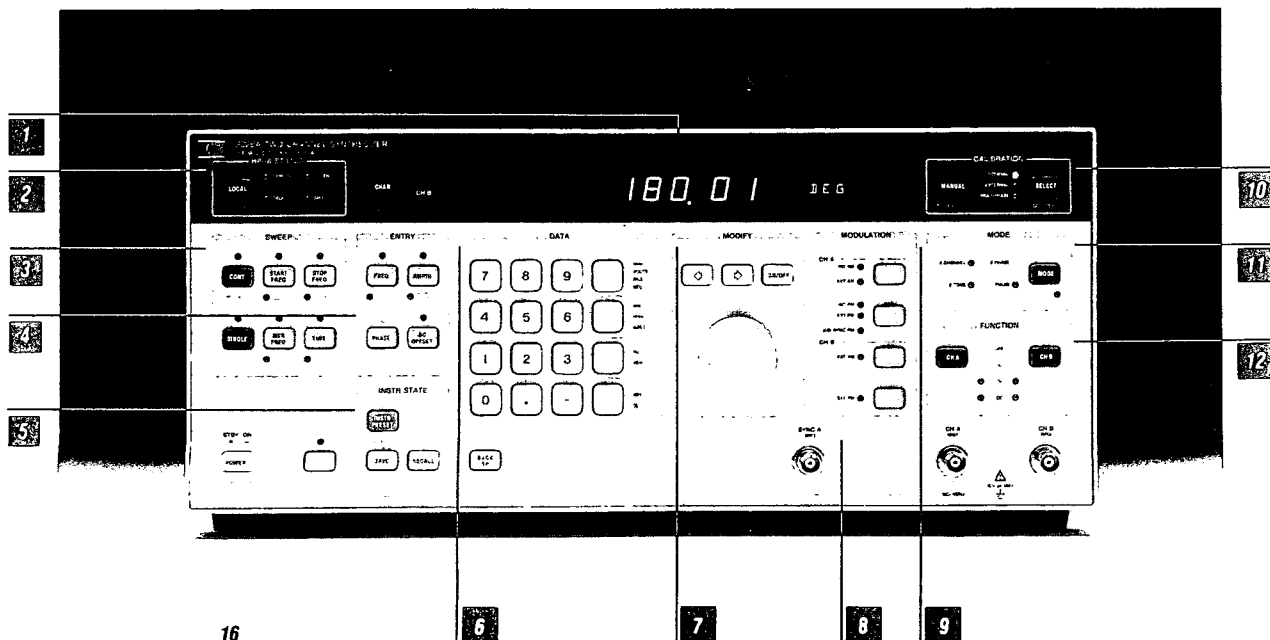

1 Modulation Inputs

PM (5 kHz maximum modulation frequency) or AM (100 kHz maximum modulation frequency) is available for either or both channels. AM and PM can operate simultaneously.

2 Calibration Inputs

External calibration sources are connected to the calibration inputs.

3 Channel Outputs

Optional rear panel outputs (Option 003) for Channel A and B.

4 Ext Trig Input

Allows external triggering of single sweeps.

5 Z-Blank/X-Drive Outputs

The Z-BLANK and X-DRIVE OUTPUTS are compatible with most oscilloscopes and plotters. Z-BLANK signal is TTL high during retrace. X-DRIVE provides linear 0 to 10 V ramp proportional to sweep time.

6 HP-IB

Allows remote operation with external controllers.

7 Marker Output

A TTL (0 to 5 V) negative going transition during sweeps.

8 20-33 MHz B-L.O. Output

Output offset from Channel B frequency by 20 MHz.

9 Frequency Reference Input/Output

The HP 3326A is phase-locked to stable frequency references with the 1, 2, 5, 10 MHz REF IN connector. Other instruments are phase-locked to the HP 3326A through the 10 MHz OUTPUT connector. The 10 MHz OVEN OUTPUT option (Option 001) provides a high stability frequency reference when connected to 1, 2, 5, 10 MHz REF IN.

Figure 2.2
HP 3326A Rear Panel.

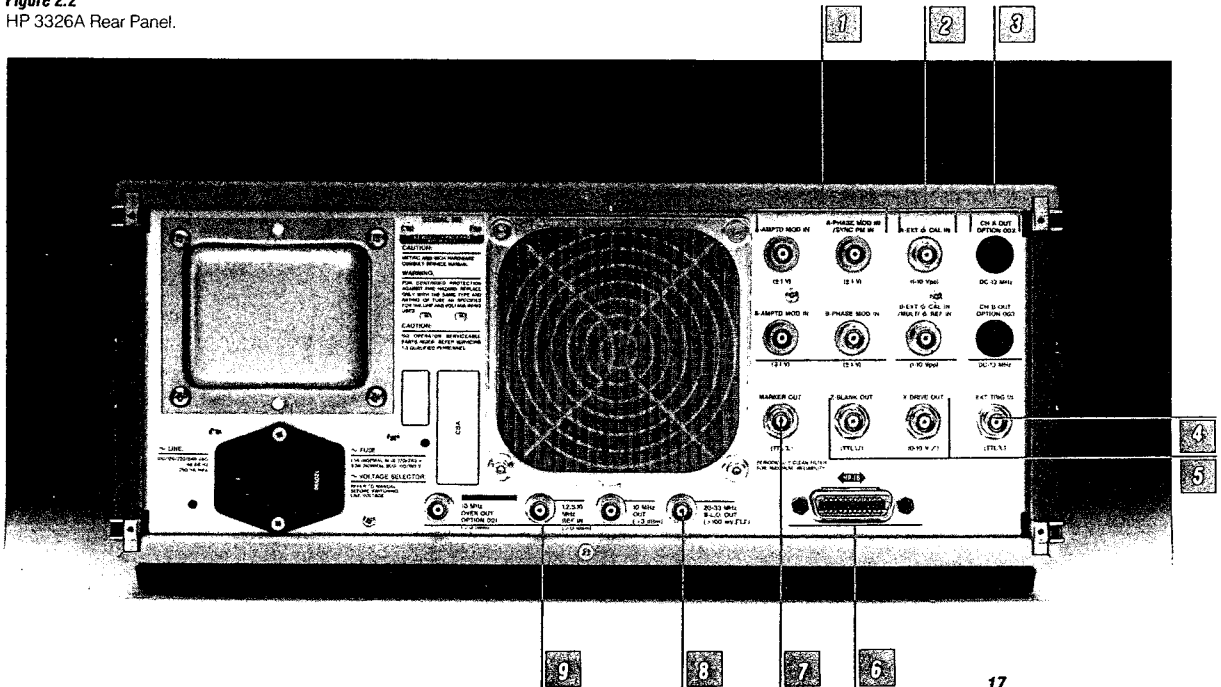

3. TWO-CHANNEL MODE OPERATION AND APPLICATIONS

TWO-CHANNEL MODE OPERATION GETTING STARTED

1. Instrument Preset.

To establish a known setup prior to entering setup data, press the green INSTR PRESET key. Upon preset, the HP 3326A assumes the following setup characteristics:

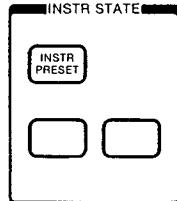

PRESET.

Mode	2 CHANNEL
Frequency A and B	1000 Hz
Amplitude A and B	100 mVp-p
DC offset A and B	0 V
Phase	0 deg
Modulation	Off
Modulation level	30%
Sweep	Off
	Single ramp
	13 MHz span
	1 s sweep
Function A and B	Sine wave
Calibration	Internal
Autocalibration	Off

2. Select Mode—2 CHANNEL.

The preset state places the HP 3326A into the Two-Channel mode as indicated by the illuminated the 2 CHANNEL indicator. In the Two-Channel mode, the HP 3326A operates as two independent sources.

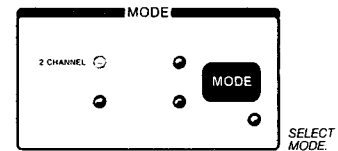

SELECT MODE.

3. Set Entry and Data Parameters.

Prior to entering data parameters, press the CHAN key to select the channel to be modified. The channel selected is indicated by the illuminated channel indicator.

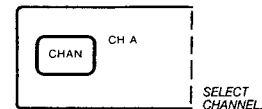

SELECT CHANNEL.

Select an ENTRY key corresponding to the parameter to be modified. An indicator for the FREQ, AMPTD, PHASE, DC OFFSET, DUTY CYCLE and % AM/PM DEV ENTRY keys illuminates after the respective key is selected and the current value for the parameter is displayed.

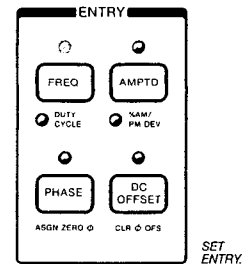

SET ENTRY.

Enter new values into the display area with the numeric keypad and terminate the entry with the appropriate units key in the DATA block. Prior to ending the entry with the units keys, erroneous entries are corrected by removing display digits with the BACK SPACE key or canceling the entry by pressing an ENTRY key. Entering an invalid value results in an error message and rejection of the entry. Appendix A contains a listing of the error messages and a description of the fault. Figure 3.1 illustrates entering setup values into the HP 3326A.

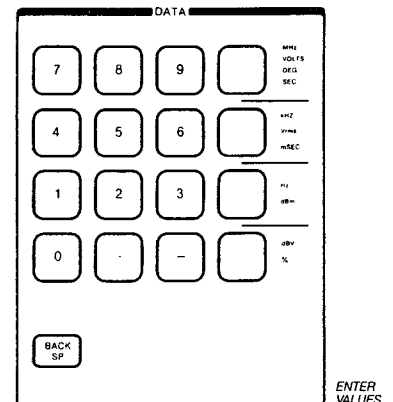

ENTER VALUES.

1. CHAN (CH A)					
2. AMPTD	1	.	1	2	5 VRMS
3. FREQ	1	0	kHz		
1. CHAN (CH B)					
2. AMPTD	.	3	5	1	VRMS
3. FREQ	3	0	kHz		

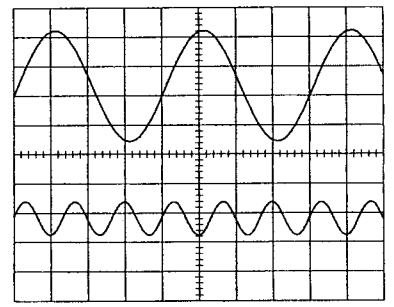
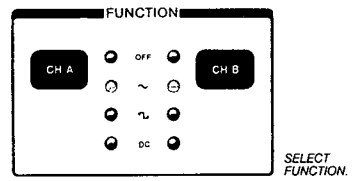

Figure 3.1
 Two-Channel mode keystroke example resulting in the above output signals.

4. Select Function.

The output waveform for each channel is selected with the FUNCTION keys. The output for each channel can be disabled or set to sine wave, square wave, or dc output (dc offset) only.



SELECT FUNCTION.

5. Connect Device Under Test.

Connect the HP 3326A outputs to the test device and other instruments used in the measurement as required.

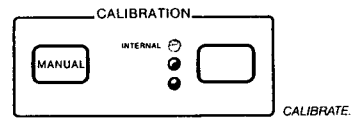

CALIBRATE.

6. Calibration.

Before making a measurement, calibrate the HP 3326A with the MANUAL key. Amplitude, dc offset, phase, and internal modulation are calibrated internally when the manual key is pressed.

TWO-CHANNEL MODE APPLICATIONS SWEEP MIXER MEASUREMENTS

Application

The characterization of mixers usually involves the measurement of frequency response, conversion loss and distortion. Point-to-point cw measurements can be made, but these are slow and tedious. Since the RF and LO input signals and their difference frequency (the IF) must be accurately controlled, two sources are typically required. The use of swept techniques can speed up the measurement and provide characterization over a wide range of frequencies.

Measurement Considerations

The testing of devices such as mixers is somewhat complicated because they operate with different input and output frequencies. Although broadband measurement techniques can be used, the numerous harmonic and spurious signals usually present can limit measurement accuracy. The use of a narrowband tracking network analyzer eliminates these problems by selecting only the desired signal component and provides better accuracy and dynamic range.

Mixer intermodulation products and group delay are examples of different distortion effects that are important in mixer applications. A mixer intermodulation distortion measurement is illustrated in Chapter 4.

HP 3326A Solution

Figure 3.2 shows a measurement setup using the HP 3326A with an HP 3577A Network Analyzer to make swept measurements of mixer frequency response, conversion loss and group delay. The HP 3326A Channel A output provides the RF input to the mixer. The Channel B output is used to provide a local oscillator signal.

Using the HP 3326A Two-Channel mode, the Channel A sweep is set to the desired mixer input range and the HP 3577A is set to sweep over the corresponding mixer output frequency range. The HP 3326A Z-blank signal externally triggers the HP 3577A in the

continuous sweep mode. Both instruments use a common frequency reference and the same sweep time.

To make a measurement, first calibrate by measuring the RF input signal. This is accomplished by replacing the mixer with a through connection, and taking a reference measurement with the HP 3577A set to sweep through the input frequency range. The measurement is initiated with an HP 3326A single sweep keystroke. This reference measurement will be valid at the mixer output if the mixer RF input is linear.

Figure 3.2
Setup for swept mixer testing.

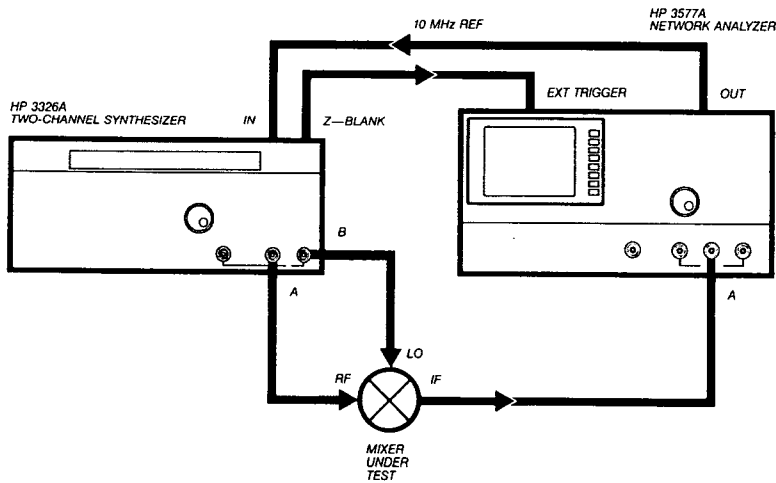

Then use the HP 3577A Normalization function to store the reference measurement. When normalized, the mixer measurement at HP 3577A input A will be displayed as A/D1, where D1 is the reference measurement. With this technique, frequency response flatness can be measured to 0.3 dB, limited by the HP 3577A absolute flatness performance.

Figures 3.3 and 3.4 illustrate frequency response and group delay measurements of a mixer with a 10.7 MHz IF bandpass filter. Mixer flatness and conversion loss is obtained from the frequency response measurement. In this example the HP 3326A Channel A frequency is swept from 2.2 to 3.2 MHz (RF), and the Channel B start and stop sweep frequencies are both set at 8 MHz to produce a cw signal at 8 MHz. The HP 3577A is set to sweep from 10.2 to 11.2 MHz (IF). The HP 3326A was set for sinusoidal output and 0 dBm at both channels.

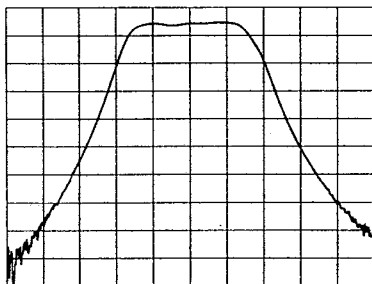

Figure 3.3
Mixer frequency response measurement at IF output. Vertical axis 10 dB/div. Horizontal 10.2 to 11.2 MHz.

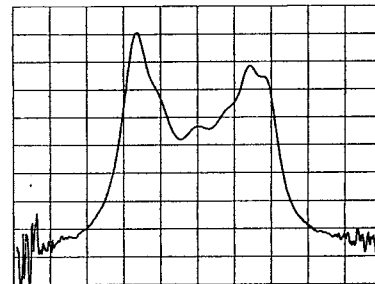

Figure 3.4
Mixer group delay flatness measurement. Vertical axis 20 us/div. Horizontal axis 10.2 to 11.2 MHz.

PHASE-LOCKED LOOP TESTING

Application

The phase-locked loop (PLL) is an important circuit in many electronic applications such as communications, consumer electronics, frequency synthesis, and navigation. Although there are many variations in loop design, a basic loop consists of a phase detector, low-pass filter, voltage-controlled oscillator (VCO) and a frequency divider as shown in Figure 3.5.

In a PLL circuit, the phase detector compares the input signal phase with that of the VCO signal after it passes through the frequency divider. The phase detector output is an error signal that is proportional to the difference in phase between its input signals. This error voltage passes through a low-pass filter which suppresses noise, high frequency signal components and helps determine loop dynamic performance. The PLL operates in such a way that the VCO and input signals are locked together with a constant phase difference. The measurement of PLL frequency response and transient response are often needed to analyze the performance of these circuits.

Frequency Response Measurement Considerations

The analysis of phase-locked loops has been somewhat difficult for several reasons. First, the controlled variable is frequency, but the error signal is based on phase. Since frequency is the derivative of phase, the phase of the VCO is proportional to the integral of the filtered VCO voltage. This gives the PLL an integrated rather than a linear feedback function.

Second, the phase detector requires two signals to operate and this usually necessitates that analysis be done with the loop closed. Third, many of the PLL components such as the phase detector or the VCO are often non-linear so that input signals with varying peak phase deviations can cause varying loop responses.

Several techniques have been developed to analyze PLL circuits. One technique is to frequency modulate the input signal and monitor the resulting VCO control voltage. This technique works well when the PLL is used as a frequency demodulator, but for other applications it is necessary to assume that the VCO has constant gain independent of the modulation rate or signal amplitude. Since the FM modulation index is dependent upon the rate, large phase deviations can be produced which cause the loop to operate in non-linear regions.

Another technique is to insert a signal into the loop and analyze the resulting response, but the process of injecting a signal can alter loop performance. The individual elements of the loop can be analyzed separately, but loop interactions are usually difficult to predict. Analysis of individual loop elements is most valuable in diagnosing faulty loop operation.

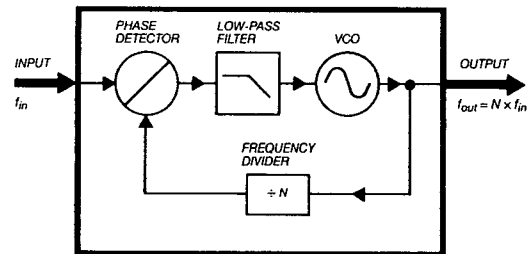

Figure 3.5
Basic phase-locked loop block diagram.

HP 3326A Solution

A phase modulation technique can be used that offers unique capabilities which enhance the user's ability to analyze PLL circuits and that overcomes many of the disadvantages of other methods. The HP 3326A is well suited to this technique and its Two-Channel capability can simplify PLL measurements by reducing equipment complexity.

The frequency stability of the HP 3326A makes it ideal for narrowband loop testing. The calibrated and wide range output level of the HP 3326A is useful when testing a PLL circuit with a response that is dependent upon input signal level. Wide range level control is also important for generating a low PM index for frequency response measurements on PLL circuits with one of the three methods available.

The HP 3326A can be used to make a variety of PLL frequency response measurements as summarized in Table 3.1. The test setup and details of each method are considered separately.

<i>Method</i>	<i>Test Rates</i>	<i>Equipment Required</i>	<i>Comments</i>
1	20 Hz to 5 kHz	1ea HP 3326A Two-Channel Synthesizer 1ea Spectrum Analyzer (HP 3585A) 1ea Oscilloscope (HP 1740A) 1ea Phase Detector	For swept measurement of magnitude response of PLL circuits with inputs and outputs up to 13 MHz. HP 10534A Mixer is used as a Phase Detector with RF and LO input frequencies down to 50 kHz.
2	5 Hz to 5 kHz	1ea HP 3326A Two-Channel Synthesizer 1ea Network Analyzer (HP 3577A) 1ea Oscilloscope (HP 1740A) 1ea Phase Detector 1ea 50 Ohm Power Splitter (HP 11652-60009)	For swept measurement of magnitude and phase response of PLL circuits with inputs and outputs up to 13 MHz. HP 10534A Mixer is used as a Phase Detector with RF and LO input frequencies down to 50 kHz.
3	Resolution of spectrum analyzer to 13MHz.	1ea HP 3326A Two-Channel Synthesizer 1ea RF Spectrum Analyzer (HP 3585A, HP 8568)	For swept measurement of magnitude response of PLL circuits with inputs up to 13 MHz and outputs up to the limit of the spectrum analyzer.

Table 3.1A comparison of three methods using the HP 3326A to measure the frequency response of phase-locked loops.

• **Method 1**

A swept display of PLL magnitude vs phase can be obtained using the setup shown in Figure 3.6. This method yields a fast display response and is valuable in making loop adjustments. Using this setup, loops with input and output frequencies up to 13 MHz can be analyzed. Phase modulation rates up to the 5 kHz limit of the HP 3326A phase modulator are possible. The lower limit on the rate is determined by the minimum frequency of the spectrum analyzer/tracking generator.

The frequency response of the HP 3326A phase modulator is relatively flat at low modulation rates, but rolls off for rates near the modulation bandwidth. The frequency response curve shown in Figure 3.7 shows a typical HP 3326A phase modulator frequency response.

The effects of the HP 3326A phase modulator frequency response can be accounted for by taking a reference reading with the phase-locked loop out of the circuit and replacing it with a through connection. In many PLL circuits, the input and output frequencies are different and the HP 3326A Channel A frequency will have to be temporarily changed to obtain a reference reading. The reference reading can be stored in the spectrum analyzer's trace memory and subtracted out from the measurement with the loop in the circuit.

Proper phase demodulation occurs when the inputs of phase detector number 2 are at the same frequency and have a phase relationship that centers the detector in its linear range as observed on the oscilloscope. With the HP 3326A in the Two-Channel mode, the Channel B phase is adjusted for linear operation.

The amount of phase deviation is adjusted to assure that both the PLL and the phase demodulator are operating in their linear regions. Some PLL circuits have significant peaking and it may be necessary to reduce the deviation so that gain compression does not occur. Some PLL circuits are sensitive to input signal level variations and should be tested at various input levels.

With this method the spectrum analyzer tracking generator output is used to phase modulate HP 3326A Channel A. The modulated RF output from HP 3326A Channel A is used as the input signal to the PLL under test. This produces a phase error which the loop responds to by phase modulating the VCO. The modulated VCO signal is then demodulated by phase detector number 2 and the frequency response is displayed on the spectrum analyzer. An example of a typical PLL frequency response measurement is shown in Figure 3.8.

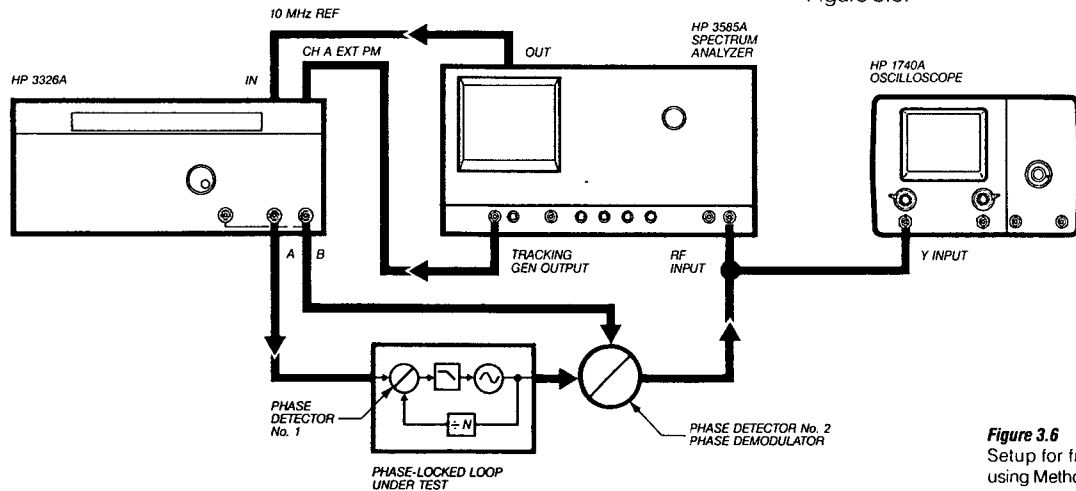

Figure 3.6
Setup for frequency response measurement using Method 1.

Figure 3.7
Magnitude and phase response of HP 3326A phase modulator. Vertical axis: upper trace 2 dB/div.; lower trace 45 deg/div. Horizontal axis 10 Hz to 15 kHz.

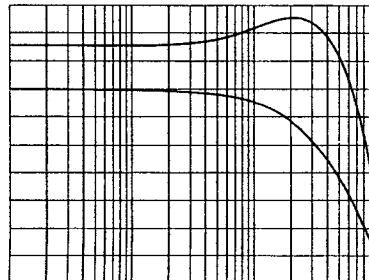
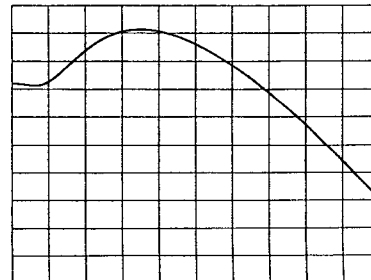

Figure 3.8
Frequency response of a typical phase-locked loop using Method 1. Vertical axis 2 dB/div.; horizontal axis 250 Hz to 5 kHz.



• **Method 2**

With the use of a network analyzer instead of a spectrum analyzer, swept frequency response measurements can be made that yield phase as well as magnitude information. The test setup and measurement procedure for this method are very similar to that of method 1 and is shown in Figure 3.9. The only exception is that for certain phase detectors such as mixers, it is possible to operate on either a positive or negative slope which results in a 180 degree phase shift.

With the HP 3577A Network Analyzer, frequency response measurements can be made on loops with PM rates as low as 5 Hz. As in method 1, the upper PM rate is limited to 5 kHz by the frequency response of the HP 3326A phase modulator. Effects of this frequency response, particularly below 5 kHz, can be removed by taking a refer-

ence measurement as in Method 1. The HP 3577A built-in normalization capability is convenient for automatically removing this effect. Figure 3.10 is an example of a typical PLL magnitude and phase response using this method.

• **Method 3**

This method is useful for obtaining the magnitude frequency response of PLL circuits with wide bandwidths and is not restricted to loops with output frequencies within the range of the HP 3326A. The loop input frequency however must be within the HP 3326A's range. Measurements can be made with PM rates limited on the low end by the resolution of the spectrum analyzer used and on the high end by the difference of the HP 3326A Channel A and Channel B frequencies.

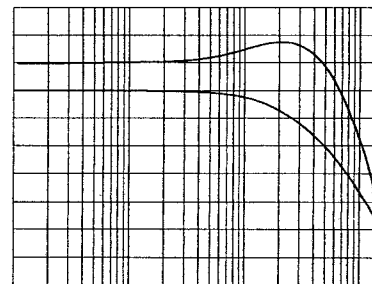

Figure 3.10
Magnitude and phase response of a typical phase locked loop using Method 2. Vertical axes: upper trace 1 dB/div.; lower trace 30 deg/div. Horizontal axis 5 Hz to 5 kHz.

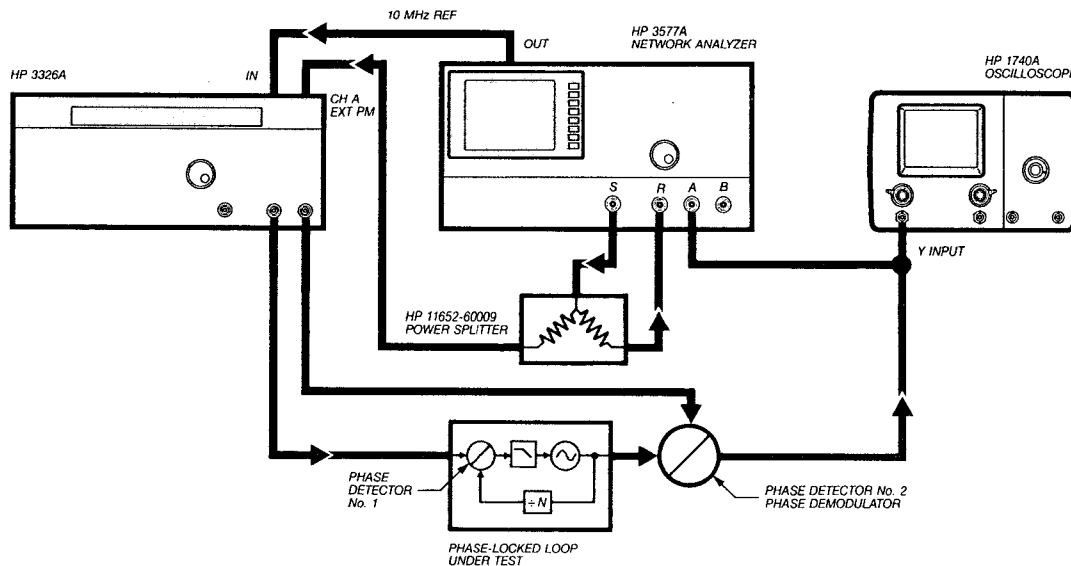

Figure 3.9
Setup for frequency response measurement using Method 2.

The test setup for this method is shown in Figure 3.11. This method is useful because it requires few instruments and the test setup is simple. The HP 3326A is set to the Two-Channel mode and the output combiner is used to provide a composite PLL input signal consisting of two frequencies. This is equivalent to a signal with both AM and PM components. If the phase detector in the PLL is operated near quadrature, the AM component will be removed and only the PM component remains. The PM rate is determined by the frequency difference between the HP 3326A Channel A and B frequencies.

The PM index is set by the ratio between the HP 3326A Channel A and B signal levels and is approximately $(\text{level B}/\text{level A})/2$ where level A is larger. This index is normally set to less than 0.1 radian so that the phase deviation produced is mainly from the first sideband and the PLL operates in a linear region. The first sideband level, as observed on the spectrum analyzer closely tracks the PLL closed loop frequency response.

To make a measurement, the setup of Figure 3.11 is used. The spectrum analyzer is set so that it sweeps from the carrier frequency out to the PLL bandwidth of interest. With the HP 3326A Channel A frequency set to the PLL input frequency, adjust the Channel B frequency offset (positive direction) to produce a first PM sideband at the desired frequency corresponding to a test frequency within the loop bandwidth. This Channel B offset is then varied for each sweep of the spectrum analyzer.

The HP 3585A and HP 8568A Spectrum Analyzers have a Max Hold function which is useful for storing the first sideband levels at each of the different offsets for each sweep. It is important to set the resolution bandwidth of the spectrum analyzer to resolve the spacing between the carrier and the sidebands. An example of a PLL frequency response is shown in Figure 3.12. The large signal at the start frequency is the carrier. The amplitude of each of the sidebands traces out the PLL frequency response.

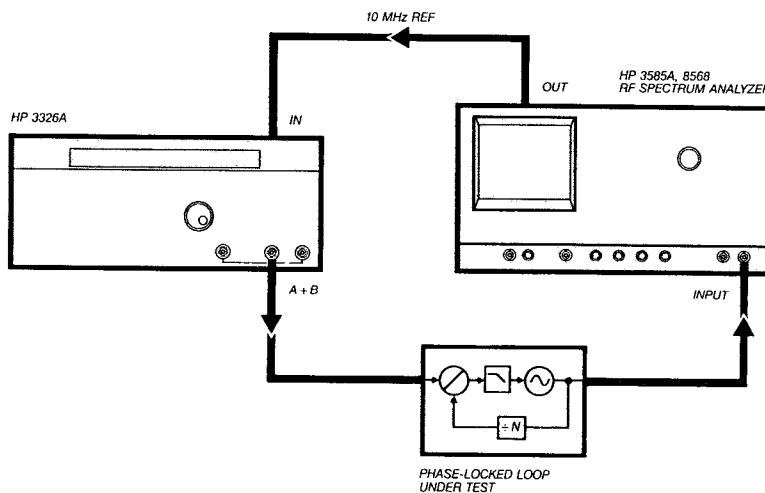
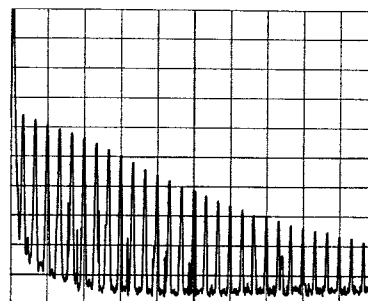

Figure 3.11
Setup for measuring frequency response with Method 3.

Figure 3.12
Typical phase-locked loop frequency response measurement using Method 3. The first signal is the 350 kHz carrier. Vertical axis 10 dB/div.; Horizontal axis 350 kHz to 365 kHz.



Transient Response Measurement Considerations

The time domain response of a PLL circuit to a step change in input phase is useful for determining loop parameters such as rise time, overshoot and damping factor. These parameters imply many of the same PLL characteristics that can be measured with frequency response techniques, however they are most useful in determining loop settling time and dynamic response performance.

HP 3326A Solution

Figure 3.13 shows a test setup for measuring PLL transient response. In this setup the HP 3326A Channel A output phase is switched between two values using external square wave PM. The HP 3314A Function Generator is used to produce a square wave signal. The rise and fall time of the HP 3326A phase modulator is approximately 6 μ sec and useful measurements can be made on loops with bandwidths of approximately 1 kHz or less.

The phase modulated Channel A signal is applied to the PLL input and the output from the VCO is demodulated by a phase detector. The loop time domain response to the phase change is displayed on the oscilloscope. A typical response is shown in Figure 3.14. Linear operation of both phase detectors should be maintained the same as for frequency response testing.

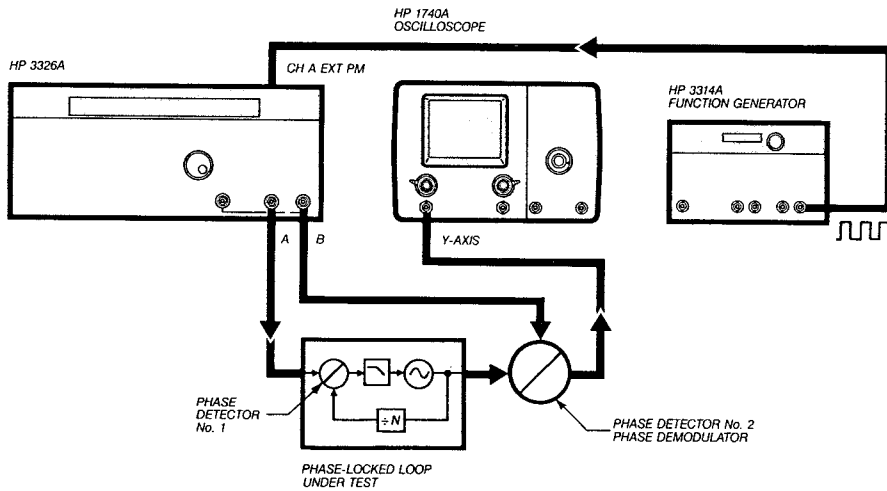

Figure 3.13
Setup for measuring transient response.

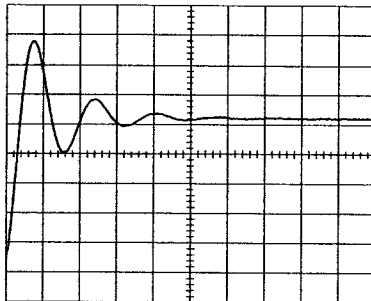

Figure 3.14
Typical phase-locked loop transient response measurement. Vertical axis 50 mV/div.; Horizontal axis 1 ms/div.

4. TWO-TONE MODE OPERATION AND APPLICATIONS

TWO-TONE MODE OPERATION GETTING STARTED

1. Instrument Preset.

To establish a known setup prior to entering setup data, press the green INSTR PRESET key. Upon preset, the HP 3326A assumes the following setup characteristics:

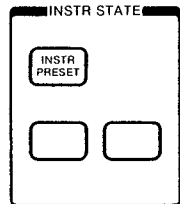

PRESET

Mode	2 CHANNEL
Frequency A and B	1000 Hz
Amplitude A and B	100 mVp-p
DC offset A and B	0 V
Phase	0 deg
Modulation	Off
Modulation level	30%
Sweep	Off
	Single ramp
	13 MHz span
	1 s sweep
Function A and B	Sine wave
Calibration	Internal
Autocalibration	Off

2. Select Mode—2 TONE.

For Two-Tone setups, press the MODE key to illuminate the 2 TONE indicator. The HP 3326A now operates as two tracking sources with the Channel B frequency capable of being offset from Channel A by 100 kHz.

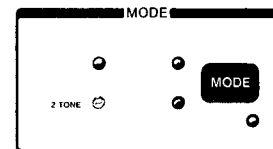

SELECT MODE.

3. Set Entry and Data Parameters.

Prior to entering data parameters, press the CHAN key to select the channel to be modified. The channel selected is indicated by the illuminated channel indicator.

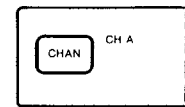

SELECT CHANNEL.

Select an ENTRY key corresponding to the parameter to be modified. An indicator for the FREQ, AMPTD, PHASE, DC OFFSET, DUTY CYCLE and % AM/PM DEV ENTRY keys illuminates after the respective key is selected and the current value for the parameter is displayed.

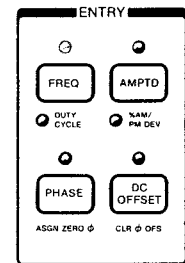

SET ENTRY.

Enter new values into the display area with the numeric keypad and terminate the entry with the appropriate units key in the DATA block. Prior to ending the entry with the units keys, erroneous entries are corrected by removing display digits with the BACK SPACE key or canceling the entry by pressing an ENTRY key. Entering an invalid value results in an error message and rejection of the entry. Appendix A contains a listing of the error messages and a description of the fault. Figure 4.1 illustrates entering setup values into the HP 3326A.

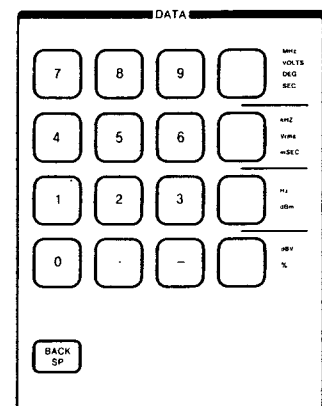

ENTER VALUES.

1. CHAN (CH A)					
2. AMPTD	1	•	1	2	5 VRMS
3. FREQ	8	•	0	0	5 KHz

1. CHAN (CH B)					
2. AMPTD	1	•	1	2	5 VRMS
3. FREQ	1	0	•	0	5 KHz

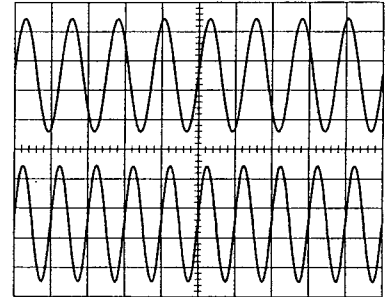
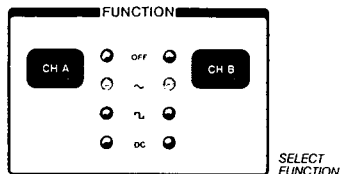

Figure 4.1
Two-Tone mode keystroke example resulting in the above output signals.

4. Select Function.

The output waveform for each channel is selected with the FUNCTION keys. The output for each channel can be disabled or set to sine wave, square wave, or dc output (dc offset) only.



SELECT FUNCTION.

5. Connect Device Under Test.

Connect the HP 3326A outputs to the test device and other instruments used in the measurement as required.

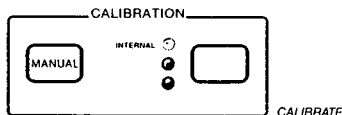

CALIBRATE.

6. Calibration.

Before making a measurement, calibrate the HP 3326A with the MANUAL key. Amplitude, dc offset, phase, and internal modulation are calibrated internally when the MANUAL key is pressed.

TWO-TONE MODE APPLICATIONS SWEPT TWO-TONE INTERMODULATION DISTORTION

Application

Measurement of intermodulation (IMD) products can yield important information about the non-linear characteristics of a circuit or system. These characteristics relate to second and third-order distortion properties of many devices such as voice grade and consumer audio amplifiers, mixers, and crystal filters. Applications can be found in many areas of communications including single sideband, AM and FM transceivers, modems and voiceband data transmission used in telecommunications and high frequency radio teletype.

Measurement Considerations

The intermodulation method of measuring distortion uses a combined driving signal normally composed of two sine wave signals at different frequencies. A variation of this method, known as transient intermodulation distortion (TIM), uses a combination of sine wave and square wave signals and is useful in applications where dynamic distortion performance is important.

The IMD method is useful because second and third-order distortion measurements are not affected by the harmonic distortion of the signal source. Such harmonic distortion does not occur at the same frequencies as the intermodulation distortion produced by the device under test. Thus a spectrum analyzer can be used to select just the distortion products produced by the device under test.

A common method uses a combination of two relatively high frequency signals of equal amplitude as the driving signal. For audio frequency measurements, their frequencies are typically separated by a few hundred Hertz. The separation is typically 10 kHz to 100 kHz for RF measurements. Figure 4.2 illustrates the distortion products using this method.

Figure 4.2
Third-order intermodulation distortion products.

The distortion sidebands at frequency $f_b - f_a$ are second-order products and are much lower in frequency than the input signals f_a and f_b . The second-order distortion is equal to the ratio of the amplitude of the signal at frequency $f_a - f_b$ to that of the sum of the signals at f_a and f_b .

The third-order distortion products are gathered around the frequencies of the two driving signals at $2f_a - f_b$ and $2f_b - f_a$. Third-order distortion is equal to the ratio of the sum of the amplitudes of these third-order products to the sum of the amplitudes of the driving signals at f_a and f_b .

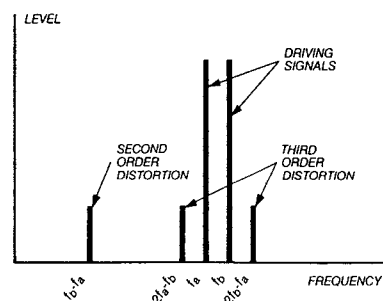

HP 3326A Solution

The HP 3326A can be used with an HP 3585A Spectrum Analyzer as shown in Figure 4.3 to make swept IMD measurements. Using the Two-Tone mode and the internal combiner the HP 3326A can produce a Two-Tone signal at the Channel A output with a third-order IMD level of -80 dBc (below $+13$ dBm and 1 MHz).

This built-in capability eliminates the need for two separate sources and an external combiner. Combinations of sine wave and square wave signals can be produced for both conventional and transient IMD testing. Independent levels can be set for each tone to establish the proper level ratio.

This HP 3326A/3585A system provides swept IMD measurements resulting in characterization of IMD performance over the frequency range of interest. The HP 3326A Z-blank signal is used to trigger the HP 3585A sweep. With a common frequency reference and identical sweep times for both the HP 3326A and HP 3585A, the display on the HP 3585A Spectrum Analyzer can be set to track the desired IMD product or the frequency response of the device under test.

The HP 3585A resolution bandwidth should be set wide enough to allow for small tracking offsets during the HP 3326A sweep and narrow enough to resolve the distortion product of interest.* During a measurement it is important that the HP 3326A and the HP 3585A automatic calibration functions be disabled to prevent possible loss of tracking during periodic calibration.

Figure 4.3

Setup for swept intermodulation distortion measurements using the HP 3326A.

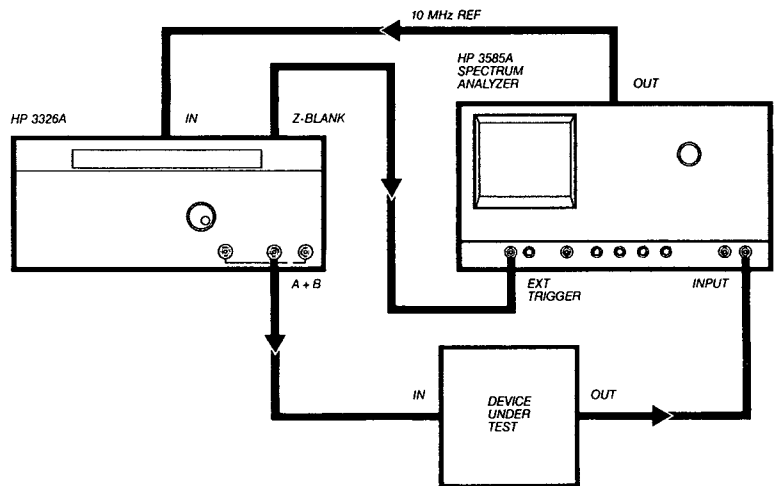

* To assure proper frequency tracking it may be necessary to disable HP 3585A multi-loop operation. This may be accomplished through the use of HP 3585A Test Mode 06 (See HP 3585A Service Manual pg. 11-3).

Using this setup, a reference trace is first taken of the frequency response of the device under test using only the Channel A output from the HP 3326A. This is accomplished by disabling the internal combiner and setting the Channel A start/stop sweep frequencies to sweep the IMD response frequency range. The same start/stop frequencies are set on the HP 3585A. With the device under test connected, a single sweep is triggered on the HP 3326A, and the reference frequency response is displayed on the HP 3585A display. This reference frequency response is stored in the the HP 3585A trace memory using the Store A—B function.

Next, the HP 3326A Channel A and B sweep frequencies are set to produce a two-tone signal that will result in the desired IMD products over the frequency range of the reference sweep. The HP 3326A internal combiner is turned on and the combined output is at the Channel A output connector.

The HP 3326A single sweep function is triggered and the response on the HP 3585A display is stored in trace memory A. The intermodulation distortion level is the difference between the displayed IMD response and the reference reading in trace memory B which can be seen by viewing both trace A and B simultaneously.

• **IF Amplifier Example**

An example of swept third-order IMD measurement of an IF amplifier and filter is shown in Figure 4.4. The swept two-tone frequencies from HP 3326A Channel A is from 430 kHz to 480 kHz and Channel B is swept from 431 kHz to 481 kHz. The HP 3326A internal combiner is turned on for a combined output. Equal amplitude signals of -30 dBm are used at both channels and sweep time is 20 seconds. The HP 3585A Spectrum Analyzer is set to sweep from 429 kHz to 479 kHz with a resolution bandwidth of 100 Hz. A reference frequency response measurement is made with the HP 3326A set to sweep from 429 kHz to 479 kHz. In this example, the third-order IMD level can be seen as the difference between the upper reference trace and the lower measurement trace of Figure 4.4.

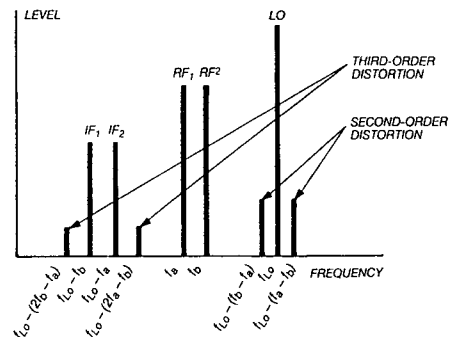

Figure 4.4
Swept third-order distortion measurement of an IF amplifier and filter. Distortion level is the difference between the reference trace (upper) and the measurement trace (lower). Vertical axis 10 dB/div.; Horizontal axis 429 kHz to 479 kHz.

• **Mixer Example**

To measure the third-order IMD response of a mixer, the HP 3326A is set to produce two closely spaced signals f_a and f_b with the internal combiner turned on. This two-tone signal is used as the RF input to the mixer and is mixed with a local oscillator to produce two IF signals with third-order distortion products as shown in Figure 4.5.

Figure 4.5
Mixer distortion products.



An example of a swept third-order mixer distortion measurement is shown in Figure 4.6. In this example, the HP 3326A Channel A frequency is swept from 10.3 to 9.7 MHz while Channel B frequency is swept from 10.31 to 9.71 MHz. With a mixer local oscillator frequency of 10.475 MHz, the HP 3585A Spectrum Analyzer is set to sweep from 155 kHz to 755 kHz to track one of the third-order responses during the measurement. As in the previous example, a reference frequency response measurement should be taken. The HP 3326A Channel A sweep should be from 10.32 MHz to 9.72 MHz during the reference sweep.

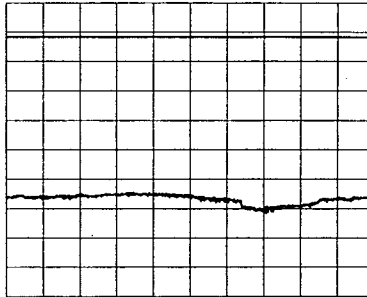

Figure 4.6
Swept third-order distortion of a mixer at the IF output. Distortion level is the difference between the two traces. Vertical axis 10 dB/div.; Horizontal axis 155 kHz to 755 kHz.

SEQUENTIAL TONE SIGNALING

Application

Selective calling systems are used in communications for enabling of pre-determined communication equipment. An example of this is dual-tone multiple-frequency (DTMF) signaling used in touch-tone telephone equipment. Multiple-tone signalling is also used in personal pagers and mobile radio applications. These applications require one or more sources with fast frequency switching to simulate tone encoders and test tone decoders.

Measurement Considerations

Available selective calling systems represent a wide variety of tone formats. These formats differ in the number of tones present simultaneously, the time duration and amplitude of each tone, and the number of tones in a sequence. In communication systems with a large number of receiving devices, the tone format can be complex in order to accommodate many different device addresses. Let's look at an example with the DTMF format:

• Dual-Tone Multiple-Frequency (DTMF)

This format requires a sequence of tone pairs as specified in tone encoding standards such as EIA RS-470, Bell Technical Reference Pub. 48005 and CCITT. Table 4.1 lists the tone-pair frequencies for each touch-tone digit.

The critical level, timing, frequency accuracy and distortion performance parameters are listed in Table 4.2. A typical DTMF timing sequence is shown in Figure 4.7.

Low-Group Frequencies (Hz)	High-Group Frequencies(Hz)			
	1209	1336	1477	1633
697	1	2	3	A
770	4	5	6	B
852	7	8	9	C
941	*	0	#	D

Table 4.1 DTMF Frequency Assignments.

Parameter	Performance Standard
Minimum Tone Duration	50 ms
Minimum Interdigital Time	45 ms
Minimum Cycle Time	100 ms (10 tones per second)
Nominal Signal Level	-6 to -4 dBm (600 Ohms)
Frequency Accuracy	± 1.2%
Total Distortion	≤ 10% above 500 Hz (Bell) ≤ 2% below 3400 Hz (CCITT)

Table 4.2 DTMF Performance Parameters.

HP 3326A Solution

The HP 3326A Discrete Sweep function can be used to generate rapid tone sequences at either or both of its two outputs. This feature takes advantage of fast internal hardware switching time (as fast as 5 ms) and internal Save-Recall Memory for a frequency list.

The frequencies of each channel and a corresponding dwell time are stored for each element of Discrete Sweep. Up to 63 frequency-time combinations can be stored in memory and then sequentially accessed using single or continuous sweep triggering. In the single sweep mode, an external signal can be used to trigger the sweep. Individual tones may be accessed through the Recall Discrete function. The amplitude of the tones are all equal during Discrete Sweep.

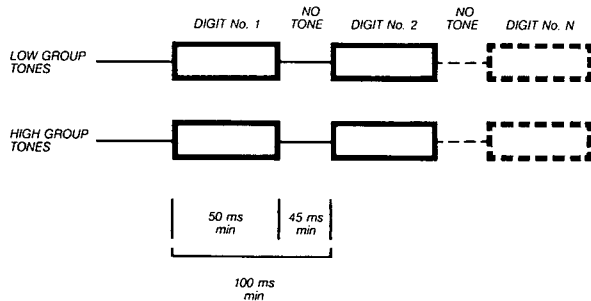

Figure 4.7
The timing sequence for a dual-tone multiple-frequency (DTMF) signal.

• **DTMF Example**

The following procedure shows the keystroke sequence for setting up a DTMF signal corresponding to the digits 7-1-5.

1. Select the Two-Channel mode and set the amplitude to 0.38 Vrms. This level is approximately equal to the voltage into 600 Ohms at -6 dBm. Activate the output combiner and clear the discrete memory before proceeding.
2. Set Channel A frequency to 852 Hz and Channel B frequency to 1209 Hz. This corresponds to the DTMF 7 digit. Set sweep dwell time to 50 ms and store this frequency pair and dwell time in discrete memory location 00.
3. Set Channel A and Channel B frequencies to 0 Hz (or alternately to a frequency above the cutoff frequency of a low-pass filter optionally placed in the HP 3326A output). Set sweep dwell time to 45 ms and store in location 01. This corresponds to an interdigital no-tone state.
4. Set the Channel A and B frequencies to 697 Hz and 1209 Hz (DTMF 1) respectively, with the same dwell time and store in location 01. Repeat for the frequency pair 770 Hz and 1336 Hz (DTMF 5) and same dwell time and store in location 02.
5. Repeat Step 3 for the interdigital no-tone state using location 03.
6. Select the Discrete Sweep mode, then trigger the sweep sequence with a single or continuous sweep keystroke. The combined DTMF signal is available at the Channel A output with the HP 3326A combiner activated.

*5. TWO-PHASE MODE OPERATION
AND APPLICATIONS*

TWO-PHASE MODE OPERATION GETTING STARTED

1. Instrument Preset.

To establish a known setup prior to entering setup data, press the green INSTR PRESET key. Upon preset, the HP 3326A assumes the following setup characteristics:

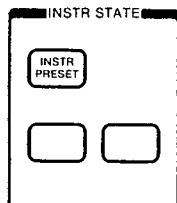

PRESET.

Mode	2 CHANNEL
Frequency A and B	1000 Hz
Amplitude A and B	100 mVp-p
DC offset A and B	0 V
Phase	0 deg
Modulation	Off
Modulation level	30%
Sweep	Off
	Single ramp
	13 MHz span
	1 s sweep
Function A and B	Sine wave
Calibration	Internal
Autocalibration	Off

2. Select Mode—2 PHASE.

For Two-Phase setups, press the MODE key to illuminate the 2 PHASE indicator. The HP 3326A now operates as two tracking sources with a variable phase offset.

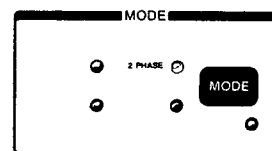

SELECT MODE.

3. Set Data and Entry Parameters.

Prior to entering data parameters, press the CHAN key to select the channel to be modified. The channel selected is indicated by the illuminated channel indicator.

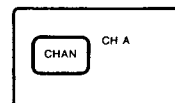

SELECT CHANNEL.

Select an ENTRY key corresponding to the parameter to be modified. An indicator for the FREQ, AMPTD, PHASE, DC OFFSET, DUTY CYCLE and % AM/PM DEV ENTRY keys illuminates after the respective key is selected and the current value for the parameter is displayed.

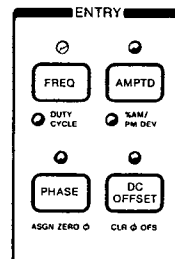

SET ENTRY.

Enter new values into the display area with the numeric keypad and terminate the entry with the appropriate units key in the DATA block. Prior to ending the entry with the units keys, erroneous entries are corrected by removing display digits with the BACK SPACE key or canceling the entry by pressing an ENTRY key. Entering an invalid value results in an error message and rejection of the entry. Appendix A contains a listing of the error messages and a description of the fault. Figure 5.1 illustrates entering setup values into the HP 3326A.

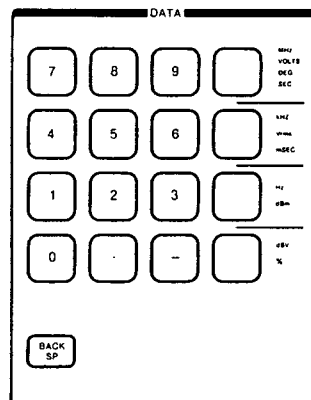

ENTER VALUES.

1. CHAN (CH A)		
2. AMPTD	1	• 1 2 5 VRMS
3. FREQ	1	0 kHz

1. CHAN (CH B)		
2. AMPTD	1	• 1 2 5 VRMS
3. PHASE	4	5 DEG

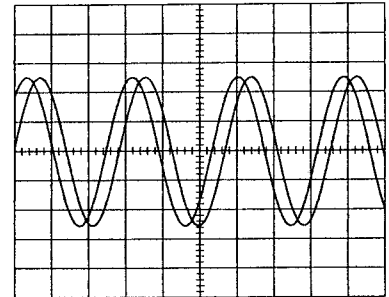
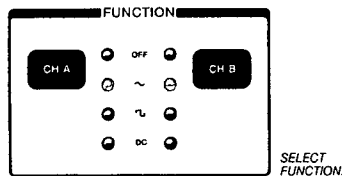

Figure 5.1
Two-Phase mode keystroke example resulting in the above output signals.

4. Select Function.

The output waveform for each channel is selected with the FUNCTION keys. The output for each channel can be disabled or set to sine wave, square wave, or dc output (dc offset) only.



5. Connect Device Under Test.

Connect the HP 3326A outputs to the test device and other instruments used in the measurement as required. For two-phase measurements, the Channel A output is used as the output reference.

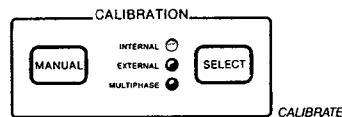

6. Calibration.

Before making a measurement, calibrate the HP 3326A with the MANUAL key. Amplitude, dc offset, and internal modulation are calibrated internally when the MANUAL key is pressed. Phase calibrations are based upon the selection made with the CALIBRATION SELECT key. Internal calibration senses phase at the HP 3326A outputs. External calibration senses phase at a point external to the HP 3326A through the CH A EXT CAL INPUT and CH B EXT CAL INPUT as shown in Figure 5.2. Multiphase calibration uses the phase of an external frequency source as a reference and calibrates the HP 3326A phase with respect to that reference. Multiple Phase Operation in this chapter discusses multiphase calibration and operation.

Figure 5.2
External phase calibration connections.

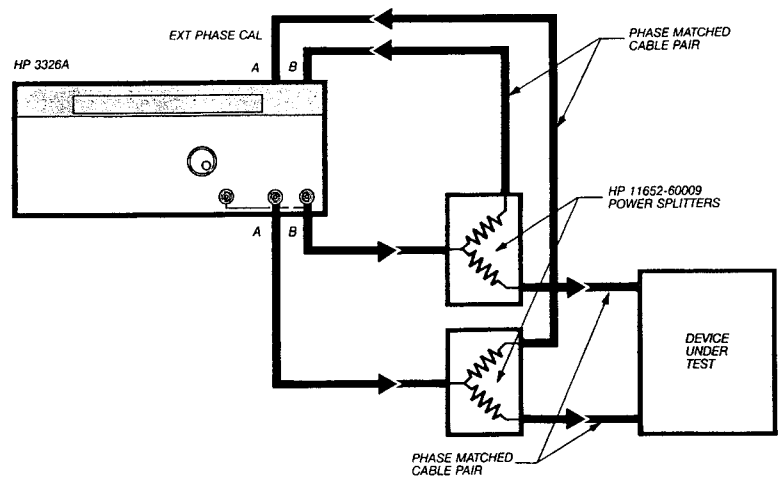

TWO-PHASE MODE APPLICATIONS

SERVO SYSTEM STABILITY

Application

Accurate characterization of servo system stability used in electromechanical applications such as helicopter autopilots, bicycle ergometers and process control is needed to assure proper operation. Low frequency gain/loss and phase shift measurements are needed to characterize these servo systems. These low frequency measurements are also important in medical, geophysical and mechanical applications.

Measurement Considerations

The stability of a servo system can be determined using conventional techniques of measuring the magnitude and phase vs. frequency of the servo loop. The results can be plotted in several forms to characterize the servo system. A plot of phase versus magnitude on the complex s-plane is a Nyquist diagram. Log magnitude versus log frequency is a Bode plot. Plotting log magnitude versus phase yields a Nichols chart.

HP 3326A Solution

• Phase Shift

With the test setup shown in Figure 5.3, the HP 3326A is used to make accurate and simple phase shift measurements. This technique involves comparing the sinusoidal output of the device under test to the sinusoidal output of the HP 3326A Channel B signal, then adjusting the Channel B phase until a phase null is reached. The phase angle of the device under test is read directly from the HP 3326A Channel B phase display.

A phase null is indicated on an oscilloscope, configured in the X-Y mode. The X-Y mode produces a straight line Lissajous pattern, as shown in Figure 5.4.

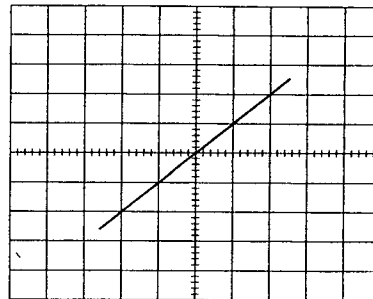
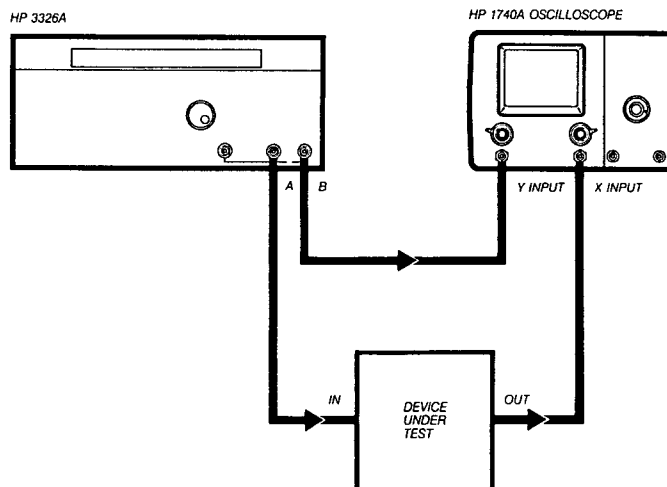

Figure 5.4

A phase null is indicated by a straight line on the oscilloscope display.

Figure 5.3

Setup for measuring phase shift using the Lissajous technique.



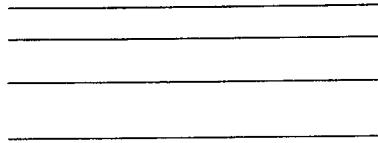

The null technique yields high phase sensitivity with excellent repeatability. By increasing the oscilloscope scaling factor, small changes can be observed near null. The accuracy of the phase shift measurement is limited by the HP 3326A phase accuracy, the depth of the null and the phase match of the X and Y oscilloscope inputs.

Normally at low frequencies small differences in cable lengths along the signal paths to the oscilloscope do not introduce significant phase errors. However, at RF frequencies, as in some electronic applications, the effects of different cable lengths should be considered. Errors can be minimized by using the HP 3326A's built-in internal or external phase calibration capability and is recommended before making a measurement.

• **Gain/Loss**

To accurately determine the magnitude of the gain (or loss) in the servo loop, the HP 3326A's output attenuator can be used as a standard in a substitution measurement. Using this technique, the oscilloscope is placed in the normal time base mode, and the output of the servo loop under test is connected to the Y-axis input. Temporarily replace the servo loop under test with a through connection to establish a reference level on the oscilloscope, then note the HP 3326A Channel A output level. Now reconnect the device under test and adjust the HP 3326A Channel A output level for an oscilloscope display at the reference level. The difference between the reference level and the readjusted HP 3326A output level in dB is the servo loop gain at the test frequency.

TRACK-AND-HOLD SETTLING TIME

Application

Track-and-hold circuits are commonly used in analog-to-digital converters. Their design and performance evaluation often requires the measurement of settling time after a full scale input change. The characteristics of the amplifier in track-and-hold device usually determine settling time. A model of a typical track-and-hold circuit is shown in Figure 5.5. In this model, the amplifier input tracks the signal at all times and samples of the amplifier output are taken and held for various times after a full scale input change.

Measurement Considerations

The value of the sampled signal can be measured on a digital voltmeter for various delay times after a full scale track and hold circuit input level change. A test setup for this measurement is shown in Figure 5.6. In this setup, the gate signal is a particular logic level (e.g., TTL, ECL, CMOS, etc.) and the input level is rapidly changed between the device minimum and maximum values to simulate a full scale range change.

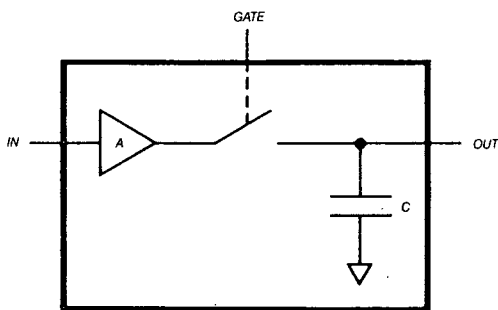

Figure 5.5
A block diagram of a typical track-and-hold circuit.

HP 3326A Solution

The HP 3326A Two-Phase mode with square wave output is used to generate both a rapidly changing input signal and the gate signal with a known delay time as shown in Figure 5.7. The HP 3326A Channel B dc offset and square wave amplitude are adjusted to produce the required gate logic signal. This gate signal is also used to trigger the digital voltmeter which measures the sampled value. The delay time T is related to the HP 3326A Channel B phase offset $\Delta\phi$ as given by the equation $T = \Delta\phi / (360 \times \text{freq}(\text{Hz}))$.

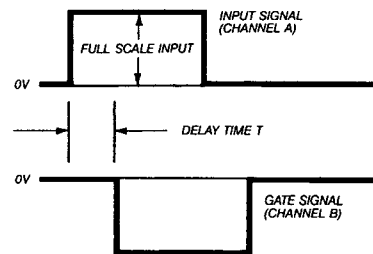

Figure 5.7
The HP 3326A Two-Phase mode is used to generate both the input and gating signals with an accurate delay time.

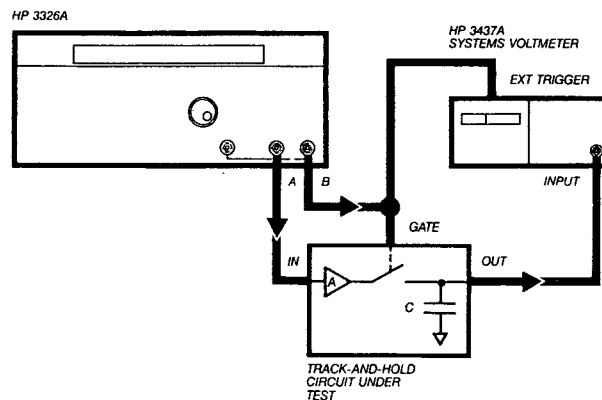

Figure 5.6
Track-and-hold settling time measurements can be made with this setup using an HP 3326A.

The HP 3326A performance allows precise delay times to be generated. The minimum delay is determined by the residual PM performance of the HP 3326A. Residual PM causes gate jitter of approximately 0.1 percent of a period (e.g., 1 ns at 1 MHz and 1 μ s at 1 kHz). The rise/fall time of the HP 3326A square wave is approximately 15 ns.

The maximum delay time is two periods of the test frequency. By varying the delay time (Channel B phase) and taking a series of readings on the digital voltmeter the track and hold settling characteristics can be measured as a function of time after a full scale input change. Figure 5.8 shows a settling time measurement using this procedure.

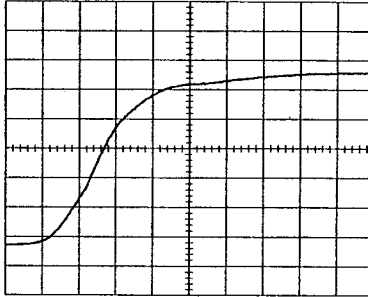

Figure 5.8
Example of a track-and-hold settling time measurement.

BALANCED OUTPUT

Application

A balanced output has two lines which are symmetrical about ground, with equal signal levels and 180 degrees out of phase. Balanced outputs are used to drive balanced loads such as a balanced line used in high speed data transmission to remote terminals from a central computer. They are also used to drive symmetrical circuits such as switching regulators or amplifiers.

Measurement Considerations

Many of these applications requiring a balanced output can be driven directly with respect to ground. For those applications requiring a non-grounded reference point or floating balanced signals, balancing transformers are commonly used. Impedances such as 124, 135, 150, 300, 600 or 900 Ohms may also be required in these applications.

HP 3326A Solution

The HP 3326A can be used to produce two signals with a 180 degree phase relationship using the Two-Phase mode. The two signals can be set to equal levels and both are referenced to ground. The equivalent circuit for this is

shown in Figure 5.9. Note that the output impedance is twice that of each HP 3326A output or 100 Ohms (without the High Voltage Output Option) and the Channel A and B levels are each one-half of the balanced output level.

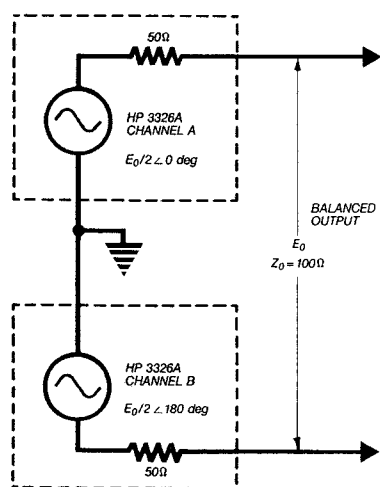

Figure 5.9
Equivalent circuit of the HP 3326A output when used as a balanced source.

For those applications requiring other impedances, it is a simple matter to add a balanced attenuator to the HP 3326A output as shown in Figure 5.10. The values for R1 and R2 are given by the following equations where ZS = 100 Ohms (HP 3326A balanced output impedance) and ZL is the load impedance.

$$R1 = ZS / \sqrt{1 - ZS/ZL}$$

and

$$R2 = ZL / 2 \sqrt{1 - ZS/ZL}$$

Values for R1 and R2 are listed in Table 5.1 for some of the common balanced output impedances. Attenuation values are also listed so that the HP 3326A output level can be increased to compensate for the loss in the attenuator pad.

HP 3326A

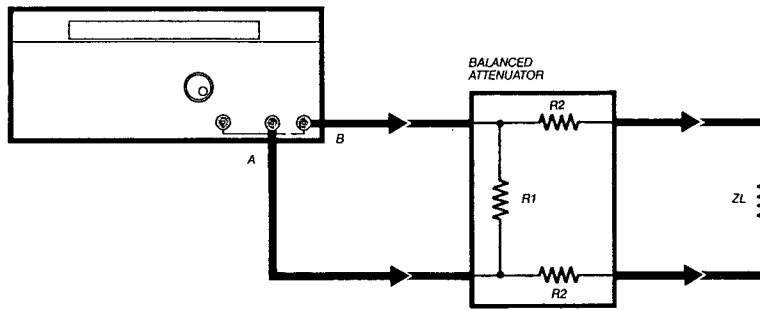

Figure 5.10

Output impedances other than 100 Ohms can be obtained using a balanced attenuator pad.

<i>Impedance(ZL) (Ohms)</i>	<i>R1 (Ohms)</i>	<i>R2 (Ohms)</i>	<i>Attenuation (dB)</i>
124	227.3	27.3	4.10 dB
135	196.4	34.4	4.88 dB
150	173.2	43.3	5.72 dB
300	122.5	122.5	9.96 dB
600	109.6	273.8	13.42 dB
900	106.1	424.3	15.31 dB

Table 5.1 Balanced attenuator values for various impedances.

PHASE DETECTOR TESTING

Application

A phase detector is an important component in phase-locked loops, communication systems and many other applications. The function of a phase detector is to produce an output signal that is proportional to the phase difference between its two input signals. An ideal phase detector has a linear transfer function between its output and input. Characterization of this transfer function is important in order to analyze overall system performance.

Phase Detector Measurement Considerations

The slope of a phase detector transfer function is a key factor in the loop gain of a phase locked loop. The distortion characteristics of a phase demodulator are related to detector linearity. The slope or linearity of the transfer function may vary over the detectors' input range.

Measurement of detector characteristics can be difficult because the non-linearity of interest frequently occurs over a small region such as the zero crossover point. A phase detector characteristic with a change in slope around zero phase is shown in Figure 5.13. Phase modulation techniques can be used to simplify the measurement of phase detector linearity and gain.

HP 3326A Solution

The HP 3326A is particularly useful for phase detector testing because it provides the required two input signals and can be phase modulated. In addition, it has the phase resolution and accuracy required and offers both sine wave and square wave signals for testing both analog and digital types of detectors. HP 3326A PM linearity is ± 0.5 percent of the best fit straight line over a ± 360 degree range.

Figure 5.11

A typical phase detector transfer function. Vertical axis 100 mv/div.; horizontal axis 75 deg/div.

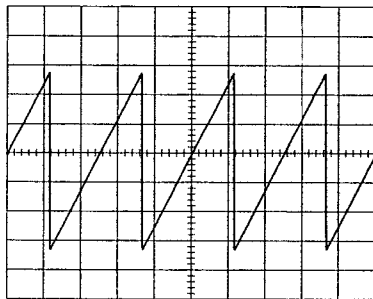

Figure 5.12 shows a test setup for measuring phase detector characteristics. Using the HP 3326A Two-Phase mode, Channel B phase is adjusted for operation at the detectors' region of interest. The HP 3326A Channel A and B output levels and waveforms are adjusted to be compatible with the phase detector input requirements.

The HP 3326A Channel A output is externally phase modulated with a sine wave (or triangular wave) from the HP 3314A Function Generator at a convenient rate below 5 kHz. This signal also drives the X-axis of the HP 1740A Oscilloscope. The phase detectors' output level versus input phase is displayed on the oscilloscope. Resolution can be increased by reducing the peak deviation and increasing the oscilloscope sensitivity. Figure 5.13 shows an example of a phase detector transfer function characteristic as measured with this technique.

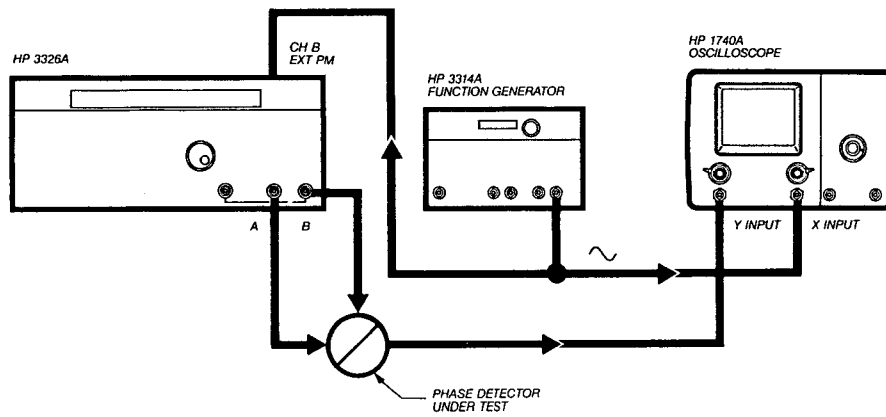

Figure 5.12
Setup for phase detector testing using the HP 3326A.

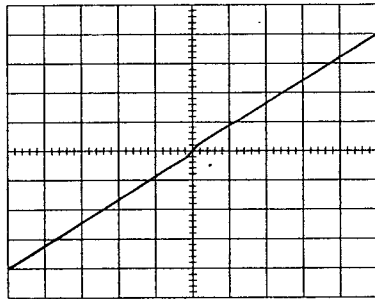

Figure 5.13
A digital phase detector response to input changes centered around zero phase. Vertical axis 50 mV/div.; Horizontal axis 10 deg/div.

PHASED ARRAY STEERING

Application

The directivity pattern of multiple-element phased arrays such as those used in sonar, medical ultrasound imaging and radio communications are usually steered in a particular direction. Steering allows the main lobe of the directivity pattern to be concentrated at an object or in a desired direction. This minimizes transmitter power requirements and maximizes the received signal level. Steering also reduces the effects of unwanted interference and is of particular importance in pulse applications where it reduces the effects of echoes.

Directivity pattern steering can be accomplished by controlling the signal time delay between the individual transducer elements in the array as illustrated in Figure 5.14. The phase difference between the wavefronts at each array element is a function of the azimuth direction. By adding the proper time delay or phase offset to (or from) each element, the combined array can be made to constructively add signals in the desired direction or reject those in other directions.

Measurement Considerations

The HP 3326A offers high resolution phase control that is needed in array steering applications. Two or more HP 3326A's can be used together to generate the required number of signals with an accurate phase relationship for multiple phase applications. The use of additional HP 3326A's does not require a phase meter or other instruments to maintain calibration. A built-in multiphase calibration function can be used to align the phase of these additional HP 3326A's to a reference phase. This subject is discussed in this chapter under Multiple Phase Operation.

HP 3326A Solution

The method of phase control varies depending upon the array design, but in general, consists of either controlling the phase at the operating frequency of the array, or controlling the phase of a local oscillator signal in a mixer scheme. Figures 5.15 and 5.16 are block diagrams of typical phasing schemes.

Figure 5.14
Operation of an electronically steerable phased array.

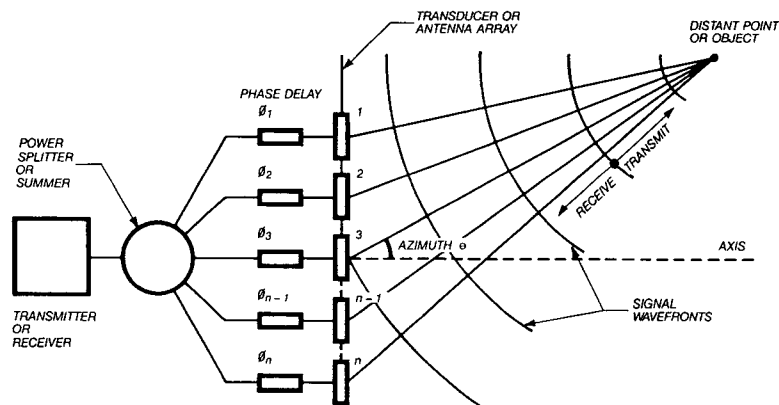

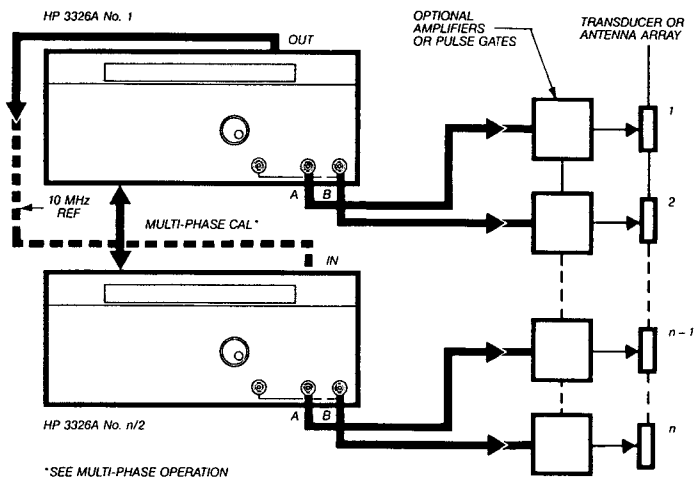

Figure 5.15

Each element of a phased array may be driven with the proper phase relationship from separate HP 3326A outputs.

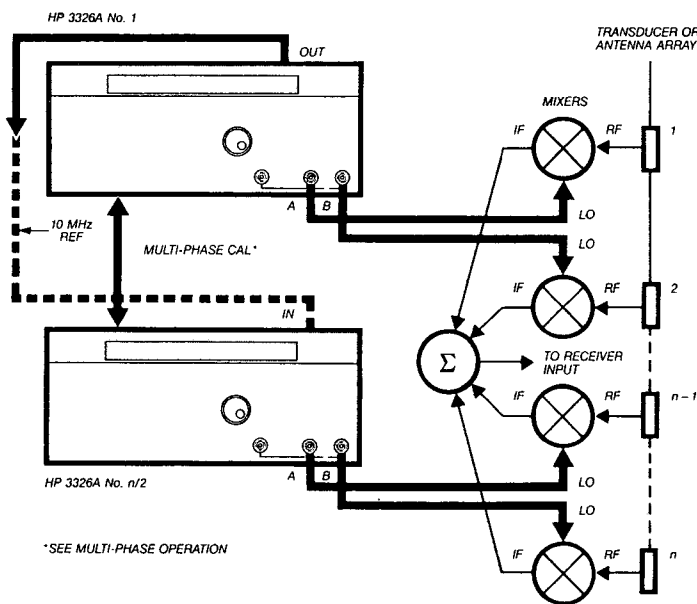

Figure 5.16

A mixer scheme can be used where the phase of the local oscillator is varied to steer or focus the array. The mixer outputs are summed and used as the receiver input.

MULTIPLE PHASE OPERATION

Application

Many applications require accurate phase relationships between more than two signals. Multiple single output sources with adjustable phase capability can be used to generate multiple phase signals. However, this usually requires additional instruments such as a phasemeter to set and maintain a calibrated phase relationship between the signals. The additional equipment can be expensive and complicates the measurement.

Measurement Considerations

Two or more HP 3326A's can be used together to simplify the multiple phase measurement problem in several ways. First, built-in multiphase calibration capability can be used to align the phase of one or more HP 3326A's to a reference phase. Once aligned, the phase of any output signal can be adjusted to the required offset without the need for additional instruments. Second, by providing two phase related signals in one instrument, the number of required source instruments is reduced.

Multiphase calibration is accomplished with two easy keystrokes. Use the Select key to select the Multiphase Calibration mode, then press the Manual key to initiate the calibration.

HP 3326A Solution

Suggested connection diagrams for three and four phase operation are shown in Figures 5.17 and 5.18, respectively. Additional phases can be added by further splitting reference Channel A output to provide calibration signals for more HP 3326A's until the calibration input level falls below +4 dBm (1 Vp-p). The use of two-resistor

power splitters as shown in the figures with phase matched outputs is recommended for highest accuracy.

Three power splitters, with 6 dB loss each, will provide an external phase calibration input level of +6 dBm at an HP 3326A output level of +24 dBm. With seven power splitters an additional seven HP 3326A's can be added for a total of sixteen phases. Additional phases can be added by using Channel A output to provide calibration signals for more HP 3326A's until the calibration input level falls below +4 dBm (1 Vp-p). The use of two-resistor

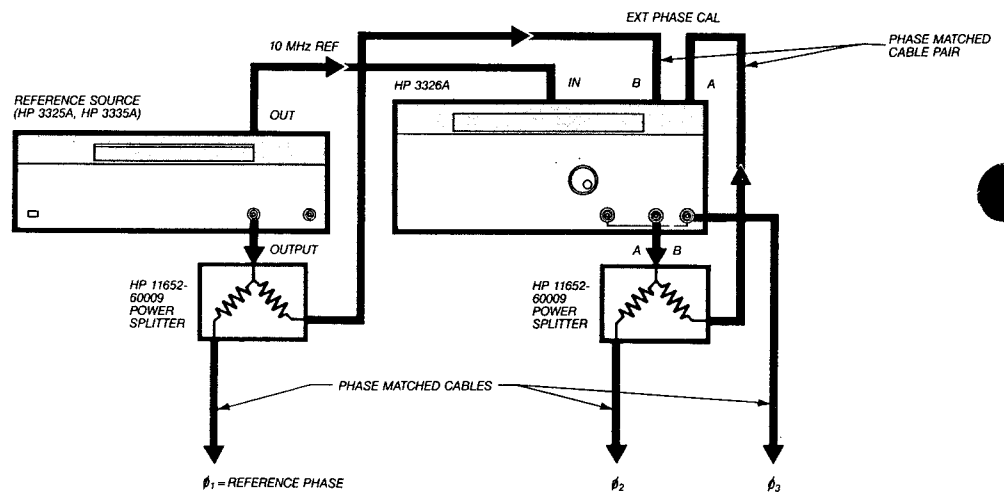

Figure 5.17
Setup for three-phase operation using the HP 3326A with another synthesizer.

The following rules must always be applied for accurate calibration. Significant errors beyond instrument accuracy can be introduced if these rules are not used:

1. The paths for the rear panel A and B external phase calibration inputs must be phase matched to each other for each HP 3326A. This rule also applies to the signal paths from each HP 3326A front panel output to the load. These paths may include one or more power splitters.

2. Calibration must be done with the same waveforms and equal signal levels ($\geq +4$ dBm or 1 Vpp) at the phase calibration inputs. User test levels may be different than the output levels required during calibration. In this case, the levels will have to be changed momentarily during calibration.

3. Calibration can be done only above 1 kHz, but is valid below 1 kHz if all sources are HP 3326A's and are triggered to change frequency simultaneously.

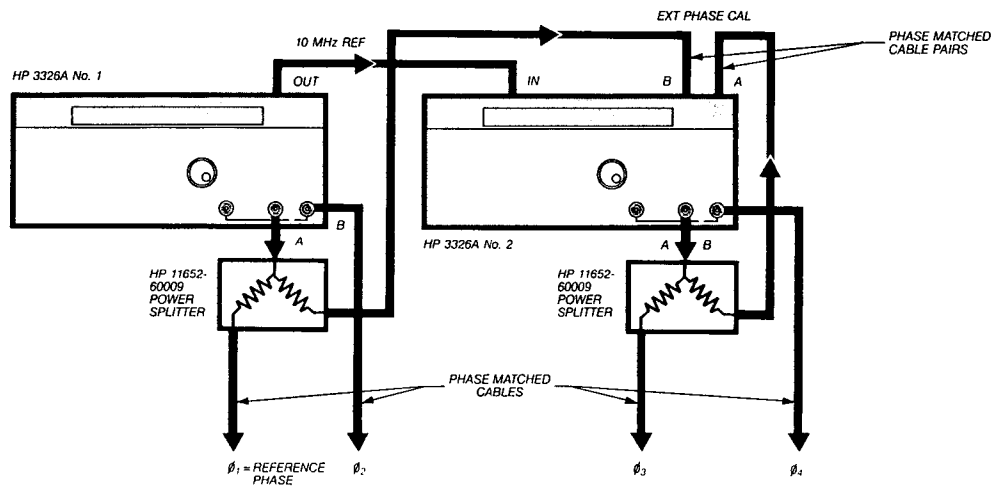

Figure 5.18
Setup for four-phase operation using a second HP 3326A.

APPENDIX A. ERROR MESSAGES

APPENDIX A. ERROR MESSAGES

This Appendix lists the error message and code set for the HP 3326A. A description of each error is given to assist the user in correcting a particular error condition. These error messages and codes are indicated on the HP 3326A display and the codes are available via the HP-IB. Errors are caused by either improper programming or instrument faults.

Message	Code	Description
SNTX	10	HP-IB command has syntax error or contains illegal characters.
RMOT	11	Front panel key pressed while HP 3326A in remote.
LOCK	12	LOCAL key pressed while HP 3326A in local lockout.
RNGE	20	Value entered for selected parameter exceeds valid limits.
RNGE	21	In 2 TONE mode, Channel B offset frequency greater than 100 kHz.
RNGE	23	Discrete frequency sweep element save nonsequential with existing elements, or instrument state save breaks continuity of discrete frequency elements.
RNGE	24	Marker frequency entered is outside sweep span.
RNGE	25	Frequency value greater than 1 MHz entered with high voltage option active.
RNGE	26	Frequency value greater than 5 kHz entered with internal PM active, or greater than 100 kHz with internal AM active.
B FR	30	In 2 TONE mode with Channel B high voltage option enabled, Channel B frequency cannot track change to Channel A frequency.
INTR	40	Value that cannot be displayed has been interrogated over the HP-IB.
RNGE	46	Internal modulation enabled and Channel B amplitude or offset selected as display value.
RNGE	47	Channel B phase selected as display value when PULSE mode enabled.
CNVT	50	Units conversion results in zero display value.
SUFY	60	Units key selected improper for parameter selected.
SUFY	65	High voltage option enabled and dBm selected as units.
INC	70	Increment value or units incompatible with displayed value.
AMPL	80	Combiner selected but not enabled because current amplitude value is too large.
MODL	86	Combiner selected but not enabled because Internal AM or PM is enabled.
MODE	87	Requested operation or function incompatible with mode selected.
FREQ	88	Internal PM selected with Channel B frequency greater than 5 kHz, or internal AM selected with Channel B frequency greater than 100 kHz.
CMBR	89	Combiner selected but not enabled because AM or PM enabled.
SWFR	90	Frequency sweep start and stop frequencies are equal for both channels.
DUTY	94	Pulse duty cycle too narrow for sweep range.
SWFR	95	High voltage option enabled and sweep frequency is greater than 1 MHz.
SWFR	96	Channel B frequency exceeds 5 kHz internal PM limit or 100 kHz internal AM limit during sweep.
RATE	100	Sweep rate less than 5 mHz/s or greater than 0.5 MHz/ms.
DSWP	110	No discrete frequency sweep elements exist for discrete frequency sweep.
DSWP	114	Frequency too high for duty cycle requested during discrete frequency sweep.
DSWP	115	High voltage option enabled and discrete frequency sweep element frequency exceeds 1 MHz.
DSWP	116	Channel B frequency exceeds the 5 kHz internal PM limit or 100 kHz internal AM limit during discrete frequency sweep.
DSWP	117	Discrete frequency elements in memory incompatible with selected mode.

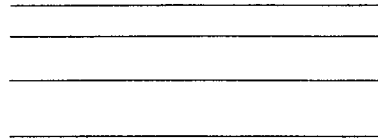

Message	Code	Description
P OF	120	Cannot clear Channel A phase offset.
H V	130	High voltage option selected and not installed.
H V	136	Channel B high voltage option selected with internal modulation.
H V	138	High voltage option selected when frequency is greater than 1 MHz.
CSUM	140	A checksum error for recall, learn, or program operation.
CSUM	150	Current instrument configuration incompatible with recalled or programmed state.
CRPT	160	An error is detected in an instrument state recalled from memory and instrument state is replaced with preset state.
A OL	170	Channel A output is overloaded.
B OL	171	Channel B output is overloaded.
SYOL	172	SYNC output is overloaded.
AVCO	173	Channel A voltage controlled oscillator is unlocked.
XREF	180	HP 3326A cannot lock to external reference signal that is present.
MCAL	190	Unsuccessful internal AM or PM calibration.
PCAL	191	Unsuccessful phase calibration.
ACAL	192	Unsuccessful amplitude calibration.
OCAL	193	Unsuccessful dc offset calibration.
	194	Unsuccessful residual dc offset calibration.
PASS	-	Successful self test.
FAIL	-	Unsuccessful self test.

FOR MORE INFORMATION: Call your HP Sales Office listed in the telephone directory white pages. Ask for the Electronic Instruments Department. Or write to Hewlett-Packard: **U.S.A.:** P.O. Box 10301, Palo Alto, CA 94303-0890. **Europe:** P.O. Box 999, 1180 AZ Amstelveen, The Netherlands. **Canada:** 6877 Goreway Drive, Mississauga, L4V 1M8, Ontario. **Japan:** Yokogawa-Hewlett-Packard Ltd., 3-29-21, Takaido-Higashi, Suginami-ku, Tokyo 168. Elsewhere in the world, write Hewlett-Packard Intercontinental, 3495 Deer Creek Road, Palo Alto, CA 94304 U.S.A.

*HP-IB INTRODUCTORY
OPERATING GUIDE*

*HP-IB INTRODUCTORY
OPERATING GUIDE*



Programming Note

3326A/9000 SERIES 200-1

SEPTEMBER 1984

Supersedes: None

Introductory Operating Guide for the HP 3326A Two-Channel Synthesizer with the HP 9000 Series 200 Desktop Computer (BASIC)

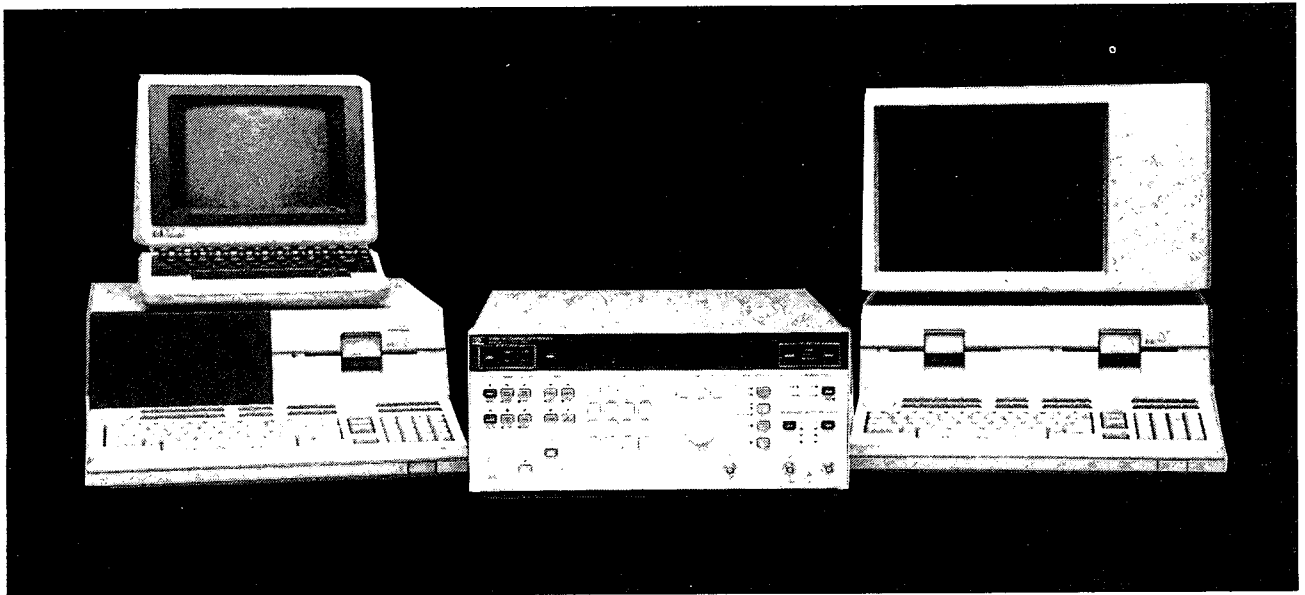

INTRODUCTION

This programming note is an introduction to the remote operation of the HP 3326A Two Channel Synthesizer. System setup and checkout instructions are included, along with a number of example programs. These programs will demonstrate some of the capabilities of the 3326A and can serve as a starting point for programs tailored to a user's specific needs.

The HP 3326A Two Channel Synthesizer combines two independent synthesizers, flexible modulation, and control circuitry into a single instrument. It provides precise phase-offset, two-tone sweep, random frequency switching, internal modulation, and pulse signals for bench or systems use.

All examples demonstrate HP-IB control of the 3326A using the HP 9836A Desktop Computer and the enhanced BASIC 2.0 programming language. While the 9836A is referenced in all program examples, these programs will also run on the other HP 9000 Series 200 desktop computers such as the Model 216 (9816A) and Model 226 (9826A).

The topics to be covered through the use of example programs include:

- REMOTE vs. LOCAL operation
- Basic parameter setup of both channels
- Sweep operations including continuous, stepped, and discrete
- Instrument state storage and retrieval
- Service requests and error retrieval

Also included are appendices on programming codes, error codes, and the status byte of the 3326A.

REFERENCE INFORMATION

For further information on the HP Interface Bus:

- Tutorial Description of the HP-IB
HP Lit. No. 5952-0156
- Condensed Description of the HP-IB
HP Part No. 59401-90030

For further information on the HP 3326A:

- HP 3326A Operating Manual
HP Part No. 03326-90000
- Product Note 3326A-1 Quick Reference Guide to the HP 3326A
HP Lit. No. 5953-5134

For further information on the HP 9836A:

- Operating Manual
HP Part No. 09836-90000
- BASIC Language Reference
HP Part No. 09826-90056
- BASIC 2.0 Condensed Reference
HP Part No. 09826-90051
- BASIC Programming Techniques
HP Part No. 09826-90011
- BASIC Interfacing Techniques
HP Part No. 09826-90025

EQUIPMENT REQUIRED

To perform the examples described in this programming note, you will need the following equipment and accessories:

- HP 3326A Two Channel Synthesizer
- HP 9836A Desktop Computer with BASIC Programming Language (option 011 or 711)
- HP 10833A HP-IB Cable (or equivalent)

NOTE

The following equipment is not required for the programs to function but rather for a visual display of the 3326A output

- HP 1740A or equivalent two-channel oscilloscope
- Two BNC cables (HP 11170C or equivalent)

EQUIPMENT SETUP

Begin by removing power from the 3326A and 9836A.

1. As shown in Figure 1, use the 10833 HP-IB cable to connect the 3326A to the built-in HP-IB interface of the 9836A.

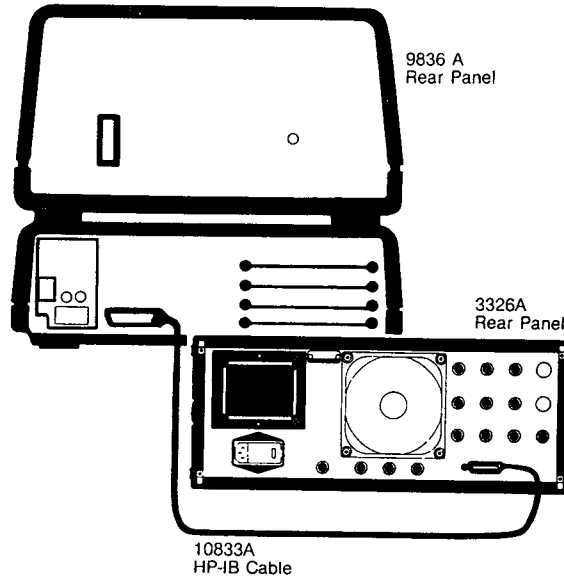

Figure 1. System HP-IB Connection

CAUTION

Do not attempt to mate black metric threaded screws on one connector with silver English threaded nuts on another connector, or vice versa, as damage may result. A metric conversion kit, which will convert one cable and one or two instruments to metric hardware is available by ordering HP Part No. 5060-0138.

2. If a visual display of the 3326A outputs is desired, connect the 3326A channel A and B outputs to the two inputs of a two-channel oscilloscope using two BNC cables. The 3326A outputs should both be terminated in 50 ohms.
3. If required, load the BASIC language operating system, following the instructions in the BASIC Operating Manual for the HP 9836A. (9836A option 711 only)
4. Turn power ON to the 3326A. All programs in this note assume the 3326A HP-IB address is decimal 18, as preset at the factory.

To display the current HP-IB address of the 3326A, press the front-panel SHIFT key, followed by the LOCAL key. The address will appear in the 3326A display as:

A d d r . = XX

where XX is a number from 00 to 30, inclusive.

If the address is not correct, enter the correct address (18) with the numeric key pad. The address is set and displayed when the second digit is entered.

The nonvolatile memory of the 3326A will retain the address while the instrument is on or off, until another address is entered.

CHECKOUT

If the BASIC operating system has been properly loaded, "BASIC READY" should appear in the 9836A display (option 711 only). If this does not occur, reload BASIC.

The following steps verify that the HP-IB connections and interface are functional:

1. Press the CLR I/O key of the 9836A to eliminate any possibility of a bus hangup.
2. Press both the SHIFT and PAUSE keys of the 9836A at the same time to reset the computer.
3. Type in "SCRATCH" on the 9836A keyboard and press the EXECUTE key. This clears any previous programs from memory.
4. Type in "REMOTE 7" on the 9836A keyboard and press the EXECUTE key. On the 3326A, both the green REMOTE and yellow LISTEN indicators should be lit.
5. If these two annunciators are not lit, perform the EQUIPMENT SETUP procedure once again and repeat this CHECKOUT procedure.

If the CHECKOUT procedure fails a second time, look for instrument or controller errors and consult the appropriate manual as listed in the REFERENCE INFORMATION section of this document.

6. When this checkout procedure passes successfully, type in "LOCAL 7" on the 9836A keyboard, followed by the EXECUTE key. The HP-IB connections and interface are now functional and the programming examples can be performed.

PROGRAMMING EXAMPLES

The following example programs cover a number of basic and advanced topics important in programming the HP 3326A.

Each programming example uses the following format:

- A general description of the program and its purpose
- A program listing
- Instructions for running the program and an explanation of the various sections of the program

EXAMPLE PROGRAM NO. 1

REMOTE, LOCAL, and LOCAL LOCKOUT operation

When operated from its front panel, the 3326A is in the LOCAL mode of operation. All front panel controls are active.

When the 3326A is under program control on the HP-IB (IEEE-488) bus, LOCAL control is disabled and the front panel is inactive. This is the REMOTE mode of operation. In this mode, the instrument can be restored to front panel control by pressing the LOCAL key or sending a LOCAL command on the HP-IB.

Issuing the LOCAL LOCKOUT command prevents all LOCAL operation and disables the action of the LOCAL key, along with the rest of the 3326A front panel controls. Front panel control can only be restored to the instrument by a LOCAL command from the controller.

The following program demonstrates these modes of operation and shows how a variable can be used in a program to define the address of a particular instrument.

1. RESET the 9836A
2. Type in SCRATCH and press the EXECUTE key to clear any previous programs.
3. Press the EDIT key, then the EXECUTE key, and type in the following program:

```
10 ! REMOTE, LOCAL, LOCAL LOCKOUT DEMO
20 !
30 Source=718
40 !
50 REMOTE Source
60 !
70 DISP "3326A IS IN REMOTE MODE"
80 !
90 PAUSE
100 REMOTE Source
110 LOCAL LOCKOUT 7
120 DISP "3326A FRONT PANEL LOCKED OUT"
130 !
140 PAUSE
150 LOCAL Source
160 DISP "3326A FRONT PANEL ACTIVE"
170 !
180 PAUSE
190 OUTPUT Source;"RST"
200 LOCAL Source
210 END
```

PROGRAM 1—EXPLANATION AND OPERATION

After the program has been entered, RESET the 9836A and press the RUN key to begin execution of the program. No oscilloscope is necessary.

Instead of using the actual instrument address (718), line 30 assigns the address to a variable that can then be used as a device "name". This makes the program easier to understand and if the instrument address changes, only one line of the program need be changed.

Line 50 places the 3326A in the REMOTE mode, and line 70 displays a message to the user on the 9836A CRT. Line 90 pauses execution of the program.

At this point, both the green REMOTE and yellow LISTEN indicators on the 3326A should be lit. Attempt to modify an instrument parameter such as FREQUENCY or AMPLITUDE. Verify that all keys except LOCAL are disabled and that an error message is displayed. Press the LOCAL key. The REMOTE annunciator will go out and the 3326A can be operated normally from the front panel.

Press CONTINUE on the 9836A to resume execution of the program. Line 110 places all instruments on the bus in the LOCAL LOCKOUT mode and program execution is paused.

Now verify that the 3326A is again in the REMOTE mode. This time, however, the LOCAL key will not return the instrument to front panel control and will generate an error message. The LOCAL LOCKOUT mode is very useful for preventing unwanted changes in parameters or states.

Press CONTINUE on the 9836A to resume execution of the program. Line 150 returns all instruments on the bus to front panel control and program execution is halted. Verify that the 3326A front panel controls are active and that the REMOTE annunciator is extinguished.

CONTINUE the program. In Line 190 an OUTPUT statement is used to command the 3326A to perform an INSTRUMENT PRESET (RST). The OUTPUT statement is a very common one in most programs and serves two functions—it first places the instrument in the REMOTE mode and then passes information or commands. In line 200 the 3326A is returned to LOCAL control.

EXAMPLE PROGRAM NO. 2 BASIC PARAMETER ENTRY

The majority of programming for the 3326A usually involves setting the basic operational parameters such as mode, channel, frequency, amplitude, etc. This program demon-

strates several ways of setting up these parameters with data from the program itself and data entered by the user. This program also covers other topics such as autocalibration and the best order for parameter entry.

RESET the 9836A, SCRATCH the memory, and press EDIT and EXECUTE to enter the following program:

```
10 ! BASIC PARAMETER ENTRY
20 !
30 Source=718
40 !
50 OUTPUT Source;"RST, CAL"
60 !
70 !CHANNEL A PARAMETER ENTRY:
80 OUTPUT Source;"CHA"
90 OUTPUT Source;"FCNA SQR, FR 1.2345 KHZ"
100 OUTPUT Source;"AM 2 UD, OF +1.05 UD"
110 !
120 !CHANNEL B PARAMETER ENTRY:
130 OUTPUT Source;"CHB"
140 OUTPUT Source;"FCNB SIN, FR 9876 HZ"
150 OUTPUT Source;"AM 1.05 VRMS; OF -0.8 UD"
160 LOCAL Source
170 PAUSE
180 !
190 !SET UP FOR INTERNAL MODULATION
200 OUTPUT Source;"RST"
210 OUTPUT Source;"CHA, FR 100 KHZ, AM 10 DBM"
220 OUTPUT Source;"CHB, FR 4.0 KHZ"
230 OUTPUT Source;"AIA ON, CAL"
240 OUTPUT Source;"ML 0 PC"
250 !
260 !INTERROGATE USER FOR INDEX
270 PRINT CHR$(12)
280 INPUT "ENTER MODULATION INDEX IN PERCENT",Index
290 IMAGE "MODULATION LEVEL IS ",DDD.DD," PERCENT"
300 PRINT USING 290;Index
310 IMAGE "ML ",DDD.DD," PC"
320 OUTPUT Source USING 310;Index
330 GOTO 280
340 END
```

PROGRAM 2—EXPLANATION AND OPERATION

After the program has been entered, RESET the 9836A and press the RUN key to begin execution of the program.

Set up the oscilloscope with channel 1 and 2 sensitivity of 1 Volt/div. and 0.2 ms/div.

Lines 50 initializes the 3326A. The RST command performs an instrument preset, leaving the 3326A in a known state. This insures that no previously used parameters or states will be incompatible with what is about to be programmed. A calibration is then performed.

In the preset mode that results from the RST command, autocalibration is disabled. If the 3326A is in the AUTOCAL ON mode, the periodic calibrations that are automatically performed may interrupt program execution. By turning these calibrations off and performing them only when necessary, such interruptions are prevented.

Lines 80-100 set up channel A. As parameters are entered from the front panel or under program control, the intermediate states that result must not create errors. These errors will cause the improper parameters to be rejected. To guard

against errors, the 3326A is first preset (RST) and parameters are entered in the following order:

- Instrument Mode
- Channel
- Output Function
- Frequency
- Amplitude
- Misc. Parameters:
 - DC Offset
 - Phase
 - Sweep Frequencies/Times
 - Modulation

Lines 130-150 set up channel B in the same manner as channel A. Several parameters may be sent with a single output statement; simply separate them with a semicolon, comma, or space.

Line 160 returns the 3326A to LOCAL control so the instrument state can be examined from the front panel. This is a chance to select a channel and press one of the ENTRY block keys to verify that the 3326A is set up according to lines 90, 100, 140, and 150 of the program.

Press CONTINUE on the 9836A to resume program execution. Lines 210-220 set the 3326A up for internal modulation with a carrier frequency of 100 kHz and modulation frequency of 4 kHz. Line 230 turns internal modulation on and performs a calibration. Modulation level is preset at 0% in line 240.

Line 270 clears the 9836A display by printing a form feed. Line 280 requests that the user input the modulation index in percent and pauses for the data to be entered.

Enter a modulation index from 0.00 percent to 100.00 percent and press CONTINUE.

Lines 290-300 print the desired modulation index on the CRT. The IMAGE statement is used to format the output and round it to two digits to the right of the decimal point.

Lines 310-320 use a similar IMAGE statement to OUTPUT the desired modulation index to the 3326A. The GOTO statement in line 330 repeats the section of the program that enables the user to enter a new modulation index.

EXAMPLE PROGRAM NO. 3 SWEEP PROGRAMMING

The 3326A can perform a variety of frequency sweeps, with one or both channels. These sweeps are programmed in much the same way as they would be set up from the front panel.

This program demonstrates sweeps in the Two Channel and Two-Phase modes, with two different types of sweep triggering.

RESET the 9836A, SCRATCH the memory, and press EDIT and EXECUTE to enter the following program:

```

10  ! SWEEP PROGRAMMING
20  !
30  Source=718
40  !
50  OUTPUT Source;"RST, CAL"
60  !
70  ! SET UP FOR TWO-CHANNEL SWEEP
80  OUTPUT Source;"CHA; AM 3.5 VD"
90  OUTPUT Source;"ST 750 HZ; SP 12.5 KHZ; STIM 1.25 SEC"
100 !
110 OUTPUT Source;"CHB"
120 OUTPUT Source;"FCNB SQR; AM 3 VD"
130 OUTPUT Source;"ST 12.5 KHZ; SP 750 HZ"
140 OUTPUT Source;"SC"
150 DISP "CONTINUOUS, TWO-CHANNEL SWEEP"
160 PAUSE
170 !
180 ! SET UP FOR TWO-PHASE SWEEP
190 Stop_freq=1000
200 OUTPUT Source;"RST"
210 OUTPUT Source;"MODE TWOP"
220 OUTPUT Source;"CHA, AM 0 DBU"
230 OUTPUT Source;"CHB, AM 0 DBU, PH -90 DEG"
240 !
250 OUTPUT Source;"SM TRGL, STIM 1.5 SEC"
260 OUTPUT Source;"ST 500 HZ, SP",Stop_freq,"HZ"
270 OUTPUT Source;"STS"
280 DISP ".TRIGGER SINGLE TWO-PHASE SWEEP"
290 FOR I=1 TO 5
300   TRIGGER Source
310   WAIT 1.5
320   TRIGGER Source
330   WAIT 1.5
340   Stop_freq=Stop_freq*2
350   OUTPUT Source;"SP",Stop_freq,"HZ"
360   NEXT I
370 LOCAL Source
380 END

```

PROGRAM 3—EXPLANATION AND OPERATION

After the program has been entered, RESET the 9836A and press the RUN key to begin execution of the program.

Set up the oscilloscope with channel 1 and 2 sensitivity of 1 Volt/div. and 0.2 ms/div. Experiment with different types of triggering.

Line 90 sets up the 3326A for a sine wave sweep on channel A from 750 Hz to 12.5 kHz with a sweep time of 1.25 seconds. The default "ramp" sweep is used, where the instrument sweeps from start to stop frequency in the specified time and resets as quickly as possible for the next sweep. Lines 120-130 configure channel B for a square wave sweep over the same limits as channel A. Sweep limits are reversed, however, to yield a downward sweep instead of an upward one.

Line 140 initiates a continuous sweep on both channels and program execution is paused. It is best to view this sweep in the oscilloscope's ALT channel mode with independent triggers for each channel. As an alternative, the channels can be viewed separately.

CONTINUE the program to set up the next sweep. Setup for the Two-Phase sweep begins on **line 190** where an initial value is established for the stop frequency. In **lines 210-230**, the 3326A is placed in the Two-Phase mode with equal amplitudes on both channels and a -90 degree phase offset for the channel B output. In **line 250** the sweep time is set at 1.5 seconds and the sweep mode is "triangle", where sweeps are from the start frequency to the stop frequency and back at equal rates.

Line 260 sets the start frequency at 500 Hz and the stop frequency at 1000 Hz, the current value of the variable Stop-freq. This value will be modified by the program later for successive sweeps. In **line 270** the trigger mode of the 3326A is established as "Start Single", where both hardware and software trigger commands will result in single sweeps. In this case, triggers are provided by the selective device trigger command "TRIGGER Source" on **lines 300 and 320**. An alternative is the group execute trigger command "TRIGGER 7". The group execute trigger command will send a simultaneous trigger to all devices on the bus and may be used to start several events at once.

Lines 290-360 form a loop that will repeatedly trigger sweeps in both directions and modify the stop frequency when each sweep is completed. The first trigger command causes the source to sweep upward to the stop frequency and stop. The program pauses for an appropriate interval to allow the sweep to be completed and sends a second trigger command, to cause the 3326A to sweep back to the start frequency.

When each sweep is concluded, **lines 340-350** cause the sweep stop frequency to be doubled and a new sweep is initiated. This process is repeated 5 times, once for each execution of the loop. **Line 370** returns the 3326A (and any other instruments on the bus) to LOCAL control.

EXAMPLE PROGRAM NO. 4 MODIFYING ENTRY PARAMETERS

Once the operating state of the 3326A has been set up, it is often necessary to modify one or more of the entry parameters (frequency, amplitude, phase, etc.). This can be done by sending successive new values for these parameters or by using the Entry Increment function.

The Entry Increment function (EINC) sends the 3326A a specific value which will then be used to increment or decrement the currently displayed entry parameter. Once the entry increment value has been sent, it is only necessary to send an up (UP) or down (DN) command to change the displayed parameter.

This technique has two major advantages: First, it is a very convenient way to make repetitive, changes of equal size. Second, it is considerably faster to send a succession of UP or DN commands than to reprogram specific values.

This program demonstrates the EINC function with frequency, amplitude, and phase changes.

RESET the 9836A, SCRATCH the memory, and press EDIT and EXECUTE to enter the following program:

```

10  ! MODIFYING ENTRY PARAMETERS
20  !
30  Source=718
40  !
50  OUTPUT Source;"RST, CAL"
60  !
70  OUTPUT Source;"CHA AM 4 V0, FR, EINC 250 HZ"
80  !
90  ! PERFORM STEPPED FREQ SWEEP
100 FOR I=1 TO 99
110   OUTPUT Source;"UP"
120   WAIT .1
130 NEXT I
140 PAUSE
150 !
160 OUTPUT Source;"CHA FR 15 KHZ, AM 1.5 V0, EINC 0.1 V0"
170 !
180 ! PERFORM STEPPED AMPL SWEEP
190 FOR I=0 TO 3
200   FOR J=0 TO 25
210     OUTPUT Source;"UP"
220     WAIT .1
230   NEXT J
240   FOR J=0 TO 25
250     OUTPUT Source;"DN"
260     WAIT .1
270   NEXT J
280 NEXT I
290 PAUSE
300 !
310 ! SET UP FOR TWO-PHASE OPERATION
320 OUTPUT Source;"RST, MODE TWOP"
330 OUTPUT Source;"CHA FR 2.5 KHZ, AM 4 V0"
340 OUTPUT Source;"CHB AM 4 V0"
350 !
360 ! SET ENTRY INCREMENT FOR PHASE
370 OUTPUT Source;"CHB, PH, EINC 30 DEG"
380 !
390 ! PERFORM PHASE INCREMENT
400 FOR I=1 TO 100
410   OUTPUT Source;"DN"
420   WAIT .2
430 NEXT I
440 END

```

PROGRAM 4—EXPLANATION AND OPERATION

After the program has been entered, RESET the 9836A and press the RUN key to begin execution of the program.

Set up the oscilloscope with channel 1 and 2 sensitivity of 1 Volt/div. and 0.2 ms/div.

Line 70 sets channel A amplitude and sends a frequency entry increment of 250 Hz. When an entry increment is sent, it must be consistent with the current entry mode of the instrument.

To perform the frequency increment or step, only an UP or DN command is required. **Lines 100-130** set up a loop to send the UP command 99 times, with a delay of 0.1 second between commands. The delay slows program execution

enough to allow the 3326A to display the updated frequency each time a command is received. The PAUSE instruction then halts program execution.

Note that the use of EINC allows any frequency increment to be performed rapidly with only a two-letter command.

CONTINUE program execution. **Line 160** sets up the 3326A for a 15 kHz, 1.5 Volt sine wave output and an amplitude entry increment of 100 mV. **Lines 190-280** create two loops nested within a third. The inner loops step the amplitude up and then down in 25 steps, thus performing an amplitude sweep. The outer loop causes this sweep to be performed 4 times. The program is once again PAUSED.

Press CONTINUE to resume program execution. **Lines 320-340** set the instrument to the TWO PHASE mode with a frequency of 2.5 kHz and an amplitude of 4 Volts on each channel. **Line 370** sets a channel B phase entry increment of 30 degrees.

Lines 400-430 decrement channel B phase in 100 steps with a delay of 0.15 seconds between steps.

EXAMPLE PROGRAM NO. 5 DISCRETE SWEEP ENTRY

In the DISCRETE SWEEP mode the 3326A will step through a sequence of user-entered frequencies on both channels. The sequence can contain up to 63 frequency pairs and an associated dwell time for each pair. Dwell times range from 5 milliseconds to 1000 seconds. Sweeps can be either continuous or single, and reset at the end of the sweep in either case. The discrete sweep elements can be entered from the front panel or through HP-IB under program control. This program demonstrates the use of an array as one of the most convenient ways of entering these elements with a computer.

In this program the array is structured in a way that makes the function of each array element easy to interpret.

RESET the 9836A, SCRATCH the memory, and press EDIT and EXECUTE to enter the following program:

```

10 ! DISCRETE SWEEP ENTRY
20 OPTION BASE 1
30 DIM Discr(5,3)
40 !
50 Source=718
60 !
70 OUTPUT Source;"RST, DCLR, CAL"
80 !
90 ! DISCRETE DATA
100 DATA 5
110 DATA 1000,2000,0.4
120 DATA 3600,1200,0.35
130 DATA 2000,4000,0.3
140 DATA 6000,2000,0.45
150 DATA 5000,10000,0.5
160 !

```

```

170 RESTORE 100
180 READ Num_e1
190 FOR I=1 TO Num_e1
200 READ Discr(I,1),Discr(I,2),Discr(I,3)
210 NEXT I
220 !
230 ! PRINT THE ARRAY
240 PRINT CHR$(12)
250 PRINT "CH A FREQ. CH B FREQ. DWELL TIME"
260 IMAGE 9D,5X,9D,5X,5D.3D
270 FOR I=1 TO Num_e1
280 PRINT USING 260;Discr(I,1),Discr(I,2),Discr(I,3)
290 NEXT I
300 !
310 ! SEND ARRAY TO 3326A AS DISCRETE PARAMETERS
320 IMAGE "DSAV ",2Z
330 FOR I=1 TO Num_e1
340 OUTPUT Source;"CHA, FR ",Discr(I,1)," HZ"
350 OUTPUT Source;"CHB, FR ",Discr(I,2)," HZ"
360 OUTPUT Source;"STIM ",Discr(I,3)," SEC"
370 OUTPUT Source USING 320;I-1
380 NEXT I
390 !
400 ! SET UP 3326A TO PERFORM DISCRETE SWEEP
410 OUTPUT Source;"CHA, FCNA SQR, AM 0 DBU"
420 OUTPUT Source;"CHB, FCNB SIN, AM 3 DBU"
430 OUTPUT Source;"SM DSCR"
440 !
450 ! INITIATE CONTINUOUS DISCRETE SWEEP
460 OUTPUT Source;"SC"
470 END

```

PROGRAM 5—EXPLANATION AND OPERATION

After the program has been entered, RESET the 9836A and press the RUN key to begin execution of the program.

Set up the oscilloscope with channel 1 and 2 sensitivity of 1 Volt/div. and 0.2 ms/div.

Line 20 specifies the default lower bound of any arrays to follow. **Line 30** reserves space in memory for the array of discrete sweep parameters to follow. **Line 70** presets the 3326A, clears any previous discrete sweep parameters, and calibrates for optimum accuracy.

Lines 100-150 construct a data stream in memory that will be used to fill the array of discrete sweep parameters. The array has 5 rows and three columns. Each row contains two frequencies for channels A and B, respectively, and an associated dwell time in seconds. The first data statement (**line 100**) contains the number of rows in the array.

Line 170 causes the succeeding read statements to begin reading data at **line 100**. This is a precaution, in case there are any other data statements in the program.

Line 180 reads the first item from the data stream, a count of the rows in the array. This count is used to construct a loop in **lines 190-210**. Each time this loop is executed, it fills a new row in the array, containing channel A and B frequencies and a dwell time.

Line 240 clears the 9836A display and **line 250** prints a header for the discrete sweep data to follow. The loop beginning in **line 270** is executed once to print each row of the array using the image (format) statement in **line 260**.

Lines 340-390 create a loop that assigns elements in the array to appropriate variables and sends them to the 3326A as discrete sweep parameters.

Line 440 sets the 3326A to the DISCRETE SWEEP mode and line 470 initiates a continuous discrete sweep.

EXAMPLE PROGRAM NO. 6 INTERROGATING ENTRY PARAMETERS

Virtually all of the current operating parameters of the 3326A can be interrogated by a computer over HP-IB. Any function that has a numeric value associated with it can be interrogated, even if the function is not currently active.

The following program demonstrates the capability of this interrogate function. User-entered frequency, amplitude, and offset parameters are transferred from the 3326A to the computer and displayed.

RESET the 9836A, SCRATCH the memory, and press EDIT and EXECUTE to enter the following program:

```

10      ! INTERROGATING ENTRY PARAMETERS
20      !
30      Source=718
40      !
50      LOCAL Source
60      PRINT CHR$(12)
70      PRINT "THE 3326A IS UNDER FRONT PANEL CONTROL"
80      PRINT "SET UP A FRONT PANEL STATE (FREQUENCY,"
90      PRINT "AMPLITUDE, OFFSET) FOR BOTH CHANNELS"
100     PRINT "AND PRESS CONTINUE"
110     PAUSE
120     !
130     ! INTERROGATE CHANNEL A PARAMETERS
140     OUTPUT Source;"CHA FR?"
150     ENTER Source;Cha_fr$
160     OUTPUT Source;"CHA AM?"
170     ENTER Source;Cha_am$
180     OUTPUT Source;"CHA OF?"
190     ENTER Source;Cha_of$
200     !
210     ! INTERROGATE CHANNEL B PARAMETERS
220     OUTPUT Source;"CHB FR?"
230     ENTER Source;Chb_fr$
240     OUTPUT Source;"CHB AM?"
250     ENTER Source;Chb_am$
260     OUTPUT Source;"CHB OF?"
270     ENTER Source;Chb_of$
280     !
290     ! PRINT PARAMETERS
300     PRINT CHR$(12)
310     PRINT "      CHANNEL A           CHANNEL B:"
320     PRINT
330     IMAGE K,4X,K
340     PRINT USING 330;Cha_fr$,Chb_fr$
350     PRINT USING 330;Cha_am$,Chb_am$
360     PRINT USING 330;Cha_of$,Chb_of$
370     LOCAL Source
380     END

```

PROGRAM 6—EXPLANATION AND OPERATION

After the program has been entered, RESET the 9836A and press the RUN key to begin execution of the program.

Line 50 insures that the 3326A is in the LOCAL mode so that the user can set up an instrument state from the front panel. Lines 70-100 print a message to the user. Program execution is halted so that 3326A parameters may be entered.

As suggested by the instructions, enter a frequency, amplitude, and offset for each channel from the front panel of the 3326A.

Lines 140-270 interrogate the 3326A for three major parameters from each channel—frequency, amplitude, and offset. The 3326A is directed to output an entry parameter by selecting a channel and supplying an appropriate prefix followed by a question mark.

An ENTER command is used to receive the data and assign it to a string variable. String variables preserve any prefixes or suffixes that the 3326A may send with the requested parameter value. An ENTER command must immediately follow each interrogate command to receive the instrument's output.

The 3326A always responds with Hertz for frequency values, Volts peak-to-peak for amplitude values, seconds for time values, Volts DC for offset values, degrees for phase and percent for duty cycle. Response for internal modulation level is percent or degrees for AM and PM, respectively. In this example, the prefixes, suffixes, and leading and trailing zeroes output by the 3326A are all printed. If string variables were not used to enter the data, other print formats could be used to print only the numeric data.

Lines 310-360 print the requested information on the 9836A CRT. The "K,4X,K" format in line 330 prints each complete parameter string without leading or trailing blanks and prints four spaces between the two strings on each line.

EXAMPLE PROGRAM NO. 7 SAVING AND RESTORING A 3326A SETUP

It is often helpful to be able to save a specific instrument setup state or states that will be used later in a test procedure. A state can be saved in one of the 3326A's nine internal registers or it can be transferred to the memory of the 9836A for long term storage.

There are two ways to use the computer to store instrument state data. The individual parameters can be interrogated, (as in the previous example program) or the 3326A's LEARN mode may be used to represent the complete instrument state as a compacted string of binary bytes.

Though individual instrument parameters cannot be decoded from the LEARN string, it is a faster and more compact way to represent entire instrument states.

Upon receipt of the LRN command, the 3326A outputs a string of 172 bytes which define an entire setup state. This string can be stored in a computer and later output to the 3326A to restore a setup state.

This program demonstrates the use of the LRN and PRG commands to save and restore a 3326A setup state.

RESET the 9836A, SCRATCH the memory, and press EDIT and EXECUTE to enter the following program:

```
10 ! SAVING OR RESTORING A 3326A SETUP
20 !
30 DIM State$(172)
40 Source=718
50 !
60 LOCAL Source
70 PRINT CHR$(12)
80 PRINT "THE 3326A IS UNDER FRONT PANEL CONTROL
90 PRINT "SET UP A FRONT PANEL STATE"
100 PRINT "AND PRESS CONTINUE"
110 PAUSE
120 ! RETRIEVE CURRENT INSTRUMENT STATE
130 OUTPUT Source;"SAV 9"
140 OUTPUT Source;"LRN 9"
150 ENTER Source USING "#,172A";State$
160 LOCAL Source
170 PRINT CHR$(12)
180 DISP "CHANGE THE FRONT PANEL STATE"
190 PAUSE
200 ! RESTORE THE CURRENT INSTRUMENT STATE
210 OUTPUT Source;"PRG 9"&State$
220 OUTPUT Source;"RCL 9"
230 LOCAL Source
240 DISP "INSTRUMENT STATE RESTORED"
250 END
```

PROGRAM 7—EXPLANATION AND OPERATION

After the program has been entered, RESET the 9836A and press the RUN key to begin execution of the program.

Line 30 reserves space for the string State\$. This string holds the binary characters representing the setup state.

Lines 60-100 place the 3326A in the LOCAL mode and print a message to set up the 3326A. This state will be stored in the string "State\$". Program execution is then paused.

Follow the instructions and set up a distinctive front panel state.

Press CONTINUE. **Line 130** causes the setup state to be stored in the 3326A's internal register 9. The LRN and PRG commands actually operate with the 3326A's **internal storage registers** rather than the current setup state. Once the state is copied in register 9, **lines 140-150** send the LRN command to retrieve register 9 and read in the data. The format USING "#,172A" causes the 9836A to read 172 characters for the string and suppresses the requirement for terminating conditions (such as the EOI bus management line).

Once the setup state has been stored, **Lines 160-180** restore the 3326A to front panel control and instruct the user to change the setup state. At this point the 3326A can also be preset, turned off, or completely cleared.

Press CONTINUE to resume program execution. **Line 210** sends the 3326A a command to place the contents of the string "State\$" in register 9. Then **line 220** recalls register 9 to restore the previous front panel state. Finally, the instru-

ment is restored to LOCAL control and an appropriate message is displayed on the 9836A CRT. At this point the user can verify that the previous setup state has indeed been restored.

In this same fashion, multiple setup states could be stored in the 9836A and, if desired, saved on disk for later use.

EXAMPLE PROGRAM NO. 8 SERVICE REQUESTS AND ERRORS

Certain errors and operating conditions of the 3326A can be detected and monitored by the 9836A on an interrupt basis or periodically under program control. Included are both programming and hardware errors and instrument conditions such as the start or completion of a sweep.

When the desired error or condition exists, the user can configure the 3326A to request service from the computer by initiating a Service Request. (SRQ). The computer can detect whether an SRQ has taken place on the bus by analyzing bit 1 (LSB is bit 0) of its interrupt status register (register 4 on the 9836A built in HP-IB interface).

Two methods can be used to analyze the interrupt status of the 9836A HP-IB interface: The program can periodically read the computer's interrupt status register, or it can enable bit 1 of the interrupt enable mask (register 5) to interrupt program execution when an SRQ occurs and bit 1 is set.

In either case, if more than one instrument is on the bus, the computer must conduct a serial poll of all instruments to determine which device requested service. This is done using the SPOLL command and sequentially analyzing the status byte of each instrument that might have generated an SRQ. Under the IEEE-488 definition, the instrument that requires service must have bit 6 of its status byte set.

Once it is determined the 3326A has requested service, the computer can decode the contents of the status byte or, if appropriate, interrogate the error register. A complete description of the status byte and of the error codes are appendices C and B, respectively, of this note. More simply, however, the computer can configure the 3326A to issue an SRQ only when a specific set of errors or operating conditions exist. This set of conditions is determined by a numeric value generated by summing the decimal values of each bit to be checked in the status byte. This value is then sent to the 3326A using the MASK command.

The following program demonstrates the use of the SRQ interrupt in the 9836A and the interrupt mask in the 3326A. In addition, the program interrogates the 3326A for the number of an error generated and prints an appropriate message to the user on the 9836A CRT.

RESET the 9836A, SCRATCH the memory, and press EDIT and EXECUTE to enter the following program:

```

10  ! SERVICE REQUESTS AND ERRORS
20  !
30  Source=718
40  !
50  ABORT 7
60  CLEAR Source
70  OUTPUT Source;"MASK 32 PC"
80  ENABLE INTR 7;2
90  ON INTR 7 GOSUB Srq
100 !
110 INPUT "ENTER CHANNEL A VOLTAGE IN VOLTS",Level
120 OUTPUT Source;"CHA, AM ";Level;" VD"
130 WAIT .1
140 GOTO 110
150 !
160 Srq:   BEEP
170   Status=SPOLL(Source)
180   PRINT CHR$(12)
190   PRINT "E R R O R   D E T E C T E D"
200   OUTPUT Source;"ERR?"
210   ENTER Source;User_error
220   PRINT
230   PRINT "ERROR NUMBER",User_error
240   IF BIT(Status,0) THEN PRINT "PROGRAMMING ERROR"
250   IF BIT(Status,1) THEN PRINT "END OF SWEEP"
260   IF BIT(Status,2) THEN PRINT "SWEEP IN PROGRESS"
270   IF BIT(Status,3) THEN PRINT "HARDWARE ERROR"
280   IF BIT(Status,4) THEN PRINT "READY FOR DATA"
290   IF BIT(Status,7) THEN PRINT "POWER FAILURE/ON"
300   ENABLE INTR 7;2
310   WAIT 3
320   PRINT CHR$(12)
330   RETURN
340   !
350   END

```

PROGRAM 8—EXPLANATION AND OPERATION

After the program has been entered, RESET the 9836A and press the RUN key to begin execution of the program. No oscilloscope is necessary.

Line 50 aborts any current activity on the bus and **Line 60** is a selective DEVICE CLEAR command used here to clear the status byte of the 3326A in the event there is an existing SRQ.

Line 70 sends a Service Request MASK to the 3326A enabling an SRQ only when bit 5 of the 3326A status byte is set. Bit 5 (decimal value 32) is set when an error condition exists in the 3326A. **Line 80** enables program interruption on bit 1 (decimal value 2) of the 9836A status register 5.

Line 90 directs program execution to the subroutine "SRQ" when an SRQ interrupt is generated.

Line 110 asks the user to enter a channel A output level. This level is sent to the 3326A as an HP-IB command in **line 120**.

Line 130 delays program execution long enough to allow the 3326A to generate an error (in the event the entered voltage exceeds limits). Without this delay, the program will be directed to **line 110** before an SRQ can occur. **Line 110** halts program execution to wait for user input and will therefore inhibit interrupt response.

Following the instructions in **line 110**, enter a channel A amplitude in volts and press CONTINUE. Verify that this level is present in the 3326A display. The program will continue to request voltage inputs until an invalid voltage is entered.

When the program transmits an invalid parameter to the 3326A, an SRQ is generated and **line 90** directs program execution to the subroutine "SRQ" beginning on **line 160**. An audible tone is then generated to alert the user.

Line 170 causes a Serial Poll to be performed and assigns the result to the variable "Status". In the event several instruments are present on the bus and an error can be generated by two or more of them, each instrument must be polled individually. The instrument requesting service will have bit 6 of its status byte set and its status byte can be analyzed to determine the cause of the SRQ.

In this case, it is assumed the SRQ is from the 3326A and the MASK statement in **line 70** insures that the cause is a program or hardware error. The computer, therefore, reads and displays the error in **lines 200-230**.

Lines 240-290 analyze successive bits of the status byte to determine the condition of the 3326A and print appropriate messages to the user. The interrupt is then re-enabled in **line 300** and the user messages are displayed for three seconds. In **line 320** the 9836A CRT is cleared and the program returns to ask the user for a new voltage level.

To generate messages such as "End Of Sweep" or "Sweep In Progress", simply enter an invalid Channel A voltage, press the LOCAL key on the 3326A, and initiate a single or continuous sweep before pressing the CONTINUE key.

APPENDIX A
HP 3326A PROGRAMMING CODES

Mnemonic	Range	Suffix	Front Panel Control	Description Resolution Syntax
ACAL	0-1 or —	— OFF, ON	AUTO	AutoCALibration Syntax: "ACALO" "ACAL OFF"
AEA	0-1 or —	— OFF, ON	CH A	Channel A External Am Syntax: "AEA1" "AEA ON"
AEP	0-1 or —	— OFF, ON	CH A	Channel A External Pm Syntax: "AEP1" "AEP ON"
AIA	0-1 or —	— OFF, ON	CH A	Channel A Internal Am Syntax: "AIA1" "AIA ON"
AIP	0-1 or —	— OFF, ON	CH A	Channel A Internal Pm Syntax: "AIP1" "AIP ON"
AM	0-10 V	VO, VRMS, DBM, DBV	AMPTD	Amplitude Resolution: 1 mVpp Syntax: "AM1.125VO"
BEA	0-1 or —	— OFF, ON	CH B	Channel B External Am Syntax: "BEA1" "BEA ON"
BEP	0-1 or —	— OFF, ON	CH B	Channel B External Pm Syntax: "BEP1" "BEP ON"
BUSM	1-2	—	none	BUS Mode Syntax: "BUSM2"
CAL	—	—	MANUAL	CALibrate Syntax: "CAL"
CF	0-13 MHz	HZ, KHZ, MHZ	CNTR FREQ	Center Frequency Resolution: 1 μ Hz f < 100 kHz 1 mHz f \geq 100 kHz Syntax: "CF10KHZ"
CFM	—	—	MKR->CF	Center Frequency equals Marker value Syntax: "CFM"
CHA	—	—	CHAN	select CHannel A Syntax: "CHA"
CHB	—	—	CHAN	select CHannel B Syntax: "CHB"
CMB	0-1 or —	— OFF, ON	COMBINED	CoMBiner Syntax: "CMB1" "CMB ON"

HP 3326A PROGRAMMING CODES (CONT'D)

Mnemonic	Range	Suffix	Front Panel Control	Description Resolution Syntax
CMD	1 or —	— INT	SELECT	Calibration MoDe - INTernal Syntax: "CMD1" "CMD INT"
	2 or —	— EXT		Calibration MoDe - EXTernal Syntax: "CMD1" "CMD EXT"
	3 or —	— MULT		Calibration MoDe - MULTiphase Syntax: "CMD3" "CMD MULT"
COF	—	—	CLR ϕ OFS	Clear phase Offset Syntax: "COF"
DBM	—	—	units	DBM
DBV	—	—	units	DBV
DC	—	—	none	suffix DC function output
DCLR	—	—	RST DISCRETE	Discrete sweep CLear Syntax: "DCLR"
DEG	—	—	units	DEGrees
DN	—	—	none	Down increment by EINC value Syntax: "DN"
DRCL	00-62	—	RCL DISCRETE	Discrete ReCaLI Syntax: "DRCL02"
DSAV	00-62	—	DISCRETE STO	Discrete SAve Syntax: "DSAV02"
DSCR	—	—		Suffix - DiSCReTe Sweep Mode
DISP	0-1 or —	— OFF, ON	none	DISPlay control Syntax: "DISP1" "DISP ON"
DUTY	1-99%	PC	DUTY CYCLE	DUTY cycle Resolution: 0.01% Syntax: "DUTY25.05PC"
EINC	see description		none	Entry INCReption for UP, DN, TUP, and TDN commands Use increment resolution and suffix appropriate for entry value modified Syntax: "EINC1HZ" "EINC.1VRMS"

HP 3326A PROGRAMMING CODES (CONT'D)

Mnemonic	Range	Suffix	Front Panel Control	Description Resolution Syntax
ERR?	—	—	none	ERRor code Syntax: "ERR?"
EXT	—	—	none	suffix for EXTernal calibration
FCNA	0 or —	— OFF	CHA	FunCtioN channel A OFF Syntax: "FCNA0" "FCNA OFF"
	1 or —	— SIN		FunCtioN channel A SINe Syntax: "FCNA1" "FCNA SIN"
	2 or —	— SQR		FunCtioN channel A SQUaRe Syntax: "FCNA2" "FCNA SQR"
FCNB	3 or —	— DC	CHB	FunCtioN channel A DC Syntax: "FCNA3" "FCNA DC"
	0 or —	— OFF		FunCtioN channel B OFF Syntax: "FCNB0" "FCNB OFF"
	1 or —	— SIN		FunCtioN channel B SINe Syntax: "FCNB1" "FCNB SIN"
	2 or —	— SQR		FunCtioN channel B SQUaRe Syntax: "FCNB2" "FCNB SQR"
	3 or —	— DC		FunCtioN channel B DC Syntax: "FCNB3" "FCNB DC"
FR	0-13 MHz	HZ, KHZ, MHZ	FREQ	FRequency Resolution: 1 μ Hz f < 100 kHz 1 MHz f \geq 100 kHz Syntax: "FR7.500003MHZ"
HVA	0-1 or —	— OFF, ON	CH A HV	High Voltage channel A Syntax: "HVA1" "HVA ON"
HVB	0-1 or —	— OFF, ON	CH B HV	High Voltage channel B Syntax: "HVB1" "HVB ON"
HZ	—	—	units	HertZ

HP 3326A PROGRAMMING CODES (CONT'D)

Mnemonic	Range	Suffix	Front Panel Control	Description Resolution Syntax
ID?	—	—	none	IDentification Syntax: "ID?"
INT	—	—	none	suffix for INTernal calibration
KHZ	—	—	units	KiloHertz
LRN	0-9	—	none	LeaRN (read) nonvolatile memory Syntax: "LRN3"
MASK	0-255	PC	none	srq MASK (weighted binary sum of bit postions) Syntax: "MASK32PC"
MF	0-13MHz	HZ, KHZ, MHZ	MKR FREQ	Marker Frequency Resolution: 1 μ Hz f < 100 kHz 1 mHz f \geq 100 kHz Syntax: "MF8.0MHZ"
MFY	0-1 or —	— OFF, ON	ON/OFF	front panel ModiFY control Syntax: "MFY1" "MFY ON"
MHZ	—	—	units	MegaHertz
ML	0-100% or 0-360°	PC DEG	% AM/PM DEV	Modulation Level Resolution: 0.1% or 1° Syntax: "ML30PC"
MODE	1 or — 2 or — 3 or — 4 or —	— TWOC — TWOP — TWOT — PULS	MODE	MODE TWO Channel Syntax: "MODE1" "MODE TWOC" MODE TWO Phase Syntax: "MODE2" "MODE TWOP" MODE TWO Tone Syntax: "MODE3" "MODE TWOT" MODE PULSe Syntax: "MODE4" "MODE PULS"
MS	—	—	units	MilliSeconds
MULT	—	—	none	suffix for MULTiphase calibration
NOM	—	—	none	NO Modulation Syntax: "NOM"
OF	+ -5 V	VO	DC OFFSET	Offset Resolution: 10 mV Syntax: "OF3VO"

HP 3326A PROGRAMMING CODES (CONT'D)

Mnemonic	Range	Suffix	Front Panel Control	Description Resolution Syntax
OFF	—	—	none	suffix to disable function
ON	—	—	none	suffix to enable function
PC	—	—	units	PerCent
PH	+ -720°	DEG	PHASE	PHase Resolution: 0.01° Syntax: "PH180DEG"
PRG	0-9	—	none	PRoGram (restore) nonvolatile memory Syntax: "PRG3"
PULS	—	—	none	suffix for PULSe mode
RAMP	—	—	none	suffix for RAMP sweep
RCL	0-9	—	RECALL	ReCaLI Syntax: "RCL3"
RDY?	—	—	none	ReaDY Syntax: "RDY?"
REV?	—	—	none	REVision Syntax: "REV?"
RST	—	—	INSTR PRESET	ReSeT Syntax: "RST"
SAV	0-9	—	STORE	SAVe Syntax: "SAV3"
SC	—	—	CONT	Sweep, Continuous Syntax: "SC"
SEC	—	—	units	SEConds
SER?	—	—	none	SERial number Syntax: "SER?"
SIN	—	—		suffix for SINE wave function
SM	1	—	TRIANGLE	Sweep Mode - linear RAMP Syntax: "SM1" "SM RAMP"
	or —	RAMP		
	2	—	TRIANGLE	Sweep Mode - linear TRianGLE Syntax: "SM2" "SM TRGL"
	or —	TRGL		
3	—	DISCRETE	Sweep Mode - DisCRete Syntax: "SM3" "SM DSCR"	
or —	DSCR			

HP 3326A PROGRAMMING CODES (CONT'D)

Mnemonic	Range	Suffix	Front Panel Control	Description Resolution Syntax
SP	0-13 MHz	HZ, KHZ, MHZ	STOP FREQ	StoP frequency Resolution: 1 μ Hz f < 100 kHz 1 mHz f \geq 100 kHz Syntax: "SP7.125MHZ"
SPAN	0-13 MHz	HZ, KHZ, MHZ	SPAN	sweep frequency SPAN Resolution: 1 μ Hz f < 100 kHz 1 mHz f \geq 100 kHz Syntax: "SPAN10.125MHZ"
SPE	0-1 or —	— OFF, ON	CH A	Synchronous Phase modulation External Syntax: "SPE1" "SPE ON"
SQR	—	—	none	suffix for SQuaRe wave function
SRE	—	—	RESET SWP	Sweep REset Syntax: "SRE"
SS	—	—	SINGLE	Sweep Single Syntax: "SS"
ST	0-13 MHz	HZ, KHZ, MHZ	START FREQ	STart frequency Resolution: 1 μ Hz f < 100 kHz 1 mHz f \geq 100 kHz Syntax: "ST3.5KHZ"
STC	—	—	none	Sweep on Trigger - Continuous Syntax: "STC"
STIM	5 ms-1000 s	SEC, MS	TIME	Sweep TIME Resolution: 1 mS Syntax: "STIM.3S"
STS	—	—	none	Sweep on Trigger - Single Syntax: "STS"
TDN	—	—	none	Trigger Down increment by EINC amount Syntax: "TDN"
TOFF	—	—	none	Trigger OFF Syntax: "TOFF"
TRGL	—	—	suffix	TRianGLE sweep mode
TST	—	—	SELF TEST	self TeST Syntax: "TST"
TUP	—	—	none	Trigger UP increment by EINC amount Syntax: "TUP"

HP 3326A PROGRAMMING CODES (CONT'D)

Mnemonic	Range	Suffix	Front Panel Control	Description Resolution Syntax
TWOC	—	—	none	suffix for TWO Channel mode
TWOP	—	—	none	suffix for TWO Phase mode
TWOT	—	—	none	suffix for TWO Tone mode
UP	—	—	none	UP increment by EINC value Syntax: "UP"
VO	—	—	units	VOlts peak-to-peak for amplitude. VOlts dc for dc offset.
VRMS	—	—	units	Volts RMS for amplitude
WAIT	—	—	none	no operation Syntax: "WAIT"
ZPH	—	—	ASGN ZERO ϕ	Zero PHase Syntax: "ZPH"

APPENDIX B

HP 3326A HP-IB ERROR CODES

CODE DESCRIPTION

10	HP-IB command has syntax error or contains illegal characters
11	Front panel key pressed while HP 3326A in remote
12	Front panel key pressed while HP 3326A in local lockout
20	Value entered for selected parameter exceeds valid limits
21	In 2 TONE mode, channel B offset frequency greater than 100 kHz
22	Amplitude and dc offset values incompatible
23	Discrete frequency sweep element save nonsequential with existing elements, or instrument state save breaks continuity of discrete frequency elements
24	Marker frequency entered is outside sweep span
25	Frequency value greater than 1 MHz entered with high voltage option active

APPENDIX B. HP 3326A HP-IB ERROR CODES (CONT.)

CODE DESCRIPTION

26	Frequency value greater than 5 kHz entered with internal PM active, or greater than 100 kHz with internal AM active
29	Combiner is enabled, and nonzero dc offset entered with function other than DC only, or amplitude value greater than half the normal limits
30	In 2 TONE mode with channel B high voltage option enabled, channel B frequency cannot track change to channel A frequency
40	Value that cannot be displayed has been interrogated over the HP-IB
46	Internal modulation enabled and Channel B amplitude or offset selected as display value
47	Channel B phase selected as display value when PULSE mode enabled
50	Units conversion results in zero display value
60	Units key selected improper for parameter selected
65	High voltage option enabled and dBm selected as units
70	Increment value or units incompatible with displayed value
80	Combiner selected but not enabled because current amplitude value is too large
86	Combiner selected but not enabled because Internal AM or PM is enabled
87	1) In PULSE mode—sine wave output selected, combiner selected, or zero phase assigned to channel B 2) In 2 CHANNEL, 2 TONE, or PULSE mode—channel B phase offset cleared 3) In 2 TONE, 2 PHASE, or PULSE mode—internal AM or PM selected 4) In 2 CHANNEL mode—synchronous PM selected
88	Internal PM selected with channel B frequency greater than 5 kHz, or internal AM selected with channel B frequency greater than 100 kHz
89	Combiner selected but not enabled because AM or PM enabled
90	Frequency sweep start and stop frequencies are equal for both channels
94	Pulse duty cycle too narrow for sweep range
95	High voltage option enabled and sweep frequency is greater than 1 MHz
96	Channel B frequency exceeds 5 kHz internal PM limit or 100 kHz internal AM limit during sweep
100	Sweep rate less than 5 MHz per second or greater than 0.5 MHz per second
110	No discrete frequency sweep elements exist for discrete frequency sweep
114	Frequency too high for duty cycle requested during discrete frequency sweep
115	High voltage option enabled and discrete frequency sweep element frequency exceeds 1 MHz
116	Channel B frequency exceeds the 5 kHz internal PM limit or 100 kHz internal AM limit during discrete frequency sweep
117	Discrete frequency elements in memory incompatible with selected mode
120	Cannot clear channel A phase offset
130	High voltage option selected and not installed
136	Channel B high voltage option selected with internal modulation
138	High voltage option selected when frequency is greater than 1 MHz
140	A checksum error for recall, learn, or program operation
150	Current instrument configuration incompatible with recalled or programmed state
160	An error is detected in an instrument state recalled from memory and instrument state is replaced with preset state
170	Channel A output is overloaded
171	Channel B output is overloaded
172	SYNC output is overloaded
173	Channel A voltage controlled oscillator is unlocked
180	HP 3326A cannot lock to external reference signal that is present
190	Unsuccessful internal AM or PM calibration
191	Unsuccessful phase calibration
192	Unsuccessful amplitude calibration
193	Unsuccessful dc offset calibration
194	Unsuccessful residual dc offset calibration

APPENDIX C
HP 3326A STATUS BYTE

BIT NUMBER	DECIMAL VALUE	DESCRIPTION
B7	128	POWER RESTORED. Set when power is restored to the HP 3326A after power is interrupted. Reset when the HP 3326A is preset or receives a device clear, selected device clear, or RST command.
B6	64	REQUIRE SERVICE. Set when the HP 3326A requires service (sent an SRQ). Cleared along with the SRQ line when a serial poll is performed. It is also cleared when the condition causing the SRQ is removed.
B5	32	ERROR. Set when either a program or hardware error condition exists for the HP 3326A. Reset when the HP 3326A is preset, or receives a device clear command, selected device clear command, RST command, or when the error register is read with the IERR or ERR? HP-IB command.
B4	16	READY. Set when the HP 3326A has executed the last HP-IB command and is ready for the next command. Reset when the HP 3326A receives a device dependent command, device clear command, selected device clear command, or trigger.

BIT NUMBER	DECIMAL VALUE	DESCRIPTION
B3	8	HARDWARE ERROR. Set when the HP 3326A detects an internal failure. Reset with an INSTR PRESET, device clear command, selected device clear command, RST command, or when the error register is read with the IERR or ERR? HP-IB command.
B2	4	SWEEP START/IN PROGRESS. Set when the HP 3326A starts a sweep. Reset when the sweep is stopped (either by reaching the stop frequency or aborted by a front panel or HP-IB command). It is also reset when the HP 3326A is preset or receives a device clear command, selected device clear command, or RST command.
B1	2	SWEEP STOPPED. Set when the HP 3326A ends a sweep normally. Reset when the HP 3326A is preset or receives a device clear command, selected device clear command, or RST command.
B0	1	PROGRAM ERROR. Set when the HP 3326A receives an invalid HP-IB command (e.g. command syntax or incompatible command for mode selected). Reset when the HP 3326A is preset or receives a device clear command, selected device clear command, or RST command.



FOR MORE INFORMATION, CALL YOUR LOCAL HP SALES OR SERVICE OFFICE or East (201) 265-5000 • Midwest (312) 255-9800 • South (404) 955-1500 • West (213) 970-7500 or (415) 968-9200 **OR WRITE**, Hewlett-Packard, 1820 Embarcadero, Palo Alto, California 94303. **IN EUROPE, CALL YOUR LOCAL HP SALES or SERVICE OFFICE OR WRITE**, Hewlett-Packard S.A., 7, rue du Bois-du-Lan Case Postale 365 CH 1217 Meyrin 1 - Geneva, Switzerland. **IN JAPAN**, Yokogawa-Hewlett-Packard Ltd., 1-27-15, Yabe Sagamiara City, Kanagawa Prefecture, Japan 229.

5953-5135

Printed in U.S.A.

*HP-IB QUICK
REFERENCE GUIDE*

HP-IB QUICK REFERENCE GUIDE

Supersedes: None

Quick Reference Guide for the HP 3326A Two-Channel Synthesizer

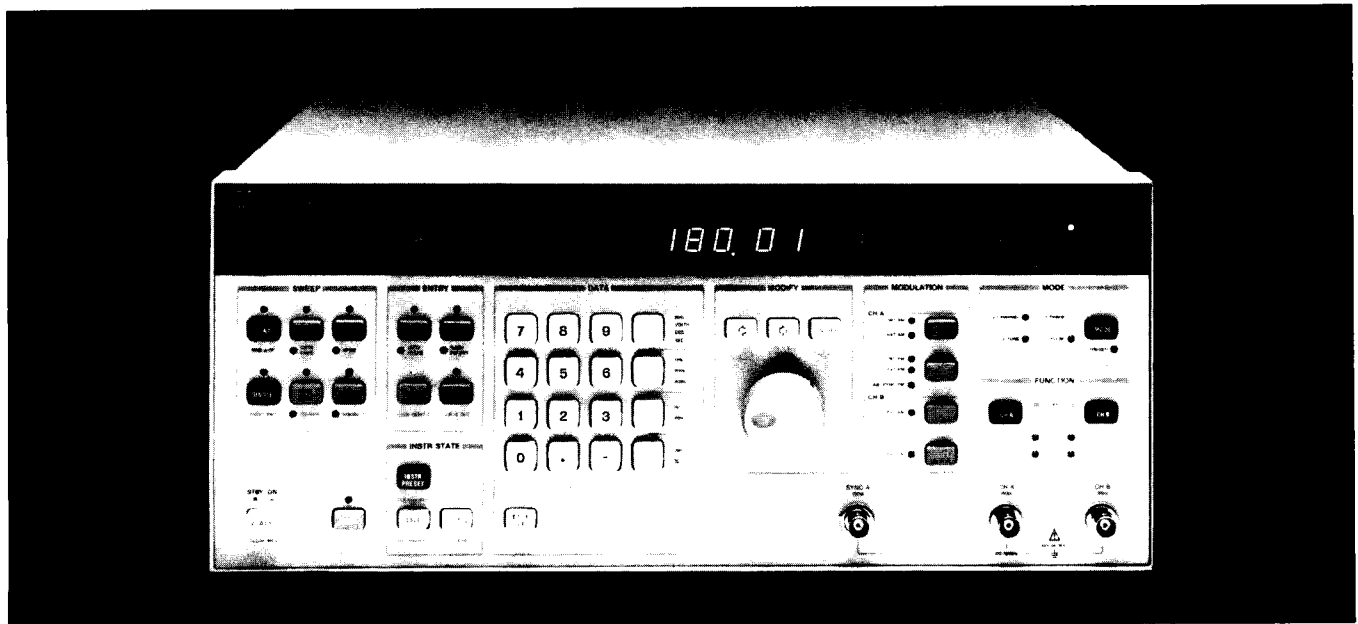

INTRODUCTION

This programming note is a reference guide for the remote operation of the HP 3326A Two-Channel Synthesizer. This note is intended for use by those familiar with HP-IB programming and the basic functions of the HP 3326A Two-Channel Synthesizer. For complete programming information refer to the HP 3326A Operating Manual.

INPUT DATA

The 3326A Two-Channel Synthesizer accepts programming codes that contain information for programming all of the front panel and special HP-IB only functions except the Line switch and Set HP-IB Address. The programming data

string consists of a string of ASCII coded characters composed of one or more of the following control fields:

- Channel Select
- Entry Select
- Function Select
- Sweep Mode
- Mode Select
- Modulation
- Instrument State/Registers
- Calibration
- Special HP-IB Only Functions

Input Syntax. The 3326A responds to program codes in the order in which they are received. Each event or performed action is programmed with a string of ASCII coded characters that follow one of the following sequences.

- **Numeric Entry:**
[Entry Prefix] [Numeric Value] [Numeric terminator]
- **Select Value/Mode:**
[Entry Prefix] [Numeric Value]
- **Immediate Action:**
[Action Code]

NOTE

The HP-IB program code sequence typically mirrors that of the local front panel keystroke sequence, except the shift functions which have special HP-IB codes.

Entry Prefix/Action Codes. Entry prefix/action codes are typically 2 to 5 character mnemonics. For an entry that has a numeric value associated with it, programming the entry prefix code only will enable and activate the numeric display of the current value.

Numeric Values/Formats. These are either a single decimal digit, a set of 14 characters or less representing a number, or a string of binary bytes. A string of 15 characters maximum can be expressed in exponential, decimal, or integer form. Acceptable numeric formats are referenced in later sections by the following format syntax:

Format #1: Exponential	$\pm d^{***}d.d^{***}dE \pm dd$
Format #2: Decimal	$\pm d^{***}d.d^{***}d$
Format #3: Integer	$\pm d^{***}d$
Format #4: Single Digit	d
Format #5: Binary String	b^{***}b

The character 'd' indicates a leading or trailing zero, a space, or a numeric digit (0 through 9). The character 'b' indicates an 8-bit binary byte. The characters '***' indicate a variable number of the previous character. Numeric values are scaled by the appropriate numeric terminator. Negative signs are ignored and the positive value used if the parameter can not have negative values.

Numeric Terminators. Numeric terminators are multi-character codes that terminate and scale the associated numeric value. Thus, frequency values can be entered in MHz (MHZ), kHz (KHZ), or Hz (HZ); sweep time values can be entered in seconds (SEC) or milliseconds (MS); amplitude values can be entered in dBm (DBM), dBV (DBV), Volts peak-to-peak (VO), Volts RMS (VRMS), millivolts peak-to-peak (MV), or millivolts RMS (MR); phase in degrees (DEG); and modulation level in % AM (PC) or degrees PM (DEG).

Valid Characters. The valid characters in program codes can be either upper or lower case characters (A-Z, a-z) since they can be interchanged, digits (0-9), decimal point (.), plus/minus signs (+, -), question mark (?), and pound sign (#). The parity bit (ie. 8th bit) is ignored by the 3326A.

Delimiters. All alpha programming codes must be delimited by a non-valid character (ie. space, comma, semicolon) for that action to be activated and the next event processed. If a valid character is used, a syntax error will occur.

Programming Data. The 3326A buffers up to 3 or 100 characters of HP-IB data, depending on the bus mode selected. Thus care must be taken to ensure a desired action has occurred. This can be accomplished via the WAIT command or a serial poll of the status byte ready bit.

Table 1 lists all Input Programming Codes and their syntax.

Instrument Preset. Instrument Preset turns off all functions then sets the following:

- Channel A:

Frequency	1000 Hz
Amplitude	100 mV pp
DC Offset	0 V
Phase	0 deg
Function	sine
Start Frequency	0 Hz
Stop Frequency	13 MHz
- Channel B:

Frequency	1000 Hz
Amplitude	100 mV pp
DC Offset	0 V
Phase	0 deg
Function	sine
Start Frequency	0 Hz
Stop Frequency	13 MHz
- Mode
- Duty Cycle
- Modulation Level
- Marker Frequency
- Marker Channel
- Sweep Time
- Sweep Mode
- Calibration Mode
- Channel Selected
- Trigger Action Pending

Instrument Preset does not affect the Storage Registers, HP-IB address, or Service Request Mask value.

OUTPUT DATA

The 3326A has several output modes that allow the user to learn and interrogate the present instrument state. The following output modes are available:

- Learn String
- Interrogate Parameter
- Interrogate Error

All messages are terminated by asserting the bus EOI signal in parallel with the last byte of the message to be sent.

Learn String: Selected with the "LRN" program code, the 3326A outputs a Learn String of 172 bytes in length. This binary data string completely describes the present instrument state saved in the specified Storage Register of the 3326A. The information is packed and encoded for minimal storage requirements thereby making data analysis difficult. When stored in an ASCII character data string, the Learn String can later be input to any Storage Register of the 3326A to save that instrument state (see Table 1 for Learn String information). The length of the Learn String is fixed, independent of the functions selected.

Format: 172 [8 bit bytes] [EOI]

Interrogate Parameter: Selected with the "I" preceding the program code for the parameter to be interrogated, or a "?" following the program code, the 3326A will output an ASCII string composed of the parameter code, present numeric value, and units. The numeric value indicates either the present status, mode or value. Values are expressed in fundamental units, ie. Hz, seconds, volts, degrees, and %. Table 1 also lists the output format for each valid parameter to interrogate.

Format: [program code] [numeric value] [units] [CR] [LF] [EOI]

Interrogate Error: Selected with the "ERR?" program code, the 3326A outputs a numeric value corresponding to the most recent error number. Table 3 lists the possible error numbers and their causes.

Format: [numeric value] [CR] [LF] [EOI]

TRIGGER

The 3326A responds to HP-IB Commands Group Execute Trigger (GET) and Selective Device Trigger (SDT) depending upon the last trigger action command. Receipt of either command causes the 3326A to perform an action specified by the Trigger Action command.

CLEAR

The 3326A responds to both Device Clear (DCL) and Selective Device Clear (SDC) by clearing all bits of the status byte then setting bit 4 (Ready for Data), clearing the HP-IB command buffer, and initializing the interface so that it is ready to receive HP-IB programming codes. This is necessary if the instrument state prior to sending HP-IB commands is unknown. It is good practice to execute DCL or SDC at the beginning of any program.

REMOTE/LOCAL CHANGES

The 3326A goes to the Remote state when the LREN line is true (low) and the 3326A receives its listen address. In Remote, all front panel functions are disabled except the LINE switch and the LOCAL key. The LOCAL function can also be disabled via the Local Lockout (LLO) command.

The 3326A goes to the Local state when it receives the Go To Local (GTL) command or when the LREN line is set false (high). If the Local Lockout (LLO) command has not been executed, the 3326A can also be set to Local by pressing the LOCAL key. In Local, the front panel is active but the instrument will still respond to HP-IB programming codes.

SERVICE REQUEST

The 3326A can initiate a Service Request (SRQ) whenever one of the following conditions exists:

- Programming error (syntax, incompatible mode, etc.)
- Sweep in progress
- Hardware error
- Ready for data
- Power Failure/On

Further information can be obtained by conducting a Serial Poll, which accesses the Status Byte. The SRQ is cleared only by executing a Serial Poll. To select an SRQ for a particular set of circumstances, the Request Mask function can be used to determine which of the bits in the Status Byte can cause an SRQ. The mask value is determined by summing the decimal values of each selected function/condition that is desired. The default Request Mask at power on is "00000000" or decimal 0. The mask value is reset to the default value only at power on or by the front panel memory clear function.

STATUS BYTE

The 3326A responds to a Serial Poll by sending its status byte as indicated in Table 2. When Bit 6 (Request Service) of

TABLE 1. HP3326A HP-IB MNEMONIC SUMMARY

Front Panel Control	Mnemonic	Range	Suffix	Interrogation Response	Description Resolution Syntax
CALIBRATION BLOCK					
AUTO	ACAL or ACAL	0-1 —	— OFF, ON	—	AutoCALibration Syntax: "ACAL0" "ACAL OFF"
MANUAL	CAL	—	—	—	CALibrate Syntax: "CAL"
SELECT	CMD or CMD	1 —	— INT	—	Calibration MoDe - INTernal Syntax: "CMD1" "CMD INT"
	CMD or CMD	2 —	— EXT	—	Calibration MoDe - EXTernal Syntax: "CMD1" "CMD EXT"
	CMD or CMD	3 —	— MULT	—	Calibration MoDe - MULTiphase Syntax: "CMD3" "CMD MULT"
SELF TEST	TST	—	—	#####	self TeST, each # = P or F for Pass or Fail Syntax: "TST"
ENTRY BLOCK					
AMPTD	AM	0-10 V	VO, VRMS, DBM, DBV	AM ±#.###E ±##VO	AMplitude Resolution: 1 mV p-p Syntax: "AM1.125VRMS"
ASGN ZERO φ	ZPH	—	—	—	Zero PHase Syntax: "ZPH"
CLR φ OFS	COF	—	—	—	Clear phase OFset Syntax: "COF"
DC OFFSET	OF	± 5 V	VO	OF ±#.###E ±##VO	OFFset Resolution: 10 mV Syntax: "OF3.02VO"
FREQ	FR	0-13 MHz	HZ, KHZ, MHZ	FR #####.#####HZ or FR #####.###HZ	FRequency Resolution: 1 μHz f < 100 kHz, 1 mHz f ≥ 100 kHz Syntax: "FR7.5MHZ"
PHASE	PH	± 720°	DEG	PH ±#.###E ±##DEG	PHase Resolution: 0.01° Syntax: "PH180.05DEG"
DUTY CYCLE	DUTY	1-99%	PC	DUTY#.###E ±##PC	DUTY cycle Resolution: 0.01% Syntax: "DUTY25.50PC"
% AM/ PM DEV	ML or ML	0-100% 0-360°	PC DEG	ML ±#.###E ±##PC or ML ±#.###E ±##DEG	Modulation Level Resolution: 0.1% or 1° Syntax: "ML30.5PC"

HP 3326A HP-IB MNEMONIC SUMMARY (Cont'd)

	Front Panel Control	Mnemonic	Range	Suffix	Interrogation Response	Description Resolution Syntax	
FUNCTION BLOCK	CHA	FCNA or FCNA	0 —	— OFF	—	FunCtioN channel A OFF Syntax: "FCNA0" "FCNA OFF"	
		FCNA or FCNA	1 —	— SIN	—	FunCtioN channel A SINe Syntax: "FCNA1" "FCNA SIN"	
		FCNA or FCNA	2 —	— SQR	—	FunCtioN channel A SQuaRe Syntax: "FCNA2" "FCNA SQR"	
		FCNA or FCNA	3 —	— DC	—	FunCtioN channel A DC Syntax: "FCNA3" "FCNA DC"	
	CH A HV	HVA or HVA	0-1 —	— OFF, ON	—	High Voltage channel A Syntax: "HVA1" "HVA ON"	
	CHB	FCNB or FCNB	0 —	— OFF	—	FunCtioN channel B OFF Syntax: "FCNB0" "FCNB OFF"	
		FCNB or FCNB	1 —	— SIN	—	FunCtioN channel B SINe Syntax: "FCNB1" "FCNB SIN"	
		FCNB or FCNB	2 —	— SQR	—	FunCtioN channel B SQuaRe Syntax: "FCNB2" "FCNB SQR"	
		FCNB or FCNB	3 —	— DC	—	FunCtioN channel B DC Syntax: "FCNB3" "FCNB DC"	
	CH B HV	HVB or HVB	0-1 —	— OFF, ON	—	High Voltage channel B Syntax: "HVB1" "HVB ON"	
	BUS MODES		BUSM	1-2	—		BUS Mode Syntax: "BUSM2"
			WAIT	—	—	—	no operation Syntax: "WAIT"
DISPLAY CONTROL		DISP or DISP	0-1 —	— OFF, ON	—	DISPlay control Syntax: "DISP1" "DISP ON"	

HP 3326A HP-IB MNEMONIC SUMMARY (Cont'd)

Front Panel Control	Mnemonic	Range	Suffix	Interrogation Response	Description Resolution Syntax
ERROR CODES					
	ERR?	—	—	ERR ###	ERRor code Syntax: "ERR?"
HP 3326A IDENTIFICATION					
	ID?	—	—	HP3326A	IDentification Syntax: "ID?"
	RDY?	—	—	0	ReaDY Syntax: "RDY?"
	REV?	—	—	####,####	REVision Syntax: "REV?"
	SER?	—	—	####A00000	SERial number Syntax: "SER?"
MODIFYING PARAMETERS					
	DN	—	—	—	Down increment by EINC value Syntax: "DN"
	EINC	see description	—	—	Entry INCRement for UP, DN, TUP, and TDN commands Use increment resolution and suffix appropriate for entry value modified Syntax: "EINC1HZ" "EINC.1VRMS"
	UP	—	—	—	UP increment by EINC value Syntax: "UP"
READING AND MASKING THE STATUS BYTE					
	MASK	0-255	PC	MASK###PC	SRQ MASK (weighted binary sum of bit po- sitions) Syntax: "MASK32PC"
SAVING OR RESTORING AN HP 3326A SETUP					
	LRN	0-9	—	—	LeaRN (read) nonvolatile memory Syntax: "LRN3"
	PRG	0-9	—	—	ProGram (restore) non- volatile memory Syntax: "PRG3"

HP 3326A HP-IB MNEMONIC SUMMARY (Cont'd)

	Front Panel Control	Mnemonic	Range	Suffix	Interrogation Response	Description Resolution Syntax
TRIGGERED OPERATION						
	STC	—	—	—	—	Sweep Triggered Continuous Syntax: "STC"
	STS	—	—	—	—	Sweep Triggered Single Syntax: "STS"
	TDN	—	—	—	—	Trigger Down increment by EINC amount Syntax: "TDN"
	TOFF	—	—	—	—	Trigger OFF Syntax: "TOFF"
	TUP	—	—	—	—	Trigger UP increment by EINC amount Syntax: "TUP"
INSTR STATE BLOCK						
	INSTR PRESET	RST	—	—	—	ReSeT Syntax: "RST"
	RCL DISCRETE	DRCL	00-62	—	—	Discrete ReCaLI element Syntax: "DRCL02"
	RECALL	RCL	0-9	—	—	ReCaLI memory Syntax: "RCL3"
	RST DISCRETE	CLR	—	—	—	Discrete sweep CLear elements Syntax: "CLR"
	SAVE	SAV	0-9	—	—	SAVe memory Syntax: "SAV3"
	SAVE DISCRETE	DSAV	00-62	—	—	Discrete SAVe element Syntax: "DSAV02"
MODE BLOCK						
	COMBINED	CMB or CMB	0-1 —	— OFF, ON	—	CoMBiner Syntax: "CMB1" "CMB ON"
	MODE	MODE or MODE	1 —	— TWOC	—	MODE TWO Channel Syntax: "MODE1" "MODE TWOC"
		MODE or MODE	2 —	— TWOP	—	MODE TWO Phase Syntax: "MODE2" "MODE TWOP"
		MODE or MODE	3 —	— TWOT	—	MODE TWO Tone Syntax: "MODE3" "MODE TWOT"
		MODE or MODE	4 —	— PULS	—	MODE PULSe Syntax: "MODE4" "MODE PULS"

HP 3326A HP-IB MNEMONIC SUMMARY (Cont'd)

	Front Panel Control	Mnemonic	Range	Suffix	Interrogation Response	Description Resolution Syntax
MODIFY BLOCK						
	ON/OFF	MFY or MFY	0-1 —	— OFF, ON	—	front panel ModiFY control Syntax: "MFY1" "MFY ON"
MODULATION BLOCK						
	none	NOM	—	—	—	NO Modulation Syntax: "NOM"
	CH A	AEA or AEA	0-1 —	— OFF, ON	—	Channel A External Amplitude modulation Syntax: "AEA1" "AEA ON"
		AEP or AEP	0-1 —	— OFF, ON	—	Channel A External Phase modulation Syntax: "AEP1" "AEP ON"
		AIA or AIA	0-1 —	— OFF, ON	—	Channel A Internal Amplitude modulation Syntax: "AIA1" "AIA ON"
		AIP or AIP	0-1 —	— OFF, ON	—	Channel A Internal Phase modulation Syntax: "AIP1" "AIP ON"
		SPE or SPE	0-1 —	— OFF, ON	—	Synchronous Phase modulation External Syntax: "SPE1" "SPE ON"
	CH B	BEA or BEA	0-1 —	— OFF, ON	—	Channel B External Amplitude modulation Syntax: "BEA1" "BEA ON"
		BEP or BEP	0-1 —	— OFF, ON	—	Channel B External Phase modulation Syntax: "BEP1" "BEP ON"
STATUS BLOCK						
	CHAN	CHA	—	—	—	select CHannel A Syntax: "CHA"
		CHB	—	—	—	select CHannel B Syntax: "CHB"

HP 3326A HP-IB MNEMONIC SUMMARY (Cont'd)

Front Panel Control	Mnemonic	Range	Suffix	Interrogation Response	Description Resolution Syntax
SWEEP BLOCK					
CONT	SC	—	—	—	Sweep, Continuous Syntax: "SC"
CNTR FREQ	CF	0-13 MHz	HZ, KHZ, MHZ	CF #####.#####HZ or CF #####.###HZ	Center Frequency Resolution: 1 μHz f < 100 kHz, 1 mHz f ≥ 100 kHz Syntax: "CF10KHZ"
DISCRETE	SM or SM	3 —	— DSCR	—	Sweep Mode - DiSCReTe Syntax: "SM3" "SM DSCR"
MKR FREQ	MF	0-13 MHz	HZ, KHZ, MHZ	MF #####.#####HZ or MF #####.###HZ	Marker Frequency Resolution: 1 μHz f < 100 kHz, 1 mHz f ≥ 100 kHz Syntax: "MF8.0MHZ"
MKR-> CF	CFM	—	—	—	Center Frequency equals Marker value Syntax: "CFM"
RESET SWP	SRE	—	—	—	Sweep REset Syntax: "SRE"
SINGLE	SS	—	—	—	Sweep Single Syntax: "SS"
SPAN	SPAN	0-13 MHz	HZ, KHZ, MHZ	SPAN#####.#####HZ or SPAN#####.###HZ	sweep frequency SPAN Resolution: 1 μHz f < 100 kHz, 1 mHz f ≥ 100 kHz Syntax: "SPAN10MHZ"
START FREQ	ST	0-13 MHz	HZ, KHZ, MHZ	ST #####.#####HZ or ST #####.###HZ	STart frequency Resolution: 1 μHz f < 100 kHz, 1 mHz f ≥ 100 kHz Syntax: "ST3.567891KHZ"
STOP FREQ	SP	0-13 MHz	HZ, KHZ, MHZ	SP #####.#####HZ or SP #####.###HZ	StoP frequency Resolution: 1 μHz f < 100 kHz, 1 mHz f ≥ 100 kHz Syntax: "SP7.1E6HZ"
TIME	STIM	5 ms-1000 s	SEC, MS	STIM ± #.#####E ± ##SEC	Sweep TIME Resolution: 1 MS Syntax: "STIM.3MS"
TRIANGLE	SM or SM	1 —	— RAMP	—	Sweep Mode - linear RAMP Syntax: "SM1" "SM RAMP"
	SM or SM	2 —	— TRGL	—	Sweep Mode - linear TRianGLe Syntax: "SM2" "SM TRGL"

the Status Byte is true (one), an SRQ has occurred. See *Service Request* for the conditions causing a Service request. All other bits (0-5,7) indicate the present status of the noted function. The bits are true (one) only if the associated function/condition is true.

STATUS BIT

The 3326A does not respond to a Parallel Poll.

PASS CONTROL

The 3326A does not have the ability to take or pass control.

ABORT

The 3326A responds to the Abort message (Interface Clear - IFC true) by stopping all Listener or Talker functions.

ADDRESS ASSIGNMENT INFORMATION

The 3326A basic address is factory preset to decimal 18. In the Local mode, this address can be changed from the front panel by pressing the SHIFT and then the LOCAL keys. The display will show the current address; a new one can be entered via the 3326A keyboard.

Table 2: Status Byte Description

Status Byte Bit Numbers: B7 B6 B5 B4 B3 B2 B1 B0		
BIT NUMBER	DECIMAL VALUE	DESCRIPTION
B7	128	POWER RESTORED. Set when power is restored to the HP 3326A after power is interrupted. Reset when the HP 3326A is preset or receives a device clear, selected device clear, or RST command.
B6	64	REQUIRE SERVICE. Set when the HP 3326A requires service (sent an SRQ). Cleared along with the SRQ line when a serial poll is performed. It is also cleared when the condition causing the SRQ is removed.
B5	32	ERROR. Set when either a program or hardware error condition exists for the HP 3326A. Reset when the HP 3326A is preset, or receives a device clear command, selected device clear command, RST command, or when the error register is read with the IERR or ERR? HP-IB command.
B4	16	READY. Set when the HP 3326A has executed the last HP-IB command and is ready for the next command. Reset when the HP 3326A receives a device dependent command, device clear command, selected device clear command, or trigger.
B3	8	HARDWARE ERROR. Set when the HP 3326A detects an internal failure. Reset with an INSTR PRESET, device clear command, selected device clear command, RST command, or when the error register is read with the IERR or ERR? HP-IB command.
B2	4	SWEEP START/IN PROGRESS. Set when the HP 3326A starts a sweep. Reset when the sweep is stopped (either by reaching the stop frequency or aborted by a front panel or HP-IB command). It is also reset when the HP 3326A is preset or receives a device clear command, selected device clear command, or RST command.
B1	2	SWEEP STOPPED. Set when the HP 3326A ends a sweep normally. Reset when the HP 3326A is preset or receives a device clear command, selected device clear command, or RST command.
B0	1	PROGRAM ERROR. Set when the HP 3326A receives an invalid HP-IB command (e.g. command syntax or incompatible command for mode selected). Reset when the HP 3326A is preset or receives a device clear command, selected device clear command, or RST command.

The new address will remain until changed by the operator because of the 3326A's non-volatile memory. However, should battery power be interrupted, the address will default to the factory preset address of 18.

- T6 Basic Talker—Serial Poll capability; no talk only
- L4 Basic Listener—Unaddressed if addressed to talk; no listen only
- SR1 Service Request—full capability
- RL1 Remote Local—complete capability
- PP0 Parallel Poll—no capability
- DC1 Device Clear—full capability
- DT1 Device Trigger—full capability
- C0 Controller—no capability
- E1 Driver Electronics—open collector

INTERFACE FUNCTION CODES

- SH1 Source Handshake—full capability
- AH1 Acceptor Handshake—full capability

Table 3: Error Summary

ERROR#	FRONT PANEL ALPHA	ERROR DESCRIPTION
10	SNTX	Illegal HP-IB code syntax
11	RMOT	Front panel keypress in remote
12	LOCK	LOCAL key pressed in local lockout
20-29	RNGE	Entered parameter out of range
30	B FR	Channel B cannot track
40-49	INTR	Channel A in Two-Tone/HV on
50	CNVT	Cannot interrogate or display parameter
60-69	SUFX	Units conversion rounded to zero
70	INC	Illegal units terminator
80	AMPL	Entry increment value or terminator error
86	MODL	Incompatible with amplitude
87	MODE	Incompatible with modulation
88	FREQ	Incompatible with mode
89	CMBR	Incompatible with frequency
90	SWFR	Incompatible with combiner
94	DUTY	Start and stop frequencies equal
95	SWFR	Pulse duty cycle too narrow
96	SWFR	Illegal sweep frequencies for HV option
100	RATE	Illegal sweep frequency for internal modulation
110-114	DSWP	Illegal sweep rate
115	DSHV	Illegal discrete sweep due to mode or lack of elements
116	DSML	Illegal discrete sweep frequency with HV option
117	DSMD	Illegal discrete sweep frequency with modulation
120	P OF	Mode changed after discrete frequency sweep elements entered
130-139	H V	Cannot clear Channel A Phase Offset
140	CSUM	Cannot program High Voltage option
150		Checksum error indicates bad instrument state
160	CRPT	Requested state is incompatible
170	A OL	Corrupted power-on state is preset
171	B OL	Channel A overloaded
172	SYOL	Channel B overloaded
173	AVCO	Sync output overloaded
174	BVCO	Channel A VCO unlocked
180	XREF	Channel B VCO unlocked
190	MCAL	External Reference unlocked
191	PCAL	Internal AM or PM cal unsuccessful
192	ACAL	Phase cal unsuccessful
193	OCAL	Amplitude cal unsuccessful
194	OCAL	DC Offset cal unsuccessful
300-399	FAIL	Residual Offset cal unsuccessful
		Self Test Error Codes

Table 4: Alphabetical Listing of HP-IB Codes

MNEMONIC DESCRIPTION	
AC	* Calibrate
ACAL	Auto Calibration
AEA	A External AM modulation
AEP	A External PM modulation
AIA	A Internal AM modulation
AIP	A Internal PM modulation
AM	Amplitude
AP	* Assign Zero Phase
BEA	B External AM modulation
BEP	B External PM modulation
BUSM	Bus Mode
CAL	Calibrate
CF	Set Sweep Center Frequency
CFM	Marker to Center Frequency
CHA	Select Channel A
CHB	Select Channel B
CMB	Combiner Enable
CMD	Calibration Mode
COF	Clear Phase Offset (Ch B)
DB	* dBm
DBM	dBm
DBV	dBV
DC	DC Function Selection
DE	* Degrees
DEG	Degrees
DISP	Display Blank
DN	Step Down/Decrement Value
DRCL	Discrete Recall Element
DRST	Discrete Reset Elements
DSAV	Discrete Save Element
DSCR	Discrete Sweep Mode
DUTY	Duty Cycle
EINC	Set the entry-increment value
ER?	* Output Error Number
ERR?	Output Error Number
EXT	External Calibration mode
FCNA	Set Channel A Function
FCNB	Set Channel B Function
FR	Frequency
FU	* Function of selected channel
HV	* High Voltage of selected channel
HVA	High Voltage A
HVB	High Voltage B
HZ	Hz
ID?	Output Instrument ID
INT	Internal Calibration Mode
KH	* kHz
KHZ	kHz
LRN	Output Learn String
MA	* External AM of selected channel
MASK	Request Mask
MD	* Bus Mode
MF	Sweep Marker
MFY	Modify on/off
MH	* MHz

MNEMONIC DESCRIPTION	
MHZ	MHz
ML	Modulation Level (% AM or PM Deviation)
MODE	Mode
MP	* External PM of selected channel
MR	* mV RMS
MS	milliseconds
MULT	Multiphase Calibration Mode
MV	* millivolts peak-to-peak
NOM	No modulation
OF	DC Offset
OFF	Off
ON	On
PC	Percent
PH	Phase
PRG	Program Learn String
PULS	Pulse Mode selection
RAMP	Ramp Sweep Mode
RCL	Recall Register
RDY?	Output Ready Status
RE	* Recall Register
REV?	Output Revision Number
RST	Instrument Preset
SAV	Save Register
SC	Sweep Continuous
SEC	Seconds
SER?	Output Serial Number
SIN	Sine Function selection
SM	Sweep Mode
SP	Sweep Stop Frequency
SPAN	Set Sweep Span
SPE	Synchronous Phase External modulation
SQR	Square Function selection
SR	* Save Register
SRE	Sweep Reset
SS	Sweep Single
ST	Sweep Start Frequency
STC	External Triggered Continuous Sweep
STIM	Sweep Time
STS	External Triggered Single Sweep
TDN	External Triggered Decrement Value
TE	* Self Test
TI	* Sweep Time
TOFF	External Trigger no action
TRGL	Triangle Sweep Mode
TST	Self Test
TUP	External Triggered Increment Value
TWOC	Two-Channel Mode selection
TWOP	Two-Phase Mode selection
TWOT	Two-Tone Mode selection
UP	Step Up/Increment Value
VO	Volts peak-to-peak
VR	* V RMS
VRMS	V RMS
WAIT	Wait
ZPH	Zero Phase

* This is an HP 3325A HP-IB mnemonic that is totally compatible and accepted by the 3326A. Some may require specifying which channel is to be affected by the command.

*OPERATING AND
REFERENCE MANUAL*

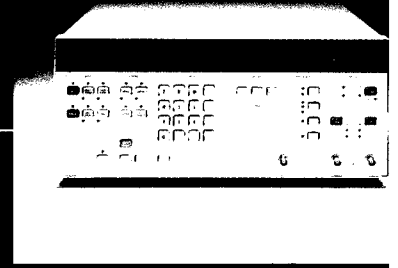



CERTIFICATION

Hewlett-Packard Company certifies that this product met its published specifications at the time of shipment from the factory. Hewlett-Packard further certifies that its calibration measurements are traceable to the United States National Bureau of Standards, to the extent allowed by the Bureau's calibration facility, and to the calibration facilities of other International Standards Organization members.

WARRANTY

This Hewlett-Packard product is warranted against defects in material and workmanship for a period of one year from date of shipment. During the warranty period, Hewlett-Packard Company will, at its option, either repair or replace products which prove to be defective.

For warranty service or repair, this product must be returned to a service facility designated by -hp-. Buyer shall prepay shipping charges to -hp- and -hp- shall pay shipping charges to return the product to Buyer. However, Buyer shall pay all shipping charges, duties, and taxes for products returned to -hp- from another country.

HP software and firmware products which are designated by HP for use with a hardware product, when properly installed on that hardware product, are warranted not to fail to execute their programming instructions due to defects in materials and workmanship. If HP receives notice of such defects during their warranty period, HP shall repair or replace software media and firmware which do not execute their programming instructions due to such defects. HP does not warrant that the operation of the software, firmware or hardware shall be uninterrupted or error free.

LIMITATION OF WARRANTY

The foregoing warranty shall not apply to defects resulting from improper or inadequate maintenance by Buyer, Buyer-supplied software or interfacing, unauthorized modification or misuse, operation outside of the environmental specifications for the product, or improper site preparation or maintenance.

NO OTHER WARRANTY IS EXPRESSED OR IMPLIED. HEWLETT-PACKARD SPECIFICALLY DISCLAIMS THE IMPLIED WARRANTIES OF MERCHANTABILITY AND FITNESS FOR A PARTICULAR PURPOSE.

EXCLUSIVE REMEDIES

THE REMEDIES PROVIDED HEREIN ARE BUYER'S SOLE AND EXCLUSIVE REMEDIES. HEWLETT-PACKARD SHALL NOT BE LIABLE FOR ANY DIRECT, INDIRECT, SPECIAL, INCIDENTAL, OR CONSEQUENTIAL DAMAGES, WHETHER BASED ON CONTRACT, TORT, OR ANY OTHER LEGAL THEORY.

ASSISTANCE

Product maintenance agreements and other customer assistance agreements are available for Hewlett-Packard products.

For any assistance, contact your nearest Hewlett-Packard Sales and Service Office. Addresses are provided at the back of this manual.

OPERATING MANUAL

MODEL 3326A
TWO-CHANNEL SYNTHESIZER

WARNING

*To prevent potential fire or shock hazard, do not
expose equipment to rain or moisture.*

Manual Part No. P/O 03326-90000

Microfiche Part No. 03326-90050

© Copyright Hewlett-Packard Company 1984
P.O. Box 69, Marysville, Washington 98270 U.S.A.

Printed: September 1984



SAFETY SUMMARY

The following general safety precautions must be observed during all phases of operation, service, and repair of this instrument. Failure to comply with these precautions or with specific warnings elsewhere in this manual violates safety standards of design, manufacture, and intended use of the instrument. Hewlett-Packard Company assumes no liability for the customer's failure to comply with these requirements. This is a Safety Class 1 instrument.

GROUND THE INSTRUMENT

To minimize shock hazard, the instrument chassis and cabinet must be connected to an electrical ground. The instrument is equipped with a three conductor ac power cable. The power cable must either be plugged into an approved three-contact electrical outlet or used with a three-contact to two-contact adapter with the grounding wire (green) firmly connected to an electrical ground (safety ground) at the power outlet. The power jack and mating plug of the power cable meet International Electrotechnical Commission (IEC) safety standards.

DO NOT OPERATE IN AN EXPLOSIVE ATMOSPHERE

Do not operate the instrument in the presence of flammable gases or fumes. Operation of any electrical instrument in such an environment constitutes a definite safety hazard.

KEEP AWAY FROM LIVE CIRCUITS

Operating personnel must not remove instrument covers. Component replacement and internal adjustments must be made by qualified maintenance personnel. Do not replace components with power cable connected. Under certain conditions, dangerous voltages may exist even with the power cable removed. To avoid injuries, always disconnect power and discharge circuits before touching them.

DO NOT SERVICE OR ADJUST ALONE

Do not attempt internal service or adjustment unless another person, capable of rendering first aid and resuscitation, is present.

DO NOT SUBSTITUTE PARTS OR MODIFY INSTRUMENT

Because of the danger of introducing additional hazards, do not install substitute parts or perform any unauthorized modification to the instrument. Return the instrument to a Hewlett-Packard Sales and Service Office for service and repair to ensure that safety features are maintained.

DANGEROUS PROCEDURE WARNINGS

Warnings, such as the example below, precede potentially dangerous procedures throughout this manual. Instructions contained in the warnings must be followed.

WARNING

Dangerous voltages, capable of causing death, are present in this instrument. Use extreme caution when handling, testing, and adjusting.

SAFETY SYMBOLS

General Definitions of Safety Symbols Used On Equipment or In Manuals.



Instruction manual symbol: the product will be marked with this symbol when it is necessary for the user to refer to the instruction manual in order to protect against damage to the instrument.



Indicates dangerous voltage (terminals fed from the interior by voltage exceeding 1000 volts must be so marked).

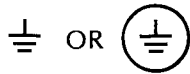

Protective conductor terminal. For protection against electrical shock in case of a fault. Used with field wiring terminals to indicate the terminal which must be connected to ground before operating equipment.



Low-noise or noiseless, clean ground (earth) terminal. Used for a signal common, as well as providing protection against electrical shock in case of a fault. A terminal marked with this symbol must be connected to ground in the manner described in the installation (operating) manual, and before operating the equipment.



Frame or chassis terminal. A connection to the frame (chassis) of the equipment which normally includes all exposed metal structures.



Alternating current (power line).



Direct current (power line).



Alternating or direct current (power line).

WARNING

The WARNING sign denotes a hazard. It calls attention to a procedure, practice, condition or the like, which, if not correctly performed or adhered to, could result in injury or death to personnel.

CAUTION

The CAUTION sign denotes a hazard. It calls attention to an operating procedure, practice, condition or the like, which, if not correctly performed or adhered to, could result in damage to or destruction of part or all of the product.

NOTE

The NOTE sign denotes important information. It calls attention to procedure, practice, condition or the like, which is essential to highlight.

Printing History

New editions are complete revisions of the manual. Update packages, which are issued between editions, contain additional and replacement pages to be merged into the manual by the customer. The dates on the title page change only when a new edition or a new update is published. No information is incorporated into a reprinting unless it appears as a prior update; the edition does not change when an update is incorporated.

A software code may be printed before the date; this indicates the version level of the software product at the time the manual or update was issued. Many product updates and fixes do not require manual changes and, conversely, manual corrections may be done without accompanying product changes. Therefore, do not expect a one-to-one correspondence between product updates and manual updates.

Edition 1	September 1984	03326-90000	E0984
Update 1	December 1987		U1287
(Manual Changes October, 1984 Incorporated)			I1287

TABLE OF CONTENTS

Chapter 1 — Operation and Reference

HP 3326A TURN ON AND WARM UP	1-2
CH A AND CH B OUTPUTS	1-5
SELECTING AN OPERATING MODE	1-6
SELECTING THE OUTPUT FUNCTION	1-12
DATA ENTRY AND MODIFICATION	1-14
THE ENTRY KEYS	1-20
LINEAR FREQUENCY SWEEP	1-29
DISCRETE FREQUENCY SWEEP	1-39
MODULATION	1-44
SAVING / RECALLING AN INSTRUMENT STATE, AND MEMORY OPERATIONS	1-50
CALIBRATION AND SELF TEST	1-53
HP-IB STATUS KEYS / INDICATORS / CONNECTOR	1-57
EXTERNAL TRIGGER	1-59
MARKER / Z-BLANK (PEN LIFT) / X-DRIVE OUTPUTS	1-59
SYNC A OUTPUT	1-63
20-33 MHz L.O. OUTPUT (EXTENDED FREQUENCY)	1-64
PHASE LOCK TO EXT REF/OVEN STABILIZED FREQUENCY OPTION	1-66

Chapter 2 — HP-IB Operation

DESCRIPTION OF THE HP-IB	2-1
HP 3326A HP-IB CAPABILITY	2-2
HP-IB INTERFACE MANAGEMENT LINES	2-2
TALK / LISTEN ADDRESSES	2-2
VIEWING THE HP 3326A HP-IB ADDRESS	2-4
CHANGING THE HP 3326A HP-IB ADDRESS	2-4
BUS MESSAGES	2-4
SERVICE REQUEST	2-6
THE STATUS BYTE	2-7
MASKING THE STATUS BYTE	2-8

Chapter 3 — HP 3326A HP-IB Commands

REMOTE FRONT PANEL OPERATION	3-1
COMMAND SYNTAX	3-1
BUS MODES	3-3
VIEWING THE HP 3326A HP-IB ADDRESS	3-3
CHANGING THE HP 3326A HP-IB ADDRESS	3-4
INTERROGATING THE HP 3326A FOR SETUP PARAMETERS	3-4
DISPLAYING THE HP 3326A SETUP PARAMETERS	3-4
MODIFYING PARAMETERS	3-5
DISPLAY CONTROL	3-6
SAVING OR RESTORING AN HP 3326A SETUP	3-6
HP 3326A IDENTIFICATION	3-7
TRIGGERED SWEEPS	3-8
READING AND MASKING THE STATUS BYTE	3-8
ERROR CODES	3-10
HP 3325A COMPATIBILITY	3-12
UNITS	3-13
HP 3326A MNEMONICS SUMMARIES	3-13

Appendices

APPENDIX A	A1
APPENDIX B	B1
APPENDIX C	Inside Rear Cover

CHAPTER 1
OPERATION AND REFERENCE



Chapter 1 — Table of Contents

HP 3326A TURN ON AND WARM UP	1-2
CH A AND CH B OUTPUTS	1-5
SELECTING AN OPERATING MODE	1-6
SELECTING THE OUTPUT FUNCTION	1-12
DATA ENTRY AND MODIFICATION	1-14
THE ENTRY KEYS	1-20
LINEAR FREQUENCY SWEEP	1-29
DISCRETE FREQUENCY SWEEP	1-39
MODULATION	1-44
SAVING / RECALLING AN INSTRUMENT STATE, AND MEMORY OPERATIONS	1-50
CALIBRATION AND SELF TEST	1-53
HP-IB STATUS KEYS / INDICATORS / CONNECTOR	1-57
EXTERNAL TRIGGER	1-59
MARKER / Z-BLANK (PEN LIFT) / X-DRIVE OUTPUTS	1-59
SYNC A OUTPUT	1-63
20-33 MHz L.O. OUTPUT (EXTENDED FREQUENCY)	1-64
PHASE LOCK TO EXT REF/OVEN STABILIZED FREQUENCY OPTION	1-66



OPERATION AND REFERENCE

This chapter contains a description of the manual operation of the HP 3326A Two Channel Synthesizer. This chapter is subdivided into sections describing each major function of the HP 3326A. The sections contained in this chapter are listed in the table of contents printed on the chapter divider.

CAUTION

Prior to operating the HP 3326A, check that the fuse rating and line voltage setting are correct for the local ac power source. The POWER REQUIREMENTS section in the HP 3326A Installation Manual contains information on setting the line voltage selector and selecting the fuse of the HP 3326A for the local ac power source.

NOTE

A fold out page located at the back of this manual illustrates the front and rear panel controls, connectors, and indicators on the HP 3326A. This illustration can be extended for easy reference while reading this manual.

Examples of HP-IB commands that correspond to front panel keys are listed after the front panel key description. HP-IB commands are used for remote operation of the HP 3326A with a controller. A complete list of HP-IB commands is included in Chapter III, "HP 3326A HP-IB COMMANDS."

HP 3326A TURN ON AND WARM UP

Turn On and Power Up Self Tests

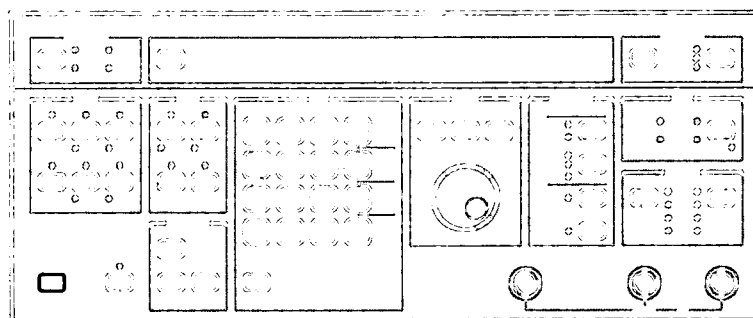

Connect the HP 3326A to a suitable power source and depress the POWER switch to apply power to the entire HP 3326A. When power is applied, the HP 3326A initially displays "HP 3326A" followed by a list of the options installed. The HP 3326A then initiates a series of self tests and calibrates internal circuits. During a self test, all indicators (except the EXT REF indicator) and display segments are illuminated then extinguished, and a series of internal tests are initiated. After each internal test, PASS or FAIL followed by a test number is displayed to indicate the test results. During a self test, the outputs are disabled.

When power is removed from the HP 3326A with the POWER key, the HP 3326A is in a standby condition. In the standby condition, power is applied to the high stability frequency reference circuits (Option 001) to maintain frequency accuracy.

Turn On State

The initial state of the HP 3326A at power up is dependent upon the setting of internal switches. The normal turn on state is the preset state described in "The Preset State and the INSTR PRESET Key". However, through the use of the internal SAVE switch, the setup state selected prior to removing power can be selected as the turn on state. Setting of internal switches must be done by qualified service personnel. The location and settings of the SAVE switch are described in the HP 3326A Service Manual.

Warm Up

An HP 3326A without the high stability frequency reference (Option 001) requires 30 minutes of operation to meet all specifications. An HP 3326A with Option 001 requires 15 minutes of operation to meet frequency specifications if power is disconnected for less than 24 hours. If power is disconnected from the HP 3326A with Option 001 for

more than 24 hours, up to 72 hours of operation may be required to meet frequency specifications. The HP 3326A with Option 001 requires 30 minutes of operation to meet other specifications.

NOTE

When power is removed from the HP 3326A with the POWER key, the HP 3326A is in a standby condition. In the standby condition, power is applied to the high stability frequency reference circuits (Option 001) to maintain frequency accuracy.

The Preset State and the Instr Preset Key

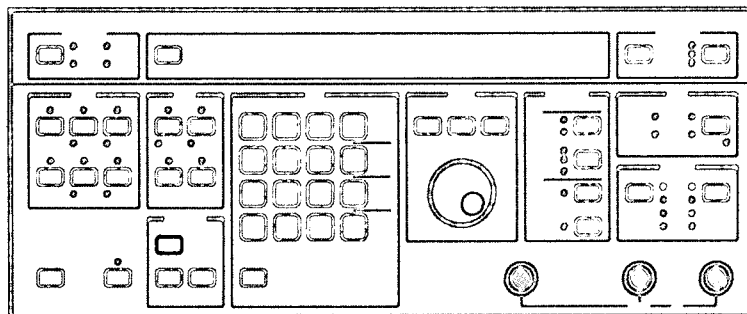

The preset state of the HP 3326A is listed in Figure 1-1. The HP 3326A is restored to the preset state by pressing the green INSTR PRESET (INSTRUMENT PRESET) key. INSTR PRESET provides a convenient starting state for establishing an instrument setup. INSTR PRESET does not destroy instrument states or discrete frequency sweep elements stored in the internal nonvolatile memory.

HP-IB Example:

"RST"

KEY GROUP	KEY	PRESET STATE/VALUE
MODE	MODE COMBINED	2 CHANNEL Off
FUNCTION	CH A CH B CH A HV CH B HV	Sine wave Sine wave Off Off
STATUS	CHAN	Channel A
ENTRY	FREQ DUTY CYCLE AMPTD % AM/PM DEV PHASE ASSIGN ZERO ϕ DC OFFSET CLR ϕ OFS	1 kHz 50 % 0.1 V Peak-to-peak 30% (AM) / 108° (PM) 0° — 0 V —
SWEEP	CONT START FREQ CNTR FREQ STOP FREQ SPAN SINGLE RESET SWP MKR FREQ TRIANGLE TIME DISCRETE	Disabled 0 Hz 6.5 MHz 13 MHz 13 MHz Disabled — 6.5 MHz (Channel A) Ramp selected 1 second Disabled (Linear sweep)
CALIBRATION	MANUAL AUTO SELECT SELF TEST	— Disabled INTERNAL —
MODULATION	—	Off
MODIFY	ON/OFF	Off
UNGROUPED KEYS	SHIFT	Off
TRIGGER SIGNAL	—	Single sweep pending
HP-IB STATUS	LOCAL BUS ADRS	No effect No effect

Figure 1-1. HP 3326A Preset State

CH A AND CH B OUTPUTS

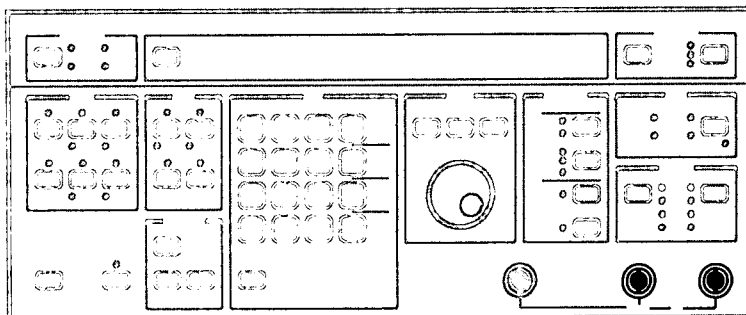

CH A and CH B Output Connectors

The CH A (channel A) and CH B (channel B) output connectors are normally located on the front panel. Option 003, Rear Panel Main Signal Outputs, replaces the front panel channel A and B outputs with rear panel outputs.

The channel A connector, in addition to being the output for channel A, is also the active output for combined and internal modulation operation. For combined and internal modulation operation, the channel B output is used internally and is unavailable at the CH B connector.

The output impedance is 50Ω from 0 to 100 kHz, with a return loss of greater than 20 dB over the range of 100 kHz to 13 MHz. The output impedance with the high voltage option enabled is less than 2Ω from 0 to 50 kHz, and less than 10Ω over the range of 50 kHz to 1 MHz. Both outputs share the same ground and may be floated up to ± 42 volts peak.

**WARNING**

The maximum peak voltage (ac + dc) that can be safely applied between chassis and the outer conductor of the HP 3326A input and output connectors is ± 42 volts peak.

Setup For Viewing Output Waveforms

Figure 1-2 illustrates a simple setup to view the HP 3326A outputs and observe the effects of changing the HP 3326A settings. For example purposes, the selection of an oscilloscope is not critical although a dual channel oscilloscope has the advantage of displaying both channels simultaneously.

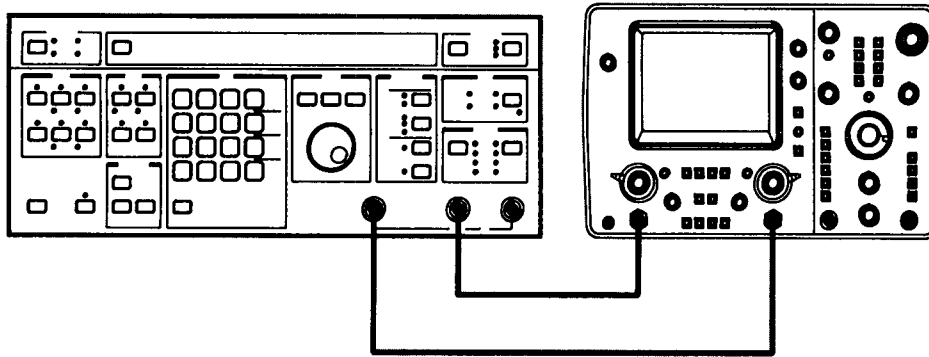
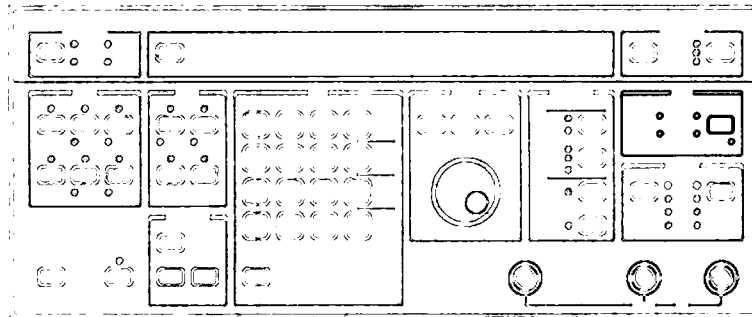

Figure 1-2. Connections for Viewing Output

SELECTING AN OPERATING MODE



The Mode Key

MODE

The MODE key selects the operating mode of the HP 3326A. Each time the MODE key is pressed, the operating mode sequences through the 2 CHANNEL, 2 PHASE, 2 TONE, and PULSE operating modes. The mode selected is indicated by the illuminated indicator. COMBINED operation is enabled by pressing the blue SHIFT key prior to the MODE key. The operating modes affect operating limits, operating characteristics, and selection of the CH A and CH B outputs. The effects on the operating characteristics and limits are included in the applicable sections for the characteristics and limits. When the 2 PHASE or PULSE mode is selected, the HP 3326A performs an internal phase calibration. During a mode change, the channel A and B outputs are disabled.

2 Channel Mode

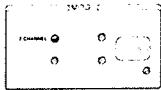











In the 2 CHANNEL mode, the HP 3326A operates as two independent synthesizers. Sweep parameters, frequency, amplitude, dc offset, external modulation, sine wave output, and square wave output is independent for each channel. With internal modulation enabled, the channel B synthesizer is used to internally modulate the channel A synthesizer. Figure 1-3 illustrates the effect of changing frequency in the 2 CHANNEL mode.

HP-IB Examples:

“MODE1”
OR
“MODE TWOC”

STEP 1  NOTE THAT "2 CHANNEL" IS ILLUMINATED IN THE MODE SECTION OF THE FRONT PANEL

STEP 2  CH A  1 
 1 

STEP 3  CH B  1 
 1 

TYPICAL OSCILLOSCOPE DISPLAY RESULT

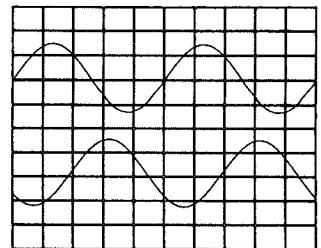

STEP 4  CH B  2 

TYPICAL OSCILLOSCOPE DISPLAY RESULT

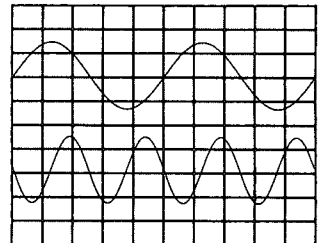
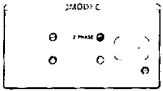

Figure 1-3. Frequency Change In 2 Channel Mode

2 Phase Mode



In the 2 PHASE mode, both channel A and B frequencies are the same (see Figure 1-4). The phase offset of channel B with respect to channel A remains constant as frequency is changed. Amplitude, dc offset, external amplitude modulation, sine wave output, and square wave output is independent for each channel.

HP-IB Examples:

"MODE 2"
or
"MODE TWOP"

STEP 1 **INSTR PRESET** **MODE** PRESS UNTIL "2 PHASE" IS ILLUMINATED

STEP 2 **CHAN** CH A **FREQ** 1 kHz
Vrms
mSEC
AMPTD 1 kHz
Vrms
mSEC

STEP 3 **CHAN** CH B **AMPTD** 1 kHz
Vrms
mSEC

TYPICAL OSCILLOSCOPE DISPLAY RESULT

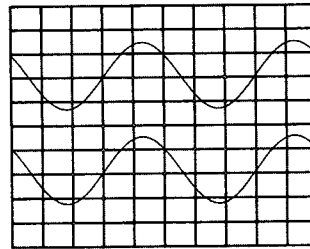

STEP 4 **CHAN** CH A **FREQ** 3 kHz
Vrms
mSEC

TYPICAL OSCILLOSCOPE DISPLAY RESULT

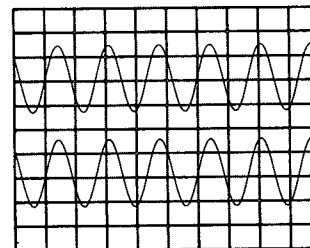

Figure 1-4. Frequency Change In 2 Phase Mode

2 Tone Mode



In the 2 TONE mode, the channel B frequency tracks changes to the channel A frequency (see Figure 1-5). The maximum frequency difference between channel A and channel B is 100 kHz. Amplitude, dc offset, external amplitude modulation, sine wave output, and square wave output are independent for each channel.

HP-IB Examples:

"MODE3"
OR
"MODE TWOT"

STEP 1 **INSTR PRESET** **MODE** PRESS UNTIL "2 TONE" IS ILLUMINATED

STEP 2 **CHAN** CH A **FREQ** 1 [] kHz
[] Vrms
[] mSEC
AMPTD 1 [] kHz
[] Vrms
[] mSEC

STEP 3 **CHAN** CH B **FREQ** 2 [] kHz
[] Vrms
[] mSEC
AMPTD 1 [] kHz
[] Vrms
[] mSEC

TYPICAL OSCILLOSCOPE DISPLAY RESULT

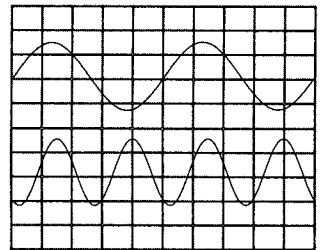

STEP 4 **CHAN** CH A **FREQ** 2 [] kHz
[] Vrms
[] mSEC

TYPICAL OSCILLOSCOPE DISPLAY RESULT

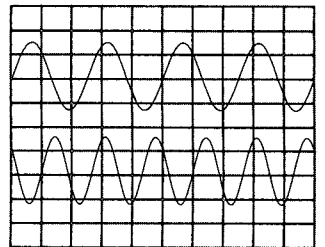

Figure 1-5. Frequency Change In 2 Tone Mode

Pulse Mode



In the PULSE mode, the channel B square wave output is the complement of the channel A square wave output (see Figure 1-6). Amplitude, dc offset, and external amplitude modulation are independent for each channel.

HP-IB Examples:

“MODE4”
 or
 “MODE PULS”

STEP 1 PRESS UNTIL "PULSE" IS ILLUMINATED

STEP 2 CH A kHz
 V_{rms}
 mSEC
 MHz
 VOLTS
 DEG
 SEC

STEP 3 CH B MHz
 VOLTS
 DEG
 SEC

TYPICAL OSCILLOSCOPE DISPLAY RESULT

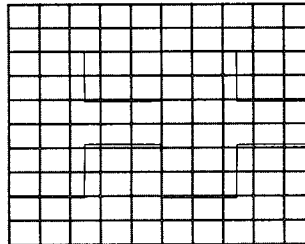

STEP 4 CH A kHz
 V_{rms}
 mSEC

TYPICAL OSCILLOSCOPE DISPLAY RESULT

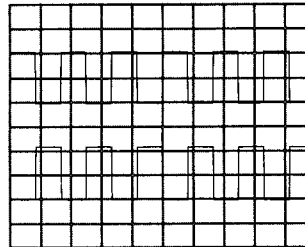
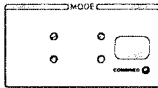

Figure 1-6. Frequency Change in Pulse Mode

Combined Operation



With COMBINED operation, the channel B output is diverted and summed with the channel A output (see Figure 1-7). COMBINED operation reduces the amplitude output limit of each channel by 50% (6.02 dB) and sets the dc offset level to zero. DC offsets can be entered if DC is selected as the function, however, when alternate functions (OFF, sine wave, or square wave) are selected, the DC offset level is returned to zero. When COMBINED operation is enabled, either a DC function, or a high voltage output may be selected. Note that the peak-to-peak amplitude of the output signal is a function of the phase, frequency, and amplitude of each channel. COMBINED operation is selectable only in the 2 CHANNEL, 2 PHASE, and 2 TONE MODES. COMBINED operation is disabled for internal modulation.

HP-IB Examples:

“CMB1”
or
“CMB ON”

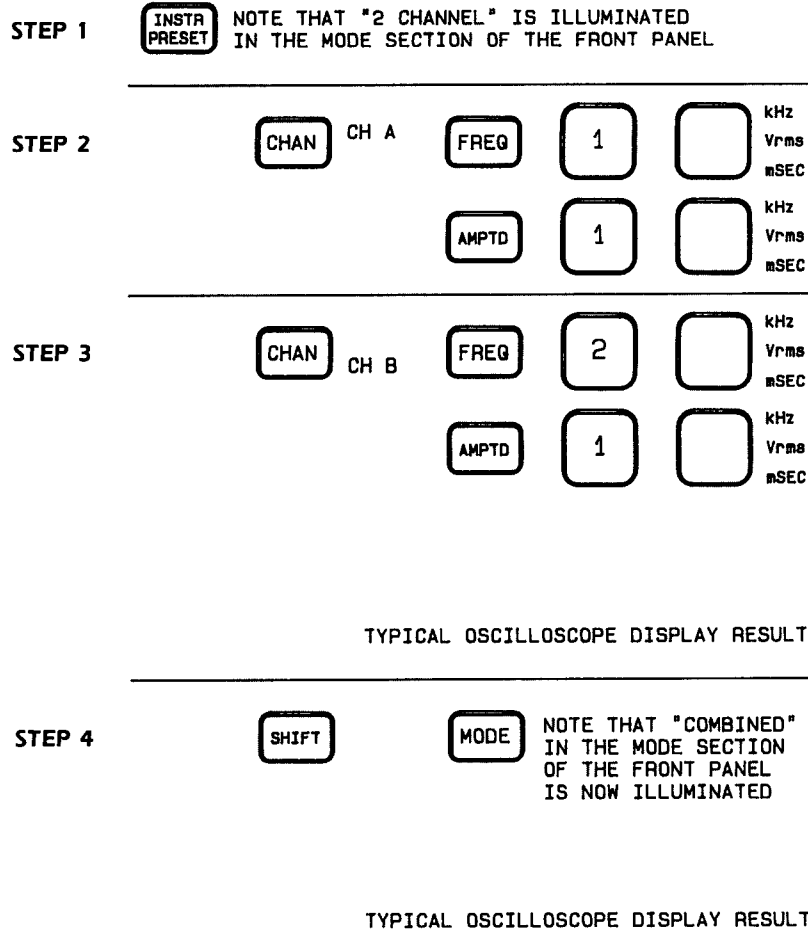
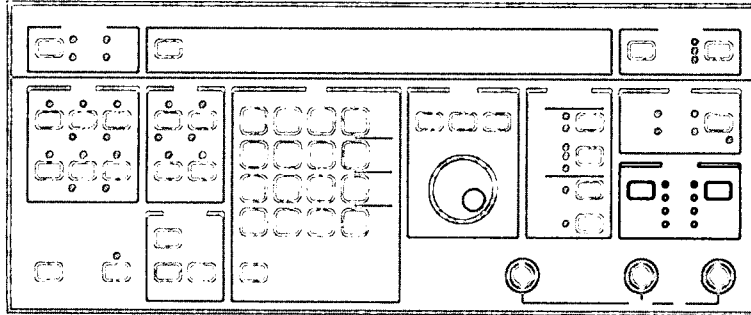
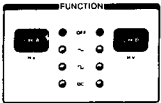

Figure 1-7. Combined Operation

SELECTING THE OUTPUT FUNCTION



The CH A and CH B Keys



The CH A and CH B keys select the output waveform for the channel A and channel B outputs, respectively. Each time the CH A or CH B key is pressed, the output waveform sequences through the OFF, \sim (sine wave), \square (square wave), and DC outputs. The selected output is indicated by an illuminated indicator. If the pulse mode is selected, the sine wave and DC only output is removed from the output waveform selection sequence. The blue high voltage (HV) legends printed below these keys are active only if the high voltage option (Option 002) is installed.

The Off, \sim , \square , and DC Indicators

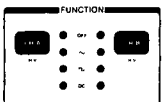

When all function indicators are extinguished, the output channel is disabled.

HP-IB Examples:

“FCNA0”
or
“FCNA OFF”
“FCNBO”
or
“FCNB OFF”

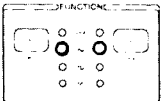

The \sim (sine wave) indicator illuminates when a sine wave output is enabled. If the pulse mode is selected, the sine wave output is removed from the output waveform selection sequence.

HP-IB Examples:

“FCNA1”
or
“FCNA SIN”
“FCNB 1”
or
“FCNB SIN”

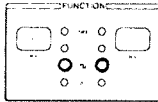

The  (square wave) indicator illuminates when a square wave output is enabled.

HP-IB Examples:

“FCNA2”
 or
 “FCNA SQR”
 “FCNB 2”
 or
 “FCNB SQR”

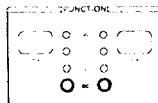

The DC indicator illuminates when a dc only output is enabled. With dc only, the ac portion of the output is suppressed. The output amplitude for the DC function is controlled by the value entered for the DC OFFSET key.

HP-IB Examples:

“FCNA3”
 or
 “FCNA DC”
 “FCNB3”
 or
 “FCNB DC”

The High Voltage Option (Option 002)

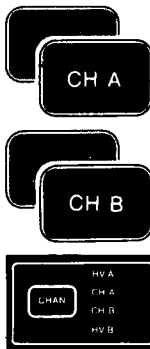

The HV (high voltage) key enables or disables the high voltage output option. The HV key is available by pressing the blue SHIFT key prior to pressing the CH A or CH B key. An HV indicator, to the left of the display, illuminates when a high voltage output is enabled. The high voltage option increase the available output voltage range by a factor of four with a maximum value of 40 volts peak-to-peak. Enabling the high voltage option reduces the maximum output frequency to 1 MHz, and decreases the output impedance. The output signal is momentarily set at zero volts if internal attenuator settings change.

NOTE

The channel B high voltage option is disabled if the channel A frequency is greater than 1 MHz and the HP 3326A mode is changed. The channel B frequency must be reduced below 1 MHz before the high voltage option can be enabled.

HP-IB Examples:

“HVA1” “HVB1”
 or
 “HVA ON” “HVB ON”

DATA ENTRY AND MODIFICATION

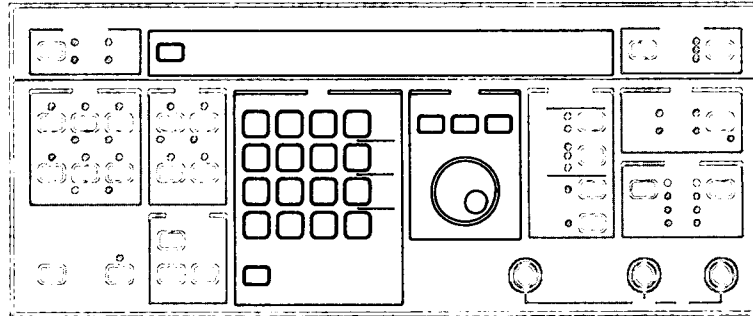

Selecting the Channel for Modification



Prior to entering data to specify the HP 3326A output, it is necessary to select the channel to be modified with the CHAN key to the left of the display window. The channel currently selected is indicated by the illuminated CH A or CH B indicator next to the CHAN key. The CHAN key selects the alternate channel for display and modification each time the CHAN key is pressed.

HP-IB Examples:

“CHA”
“CHB”

The Data Keys

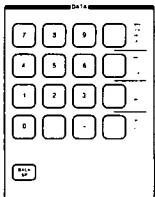

Entering setup values with the numeric keypad is a simple three step process. Select a parameter to change, enter the desired value (most significant digit first), and end the entry with a units key. For example, to change the output amplitude to 1 Vrms, press the AMPTD (amplitude) key and display the current amplitude value. Press the 1 key in the numeric keypad, and press the kHz Vrms mSEC units key to end the entry (see Figure 1-9). Notice that the Vrms units from the kHz Vrms mSEC units key are assigned to the data value. The HP 3326A assigns the units to the data value that corresponds to parameter being changed. If the entered value exceeds the HP 3326A range limits, the entered value is ignored and an error message is displayed. To cancel an incomplete data entry, press any key that requires the display for data entry (see Figure 1-8). lists the keys that accept numeric data.

AMPTD	RCL DISCRETE
BUS ADRS	SAVE
CNTR FREQ	SAVE DISCRETE
DC OFFSET	SPAN
DUTY CYCLE	START FREQ
FREQ	STOP FREQ
MKR FREQ	TIME
PHASE	% AM/PM DEV
RECALL	

Figure 1-8. Keys That Accept Data Values



The value in the display window is edited during data entry with the BACK SPACE key. Each time the BACK SPACE key is pressed, the least significant digit or decimal point is removed from the display. After the incorrect digits are removed from the display value, data entry can continue with the numeric keypad and units keys. Figure 1-9 illustrates the use of the BACK SPACE key.

DATA ENTRY

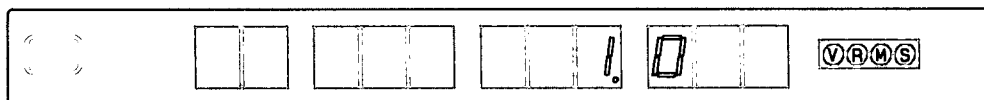

DATA CORRECTION

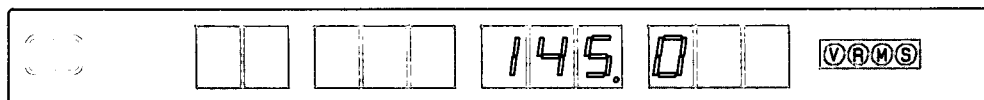

Figure 1-9. Data Entry Example

Error Messages

If an attempt is made to enter or modify operating parameters beyond the HP 3326A capabilities, the new input is ignored and an error message and code is displayed. Figure 1-10 lists the error messages and explanations of the errors. A complete list of the error messages and codes is included in Appendix A.

ERROR MESSAGE	CODES	DESCRIPTION
SNTX	10	(HP-IB SyNTaX) AN HP-IB command has a syntax error.
RMOT	11	(ReMOTe) A front panel key is pressed while the HP 3326A is in remote.
LOCK	12	(local LOCKout) The LOCAL key is pressed while the HP 3326A is in local lockout.
RNGE	20, 26, 29	(RaNGE) The value entered for the selected parameter exceeds the valid limits.
INTR	40, 46, 47	(INTeRrogate) The value of the function requested cannot be displayed because of the mode, modulation, channel, or sweep selected.
CNVT	50	(CoNVerTs) The units conversion requested results in an invalid zero display value.
SUFx	60, 65	(SUFfix) The units key selected is improper for the function selected.
INC	70	(INCrement) The increment value or units used over the HP-IB is incompatible with the displayed value.
AMPL	80	(AMPLitude) Combined operation is selected and the current amplitude is too large.
MODL	86	(MODuLation) The requested value is incompatible with the modulation mode selected.
MODE	87	(MODE) The requested value or function is incompatible with the mode selected.
FREQ	88	(FREQuency) The channel B frequency value is too large for modulation.
CMBR	89	(CoMBineR) The requested value or function is incompatible with combined operation.
SWFR	90, 95, 96	(SWEEP FREquency) The sweep frequencies are not valid for sweep operation, high voltage option, internal PM, or internal AM.
DUTY	94	(DUTY cycle) The duty cycle of a PULSE is too narrow for a sweep.
RATE	100	(RATE) The sweep rate is less than 5 mHz/s or greater than 0.5 MHz/ms.
DSWP	110, 114	(DiScrete frequency SWEEP) The discrete frequency sweep is invalid because of mode selected or the lack of sweep elements.

Figure 1-10. Error Messages

DSHV	115	(Discrete Sweep High Voltage) The high voltage option is enabled and a discrete frequency element frequency exceeds 1 MHz.
DSML	116	(Discrete Sweep ModuLation) The channel B frequency exceeds the 5 kHz internal Pm limit or exceeds the 100 kHz internal AM limit during a discrete frequency sweep.
DSMD	117	(Discrete Sweep MoDe) The discrete frequency sweep elements in memory are incompatible with the mode selected.
P OF	120	(Phase OFset) Cannot clear phase offset of channel A.
H V	130, 136, 138	(High Voltage) The high voltage (HV) option cannot be enabled because the output frequency is greater than 1 MHz, the option is not installed, or modulation is enabled.
CSUM	140	(CheckSUM) An error is detected in setup data when recalled from memory.
CRPT	160	(CoRruPT) An error is detected in an instrument state recalled from memory. The instrument state is replaced with the preset state.
A OL	170	(A OverLoad) The channel A output is overloaded. The load impedance for the channel A output is too low or a voltage source is attached to the channel A output.
B OL	171	(B OverLoad) The channel B output is overloaded. The load impedance for the channel B output is too low or a voltage source is attached to the channel B output.
SYOL	172	(SYnc OverLoad) The SYNC A output is overloaded. The load impedance attached to the SYNC A output is too low or a voltage source is attached to the SYNC output.
AVCO	173	(channel A Voltage Controlled Oscillator) The channel A voltage controlled oscillator is unlocked.
BVCO	174	(channel B Voltage Controlled Oscillator) The channel B voltage controlled oscillator is unlocked.
XREF	180	(eXternal REference) An external reference signal is sensed, but the HP 3326A cannot lock to it.
MCAL	190	(Modulation CALibration) An internal AM or PM calibration is unsuccessful.
PCAL	191	(Phase CALibration) A phase calibration is unsuccessful.
ACAL	192	(Amplitude CALibration) An amplitude calibration is unsuccessful.
OCAL	193-194	(Offset CALibration) A dc offset calibration is unsuccessful.
PASS	—	A self test is successful.
FAIL	—	A self test is unsuccessful.

Viewing Setup Parameters

The current value of a setup parameter is displayed when a front panel key that accepts entries from the keypad (such as the **FREQ** or **AMPTD** key) is pressed. Figure 1-8 lists the front panel keys that accept entries from the keypad. Selecting one of these keys does not alter the current setup values. An error message is displayed if the key pressed is inactive for the mode selected. Pressing the **CHAN** key alternates the display between the channel A and B values for the parameter selected.

Units Conversion

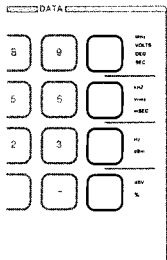

The units keys, in addition to ending data entry, can perform units conversion on displayed values. Pressing a units key converts the value to the equivalent value for the units key pressed. For example, if the display value is in dBm, pressing the dBV % units key converts the display value to dBV. Converting units does not alter the current setup. The message "Error 50 CNVT" (CoNVerT) is displayed if the conversion would result in a zero display value that is inconsistent with the current value. For example, converting 0.000001 Hz to MHz would erroneously display 0 MHz. Figure 1-11 illustrates units conversion.

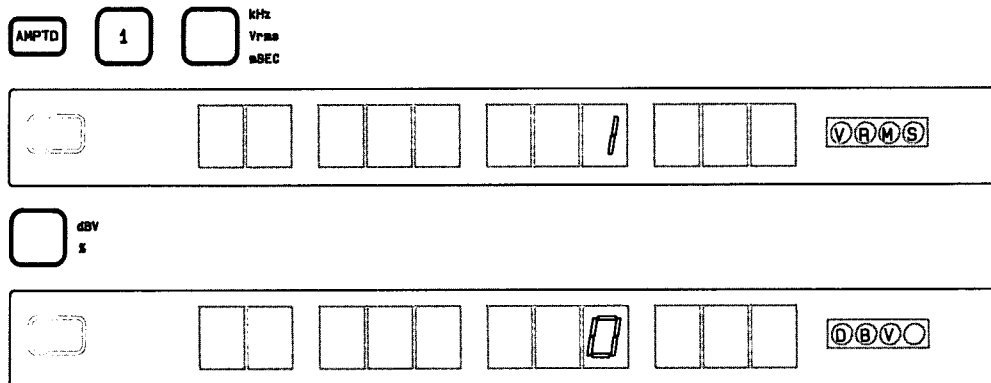
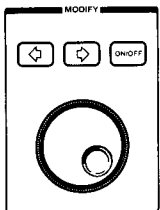

Figure 1-11. Units Conversion

Modifying Entry Values with the Rotary Knob



The display value can be modified with the rotary knob and keys in the **MODIFY** control group (see Figure 1-12). The rotary knob is enabled with either the arrow keys or **ON/OFF** key. When the modify rotary knob is enabled, a single digit in the display flashes. The flashing digit is the least significant digit that is modified with the rotary knob. Turning the rotary knob clockwise increments the value of the display, while turning the rotary knob counterclockwise decrements the value of the display. The rotary knob modifies the display value until the boundary limit is reached. The rotary knob (and flashing digit) is disabled with the **ON/OFF** key. Figure 1-13 lists the display values that are modified with the rotary knob.

The display digit modified with the rotary knob is selected with the right arrow and left arrow keys. Pressing the right arrow key selects the next least significant digit for modification and pressing the left arrow key selects the next most significant digit for modification.

HP-IB Examples:

"MFY1"
or
"MFY ON"

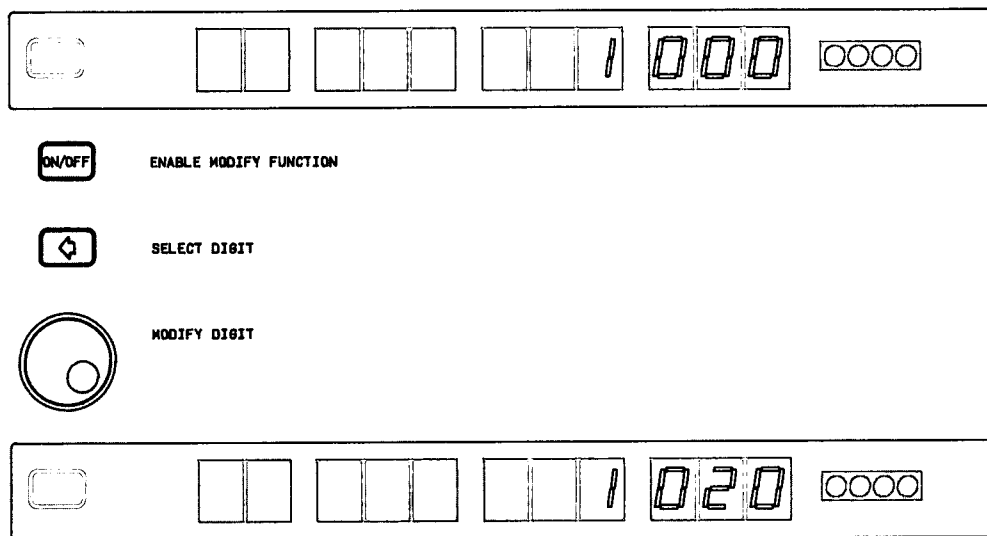
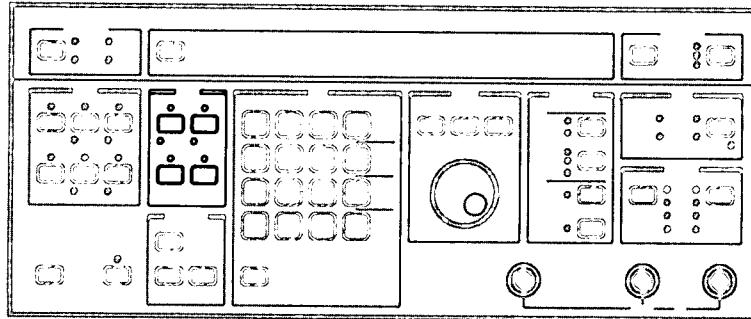

Figure 1-12. Modifying Entries with the Rotary Knob

AM PERCENT MODULATION	FREQUENCY	START FREQUENCY
AMPLITUDE	MARKER FREQUENCY	STOP FREQUENCY
DC OFFSET	PHASE	TIME
DUTY CYCLE	PM PEAK DEVIATION	
CENTER FREQUENCY	SPAN	

Figure 1-13. Parameters Modified with the Rotary Knob

THE ENTRY KEYS



Frequency



The **FREQ** (frequency) key enables display, entry or modification of the frequency of the channel selected with the **CHAN** key. The indicator above the **FREQ** key illuminates when the output frequency value is displayed. The displayed frequency value is changed with the numeric keypad and units keys, or modified with the **MODIFY** controls. The MHz, kHz, and Hz units allow convenient entry of frequency values. Frequency resolution is 1 μ Hz for frequencies below 100 kHz, and 1 mHz for 100 kHz and above. Frequency ranges are dependent upon selection of the operating mode and high voltage option (see Figure 1-14). During a frequency change the output is phase continuous; that is, there are no phase discontinuities in the output waveform.

NOTE

After a mode change, the channel B frequency is set to the channel A frequency.

2 Channel Mode

Each channel frequency is set independently. The frequency range for each channel is 0 to 13 MHz.

2 Phase or Pulse Mode

The frequency of both channels is set to the same value by a change in frequency of either channel. The frequency range is 0 to 13 MHz.

2 Tone Mode

The channel B frequency tracks changes to the channel A frequency. The frequency range of channel A is 0 to 13 MHz. The channel B frequency can have up to a 100 kHz offset from channel A with a maximum frequency of 13.1 MHz. If a channel A frequency change forces the channel B frequency to less than zero, the channel B frequency is changed to a value equal to the channel A frequency plus the absolute value of the offset. The negative channel B value is displayed, and the channel B output frequency is the absolute value of the displayed value.

Internal Phase Modulation

The frequency range of channel A is 0 to 13 MHz. The frequency range of channel B is 0 to 5 kHz.

Internal Amplitude Modulation

The frequency range of channel A is 0 to 13 MHz. The frequency range of channel B is 0 to 100 kHz.

HV Option

With the high voltage option enabled, the frequency output is 0 to 1 MHz. In the 2 TONE mode, the maximum channel B frequency is 1.1 MHz.

NOTE

After a mode change, the channel B frequency is set to the channel A frequency. If the channel B frequency is set to greater than 1 MHz, the channel B high voltage option is disabled. To enable the high voltage option, reduce the channel B frequency to below 1 MHz.

HP-IB Example:

"FR7.500003MHZ"

MODE	CH A	CH B	NOTES
2 CHANNEL	0 - 13 MHz	0 - 13 MHz	
2 PHASE	0 - 13 MHz	0 - 13 MHz	Channel A frequency = channel B frequency. Set by either channel.
2 TONE	0 - 13 MHz	CH A \pm 100 kHz (13.1 MHz max.)	Channel B tracks Channel A. Changing channel B changes frequency offset.
PULSE	0 - 13 MHz	0 - 13 MHz	Channel A frequency = channel B frequency. Set by either channel.
INTERNAL PHASE MODULATION	0 - 13 MHz	0 - 5 kHz	
INTERNAL AMPLITUDE MODULATION	0 - 13 MHz	0 - 100 kHz	
HV OPTION	0 - 1 MHz	0 - 1 MHz	(Channel B frequency 0-1.1 MHz in 2 Tone)

Figure 1-14. Frequency Limits

Amplitude



The AMPTD (amplitude) key enables display, entry, or modification of the amplitude of the channel selected with the CHAN key. The indicator above the AMPTD key illuminates when an amplitude value is displayed. The displayed amplitude value is changed with the numeric keypad and units keys, or modified with the MODIFY controls. The VOLTS, Vrms, dBm, and dBV units allow convenient entry of amplitude values. The amplitude range without dc offset is from 1 mV peak-to-peak to 10 V peak-to-peak (4 mV peak-to-peak to 40 V peak-to-peak with high voltage enabled). The amplitude range is dependent upon selection of COMBINED operation, internal modulation, dc offset, and high voltage option (see Figure 1-15). The output signal is momentarily set at zero volts if internal attenuator settings change.

HIGH VOLTAGE	COMBINED	DC OFFSET	MAXIMUM AMPLITUDE	NOTES
OFF	OFF	OFF	10 Vpp	
ON	OFF	OFF	40 Vpp	
OFF	ON	OFF	5 Vpp	
ON	ON	OFF	20 Vpp	
OFF	OFF	ON	± 5 Vpk	AC + DC
ON	OFF	ON	± 20 Vpk	AC + DC
OFF	ON	ON	± 2.5 Vpk	DC only
ON	ON	ON	± 10 Vpk	FUNCTION DC only FUNCTION

Figure 1-15. Maximum Amplitudes

Internal Modulation

With internal modulation, the channel B amplitude is controlled by the % AM/PM DEV key. Internal modulation uses the channel B output internally and a signal is unavailable at the CH B connector.

High Voltage Option

With the high voltage option, the upper amplitude limit is increased to 40 volts peak-to-peak and the lower amplitude limit is increased to 4 mV peak-to-peak. The high voltage output needs to be enabled prior to entering voltage values greater than 10 volts.

Combined

For COMBINED operation, the output of channel B is diverted and summed with the channel A output. The amplitude limit of each channel is reduced by 50% (6.02 dB). The upper amplitude limit for COMBINED operation is ± 5 volts (± 20 volts with the high voltage option enabled). Note that the output amplitude level is dependent upon phase, frequency, and amplitude values.

DC Offset

The limit for an ac output with a dc offset is ± 5 volts peak (± 20 volts peak with the high voltage option enabled). Figure 1-16 illustrates dc offset versus amplitude.

HP-IB Example

“AM1.125VO”

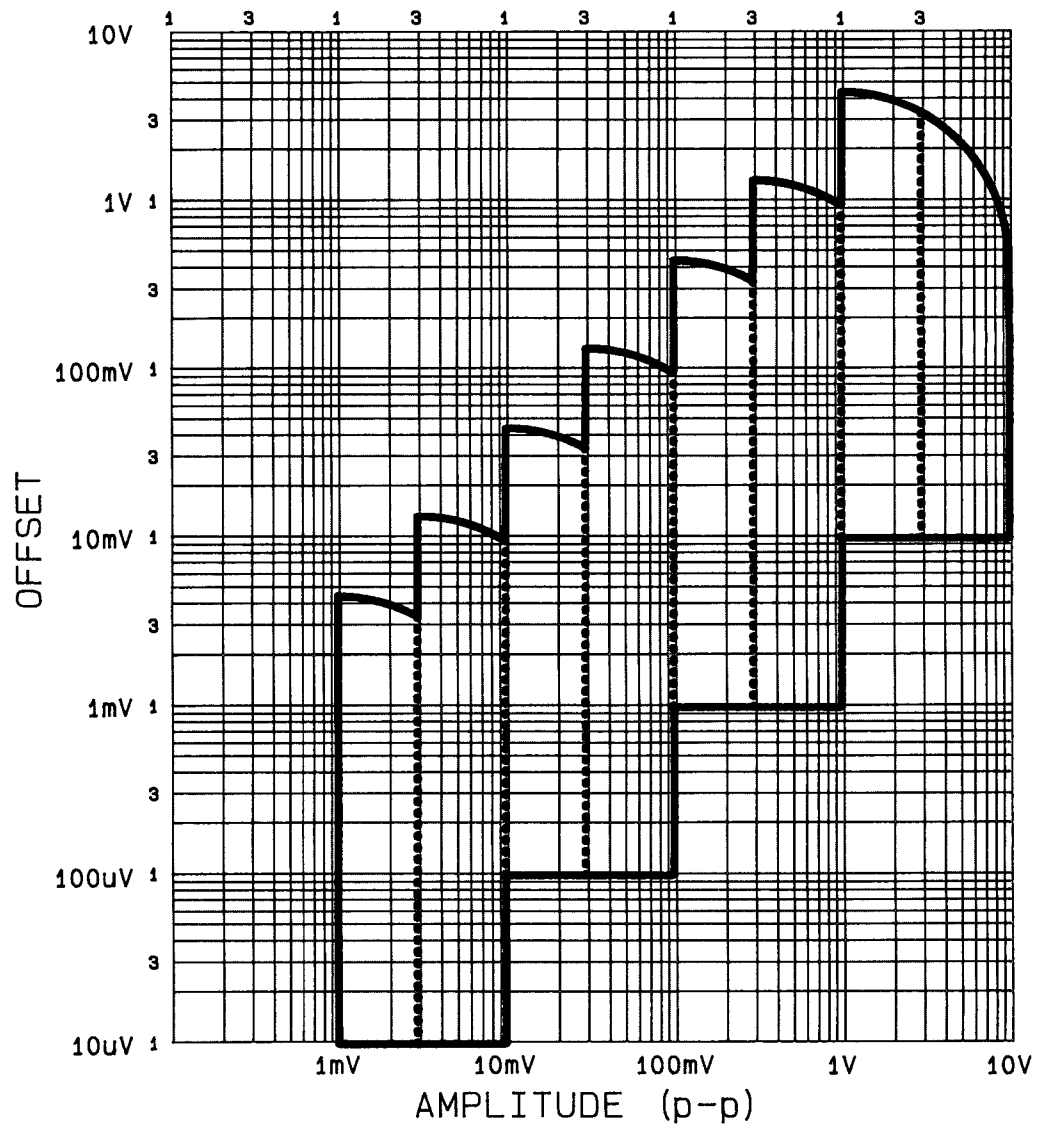

Figure 1-16. Amplitude Range with DC Offset

DC Offset



The DC OFFSET key enables display, entry, or modification of the dc offset of the channel selected with the CHAN key (see Figure 1-17). The indicator above the DC OFFSET key illuminates when a dc offset value is displayed. The displayed dc offset value is changed with the numeric keypad and VOLTS units key, or modified with the MODIFY controls. The maximum dc offset range is ± 5 volts (± 20 volts with the high voltage option enabled). The dc offset range is dependent upon amplitude, and selection of combined operation, internal modulation, and high voltage option. Figure 1-15 lists the maximum output of the HP 3326A. The output signal is momentarily set at zero volts if internal attenuator settings change.

STEP 1

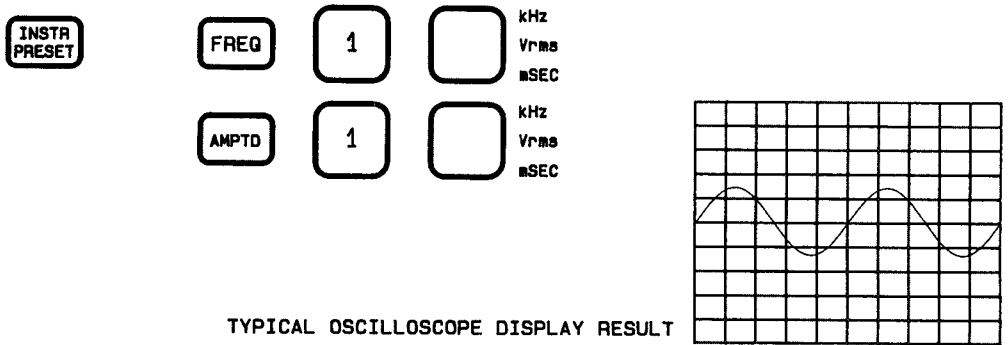

TYPICAL OSCILLOSCOPE DISPLAY RESULT

STEP 2

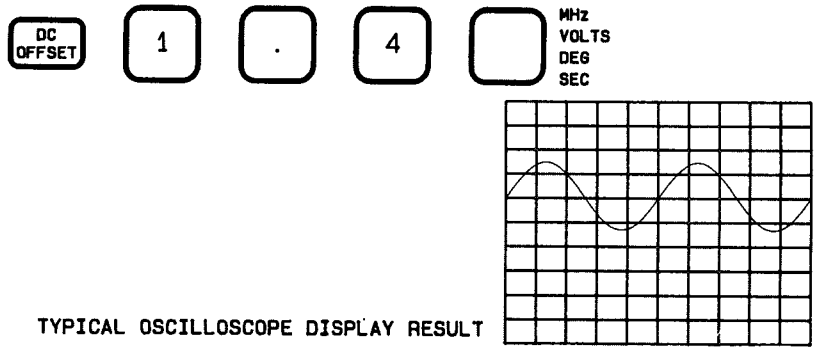

TYPICAL OSCILLOSCOPE DISPLAY RESULT

Figure 1-17. DC Offset

AC with DC Offset

The maximum dc offset is a function of the selected ac amplitude. The maximum amplitude for ac plus dc is ± 5 volts peak (± 20 with the high voltage option). DC offset versus amplitude (with combined operation, internal modulation, and high voltage option disabled) is illustrated in Figure 1-16. The maximum ac and dc outputs and maximum dc offsets for the HP 3326A are:

AC AMPLITUDE	MAXIMUM AC + DC	MAXIMUM DC OFFSET
1.0 to 10 Vpp	± 5.0 V	± 4.5 V
0.1 to 1.0 Vpp	± 0.5 V	± 0.45 V
10 to 100 mVpp	± 50 mV	± 45 mV
1 to 10 mVpp	± 5 mV	± 4.5 mV

DC Only

With the output FUNCTION set to DC, the output level is controlled by DC OFFSET entries. The maximum dc output is ± 5 volts peak (± 20 with the high voltage option).

Combined

For COMBINED operation with a sine wave, square wave, or OFF output FUNCTION selected, the dc offset is set to zero.

High Voltage Option

With the high voltage option enabled, the dc offset range is ± 20 volts (ac + dc peak value or dc only). DC offset with the high voltage option is independent of the ac amplitude except that the combination of ac plus dc cannot exceed ± 20 volts.

Internal Modulation

With internal modulation, the channel B dc offset is disabled.

HP-IB Example

“OF3VO”

Phase



The PHASE key enables display, entry, or modification of the phase of the channel selected with the CHAN key. The indicator above the PHASE key illuminates when a phase value is displayed. The displayed phase value is changed with the numeric keypad and DEG (DEGREES) units key, or modified with the MODIFY controls. The phase display range is ± 720 degrees with a resolution of 0.01 degrees. Phase values of ± 1440 degrees entered through the keypad are accepted and the value is displayed modulo 720. The effect of the phase offset is dependent upon selection of the operating mode. Figure 1-18 illustrates the effect of changing phase.

STEP 1



PRESS UNTIL "2 PHASE" IS ILLUMINATED

STEP 2



CH A



kHz
Vrms
mSEC



kHz
Vrms
mSEC

STEP 3



CH B



MHz
VOLTS
DEG
SEC



kHz
Vrms
mSEC

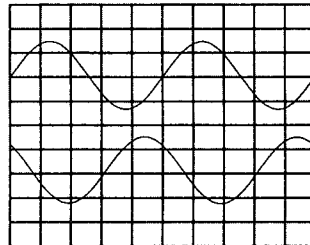

TYPICAL OSCILLOSCOPE DISPLAY RESULT

Figure 1-18. Phase

2 Channel Mode

Changing phase in the 2 CHANNEL mode changes the phase of a channel with respect to the initial waveform. The phase of channel A and B are independent.

2 Phase Mode

Without an external phase reference, a change in the phase of channel A is made with respect to the initial channel A waveform. With an external phase reference, a change in the phase of channel A is made with respect to the external reference. Channel B uses channel A as the phase reference, and a change to the channel B phase is made with respect to the current channel A waveform.

2 Tone Mode

Changing phase in the 2 TONE mode changes the phase of a channel with respect to the initial waveform. The phase of channel A and B are independent.

Pulse Mode

A change in the phase of channel A is made with respect to the initial channel A waveform. The channel B output is the complement of the channel A output. An attempt to display the channel B phase results in the display of the "Error 47 INTR" (INTeRrogate) message.

HP-IB Example

"PH32.05DEG"

Asgn Zero ϕ

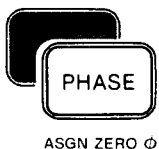

The ASGN ZERO ϕ (ASsiGN ZERO phase) key assigns zero to the phase offset between channel A and B (or between channel A and an external phase reference) without changing the phase of the output waveforms. The ASGN ZERO ϕ key is selected by pressing the blue SHIFT key prior to the PHASE key. If channel A is selected, the channel A phase value is changed to zero. If channel B is selected, the phase offset value is summed modulo 720 and stored in an internal phase offset register. Subsequent assignments of zero phase sums the displayed phase value into the phase offset register. The stored phase offset value is recalled with the CLR ϕ OFS key. The ϕ OFS (phase offset) indicator illuminates when a phase offset value is stored.

HP-IB Example

"ZPH"

Clr ϕ Offset



The CLR ϕ OFS (CLear phase OffSet) key restores the channel B phase offset value to the display without changing the phase of the output waveforms. If the current channel B phase value is nonzero, the phase offset is summed to the phase value modulo 720. The CLR ϕ OFS key is selected by pressing the blue SHIFT key prior to the DC OFFSET key. The CLR ϕ OFS key extinguishes the ϕ OFS indicator. Pressing the CLR ϕ OFS key with channel A selected displays the message "Error 120 P OF" (Phase Offset).

HP-IB Example

"COF"

Duty Cycle (Pulse Width)

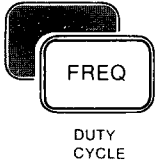

The DUTY CYCLE key enables display, entry, or modification of the duty cycle of the pulse mode channel A waveform. The DUTY CYCLE key is selected by pressing the blue SHIFT key prior to the FREQ key. The DUTY CYCLE indicator illuminates when the duty cycle value is displayed. After selection of the DUTY CYCLE key, the duty cycle value is changed with the numeric keypad and % units key, or modified with the MODIFY controls. The duty cycle range is from 1% to 99% of the period with a minimum pulse width of 20 nanoseconds. The resolution of the duty cycle is 0.01%. The duty cycle remains constant for changes in frequency provided the pulse width is greater than 20 nanoseconds. Figure 1-19 illustrates the effect on changes in duty cycle.

HP-IB Example

“25.05PC”

STEP 1 **INSTR PRESET** **MODE** PRESS UNTIL "PULSE" IS ILLUMINATED

STEP 2 **CHAN** CH A **FREQ** 1 **KHz**
AMPTD 2 **Vrms**
SHIFT **DUTY CYCLE** 2 5 **mSEC**
MHz
VOLTS
DEG
SEC
dBV
%

STEP 3 **CHAN** CH B **AMPTD** 2 **MHz**
VOLTS
DEG
SEC

TYPICAL OSCILLOSCOPE DISPLAY RESULT

Figure 1-19. Pulse Mode Output and Duty Cycle

LINEAR FREQUENCY SWEEP

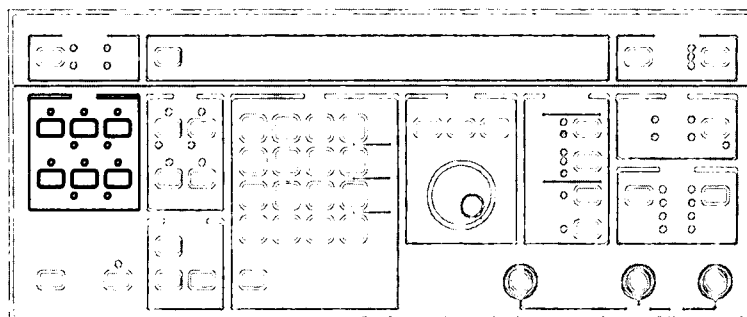

Linear sweeps are phase continuous over the full frequency range; that is, there are no phase discontinuities in the swept output waveform. Single or continuous (see Figure 1-20), and ramp or triangle (see Figure 1-21) linear sweeps are selectable. Linear sweep parameters are entered with the START FREQ (START FREQUENCY), STOP FREQ (STOP FREQUENCY), CNTR FREQ (CeNTeR FREQUENCY), SPAN, TIME, AND MKR→CF keys. The MKR FREQ (MarKeR FREQUENCY) key allows the rear panel TTL level MARKER OUT (MARKER OUTput) signal to be specified.

Single Sweep



The SINGLE key initiates a single linear sweep. The indicator above the SINGLE key illuminates when a single sweep is in progress. With a ramp sweep selected (i.e. TRIANGLE indicator extinguished), the SINGLE key initiates a sweep from the start frequency to the stop frequency over the specified sweep time. Upon reaching the stop frequency, the frequency is quickly changed to the start frequency. With a TRIANGLE sweep selected, the SINGLE key initiates a sweep from the start frequency to the stop frequency over the specified sweep time. The stop frequency is maintained until the SINGLE key is pressed. Pressing the SINGLE key initiates another sweep from the stop frequency to the start frequency.

HP-IB Example:

“SS”

Continuous Sweep



The CONT (CONTinuous) key initiates a continuous linear sweep. The indicator above the CONT key illuminates when a continuous sweep is in progress. With a ramp sweep selected (i.e. TRIANGLE indicator extinguished), the CONT key initiates a repetitive sweep from the start frequency to the stop frequency over the specified sweep time. Upon reaching the stop frequency, the frequency is quickly changed to the start frequency in preparation for the next sweep. With a TRIANGLE sweep selected, the CONT key initiates a repetitive sweep from the start frequency to the stop frequency and back to the start frequency. Each sweep (from either the start frequency to stop frequency, or from stop frequency to start frequency) is over the specified sweep time.

HP-IB Example:

“SC”

**INSTR
PRESET**

NOTE THAT "2 CHANNEL" IS ILLUMINATED
IN THE MODE SECTION OF THE FRONT PANEL

CHAN CH A

AMPTD	1		KHz V _{rms} mSEC
START FREQ	1	0	Hz dBm
STOP FREQ	5	0	0 Hz dBm
TIME	4	0	KHz V _{rms} mSEC

CHAN CH B

AMPTD	1		KHz V _{rms} mSEC
START FREQ	5	0	0 Hz dBm
STOP FREQ	1	0	Hz dBm
SINGLE			

TYPICAL OSCILLOSCOPE DISPLAY RESULT

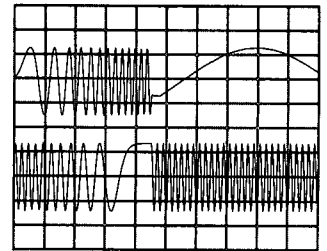

CONT

TYPICAL OSCILLOSCOPE DISPLAY RESULT

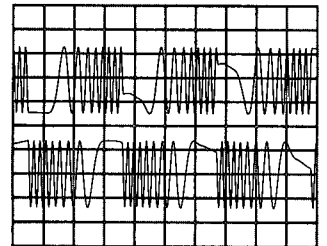

Figure 1-20. Single/Continuous Linear Sweep

Start Frequency



The START FREQ (START FREQuency) key enables display, entry, or modification of the linear sweep start frequency of the channel selected with the CHAN key. The indicator above the START FREQ key illuminates when a start frequency value is displayed. The displayed frequency value is changed with the numeric keypad and units keys, or modified with the MODIFY controls. The MHz, kHz, and Hz units allow convenient entry of frequency values. Frequency resolution is 1 μ Hz for frequencies below 100 kHz and 1 mHz for frequencies above 100 kHz. Start frequency values may be greater than the stop frequency values for a sweep from a high frequency to a low frequency.

2 Channel Mode

Each channel start frequency is set independently. The frequency range of each channel is 0 to 13 MHz.

2 Phase or Pulse Mode

The start frequency of both channels is set to the same value by a change in start frequency of either channel. The frequency range is 0 to 13 MHz.

2 Tone Mode

The channel B start frequency tracks changes to the channel A start frequency. The channel A start frequency range is 0 to 13 MHz. The channel B start frequency can have up to a 100 kHz offset from channel A with a maximum frequency of 13.1 MHz. If a channel A frequency change forces the channel B frequency to less than zero, the channel B frequency is displayed as a negative value while the channel B output frequency is the absolute value of the displayed value.

Internal Phase Modulation

The start frequency range of channel A is 0 to 13 MHz. The start frequency range of channel B is 0 to 5 kHz.

Internal Amplitude Modulation

The start frequency range of channel A is 0 to 13 MHz. The start frequency range of channel B is 0 to 100 kHz.

HV Option

With the high voltage option enabled, the start frequency range is 0 to 1 MHz. In the 2 TONE mode, the maximum channel B start frequency is 1.1 MHz.

HP-IB Example:

“ST1.512525KHZ”

Stop Frequency



The STOP FREQ (STOP FREQuency) key enables display, entry, or modification of the linear sweep stop frequency of the channel selected with the CHAN key. The indicator above the STOP FREQ key illuminates when a stop frequency value is displayed. The displayed frequency value is changed with the numeric keypad and units keys, or modified with the MODIFY controls. The MHz, kHz, and Hz units allow convenient entry of frequency values. Frequency resolution is 1 μ Hz for frequencies below 100 kHz and 1 MHz for frequencies above 100 kHz.

2 Channel Mode

Each channel stop frequency is set independently. The frequency range of each channel is 0 to 13 MHz.

2 Phase or Pulse Mode

The stop frequency of both channels is set to the same value by a change in stop frequency of either channel. The frequency range is 0 to 13 MHz.

2 Tone Mode

The channel B stop frequency tracks changes to the channel A stop frequency. The stop frequency range of channel A is 0 to 13 MHz. The channel B stop frequency can have up to a 100 kHz offset from channel A, with a maximum frequency of 13.1 MHz. If a channel A frequency change forces the channel B frequency to less than zero, the channel B frequency is changed to a value equal to the channel A frequency plus the absolute value of the offset.

Internal Phase Modulation

The stop frequency range of channel A is 0 to 13 MHz. The stop frequency range of channel B is 0 to 5 kHz.

Internal Amplitude Modulation

The stop frequency range of channel A is 0 to 13 MHz. The stop frequency range of channel B is 0 to 100 kHz.

HV Option

With the high voltage option enabled, the stop frequency range is 0 to 1 MHz. In the 2 TONE mode, the maximum channel B frequency is 1.1 MHz.

HP-IB Example:

“SP7.512525KHZ”

Time



The TIME key enables display, entry, or modification of the linear sweep time for both channels. The indicator above the TIME key illuminates when a time value is displayed. The displayed time value is changed with the numeric keypad and units keys, or modified with the MODIFY controls. The SEC and mSEC units keys end entry of numeric values. The time range is 5 milliseconds to 1000 seconds, with a resolution of 1 millisecond.

HP-IB Example:

“STIM25MS”

Marker Frequency



The MKR FREQ (MarKeR FREQUENCY) key enables display, entry, or modification of the marker frequency of the channel selected with the CHAN key. The indicator above the MKR FREQ key illuminates when the marker frequency value is displayed. The displayed frequency value is changed with the numeric keypad and units keys, or modified with the MODIFY controls. The MHz, kHz, and Hz units allow convenient entry of frequency values. Frequency resolution is 1 μ Hz for frequencies below 100 kHz and 1 mHz for frequencies above 100 kHz. Only one marker is available.

NOTE

When different start or stop frequencies are entered for each channel, selecting alternate channels can have the apparent effect of changing the marker frequency. Although the marker occurs at the same time, each channel may have a unique frequency at that time.

For a marker signal to be generated, the MKR FREQ must be within 3 milliseconds of the start or stop frequency. The following equation may be used to determine the approximate marker offset from the start or stop frequency:

$$\text{MARKER OFFSET} \geq \frac{0.003 \times \text{SPAN}}{\text{SWEEP TIME}}$$

The marker value is accepted and the message “Error 24 RNGE” is displayed if the marker value is outside the sweep frequency span. The Z-BLANK output is coincident with the start and stop frequencies and may be used for the marker of these frequencies.

HP-IB Example:

“MF5.512525KHZ”

Triangle

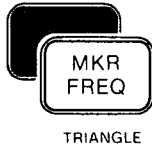

The TRIANGLE key selects either a triangle or ramp sweep. The TRIANGLE key is selected by pressing the blue SHIFT key prior to the MKR FREQ key. The TRIANGLE indicator is illuminated when a triangle sweep is selected, and extinguished when a ramp sweep is selected.

HP-IB Examples:

“SM1” “SM2”
or or
“SM RAMP” “SM TRGL”

STEP 1



NOTE THAT "2 CHANNEL" IS ILLUMINATED IN THE MODE SECTION OF THE FRONT PANEL

STEP 2



CH A



1

kHz
V_{rms}
mSEC



1

0

Hz
dBm



5

0

0

Hz
dBm



3

0

kHz
V_{rms}
mSEC

STEP 3



CH B

OFF (PRESS UNTIL ALL CHANNEL B FUNCTION INDICATORS ARE EXTINGUISHED)

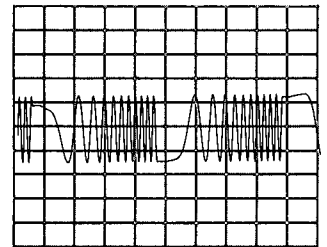

TYPICAL OSCILLOSCOPE DISPLAY RESULT (RAMP SWEEP)

STEP 4

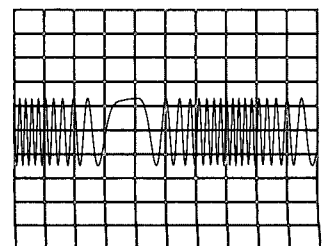

TYPICAL OSCILLOSCOPE DISPLAY RESULT (TRIANGLE SWEEP)

Figure 1-21. Triangle and Ramp Linear Sweep

Reset Sweep

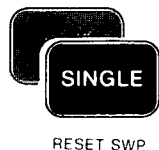

The RESET SWP (RESET SWEEP) key resets the sweep circuits to the start of the sweep. During reset, the HP 3326A also checks the sweep limits.

HP-IB Example:

“SRE”

Span



The SPAN key enables display, entry, or modification of the total linear sweep frequency span of the channel selected with the CHAN key. The SPAN key is available by pressing the blue SHIFT key prior to pressing the STOP FREQ (STOP FREQUENCY) key. The SPAN key, with the CNTR FREQ (CeNTeR FREQUENCY) key, provides an alternate entry for the frequency sweep start and stop values. The SPAN indicator illuminates when SPAN is selected and the SPAN value is displayed. The displayed frequency span value is changed with the numeric keypad and units keys, or modified with the MODIFY controls. The MHz, kHz, and Hz units allow convenient entry of frequency values. Frequency resolution is 1 μ Hz for frequencies below 100 kHz and 1 mHz for frequencies above 100 kHz.

NOTE

Frequency spans must be consistent with the operating limits and the value entered for the center frequency. Excessive frequency spans are symmetrically reduced around the current center frequency to bring the start or stop frequencies within limits.

2 Channel Mode

The frequency span of each channel is set independently. The frequency range of each channel is 0 to 13 MHz.

2 Phase or Pulse Mode

The frequency span of both channels is set to the same value by a change in the frequency span of either channel. The frequency range is 0 to 13 MHz.

2 Tone Mode

The frequency span range for channel A is 0 to 13 MHz. Changing the channel A frequency span also changes the channel B center frequency and span to maintain the current start and stop frequency offsets. The channel B frequency span may be set so that the start and stop frequencies are within 100 kHz of the channel A start and stop frequencies. If a channel A frequency change forces the channel B frequency to less than zero, the channel B output frequency is changed to the absolute value of the channel B frequency.

NOTE

The difference (offset) between the channel A and B frequencies will normally change during a sweep to maintain the offsets entered for the sweep start and stop frequencies. If a constant offset is desired, there must be a constant offset between the start and stop frequency values for channel A and B.

HV Option

With the high voltage option enabled, the maximum frequency span is 1 MHz. In the 2 TONE mode, the maximum channel B frequency span is 1.1 MHz.

HP-IB Example:

“SPAN5.512525KHZ”

Center Frequency



The CNTR FREQ (CeNTER FREQUENCY) key enables display, entry, or modification of the linear sweep center frequency of the channel selected with the CHAN key. The CNTR FREQ key is available by pressing the blue SHIFT key prior to the START FREQ key. The CNTR FREQ key, along with the SPAN key, provides an alternate entry of the frequency sweep start and stop values.

The displayed frequency value is changed with the numeric keypad and units keys, or modified with the MODIFY controls. The MHz, kHz, and Hz units allow convenient entry of frequency values. The frequency resolution is 1 μ Hz for frequencies below 100 kHz and 1 mHz for frequencies above 100 kHz. If the center frequency causes the sweep start or stop frequency to exceed the HP 3326A limits, the frequency span is reduced.

2 Channel Mode

The center frequency of each channel is set independently. The frequency range of each channel is 0 to 13 MHz.

2 Phase or Pulse Mode

The center frequency of both channels is set to the same value by a change in center frequency of either channel. The frequency range is 0 to 13 MHz.

2 Tone Mode

The channel A center frequency has the range of 0 to 13 MHz. The start and stop frequencies of channel B tracks changes to the channel A start and stop frequencies to maintain the current offset. The channel B center frequency can have up to a 100 kHz offset from channel A providing the channel B start and stop frequencies are within 100 kHz of the channel A start and stop frequencies.

HP-IB Example:

“CF5.512525KHZ”

Marker to Center Frequency



MKR → CF

The MKR → CF (MarKeR to Center Frequency) key centers the sweep band on the frequency set for the marker. The MKR → CF key is selected by pressing the blue SHIFT key prior to the CONT key. If either the sweep start or stop frequency exceeds the frequency limits, the frequency band is reduced.

2 Channel Mode

The center frequency of each channel is set independently. The frequency range of each channel is 0 to 13 MHz.

2 Phase or Pulse Mode

The center frequency of both channels is set to the same value by a change in the center frequency of either channel. The frequency range is 0 to 13 MHz.

2 Tone Mode

The channel A center frequency has the range of 0 to 13 MHz. The start and stop frequencies of channel B tracks changes to the channel A start and stop frequencies to maintain the current offset. The channel B center frequency can have up to a 100 kHz offset from channel A providing the channel B start and stop frequencies are within 100 kHz of the channel A start and stop frequencies.

HP-IB Example:

“CFM”

DISCRETE FREQUENCY SWEEP

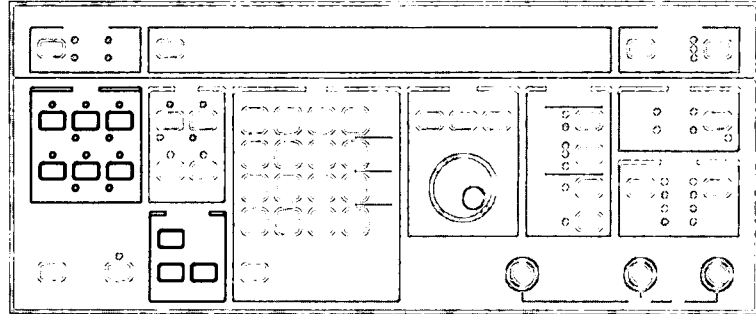

During a discrete frequency sweep, the HP 3326A sequences through the discrete frequency sweep elements (channel A and B frequencies, and dwell time) stored in non-volatile memory with the SAVE DISCRETE key (see Figure 1-22). Discrete frequency sweep element frequencies are entered with the **FREQ** (FREQUENCY) key, and dwell times are entered with the **TIME** key. The HP 3326A always sequences through the discrete frequency sweep elements from element 00 to the last element entered. With **SINGLE** sweep selected, the HP 3326A sequences through the elements each time the **SINGLE** key is pressed. With **CONT** sweep selected, the HP 3326A sequences through the elements continuously. The message "Error 110 DSWP" (Discrete frequency SWEEP) is displayed if no discrete frequency sweep elements are stored in memory. Selecting **TRIANGLE** for a discrete frequency sweep cancels the discrete frequency sweep and selects a linear sweep.

Discrete

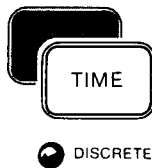

The **DISCRETE** key enables and disables discrete frequency sweeps. The **DISCRETE** key is available by pressing the blue **SHIFT** key prior to pressing the **TIME** key. The **DISCRETE** indicator illuminates when discrete frequency sweeps are enabled.

HP-IB Examples:

"SM3"
or
"SM DSCR"

Recall Discrete

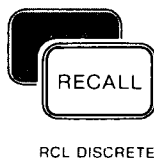

The **RCL DISCRETE** (ReCaLI DISCRETE) key followed by a discrete element number replaces the channel A and B frequency values and time values with the values stored for a discrete frequency sweep element. The **RCL DISCRETE** key is available by pressing the blue **SHIFT** key prior to pressing the **RECALL** key. Valid discrete elements numbers range from 00 to 62. Recalling a null discrete frequency sweep element number displays the message "Error 20 RNGE."

HP-IB Example:

"DRCL02"

Save Discrete



The SAVE DISCRETE key followed by a discrete frequency sweep element number stores the current channel A and B frequency values and dwell time value in nonvolatile memory. The SAVE DISCRETE key is available by pressing the blue SHIFT key prior to pressing the SAVE key. Valid discrete frequency sweep element numbers range from 00 to 62. When initially entering discrete frequency sweep elements, the element numbers must start with 00 and be sequential. Existing discrete frequency elements may be recalled, edited, and replaced in any order. Storing a discrete frequency sweep element with a nonsequential number, or using a number greater than 62 displays the message "Error 23 RNGE" (RaNGE). The message "Error 117 DSWP" (Discrete frequency SWEEP) is displayed if a discrete frequency element is entered after the mode is changed.

Discrete frequency sweep element storage uses the same nonvolatile memory as the SAVE key stores. Discrete sweep frequency storage memory is assigned by the HP 3326A. Discrete frequency sweep elements are stored in the following memory registers:

DISCRETE FREQUENCY ELEMENT NUMBER	MEMORY REGISTER
00 - 06	9
07 - 13	8
14 - 20	7
21 - 27	6
28 - 34	5
35 - 41	4
42 - 48	3
49 - 55	2
56 - 62	1

Saving an operating state in a memory register that interrupts the contiguous memory used to save discrete frequency sweep elements displays the "Error 23 RNGE" (RaNGE) message. Saving an operating state in the lowest memory register occupied by discrete frequency sweep elements reclaims that memory register for operating state storage.

HP-IB Example:

"DSAV02"

Single Sweep



The SINGLE key initiates a single discrete frequency sweep. The indicator above the SINGLE key illuminates when a single sweep is in progress. The SINGLE key initiates a sweep from the discrete frequency sweep element 00 to the last entered element. During a sweep, the SINGLE key causes the HP 3326A to step from the current discrete frequency sweep element to the next discrete frequency sweep element.

HP-IB Example:

“SS”

Continuous Sweep



The CONT (continuous) key initiates a continuous discrete frequency sweep. The indicator above the CONT key illuminates when a continuous sweep is in progress.

HP-IB Example:

“SC”

Clear Discrete



The CLR DISCRETE (CLear DISCRETE) key replaces the discrete frequency sweep elements stored in nonvolatile memory with the preset operating state. The CLR DISCRETE key is available by pressing the blue SHIFT key prior to the green INSTR PRESET key.

HP-IB Example:

“DRST”

Time



The TIME key enables display, entry, or modification of the discrete frequency sweep element dwell time for both channels. After selection of the TIME key, the time value is changed with the numeric keypad and units keys, or modified with the MODIFY controls. The SEC and mSEC units keys end entry of numeric values. The time range is from 5 milliseconds to 1000 seconds with a resolution of 1 millisecond.

HP-IB Example:

“STIM25MS”

Reset Sweep

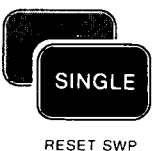

The RESET SWP (reset sweep) key resets the sweep circuits to the start of the sweep. For triggered operation, manually resetting the sweep circuits before the trigger minimizes the delay between the trigger and start of sweep.

HP-IB Example:

“SRE”

STEP 1

INSTR
PRESET

NOTE THAT "2 CHANNEL" IS ILLUMINATED
IN THE MODE SECTION OF THE FRONT PANEL

STEP 2

CHAN

CH A

FREQ

2

5

0

Hz
dBm

AMPTD

1

kHz
Vrms
mSEC

TIME

1

0

kHz
Vrms
mSEC

STEP 3

CHAN

CH B

FREQ

1

0

0

0

Hz
dBm

AMPTD

1

kHz
Vrms
mSEC

SHIFT

STORE

0

0

STEP 4

CHAN

CH A

FREQ

1

kHz
Vrms
mSEC

TIME

1

5

kHz
Vrms
mSEC

Figure 1-22. Discrete Frequency Sweep



STEP 5 CH B

STEP 6 CH A

STEP 7 CH B

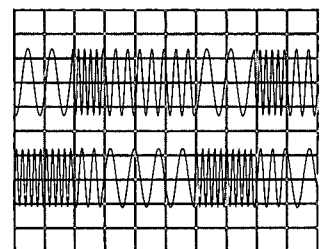

TYPICAL OSCILLOSCOPE DISPLAY RESULT

Figure 1-22. Discrete Frequency Sweep (Cont.)

MODULATION

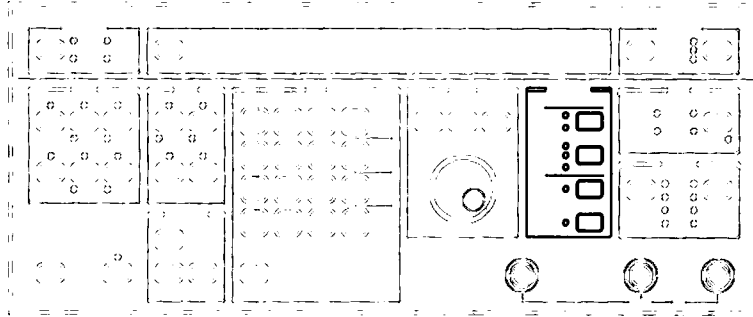

The keys in the MODULATION key block enable and disable modulation. Each time a modulation key is pressed, the modulation indicators sequence through the available selections. Available modulation selections are dependent on the mode. Figure 1-24 lists the types of modulation available for the operating modes. If a modulation type is unavailable, check the mode of operation, channel B frequency, and COMBINED operation. Modulation is disabled by pressing each of the MODULATION selection keys and extinguishing all of the MODULATION indicators, by changing the mode, or by presetting the HP 3326A. Figure 1-23 illustrates modulation definition. Figures 1-25 and 1-26 illustrates the effect of internal AM and PM modulation.

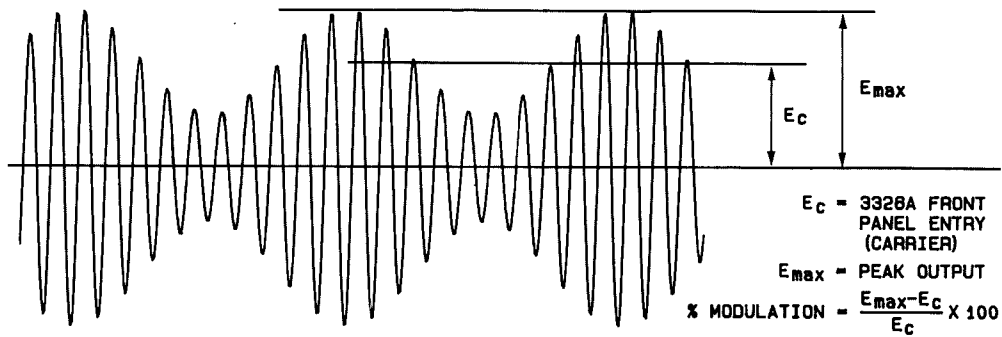
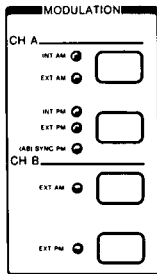

Figure 1-23. Modulation Definition

		2 CHANNEL	2 PHASE	2 TONE	PULSE
CHANNEL A	AM	INT OR EXT	EXT	EXT	EXT
	PM	INT OR EXT	SYNC	SYNC	SYNC
CHANNEL B	AM	EXT	EXT	EXT	EXT
	PM	EXT	SYNC AND EXT	SYNC AND EXT	SYNC AND EXT

Figure 1-24. Available Modulation for HP 3326A Modes

Internal AM/%AM



Internal amplitude modulation is enabled in the 2 CHANNEL mode when the channel A INT AM (Internal Amplitude Modulation) indicator is illuminated. Internal amplitude modulation uses the channel B synthesizer as the modulation source for channel A, thus only the channel A output is active. For internal amplitude modulation, 100 kHz is the maximum channel B frequency. Internal amplitude modulation limits the values entered for the channel A amplitude to 50% (6.02 dB) of the normal range.

When internal modulation is selected, the channel B high voltage option is disabled. If internal modulation cannot be selected (i.e. the INT AM indicator does not illuminate), check that the 2 CHANNEL mode is selected, COMBINED operation is disabled, and the channel B frequency is below 100 kHz.

HP-IB Example:

“AIA1”
or
“AIA ON”

Percent AM

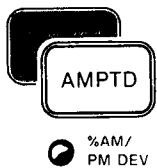

The %AM/PM DEV (percent Amplitude Modulation/Phase Modulation DEVIation) key enables display, entry, or modification of the modulation percentage. The %AM/PM DEV key is selected by pressing the blue SHIFT key prior to the AMPTD key. The %AM/PM DEV indicator illuminates when the modulation value is displayed. After selection of the %AM/PM DEV key, the modulation value is entered or modified with the numeric keypad and % units key, or modified with the MODIFY controls. The modulation value ranges from 0 to 100% with 0.1% resolution. With 0% amplitude modulation, the channel A output level is equal to the amplitude entered for the AMPTD key. The modulation value is used for both AM and PM. If the displayed modulation value is in degrees, pressing the % units key converts the displayed value to percent. Similarly, if the displayed value is in degrees, pressing the DEG units key converts the displayed value to degrees.

HP-IB Example:

“ML30.5PC”

STEP 1

<input type="button" value="CHAN"/>	CH A	<input type="button" value="FREQ"/>	<input type="text" value="1"/>	<input type="text" value="0"/>	<input type="text" value=""/>	kHz Vrms mSEC
		<input type="button" value="AMPTD"/>	<input type="text" value="5"/>	<input type="text" value=""/>		MHz VOLTS DEG SEC
<input type="button" value="SHIFT"/>		<input type="button" value="AMPTD"/>	<input type="text" value="5"/>	<input type="text" value="0"/>	<input type="text" value=""/>	dBV %

STEP 2

INT AM
 INT PM

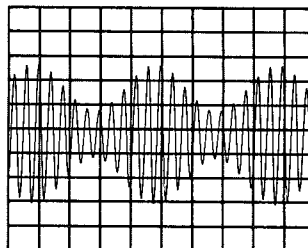

TYPICAL OSCILLOSCOPE DISPLAY RESULT

Figure 1-25. Internal AM Modulation

Internal PM/PM DEV

INT PM

Internal phase modulation is enabled in the 2 CHANNEL mode when the channel A INT PM (internal Phase Modulation) indicator is illuminated (see Figure 1-26). Internal phase modulation uses the channel B synthesizer as the modulation source for channel A. Thus, only the channel A output is active. For internal phase modulation, 5 kHz is the maximum channel B frequency.

When internal modulation is selected, the channel B high voltage option is disabled. If internal modulation cannot be selected (i.e. the INT PM indicator does not illuminate), check that the 2 CHANNEL mode is selected, COMBINED operation is disabled, and the channel B frequency is below 5 kHz.

HP-IB Example:

"AIP1"
 or
 "AIP ON"

PM Deviation

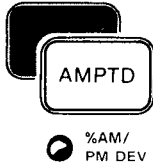

The %AM/PM DEV (percent Amplitude Modulation/Phase Modulation DEVIation) key enables display, entry, or modification of the phase modulation deviation. The %AM/PM DEV key is selected by pressing the blue SHIFT key prior to the AMPTD key. The %AM/PM DEV indicator illuminates when the phase modulation deviation value is displayed. After selection of the %AM/PM DEV key, the phase modulation deviation is entered or modified with the numeric keypad and DEG units key, or modified with the MODIFY controls. The phase modulation deviation ranges from 0 to 360° with 0.01° resolution. The modulation value is used for both AM and PM. If the displayed modulation value is in degrees, pressing the % units key converts the displayed value to percent. Similarly, if the displayed value is in degrees, pressing the DEG units key converts the displayed value to degrees.

HP-IB Example:

“ML45DEG”

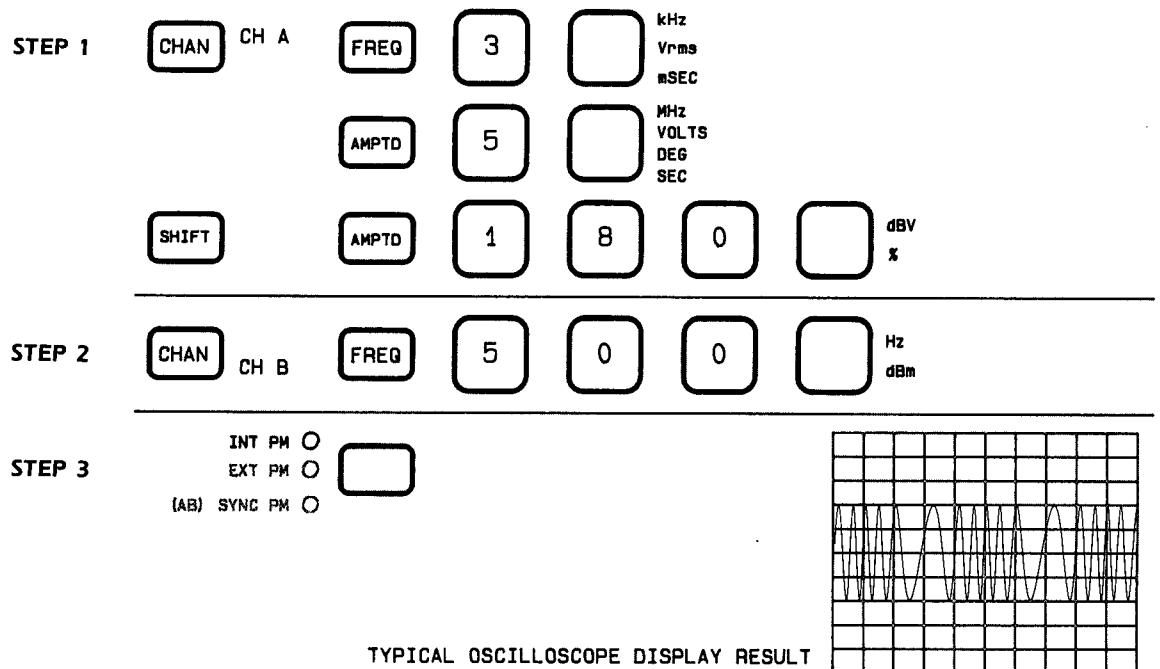
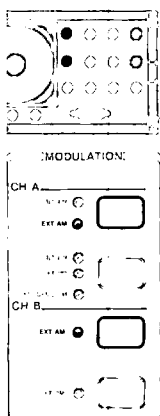

Figure 1-26. Internal PM Modulation

External AM



Either channel is amplitude modulated by an external source through the rear panel A-AMPTD MOD IN (channel A AMPLiTude MODulation INput) or B-AMPTD MOD IN (channel B AMPLiTude MODulation INput) connector when the respective channel EXT AM (EXTernal Amplitude Modulation) indicator is illuminated. The voltage range for the A-AMPTD MOD IN or B-AMPTD MOD IN connector is ± 1.0 volt. A 2 volt peak-to-peak input results in 100% modulation. A 0 volt input results in an output equal to the amplitude entered for the AMPTD key. For channel A, a -1 volt input results in a minimum level. For channel B, a $+1$ volt input results in a minimum level. The maximum amplitude modulation frequency into the HP 3326A is 100 kHz. Amplitude modulation limits the values entered for the channel A amplitude to 50% (6.02 dB) of the normal range.

HP-IB Example:

“AEA1”
 or
 “AEA ON”
 “BEA1”
 or
 “BEA ON”

External PM and Sync PM

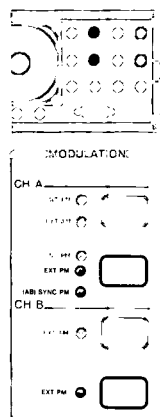

External phase modulation is enabled when the EXT PM (EXTernal Phase Modulation) or (AB) SYNC PM (channel A and B SYNChronous Phase Modulation) indicator is illuminated. Channel A is phase modulated by an external source through the rear panel A-PHASE MOD IN/SYNC PM IN (channel A PHASE MODulation INput/SYNChronous Phase Modulation INput) connector when the channel A EXT PM or (AB) SYNC PM indicator is illuminated. For synchronous phase modulation, channel B phase is held constant relative to the channel A phase. Channel B is phase modulated by an external source through the rear panel B-PHASE MOD IN (channel B PHASE MODulation INput) connector when the channel B EXT PM indicator is illuminated. The voltage range for the A-PHASE MOD IN/SYNC PM IN or B-PHASE MOD IN connector is ± 1.0 volt which corresponds to $\pm 360^\circ$ phase modulation. A 0 volt input results in an output with 0° modulation. The maximum frequency into the HP 3326A for phase modulation is 5 kHz. Phase modulation selection is dependent on the mode selected (see Figure 1-23).

2 Channel Mode

Channel A is phase modulated by an external source through the rear panel A-PHASE MOD IN/SYNC PM IN connector when the channel A EXT PM indicator is illuminated. Channel B is phase modulated by an external source through the rear panel B-PHASE MOD IN connector when the channel B EXT PM indicator is illuminated.

2 Phase, 2 Tone, or Pulse Mode

Both channels are synchronously phase modulated by an external source through the rear panel A-PHASE MOD IN/SYNC PM IN connector when the (A) SYNC PM indicator is illuminated. Channel B is also phase modulated by an external source through the rear panel B-PHASE MOD IN connector when the channel B EXT PM indicator is illuminated.

HP-IB Example:

```
“AEP1”  
or  
“AEP ON”  
“BEP1”  
or  
“BEP ON”  
“SPE1”  
or  
“SPE ON”
```

Disabling Modulation

Modulation is disabled by pressing the MODULATION selection keys corresponding to an illuminated indicator until all the indicators are extinguished. Modulation is also disabled by changing the mode with the MODE key or presetting the HP 3326A.

HP-IB Example:

```
“NOM”
```

SAVING/RECALLING AN INSTRUMENT STATE, AND MEMORY OPERATIONS

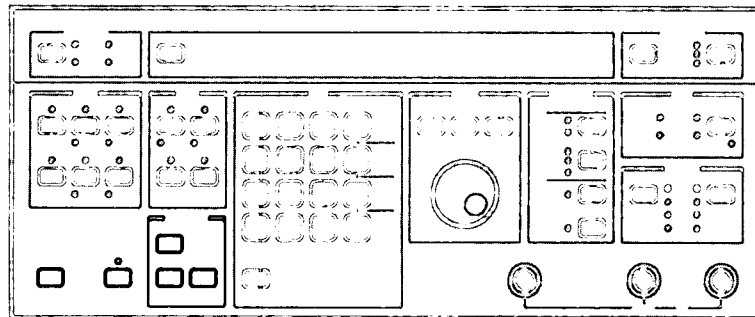

Save



The SAVE key, followed by a digit from 0 to 9, saves the current operating state in non-volatile memory. The digit following the SAVE key specifies the memory register for storing the operating state. If two operating states are saved in the same memory register, the operating state saved first is erased. Although 0 is a valid entry for a memory register, the contents of this memory register are replaced with the current operating state when power is removed from the HP 3326A.

Saving an operating state in a memory register that interrupts contiguous memory used by discrete frequency sweep elements displays the "Error 23 RNGE" (RaNGE) message. Saving an operating state in the lowest memory register occupied by discrete frequency sweep elements reclaims that memory register for operating state storage.

HP-IB Example:

"SAV2"

Recall



The RECALL key, followed by a digit from 0 to 9, recalls an operating state saved in nonvolatile memory. The digits 0 to 9 select the memory register for the recall operation. Recalling a memory register with discrete frequency sweep elements generates the "Error 20 RNGE" (RaNGE) error message.

HP-IB Example:

"RCL3"

Power Down State



Memory register 0 contains the last operating state prior to removing power. The last operating state established prior to removing power is restored by pressing the RECALL key followed by the digit 0.

Through the use of the internal SAVE switch, the setup state stored in register 0 can be selected as the turn on state. Setting of internal switches must be done by qualified service personnel. The location and settings of the SAVE switch are described in the HP 3326A Service Manual.

Memory Clear

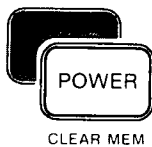

Applying power to the HP 3326A with the blue SHIFT key pressed replaces the contents of all nonvolatile memory registers with the INSTR PRESET state. All saved operating states and discrete frequency sweep elements are replaced with the INSTR PRESET state.

Recall Discrete

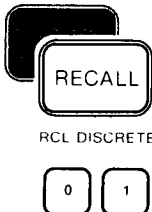

The RCL DISCRETE (ReCaLI DISCRETE) key followed by a discrete frequency sweep element number replaces the channel A and B frequency values and time value with the values stored for the discrete frequency sweep element. The RCL DISCRETE key is available by pressing the blue SHIFT key prior to pressing the RECALL key. Valid discrete frequency sweep elements numbers range from 00 to 62. Recalling a null discrete frequency sweep element displays the message "Error 20 RNGE" (RaNGE).

HP-IB Example:

"DRCL02"

Save Discrete



The SAVE DISCRETE key followed by a discrete frequency sweep element number stores the current channel A and B frequency values and dwell time value in nonvolatile memory. The SAVE DISCRETE key is available by pressing the blue SHIFT key prior to pressing the SAVE key. Valid discrete frequency sweep element numbers range from 00 to 62. When initially entering discrete frequency sweep elements, the element numbers must start with 00 and be sequential. Existing discrete frequency elements may be recalled, edited, and replaced in any order. Storing a discrete frequency sweep element with a nonsequential number, or using a number greater than 62 displays the message "Error 23 RNGE" (RaNGE). The message "Error 117 DSWP" (Discrete frequency SWEEP) is displayed if a discrete frequency element is entered after the mode is changed.

Discrete frequency sweep element storage uses the same nonvolatile memory as a SAVE operation starting with memory register 9. Discrete frequency sweep elements are stored in the following memory registers:

DISCRETE FREQUENCY ELEMENT NUMBER	MEMORY REGISTER
00 - 06	9
07 - 13	8
14 - 20	7
21 - 27	6
28 - 34	5
35 - 41	4
42 - 48	3
49 - 55	2
56 - 62	1

Saving an operating state in a memory register that interrupts the contiguous memory used to save discrete frequency sweep elements displays the "Error 23 RNGE" (RaNGE) message. Saving an operating state in the lowest memory register occupied by discrete frequency sweep elements reclaims that memory register for operating state storage.

HP-IB Example:

"DSAV03"

Clear Discrete



The CLR DISCRETE (CLear DISCRETE) key erases all discrete frequency sweep elements stored in nonvolatile memory and replaces the states with the preset state. The CLR DISCRETE key is available by pressing the blue SHIFT key prior to the green INSTR PRESET key.

HP-IB Example:

"DCLR"

Instrument Preset



The HP 3326A is restored to the preset state by pressing the green INSTR PRESET (INSTRument PRESET) key in the INSTR STATE (INSTRument STATE) key group. INSTR PRESET provides a convenient state for establishing an instrument setup, and does not destroy any instrument states stored in nonvolatile memory. The preset state is listed in Figure 1-1.

HP-IB Example:

"RST"

CALIBRATION AND SELF TEST

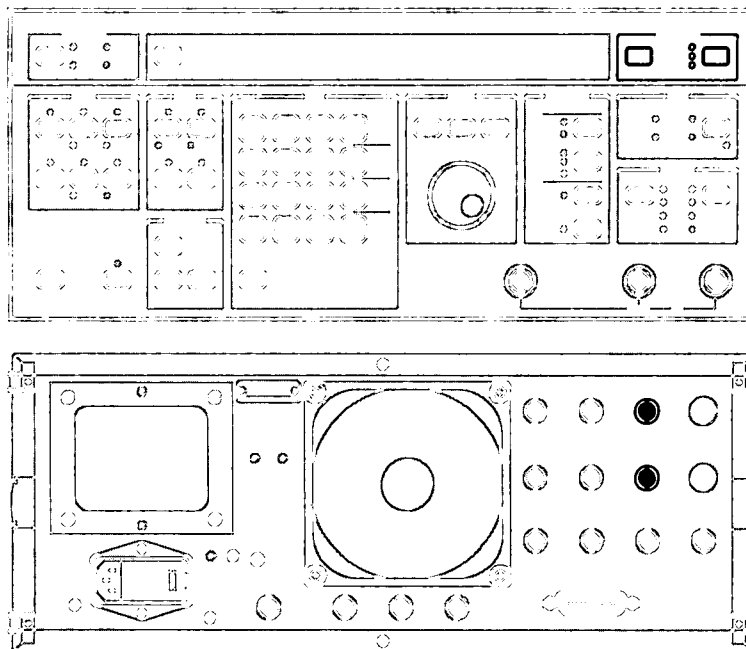

Selecting a Calibration Mode



The SELECT key selects the phase calibration source or type. Each time the SELECT key is pressed, the calibration indicators sequence through the INTERNAL, EXTERNAL, and MULTIPHASE selections. A calibration is initiated with the MANUAL key.



Internal Calibration

With internal calibration selected as the calibration source, the HP 3326A phase, amplitude, dc offset, and internal modulation is calibrated with internal references.

HP-IB Examples:

"CMD1"
or
"CMD INT"



A-EXT ϕ CAL IN



(1-10 Vpp)

B-EXT ϕ CAL IN / MULTI ϕ REF IN



(1-10 Vpp)

External Calibration

In the 2 PHASE mode, external calibration enables the HP 3326A to sense phase at an external reference point and calibrates the channel B phase with respect to channel A phase. Phase is sensed through the rear panel A-EXT ϕ CAL IN and B-EXT ϕ CAL IN/MULTI ϕ REF IN connectors. The external calibration inputs require an input range from 3 to 10 volts peak-to-peak over the frequency range of 1 kHz to 13.1 MHz. Figure 1-27 illustrates a typical external phase calibration circuit. Amplitude, dc offset, and internal modulation are calibrated with internal references.

HP-IB Example:

“CMD2”
or
“CMD EXT”

NOTE

For maximum phase calibration accuracy, match the channel A and B external calibration cable lengths.

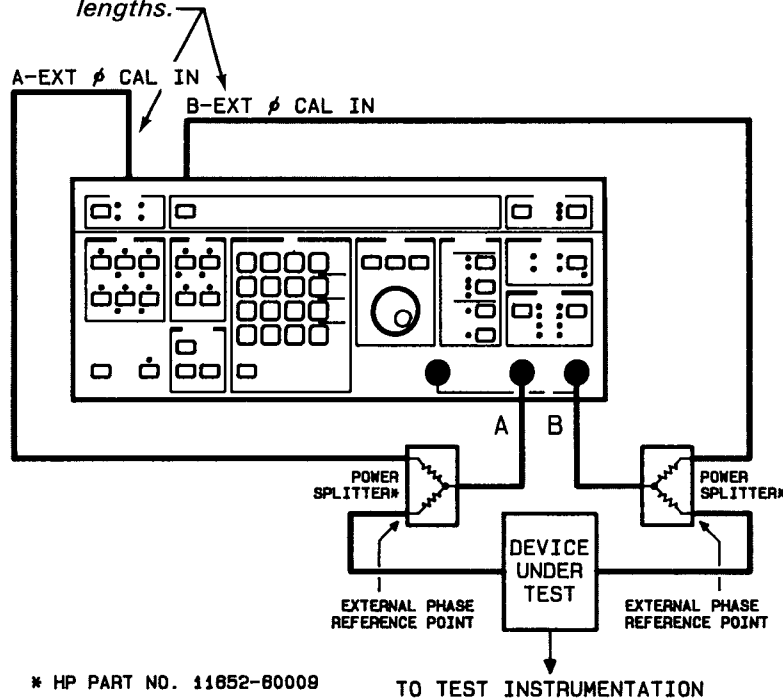

Figure 1-27. External Phase Calibration Connection Diagram



A-EXT ϕ CAL IN



(1-10 Vpp)

B-EXT ϕ CAL IN /MULTI ϕ REF IN



(1-10 Vpp)

Multiphase Calibration

In the 2 PHASE mode, multiphase calibration enables the HP 3326A to maintain a calibrated phase output with respect to an external reference. The phase relationship between channel A and the external reference of the same frequency is sensed through the rear panel A-EXT ϕ CAL IN and B-EXT ϕ CAL IN/MULTI ϕ REF IN connectors. After calibrating channel A phase to the external reference, channel B phase is internally calibrated to channel A phase. The external calibration inputs require an input range from 3 to 10 volts peak-to-peak over the frequency range of 1 kHz to 13.1 MHz. Figure 1-28 illustrates a typical multiphase calibration circuit. Amplitude, dc offset, and internal modulation are calibrated with internal references.

HP-IB Example:

“CMD3”
OR
“CMD MULT”

NOTE

For maximum phase calibration accuracy, match the channel A and B multiphase calibration cable lengths.

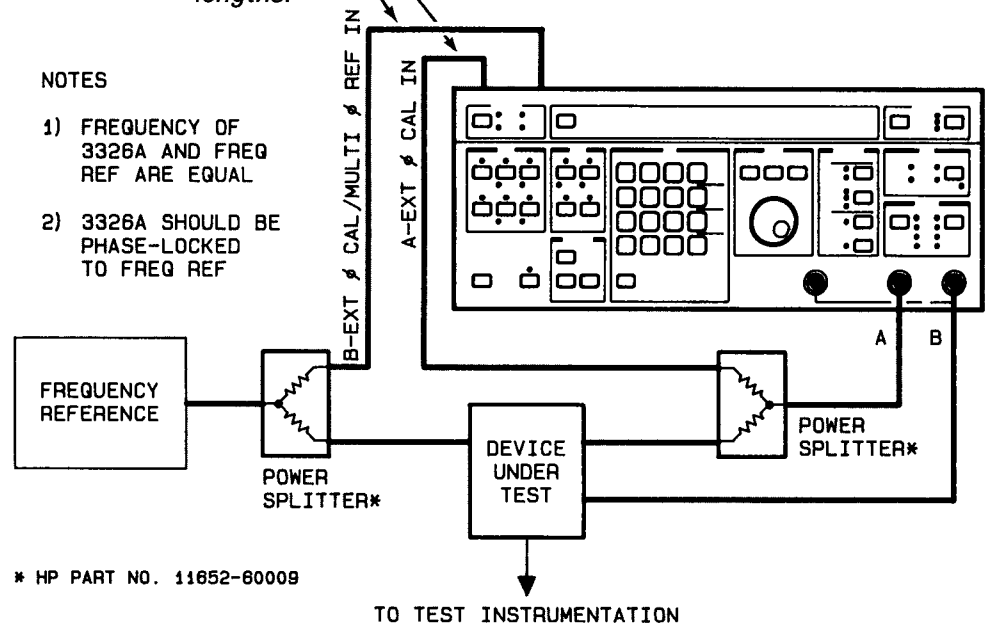

Figure 1-28. Multiphase Calibration Connection Diagram

Manual



The MANUAL key initiates a calibration each time the key is pressed. Amplitude and dc offset for the selected function, internal AM and PM (if selected), and phase (for 2 PHASE or PULSE mode) are calibrated during a manual calibration. Figure 1-29 lists other events that initiate a calibration.

HP-IB Example:

“CAL”

Automatic Calibration



An automatic calibration cycle is enabled by pressing the blue SHIFT key prior to the MANUAL key. The AUTO indicator illuminates when automatic calibration is enabled. When automatic calibration is enabled, a calibration occurs immediately after enabling automatic calibration, 5 minutes after power is applied, 15 minutes after power is applied, and at 30 minute intervals thereafter. Figure 1-29 lists the calibrations performed by the HP 3326A and the events that initiate calibration.

HP-IB Example:

“ACAL1”
or
“ACAL ON”

EVENT	TYPE OF CALIBRATION
Mode change	Phase calibration if changing to 2 PHASE or PULSE modes.
Function change	Phase calibration if AUTO CAL enabled.
Frequency change	PULSE mode or 2 PHASE mode phase calibration if frequency changed by more than 1 MHz since last phase calibration and AUTO CAL enabled.
Internal AM enabled	Internal AM calibration if AUTO CAL enabled.
Internal PM enabled	Internal PM calibration if AUTO CAL enabled.
HP-IB Program recall	If AUTO CAL not enabled, phase calibration if new mode is 2 PHASE or PULSE. If AUTO CAL enabled, performs manual calibration.
Manual calibration	Amplitude and dc offset for function selected, internal AM and PM (if enabled), and phase (2 PHASE or PULSE mode).
Power up and AUTO CAL	Amplitude and residual dc offset for sine, square wave, and DC functions, dc offset, phase shift of internal circuits, internal AM and PM, and phase. Phase calibration source or type is selected by CALIBRATION SELECT key.

Figure 1-29. HP 3326A Calibration

Self Test



A self test is initiated by pressing the blue SHIFT key prior to the SELECT key. During a self test, all indicators and display segments briefly illuminate, and a series of internal tests is initiated. After each internal test, PASS or FAIL followed by a test number is displayed to indicate the test results. During a self test, the outputs are disabled.

HP-IB Example:

"TST"

THE HP-IB STATUS KEYS/INDICATORS/CONNECTOR

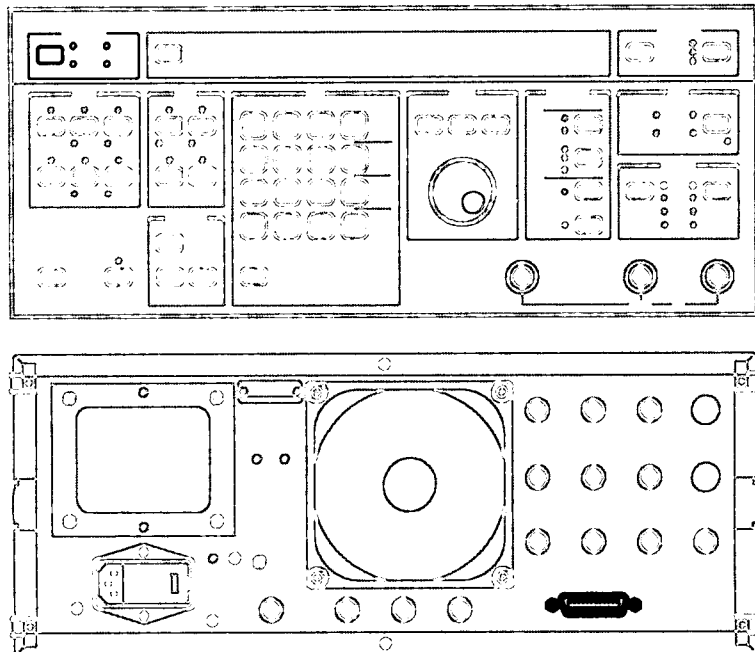

The HP-IB (Hewlett-Packard Interface Bus) Status keys and indicators are used during remote operation. An overview of the HP-IB and a description of the HP 3326A HP-IB characteristics is in Chapter II. Chapter III describes the HP 3326A commands unique to remote operation and contains a complete list of the HP-IB commands.

Local



The LOCAL key removes the HP 3326A from remote (HP-IB) operation if local lockout is not in effect and the display is not disabled. Remote operation is indicated by the illuminated REMOTE indicator.

NOTE

If "DISP OFF" (DISPlay OFF) is displayed on the HP 3326A, the display has been disabled by the DISP OFF HP-IB command. To return the HP 3326A to normal, use the DISP ON HP-IB command or apply power with the blue SHIFT key depressed (a memory clear operation).



The REMOTE indicator illuminates when the HP 3326A is operating under HP-IB control. While in remote (and local lockout is not in effect), only the LOCAL key is recognized.



The LISTEN indicator illuminates when the HP 3326A is addressed to listen over the HP-IB.



The TALK indicator illuminates when the HP 3326A is addressed to talk over the HP-IB.



The SRQ (Service ReQuest) indicator illuminates when the HP 3326A is generating an HP-IB service request.

NOTE

An SRQ may be generated while the HP 3326A is in local if the status byte mask used to enable an SRQ is not reset. To extinguish the front panel SRQ indicator, set the SRQ mask to zero and perform a serial poll with a controller, or apply power with the blue SHIFT key depressed (a memory clear operation). For more information on the status byte mask, refer to "Reading and Masking the Status Byte" in chapter III.

Bus Address



The BUS ADRS (BUS ADdReSs) key enables display or entry of the HP-IB address. The BUS ADRS key is selected by pressing the blue SHIFT key prior to the LOCAL key. After selection of the BUS ADRS key, the HP-IB address is entered with the numeric keypad. For two digit HP-IB addresses, the address is set when the second digit is entered. For single digit HP-IB addresses, the address is set when any units key is pressed. Alternately, a zero can precede the single digit to form a two digit address. The HP-IB address is an integer in the range of 0 to 30 and is retained in nonvolatile memory.



The HP 3326A is connected to other HP-IB devices through the rear panel HP-IB connector.

EXTERNAL TRIGGER

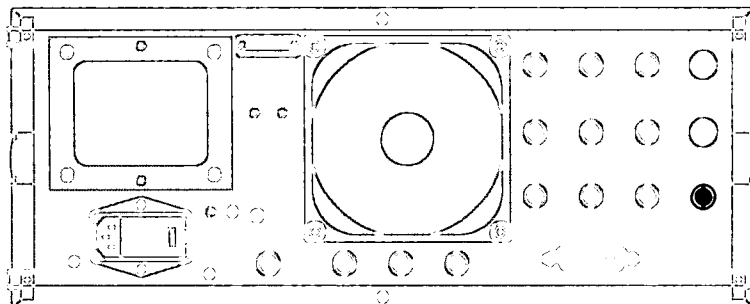

From the preset state, EXT TRIG IN (EXTERNAL TRIGGER INPUT) is used to trigger single frequency sweeps. Triggered operation is initiated by a negative edge transition of a TTL level signal after the sweep is reset. Triggers received during a sweep reset are ignored. The shortest delay between a trigger and sweep start is when the sweep is reset prior to the trigger. The trigger functions are extended through the use of HP-IB commands described in "Triggered Sweeps" and "Modifying Parameters" in Chapter III. To inhibit inadvertently triggered sweeps, remove the trigger signal from the EXT TRIG IN connector, or disable triggered operation with the TOFF (Trigger OFF) HP-IB command.

MARKER / Z-BLANK (PEN LIFT) / X-DRIVE OUTPUTS

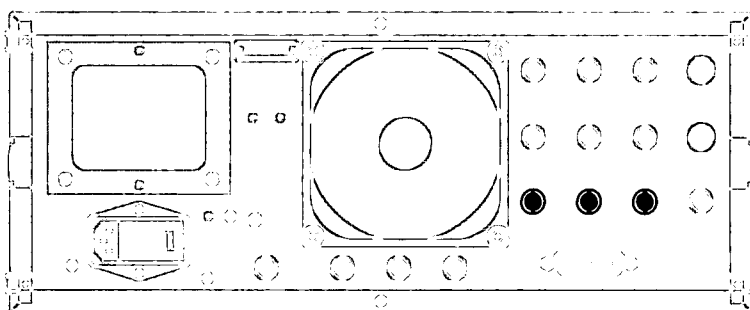

The MARKER OUT, Z-BLANK OUT, and X-DRIVE OUT connectors provide outputs to drive an analog plotter or oscilloscope display during sweep operation. Figure 1-30 illustrates the use of MARKER OUT to drive an oscilloscope. Figure 1-31 illustrates the oscilloscope connections used to obtain the display.

Marker Out



The rear panel MARKER OUT connector provides a TTL level signal to indicate when the sweep frequency reaches the value entered for the marker frequency. The high to low transition in the channel B trace in Figure 1-30 illustrates the MARKER OUT level change during a sweep.

Triangle Linear Sweep

When sweeping from the start to the stop frequency, MARKER OUT drops to a low level at the selected marker frequency. When sweeping from the stop to the start frequency, MARKER OUT rises to a high level at the selected marker frequency.

Ramp Linear Sweep

When sweeping from the start to the stop frequency, MARKER OUT drops low at the selected marker frequency.

Discrete Frequency Sweep

MARKER OUT drops low at the start of each frequency element and remains low until the end of the sweep element. MARKER OUT returns to a high level briefly (10 μ second minimum) during the transition between sweep elements.

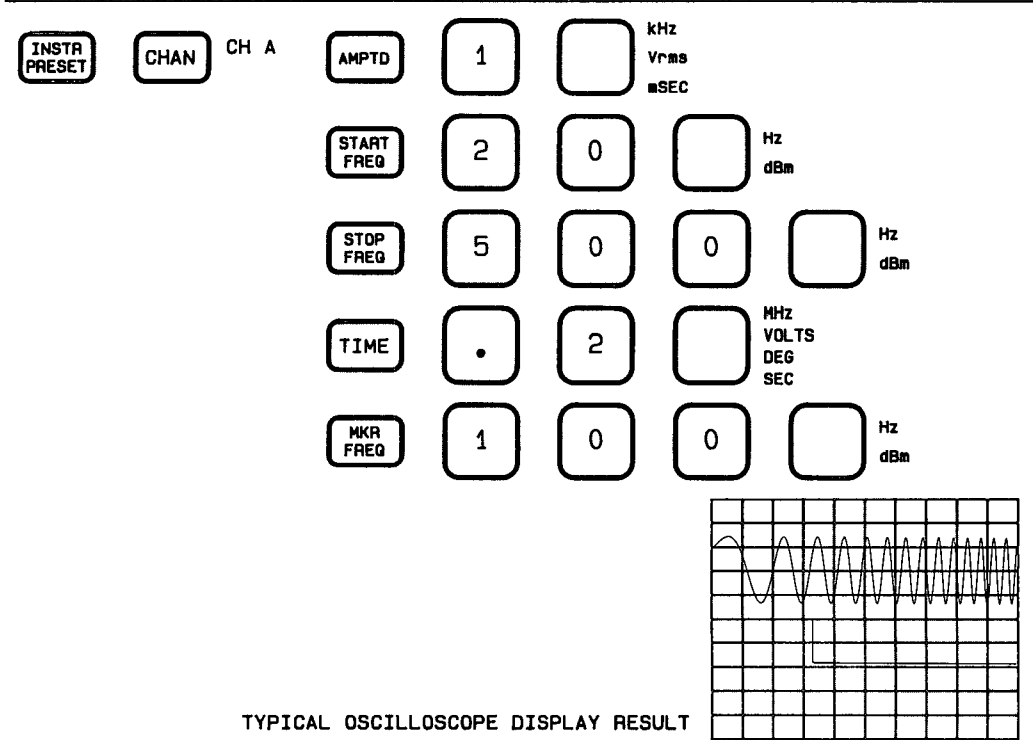

TYPICAL OSCILLOSCOPE DISPLAY RESULT

Figure 1-30. Using the MARKER OUT Signal

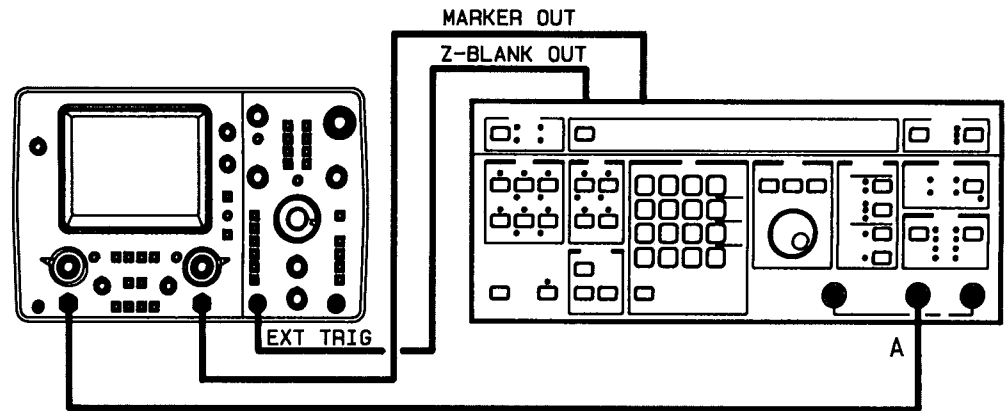

Figure 1-31. Connecting MARKER OUT to an Oscilloscope

Z-Blank Out



The Z-BLANK OUTput drops low at the start of sweep and remains low until the end of a sweep. At the end of a sweep, Z-BLANK OUT goes to a high level and remains high until another sweep segment is initiated. The Z-BLANK OUT connector is located on the rear panel and the output is TTL compatible. The Z-BLANK OUT low level is capable of sinking current from a positive voltage source through a pen-lift circuit or other device. Figure 1-32 illustrates a typical circuit for connecting Z-BLANK OUT to an oscilloscope. When used as an input, the maximum Z-BLANK OUT ratings are:

Maximum current sink: 100 mA
 Allowable voltage range: 0 to +42 V dc

Ramp Linear Sweep

Z-BLANK OUT drops low at the start of sweep and remains low until the end of a sweep. At the end of a sweep, the Z-BLANK OUT goes to a high level and remains high while the frequency is reset to the start frequency.

Triangle Linear Sweep

Z-BLANK OUT drops low during the sweep from the start frequency to the stop frequency, and during the sweep from the stop frequency to the start frequency. Z-BLANK OUT is high when the HP 3326A is not sweeping.

Discrete Frequency Sweep

Z-BLANK OUT drops low at the start of a sweep sequence and remains low until the end of a sweep sequence. At the end of a sweep, Z-BLANK OUT goes to a high level and remains high until another sweep is initiated.

X-Drive Out



During sweep operation, the rear panel X-DRIVE OUT connector provides a 0 to 10 or 10 to 0 volt linear ramp proportional to the sweep time. Figure 1-30 illustrates a typical circuit that uses X-DRIVE OUT to control the horizontal deflection of the oscilloscope display.

Triangle Linear Sweep

X-DRIVE OUT increases from 0 to 10 volts for the sweep from the start frequency to the stop frequency and decreases from 10 to 0 volts for the sweep from the stop frequency to the start frequency.

Ramp Linear Sweep

X-DRIVE OUT increases from 0 to 10 volts for the sweep from the start frequency to the stop frequency. At the end of a sweep the output is reset to 0 volts.

Discrete Frequency Sweep

Normally, X-DRIVE OUT increases linearly from 0 to 10 volts during the total sweep time. If the total sweep time is between 1000 and 1024 seconds, X-DRIVE OUT increases at the lowest sweep rate with a maximum output of 10.24 volts. If the sweep time exceeds 1024 seconds, the output voltage is reduced to 0 volts and the cycle is repeated.

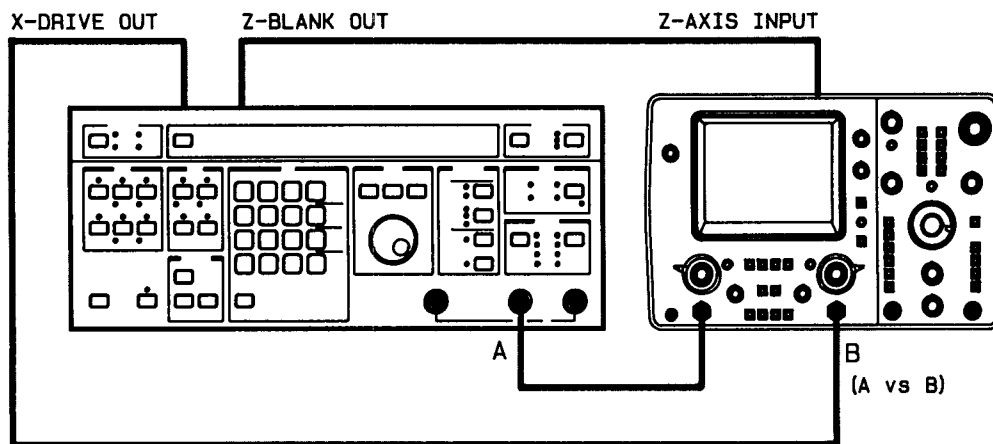
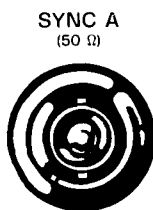
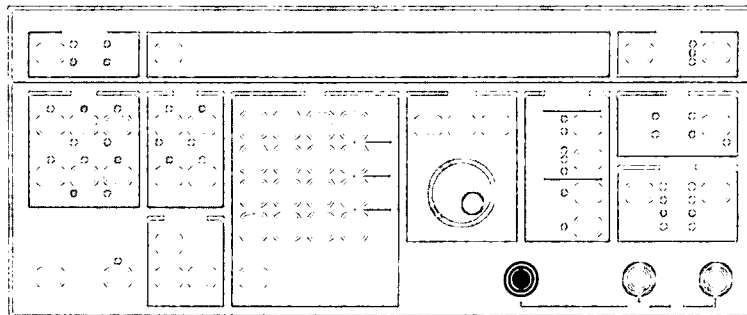

Figure 1-32. Connecting Z-BLANK OUT and X-DRIVE OUT to an Oscilloscope

SYNC A OUTPUT



A TTL square wave with the frequency and phase of the channel A output is available at the front panel SYNC A (SYNChronous with channel A) connector. The SYNC A transition occurs at the midpoint between peaks on the channel A signal. Figure 1-33 illustrates the oscilloscope connections used to obtain the display. Figure 1-34 illustrates the output from the SYNC A and CH A connectors. The impedance of the SYNC A output is 50 Ω. When the SYNC A output is terminated in 50 Ω, the output levels are:

Low level ≤ +0.2 V
 High level ≥ +1.2 V

NOTE

If the SYNC A output is connected to a high impedance load, the voltage levels will be approximately twice the values listed. Improper termination of a 50 Ω system may cause ringing at the positive and negative transitions.

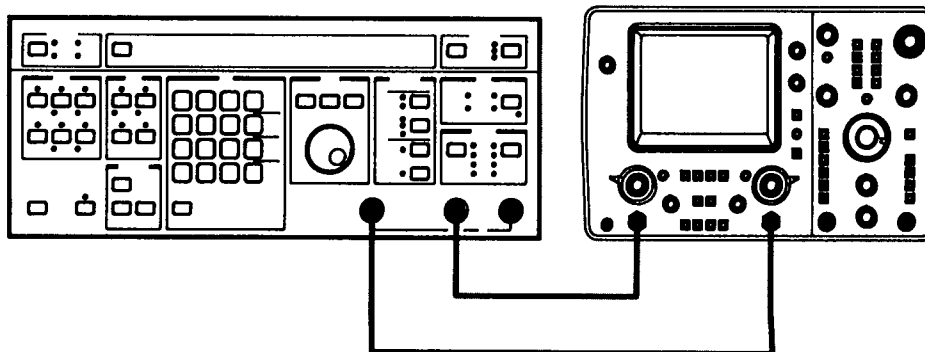

Figure 1-33. CH A and SYNC A Output Connection

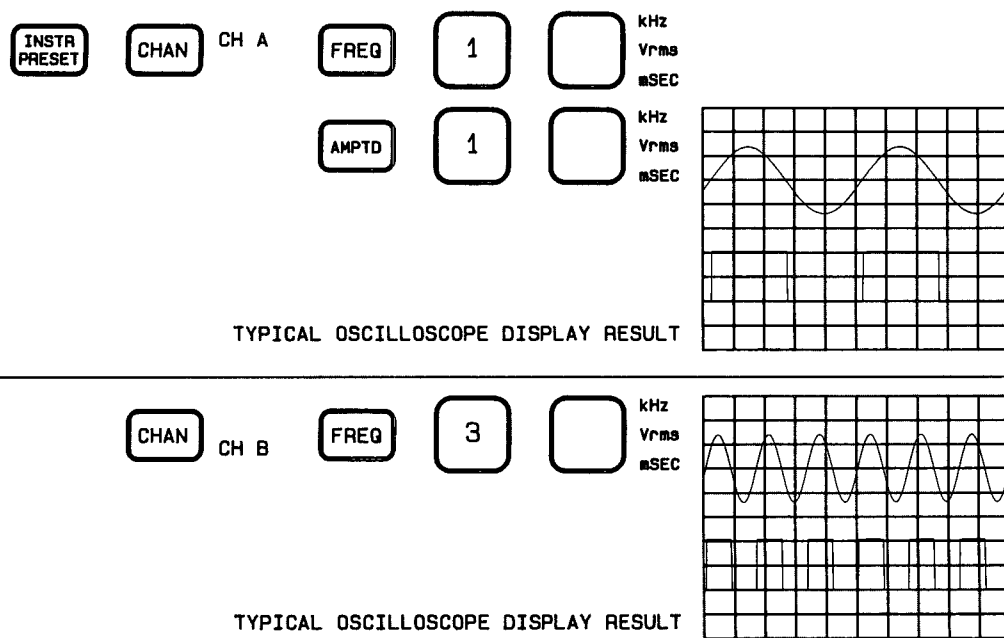
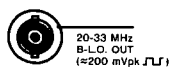
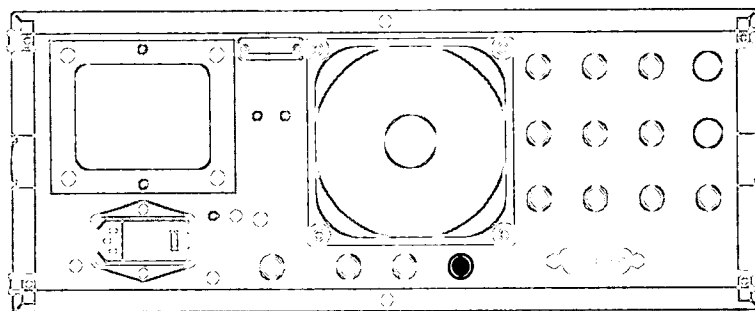

Figure 1-34. CH A and SYNC A Outputs

20-33 MHz L.O. OUTPUT (EXTENDED FREQUENCY)



The rear panel 20-33 MHz B-L.O. OUT connector supplies a signal offset by 20 MHz from the channel B output. The output is ac coupled with a level greater than 100 mV peak-to-peak into 50 ohms. The output frequency is controlled through a channel B FREQ key entry, channel B sweep, or channel B phase modulation. Figure 1-35 illustrates the oscilloscope connections used to obtain the display. Figure 1-36 illustrates the output from the 20-33 MHz B-L.O. OUT connector.

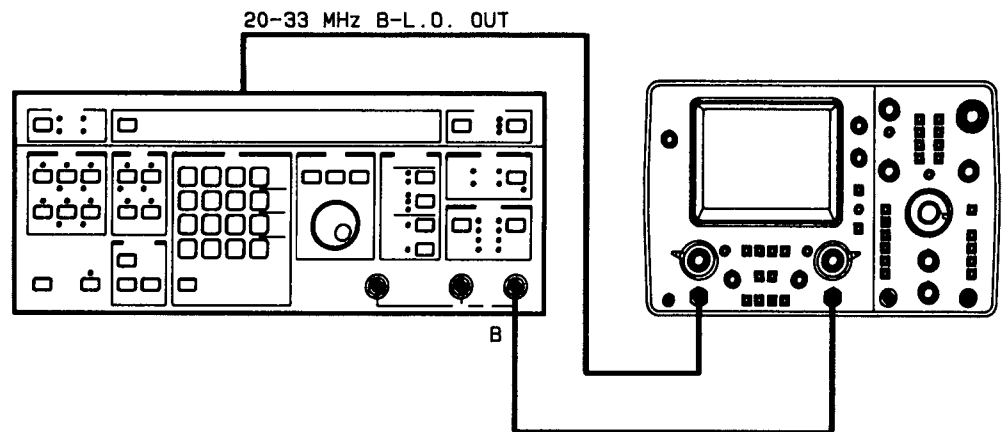

Figure 1-35. B-L.O. Output Connection

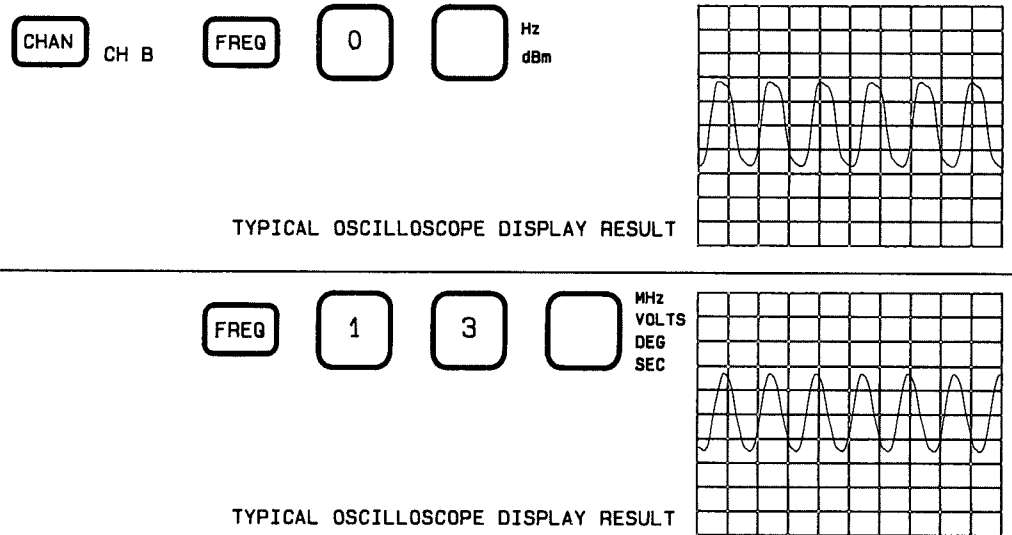
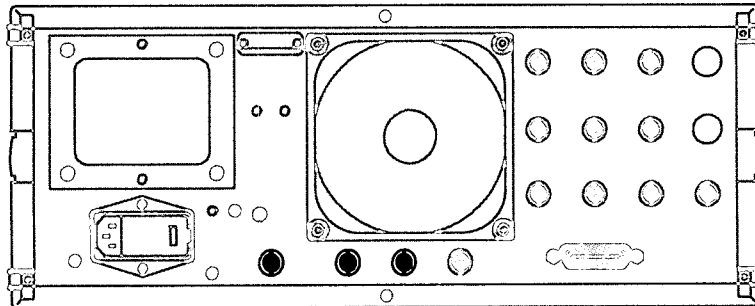

Figure 1-36. B-L.O. Output

EXTERNAL REFERENCE OR OVEN STABILIZED FREQUENCY OPTION



10 MHz Oven Output (High Stability Frequency Reference - Option 001)



The 10 MHz OVEN OUT OPTION 001 connector is available if the high stability frequency reference (Option 001) is installed. Option 001 is a 10 MHz temperature (oven) stabilized crystal oscillator. The crystal oscillator connects to the HP 3326A frequency circuits by connecting the 10 MHz OVEN OUT OPTION 001 connector to the 1, 2, 5, 10 MHz REF IN connector with a BNC to BNC adapter (HP part number 1250-1499). The 10 MHz OVEN OUT OPTION 001 output is a square wave with a level greater than 3 dBm (50 Ω). The output is present whenever the HP 3326A is connected to a power source.

To reduce the warmup time and obtain maximum performance from an HP 3326A equipped with Option 001, leave the HP 3326A connected to a power source. Power is supplied to Option 001 whenever the HP 3326A is connected to a power source. An HP 3326A with Option 001 requires 15 minutes of operation to meet frequency specifications if power is disconnected for less than 24 hours. If power is disconnected for more than 24 hours, the HP 3326A may require up to 72 hours of operation to meet frequency specifications.

External Frequency Reference

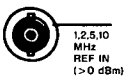

The HP 3326A is phase-locked to external frequency references through the 1, 2, 5, 10 MHz REF IN connector. Phase-locking to an external frequency reference transfers the external reference's frequency accuracy and aging rate to the HP 3326A. The level of the frequency reference must be from 0 dBm to +20 dBm (50 Ω). The frequency must be 10 MHz (± 10 ppm) or a subharmonic down to 1 MHz (e.g. 1, 2, 5, or 10 MHz). The front panel EXT REF indicator illuminates when the HP 3326A is phase-locked to an external frequency reference. The message "Error 180 XREF" (eXternal REFerence) is displayed if a signal is present and the HP 3326A is not phase-locked. The 10 MHz OVEN OUT OPTION 001 output is connected to this connector if the high stability frequency reference (Option 001) is installed.



The 10MHz OUT connector supplies a 10 MHz square wave derived from the frequency reference of the HP 3326A. The square wave has a level greater than 3 dBm (50 Ω). This output can be used to phase-lock an analyzer or other instrumentation to the frequency reference of the HP 3326A.

CHAPTER 2
HP-IB OPERATION

Chapter 2 — Table of Contents

DESCRIPTION OF THE HP-IB	2-1
HP 3326A HP-IB CAPABILITY	2-2
HP-IB INTERFACE MANAGEMENT LINES	2-2
TALK / LISTEN ADDRESSES	2-2
VIEWING THE HP 3326A HP-IB ADDRESS	2-4
CHANGING THE HP 3326A HP-IB ADDRESS	2-4
BUS MESSAGES	2-4
SERVICE REQUEST	2-6
THE STATUS BYTE	2-7
MASKING THE STATUS BYTE	2-8

CHAPTER 2

HP-IB OPERATION

This section contains an overview of the Hewlett-Packard Interface Bus (HP-IB) and the relationship of the HP 3326A to the HP-IB. The HP-IB is a bus structure that links the HP 3326A to desktop computers, minicomputers, and other HP-IB controlled instruments to form automated measurement systems. The HP-IB is Hewlett-Packard's implementation of the IEEE Standard 488-1978 and ANSI Standard MC 1.1. The HP-IB commands specifically intended for the HP 3326A HP-IB operation are listed and described in Chapter III.

DESCRIPTION OF THE HP-IB

All of the active HP-IB interface circuits are contained within the various HP-IB controlled devices. The interconnecting cable is entirely passive and its role is limited to connecting the devices in parallel so that data can be transferred from one device to another.

Every participating device must be able to perform at least one of the following roles: talker, listener, or controller. A talker transmits data to other devices called listeners. Most devices can be both a talker and listener, but not at the same time. A controller manages the operation of the bus system by designating which device is to talk and which devices are to listen at any given time. The HP 3326A can be either a talker or a listener, but does not have talk only or listen only capabilities.

The full flexibility and power of the HP-IB is realized when a controller is added to the system. An HP-IB controller participates in the measurement by being programmed to automate, monitor, and coordinate instrument operation as well as process the measurement results. Figure 2-1 summarizes the capabilities of the HP-IB.

Number of Interconnected Devices

Up to 15 devices maximum may be on one contiguous bus.

Interconnection Path/Maximum Cable Length

Star or linear bus network. Total transmission path length = 2 meters times number of devices, or 20 meters, whichever is less, with a maximum of 3 meters separating any two devices.

Message Transfer

Byte-serial, 8 bit-parallel asynchronous data transfer using a 3 wire handshake.

Data Rate

One megabyte per second (maximum) over limited distances, actual data rate depends upon the capability of the slowest device involved in the transmission.

Address Capability

Primary addresses: 31 talk, 31 listen; secondary (2-byte) addresses, 961 talk, 961 listen. 1 Talker and 14 listeners, maximum at one time. The HP 3326A has only primary address capability. Figure 2-4 lists the talk and listen HP-IB addresses.

Multiple Controller Capability

In systems with more than one controller, only one controller can be active at a time. The active controller can pass control to another controller, but only the system controller can assume unconditional control. Only one system controller is allowed.

Interface Circuits

Driver and receiver circuits are TTL compatible.

Figure 2-1. HP-IB Specification Summary

HP 3326A HP-IB CAPABILITY

The HP 3326A interfaces to the HP-IB as defined by IEEE Standard 488-1978. The interface functional subset which the HP 3326A implements is specified in Figure 2-2.

Code	Function
SH1	Complete source handshake capability
AH1	Complete acceptor handshake capability
T6	Basic talker; serial poll; unaddressed to talk if addressed to listen; no talk only
L4	Basic listener; unaddressed to listen if addressed to talk; no listen only
SR1	Complete service request capability
RL1	Complete remote/local capability
PP0	No parallel poll capability
DC1	Device clear capability
DT1	Device trigger capability
C0	No controller capability
E1	Driver electronics - open collector

Figure 2-2. HP 3326A HP-IB Capability

HP-IB INTERFACE MANAGEMENT LINES

Five lines in the HP-IB manage the orderly flow of information across the HP-IB. Figure 2-3 describes the lines used in managing the HP-IB.

LINE NAME	MNEMONIC	DESCRIPTION
Attention	ATN	Causes all devices to interpret data on the bus as a controller command and activate their acceptor handshake function (command mode) or data between addressed devices (data mode).
Interface Clear	IFC	Initializes the HP-IB system to an idle state (no activity on the bus).
Service Request	SRO	Alerts controller to a need for communication.
Remote Enable	REN	Enables devices to respond to remote control when addressed to listen.
End or Identify	EOI	Indicates last data byte of a multibyte sequence; also used with ATN to parallel poll devices for their status bit.

Figure 2-3. HP-IB Interface Management Lines

TALK/LISTEN ADDRESSES

Each HP-IB device has at least one talk, and one listen address (unless the device is totally transparent, or a talk only or listen only device). Device addresses are used by the active controller in the COMMAND MODE (ATN true) to specify the talker (via a talk address) and the listener (via listen addresses). There may be only one talker addressed by the controller to talk at any time.

The address of a device is usually preset at the factory and is resettable during system configuration. In the binary representation of the address, the device address is the decimal equivalent of the five least significant bits of the address. (On HP-IB devices with selector switches, these are the five address switches.) The address can be from 0 to 30 inclusive. The sixth and seventh bits determine if the address is a talk or listen address respectively. High level HP-IB controllers typically configure these two bits automatically. Figure 2-4 lists the HP-IB addresses if a controller requires the talk and listen addresses.

DEVICE ADDRESS	BINARY ADDRESS	ADDRESS CHARACTERS	
		TALK	LISTEN
0	0000 0000	@	SPACE
1	0000 0001	A	!
2	0000 0010	B	"
3	0000 0011	C	#
4	0000 0100	D	\$
5	0000 0101	E	%
6	0000 0110	F	&
7	0000 0111	G	'
8	0000 1000	H	(
9	0000 1001	I)
10	0000 1010	J	*
11	0000 1011	K	+
12	0000 1100	L	,
13	0000 1101	M	-
14	0000 1110	N	.
15	0000 1111	O	/
16	0001 0000	P	0
17	0001 0001	Q	1
18	0001 0010	R	2 (HP 3326A factory selected address)
19	0001 0011	S	3
20	0001 0100	T	4
21	0001 0101	U	5 (typically the controller)
22	0001 0110	V	6
23	0001 0111	W	7
24	0001 1000	X	8
25	0001 1001	Y	9
26	0001 1010	Z	:
27	0001 1011	[;
28	0001 1100	/	<
29	0001 1101]	=
30	0001 1110	^	>

Figure 2-4. HP-IB Addresses

The talk and listen addresses fall within the printable ASCII character set. When a device receives one of these characters while ATN is true, it becomes addressed. The ASCII character "?" (ASCII 31) unaddresses all devices while ATN is true. The device address (set from the HP 3326A front panel) is used by HP-IB controllers most of which automatically send the talk and listen address characters.

VIEWING THE HP 3326A HP-IB ADDRESS

The HP-IB address of the HP 3326A is stored in a nonvolatile memory (there are no address switches). The HP 3326A address appears in the display when the BUS ADDRESS key in the HP-IB STATUS block is pressed. The BUS ADDRESS key is selected by pressing the blue SHIFT key followed by the LOCAL key. The HP 3326A address is removed from the display by pressing another key that requires the display.

CHANGING THE HP 3326A HP-IB ADDRESS

Every device on the HP-IB must have a unique address. The HP 3326A address can be set at any address between 0 and 30, inclusive and is stored in internal nonvolatile memory. When selecting an address, remember that the controller also has an address (usually 21). To change the HP-IB address:

- Press the blue SHIFT key followed by the LOCAL key in the HP-IB STATUS block to display the HP-IB address.
- Enter the address with the numeric keypad. For two digit HP-IB addresses, the address is set when the second digit is entered. For a single digit HP-IB address, the address is set when any units key is pressed. Alternately, a zero can precede the single digit to form a two digit address.

NOTE

The HP-IB address is reset to 18 after a memory clear operation.

- The message "Error 20 RNGE" is displayed if the HP-IB address exceeds 30.

BUS MESSAGES

The HP-IB interface system operates in either of two modes: command mode (ATN bus management line true) or data mode (ATN bus management line false). If an HP controller is used, the bus management lines are configured automatically and all necessary command strings are issued.

In the command mode, devices on the HP-IB can be addressed or unaddressed as listeners or talkers. Bus commands are also issued in the command mode. These commands may instruct the HP-IB interface to control the instrument (like CLEAR or TRIGGER) but are more often used for bus management (REMOTE, LOCAL, POLLS, SERV-

ICE REQUEST, ABORT interface activity, or PASS CONTROL). Bus commands are issued through one of the bus management lines or through the eight bit data bus. Figure 2-5 lists the commands used in the command mode.

In the data mode, data or instructions are transferred between instruments on the HP-IB. Instructions transferred to the instrument are called device dependent commands. All the commands specifically for the HP 3326A fall into this category. The HP 3326A device dependent commands configure the HP 3326A, initiate measurements, initiate data transfers, or define error reporting conditions. These device dependent commands are meaningless for other instruments. The HP 3326A device dependent commands are listed in Chapter III.

ABORT

The abort command (interface clear - IFC true) halts all HP-IB activity. The system controller assumes unconditional control of the bus. The HP 3326A responds by becoming unaddressed.

CLEAR

The clear command causes all devices addressed to listen to reconfigure to a predefined device dependent condition. The HP 3326A responds to the clear command (both the device clear - DCL and selective device clear - SDC) by clearing the interface command buffer of any pending commands, and clearing the status byte register, the SRQ register, and error register. The HP 3326A ends the clear cycle by setting the ready bit (bit 4) in the HP 3326A status byte.

CLEAR LOCKOUT/SET LOCAL

The clear lockout/set local command removes all devices from the local lockout mode and returns the HP 3326A to local (front panel) control. Because the REN bus management line is set false, the HP-IB is in the local mode.

LOCAL

The local command clears the remote command from the listening device and returns the listening device to local (front panel) control. If local lockout is not in effect, the HP 3326A responds by returning to front panel control. The REMOTE indicator on the front panel extinguishes if the HP 3326A is in REMOTE prior to the LOCAL command.

LOCAL LOCKOUT

The local lockout command disables the LOCAL front panel key to avoid operator interference. The HP 3326A front panel is locked out.

PARALLEL POLL

The parallel poll command is a controller operation used to obtain information from the devices under its control. The HP 3326A does not respond.

PASS CONTROL

The pass control command shifts system control from one controller to another. The HP 3326A does not respond.

Figure 2-5. HP-IB Control Commands 

REMOTE

The remote command directs an instrument to take instructions from the HP-IB. To implement the remote command, the controller must set the REN bus management line true. When the HP 3326A accepts the remote command, the REMOTE front panel indicator illuminates and the front panel is disabled except for the LOCAL key. If local lockout message is issued, the mode cannot be changed from remote to local via the front panel.

SERIAL POLL

The serial poll command requests that the HP 3326A send its status byte. Encoded in the HP 3326A status word are eight bits indicating the states of several operating parameters (refer to "The Status Byte").

SERVICE REQUEST

The SRQ (service request) bus management line is used by a device to indicate the need for attention from the controller. When the HP 3326A issues an SRQ it also sets bit six of the status byte (see the Status Byte) and illuminates the front panel SRQ indicator. The SRQ is cleared by executing a serial poll of the HP 3326A.

NOTE

An SRQ may be generated while the HP 3326A is in local if the status byte mask used to enable an SRQ is not reset. To extinguish the front panel SRQ indicator, set the SRQ mask to zero and perform a serial poll with a controller, or apply power with the shift key depressed (a memory clear operation). A memory clear replaces the contents of nonvolatile memory with preset state setup data. For more information on the status byte mask, refer to "Masking the Status Byte."

TRIGGER

The group execute trigger (GET) or selective device trigger (SDT) command causes all addressed instruments with HP-IB trigger capability to execute a predefined function simultaneously. The HP 3326A responds to the HP-IB trigger as it would to an external trigger.

Figure 2-5. HP-IB Control Commands (Cont.)

SERVICE REQUEST

One of the five bus management lines connected to every device on the bus is the SRQ line. The SRQ line is used by a device to indicate the need for attention from the controller. When the HP 3326A requires service, it sets bit six of the status byte, illuminates the front panel SRQ indicator, and generates the SRQ. Bit six, the require service bit, is sometimes referred to as the status bit in connection with a poll. Any bit in the status byte may initiate an SRQ. The status byte may be masked to select which bits cause the HP 3326A to set the SRQ line.

When a controller senses an SRQ, it can poll each device to find the device requiring service. The HP 3326A responds to a serial poll by returning its status byte.

THE STATUS BYTE

The status byte is an eight bit word transmitted by the HP 3326A in response to a serial poll. The state of each bit indicates the status of an internal HP 3326A function. Figure 2-6 describes the HP 3326A status byte bit positions, and the events and conditions that set and reset each bit. Any status bit becomes enabled (set) when the condition it represents changes from false to true. An enabled bit sets bit 6, and generates an SRQ if the Boolean AND of the status byte and the status byte mask is not equal to zero.

Status Byte Bit Numbers: B7 B6 B5 B4 B3 B2 B1 B0

BIT NUMBER	DECIMAL VALUE	DESCRIPTION
B7	128	POWER RESTORED. Set when power is restored to the HP 3326A after power is interrupted. Reset when the HP 3326A is preset or receives a device clear, selected device clear, or RST command.
B6	64	REQUIRE SERVICE. Set when the HP 3326A requires service (sent an SRQ). Cleared when the condition causing the SRQ is removed, or when the HP 3326A is preset or receives a device clear, selected device clear, or RST command.
B5	32	ERROR. Set when either a program or hardware error condition exists for the HP 3326A. Reset when the HP 3326A is preset, or receives a device clear command, selected device clear command, RST command, or when the error register is read with the IERR or ERR? HP-IB command.
B4	16	READY. Set when the HP 3326A has executed the last HP-IB command and is ready for the next command. Reset when the HP 3326A receives a device dependent command, device clear command, selected device clear command, or trigger.
B3	8	HARDWARE ERROR. Set when the HP 3326A detects an internal failure. Reset when the HP 3326A is preset, or receives a device clear command, selected device clear command, RST command, or when the error register is read with the IERR or ERR? HP-IB command.
B2	4	SWEEP START/IN PROGRESS. Set when the HP 3326A starts a sweep. Reset when the sweep is stopped (either by reaching the stop frequency or aborted by a front panel or HP-IB command). It is also reset when the HP 3326A is preset or receives a device clear command, selected device clear command, or RST command.
B1	2	SWEEP STOPPED. Set when the HP 3326A ends a sweep normally. Reset when the HP 3326A is preset or receives a device clear command, selected device clear command, or RST command.
B0	1	PROGRAM ERROR. Set when the HP 3326A receives an invalid HP-IB command (e.g. command syntax or incompatible command for mode selected). Reset with an INSTR PRESET, device clear command, selected device clear command, RST command, or when the error register is read with the IERR or ERR? HP-IB command.

Figure 2-6. HP 3326A Status Byte

MASKING THE STATUS BYTE

The HP 3326A MASK command specifies which bits in the status byte will be enabled to generate an SRQ. The MASK command has the syntax of "MASKnPC" where n is an integer number corresponding to the enabled bits in the status byte, and PC is the suffix used to end the command. The integer number is determined by summing the decimal values of the enabled bits in the status byte. Figure 2-6 describes the HP 3326A status byte and lists the decimal value of each bit position. The require service bit (bit 6) cannot be disabled.

CHAPTER 3
HP 3326A HP-IB COMMANDS

Chapter 3 — Table of Contents

REMOTE FRONT PANEL OPERATION	3-1
COMMAND SYNTAX	3-1
BUS MODES	3-3
VIEWING THE HP 3326A HP-IB ADDRESS	3-3
CHANGING THE HP 3326A HP-IB ADDRESS	3-4
INTERROGATING THE HP 3326A FOR SETUP PARAMETERS	3-4
DISPLAYING THE HP 3326A SETUP PARAMETERS	3-4
MODIFYING PARAMETERS	3-5
DISPLAY CONTROL	3-6
SAVING OR RESTORING AN HP 3326A SETUP	3-6
HP 3326A IDENTIFICATION	3-7
TRIGGERED SWEEPS	3-8
READING AND MASKING THE STATUS BYTE	3-8
ERROR CODES	3-10
HP 3325A COMPATIBILITY	3-12
UNITS	3-13
HP 3326A MNEMONICS SUMMARIES	3-14

HP 3326A HP-IB COMMANDS

The commands for operating the HP 3326A remotely through the HP-IB are listed in this chapter. A complete HP 3326A HP-IB command summary is located at the end of this chapter. HP-IB commands corresponding to front panel keys are described in Chapter 1, Operator's Introduction. Commands used exclusively for HP-IB operation are described in this chapter. For an introduction to programming with the HP 3326A HP-IB commands, refer to the HP 3326A Introductory Operating Guide.

REMOTE FRONT PANEL OPERATION

Many of the HP-IB functions are the remote equivalent of manually pressing a front panel key and are executed in similar sequences. The major differences are for the front panel keys accessed by pressing the blue SHIFT key. These keys have their own HP-IB commands.

The HP-IB REMOTE status light, located in the HP-IB STATUS block on the left side of the front panel, indicates whether the instrument is currently operating under local (front panel control) or remote control. Remote operation is accomplished only via commands transmitted through the HP-IB.

NOTE

The REMOTE indicator on the HP 3326A can be used for a quick operational check of the HP-IB. Refer to the Controller Operating Manual for a description of the HP-IB REMOTE message. When this message is sent to the HP 3326A, the REMOTE indicator should illuminate. If this does not occur, check the cabling, the HP 3326A address, and the syntax of the controller statement.

When the HP 3326A is in local, the operation is determined solely by front panel key operation. Programming the HP 3326A to remote does not alter the current operating state. The commands sent over the HP-IB change the state of the HP 3326A. Returning to local, either by pressing the LOCAL key (if local lockout is not in effect), or by an HP-IB command, causes the HP 3326A to return to front panel control without changing the operating state.

COMMAND SYNTAX

The HP 3326A Mnemonic Summary, HP-IB Only Mnemonic Summary, and Alphabetic HP 3326A Mnemonic Summary at the end of this chapter list the HP 3326A HP-IB commands. The HP 3326A Mnemonic Summary segments the HP-IB commands into groups related to the front panel key operations. The HP-IB Only Mnemonic Summary lists the HP-IB only commands in groups of related operations. The Alphabetic HP 3326A Mnemonic Summary contains a complete alphabetic list of HP-IB commands. For an

HP-IB command requiring a range value or a suffix, the applicable range limit and suffix are also listed. The following conventions apply to the HP 3326A HP-IB commands:

- The HP 3326A accepts data in seven bit ASCII code and ignores the eighth (parity) bit.
- All characters other than A through Z, a through z, 0 through 9, plus (+), minus (–), period (.), question mark (?), and pound sign (#) are treated as command separators. Command separators may not be embedded in an HP-IB command mnemonic.
- Two successive HP 3326A HP-IB commands must be separated by a command separator, or the last character of the first command may be sent with EOI.
- Range values may be in integer, real, or exponential form. For positive values, only the first eleven digits of the mantissa are used. For negative values, only the first ten digits of the mantissa are used. Leading zeros before the decimal point are ignored.
- An HP-IB mnemonic must precede any setup data or suffix.
- After information is requested from the HP 3326A, the HP 3326A responds with the information when it is addressed to talk.

The HP 3326A uses the following forms for HP-IB commands:

COMMAND FORM	EXAMPLE	EXAMPLE DESCRIPTION
Mnemonic EOS	“CHA”	Channel A
Mnemonic Suffix EOS	“FCNA SIN”	Sine function for channel A
Mnemonic Data EOS	“HVA 0”	High voltage off
Mnemonic Range data Suffix EOS	“AM 1 VO”	Amplitude of 1 Vrms
Mnemonic ? EOS	“FR?”	Interrogate frequency

where:

- mnemonic is the HP-IB mnemonic
- EOS indicates the end of string marker (a command separator, typically the carriage return and line feed supplied by the controller)
- suffix is an alphabetic code for units, function, or mode
- data is a numeric code for a function or mode
- range data is the value for an entry parameter
- ? is used to interrogate the HP 3326A.

A program string for the HP 3326A may contain multiple HP-IB commands such as “CHA FCNA SIN HVA0 AM1VO FR?” For a program string, a command separator (in this example, a space) is required between HP-IB commands.

BUS MODES

The HP 3326A accepts data and commands from the HP-IB in either of two modes: bus mode 1 or bus mode 2. Bus mode 1 is the default operating mode for the HP 3326A. Bus mode 2 should be used if speed of communications is a critical factor in the HP-IB system.

BUSM1

In BUSM1 (BUS Mode 1), the default operating mode, the HP 3326A processes one character (byte) at a time. That is, the controller must wait for the HP 3326A to finish processing a previously accepted character before the HP 3326A will accept an additional character in the command.

NOTE

In bus mode 1, the HP 3326A buffers up to three characters. If a measurement sequence is started immediately after issuing a command to the HP 3326A, the HP 3326A may not have finished processing the last command. To check if the HP 3326A command processing is complete, monitor the ready bit in the status byte with a serial poll, or mask the status byte ready bit and monitor the SRQ line. An alternate approach to check the status of command processing is to issue the command WAIT. The HP 3326A does not finish the handshake on the command WAIT until the last character is accepted. This insures that the previous command has been processed.

BUSM2

When BUSM2 (BUS Mode 2) is in effect, the HP 3326A buffers up to 100 characters of HP-IB data. While the buffered characters are being processed, the controller can communicate with other devices on the bus. If the buffer becomes full, the HP 3326A does not complete the HP-IB handshake (i.e. delays the controller) and will not accept additional characters until all the buffered characters are processed. To check if the HP 3326A command processing is complete, monitor the ready bit in the status byte with a serial poll, or mask the status byte ready bit and monitor the SRQ line.

VIEWING THE HP 3326A HP-IB ADDRESS

The HP-IB address of the HP 3326A is stored in nonvolatile memory (there are no address switches). The HP 3326A address appears in the display when the BUS ADDRESS key in the HP-IB STATUS block is pressed. The BUS ADDRESS key is selected by pressing the blue SHIFT key followed by the LOCAL key. The HP 3326A address is removed from the display by pressing another key that requires the display.

CHANGING THE HP 3326A HP-IB ADDRESS

The HP 3326A address can be set at any address between 0 and 30, inclusive. The HP-IB address of the HP 3326A is set to 18 at the factory and stored in nonvolatile memory. When selecting an address, remember that the controller also has an address (usually 21).

To change the HP-IB address:

- Press the blue SHIFT key followed by the LOCAL key in the HP-IB STATUS block to display the HP-IB address.
- Enter the address with the numeric keypad. For two digit HP-IB addresses, the address is set when the second digit is entered. For single digit HP-IB addresses, the address is set when any units key is pressed. Alternately, a zero can precede the single digit to form a two digit address.

NOTE

The HP-IB address is reset to 18 after a memory clear operation.

- The message "Error 20 RNGE" is displayed if the HP-IB address exceeds 30.

INTERROGATING THE HP 3326A FOR SETUP PARAMETERS

The value of a setup parameter is read over the HP-IB by sending the parameter HP-IB mnemonic followed by a question mark (?). The HP-IB command summary table lists the parameters that can be interrogated and the form of the response. For example, sending the mnemonic FR? sets up the HP 3326A to respond with the frequency value for the selected channel. The frequency value is transmitted when the HP 3326A is addressed to talk. Each value is returned with units.

The HP 3326A always responds with the units Hertz for frequency values, volts peak-to-peak for amplitude values, seconds for time values, volts dc for offset values, degrees for phase, and percent for duty cycle. The HP 3326A responds with either percent or degrees for modulation level. Each interrogation response ends with a carriage return (ASCII 13) and line feed (ASCII 10) character.

DISPLAYING THE HP 3326A SETUP PARAMETERS

The current value for a setup parameter is displayed on the HP 3326A front panel if the corresponding HP-IB mnemonic is sent without data and a suffix. For example, sending the mnemonic AM displays the amplitude value for the selected channel but does not change the amplitude value.

The units for the displayed value of a setup parameter change to new units if the corresponding HP-IB mnemonic and new suffix are sent without data. For example, sending the mnemonic AM DBV displays the current amplitude value in dBV for the selected channel. Sending the AM DBV command does not change the amplitude value.

NOTE

If the display is disabled with the DSP0 or DSP OFF command, the requested value is not displayed.

MODIFYING PARAMETERS

The HP 3326A modify functions are implemented over the HP-IB with the EINC (Entry INCrement), UP, and DN (Down) HP-IB commands. The TDN (Trigger Down) and TUP (Trigger UP) HP-IB commands enable the HP 3326A to increment or decrement the display value whenever a trigger is received. The front panel modify controls are enabled (for local operation) and disabled with the MFY (ModiFY) command.

EINC

The amount to increment or decrement the display value is set with the EINC (Entry INCrement) HP-IB command. The EINC command includes a positive range value and a suffix applicable for the value to be modified. Values entered with the EINC command apply only to the UP, DN, TUP, and TDN HP-IB commands. Only one EINC value is stored internally by the HP 3326A. An error is generated if the display is incremented or decremented and the EINC command suffix is not compatible with the units of the displayed value. An example of the EINC command is EINC10.2KHZ.

MFY0 or MFY OFF

The MFY0 (ModiFY) or MFY OFF command disables the front panel modify controls and inhibits the flashing digit on the front panel display.

MFY1 or MFY ON

The MFY1 (ModiFY) or MFY ON command enables the front panel modify controls. The HP 3326A must be put into local before the HP 3326A accepts changes through the modify controls.

TUP and TDN

The TUP (Trigger UP) and TDN (Trigger Down) HP-IB commands enable the HP 3326A to increment or decrement the display value by the increment set with the EINC mnemonic whenever a trigger is received. The HP 3326A responds to either a trigger applied through the rear panel EXT TRIG (EXTernal TRIGger) connector, or to the HP-IB group execute trigger command. The TUP and TDN commands do not require a range value or suffix.

TOFF

The TOFF (Trigger OFF) command disables trigger operations on the HP 3326A. Trigger operations are enabled when power is applied, after an instrument preset, or with the TDN, TUP, STC, and STS HP-IB commands.

UP and DN

The UP and DN (Down) commands increment and decrement the display value by the increment set with the EINC mnemonic. The UP and DN commands do not require a range value or suffix.

DISPLAY CONTROL

DISP0 or DISP OFF

The DISP0 (DISPlay) or DISP OFF command inhibits the HP 3326A from displaying setup values on the front panel display. While the display is disabled, DISP OFF (diSPay OFF) appears in the display and all front panel indicators (except the HP-IB Status) are extinguished. The display is returned to normal with the DISP1 or DISP ON command.

NOTE

If the HP 3326A is returned to local with the display disabled, the HP 3326A will not respond to the front panel keys. To restore the HP 3326A to front panel operation without a controller, apply power with the shift key depressed (a memory clear operation). A memory clear replaces the contents of the nonvolatile memory with preset state setup data, and changes the HP-IB address to 18.

DISP1 or DISP ON

The DISP1 (DISPlay) or DISP ON command enables the HP 3326A to display setup values on the front panel display. The DISP1 or DISP ON command is necessary only if the HP 3326A display is disabled during HP-IB operation.

SAVING OR RESTORING AN HP 3326A SETUP

The contents of any HP 3326A memory register can be accessed over the HP-IB. The data is transferred over the HP-IB in binary form with the LRN (LeaRN) and PRG (PRoGram) mnemonics. This binary form is useful for storing HP 3326A setup data in external memory for more permanent storage. The SAV (SAVe) mnemonic stores HP 3326A setup data in internal nonvolatile memory, and the RCL (ReCaLI) mnemonic recalls HP 3326A setup data from internal nonvolatile memory.

LRN

The LRN (LeaRN) command, combined with an integer, configures the HP 3326A to transfer the setup data stored in the nonvolatile memory register over the HP-IB. The LRN command has the syntax of LRNn where n ranges from 0 to 9 and represents the nonvolatile memory register to transfer. After the HP 3326A is addressed to talk, the ASCII characters #A followed by two length bytes and 168 bytes of binary data are transmitted by the HP 3326A. The length bytes represent the most significant and least significant bytes of the number of bytes transmitted. The binary transmission is ended with the HP-IB EOI bus management line being asserted on the last byte. Note that the controller must read the data after issuing this command.

PRG

The PRG (PRoGram) command, combined with an integer ranging from 0 to 9, prefaces the 172 bytes of binary setup data to be loaded into the HP 3326A nonvolatile memory. The integer specifies the nonvolatile memory register to receive the binary setup data. The new setup is set after the last data word is received. Data loaded into the HP 3326A must be data output by the LRN command. The received HP-IB data is checked internally to insure data integrity.

RCL

The RCL (ReCaLI) command, combined with an integer, recalls a stored instrument setup from internal memory to the current HP 3326A setup. The RCL command has the syntax of RCLn where n is an integer ranging from 0 to 9 and represents the memory register of the stored the setup data.

SAV

The SAV (SAVe) command, combined with an integer, stores the current HP 3326A setup in internal memory. The SAV command has the syntax of SAVn where n is an integer ranging from 0 to 9 and represents the memory register to receive the setup data.

HP 3326A IDENTIFICATION

ID?

The ID command transmits the HP 3326A identification code (HP3326A) to the remote interface.

REV?

The REV? command transmits a pair of revision date codes (the revision and capability date) for the program stored in the HP 3326A read only memory. The date code pair is transmitted as nnnn,nnnn where nnnn represents each four digit integer. The year since 1960 is represented by the first two digits, and the week is represented by the second two digits in each number.

SER?

The SER? (SERial number) command transmits a ten character string stored in the HP 3326A read only memory. The ten character string has the form of nnnnA0000 where nnnn represents an integer corresponding to the revision date for the HP 3326A software. The year is represented by the first two digits, and the week is represented by the second two digits. The next character in the string is the ASCII character A, and the remaining characters are zeros. The actual serial number of the HP 3326A is not stored in memory.

TRIGGERED SWEEPS

The sweep functions of the HP 3326A operate under trigger control when the STC (Sweep Triggered Continuous) or STS (Sweep Triggered Single) HP-IB commands are in effect. The HP 3326A responds to either a trigger applied through the rear panel EXT TRIG (EXTernal TRIGger) connector or to the HP-IB group execute trigger command. Refer to the controller operating manual for implementation of the group execute trigger command.

STC

The STC (Sweep Triggered Continuous) command enables the HP 3326A to initiate a continuous sweep when a trigger is received. A sweep in progress is stopped after the STC command is issued. The shortest delay ($\leq 10 \mu\text{s}$) between a trigger and sweep start occurs when the trigger is preceded by the SRE (Sweep REset) command.

STS

The STS (Sweep Triggered Single) command enables the HP 3326A to initiate a single sweep when a trigger is received. A sweep in progress is stopped after the STS command is issued. The shortest delay ($\leq 10 \mu\text{s}$) between a trigger and sweep start occurs when a trigger is preceded by the SRE (Sweep REset) command.

TOFF

The TOFF (Trigger OFF) command disables trigger operations on the HP 3326A. Trigger operations are enabled when power is applied, after an instrument preset, or with the TDN, TUP, STC, and STS HP-IB commands.

READING AND MASKING THE STATUS BYTE

The MASK command specifies which bits in the status byte are enabled to generate an SRQ. The status byte is an eight bit word that the HP 3326A outputs when requested by a serial poll. The state of each bit indicates the status of an internal HP 3326A function. A service request is generated when the Boolean AND of the status byte and status byte mask is not equal to zero.

MASK

The MASK command has the syntax of MASKnPC where n is an integer corresponding to the enabled bits in the status byte, and PC is the suffix used to end the command. The integer is determined by summing the decimal values of the enabled bits in the status byte. Figure 3-1 describes the HP 3326A status byte and lists the decimal value of each bit position. The require service bit (bit 6) cannot be disabled and mask programming for this bit is ignored.

Status Byte Bit Numbers: B7 B6 B5 B4 B3 B2 B1 B0

BIT NUMBER	DECIMAL VALUE	DESCRIPTION
B7	128	POWER RESTORED. Set when power is restored to the HP 3326A after power is interrupted. Reset when the HP 3326A is preset or receives a device clear, selected device clear, or RST command.
B6	64	REQUIRE SERVICE. Set when the HP 3326A requires service (sent an SRQ). Cleared when the condition causing the SRQ is removed, or when the HP 3326A is preset or receives a device clear, selected device clear, or RST command.
B5	32	ERROR. Set when either a program or hardware error condition exists for the HP 3326A. Reset when the HP 3326A is preset, or receives a device clear command, selected device clear command, RST command, or when the error register is read with the IERR or ERR? HP-IB command.
B4	16	READY. Set when the HP 3326A has executed the last HP-IB command and is ready for the next command. Reset when the HP 3326A receives a device dependent command, device clear command, selected device clear command, or trigger.
B3	8	HARDWARE ERROR. Set when the HP 3326A detects an internal failure. Reset when the HP 3326A is preset, or receives a device clear command, selected device clear command, RST command, or when the error register is read with the IERR or ERR? HP-IB command.
B2	4	SWEEP START/IN PROGRESS. Set when the HP 3326A starts a sweep. Reset when the sweep is stopped (either by reaching the stop frequency or aborted by a front panel or HP-IB command). It is also reset when the HP 3326A is preset or receives a device clear command, selected device clear command, or RST command.
B1	2	SWEEP STOPPED. Set when the HP 3326A ends a sweep normally. Reset when the HP 3326A is preset or receives a device clear command, selected device clear command, or RST command.
B0	1	PROGRAM ERROR. Set when the HP 3326A receives an invalid HP-IB command (e.g. command syntax or incompatible command for mode selected). Reset with an INSTR PRESET, device clear command, selected device clear command, RST command, or when the error register is read with the IERR or ERR? HP-IB command.

Figure 3-1. HP 3326A Status Byte

Examples: To enable the error bit (bit 5 with a decimal value of 32) to generate an SRQ, send the command MASK32PC. To enable the error bit (bit 5 with a decimal value of 32) and ready bit (bit 4 with a decimal value of 16) to generate an SRQ, send the command MASK48PC where 48 is the sum of 16 plus 32.

ERROR CODES

ERR?

The ERR? command transmits the code for the last error that occurred, resets the error register, and resets the error bits in the status byte. Bit 5 in the status byte is set when either a program error or hardware error occurs. Bit 0 is also set when a program error occurs, and bit 3 is also set when a hardware error occurs. Figure 3-2 summarizes the error codes and Appendix A provides additional detail on the error codes.

CODE	DESCRIPTION
10	HP-IB command has syntax error or contains illegal characters
11	Front panel key pressed while HP 3326A in remote
12	LOCAL key pressed while HP 3326A in local lockout
20	Value entered for selected parameter exceeds valid limits
21	In 2 TONE mode, channel B offset frequency greater than 100 kHz
23	Discrete frequency sweep element save nonsequential with existing elements, or instrument state save breaks continuity of discrete frequency elements
24	Marker frequency entered is outside sweep span
25	Frequency value greater than 1 MHz entered with high voltage option active
26	Frequency value greater than 5 kHz entered with internal PM active, or greater than 100 kHz with internal AM active
30	In 2 TONE mode with channel B high voltage option enabled, channel B frequency cannot track change to channel A frequency
40	Value that cannot be displayed has been interrogated over the HP-IB
46	Internal modulation enabled and Channel B amplitude or offset selected as display value
47	Channel B phase selected as display value when PULSE mode enabled
50	Units conversion results in zero display value
60	Units key or suffix used improper for parameter selected

Figure 3-2. Error Messages

65	High voltage option enabled and dBm selected as units
70	Increment value or units incompatible with displayed value
80	Combined operation selected but not enabled because current amplitude value is too large, or amplitude modulation selected but not enabled because current amplitude and offset values are too large.
86	Combined operation selected but not enabled because Internal AM or PM is enabled
87	2 CHANNEL mode — synchronous PM is selected but not enabled 2 PHASE or 2 TONE mode — internal AM or PM is selected but not enabled — external PM is selected but not enabled PULSE mode — sine wave or dc only output is selected but not enabled (HP-IB) — combined operation is selected but not enabled — zero phase cannot be assigned to channel B — channel B phase offset cannot be cleared — internal AM or PM is selected but not enabled — external PM is selected but not enabled
88	Internal PM selected with channel B frequency greater than 5 kHz, or internal AM selected with channel B frequency greater than 100 kHz, or sweeping above these frequencies with AM or PM selected.
89	Combined operation selected but not enabled because AM or PM enabled
90	Frequency sweep start and stop frequencies are equal for both channels
94	Pulse duty cycle too narrow for sweep range
95	High voltage option enabled and sweep frequency is greater than 1 MHz
96	Channel B frequency exceeds 5 kHz internal PM limit or 100 kHz internal AM limit during sweep
100	Sweep rate less than 5 mHz/s or greater than 0.5 MHz/ms
110	No discrete frequency sweep elements exist for discrete frequency sweep
114	Frequency too high for duty cycle requested during discrete frequency sweep
115	High voltage option enabled and discrete frequency sweep element frequency exceeds 1 MHz
116	Channel B frequency exceeds 5 kHz internal PM limit or 100 kHz internal AM limit during discrete frequency sweep
117	Discrete frequency elements in memory incompatible with selected mode
120	Cannot clear channel A phase offset
130	High voltage option selected and not installed
136	Channel B high voltage option selected with internal modulation

Figure 3-2. Error Messages (Cont.)

138	High voltage option selected and frequency is greater than 1 MHz; or frequency sweeps above 1 MHz; or combiner enabled with frequency of either channel above 1 MHz.
140	A checksum error for recall, learn, or program operation
150	Current instrument configuration incompatible with recalled or programmed state
160	Error detected in an instrument state recalled from memory; instrument state replaced with preset state
170	Channel A output overloaded
171	Channel B output overloaded
172	SYNC A output overloaded
173	Channel A voltage controlled oscillator unlocked
174	Channel B voltage controlled oscillator unlocked
180	HP 3326A cannot lock to external reference signal that is present
190	Unsuccessful internal AM or PM calibration
191	Unsuccessful phase calibration
192	Unsuccessful amplitude calibration
193	Unsuccessful dc offset calibration
194	Unsuccessful residual dc offset calibration

Figure 3-2. Error Messages (Cont.)

HP 3325A COMPATIBILITY

For compatibility with existing programs, the HP 3326A supports many of the HP 3325A Synthesizer/Function Generator HP-IB commands. The major changes required in adapting an HP 3325A program for HP 3326A operation are adding the CHA or CHB command to specify the affected channel of the HP 3326A, and reducing frequency values greater than 13 MHz. Figure 3-3 lists the mnemonics unique to HP 3325A that are recognized by the HP 3326A. For HP 3325A compatibility, the HP 3326A also recognizes interrogations for entered values that have the letter I preceding the mnemonic.

HP 3325A COMMAND	HP 3326A COMMAND	DESCRIPTION
AC	CAL	Calibrate
AP	ZPH	Zero phase
DB	DBM	
DE	DEG	Degrees
ER	ERR	Error interrogation
FU	FCNA, B	Function (FU1 and FU2 from HP 3325A only)
HV	HVA, HVB	High voltage option
KH	KHZ	Kilohertz
MA	AEA, BEA	External AM for the selected channel
MD	BUSM	Bus mode
MH	MHZ	Megahertz
MP	AEP, BEP	External PM for the selected channel
MR	none	Millivolts rms
MV	none	Millivolts
RE	RCL	Recall
SE	SEC	Seconds
SR	SAV	Save
TE	TST	Self test
TI	STIM	Sweep time
VR	VRMS	Volts rms

Figure 3-3. HP 3325A Supported Commands

UNITS

Figure 3-4 lists the units used with the HP-IB mnemonics.

SUFFIX	DESCRIPTION
DBM	dBm: dB with respect to 1 milliwatt with 50 Ω impedance
DBV	dBV: dB with respect to 1 Volt rms
DEG	Degrees
HZ	Hertz
KHZ	Kilohertz
MHZ	Megahertz
MS	Milliseconds
PC	Percent
SEC	Seconds
VO	Volts peak-to-peak for amplitude, volts dc for dc offset.
VRMS	Volts rms for amplitude

Figure 3-4. Units Used With HP-IB Mnemonics

HP 3326A HP-IB MNEMONICS SUMMARIES

The HP 3326A mnemonic summaries list the HP 3326A HP-IB commands. Entries in the mnemonic, range, and suffix columns are listed in the order used in an HP-IB command. In each case the mnemonic is required. If either a range value or suffix is required to complete a command, it is listed following the mnemonic. Units listed in the range column are for reference. The applicable units for a mnemonic and range value appear in the suffix column.

NOTE

The listed range values are set by the preset state. These values vary as a result of the HP 3326A functions and options selected. Frequency range is changed by internal modulation, high voltage option and two-tone mode. Output amplitude range is changed with the selection of DC OFFSET, combiner, and high voltage option. DC OFFSET is changed with the selection of function, combiner, high voltage option, and amplitude.

The interrogation response column lists the form of the response after interrogating the HP 3326A. To interrogate the HP 3326A for a setup value, issue only the HP-IB mnemonic followed by a question mark (?). Sending an HP-IB mnemonic and question mark for a function that does not respond to an interrogation generates an HP-IB syntax error. The # in the interrogation response represents a decimal digit and does not appear in the interrogation response. The HP 3326A transmits the interrogation response when it is addressed to talk.

The description column lists a short description of the HP-IB command function, the syntax of the command string, and applicable resolution for the range.

HP 3326A HP-IB MNEMONIC SUMMARY

Front Panel Control	Mnemonic	Range	Suffix	Interrogation Response	Description Resolution Syntax	
CALIBRATION BLOCK	AUTO	ACAL	0-1	—	ACAL#	AutoCALibration Syntax: "ACAL0" "ACAL OFF"
		or ACAL	—	OFF, ON		
	MANUAL	CAL	—	—	CALibrate Syntax: "CAL"	

SELECT	CMD or CMD	1 —	— INT	—	—	Calibration MoDe - INTernal Syntax: "CMD1" "CMD INT"
	CMD or CMD	2 —	— EXT	—	—	Calibration MoDe - EXTernal Syntax: "CMD1" "CMD EXT"
	CMD or CMD	3 —	— MULT	—	—	Calibration MoDe - MULTiphase Syntax: "CMD3" "CMD MULT"
SELF TEST	TST	—	—	#####	—	self TeST, each # = P or F for Pass or Fail Syntax: "TST"

ENTRY BLOCK

AMPTD	AM	0-10 V	VO, VRMS, DBM, DBV	AM ±#.###E ±##VO	AMplitude Resolution: 1 mV p-p Syntax: "AM1.125VRMS"
ASGN ZERO φ	ZPH	—	—	—	Zero PHase Syntax: "ZPH"
CLR φ OFS	COF	—	—	—	Clear phase Offset Syntax: "COF"
DC OFFSET	OF	± 5 V	VO	OF ±#.###E ±##VO	Offset Resolution: 10 mV Syntax: "OF3.02VO"
FREQ	FR	0-13 MHz	HZ, KHZ, MHZ	FR #####.#####HZ or FR #####.###HZ	FRequency Resolution: 1 μHz < 100 kHz 1 mHz ≥ 100 kHz Syntax: "FR7.5MHZ"
PHASE	PH	± 720°	DEG	PH ±#.###E ±##DEG	PHase Resolution: 0.01° Syntax: "PH180.05DEG"
DUTY CYCLE	DUTY	1-99%	PC	DUTY#.###E ±##PC	DUTY cycle Resolution: 0.01 % Syntax: "DUTY25.50PC"
% AM/ PM DEV	ML or ML	0-100% 0-360°	PC DEG	ML ±#.###E ±##PC or ML ±#.###E ±##DEG	Modulation Level Resolution: 0.1 % 1° Syntax: "ML30.5PC"

**FUNCTION
BLOCK**

CHA	FCNA	0	—	—	FunCtioN channel A OFF
	or FCNA	—	OFF		Syntax: "FCNAO" "FCNA OFF"
	FCNA	1	—	—	FunCtioN channel A SINe
	or FCNA	—	SIN		Syntax: "FCNA1" "FCNA SIN"
CH A HV	FCNA	2	—	—	FunCtioN channel A SQuaRe
	or FCNA	—	SQR		Syntax: "FCNA2" "FCNA SQR"
	FCNA	3	—	—	FunCtioN channel A DC
	or FCNA	—	DC		Syntax: "FCNA3" "FCNA DC"
CH A HV	HVA	0-1	—	—	High Voltage channel A
	or HVA	—	OFF, ON		Syntax: "HVA1" "HVA ON"
CHB	FCNB	0	—	—	FunCtioN channel B OFF
	or FCNB	—	OFF		Syntax: "FCNBO" "FCNB OFF"
	FCNB	1	—	—	FunCtioN channel B SINe
	or FCNB	—	SIN		Syntax: "FCNB1" "FCNB SIN"
CH B HV	FCNB	2	—	—	FunCtioN channel B SQuaRe
	or FCNB	—	SQR		Syntax: "FCNB2" "FCNB SQR"
	FCNB	3	—	—	FunCtioN channel B DC
	or FCNB	—	DC		Syntax: "FCNB3" "FCNB DC"
CH B HV	HVB	0-1	—	—	High Voltage channel B
	or HVB	—	OFF, ON		Syntax: "HVB1" "HVB ON"

INSTR STATE BLOCK

INSTR PRESET	RST	—	—	—	ReSeT Syntax: "RST"
RCL DISCRETE	DRCL	00-62	—	—	Discrete ReCaLI Syntax: "DRCL02"
RECALL	RCL	0-9	—	—	ReCaLI Syntax: "RCL3"
CLR DISCRETE	CLR	—	—	—	Discrete sweep CLear Syntax: "DCLR"
SAVE	SAV	0-9	—	—	SAVe Syntax: "SAV3"
SAVE DISCRETE	DSAV	00-62	—	—	Discrete SAVe Syntax: "DSAV02"

MODE BLOCK

COMBINED	CMB	0-1	—	—	CoMBiner Syntax: "CMB1" "CMB ON"
	or CMB	—	OFF, ON		
MODE	MODE	1	—	—	MODE TWO Channel Syntax: "MODE1" "MODE TWOC"
	or MODE	—	TWOC		
	MODE	2	—	—	MODE TWO Phase Syntax: "MODE2" "MODE TWOP"
	or MODE	—	TWOP		
	MODE	3	—	—	MODE TWO Tone Syntax: "MODE3" "MODE TWOT"
or MODE	—	TWOT			
MODE	4	—	—	MODE PULSe Syntax: "MODE4" "MODE PULS"	
or MODE	—	PULS			

MODIFY BLOCK

ON/OFF	MFY	0-1	—	—	front panel ModIFy control Syntax: "MFY1" "MFY ON"
	or MFY	—	OFF, ON		

MODULATION BLOCK

CH A	AEA or AEA	0-1 —	— OFF, ON	—	Channel A External Amplitude modulation Syntax: "AEA1" "AEA ON"
	AEP or AEP	0-1 —	— OFF, ON	—	Channel A External Phase modulation Syntax: "AEP1" "AEP ON"
	AIA or AIA	0-1 —	— OFF, ON	—	Channel A Internal Amplitude modulation Syntax: "AIA1" "AIA ON"
	AIP or AIP	0-1 —	— OFF, ON	—	Channel A Internal Phase modulation Syntax: "AIP1" "AIP ON"
	SPE or SPE	0-1 —	— OFF, ON	—	Synchronous Phase modulation External Syntax: "SPE1" "SPE ON"
	CH B	BEA or BEA	0-1 —	— OFF, ON	—
BEP or BEP		0-1 —	— OFF, ON	—	Channel B External Phase modulation Syntax: "BEP1" "BEP ON"
none		NOM	—	—	NO Modulation Syntax: "NOM"

STATUS BLOCK

CHAN	CHA	—	—	—	select CHannel A Syntax: "CHA"
	CHB	—	—	—	select CHannel B Syntax: "CHB"

SWEEP BLOCK

CONT	SC	—	—	—	Sweep, Continuous Syntax: "SC"
CNTR FREQ	CF	0-13 MHz	HZ, KHZ, MHZ	CF #####.#####HZ or CF #####.###HZ	Center Frequency Resolution: 1 μ Hz < 100 kHz 1 mHz \geq 100 kHz Syntax: "CF10KHZ"

DISCRETE	SM or SM	3 —	— DSCR	—	Sweep Mode - DiSCReTe Syntax: "SM3" "SM DSCR"
MKR FREQ	MF	0-13 MHz	HZ, KHZ, MHZ	MF #####.#####HZ or MF #####.###HZ	Marker Frequency Resolution: 1 μ Hz < 100 kHz 1 mHz \geq 100 kHz Syntax: "MF8.0MHZ"
MKR-> CF	CFM	—	—	—	Center Frequency from Marker Syntax: "CFM"
RESET SWP	SRE	—	—	—	Sweep REset Syntax: "SRE"
SINGLE	SS	—	—	—	Sweep Single Syntax: "SS"
SPAN	SPAN	0-13 MHz	HZ, KHZ, MHZ	SPAN#####.#####HZ or SPAN#####.###HZ	sweep frequency SPAN Resolution: 1 μ Hz < 100 kHz 1 mHz \geq 100 kHz Syntax: "SPAN10MHZ"
START FREQ	ST	0-13 MHz	HZ, KHZ, MHZ	ST #####.#####HZ or ST #####.###HZ	STart frequency Resolution: 1 μ Hz < 100 kHz 1 mHz \geq 100 kHz Syntax: "ST3.567891KHZ"
STOP FREQ	SP	0-13 MHz	HZ, KHZ, MHZ	SP #####.#####HZ or SP #####.###HZ	StoP frequency Resolution: 1 μ Hz < 100 kHz 1 mHz \geq 100 kHz Syntax: "SP7.1E6HZ"
TIME	STIM	5 ms-1000 s	SEC, MS	STIM \pm #.#####E \pm ##SEC	Sweep TIME Resolution: 1 MS Syntax: "STIM.3MS"
TRIANGLE	SM or SM	1 —	— RAMP	—	Sweep Mode - linear RAMP Syntax: "SM1" "SM RAMP"
	SM or SM	2 —	— TRGL	—	Sweep Mode - linear TRianGLe Syntax: "SM2" "SM TRGL"

HP-IB ONLY MNEMONIC SUMMARY

BUS MODES

BUSM	1-2	—	—	BUS Mode Syntax: "BUSM2"
WAIT	—	—	—	no operation Syntax: "WAIT"

DISPLAY CONTROL

DISP or DISP	0-1	—	—	DISPlay control Syntax: "DISP1" "DISP ON"
	—	OFF, ON		

ERROR CODES

ERR?	—	—	ERR ###	ERRor code Syntax: "ERR?"
------	---	---	---------	------------------------------

HP 3326A IDENTIFICATION

ID?	—	—	HP3326A	IDentification Syntax: "ID?"
RDY?	—	—	0	ReaDY Syntax: "RDY?"
REV?	—	—	####,####	REVision Syntax: "REV?"
SER?	—	—	####A00000	SERial number Syntax: "SER?"

MODIFYING PARAMETERS

DN	—	—	—	Down increment by EINC value Syntax: "DN"
EINC	see description	—	—	Entry INCrement for UP, DN, TUP, and TDN commands Use increment resolution and suffix appropriate for entry value modified Syntax: "EINC1HZ" "EINC.1VRMS"
UP	—	—	—	UP increment by EINC value Syntax: "UP"

READING AND MASKING THE STATUS BYTE

MASK	0-255	PC	MASK###PC	srq MASK (weighted binary sum of bit positions) Syntax: "MASK32PC"
------	-------	----	-----------	---

SAVING OR RESTORING AN HP 3326A SETUP

LRN	0-9	—	—	LeaRN (read) nonvolatile memory Syntax: "LRN3"
PRG	0-9	—	—	ProGram (restore) nonvolatile memory Syntax: "PRG3"

TRIGGERED OPERATION

STC	—	—	—	Sweep Triggered Continuous Syntax: "STC"
STS	—	—	—	Sweep Triggered Single Syntax: "STS"
TDN	—	—	—	Trigger Down increment by EINC amount Syntax: "TDN"
TOFF	—	—	—	Trigger OFF Syntax: "TOFF"
TUP	—	—	—	Trigger UP increment by EINC amount Syntax: "TUP"

ALPHABETIC LISTING OF HP-IB MNEMONICS

Mnemonic	Range	Suffix	Front Panel Control	Description Resolution Syntax
ACAL	0-1 or —	— OFF, ON	AUTO	AutoCALibration Syntax: "ACALO" "ACAL OFF"
AEA	0-1 or —	— OFF, ON	CH A	Channel A External Am Syntax: "AEA1" "AEA ON"
AEP	0-1 or —	— OFF, ON	CH A	Channel A External Pm Syntax: "AEP1" "AEP ON"
AIA	0-1 or —	— OFF, ON	CH A	Channel A Internal Am Syntax: "AIA1" "AIA ON"
AIP	0-1 or —	— OFF, ON	CH A	Channel A Internal Pm Syntax: "AIP1" "AIP ON"
AM	0-10 V	VO, VRMS, DBM, DBV	AMPTD	AMplitude Resolution: 1 mVpp Syntax: "AM1.125VO"
BEA	0-1 or —	— OFF, ON	CH B	Channel B External Am Syntax: "BEA1" "BEA ON"
BEP	0-1 or —	— OFF, ON	CH B	Channel B External Pm Syntax: "BEP1" "BEP ON"
BUSM	1-2	—	none	BUS Mode Syntax: "BUSM2"
CAL	—	—	MANUAL	CALibrate Syntax: "CAL"
CF	0-13 MHz	HZ, KHZ, MHZ	CNTR FREQ	Center Frequency Resolution: 1 μ Hz < 100 kHz 1 mHz \geq 100 kHz Syntax: "CF10KHZ"
CFM	—	—	MKR->CF	Center Frequency from Marker Syntax: "CFM"

CHA	—	—	CHAN	select CHannel A Syntax: "CHA"
CHB	—	—	CHAN	select CHannel B Syntax: "CHB"
CMB	0-1 or —	— OFF, ON	COMBINED	CoMBiner Syntax: "CMB1" "CMB ON"
CMD	1 or —	— INT	SELECT	Calibration MoDe - INTernal Syntax: "CMD1" "CMD INT"
	2 or —	— EXT		Calibration MoDe - EXTernal Syntax: "CMD1" "CMD EXT"
	3 or —	— MULT		Calibration MoDe - MULTiphase Syntax: "CMD3" "CMD MULT"
COF	—	—	CLR ϕ OFS	Clear phase OFset Syntax: "COF"
DBM	—	—	units	DBM
DBV	—	—	units	DBV
DC	—	—	none	suffix DC function output
DCLR	—	—	CLR DISCRETE	Discrete sweep CLear Syntax: "DCLR"
DEG	—	—	units	DEGrees
DN	—	—	none	Down increment by EINC value Syntax: "DN"
DRCL	00-62	—	RCL DISCRETE	Discrete ReCaLI Syntax: "DRCL02"
DSAV	00-62	—	DISCRETE STO	Discrete SAVe Syntax: "DSAV02"
DSCR	—	—		Suffix - DiSCRete Sweep Mode
DISP	0-1 or —	— OFF, ON	none	DISPlay control Syntax: "DISP1" "DISP ON"

DUTY	1-99%	PC	DUTY CYCLE	DUTY cycle Resolution: 0.01% Syntax: "DUTY25.05PC"
EINC	see description		none	Entry INCrement for UP, DN, TUP, and TDN commands Use increment resolution and suffix appropriate for entry value modified Syntax: "EINC1HZ" "EINC.1VRMS"
ERR?	—	—	none	ERRor code Syntax: "ERR?"
EXT	—	—	none	suffix for EXTernal calibration
FCNA	0 or —	— OFF	CHA	FunCtioN channel A OFF Syntax: "FCNA0" "FCNA OFF"
	1 or —	— SIN		FunCtioN channel A SINe Syntax: "FCNA1" "FCNA SIN"
	2 or —	— SQR		FunCtioN channel A SQaRe Syntax: "FCNA2" "FCNA SQR"
	3 or —	— DC		FunCtioN channel A DC Syntax: "FCNA3" "FCNA DC"
FCNB	0 or —	— OFF	CHB	FunCtioN channel B OFF Syntax: "FCNB0" "FCNB OFF"
	1 or —	— SIN		FunCtioN channel B SINe Syntax: "FCNB1" "FCNB SIN"
	2 or —	— SQR		FunCtioN channel B SQaRe Syntax: "FCNB2" "FCNB SQR"
	3 or —	— DC		FunCtioN channel B DC Syntax: "FCNB3" "FCNB DC"

FR	0-13 MHz	HZ, KHZ, MHZ	FREQ	FRequency Resolution: 1 μ Hz < 100 kHz 1 mHz \geq 100 kHz Syntax: "FR7.500003MHZ"
HVA	0-1 or —	— OFF, ON	CH A HV	High Voltage channel A Syntax: "HVA1" "HVA ON"
HVB	0-1 or —	— OFF, ON	CH B HV	High Voltage channel B Syntax: "HVB1" "HVB ON"
HZ	—	—	units	Hertz
ID?	—	—	none	IDentification Syntax: "ID?"
INT	—	—	none	suffix for INTernal calibration
KHZ	—	—	units	KiloHertz
LRN	0-9	—	none	LeaRN (read) nonvolatile memory Syntax: "LRN3"
MASK	0-255	PC	none	srq MASK (weighted binary sum of bit postions) Syntax: "MASK32PC"
MF	0-13MHz	HZ, KHZ, MHZ	MKR FREQ	Marker Frequency Resolution: 1 μ Hz <100 kHz 1 mHz \geq 100 kHz Syntax: "MF8.0MHZ"
MFY	0-1 or —	— OFF, ON	ON/OFF	front panel ModIFy control Syntax: "MFY1" "MFY ON"
MHZ	—	—	units	MegaHertz
ML	0-100% or 0-360°	PC DEG	% AM/PM DEV	Modulation Level Resolution: 0.1% 1° Syntax: "ML30PC"

MODE	1 or —	— TWOC	MODE	MODE TWO Channel Syntax: "MODE1" "MODE TWOC"
	2 or —	— TWOP		MODE TWO Phase Syntax: "MODE2" "MODE TWOP"
	3 or —	— TWOT		MODE TWO Tone Syntax: "MODE3" "MODE TWOT"
	4 or —	— PULS		MODE PULSe Syntax: "MODE4" "MODE PULS"
MS	—	—	units	MilliSeconds
MULT	—	—	none	suffix for MULTiphase calibration
NOM	—	—	none	NO Modulation Syntax: "NOM"
OF	+5 V	VO	DC OFFSET	OFFset Resolution: 10 mV Syntax: "OF3VO"
OFF	—	—	none	suffix to disable function
ON	—	—	none	suffix to enable function
PC	—	—	units	PerCent
PH	+720°	DEG	PHASE	PHase Resolution: 0.01° Syntax: "PH180DEG"
PRG	0-9	—	none	PRoGram (restore) nonvolatile memory Syntax: "PRG3"
PULS	—	—	none	suffix for PULSe mode
RAMP	—	—	none	suffix for RAMP sweep
RCL	0-9	—	RECALL	ReCaLI Syntax: "RCL3"
RDY?	—	—	none	ReaDY Syntax: "RDY?"
REV?	—	—	none	REVision Syntax: "REV?"

RST	—	—	INSTR PRESET	ReSeT Syntax: "RST"
SAV	0-9	—	STORE	SAVe Syntax: "SAV3"
SC	—	—	CONT	Sweep, Continuous Syntax: "SC"
SEC	—	—	units	SEConds
SER?	—	—	none	SERial number Syntax: "SER?"
SIN	—	—		suffix for SINE wave function
SM	1	—	TRIANGLE	Sweep Mode - linear RAMP Syntax: "SM1" "SM RAMP"
	or —	RAMP		
	2 or —	TRGL	TRIANGLE	
3 or —	—	DISCRETE	Sweep Mode - DisCRete Syntax: "SM3" "SM DSCR"	
	DSCR			
SP	0-13 MHz	HZ, KHZ, MHZ	STOP FREQ	StoP frequency Resolution: 1 μ Hz < 100 kHz 1 mHz > = 100 kHz Syntax: "SP7.125MHZ"
SPAN	0-13 MHz	HZ, KHZ, MHZ	SPAN	sweep frequency SPAN Resolution: 1 μ Hz < 100 kHz 1 mHz > = 100 kHz Syntax: "SPAN10.125MHZ"
SPE	0-1	—	CH A	Synchronous Phase modulation External Syntax: "SPE1" "SPE ON"
	or —	OFF, ON		
SQR	—	—	none	suffix for SQuaRe wave function
SRE	—	—	RESET SWP	Sweep REset Syntax: "SRE"
SS	—	—	SINGLE	Sweep Single Syntax: "SS"

ST	0-13 MHz	HZ, KHZ, MHZ	START FREQ	STart frequency Resolution: 1 μ Hz < 100 kHz 1 mHz \geq 100 kHz Syntax: "ST3.5KHZ"
STC	—	—	none	Sweep on Trigger - Continuous Syntax: "STC"
STIM	5 ms-1000 s	SEC, MS	TIME	Sweep TIME Resolution: 1 mS Syntax: "STIM.3S"
STS	—	—	none	Sweep on Trigger - Single Syntax: "STS"
TDN	—	—	none	Trigger Down increment by EINC amount Syntax: "TDN"
TOFF	—	—	none	Trigger OFF Syntax: "TOFF"
TRGL	—	—	suffix	TRianGLE sweep mode
TST	—	—	SELF TEST	self TeST Syntax: "TST"
TUP	—	—	none	Trigger UP increment by EINC amount Syntax: "TUP"
TWOC	—	—	none	suffix for TWO Channel mode
TWOP	—	—	none	suffix for TWO Phase mode
TWOT	—	—	none	suffix for TWO Tone mode
UP	—	—	none	UP increment by EINC value Syntax: "UP"
VO	—	—	units	VOlts peak-to-peak for amplitude. VOlts dc for dc offset.
VRMS	—	—	units	Volts RMS for amplitude
WAIT	—	—	none	no operation Syntax: "WAIT"
ZPH	—	—	ASGN ZERO ϕ	Zero PHase Syntax: "ZPH"

APPENDICES

ERROR MESSAGES AND CODES

The HP 3326A error messages and codes provide information on the operating status of the HP 3326A, and help to establish a setup. Many of the messages and codes exist because of the extensive calibration and self test routines incorporated into the HP 3326A and will not appear during normal operation.

ERROR MESSAGE	CODE	DESCRIPTION
SNTX	10	(HP-IB SyNTaX) An HP-IB command has a syntax error or contains illegal characters. Check program controlling the HP 3326A.
RMOT	11	(ReMOTe) A front panel key is pressed while the HP 3326A is in remote. Return the HP 3326A to local.
LOCK	12	(local LOCKout) The LOCAL key is pressed while the HP 3326A is in local lockout. Disable local lockout and return the HP 3326A to local.
RNGE	20	(RaNGE) Value entered for the selected parameter exceeds the valid limits. Check range limits for last operation:

Frequency

- greater than 13 MHz (13.1 MHz for channel B in 2 TONE mode)

Amplitude

- less than 1 mVpp or greater than 10 Vpp without high voltage option
- less than 4 mV or greater than 40 Vpp with high voltage option enabled
- greater than 10 Vpp with high voltage option disabled
- greater than one half the normal limits with combined operation enabled
- greater than 5 Vpp with amplitude modulation enabled on channel A
- amplitude incompatible with dc offset

NOTE

Amplitude limits for combined operation, amplitude modulation, dc offset, and high voltage option are interdependent. Check the limits for the combination of combined operation, amplitude modulation, dc offset, or high voltage functions selected.

DC Offset

- exceeds ± 20 V with high voltage option enabled
- exceeds ± 5 V without high voltage option
- dc offset incompatible with amplitude
- invalid with combined operation and sine wave or square wave functions

Phase Duty cycle

- exceeds $\pm 1440^\circ$
- less than 1% or greater than 99%
- resulting pulse width less than 20 ns
- during sweep, pulse width less than 20 ns

Modulation level

- less than 0% or greater than 100%
- less than 0° or greater than 360°

Sweep time

- less than 5 ms or greater than 1000 seconds

Bus address

- greater than 30

EINC value

- less than minimum resolution for parameter modified (HP-IB)
- exceeds maximum value for parameter modified (HP-IB)
- units scale EINC value to less than minimum or maximum values (HP-IB)

SRQ MASK range

- greater than 255 (HP-IB)

FCNA or FCNB range

- not equal to 0, 1, 2, or 3 (HP-IB)

MODE range

- not equal to 1, 2, 3, or 4 (HP-IB)

SM range

- not equal to 1, 2, or 3 (HP-IB)

CMD range

- not equal to 1, 2, or 3 (HP-IB)

BUSM range

- not equal to 1 or 2 (HP-IB)

RNGE 21

(RaNGE) In the 2 TONE mode, the channel B offset frequency is greater than 100 kHz. Check the channel B frequency, start frequency, or stop frequency.

RNGE	23	(RaNGE) For a discrete save operation, the discrete frequency sweep element number is nonsequential with existing discrete frequency elements. For an instrument state save operation, the memory selected breaks the continuity of discrete frequency sweep elements. Instrument state saves can only replace the lowest memory location currently used by discrete frequency sweep elements.
RNGE	24	(RaNGE) The requested marker frequency is outside, or at the sweep span. The marker frequency is accepted and this message is displayed to indicate that a marker will not be generated.
RNGE	25	(RaNGE) A frequency value greater than 1 MHz is requested with the high voltage option active. Reduce the frequency value or disable the high voltage option.
RNGE	26	(RaNGE) A channel B frequency value greater than 5 kHz is requested with internal PM active or greater than 100 kHz with internal AM active. Reduce the frequency value or disable internal modulation.
B FR	30	(B FRequence) Channel B frequency in 2 TONE mode cannot track change to channel A frequency because the high voltage option is active. Check that the change to channel A frequency does not cause the channel B frequency to exceed 1 MHz.
INTR	40	(INTeRrogate) A parameter is interrogated over the HP-IB that does not have an interrogation response. Check HP-IB command structure.
INTR	46	(INTeRrogate) The channel B amplitude or offset is selected as the display value when internal modulation is enabled. Channel B amplitude is controlled by the %AM/PM DEV key when internal modulation is enabled.
INTR	47	(INTeRrogate) The channel B phase is selected as the display value when the PULSE mode is enabled. Select alternate entry or change modes.
CNVT	50	(CoNVerTs) The units conversion requested results in a zero display value. For example, converting 0.000001 Hz to MHz would change frequency to dc.
SUFx	60	(SUFfiX) The units key or HP-IB suffix used is improper for the parameter selected. Check consistency of units and parameters.
SUFx	65	(SUFfiX) The high voltage output option is enabled and dBm is selected as units. Change units used for the high voltage option to dBV, VOLTS, or Vrms.
INC	70	(INCrement) The increment value or units used over the HP-IB is incompatible with the displayed value. Check program controlling the HP 3326A.
AMPL	80	(AMPLitude) Combined operation is selected but not enabled because the current amplitude value is too large. Reduce amplitude before selecting combined operation.

MODL	86	(MODuLation) Combined operation is selected but not enabled because Internal AM or PM is enabled. Disable internal modulation prior to selecting combined operation.
MODE	87	(MODE) The requested operation or function is incompatible with the mode selected. Select alternate mode for operation required. 2 CHANNEL mode — synchronous PM is selected but not enabled 2 PHASE or 2 TONE mode — internal AM or PM is selected but not enabled — external PM is selected but not enabled PULSE mode — sine wave or dc only output is selected but not enabled (HP-IB) — combined operation is selected but not enabled — zero phase cannot be assigned to channel B — channel B phase offset cannot be cleared — internal AM or PM is selected but not enabled — external PM is selected but not enabled
FREQ	88	(FREQuency) Channel B frequency is greater than 5 kHz and internal PM is selected, or the channel B frequency is greater than 100 kHz and internal AM is selected. Internal PM or AM is not enabled. Change the channel B frequency prior to enabling modulation.
CMBR	89	(CoMBineR) Combined operation is enabled and AM or PM is selected. AM or PM is not enabled. Disable combined operation prior to selecting modulation.
SWFR	90	(SWeep FREquency) The start and stop frequencies are equal for both channels and a frequency sweep is enabled. This message appears as an advisory that the HP 3326A will not appear to sweep. If a frequency sweep is desired, change the start or stop frequencies.
DUTY	94	(DUTY cycle) The duty cycle of a PULSE is too narrow for a sweep. Reduce the start or stop frequency or, in the PULSE mode, change the duty cycle.
SWFR	95	(SWeep FREquency) The high voltage option is enabled and a frequency sweep start or stop frequency is greater than 1 MHz. Disable the high voltage option or decrease the sweep start or stop frequency.
SWFR	96	(SWeep FREquency) The channel B frequency exceeds the 5 kHz internal PM limit or exceeds the 100 kHz internal AM limit during a sweep. Disable internal modulation or decrease the sweep start or stop frequency.

RATE	100	(RATE) The sweep rate is less than 5 mHz/s or greater than 0.5 MHz/ms. For sweep rates less than 5 mHz/s, decrease the sweep time or increase the difference between the start and stop frequencies. For sweep rates greater than 0.5 MHz/ms, increase the sweep time or decrease the difference between the start and stop frequencies.
DSWP	110	(Discrete frequency SWEEP) A discrete frequency sweep is invalid because no discrete frequency elements are saved in memory. Enter discrete frequency elements (the channel A and B frequencies, and dwell time) through the SAVE DISCRETE key starting with element 00.
DSWP	114	(Discrete frequency SWEEP) A frequency is too high for the duty cycle requested during a discrete frequency sweep. Reduce the discrete frequency sweep element frequency or, in PULSE mode, change the duty cycle.
DSHV	115	(Discrete Sweep High Voltage) The high voltage option is enabled and a discrete frequency element frequency exceeds 1 MHz. Disable the high voltage option or reduce the discrete frequency sweep element frequency.
DSML	116	(Discrete Sweep Modulation) The channel B frequency exceeds the 5 kHz internal PM limit or exceeds the 100 kHz internal AM limit during a discrete frequency sweep. Reduce the discrete frequency sweep element frequency or disable modulation.
DSMD	117	(Discrete Sweep MoDe) The discrete frequency sweep elements in memory are incompatible with the mode selected. For example, discrete frequency elements entered in 2 PHASE mode and current mode is 2 TONE. Change the HP 3326A mode, or enter new discrete frequency elements.
P OF	120	(Phase Offset) The phase offset of channel A cannot be cleared.
H V	130	(High Voltage) The high voltage option is not installed and high voltage is selected.
H V	136	(High Voltage) Channel B high voltage option is selected when internal modulation is enabled. Disable internal modulation prior to enabling high voltage option.
H V	138	(High Voltage) Channel A or channel B high voltage option is selected when the frequency is greater than 1 MHz. Reduce the channel A or B frequency.
CSUM	140	(CheckSUM) A checksum error is detected during a recall, HP-IB learn, or HP-IB program operation. For HP-IB operation, check HP-IB cables, and that instrument state data saved external to the HP 3326A has not changed.
—	150	The current instrument configuration is incompatible with the state recalled or programmed.
CRPT	160	(CoRRuPT) An error is detected in an instrument state at power up. The corrupt instrument state is replaced with the preset state.

A OL	170	(A OverLoad) Channel A output is overloaded. The load impedance for the channel A output is too low, or a voltage source is attached to the channel A output.
B OL	171	(B OverLoad) Channel B output is overloaded. The load impedance for the channel B output is too low, or a voltage source is attached to the channel B output.
SYOL	172	(SYnc OverLoad) The SYNC A output is overloaded. The load impedance attached to the SYNC A output is too low, or a voltage source is attached to the SYNC A output.
AVCO	173	(channel A Voltage Controlled Oscillator) The channel A voltage controlled oscillator is unlocked. This indicates a hardware failure if the message persists.
BVCO	174	(channel B Voltage Controlled Oscillator) The channel B voltage controlled oscillator is unlocked. This indicates a hardware failure if the message persists.
XREF	180	(eXternal REFerence) An external reference signal is available but the HP 3326A cannot lock to it. Check the frequency, level, and stability of the reference signal.
MCAL	190	(Modulation CALibration) An internal AM or PM calibration is unsuccessful and the HP 3326A is unable to calibrate internal circuits. If this message occurs after the HP 3326A is fully warmed-up (30 minutes of operation), the HP 3326A may require repair or adjustment to meet specifications.
PCAL	191	(Phase CALibration) A phase calibration is unsuccessful and the HP 3326A is unable to calibrate internal circuits. If this message occurs after the HP 3326A is fully warmed-up (30 minutes of operation), the HP 3326A may require repair or adjustment to meet specifications.
ACAL	192	(Amplitude CALibration) An amplitude calibration is unsuccessful and the HP 3326A is unable to calibrate internal circuits. If this message occurs after the HP 3326A is fully warmed-up (30 minutes of operation), the HP 3326A may require repair or adjustment to meet specifications.
OCAL	193	(Offset CALibration) A dc offset calibration is unsuccessful and the HP 3326A is unable to calibrate internal circuits. If this message occurs after the HP 3326A is fully warmed-up (30 minutes of operation), the HP 3326A may require repair or adjustment to meet specifications.
OCAL	194	(Offset CALibration) A residual dc offset calibration is unsuccessful and the HP 3326A is unable to calibrate internal circuits. If this message occurs after the HP 3326A is fully warmed-up (30 minutes of operation), the HP 3326A may require repair or adjustment to meet specifications.
PASS	—	A self test has completed successfully.
FAIL	—	A self test is unsuccessful. This indicates a hardware failure if the message persists.

APPENDIX B

SPECIFICATIONS

Unless otherwise stated, the following specifications apply to the Channel A and Channel B outputs in all modes, with the internal combiner and all modulation off, and outputs terminated in 50 ohms. For tabular data, specifications apply at and above the stated frequency or amplitude range.

Specifications describe the instrument's warranted performance after a warm-up period of 30 minutes (except where noted). SUPPLEMENTAL CHARACTERISTICS are intended to provide information useful in applying the instrument by giving typical, but non-warranted, performance parameters. Supplemental characteristics are denoted as *typical*, *nominal*, or *approximate*.

MODES

TWO-CHANNEL: Channels A and B are independent.

TWO-PHASE: Channels A and B are the same frequency, with a calibrated phase difference between them.

TWO-TONE: Channel B frequency must be within 100 kHz of the Channel A frequency.

PULSE: Channel B is the complement of the Channel A output.

WAVEFORMS

Sine, Square, Pulse and DC.

FREQUENCY

RANGE: DC to 13 MHz.

RESOLUTION: 1 μ Hz below 100 kHz, 1 mHz at or above 100 kHz.

ACCURACY: $\pm 5 \times 10^{-6}$ of selected value, 20°C to 30°C, at time of frequency reference calibration with standard instrument.

STABILITY: $\pm 5 \times 10^{-6}$ /year, 20°C to 30°C, with standard instrument.

MAIN SIGNAL OUTPUTS (Channels A and B, all waveforms unless noted)

IMPEDANCE: 50 Ω \pm 1 Ω , DC to 100 kHz.

RETURN LOSS: > 20 dB, 100 kHz to 13 MHz.

CHANNEL ISOLATION: > 80 dB below the larger signal, or < -90 dBm, whichever is greater, 10 Hz to 13 MHz, sine wave only, Two-Channel and Two-Tone modes. For square wave and DC, *typically* > 80 dB to 5 MHz, *typically* > 65 dB to 13 MHz.

CONNECTOR: Front panel BNC (rear panel if Option 003).

FLOATING: Both outputs share the same ground and may be floated up to ± 42 V peak (AC & DC).

AC AMPLITUDE (All Waveforms)

RANGE (WITHOUT DC OFFSET):

Units Displayed	Function			
	Sine		Square & Pulse	
	min	max	min	max
peak-to-peak	1.000 mV	10.00 V	1.000 mV	10.00 V
rms	0.354 mV	3.54 V	0.500 mV	5.00 V
dBm(50 Ω)	-56.02	+23.98	-53.01	+26.99
dBV	-69.03	+10.97	-66.02	+13.98

RESOLUTION: 4 digits, or approximately 0.1% of value for peak-to-peak entry, 0.3% of value for rms entry, and 0.01 dB for dBm or dBV entry.

ACCURACY: Relative to selected value after performing self-calibration.

Sine Wave:

	0.001 Hz	100 kHz	1 MHz	13 MHz
+ 23.98 dBm	± 0.1 dB	± 0.3 dB	± 0.6 dB	± 0.6 dB
+ 3.98 dBm			± 0.8 dB	± 1.0 dB
- 36.02 dBm	± 0.2 dB	± 0.5 dB		
- 56.02 dBm				

Square Wave and Pulse

(5 to 95% duty cycle):

	0.001 Hz	100 kHz	1 MHz	13 MHz
10.00 Vpp		$\pm 3.0\%$	$\pm 6.0\%$	$\pm 8.0\%$
1.00 Vpp	$\pm 2.0\%$	$\pm 5.0\%$		
100 mVpp				

WAVEFORM CHARACTERISTICS

SINE WAVE SPECTRAL PURITY:

Harmonic Distortion: Harmonically related signals will be less than the following levels relative to the fundamental, or < -90 dBm, whichever is greater.

	10 Hz	50 kHz	100 kHz	1 MHz	13 MHz
+ 23.98 dBm	-80 dBc	-70 dBc	-55 dBc	-30 dBc	-30 dBc
+ 13.98 dBm	-80 dBc	-80 dBc	-65 dBc	-50 dBc	-50 dBc
- 56.02 dBm	-80 dBc	-80 dBc	-65 dBc	-50 dBc	-50 dBc

Spurious: In Two-Channel mode, all non-harmonically related output signals (10 Hz* to 40 MHz) will be less than the following levels relative to the fundamental, or < -90 dBm, whichever is greater.

Channel Frequency Spurious Level

10 Hz to 1 MHz	-80 dBc
1 MHz to 13 MHz	-70 dBc

*Ground isolation must be maintained.

Integrated Phase Noise: For a 30 kHz band centered on a 10 MHz carrier (excluding ± 1 Hz about the carrier).

With option 001: < -63 dBc.

With standard instrument: *typically* < -60 dBc.

SQUARE WAVE AND PULSE CHARACTERISTICS:

Rise/fall time: ≤ 15 ns 10% to 90% at full output at 1 MHz.

Overshoot: $\leq 5\%$ of peak-to-peak amplitude at full output at 1 MHz.

Square Wave symmetry: $\leq \pm 1\%$ of period + 6ns.

Pulse Width range: 1% to 99% of period or 20 ns, whichever is greater.

Pulse Width resolution: 0.1% of period.

Pulse Width accuracy: $\leq \pm 1\%$ of period ± 20 ns.

DC ONLY

RANGE: 0 to ± 5.0 V.

RESOLUTION: 3 digits or 10 mV.

ACCURACY (AFTER PERFORMING SELF-CALIBRATION): ± 75 mV.

SPECIFICATIONS

DC OFFSET

RANGE: Maximum DC Offset is a function of the selected AC amplitude.

AC Amplitude	Max AC + DC	Max DC Offset
1.0 to 10.0 Vpp	± 5.0 V	± 4.5 V
0.1 to 1.0 Vpp	± 0.5 V	± 0.45 V
10 mV to 100 mVpp	± 50 mV	± 45 mV
1 mV to 10 mVpp	± 5 mV	± 4.5 mV

RESOLUTION: 4 digits.

DC ACCURACY (AFTER PERFORMING SELF-CALIBRATION):

	Mode	
	Sine Wave	Square Wave/Pulse*
10 Hz to 1 MHz	± 2.0% of max DC	± 2.0% of max DC
1 MHz to 13 MHz	± 5.0% of max DC	± 6.0% of max DC

* midpoint between peaks

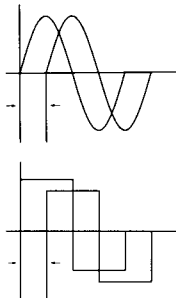

PHASE OFFSET

The following specifications apply to the Phase Offset between Channels A and B in the Two-Phase mode only. Phase is defined as the difference in rising edge to rising edge (using the midpoint as the reference point) for sine and square waves.

RANGE: ± 720°.

RESOLUTION: 0.01°.

ABSOLUTE ACCURACY: in degrees with the following output waveforms on Channels A and B, equal amplitude levels, and either internal phase calibration or external phase calibration (using a power splitter and equal length cables).

Cal Mode	Sine/Sine Outputs:					
	0.1 Hz	10 Hz	1 kHz	100 kHz	1 MHz	13 MHz
Internal ¹	± 0.5°	± 0.2°	± 0.2°	± 0.3°	± 2.0°	
Internal ²	± 0.8°	± 0.4°	± 0.4°	± 0.5°	± 3.0°	
External ¹		N/A	± 0.2°	± 0.3°	± 2.0°	

1 = Both amplitude levels
2 = Both amplitude levels

Typical performance

UNEQUAL LEVELS (Sine/Sine Mode)

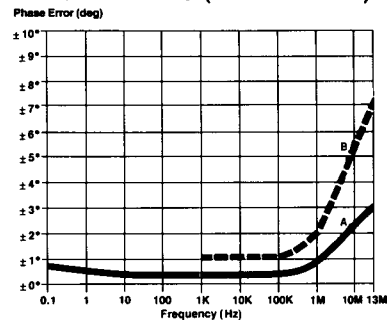

A) Unequal Levels, Internal Cal.¹
B) Unequal Levels, External Cal.¹

Square/Square Outputs:

Cal Mode	0.1 Hz	10 Hz	1 kHz	100 kHz	1 MHz	13 MHz
Internal ¹	± 0.5°	± 0.2°	± 0.2°	± 0.2°	± 0.7°	± 5.0°
Internal ²	± 0.8°	± 0.4°	± 0.4°	± 0.4°	± 1.0°	± 7.0°
External ¹		N/A	± 0.2°	± 0.2°	± 0.7°	± 5.0°

1 = Both amplitude levels
2 = Both amplitude levels

Typical Performance

UNEQUAL LEVELS (Square/Square Mode)

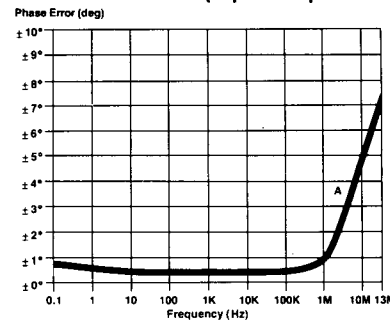

A) Unequal Levels, Internal Cal.¹

STABILITY WITH TEMPERATURE: typically ± 0.3°/phase/°C, 20°C to 30°C.

STABILITY WITH TIME: typically ± 0.1°/10 min after a 30 min warm-up, ± 0.02°/10 min after a 1 hr warm-up.

AMPLITUDE MODULATION

The following specifications apply to the Channel A and Channel B outputs with external modulation or to the Channel A output with internal modulation (Channel B is the modulation source). External amplitude modulation is allowed in any mode while internal amplitude modulation is allowed only in the Two-Channel mode.

WAVEFORMS: Sine, square, or pulse (pulse allowed in external only).

CARRIER FREQUENCY RANGE: DC to 13 MHz.

MODULATION FREQUENCY RANGE: DC to 100 kHz.

MODULATION DEPTH: 0 to 100%.

The following specifications apply at 10 MHz carrier frequency, 1 kHz modulation source, 80% modulation depth.

Envelope Distortion: < -46 dB.

Incidental PM: ≤ 5° peak.

Modulation Index Accuracy (internal only): ± 5% of setting

Modulation Index Resolution (internal only): 0.1%.

EXTERNAL MODULATION:

Channel A sensitivity: approximately -1.0 V for 0%, +1.0 V for 100%.

Channel B sensitivity: approximately +1.0 V for 0%, -1.0 V for 100%.

Input impedance: 10 KΩ nominal.

SPECIFICATIONS

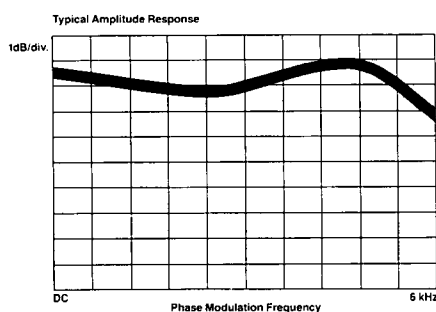

PHASE MODULATION

The following specifications apply to the Channel A and Channel B outputs with external and synchronous phase modulation, and to the Channel A output with internal phase modulation (Channel B is the modulation source). External and synchronous PM are allowed in any mode while internal PM is allowed only in the Two-Channel mode.

WAVEFORMS: Sine, square, or pulse (pulse allowed in external only).

CARRIER FREQUENCY RANGE: DC to 13 MHz.

MODULATION FREQUENCY RESPONSE: DC to 200 Hz: ± 0.5 dB
DC to 5 kHz: -3 dB see typical plot

PHASE DEVIATION: $\pm 360^\circ$.

LINEARITY: $\pm 0.5\%$, best fit straight line.

DISTORTION (10 MHz CARRIER FREQUENCY, 1 kHz MODULATION SOURCE):

≤ -50 dBc for less than $\pm 45^\circ$ peak deviation,

≤ -37 dBc at $\pm 90^\circ$ peak deviation

INTERNAL MODULATION:

Phase deviation resolution: 1° .

Phase deviation accuracy: 5% of setting

EXTERNAL AND SYNCHRONOUS MODULATION:

Sensitivity: approximately $360^\circ/V$.

Input impedance: $3\text{ k}\Omega$ nominal.

Incidental AM: $< 0.5\%$ at 360° peak deviation

FREQUENCY SWEEP

SWEEP TYPES:

Linear sweep: User selectable Start/Stop Frequencies and Sweep Time.

Discrete sweep: 1 to 63 user selectable sequential elements. Each element consists of Channel A and B frequencies and the dwell time before switching to the next element.

LINEAR SWEEP:

Sweep forms: Triangle, ramp.

Sweep time: 5 ms to 1000 s, limited to 5 mHz/s to 500 MHz/s sweep rates.

Sweep Width: 25 μ Hz to 13 MHz.

DISCRETE SWEEP DWELL TIME: 5 ms to 1000 s between switching elements, limited to 5 mHz/s to 500 MHz/s sweep rates.

PHASE CONTINUITY: Sweep is phase continuous over the full frequency range.

OUTPUT COMBINER

The following specifications apply when Channel A and B are combined on the Channel A output with the Channel B output automatically turned off and terminated in 50Ω . The combiner may be used in the Two-Channel, Two-Phase and Two-Tone modes only. DC offset is automatically set to 0 V when the combiner is on.

FREQUENCY RANGE: DC to 13 MHz.

RETURN LOSS: > 20 dB.

AMPLITUDE: The maximum settable levels of Channels A and B are each reduced by 6.02 dB.

AMPLITUDE ACCURACY: Add the following to the amplitude accuracy of Channel A or B, given on page 10.

DC to 100 kHz	± 0.1 dB
100 kHz to 13 MHz	± 0.3 dB

INTERMODULATION DISTORTION: In Two-Tone mode, third-order intermodulation products will be less than the following levels relative to the higher of the fundamentals. Both channels must be in the indicated frequency band with a minimum frequency separation of 10 Hz.

	10 Hz	1 MHz	13 MHz
+ 17.96 dBm			
+ 7.98 dBm	-70 dB		-45 dB
- 56.02 dBm	-80 dB		-65 dB

AUXILIARY OUTPUTS

SYNC A: Square Wave with the same frequency as Channel A.

Level: $V_{\text{high}} \geq 1.2$ V, $V_{\text{low}} \leq 0.2$ V into 50Ω .

Output impedance: 50Ω nominal.

Connector: Front panel BNC.

X-AXIS DRIVE: Linear ramp proportional to sweep time in linear sweep mode and discrete sweep (if dwell time is < 1000 s).

Level: 0 to $+10$ V DC.

Linearity: $\pm 0.2\%$ between 10% and 90% of ramp.

Accuracy: $\pm 4\%$ of full scale value, $> 10\text{ k}\Omega$ load.

Connector: Rear panel BNC.

Z-AXIS BLANK: TTL compatible level that is low during sweep.

Connector: Rear panel BNC.

SWEEP MARKER: TTL compatible level that makes a high-to-low transition at the selected marker frequency during linear sweep or is low during discrete frequencies, pulsing high for a minimum of 10 μ s between frequency changes.

Connector: Rear panel BNC.

10 MHz REFERENCE: $> +3$ dBm output for frequency-locking additional instruments to the 3326A.

Impedance: 50Ω nominal.

Connector: Rear panel BNC.

10 MHz OVEN OUTPUT (OPTION 001 ONLY): $> +3$ dBm internal high stability frequency reference output for phase-locking other instruments.

Connector: Rear panel BNC.

20 - 33 MHz LO OUTPUT: ≥ 100 mV square wave output that is offset 20 MHz from the Channel B output frequency.

Impedance: 50Ω nominal, AC coupled.

Connector: Rear panel BNC.

SPECIFICATIONS

AUXILIARY INPUTS

EXTERNAL REFERENCE INPUT: For phase-locking the 3326A to an external frequency reference. Signal from 0 dBm to +20 dBm into 50Ω. Reference must be 1, 2, 5 or 10 MHz ± 10 ppm. Channel A phase stability with respect to external reference input is ± 1°C.

Connector: Rear panel BNC. With option 001 this input must be connected to the 10 MHz Oven Output.

EXTERNAL TRIGGER: TTL compatible level that initiates linear or discrete sweep on high to low transition.

Connector: Rear panel BNC.

CHANNEL A EXTERNAL PHASE CALIBRATION: For external or multiphase calibration.

Frequency range: 1 kHz to 13 MHz.

Amplitude range: 1 to 10 V peak-to-peak.

Impedance: 50Ω nominal.

Waveform: Sine wave or square wave with 50% duty cycle.

Connector: Rear panel BNC.

CHANNEL B EXTERNAL PHASE CALIBRATION: For external or multiphase calibration. Specifications identical to Channel A external phase calibration input.

Connector: Rear panel BNC.

CHANNEL A EXTERNAL AMPLITUDE MODULATION: See modulation specifications.

Connector: Rear panel BNC.

CHANNEL B EXTERNAL AMPLITUDE MODULATION: See modulation specifications.

Connector: Rear panel BNC.

CHANNEL A EXTERNAL PHASE MODULATION/SYNCHRONOUS PHASE MODULATION: See modulation specifications.

Connector: Rear panel BNC.

CHANNEL B EXTERNAL PHASE MODULATION: See modulation specifications.

Connector: Rear panel BNC.

SAVE/RECALL MEMORY

Ten non-volatile memory locations.

Front panel setups can be stored in memory locations 1 through 9. Last front panel setup is saved in memory location 0 when power is removed. Use of discrete sweep overwrites memory locations 1 through 9 with the 63 discrete elements, where an element consists of Channel A and B frequencies and the dwell time between elements.

HP-IB CONTROL

CAPABILITY: Compatible with IEEE Standard 488 – 1978. All front panel functions, except line switch and HP-IB address, are programmable. Special HP-IB only functions include Service Requests, diagnostics, device trigger for external trigger, and front panel display secure mode. The 3326A is compatible with most HP 3325A HP-IB mnemonics.

INTERFACE FUNCTIONS: SH1,AH1,T6,L4,SR1,RL1,PP0,DC1,DT1,C0,E1.

TYPICAL SWITCHING TIMES (EXCLUSIVE OF PROGRAMMING TIME):

Frequency (to within ± 10ppm):

≤ 10 ms for a 100 kHz step.

≤ 25 ms for a 1 MHz step.

≤ 70 ms for a 10 MHz step.

Phase (to within ± 1°): ≤ 15 ms.

Amplitude (to within amplitude specifications): ≤ 30 ms.

OPTIONS

OPTION 001 HIGH STABILITY

FREQUENCY REFERENCE

Improves frequency stability and integrated phase noise characteristics.

STABILITY: ± 5 × 10⁻⁸/week, after 72 hours continuous operation, ± 1 × 10⁻⁷/mo. after 15 days continuous operation.

WARM-UP TIME: Reference will be within ± 1 × 10⁻⁷ of final value 15 minutes after turn-on at 25°C for an off time of 24 hours.

PHASE NOISE: see Sine Wave Spectral Purity section on page B1.

OPTION 002 HIGH VOLTAGE OUTPUT

Increases output level by a factor of 4 and expands the allowable DC offset range. The following specifications apply to the Channel A and Channel B outputs in all modes with the internal combiner off.

FREQUENCY RANGE: DC to 1 MHz.

OUTPUT IMPEDANCE:

DC to 50 kHz: < 2Ω.

50 kHz to 1 MHz: < 10Ω.

AMPLITUDE:

Range: 4 mV to 40 Vpp into 1 kΩ load with < 200 pF, without DC offset. Levels are 4 times the standard instrument ranges. Amplitude is entered in peak-to-peak units only.

Accuracy: ≤ ± 12% of peak-to-peak value for sine, square, and pulse for 400 mV to 40 Vpp values.

SINE WAVE HARMONIC DISTORTION: Harmonically related signals will be less than the following levels relative to the fundamental, into 1 KΩ, no DC offset.

	10 Hz	50 kHz	100 kHz	1 MHz
40.00 Vpp	—	—	—	—
12.64 Vpp	—	-75 dB	-65 dB	-40 dB
400 mVpp	—	-80 dB	-75 dB	-55 dB

SPECIFICATIONS

SQUARE WAVE AND PULSE CHARACTERISTICS:

Rise/fall time: ≤ 150 ns, 10% to 90% at full output with 1 k Ω, 200 pF load.

Overshoot: ≤ 10% of peak-to-peak amplitude at full output with 1 kΩ, 200 pF load.

DC ONLY AND DC OFFSET CHARACTERISTICS:

DC Only Range: 0 to ± 20 V.

DC Offset Range: ± 20 V independent of the AC amplitude range. DC + AC peak must be less than 20 V.

DC Offset Accuracy: ± 100 mV ± 1% of setting.

OUTPUT COMBINER: The following specifications apply when Channel A and B are combined on the Channel A output (Channel B output is off). The combiner may be used in the Two-Channel, Two-Phase and Two-Tone modes. DC offset is automatically set to 0 V when the combiner is on.

INTERMODULATION DISTORTION: Third-order intermodulation products will be less than the following levels relative to the higher of the fundamentals (sine wave only). Both channels must be in the indicated frequency band with a minimum frequency separation of 10 Hz.:

20.00 Vpp	10 Hz	100 kHz	1 MHz
6.32 Vpp	- 60 dB	- 40 dB	
200 mVpp	- 75 dB	- 55 dB	

MAXIMUM OUTPUT CURRENT: 80 mA peak-to-peak.

OPTION 003 REAR PANEL MAIN SIGNAL OUTPUTS

Replaces front panel Channel A and B outputs with rear panel outputs.

GENERAL

OPERATING ENVIRONMENT:

Temperature: 0°C to 55°C.

Relative Humidity: 95%, 0°C to 40°C.

Altitude: ≤ 4,572 m (15,000 ft).

STORAGE ENVIRONMENT:

Temperature: - 40°C to + 75°C.

Altitude: ≤ 15,240 m (50,000 ft).

POWER: 100/120/220/240V, + 5%, - 10%; 48 to 66 Hz; 120 VA, 290 VA with all options, 100 VA standby.

WEIGHT: 27 kg (60 lbs.) net, 37 kg (81 lbs.) shipping.

DIMENSIONS: 177 mm H x 425.5 mm W x 497.8 mm D (7'' x 16 - 3/4'' x 19 - 5/8'').

ACCESSORIES INCLUDED:

1 ea. Operating Manual (HP Part Number 03326 - 90000). 1 ea. Service Manual (HP Part Number 03326 - 90010).

ACCESSORIES AVAILABLE:

15507A Ground Isolator for breaking signal grounds between input and output connectors, thereby isolating a connector from the chassis ground.

11048C 50 Ohm Feed Thru Termination for terminating outputs in 50Ω.

11652 - 60009 50 Ohm BNC Power Splitter. 11667A 50 Ohm Type N Power Splitter for use in external and multiphase calibration.

03326 - 84401 Service Accessory Kit for trouble-shooting and repair of the 3326A. Includes extender boards and cables.

9211 - 2656 Transit Case for rugged protection, transportation, and storage.

RELATED EQUIPMENT

1980B Oscilloscope Measurement System (DC to 100 MHz)

3561A Dynamic Signal Analyzer (125 μHz to 100 kHz)

3585A Spectrum Analyzer (20 Hz to 40 MHz)

3586C Selective Level Meter (50 Hz to 32.5 MHz)

ORDERING INFORMATION:

USA List Prices Only

3326A Two-Channel Synthesizer \$9,200

Option 001 High Stability Frequency Reference add 650
(to retrofit order HP Part Number 03326-88801)

Option 002 High Voltage Output add 300
(to retrofit order HP Part Number 03326-88802)

Option 003 Rear Panel Main Signal Outputs N/C
(to retrofit order HP Part Number 03326-88803)

Option 907 Front Handle Kit add 60
(to retrofit order HP Part Number 5061-0090)

Option 908 Rack Flange Kit add 35
(to retrofit order HP Part Number 5061-0078)

Option 909 Rack Flange and Front Handle Kit add 90
(to retrofit order HP Part Number 5061-0084)

Option 910 Extra Operating Manual add 100

Option 914 Delete Service Manual less 115

15507A Ground Isolator 275

11048C 50 Ohm Feed Thru Termination 30

9211-2656 Transit Case 540

03326-84401 Service Accessory Kit 250

APPENDIX C

QUICK REFERENCE

This quick reference foldout contains abbreviated operating information for the HP 3326A. Included in this section is a brief description of the HP 3326A front and rear panels.

APPENDIX C

Key/Connector/Indicator/Key Block	Page		Page
AMPTD key	1-22	LISTEN indicator	1-58
ASGN ZERO ϕ key	1-27	LOCAL key	1-58
AUTO key	1-56	MANUAL key	1-56
A-AMPTD MOD IN connector	1-48	MARKER OUT connector	1-60
A-EXT PHASE CAL IN connector	1-54, 1-55	MKR FREQ key	1-34
A-PHASE MOD IN/SYNC PM IN connector	1-48	MKR-CF key	1-38
BACK SP key	1-15	MODE block	1-6
BUS ADRS key	1-58	MODE key	1-6
B-AMPTD MOD IN connector	1-48	MODIFY block	1-18
B-EXT PHASE CAL IN/ MULTI PHASE		MODULATION block	1-44
REF IN connector	1-54, 1-55	MODULATION keys	1-44
B-PHASE MOD IN connector	1-48	MULTIPHASE indicator	1-55
CALIBRATION block	1-53	MODULATION INPUTS	1-48
CALIBRATION INPUTS	1-54, 1-55	ON/OFF key	1-18
CH A indicator	1-14	PHASE key	1-26
CH A key	1-12	POWER KEY	1-2
CH A OUT OPT 003 connector	1-5	PULSE indicator	1-10
CH A output	1-5	RCL DISCRETE key	1-39, 1-51
CH B indicator	1-14	RECALL key	1-50
CH B key	1-12	REMOTE indicator	1-58
CH B OUT OPT 003 connector	1-5	RESET SWEEP key	1-36, 1-41
CH B output	1-5	Rotary knob	1-18
CHAN key	1-14	SAVE key	1-50
CLEAR MEM key	1-51	SAVE DISCRETE key	1-40, 1-51
CLR DISCRETE key	1-41, 1-52	SELECT key	1-53
CLR ϕ OFS key	1-27	SELF TEST key	1-57
CNTR FREQ key	1-37	SINGLE key	1-30, 1-41
COMBINED key	1-11	SPAN key	1-36
CONT key	1-30, 1-41	SRQ indicator	1-58
DATA block	1-14	START FREQ key	1-32
DC OFFSET key	1-24	STATUS block	1-14
DC indicator	1-13	STOP FREQ key	1-33
DISCRETE key	1-39	SYNC A output	1-63
DUTY CYCLE key	1-28	SWEEP	1-29
ENTRY block	1-20	TALK indicator	1-58
EXT AM indicator	1-48	TIME key	1-34, 1-41
EXT PM indicator	1-48	TRIANGLE key	1-35
EXT REF indicator	1-66	X-DRIVE connector	1-62
EXT TRIG IN connector	1-59	Z-BLANK TTL connector	1-61
EXTERNAL indicator	1-54	1, 2, 5, 10 MHz REF IN connector	1-66
FREQ key	1-20	2 CHANNEL indicator	1-7
FREQUENCY REFERENCE INPUT/OUTPUT	1-66	2 PHASE indicator	1-8
FRONT PANEL OUTPUTS	1-5, 1-63	2 TONE indicator	1-9
FUNCTION block	1-12	10 MHz OUT connector	1-66
HP-IB connector	1-57	10 MHz OVEN OUTPUT Option 001 connector	1-66
HP-IB STATUS block	1-57	20-33 MHz B-L.O. OUTPUT connector	1-64
HV key	1-13	(AB) SYNC PM indicator	1-48
HV-A indicator	1-13	ϕ OFFSET indicator	1-27
HV-B indicator	1-13	% AM/PM DEV key	1-45, 1-47
INSTR PRESET key	1-3, 1-52	- key	1-19
INSTR STATE block	1-39, 1-50	- key	1-19
INT AM indicator	1-45	~ indicator	1-12
INT PM indicator	1-46	∇ indicator	1-13
INTERNAL indicator	1-53		

1 STATUS

Display panel displays frequency (up to 11 digits), amplitude, phase offset, dc offset, sweep frequencies and time, marker frequency, and HP-IB address values, as well as error messages.

CHAN key selects channel for display and modification.

CH A and **CH B** indicators indicate channel selected for display and modification.

HV-A and **HV-B** indicators illuminate when the high voltage option is enabled.

Φ OFFSET indicator illuminates when a phase offset exists for channel B relative to channel A.

EXT REF indicator illuminates when the HP 3326A is operating with an external frequency reference or high stability frequency option (Option 001).

2 DATA

Frequency, amplitude, offset, time, phase, duty cycle, modulation level, memory location, and HP-IB address values are entered with the numeric keypad followed by a units suffix.

BACK SP key removes the least significant digit from the display during data entry.

3 HP-IB STATUS

REMOTE, **LISTEN**, **TALK**, and **SRQ** status indicators provide an indication of HP-IB operation.

LOCAL key switches HP 3326A control from remote operation to front panel operation unless local lockout is in effect.

BUS ADRS key enables display or modification of the HP-IB address stored in nonvolatile memory.

4 SWEEP

CONT and **SINGLE** keys select either continuous or single frequency sweeps. During discrete frequency sweeps, the **SINGLE** key steps through the sweep elements.

START FREQ and **STOP FREQ** keys allow entry or modification of the frequency sweep start and stop frequencies.

MKR-CF key centers the sweep span around the marker frequency.

CNTR FREQ and **SPAN** keys allow entry or modification of the frequency sweep start and stop frequencies in terms of sweep center frequency and sweep span.

MKR FREQ key allows entry or modification of a marker frequency.

TIME key allows entry or modification of the frequency sweep sweep time. For discrete frequency sweeps, time is the dwell time for each discrete frequency sweep element.

RESET SWEEP key resets the frequency sweep circuits.

TRIANGLE key selects triangle (indicator illuminated) or ramp (indicator extinguished) linear frequency sweeps. The ramp sweep function sweeps from start to stop frequency, while the triangle sweep function sweeps from start to stop to start frequencies.

DISCRETE key enables discrete frequency sweeps (frequency hopping). Discrete frequency sweeps sequence through the discrete frequency sweep elements stored with the **SAVE DISCRETE** key.

5 ENTRY

FREQ key allows entry or modification of frequency values.

AMPTD key allows entry or modification of amplitude values.

DUTY CYCLE key allows entry or modification of the square wave duty cycle.

% AM/PM DEV key allows entry or modification of percent of AM modulation or PM deviation.

PHASE key allows entry or modification of phase values.

DC OFFSET key allows entry or modification of dc offset values.

ASGN ZERO ϕ key assigns a zero value to phase offset without changing the phase of the output.

CLR ϕ OFS key restores the channel B phase offset value without changing the phase of the output.

6 INSTR STATE

INSTR PRESET key sets the following setup:

Mode	2 CHANNEL
Combined operation	Off
Frequency A and B	1000 Hz
Amplitude A and B	100 mVpp
Phase	0°
Duty cycle	50 %
DC offset A and B	0 V
Modulation	Off
Modulation level	30%
Sweep	Off
	Ramp
	13 MHz span
	1 s. sweep
	6.5 MHz marker
Function A and B	Sine wave
High voltage	Off
Calibration	Internal
Autocalibration	Off

1 STATUS

2 DATA

3 HP-IB STATUS

4 SWEEP

5 ENTRY

6 INSTR STATE

7 POWER/SHIFT



CAUTION

The maximum peak voltage (ac + dc) that can be safely applied between the chassis and the outer conductor of the HP 3326A input and output connectors is ± 42 Vpk.

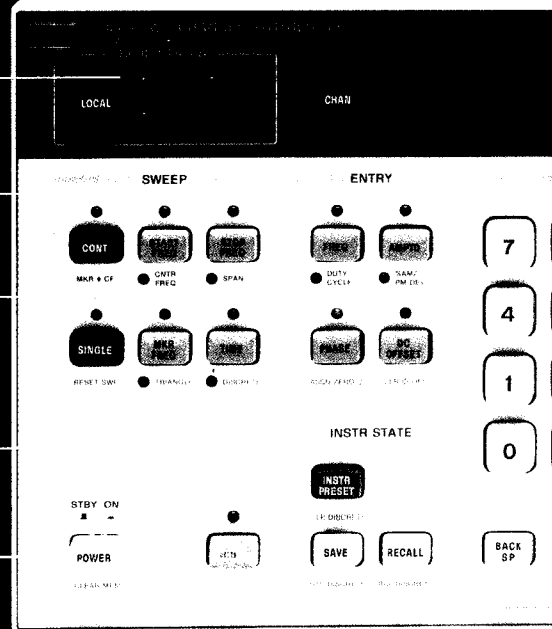

SAVE and **RECALL** keys save and recall setups from nonvolatile memory registers 0 - 9. Register 0 contains the last setup prior to removing power.

CLR DISCRETE key erases all discrete frequency sweep elements stored in memory.

7 POWER/SHIFT

POWER KEY applies power to the entire HP 3326A when ON (depressed). In STBY, power is applied only to the high stability frequency reference option (Option 001) when the HP 3326A is connected to a suitable power source.

CLEAR MEM key clears the contents of internal memory if the key is held down when power is applied.

SHIFT key enables the front panel keys to select the alternate functions printed in blue.

8 MODIFY

Rotary knob modifies frequency, amplitude, phase, offset, duty cycle, modulation level and time values when enabled by arrow keys or ON key.

— and — keys enable the rotary knob and select display (flashing) digit modified.

ON/OFF key enables and disables the modify function and flashing digit.

9 MODULATION

Modulation keys select internal and external AM and PM sources. Internal modulation uses channel B to modulate channel A. External modulation inputs are on the rear panel.

INT AM, INT PM, EXT AM, EXT PM, and **(AB) SYNC PM** indicators illuminate to indicate the type of modulation selected with the modulation keys.

10 CALIBRATION

MANUAL key initiates an HP 3326A calibration.

AUTO key enables automatic calibration.

INTERNAL, EXTERNAL, and **MULTIPHASE** indicators illuminate to indicate the phase calibration source selected with the SELECT key.

SELECT key selects the HP 3326A phase calibration source. Multiphase and external phase calibration inputs are on the rear panel.

SELF TEST key initiates a self test.

11 MODE

MODE key selects the 2 CHANNEL, 2 PHASE, 2 TONE, or PULSE operating modes. The 2 CHANNEL mode provides two independent

sources, the 2 PHASE mode provides two tracking sources with a phase offset, the 2 TONE mode provides two tracking sources with a frequency offset, and the PULSE mode provides a pulse signal and its complement.

2 CHANNEL, 2 PHASE, 2 TONE, or **PULSE** indicators illuminate to indicate the mode selected.

COMBINED key combines channel A and B to produce a composite output at channel A.

12 FUNCTION

CH A and **CH B** keys select the function outputs for each channel.

—, —, and **DC** indicators indicate function selected with CH A and CH B keys.

HV keys enable the high voltage option for low impedance outputs with levels up to 40 Vpp.

13 FRONT PANEL OUTPUTS

SYNC A output provides a TTL square wave with same frequency as channel A. SYNC A output impedance is 50 Ω.

CH A and **CH B** outputs provide standard impedance of 50 Ω. High voltage output impedance is less than 2 Ω to 50 kHz and less than 10 Ω to 1 MHz.

MODIFY 8

MODULATION 9

CALIBRATION 10

MODE 11

FUNCTION 12

FRONT PANEL OUTPUTS 13

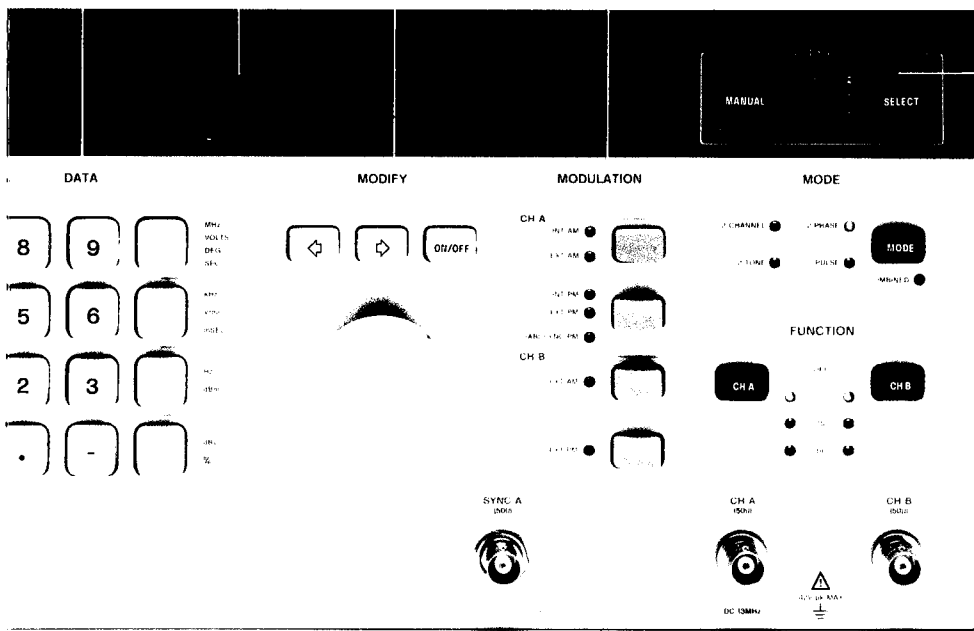

1 MODULATION INPUTS

A-AMPTD MOD IN and **B-AMPTD MOD IN** connectors provide the input to externally modulate the amplitude of the channel A and B outputs (100 kHz maximum modulation frequency). 1 Vdc (-1 Vdc for channel B) corresponds to 100% modulation.

A-PHASE MOD IN/SYNC PM IN and **B-PHASE MOD IN** connectors provide the input to externally phase modulate the channel A and B outputs (5 kHz maximum modulation frequency). ± 1 Vdc corresponds to $\pm 360^\circ$ modulation.

2 CALIBRATION INPUTS

A-EXT PHASE CAL IN and **B-EXT PHASE CAL IN/ MULTI ϕ REF IN** connectors allow the HP 3326A to sense phase externally for an external or multiphase calibration. These inputs require a 1 kHz to 13.1 MHz signal with an amplitude of 3 to 10 Vpp.

3 CHANNEL OUTPUTS

CH A OUT OPT 003 and **CH B OUT OPT 003** are optional rear panel outputs for channel A and B.

4 FREQUENCY REF INPUT/OUTPUT

1, 2, 5, 10 MHz REF IN connector allows the HP 3326A to phase-lock to a stable frequency reference. This input is referenced to chassis ground.

10 MHz OUT connector provides 10 MHz square wave (<3 dBm 50 Ω) as a frequency reference for other instruments. This output is referenced to chassis ground.

10 MHz OVEN OUTPUT Option 001 provides a high stability frequency reference when connected to 1, 2, 5, 10 MHz REF IN. The 10 MHz OVEN OUTPUT is a square wave (< 3 dBm 50 Ω). This output is referenced to chassis ground.

5 20-33 MHz B-L.O. OUTPUT

20-33 MHz B-L.O. OUTPUT provides an output offset from the channel B frequency by 20 MHz. This output is referenced to chassis ground.

6 MARKER OUT

MARKER OUT TTL level signal provides a negative going transition at the frequency entered with the MKR FREQ key.

7 EXT TRIG INPUT

EXT TRIG IN allows external triggering of sweeps on negative edge transition of a TTL signal.

8 X-DRIVE/Z-BLANK OUTPUTS

X-DRIVE provides linear 0 to <10 V ramp proportional to sweep time.

Z-BLANK TTL output drops low at start of sweep during frequency sweeps, capable of sinking current (100 mA maximum) from a positive source.

9 HP-IB

HP-IB connector allows remote operation of the HP 3326A with an external controller. This connector is referenced to chassis ground.

MODULATION INPUTS 1

CALIBRATION INPUTS 2

CHANNEL OUTPUTS 3

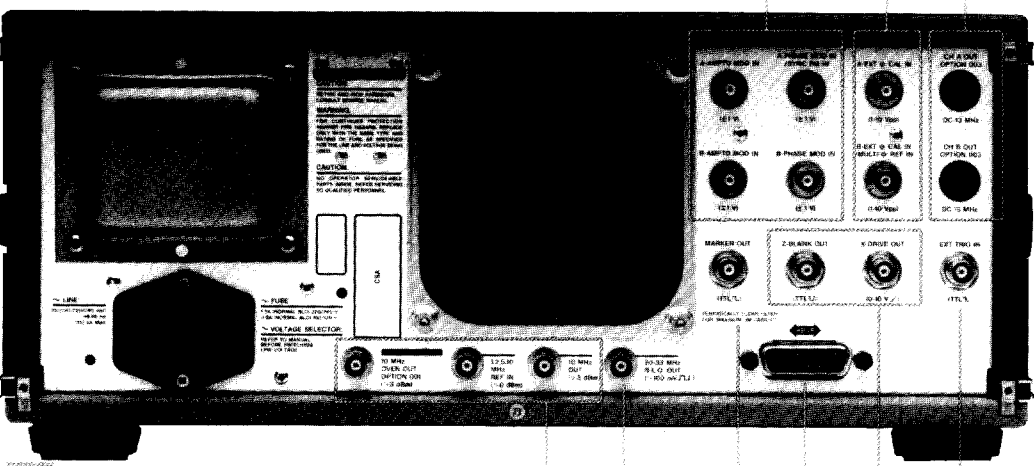

4 FREQUENCY REF INPUT/OUTPUT

5 20-33 MHz B-L.O. OUTPUT

6 MARKER OUT

TRIGGER INPUT 7

X DRIVE/Z BLANK 8

HP-IB 9