

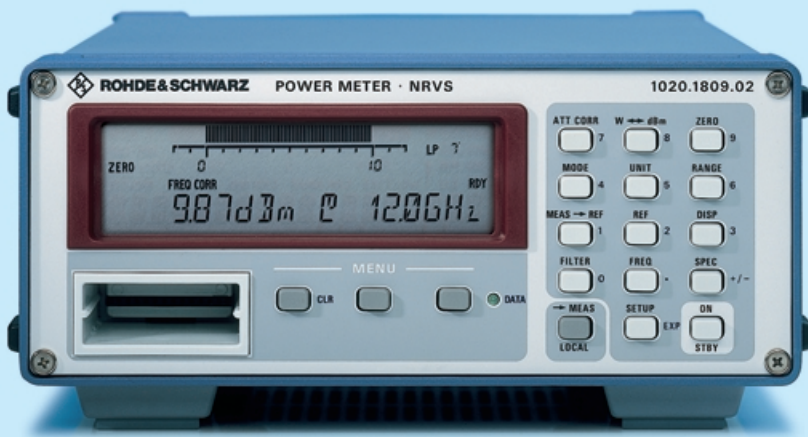

Power Meter NRVS

Power, level and voltage measurements from DC to 40 GHz

- Accurate, general-purpose, easy-to-use
- Intelligent measuring heads: just plug them in and measure
- DC frequency input for tracking frequency response correction
- Analog output
- Remote control of all functions via IEC/IEEE bus



Uncompromizing technology and ease of operation make the NRVS an ideal instrument for any kind of power measurement in manifold laboratory and system applications. Thanks to its unique measuring heads with calibration data memory and temperature sensor, which make adjustments by the user superfluous, the NRVS measures at all times with high accuracy and free of operator's errors.

The range of measuring heads includes thermal power sensors as well as highly sensitive diode power sensors, peak power sensors, probes and insertion units for voltage measurements. The NRVS covers a power span from 100 pW up to the kW range. In addition to the power sensors, all voltage probes of the URV5-Z series can be used.

Readout

Measurement results, units and various items of information are displayed on a large 4 1/2-digit LC display in three steps of resolution.

All standard units of measurement or relative modes can be selected. A high-resolution bargraph indicator with selectable scaling or autoscaling permits quasi-analog display of measured values with any unit or resolution.

The characters „PEP“ or „PUL“ preceding the numerical value denote the maximum envelope power (measured with a Peak Power Sensor of the NRV-Z3x series) or the pulse power, respectively. The pulse power is a calculated peak value for RF bursts with rectangular envelope. It is based on the duty factor and the average power value. Pulse power measurements can be made using thermocouple sensors as well as diode power sensors operated in the square-law region.

Operation

Operation of the power meter is to a great extent via self-explanatory menus so that the user will hardly ever have to refer to the manual. For setting the instrument rapidly to a specific status, 20 complete setups can be stored. A selectable write protection prevents inadvertent alteration of stored setup data.

Measurement rate

The attainable measurement rate not only depends on the type of measuring head used but also on the setting of the averaging filter, which must be matched to the measurement conditions. Taking into account the connected measuring head, the NRVS automatically selects the appropriate measurement rate by determining the optimum averaging time required for a steady readout as a function of level and selected resolution. This automatic selection may be disabled and an averaging time of between 4 ms and 25 s may be set manually to measure faster than in automatic operation or to further reduce the noise.

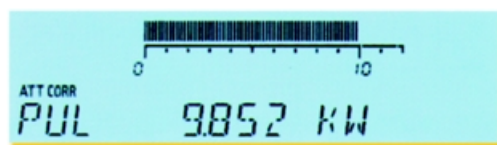
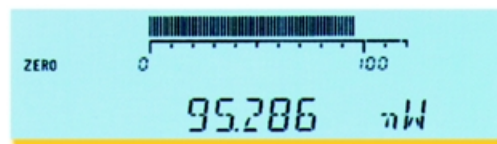
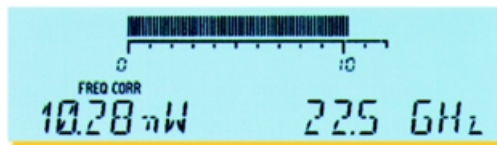

Measuring heads

Power meters cover a wide range of applications and a great variety of frequency and power ranges. Since suitable measuring heads are available for the various applications and ranges, the only factors to influence the selec-

tion of a power meter are versatility, system compatibility and ease of operation. In these aspects the NRVS is a top-class unit. NRVS measuring heads are not type-specific and may therefore be used with any unit of the R&S power and voltmeter families.

Thermal power sensors measure the average power irrespective of the signal shape and meet the highest demands on accuracy. Diode power sensors are more sensitive – they are able to measure power down to the pW range – but their measurement accuracy is impaired when high-level, non-sinusoidal signals are to be measured. In the medium sensitivity range it is recommended to use diode power sensors with integrated attenuator, eg NRV-Z2. This combination not only allows considerably faster level measurements in the range between 10 and 100 μW than a thermal power sensor, it also offers better matching than a highly sensitive diode detector and still measures true rms power.

The maximum envelope power of modulated signals can be measured by means of a Peak Power Sensor of the NRV-Z3x series. These sensors are suitable for sync peak power measurements on TV transmitters and transmitter power measurements on TDMA radio equipment or for general applications. Peak Power Sensors, which consist of a fast diode detector followed by a peak-hold circuit, are calibrated individually like all Rohde&Schwarz power sensors.

Besides the NRV-Z power sensors, all voltage probes of the URV5-Z series can be used with the NRVS.

NRVS in use:
on-site measurement on TV transmitter

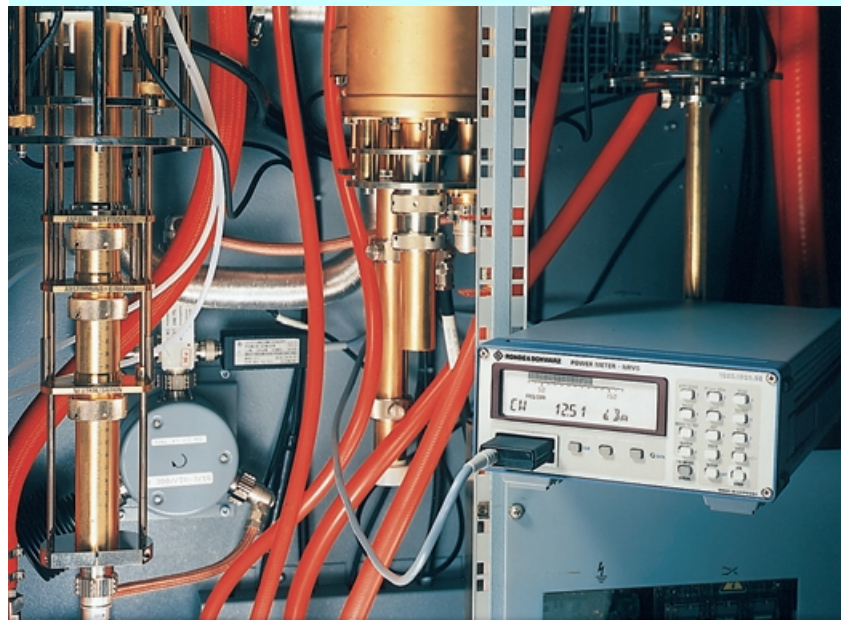

Measurement accuracy

The accuracy of an RF power measurement essentially depends on the characteristics of the power sensor. Errors encountered in this case are a function of level, temperature and frequency and cannot be eliminated completely by design. Error sources of power sensors:

- Non-linearity
- Level-dependent temperature effect
- Frequency response

To be able to measure correctly under any conditions, deviations from the ideal must be registered numerically and considered in the measurement result. The usual way to obtain accurate results is to calibrate the sensors with the aid of a generator prior to their use. The disadvantages of this method are obvious: a calibration has to be performed before each measurement, for each individual sensor and even at intervals during a measurement (in the case of tem-

perature variations). For this reason, Rohde&Schwarz has for years been producing sensors that offer great convenience to the user, although at a higher expenditure to the manufacturer. This technique can be summarized as: plug in and go!

All relevant parameters are measured in the factory individually for each measuring head and then stored in the head. The level-dependent temperature effect is represented as a two-dimensional characteristic with a great number of measurement points.

Each measuring head comprises a temperature sensor, the signal of which is evaluated in the power meter at regular intervals. From the measured temperature and level values, the stored characteristic yields the correction values for the output voltage of the measuring head. The input power is then calculated from this corrected voltage with the aid of a transfer function which is also stored in the head.

Subsequently, frequency-response correction is carried out. The NRVS multiplies the calculated input power with the correction factor for the signal frequency. This frequency is either entered by the user or obtained from a frequency-proportional DC voltage at the DC FREQ input.

This comprehensive error correction technique offers the following advantages:

- Unrestricted exchange of measuring heads thanks to individual calibration
- Optimum measurement accuracy
- Calibration of measuring heads directly traceable to PTB standards
- Fast and convenient operation

In spite of all these corrective measures, one uncertainty remains which is not caused by the measuring head but by a possible mismatch of measuring head and signal source.

As an example, the power applied from a source to a load with a characteristic impedance Z_0 (50 or 75 Ω) is to be measured. The output impedance of the source and the input impedance of the measuring head, which acts as a load, deviate from Z_0 to some extent. This mismatch at both ends causes a measurement error which is often ignored because it cannot be specified for the measuring head separately. The error depends on the degree of mismatch between source and measuring head. (See diagram on page 7). Since, generally, the SWR of the source cannot be varied, the measurement accuracy can only be increased by selecting a low-reflection measuring head. Since all NRVS power sensors offer excellent SWR characteristics, no wrong choice can be made.

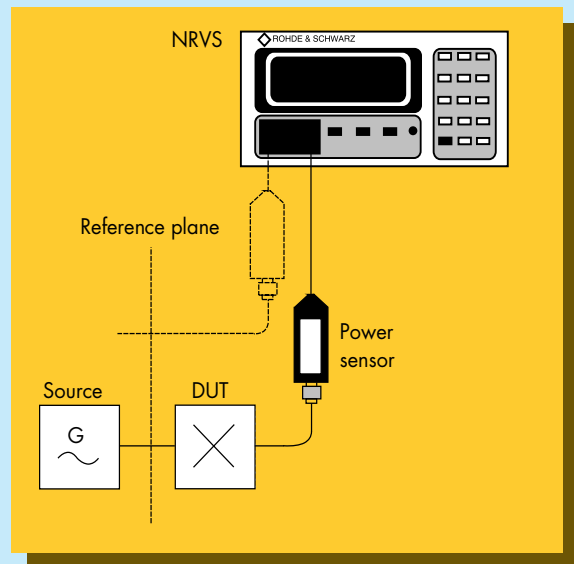

Depending on the measuring head used, attenuations of up to 90 dB can be measured with the NRVS.

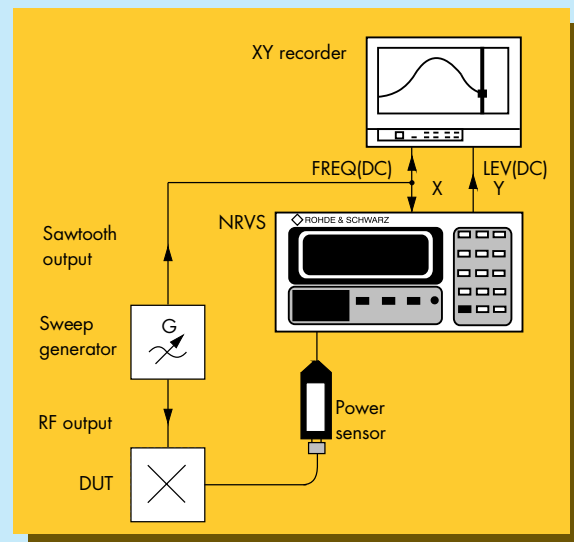

This setup is used for measuring and recording the powertransfer characteristic of a DUT.

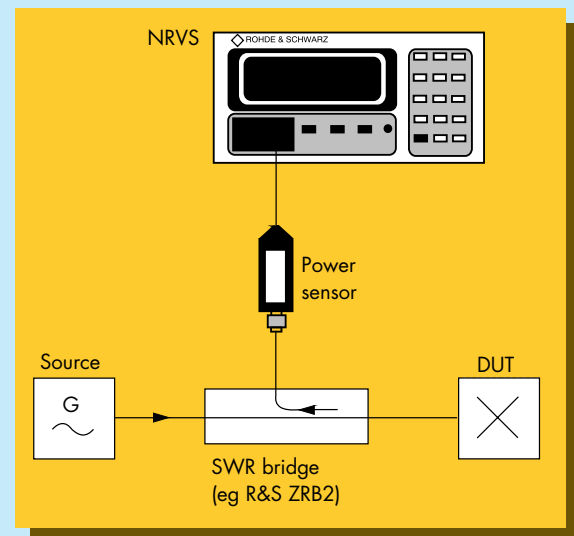

Thanks to their wide dynamic range, the NRVS power sensors are ideal for measuring small reflection coefficients, eg by using SWR Bridge ZRB2.



WF 43 230

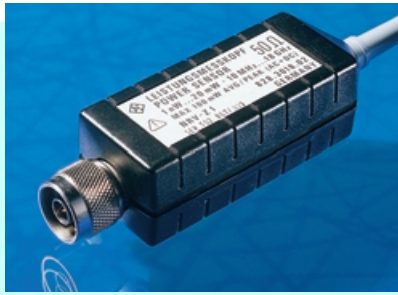

WF 39 823



WF 39 821

Power sensors

NRV-Z1 828.3018.02	Diode Power Sensor 50 Ω 10 MHz to 18 GHz, 200 pW to 20 mW	Power measurements of highest sensitivity up to 18 GHz in 50-Ω systems
NRV-Z2 828.3218.02	Diode Power Sensor 50 Ω 10 MHz to 18 GHz, 20 nW to 500 mW	Power measurements with minimum mismatch, for high powers in 50-Ω systems
NRV-Z3 828.3418.02	Diode Power Sensor 75 Ω 1 MHz to 2.5 GHz, 100 pW to 13 mW	Power measurements in 75-Ω systems
NRV-Z4 828.3618.02	Diode Power Sensor 50 Ω 100 kHz to 6 GHz, 100 pW to 20 mW	Power measurements of highest sensitivity in the frequency range 100 kHz to 6 GHz, very large dynamic range
NRV-Z5 828.3818.02	Diode Power Sensor 50 Ω 100 kHz to 6 GHz, 10 nW to 500 mW	Like NRV-Z4, but for high powers and minimum mismatch
NRV-Z6 828.5010.02	Diode Power Sensor 50 Ω 50 MHz to 26.5 GHz, 400 pW to 20 mW	Power measurements up to 26.5 GHz with high sensitivity in 50-Ω systems (PC 3.5)
NRV-Z15 1081.2305.02	Diode Power Sensor 50 Ω 50 MHz to 40 GHz, 400 pW to 20 mW	Power measurements up to 40 GHz with high sensitivity in 50 Ω systems (2.92 mm)
NRV-Z31 857.9604.02/3/4	Peak Power Sensor 50 Ω 30 MHz to 6 GHz, 1 μW to 20 mW	Peak power measurements, pulse width ≥2 (200) μs, pulse repetition rate ≥10 (100) Hz, 3 models
NRV-Z32 1031.6807.04/5	Peak Power Sensor 50 Ω 30 MHz to 6 GHz, 100 μW to 2(4) W	Peak power measurements, pulse width ≥2 (200) μs, pulse repetition rate ≥25 (100) Hz, 2 models
NRV-Z33 1031.6507.03/4	Peak Power Sensor 50 Ω 30 MHz to 6 GHz, 1 mW to 20 W	Peak power measurements up to 20 W, pulse width ≥2 (200) μs, pulse repetition rate ≥100 Hz, 2 models
NRV-Z51 857.9004.02	Thermal Power Sensor 50 Ω DC to 18 GHz, 1 μW to 100 mW	High-precision power measurement also with non-sinusoidal signals, N connector
NRV-Z52 857.9204.02	Thermal Power Sensor 50 Ω DC to 26.5 GHz, 1 μW to 100 mW	Same as NRV-Z51, but with PC 3.5 connector for measurements up to 26.5 GHz
NRV-Z53 858.0500.02	Thermal Power Sensor 50 Ω DC to 18 GHz, 100 μW to 10 W	High-power measurements up to 10 W also with non-sinusoidal signals
NRV-Z54 858.0800.02	Thermal Power Sensor 50 Ω DC to 18 GHz, 300 μW to 30 W	High-power measurements up to 30 W also with non-sinusoidal signals
NRV-Z55 1081.2005.02	Thermal Power Sensor 50 Ω DC to 40 GHz, 1 μW to 100 mW	Same as NRV-Z51, but with 2.92 mm connector for measurements up to 40 GHz

RF insertion units

URV5-Z2 395.1019.02	10-V Insertion Unit 50 Ω 200 μV to 10 V, 9 kHz to 3 GHz	Low-load RF voltage measurements in 50-Ω coaxial systems, low-loss power measurements on well-matched RF lines
URV5-Z4 395.1619.02	100-V Insertion Unit 50 Ω 2 mV to 100 V, 100 kHz to 3 GHz	Virtually no-load RF voltage measurements in coaxial 50-Ω systems even at higher voltages. Due to minimum insertion loss and reflection coefficient this unit leaves a 50-Ω line practically unaffected

Probes

URV5-Z7 395.2615.02	RF Probe 200 μV to 10 V, 20 kHz to 1 GHz	For measurements in RF circuits at low capacitive and resistive load
with 20-dB plug-on divider*)	2 mV to 100 V, 1 to 500 MHz	The 20-dB and 40-dB plug-on dividers increase the voltage measurement range of the RF probe; the high Q factor of the capacitive divider makes the resistive loading negligible, the capacitive loading goes down to 0.5 pF (40-dB divider)
with 40-dB plug-on divider *)	20 mV to 1000 V, 500 kHz to 500 MHz	
with 50-Ω adapter URV-Z50	200 μV to 10 V, 20 kHz to 1 GHz	With integrated termination for power or level measurements on test items with a source impedance of 50 Ω up to 1 GHz
with 75-Ω adapter URV-Z3	200 μV to 10 V, 20 kHz to 500 MHz	With integrated termination for power or level measurements in 75-Ω systems such as antenna arrays or video equipment
URV5-Z1 395.0512.02	DC Probe 1 mV to 400 V, 9 MΩ 3 pF	For low-capacitance DC voltage measurements in RF circuits at minimum loading

*) part of URV-Z6

Automatic filter setting depending on measurement range

Resolution	Filter number						
HIGH 0.001 dB	11	9	7	7	7	7	7
MEDIUM 0.01 dB	9	7	3	3	3	3	3
LOW 0.1 dB	7	3	0	0	0	0	0
NRV-Z1, -Z3, -Z4, -Z6, -Z15	10 nW	100 nW	1 μW	10 μW	100 μW	1 mW	20 mW
NRV-Z2, -Z5	1 μW	10 μW	100 μW	1 mW	10 mW	100 mW	500 mW
NRV-Z31	-	1 μW	10 μW	100 μW	1 mW	20 mW	-
NRV-Z32	-	100 μW	1 mW	10 mW	100 mW	2 (4) W	-
NRV-Z33	-	1 mW	10 mW	100 mW	1 W	20 W	-
NRV-Z51, -Z52, -Z55	10 μW	100 μW	1 mW	10 mW	100 mW	-	-
NRV-Z53	1 mW	10 mW	100 mW	1 W	10 W	-	-
NRV-Z54	10 mW	100 mW	1 W	10 W	30 W	-	-
URV5-Z2, -Z7	-	1 mV	10 mV	100 mV	1 V	10 V	-
URV5-Z4	-	10 mV	100 mV	1 V	10 V	100 V	-

Measurement time in seconds (from trigger to output of first byte) depends on filter setting

Filter number	0	1	2	3	4	5	6	7	8	9	10	11	12
NRV-Z1 to -Z15	0.045	0.05	0.06	0.08	0.15	0.27	0.49	0.95	1.85	3.6	7.2	14.5	28.5
NRV-Z31 Mod. 02	1.04	1.04	1.05	1.07	1.13	1.24	1.44	1.84	2.7	4.3	7.5	14	27
NRV-Z31, -Z33 Mod. 03/04 NRV-Z32 Mod. 04	0.135	0.14	0.15	0.17	0.23	0.34	0.54	0.94	1.77	3.4	6.6	13	26
NRV-Z32 Mod. 05	0.435	0.44	0.45	0.47	0.53	0.64	0.84	1.24	2.07	3.7	6.9	14	27
NRV-Z51 to -Z55	0.115	0.12	0.13	0.15	0.21	0.32	0.52	0.92	1.75	3.4	6.6	13	26
URV5-Z2, -Z4, -Z7	0.065	0.07	0.08	0.10	0.20	0.38	0.72	1.45	2.8	5.5	11	22	44

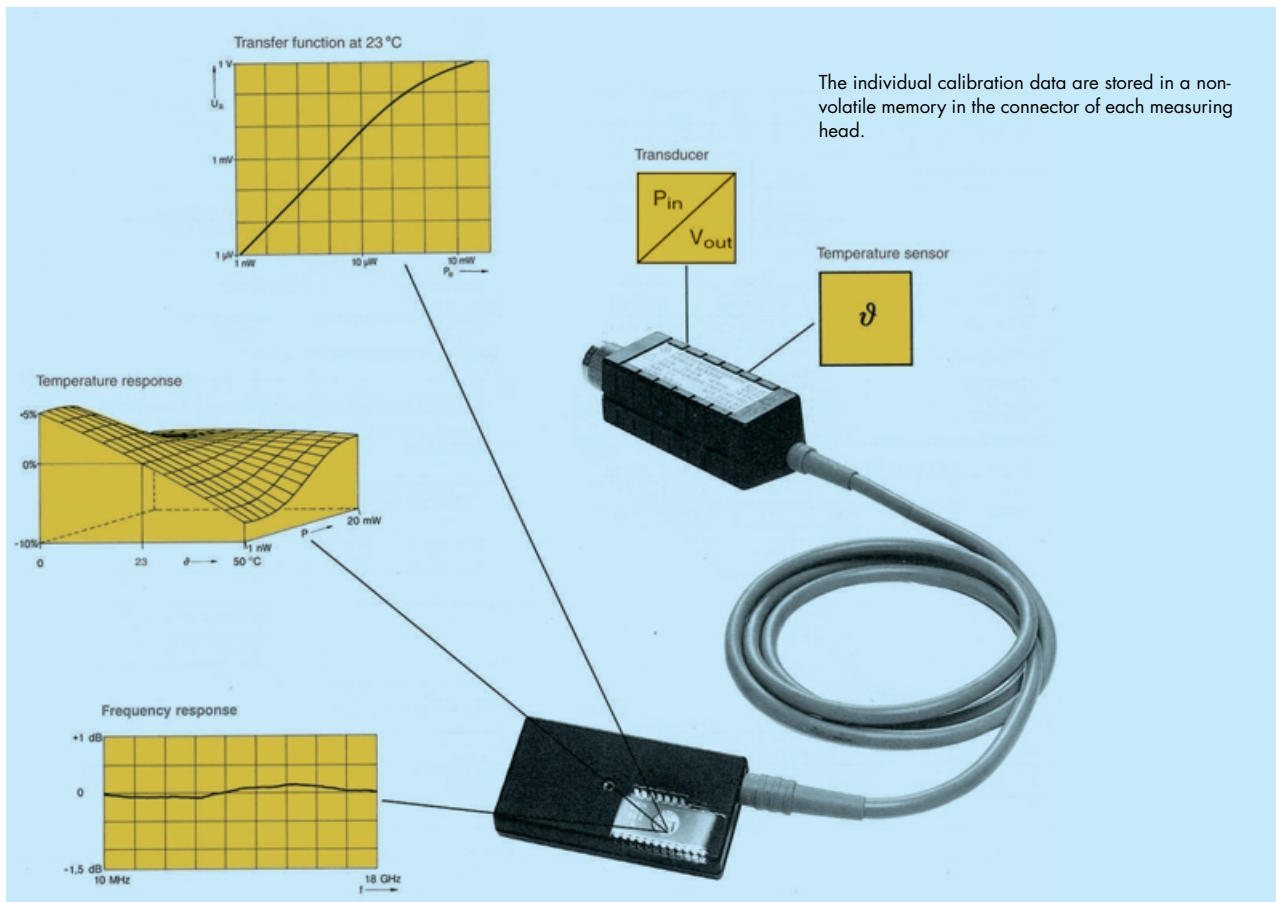

Specifications

Measurement functions	average power, pulse power, max. envelope power, DC and AC voltage (depending on measuring head)
Frequency and level range	DC to 40 GHz, 100 pW to 30 W (depending on measuring head)
Measuring heads	all voltage and power measuring heads NRV-Z and URV5-Z
Display	LCD for figures, units, user prompting and analog display
Readout absolute relative	W, dBm, V, dB μ V dB, %W or %V referred to a stored reference value, numeric readout with or without display of correction frequency automatic or with selectable scale
Analog display Resolution of digital display	4 1/2 digits max., resolution adjustable in 3 modes: HIGH: 12000 steps or 0.001 dB MEDIUM: 1200 steps or 0.01 dB LOW: 120 steps or 0.1 dB
Averaging filter	over 1 to 512 readings for reducing the display noise; manual or automatic setting depending on measurement range and resolution, see table (page 6)
Display noise	see data sheet of measuring heads
Measurement rate	see table (page 6)
Error limits of power readout in W (excluding measuring head) 18 to 28 °C 10 to 40 °C 0 to 50 °C	0.017 dB (0.4%) + 1 digit 0.039 dB (0.9%) + 1 digit 0.060 dB (1.4%) + 1 digit
Zero adjustment	manual or via IEC/IEEE bus, duration approx. 4 s
Frequency response correction	stored frequency response of measuring head taken into account by numerical entry of test frequency (manually or via IEC/IEEE bus) or by applying a frequency-proportional DC voltage attenuation or gain connected ahead taken into account; entry of attenuation value (± 200 dB) via keyboard or IEC/IEEE bus
Attenuation compensation	numeric entry via keyboard or IEC/IEEE bus, or use of stored measured value
Reference value	numeric entry via keyboard or IEC/IEEE bus, or use of stored measured value
Reference impedance	for conversion between voltage and power, automatic readout of reference impedance from data store in the measuring head or numeric entry via keyboard or IEC/IEEE bus (for RF probe)
Remote control	control of all instrument functions via IEC 625/IEEE interface; interface functions: SH1, AH1, T6, L4, SR1, RL1, DC1, DT1, PPO
DC control input for frequency response correction	BNC female, ± 12 V, linear with selectable scale, input impedance 9 M Ω , max. input voltage 50 V
DC output	BNC female, source impedance 1 k Ω , output voltage (EMF) proportional to deflection of analog display, scale value: left 0 V, right +3 V, additional settling time 250 ms, error ≤ 5 mV, ripple typ. 5 mV (V_{pp})

Sensor Check Source NRV5-B1 (option)

Frequency	50 MHz, crystal-stabilized
Power	1.00 mW; factory-set to $\pm 0.7\%$ (traceable to PTB)
Deviation from nominal	1.2% max. (0.9% RSS) at 10 to 40 °C or 1.6% max. (1.2% RSS) at 0 to 50 °C, for 1 year in each case
SWR	1.05
RF connector	N female (at rear panel); N male/SMA female adapter for NRV-Z6/-Z52/-Z15/-Z55 included

General data

Temperature range	to DIN IEC 68-2-1/68-2-2
Operating	0 to +50 °C
Storage	-40 to +70 °C
Permissible humidity	max. 80%, without condensation
Sinusoidal vibration	5 to 55 Hz, max. 2 g; 55 to 150 Hz, 0.5 g cont. (DIN IEC 68-2-6, IEC 1010-1, MIL-28800 D, class 5 complied with)
Random vibration	10 to 500 Hz, 1.9 g rms (to DIN IEC 68-2-36)
Shock	40 g shock spectrum (to MIL-STD 810 D; DIN IEC 68-2-27 complied with)
EMC	to EN 50081-1 and 50082-1, EMC directive of EC (89/336/EEC) and EMC law of the Federal Republic of Germany; MIL-STD-461 C, RE 02, CE 03, RS 03, CS 02 complied with
Safety	to EN 61010-1
Power supply	115 V +15/-22% (-15%), 47 to 63 (440) Hz, 230 V +15/-22%, 47 to 63 Hz, 13 VA, power transformer with thermal overload protection
Dimensions (W x H x D), weight	219 mm x 103 mm x 350 mm, 3.2 kg

Ordering information

Order designation	Power Meter NRV5 1020.1809.02	
Option		
Sensor Check Source	NRV5-B1	1029.2908.02
Recommended extras		
Rack Adapter	ZZA-97	827.4527.00
Transit Case	UZ-24	1029.3379.02
Service Kit	NRV5-S1	1029.2708.02

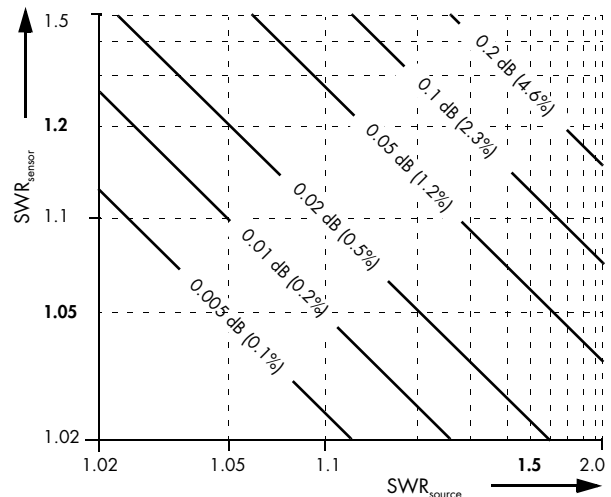

Maximum measurement error due to mismatch for source power available into 50 Ω (75 Ω). Values stated in dB and in % of power in W.



Fax Reply (Power Meter NRVS)

- Please send me an offer
- I would like a demo
- Please call me
- I would like to receive your free-of-charge CD-ROM catalog

Others: _____

Name: _____

Company/Department: _____

Position: _____

Address: _____

Country: _____

Telephone: _____

Fax: _____

E-mail: _____



ROHDE & SCHWARZ

ROHDE & SCHWARZ GmbH & Co. KG · Muehldorfstrasse 15 · 81671 Muenchen, Germany · P.O.B. 801469 · 81614 Muenchen, Germany

Telephone +49 89 41 29-0 · www.rohde-schwarz.com · CustomerSupport: Tel. +49 180 512 42 42, Fax +49 89 41 29-13777,

E-mail: CustomerSupport@rohde-schwarz.com