

Micro Vickers Hardness Testing Machines HM-200 Series

Bulletin No. 2055



Mitutoyo

Micro Vickers Hardness Testing Machines HM-200 Series

Equipped both with the latest optical system ideal for measuring the dimensions of indentation images and a test-force loading device that lets you set the desired The HM-200 series is ideal for quality control and mechanical characteristic evaluation using Vickers hardness testing of small areas.



Features

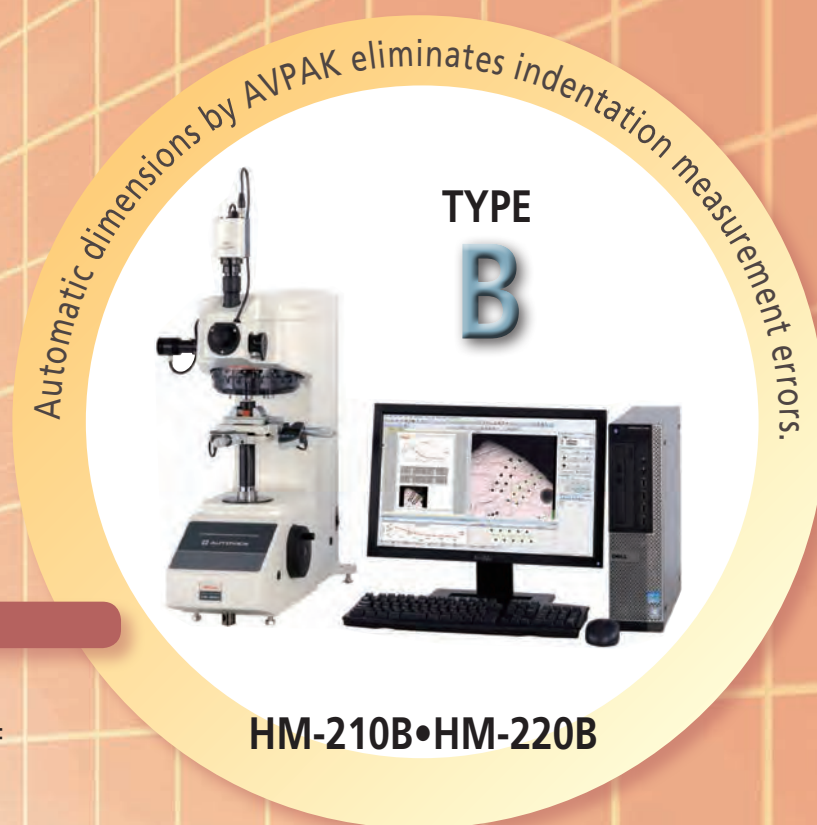

- Touch-panel operation
- Measurement of indentation dimensions using a measuring microscope
- Positioning using a manual XY stage unit

test force!



Features

- Operation using AVPAK
- Automatic measurement of indentations
- Positioning using a manual XY stage

	System A	System B
Functions		
Focusing	Manual	Manual
Testing action	Single point	Single point
Test-point positioning	Manual XY stage	Manual XY stage
Measuring indentations	Measuring microscope	Automatic (AVPAK)
Camera (for observing and measuring indentations)	Monochrome, 300,000 pixels*	Color, 3 million pixels
Operating the main unit	Touch panel	PC (AVPAK)

*When an optional video camera unit is used (pixel count of the camera itself: 380,000)

HM-210/220 Manual model main unit

High-functionality model Type A Systems

Measuring microscope

Microscope for measuring indentation dimensions
Integrated 10X eyepiece (810-354A video camera unit can be installed)

New

LED illumination unit

Uses an LED illumination unit that offers a long service life and low power consumption. LED illumination reduces the time lost during the light bulb replacement required with conventional illumination units.

Automatic turret mechanism

The positions of the indenter and the objective lens can be automatically switched using touch panel operation (can also be manually switched).

Up to four objective lenses can be installed.
Up to two indenter shaft units can be installed.

Interfacing to external instruments

Provided with a wide variety of interfaces to suit any purpose
Test results can be printed on a printer or output to a PC.

- USB 2.0 interface (for data communication)
For PC
- Digimatic interface
For DP-1VR, U-WAVE, and USB-ITN
- Serial interface
For DPU-414

Video camera unit 810-354A (For type A tester)

CCD camera and 8.4-inch TFT monitor
Enables observation and measurement of indentations at high magnification, thereby reducing operator error

Wide range of test force

Use of an electromagnetic method makes it possible to set the desired test force, between 0.4903 mN and 19610 mN. (HM-220)

New

Objective lenses provide a long working distance

Six MH Plan objectives are available. The 10X, 20X, 50X, and 100X types are used when measuring indentations, and the 2X and 5X for widefield observation tasks.

Manual XY stage unit with digital micrometer head

During test-site positioning, the positional information is displayed digitally and can also be displayed on the touch panel display controller
1"x1" (25x25mm) or 2"x2" (50x50mm) stroke can be selected.

Color touch panel controller

Touch panel operations for controlling hardness testing provide a full suite of basic functions necessary for hardness testing, a function for converting the hardness value into various types of hardness scales, and a statistical calculation function



HM-210/220 Type B System model main unit

High-functionality model Type B Systems

Measuring microscope (Can be installed as an option)

Enables magnified observation and measurement of indentations.
(The vision unit integrated in the system model main unit and the measuring microscope cannot be simultaneously used for observation.)

New

LED illumination unit

Uses an LED illumination unit that offers a long service life and low power consumption.
LED illumination reduces the time lost during the light bulb replacement required with conventional illumination units.

Automatic turret mechanism

The positions of the indenter and the objective lens can be automatically switched from a PC (AVPAK) (can also be manually switched). Up to four objective lenses can be installed.
Up to two indenter shaft units can be installed.

New

Vision unit

USB color mega-pixel camera
A 3-million pixel, 1/2-inch color USB camera is used for the system model.

Wide range of test force

Use of an electromagnetic method makes it possible to set the desired test force very accurately, between 0.4903 mN and 19610 mN. (HM-220)

New

Objective lenses provide a long working distance

Six MH Plan objectives are available. The 10X, 20X, 50X, and 100X types are used when measuring indentations, and the 2X and 5X for widefield observation tasks.

Manual XY stage unit with digital micrometer head (System B)

During test-site positioning, the positional information is displayed digitally.
1"x1" (25x25mm) or 2"x2" (50x50mm) stroke can be selected.

New

AVPAK software for automatic hardness testing systems

Software that supports control, testing, and report creation related to hardness testing
Supports parameter setting and automatic measurement.
Compatible with Windows 7 Professional 32-bit
Supports a wide-screen TFT and provides improved operability.



HM-200 Series AVPAK software for controlling Type B Systems

Multiple screen layouts for control, testing status, and result display.

Graphic view (of stored images)

For displaying the entire specimen and checking the pattern positioning
The digital zoom function can be used to easily magnify and check the site being tested.

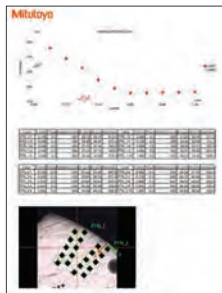
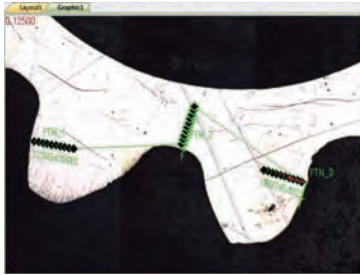

Layout view
Photos from individual views, graphs, tables, etc., can be laid out freely to help with report creation.

Part program

Automatically records the sequence of operations in a test
To repeat the same test, the part program can be called up for repeated execution.

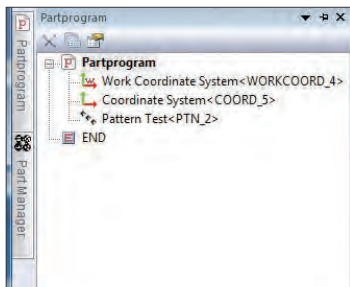

Test result view

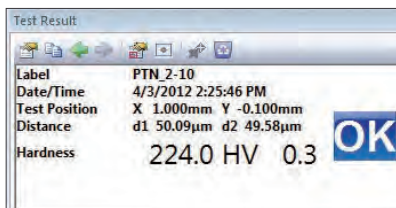

Parts manager

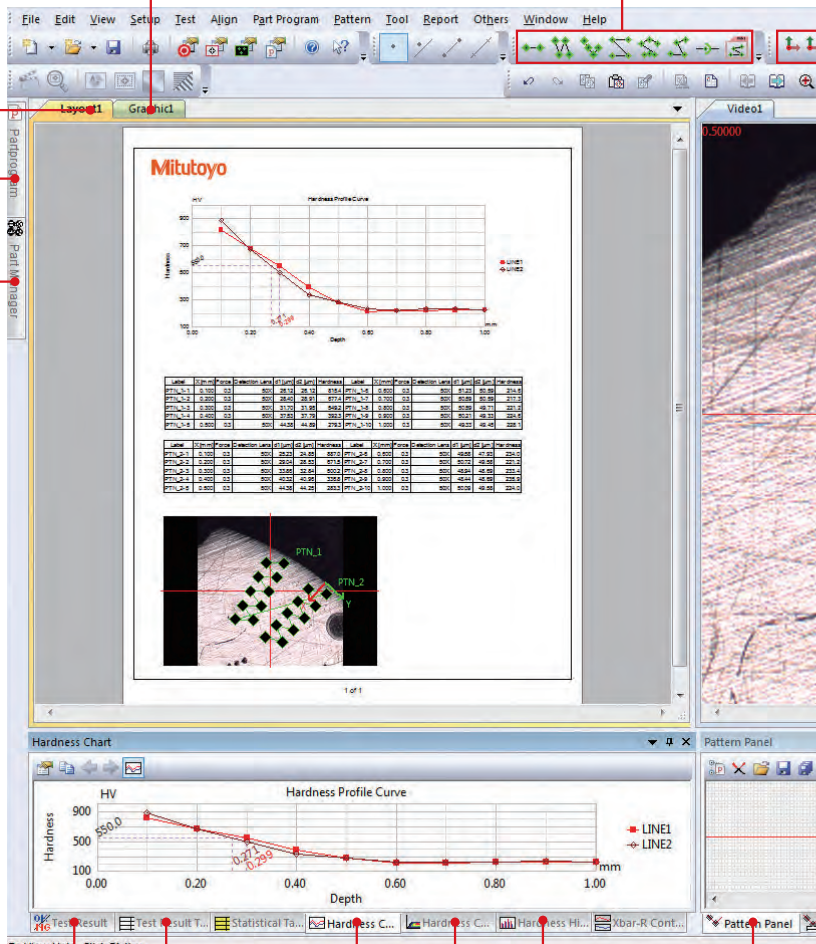

Test result list view

Hardness curve graph

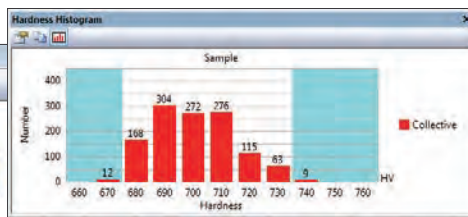

Hardness distribution diagram

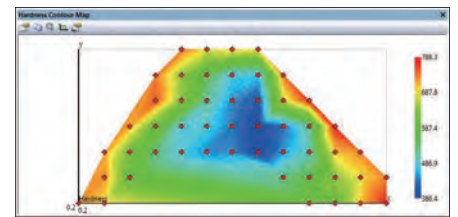

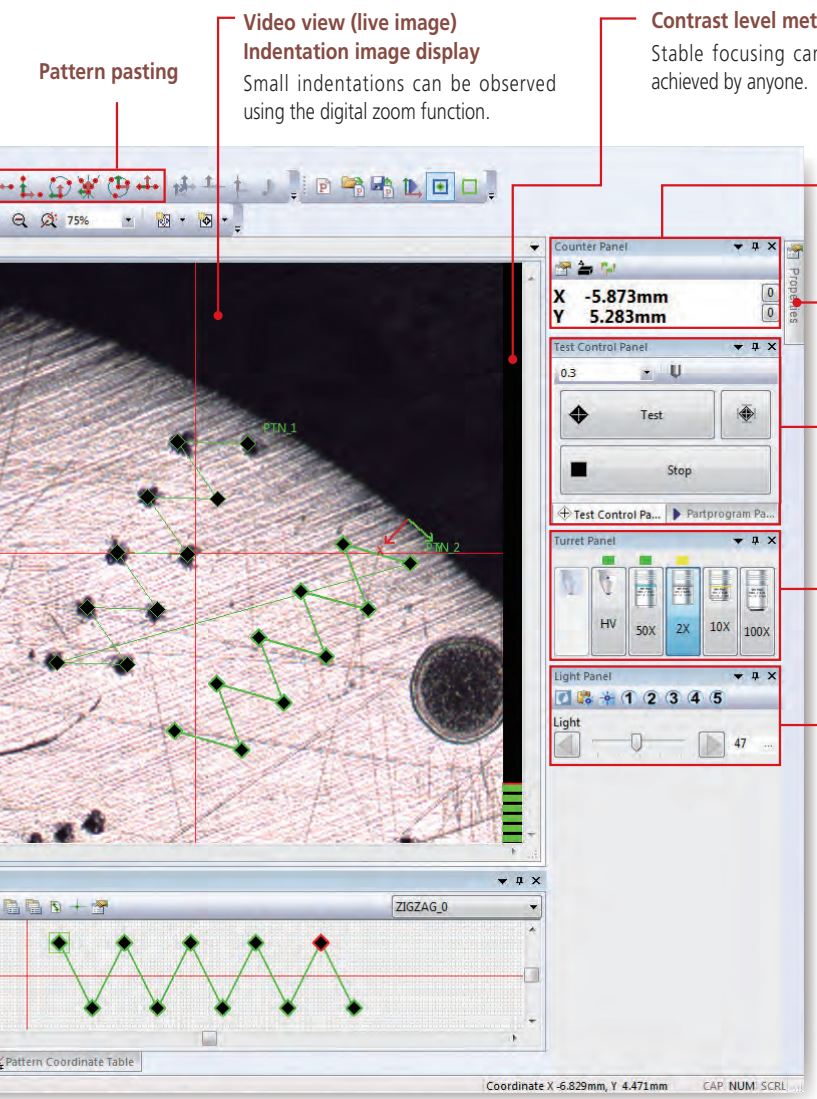

Pattern pasting

Video view (live image)
Indentation image display
 Small indentations can be observed using the digital zoom function.

Contrast level meter
 Stable focusing can be easily achieved by anyone.

Counter
 Displays the stage's current coordinates.

Property panel

Test control
 Controls testing actions such as wide- or narrow-range auto-focusing and measurement of indentations.

Turret control
 Switches the objective lens and indenter shaft

Illumination control
 Controls the illumination in 100 steps

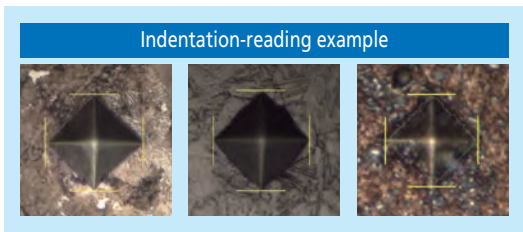

Indentation-reading example

Pattern panel

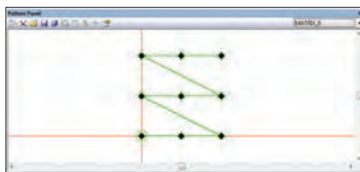
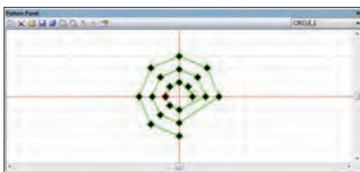

Frequency distribution graph

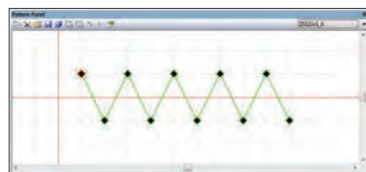
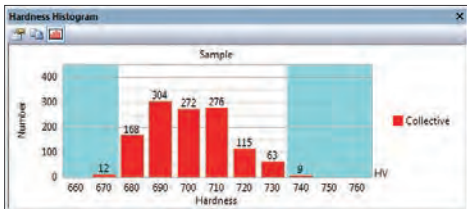

HM-200 Series AVPAK software for controlling Type B Systems

New functions

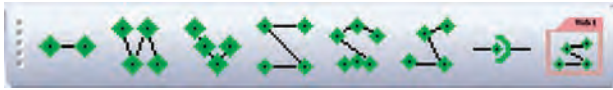

Pattern creation

This tool supports the creation of test patterns such as straight lines, zigzag lines, and teaching patterns.



Pattern pasting

This tool supports the pasting of created test patterns. It adjusts the origin, direction, etc., to paste a pattern.

Handling of multiple specimens

Multiple specimens can be tested when a part program and Parts Manager are used.

Parts Manager

Executes a common part program for specimens having the same shape



Reading of indentations

Improvement in image-processing performance has improved the indentation measurement function.

*measurement accuracy varies according to conditions.

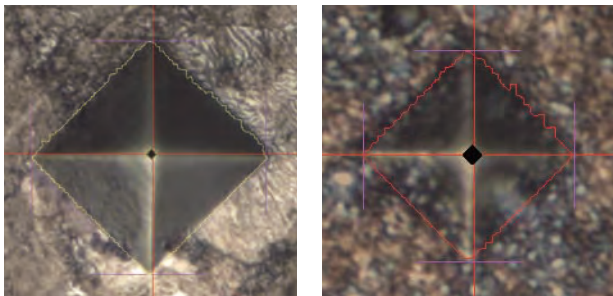

Indentation depth display

Displays the indentation depth of the diamond indenter while the testing force is being applied. (Reference value)

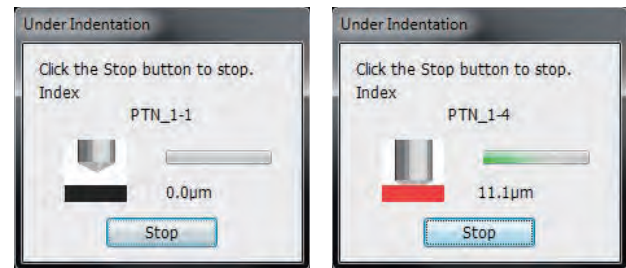

Property panel

Used for setting the test conditions such as the test force and load time, as well as the indentation measurement condition.

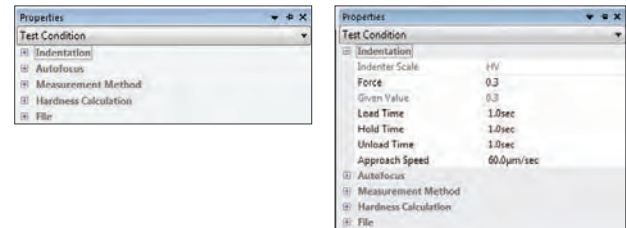

Navigation function

When the test position is being moved during multi-point testing, this function guides the travel of the XY fine adjustment manual stage to the next position.



HM-200 Series

Touch-panel control screen & System outline drawing

Touch-panel control screen

Easy-to-understand graphic display enables intuitive operation. Functions for converting values and compensating for curved surfaces, as well as a test condition guiding function are all provided as standard features.
(Installed in the manual model main unit)

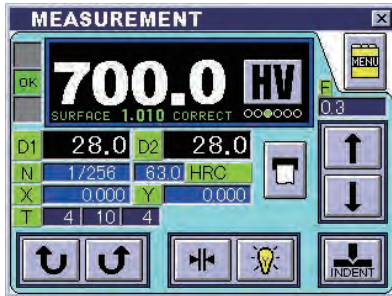

Displays test conditions and test results.

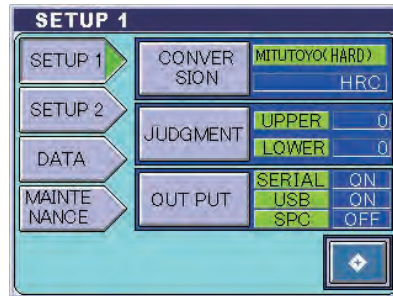

Used for selecting a conversion scale, entering a setting for Pass/Fail determination, and specifying external output.

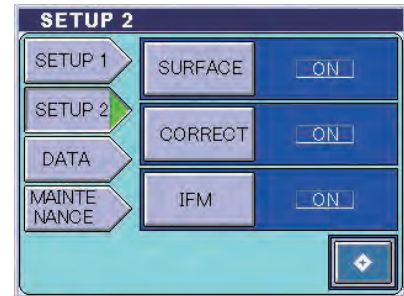

Used for selecting a conversion scale, entering a setting for Pass/Fail determination, and specifying external output.

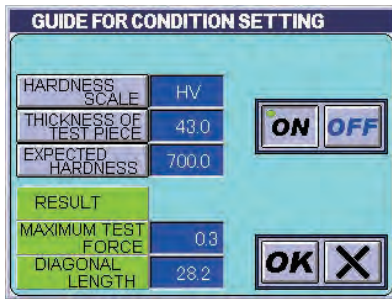

By entering the specimen thickness and the presumed hardness, you can set a test force that satisfies the JIS conditions.



In addition to the test force dwell time, you can specify loading and unloading testing actions.

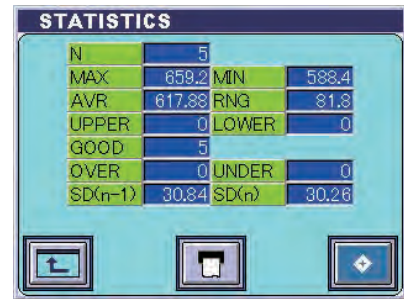

You can check the test results in a statistical list.

System A Outline drawing

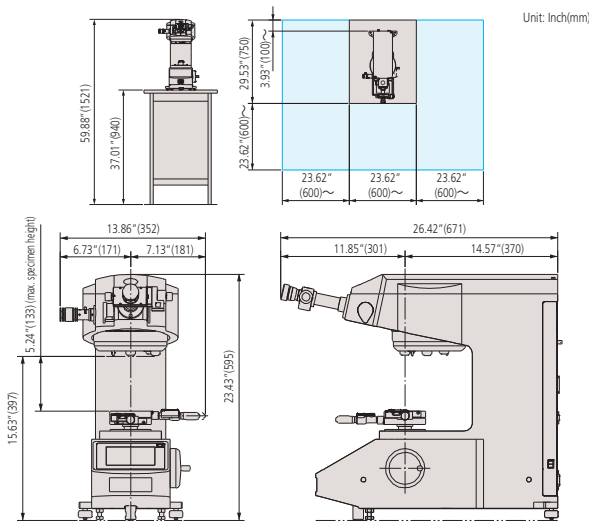

* When the .98"x.98" (25x25mm) manual XY stage is used

System B Outline drawing

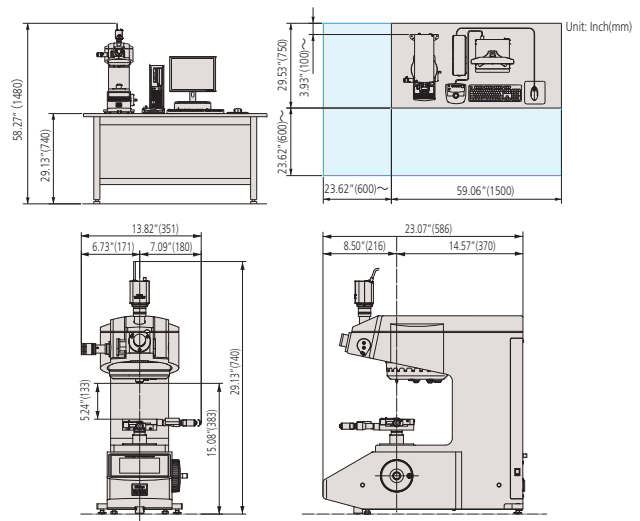

* When the .98"x.98" (25x25mm) manual XY stage is used

■ System configurations

	Code No.	Item Name	Details	Notes	
Standard Configurations	64AAB305	HM210 Type A	Standard test force, 10x, 50x, measuring microscope, 1" x 1" Digimatic X-Y stage	Vickers Indenter	
	64AAB306	HM210 Type A	Standard test force, 10x, 20x, 50x, measuring microscope, 1" x 1" Digimatic X-Y stage	Vickers and Knoop Indenters	
	64AAB307	HM220 Type A	Low test force, 10x, 50x, 100x, measuring microscope, 1" x 1" Digimatic X-Y stage	Vickers Indenter	
	64AAB308	HM220 Type A	Low test force, 10x, 50x, 100x, measuring microscope, 1" x 1" Digimatic X-Y stage	Vickers and Knoop Indenters	
	64AAB323	HM210 Type B	Standard test force, 10x, 50x, AVPAK Software, camera, 1" x 1" Digimatic X-Y stage	Vickers Indenter, Requires PC, no microscope or manual control console	
	64AAB324	HM210 Type B	Standard test force, 10x, 20x, 50x, AVPAK Software, camera, 1" x 1" Digimatic X-Y stage	Vickers and Knoop Indenters, Requires PC, no microscope or manual control console	
	64AAB325	HM220 Type B	Low test force, 10x, 50x, 100x, AVPAK Software, camera, 1" x 1" Digimatic X-Y stage	Vickers indenter, Requires PC, no microscope or manual control console	
	64AAB326	HM220 Type B	Low test force, 10x, 50x, 100x, AVPAK Software, camera, 1" x 1" Digimatic X-Y stage	Vickers and Knoop Indenters, Requires PC, no microscope or manual control console	
Factory installed options for custom built testers*	11AAC104	Objective lens unit 2X	Objective lens, with lens holder	Up to three additional lenses can be selected (maximum of four lenses can be installed in the main unit)	
	11AAC105	Objective lens unit 5X	Objective lens, with lens holder		
	11AAC106	Objective lens unit 10X	Objective lens, with lens holder		
	11AAC107	Objective lens unit 20X	Objective lens, with lens holder		
	11AAC108	Objective lens unit 100X	Objective lens, with lens holder		
	11AAC109	Indenter shaft unit for HM-210	With 19BAA061 Knoop indenter	Double-indenter specification	
	11AAC110	Indenter shaft unit for HM-220	With 19BAA062 Knoop indenter	Double-indenter specification	
	11AAC129	Measuring microscope (which can be added)		Cannot be used simultaneously with the VISION UNIT	
	810-420	Manual XY stage unit 25X25mm			
	810-423	Manual XY stage unit 50X50mm			
	810-424	Manual XY stage unit 1"x1"			
	810-427	Manual XY stage unit 2"x2"			
	11AAC063	AVPAK v1 J		Japanese	
	11AAC064	AVPAK v1 E		English	
Optional accessories	810-354A	Video camera unit	Monochrome 300,000-pixel camera, 8.4-inch TFT, with a stand	Type B Installation requires a measuring microscope. Provided on a special order basis	
	810-016	Standard 2 jaw vise	Jaw opening: 51 mm		
	810-017	Special vise	Jaw opening: 100 mm		
	810-013	Thin plate specimen holder	Thickness: Max. 5 mm		
	810-014	Slender specimen holder (horizontal)	Diameter: 0.4-3 mm		
	810-015	Slender specimen holder (vertical)	Diameter: 0.4-4 mm		
	810-019	Specimen-tilting holder	Jaw opening: 37 mm, Tilting angle: ±15°, Rotating angle: ±25°		
	810-020	Universal specimen holder	Thickness: Max. 30 mm		
	810-018	Turntable	Minimum graduation: 1°		
	810-085	Adjustable thin-plate specimen holder	Thickness: Max. 3 mm, Width: Max. 56 mm		
	810-095	Rotatable tilting specimen holder	Height: Min. 20 mm, Width and diameter: 15-55 mm		
	810-870A	Specimen heater HST-250		Cannot be automatically read with AVPAK	
	810-650-1	Resin-molded specimen holder Ø25.4	Ø25.4±0.5 mm Specimen height: 9-39 mm		
	810-650-2	Resin-molded specimen holder Ø30	Ø30±0.5 mm Specimen height: 9-39 mm		
	810-650-3	Resin-molded specimen holder Ø31.75	Ø31.75±0.5 mm Specimen height: 9-39 mm		
	810-650-4	Resin-molded specimen holder Ø38.1	Ø38.1±0.5 mm Specimen height: 9-39 mm		
	810-650-5	Resin-molded specimen holder Ø40	Ø40±0.5 mm Specimen height: 9-39 mm		
	19BAA061	Knoop indenter (for standard test force)			
	19BAA062	Knoop indenter (for low test force)			
	375-056	Objective micrometer	Scale graduation: 1 mm, Minimum graduation: 0.01 mm	For magnification verification	
	Printers	02AGD600B	Model DPU-414 (with a connection cable)	Receipt printer	
		264-504-05A	Model DP-1VR	Digimatic mini-processor	
		936937	Connection cord	For DP-1VR 1 m	
02AZD810D		U-WAVE-R			
02AZD880D		U-WAVE-T	Buzzer type		
02AZD790D		Dedicated connection cable for U-WAVE-T			
06ADV380D		USB-ITN-D	Flat 10-pin	PC must be provided separately.	

* Please contact Mitutoyo for information on custom built testers.

Specifications Main Unit

Model name			HM-210 Type A	HM-210 Type B							
Main unit	HM-210 manual model main unit	810-400A	○	-							
	HM-210 system model main unit	810-403A	-	○							
Hardness tester	Applicable standards	JIS B 7725 / ISO 6507-2 / ASTM E 384									
	Test force	Hardness symbol	HV0.01	HV0.02	HV0.03	HV0.05	HV0.1	HV0.2	HV0.3	HV0.5	HV1
		N	98.07x10 ⁻³	196.1x10 ⁻³	294.2x10 ⁻³	490.3x10 ⁻³	980.7x10 ⁻³	1.961	2.942	4.903	9.807
	(gf)	(10)	(20)	(30)	(50)	(100)	(200)	(300)	(500)	(1000)	
	Indenter approach speed	Fixed at 60 μm/s									
	Test force loading time	1- 99s Can be set in 1s increments.									
Test force dwell time	0-999s Can be set in 1s increments.										
Test force unloading time	1- 99s Can be set in 1s increments.										

Model name			HM-220 Type A	HM-220 Type B								
Main unit	HM-220 manual model main unit	810-405A	○	-								
	HM-220 system model main unit	810-408A	-	○								
Hardness tester	Applicable standards	JIS B 7725 / ISO 6507-2 / ASTM E 384										
	Test force	Hardness symbol	HV0.0005	HV0.001	HV0.002	HV0.003	HV0.005	HV0.01	HV0.02	HV0.03	HV0.05	HV0.1
		N	0.4903x10 ⁻³	0.9807x10 ⁻³	1.961x10 ⁻³	2.942x10 ⁻³	4.903x10 ⁻³	9.807x10 ⁻³	19.61x10 ⁻³	29.42x10 ⁻³	49.03x10 ⁻³	98.07x10 ⁻³
	(gf)	(0.05)	(0.1)	(0.2)	(0.3)	(0.5)	(1)	(2)	(3)	(5)	(10)	
	Test force	Hardness symbol	HV0.02	HV0.03	HV0.05	HV0.1	HV0.2	HV0.3	HV0.5	HV1	HV2	
		N	196.1x10 ⁻³	294.2x10 ⁻³	490.3x10 ⁻³	980.7x10 ⁻³	1.961	2.942	4.903	9.807	19.61	
(gf)	(20)	(30)	(50)	(100)	(200)	(300)	(500)	(1000)	(2000)			
Indenter approach speed	Variable between 2 and 60 μm/s Can be set in 1μm/s increments (only for 30 gf or smaller; Fixed at 60 μm/s for 31 gf or greater)											
Test force loading time	1- 99s Can be set in 1s increments.											
Test force dwell time	0-999s Can be set in 1s increments.											
Test force unloading time	1- 99s Can be set in 1s increments.											

Mechanism	Loading device	Test force control	Electromagnetic (voice coil)	
		Test force switching	Touch panel	AVPAK
	Turret	Drive method	Motor drive	
		Operation method	Touch panel / Manual	AVPAK / Manual
	Number of turret ports	Indenter shaft unit: Up to two can be installed (including the standard Vickers indenter shaft unit already installed); Objective lens unit: Up to four can be installed		
Controller	Display content	Indentation value	Integrated touch panel (5.7-inch color LCD)	
		Minimum display unit	D1 D2, max. 5 digits each	
		Hardness value	For objective lenses of 50X or higher: 0.01 μm; For lower than 50X: 0.1 μm	
		Test condition	Maximum of four digits, Minimum: 0.1 HV/HK, Fracture toughness value	
		Test condition	Indenter (HV/HK), test force, loading, dwell, and unloading times	
		Compensation	Cylinder, sphere, measurement	
	Calculation functions	Pass/Fail determination	OK/±NG	
		Other	XY positional data, turret position display, statistical calculation	
		Language used	Japanese, English, German, French, Italian, Spanish	
		Pass/Fail determination function	Determines whether or not the measured hardness is acceptable (OK/±NG) based on the upper and lower limits that have been set.	
Function for guiding measurement condition setup	Enter the indenter, specimen thickness, and presumed hardness to calculate the maximum test force.			
Compensation function	Cylindrical compensation, spherical compensation, measurement compensation			
Statistical calculation function	Number of data units, maximum value, minimum value, average, range, upper limit, lower limit, number of passes, number of fails, ultra upper limit and ultra lower limit, standard deviation (n-1), standard deviation (n)			
External connection interface		For printer: Serial interface (compatible with the RS-232C standard); For Digimatic interface and data communication: USB 2.0		
	Maximum specimen dimensions	Maximum specimen depth: 160 mm, Maximum specimen height: 133 mm		
	Maximum load capacity	3kg		
Main unit	External dimensions (excluding protrusions and stage)	Approx. 315 (W) x 671 (D) 595 (H) mm		
	Main unit mass	Approx. 43 kg		
Main unit power supply		AC100-125V		

- Software (AVPAK) functions**
- Tester and turret control functions
 - Hardness conversion, compensation for curved surface, Pass/Fail determination, and statistical calculation
 - measurement of indentations, illumination control
 - Contrast level meter
 - Specification of test pattern and coordinate system
 - Simple operations
 - Analysis and report

Specifications Optical system

Item name	HM-210 Type A manual model main unit	HM-220 Type A manual model main unit	HM-210 Type B system model main unit	HM-220 Type B system model main unit
Optical system	Infinitely corrected optical system, 4-port objective lens switching method			
Tube lens magnification	1x			
Illumination	Light source	White LED		
	Aperture diaphragm	Variable		
Standard objective lens	Lens	MH Plan 50x		
	Working distance [mm]	2.5		
	Real field of view and imaging range	Real field of view: ø0.14 mm		Imaging range: 0.118 (H) mm x 0.089 (V) mm
Measuring microscope (Ocular)	Length-measuring microscope with integrated encoder and eyepiece (10X)			Factory-installed options
Objective lens unit (including holder) (factory-installed options)	MH Plan 2x	MH Plan 5x	MH Plan 10x	MH Plan 20x
Part No.	11AAC104	11AAC105	11AAC106	11AAC107
Working distance [mm]	6	27	11.8	5.2
Measurement range [Ø mm]	3.5 (reference)	1.4 (reference)	0.7	0.35
Imaging range [(H) mm x 0.089 (V) mm] (Vision unit)	2.95x2.21	1.18x0.89	0.59x0.44	0.30x0.22
				0.059x0.044

■ Specifications Manual XY stage unit

Systems A and B

Item name	Manual XY stage unit 1"x1"	Manual XY stage unit 2"x2"	Manual XY stage 25X25	Manual XY stage 50X50
Code No.	810-424	810-427	810-420	810-423
Stage travel range	25.4x25.4mm	50.8x50.8mm	25x25mm	50x50mm
Table size	100x100mm	130x130mm	100x100mm	130x130mm
Minimum display unit	0.001mm/0.0005"		0.001mm	
XY stage dimensions	221(W)x221(D) x37(H)mm	305(W)x305(D) x49(H)mm	221(W)x221(D) x37(H)mm	305(W)x305(D) x49(H)mm
XY stage mass	2.5kg	6.6kg	2.5kg	6.6kg

■ Specifications Video camera unit

System A

Item	Description
TFT screen magnification	10X: Approx. 200 times
	50X: Approx. 1000 times
	100X: Approx. 2000 times
CCD camera	Imaging method: EIA
	Imaging device: 1/3-inch interline CCD
	External dimensions:31(W)x72.5(D)x29(H)mm
	Mass:85g
TFT monitor	Screen size: 210.4 mm diagonal (8.4-inch)
	Number of pixels:640(H)x480(V)
	Rotation range:350°
	Tilting range:-5-40°
	Power supply:AC100-230V50/60Hz
	Power consumption:12VA
	External dimensions:228(W)x61.5(D)x195(H)mm [232 (W) x 227 (D) x 426.5 (H) mm (when installed on the stand)]
	Mass: 1.8 g (4.2 kg including the stand)

■ Standard accessories

Code No.	Item name	Specification/Remarks	Quantity
19BAA058	Diamond indenter ^{*1}	Vickers for HM-210	1
19BAA059	Diamond indenter ^{*1}	Vickers for HM-220	
-	Hardness testing block ^{*2}	700HMV0.3 25 mm (diameter) x 6 mm (thickness)	1
-	Indenter shaft unit ^{*1}	With Vickers indenter	1
-	Objective lens unit 50X*1		1
19BAA133	Spacer	Material: Bakelite 11 (W) x 42 (D) x 13 (H) mm	1
11AAB405	Extension shaft	For elevation shaft: 38 mm With two set screws	1
11AAB406	Extension shaft	For elevation shaft: 76 mm With two set screws	1
02DEA471	Dust cover	For the hardness tester main unit	1
-	Plastic Phillips screwdriver	No.1300 Phillips 2x100	1
-	Precision flathead screwdriver	No.205 flathead 1.2	1
-	Hex-head screwdriver	1.5 mm	1
-	Hex-head screwdriver	2.5 mm	2
-	Hex wrench	2.5 mm	1
-	Hex wrench	3.0 mm	1
-	Holder	Hanger bolt for the main unit	4
-	Cap ^{*1}	Cap for the holder	4
-	Cable clamp	Gray	2
-	Cable clamp	Black	2
-	Spiral tube	Black, approx. 2 m	1
02ZAA000	Power supply cord set -PSE	Classification: Unmarked/C	1
02ZAA010	AC cord set-UL/CSA	Classification: A	1
99MBG127A	User's manual for the manual model main unit	English	1
99MBG137A	User's manual for the system model main unit	English	1
11AAC198	Configuration disk	For the system main unit	1
11PAA074	Accessory case		1
-	Certificate for the tester	In both Japanese and English	1
-	Certificate for the hardness test block	In both Japanese and English	1
-	Warranty	In both Japanese and English	1

*1 Already installed in the main unit when it is delivered.

*2 The numeric values shown are nominal; actual values will be slightly above or below the nominal values.

Note: All information regarding our products, and in particular the illustrations, drawings, dimensional and performance data contained in this printed matter as well as other technical data are to be regarded as approximate average values. We therefore reserve the right to make changes to the corresponding designs. The stated standards, similar technical regulations, descriptions and illustrations of the products were valid at the time of printing. In addition, the latest applicable version of our General Trading Conditions will apply. Only quotations submitted by ourselves may be regarded as definitive. Specifications are subject to change without notice.

Mitutoyo products are subject to US Export Administration Regulations (EAR). Re-export or relocation of our products may require prior approval by an appropriate governing authority.

Trademarks and Registrations

Designations used by companies to distinguish their products are often claimed as trademarks. In all instances where Mitutoyo America Corporation is aware of a claim, the product names appear in initial capital or all capital letters. The appropriate companies should be contacted for more complete trademark and registration information.

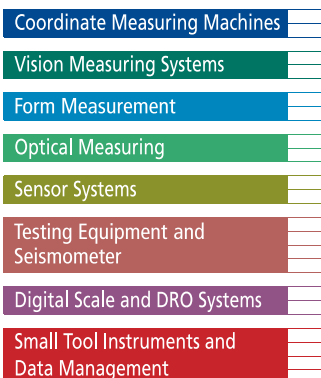

Mitutoyo America Corporation

www.mitutoyo.com

One Number to Serve You Better
1-888-MITUTOYO (1-888-648-8869)

M³ Solution Centers

Aurora, Illinois
(Corporate Headquarters)

Westford, Massachusetts

Huntersville, North Carolina

Mason, Ohio

Plymouth, Michigan

City of Industry, California

Birmingham, Alabama

Mitutoyo
Precision is our Profession