

Multi Function Measuring Systems
RIONOTE

Instruction Manual



Manuals Provided with The unit

The following manuals are provided with the unit.

RIONOTE Instruction Manual (This Manual)

Explains the functions, operating and setup procedures of the RIONOTE. It also describes how to operate and configure the Waveform Recording Program "SX-A1WR".

HTML for Instruction Manual Application

The HTML help that describes settings for RIONOTE and SX-A1WR. This help can be viewed using the Instruction Manual Application provided with the unit. Also, the online help that converts the HTML for Instruction Manual Application into a chm file is included in the CD-ROM provided with the unit.

* Viewing the chm file

If nothing is displayed by opening the online help file (*.chm), right-click the file, select Properties, and click the "Unblock".

Overview of This Manual

This manual mainly describes the functions and operations of RIONOTE and SX-A1WR. When the measuring system is used with another device, be sure to read the manual of the device for the operation.

This manual contains the following sections.

Preparation Before Use

Part Names and Functions

Describes the names and functions of ports and other parts of RIONOTE.

Attaching/Removing the Battery

Describes how to attach or remove the battery.

Charging

Describes how to charge the battery.

SD memory card

Describes how to attach or remove an SD memory card.

Amplifier unit

Describes how to attach or remove the amplifier unit.

Powering On/Off

Describes how to power on/off RIONOTE.

Auto Screen Off

Describes the function of auto screen off.

Connecting External Devices

Describes the ports of the amplifier unit and connection of sensors.

Connecting the Voice memo microphone/Earphones

Describes how to connect a voice memo microphone or earphones.

Connecting to Computer

Describes how to connect RIONOTE to a computer.

Configuring The unit

HOME Screen

Describes the RIONOTE HOME screen and operations on the screen.

Configuring The unit

Describes the RIONOTE settings.

Managing the Amplifier Unit

Describes the settings or operations related to the connected amplifier unit.

Configuring the Calibration

Describes the settings or operations on the Input settings screen.

Managing the Program/System

Describes the program/system related operations such as installing a program on RIONOTE and upgrading the system version.

SA-A1 File Converter

Describes how to install or operate the SA-A1 file converter.

Input Setting Details

Describes the items on the input settings screen.

About the Calibration

Describes the details about calibrating the sensors connected to the amplifier unit.

Specifications

Provides the RIONOTE specifications.

Waveform Recording Program SX-A1WR

SX-A1WR Overview

Describes the overview of this program.

Screen Layout

Describes the layout of the screen displayed.

Starting/Exiting the SX-A1WR

Describes how to start and exit this program.

Measuring Wave

Describes the measurement related operations using this program such as how to start and stop measurement.

Voice Memo/Marker

Describes the voice memo and marker.

Operating the Project

Describes the project related operations such as how to open and delete a project.

Operating Recall Screens

Describes the operations on the Recall screen.

Operating Graphs

Describes the graph operations on the Measurement or Recall screen.

Settings

Describes how to configure the setting items on the Measurement settings screen.

Items on Measurement Settings Screen

Describes the items on the measurement settings screen.

WAVE File Format

Describes the WAVE file format used for saving.

Approximate recording times

Provides the approximate recording times available with an SD memory card inserted in the unit.

Specifications

Provides the specifications of this program.

* Company names and product names mentioned in this manual are usually trademarks or registered trademarks of their respective owners.

Safety Precautions

Disclaimers

- RION Co., Ltd. will not be liable for any damages arising from natural disasters such as earthquakes, lightning, storms and floods, as well as fires through no fault of RION Co., Ltd., acts by third-parties, other accidents, improper use by the user, whether intentionally or negligently, or use under other abnormal conditions.
- RION Co., Ltd. will not be liable for any incidental damages arising from the use or inability to use the unit (such as corruption or loss of recorded data, lost business revenue, or suspension of business operations).
- RION Co., Ltd. will not be liable for any damages arising from use not in accordance with the instructions in this manual.
- RION Co., Ltd. will not be liable for any damages arising from malfunctions caused by use in combination with any connected equipment and/or software not authorized by RION Co., Ltd.
- RION Co., Ltd. will not be liable for any damages or lost revenue resulting from recovery of recorded data that is corrupted or lost due to failure, repair, or other operations of the unit.

For Safe Operation

Explanation of Displays and Symbols

The following messages are displayed in this manual to warn and protect users from potential danger:

These are necessary to secure the lives and health of the user and prevent the unit and peripheral equipment from being damaged.

Warning

- Disregarding such information may cause a dangerous situation where personal safety cannot be ensured.

Note

- Disregarding such information may cause injury to people or damage to equipment around them.

Important

- Disregarding such information may cause malfunction of the unit.

MEMO

- It does not directly affect the safety but includes information that assists in ensuring correct and efficient use of the unit.

Precautions

RIONOTE Precautions

Lithium-ion rechargeable battery

Warning

- This unit is designed to be powered from a dedicated rechargeable lithium ion battery. Do not use any other kind of battery. Otherwise there is a risk of malfunction, damage, overheating, smoke emission etc.

Precautions

Note

- Do not attempt to play the supplied CD-ROM disc in an audio CD player. Inserting the disc into an audio CD player poses the risk of excessive volume levels. This could cause hearing damage and result in damage to the player.
- Do not subject the touch panel of the unit to strong force or shock. Otherwise the panel may break, involving the risk of laceration or damage to peripheral equipment.
- Do not use this unit for an extended time in contact with any part of your body. The unit and the battery may become warm, involving the risk of burns or low-temperature burns.
- If you notice any sign of a problem such as overheating, smoke emission etc., disconnect the AC adapter and remove the battery.
- Take care when handling the unit to avoid the risk of laceration or other injury from the connector section.
- Take care not to drop the unit on someone to avoid the risk of bruises or other injury.

Important

- During use and storage of the unit, avoid proximity to heat sources (including equipment that may get hot) or open fire (including stoves, gas cookers etc.).
- Remove the battery while not using the unit.
- We recommend to have the packing inside the case, the bumper, and the cover replaced regularly (fare-paying service). The recommended replacement cycle is two years. If more than two years have elapsed, water resistant performance of the unit will no longer be guaranteed. Regarding replacement of these parts, please contact your supplier.

Connection related precautions

 Note	<ul style="list-style-type: none"> - When earphones or headphones are connected to the earphone jack of the unit, high volume levels may be produced. To prevent the risk of excessive levels due to differences in gain, use only the monitoring earphones available as an option from RION. - Do not apply signals with a voltage exceeding the rated maximum input voltage range to the input/output terminals and voice memo microphone jack. Otherwise the unit may be damaged by excessive voltage and there is a risk of electric shock or fire. - Connect only supplied RION products or the AC adapter available as an option from RION to the power jack. - The LAN port, USB miniB port, and USB port of the unit must only be used in compliance with the respective standards. Otherwise the unit may be damaged by excessive voltage and there is a risk of electric shock or fire.
Important	<ul style="list-style-type: none"> - Do not touch the docking connector of the unit with your fingers. Otherwise there is a risk of damage or malfunction.

Measurement at exposed rotating part or power transmitting part

 Warning	<ul style="list-style-type: none"> - Take care so that any cables connected to the unit will not get caught in rotating machinery or similar. - Do not use the shoulder strap when measuring the parts such as exposed rotating part and power transmitting part. If the shoulder strap is caught in a rotating machine or the like, the operator may also be caught in the machine.
--	--



Amplifier unit SA-A1B2/B4 Precautions

Precautions	
 Note	<ul style="list-style-type: none"> - Do not use this unit for an extended time in contact with any part of your body. The unit and the battery may become warm, involving the risk of burns or low-temperature burns. - If you notice any sign of a problem such as overheating, smoke emission etc., disconnect the AC adapter and remove the battery. - Take care not to drop the unit on someone to avoid the risk of bruises or other injury.
Important	<ul style="list-style-type: none"> - Do not remove this product from RIONOTE with this device powered on. Otherwise there is a risk of damage or malfunction of the unit..



Connection related precautions	
 Note	<ul style="list-style-type: none"> - Do not apply signals with a voltage exceeding the rated maximum input voltage range to the input/output terminals. Otherwise the unit may be damaged and there is a risk of electric shock or fire. - The USB miniB port of the unit must only be used in compliance with the respective standard. Otherwise the unit may be damaged by excessive voltage and there is a risk of electric shock or fire. - Do not use the docking connector except for connection to the RIONOTE. Otherwise the unit may be damaged and there is a risk of electric shock or fire. - Take care when handling the unit to avoid the risk of laceration or other injury from the connector section.
Important	<ul style="list-style-type: none"> - Do not touch the docking connector of the unit with your fingers. Otherwise there is a risk of damage or malfunction of the unit.

Measurement at exposed rotating part or power transmitting part	
 Warning	<ul style="list-style-type: none"> - Take care so that any cables connected to the unit will not get caught in rotating machinery or similar. - Do not use the shoulder strap when measuring the parts such as exposed rotating part and power transmitting part. If the shoulder strap is caught in a rotating machine or the like, the operator may also be caught in the machine.

Battery Precautions

Safety precautions	
 Warning	<p>Ignoring the following precautions may cause the lithium-ion rechargeable battery to explode, break, ignite, produce heat, etc. which may result in a dangerous situation where personal safety cannot be ensured.</p> <ul style="list-style-type: none"> - If a problem has occurred at the location where the battery is stored (explosion, rupture, combustion), do not approach the location because there may be flammable or harmful gases. - If you notice deformation, fluid leakage, or any other sign of a problem when opening the package in which the battery was shipped, do not use the battery and contact the supplier. - Use the battery only in the product it is designed for. - Do not heat the battery or throw it into a fire. - Do not try to disassemble or modify the battery. - Do not charge or use the battery with the positive (+) and negative (-) terminals reversed. - Do not short-circuit the positive (+) and negative (-) terminals of the battery. - Do not subject the battery to strong shocks, and do not throw or drop it. - Do not use the battery if it has been dropped or is deformed. - If the battery gets unusually warm, immediately stop using it. - If the battery looks deformed or bloated or has cracks, immediately stop using it. - If the battery has a fluid leak, immediately stop using it.
 Note	<ul style="list-style-type: none"> - If battery fluid has come into contact with your eye(s), immediately consult a doctor.
Important	<ul style="list-style-type: none"> - Do not place any conductive objects such as metal tools etc. on the battery and take care not to drop such objects on the battery. Otherwise there is a risk of short-circuiting. - When charging the battery (either standalone or inserted in the RIONOTE), use only the AC adapter specified by RION. - Clean the battery only by wiping it with a dry cloth. Do not use any organic solvents (cleaning alcohol, benzene, paint thinner etc.) on the battery. Otherwise there is a risk of deformation, discoloration, or damage to the plastic parts of the battery.

Environment related precautions	
! Warning	<p>Ignoring the following precautions may cause the lithium-ion rechargeable battery to explode, break, ignite, produce heat, etc. which may result in a dangerous situation where personal safety cannot be ensured.</p> <ul style="list-style-type: none">- During use and storage of the battery, avoid locations subject to direct sunlight and other locations that may get hot, such as an asphalt surface in summer.- During use and storage of the battery, avoid proximity to heat sources (including equipment that may get hot) or open fire (including stoves, gas cookers etc.).- Do not allow the battery to get wet. Moisture may also lead to corrosion of the terminals and connector plate.- The usage temperature range for the battery is as follows. If the battery is used in conditions outside this range, it may degrade faster and freezing or overheating may occur, involving the risk of damage and deformation. <p>Usage temperature range: -10°C to +40°C</p> <p>Temperature range during charging: +5°C to +35°C</p> <p style="padding-left: 200px;">(Both no condensation)</p> <ul style="list-style-type: none">- Do not use or store the battery in locations with high levels of dust. Otherwise there is a risk of short-circuiting.
Important	<ul style="list-style-type: none">- Turn off the power of the RIONOTE when the battery is attached to the RIONOTE for charging.- Using the battery in a low temperature environment will shorten its service life.- Condensation forming on the battery may lead to rust or other problems. Use the battery so as to avoid condensation.

Transport related precautions	
Laws/ regulations	- If the battery is to be transported by air or by sea, follow the instructions of the shipper.
 Warning	Ignoring the following precautions may cause the lithium-ion rechargeable battery to explode, break, ignite, produce heat, etc. which may result in a dangerous situation where personal safety cannot be ensured.
	<ul style="list-style-type: none"> - When transporting the battery, take care not to drop it. Otherwise the internal circuitry may be damaged and there is a risk of overcurrent, overheating, rupture, or combustion. - Do not transport a damaged battery by air.
 Note	- Do not carry the battery while holding it by the connector section. Otherwise there is a risk of electric shock or damage.
Important	- When transporting the battery, as when changing the system installation location, do not throw the battery or otherwise subject it to strong shocks from hitting, dropping etc. Otherwise there is a risk of damage.

Disposal related precautions	
Laws/ regulations	- For disposal, the battery must be handled as industrial waste. Do not throw the battery out with regular household trash. For disposal, contact the supplier. (Alternatively, have the battery disposed of by a licensed operator in compliance with waste disposal laws and environmental regulations.)
 Warning	Ignoring the following precautions may cause the lithium-ion rechargeable battery to explode, break, ignite, produce heat, etc. which may result in a dangerous situation where personal safety cannot be ensured.
	- Even a battery destined for disposal will still contain electrical energy. Avoid sparking and short-circuiting. Otherwise there is a risk of electric shock or fire.

Other precautions	
Important	<ul style="list-style-type: none">- The battery life (available operation time when the RIONOTE is powered by the battery) will depend on various factors including ambient temperature, age and usage status of the battery, storage conditions, etc.- The battery is a consumable part. After many repeated charge/discharge cycles, the battery capacity will diminish and the battery life available with one charge will become shorter. When the available operation time on battery power has become too short, replace the battery.- Storage of the battery either in fully charged condition or in empty condition will shorten its service life. It is recommended to store the battery at about half-full capacity.- If the battery is left for an extended period of time, it will self-discharge, which reduces the remaining charge.

If you have any other questions or concerns, please contact the supplier.





FCC CAUTION

Changes or modifications not expressly approved by the party responsible for compliance could void the user's authority to operate the equipment.

Note: This equipment has been tested and found to comply with the limits for a Class A digital device, pursuant to part 15 of the FCC Rules. These limits are designed to provide reasonable protection against harmful interference when the equipment is operated in a commercial environment. This equipment generates, uses, and can radiate radio frequency energy and, if not installed and used in accordance with the instruction manual, may cause harmful interference to radio communications. Operation of this equipment in a residential area is likely to cause harmful interference in which case the user will be required to correct the interference at his own expense.

5.47-5.725GHz band is restricted to indoor operations only.

This transmitter must not be co-located or operated in conjunction with any other antenna or transmitter.

The available scientific evidence does not show that any health problems are associated with using low power wireless devices. There is no proof, however, that these low power wireless devices are absolutely safe. Low power Wireless devices emit low levels of radio frequency energy (RF) in the microwave range while being used. Whereas high levels of RF can produce health effects (by heating tissue), exposure of low-level RF that does not produce heating effects causes no known adverse health effects. Many studies of low-level RF exposures have not found any biological effects. Some studies have suggested that some biological effects might occur, but such findings have not been confirmed by additional research. RIONOTE has been tested and found to comply with FCC radiation exposure limits set forth for an uncontrolled environment and meets the FCC radio frequency (RF) Exposure Guidelines.



CMIIT 产品批准

- 使用频率：2.4 - 2.4835 GHz
■ 等效全向辐射功率 (EIRP)：
天线增益 < 10 dBi 时：≤ 100 mW 或 ≤ 20 dBm
■ 最大功率谱密度：
天线增益 < 10 dBi 时：≤ 10 dBm / MHz (EIRP)
■ 载频容限：20 ppm
■ 带外发射功率（在 2.4 - 2.4835 GHz 频段以外）
≤ -80 dBm / Hz (EIRP)
■ 杂散发射（辐射）功率（对应载波 ±2.5 倍信道带宽以外）：
≤ -36 dBm / 100 kHz (30 - 1000 MHz)
≤ -33 dBm / 100 kHz (2.4 - 2.4835 GHz)
≤ -40 dBm / 1 MHz (3.4 - 3.53 GHz)
≤ -40 dBm / 1 MHz (5.725 - 5.85 GHz)
≤ -30 dBm / 1 MHz (其它 1 - 12.75 GHz)
- 不得擅自更改发射频率，加大发射功率（包括额外加装射频功率放大器），不得擅自外接天线或改用其它发射天线；
- 使用时不得对各种合法的无线电通信业务产生有害干扰；一旦发现有干扰现象时，应立即停止使用，并采取措施消除干扰后方可继续使用；
- 使用微功率无线电设备，必须忍受各种无线电业务的干扰或工业、科学及医疗应用设备的辐射干扰；
- 不得在飞机和机场附近使用；



This equipment may be operated EU.

Indication of the intended use of the equipment

The RIONOTE is analyzer and data recorder which has functions such as one-third octave band analysis, Fast Fourier transform analysis, waveform recording. Target users are professional who measure mainly sound and vibration. The RIONOTE can be used both wired and wireless.

EU COMPLIANCE STATEMENT

български

С настоящото RION CO., LTD. декларира, че този тип радиосъоръжение RIONOTE е в съответствие с Директива 2014/53/ЕС.

Цялостният текст на ЕС декларацията за съответствие може да се намери на следния интернет адрес: <http://rion-sv.com/>

español

Por la presente, RION CO., LTD. declara que el tipo de equipo radioeléctrico RIONOTE es conforme con la Directiva 2014/53/UE.

El texto completo de la declaración UE de conformidad está disponible en la dirección Internet siguiente: <http://rion-sv.com/>

čeština

Tímto RION CO., LTD. prohlašuje, že typ rádiového zařízení RIONOTE je v souladu se směrnicí 2014/53/EU.

Úplné znění EU prohlášení o shodě je k dispozici na této internetové adrese: <http://rion-sv.com/>

dansk

Hermed erklærer RION CO., LTD., at radioudstyret RIONOTE er i overensstemmelse med direktiv 2014/53/EU.

EU-overensstemmelseserklæringens fulde tekst kan findes på følgende internetadresse: <http://rion-sv.com/>

Deutsch

Hiermit erklärt RION CO., LTD., dass der Funkanlagentyp RIONOTE der Richtlinie 2014/53/EU entspricht.

Der vollständige Text der EU-Konformitätserklärung ist unter der folgenden Internetadresse verfügbar: <http://rion-sv.com/>

eesti

Käesolevaga deklareerib RION CO., LTD., et käesolev raadioseadme tüüp RIONOTE vastab direktiivi 2014/53/EL nõuetele.

ELi vastavusdeklaratsiooni täielik tekst on kättesaadav järgmisel internetiaadressil: <http://rion-sv.com/>

ελληνικά

Με την παρούσα ο/η RION CO., LTD. δηλώνει ότι ο ραδιοεξοπλισμός RIONOTE πληροί την οδηγία 2014/53/ΕΕ.

Το πλήρες κείμενο της δήλωσης συμμόρφωσης ΕΕ διατίθεται στην ακόλουθη ιστοσελίδα στο διαδίκτυο: <http://rion-sv.com/>

English

Hereby, RION CO., LTD. declares that the radio equipment type RIONOTE is in compliance with Directive 2014/53/EU.

The full text of the EU declaration of conformity is available at the following internet address: <http://rion-sv.com/>

français

Le soussigné, RION CO., LTD., déclare que l'équipement radioélectrique du type RIONOTE est conforme à la directive 2014/53/UE.

Le texte complet de la déclaration UE de conformité est disponible à l'adresse internet suivante: <http://rion-sv.com/>

hrvatski

RION CO., LTD. ovime izjavljuje da je radijska oprema tipa RIONOTE u skladu s Direktivom 2014/53/EU.

Cjeloviti tekst EU izjave o sukladnosti dostupan je na sljedećoj internetskoj adresi: <http://rion-sv.com/>

italiano

Il fabbricante, RION CO., LTD., dichiara che il tipo di apparecchiatura radio RIONOTE è conforme alla direttiva 2014/53/UE.

Il testo completo della dichiarazione di conformità UE è disponibile al seguente indirizzo Internet: <http://rion-sv.com/>

latviešu

Ar šo RION CO., LTD. deklarē, ka radioiekārta RIONOTE atbilst Direktīvai 2014/53/ES.

Pilns ES atbilstības deklarācijas teksts ir pieejams šādā interneta vietnē: <http://rion-sv.com/>

lietuvių

Aš, RION CO., LTD., patvirtinu, kad radijo įrenginių tipas RIONOTE atitinka Direktyvą 2014/53/ES.

Visas ES atitikties deklaracijos tekstas prieinamas šiuo interneto adresu: <http://rion-sv.com/>

magyar

RION CO., LTD. igazolja, hogy a RIONOTE típusú rádióberendezés megfelel a 2014/53/EU irányelvnek.

Az EU-megfelelőségi nyilatkozat teljes szövege elérhető a következő internetes címen: <http://rion-sv.com/>

Malti

B'dan, RION CO., LTD., niddikjara li dan it-tip ta' tagħmir tar-radju RION-OTE huwa konformi mad-Direttiva 2014/53/UE.

It-test kollu tad-dikjarazzjoni ta' konformità tal-UE huwa disponibbli f'dan l-indirizz tal-Internet li ġej: <http://rion-sv.com/>

Nederlands

Hierbij verklaar ik, RION CO., LTD., dat het type radioapparatuur RIONOTE conform is met Richtlijn 2014/53/EU.

De volledige tekst van de EU-conformiteitsverklaring kan worden geraadpleegd op het volgende internetadres: <http://rion-sv.com/>

polski

RION CO., LTD. niniejszym oświadcza, że typ urządzenia radiowego RION-OTE jest zgodny z dyrektywą 2014/53/UE.

Pełny tekst deklaracji zgodności UE jest dostępny pod następującym adresem internetowym: <http://rion-sv.com/>

português

O(a) abaixo assinado(a) RION CO., LTD. declara que o presente tipo de equipamento de rádio RIONOTE está em conformidade com a Diretiva 2014/53/UE.

O texto integral da declaração de conformidade está disponível no seguinte endereço de Internet: <http://rion-sv.com/>

română

Prin prezenta, RION CO., LTD. declară că tipul de echipamente radio RIONOTE este în conformitate cu Directiva 2014/53/UE.

Textul integral al declarației UE de conformitate este disponibil la următoarea adresă internet: <http://rion-sv.com/>

slovenčina

RION CO., LTD. týmto vyhlasuje, že rádiové zariadenie typu RIONOTE je v súlade so smernicou 2014/53/EÚ.

Úplné EÚ vyhlásenie o zhode je k dispozícii na tejto internetovej adrese:
<http://rion-sv.com/>

slovenščina

RION CO., LTD. potrjuje, da je tip radijske opreme RIONOTE skladen z Direktivo 2014/53/EU.

Celotno besedilo izjave EU o skladnosti je na voljo na naslednjem spletnem naslovu: <http://rion-sv.com/>

suomi

RION CO., LTD. vakuuttaa, että radiolaitetyyppi RIONOTE on direktiivin 2014/53/EU mukainen.

EU-vaatimustenmukaisuusvakuutuksen täysimittainen teksti on saatavilla seuraavassa internetosoitteessa: <http://rion-sv.com/>

svenska

Härmed försäkrar RION CO., LTD. att denna typ av radioutrustning RIONOTE överensstämmer med direktiv 2014/53/EU.

Den fullständiga texten till EU-försäkran om överensstämmelse finns på följande webbadress: <http://rion-sv.com/>

Contents

Safety Precautions

For Safe Operation	9
Explanation of Displays and Symbols	9
Precautions	10

Preparation Before Use

Part Names and Functions	34
Top View/Bottom View	34
Right Side View	35
Left Side View	37
Back View	38
Amplifier Unit (SA-A1B2/B4)	39
Attaching/Removing the Battery.....	40
Attaching the Battery	40
Removing the Battery	41
Charging.....	42
About Charging	42
Battery Status	42
Charging	43
Charging the Battery Only	44
SD memory card.....	45
Installing the SD memory card to the unit	45
Removing the SD memory card from the unit.....	46
Amplifier Unit.....	47
Attaching the Amplifier Unit to the Dock	47
Removing the Amplifier Unit from the Dock.....	48
Powering On/Off	49
Powering On.....	49
Powering Off.....	49
Forcefully Powering Off	50
Auto Screen Off	51
Auto Screen Off	51
Exiting the Screen Off State	51
Connecting External Devices.....	52
Input Jack Location	52
Connecting the Sensor	53
Removing the Sensor	54

Connecting the Voice Memo Microphone/Earphones.....	55
Connecting the Voice Memo Microphone	55
Connecting the Earphones.....	55
Connecting to Computer	56
Connecting to Computer.....	56
Configuring The unit	
HOME Screen.....	58
HOME Screen Layout	58
Basic Operation	59
Configuring The unit	62
Configuring the Screen Brightness	62
Adjusting the Monitor Output Volume	63
Configuring the Language	64
Configuring the Date and Time	65
Configuring the Time Zone.....	67
Configuring the Date Format	68
Configuring the Function Button	69
Configuring the Network.....	70
Configuring the Screen Off Time	71
Configuring the Touch Pointer	72
Formatting the SD Memory Card	73
Managing the Amplifier Unit.....	74
Registering the Amplifier Unit Connected to The unit	74
Configuring the Amplifier Unit	76
Updating the Amplifier Unit Program	78
Deleting the Amplifier Unit	81
Amplifier Unit Mass Storage Function	82
Configuring the Calibration.....	83
Configuring the Calibration.....	83
Copying the Calibration Information	87
Displaying the Calibration Information List	90
Saving Calibration Values	91
Loading Calibration Values.....	93
Editing the Setting Name	95
Deleting Calibration Values	97
Managing the Program/System.....	99
Installing the Program	99
Checking the Program Version	101
Updating the Program.....	102
Canceling the Program License	105

Activating the Program License.....	107
Checking the System Version	109
Updating the System	110
Updating the System and the program in a lump	113
Versions Required to Use SA-A1WD	115
SA-A1 File Converter.....	116
Software Installation	116
Starting the Software	120
Screen Configuration	120
Converting Files	121
Information about Text Files created by the Conversion (SX-A1RT)	124
Settings	126
Specifications	129
Input Setting Details.....	130
Channel Settings	130
Calibration.....	132
Setting of Tacho Pulse / Extra DC Input	136
About the Calibration.....	137
Basic Relationship between Physical Quantity of Measurement Object and Recorded Data	137
Calibration with SX-A1WR	138
Calibration with SX-A1RT	141
Calibration with SX-A1FT	142
Microphone Sensitivity Input	144
Calibration of DC Signals Including Offset	146
Analysis of DC Signals	147
Specifications	148
Waveform Recording Program SX-A1WR	
Software Usage License Agreement	160
SX-A1WR Overview	162
Screen Layout.....	163
Measurement Screen Layout.....	163
Recall Screen Layout	165
Project Select Screen Layout.....	167
Measurement Settings Screen Layout.....	168
Starting/Exiting the SX-A1WR.....	169
Starting the SX-A1WR	169
Exiting the SX-A1WR	170

Measuring Wave	171
Starting Measurement.....	171
Stopping Measurement	172
Configuring the Measurement Time	172
Changing the Amplifier Unit to Use	174
Capturing Screens during Monitoring and Measurement	175
Voice Memo/Marker	177
Inserting the Voice Memo	177
Playing the Voice Memo	179
Inserting the Marker during Measurement	180
Inserting the Marker to Measured Wave Data	181
Deleting the Marker	185
Operating the Project.....	186
Project	186
Opening the Project.....	187
Changing the Project Name	188
Deleting the Project.....	190
Displaying Captured Screen Data.....	192
Operating Recall Screen.....	194
Playing the Recall Data	194
Analyzing Recall Data.....	195
Capturing Recall Screen.....	196
Checking the Recall Data Settings	197
Closing the Recall Screen	198
Operating Graphs.....	199
Zooming in on the Time-Level Graph View	199
Zooming out of the Time-Level Graph View	200
Using the Single Graph View	201
Returning the Graph to the Multiple View	202
Capturing the Graph	203
Changing Time-Level Graph into Bar Graph	204
Changing Bar Graph into Time-Level Graph	205
Changing the Display Contents on Graphs	206
Settings	210
Configuring the Measurement Time	210
Configuring the File Division Cycle	211
Configuring the Pre-time.....	212
Configuring the Amplifier Unit Items	213
Configuring the Trigger	214
Configuring the Number of Graphs to Display	216
Configuring Tacho Display on the Graph	219

Calibrating	220
Initializing the Settings	221
Save the Current Settings	223
Confirming the Saved Settings	225
Load the Settings	226
Editing Settings	228
Delete the Settings	230
Setting Startup	232
Saving Startup File, Etc.	233
Items on Measurement Settings Screen	234
Measurement Settings	234
Trigger Settings	235
WAVE File Format.....	238
Basic Structure	238
Invalid Values	240
Data Types	241
Chunks	242
Approximate Recording Times	251
Approximate Recording Times	251
Specifications	253

This product can be used in any areas including residential areas.

Open source software

This product contains the open source software of the following licenses.

- (1) GPL
- (2) GPL v 2
- (3) GPL v 3
- (4) Boost Software License
- (5) Apache License
- (6) Apache License v 2

Those source codes of the open source software according to the license agreement will be given. Those source codes are given the RION Support Room (<http://rion-sv.com/>).

Note that we assume no responsibility for the source code.

Note that we are not responsible for exact details of the source code.

For details on the license, click [Manual] - [Open Source License] folder in the supplied CD-ROM.

Preparation Before Use

This section describes necessary preparation before using the unit.

Part Names and Functions

There are the following part names and functions in the unit:

Top View/Bottom View

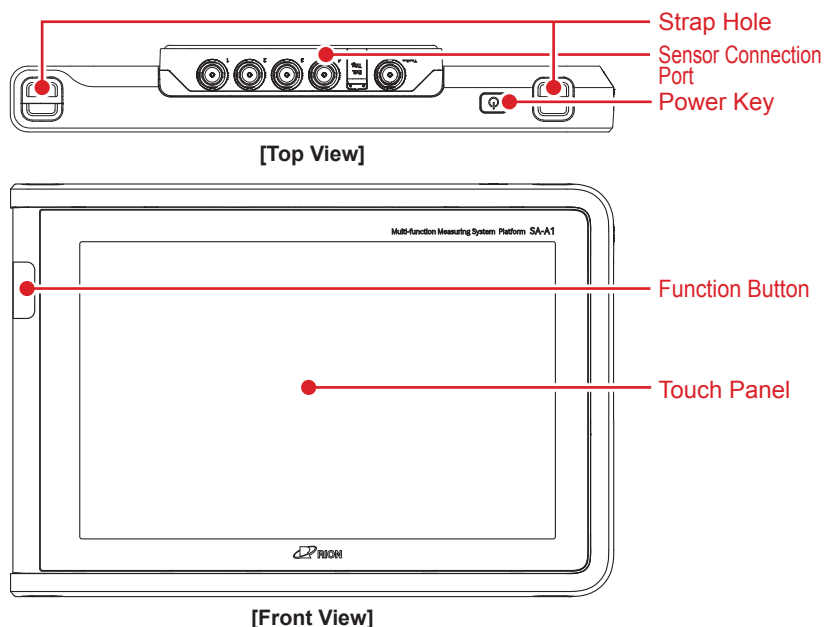

Strap Hole

Fixes a optional shoulder strap.

Sensor Connection Port (when the amplifier unit is connected)

Connects a sensor.

Power Key

Pressing and holding for more than two seconds displays a power on/off message. Pressing this short enters/exits the auto screen off state.

Touch Panel (Display)

A liquid crystal panel with back light.

Function Button

Performs a function assigned to the button.

Right Side View

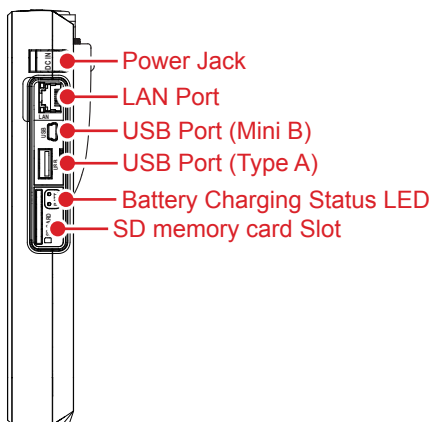

[Right Side View]

Power Jack

Connects the power cable.

LAN Port

Connects a LAN cable.

USB Port (Mini B)

Connects a Mini B USB cable.

USB Port (Type A)

Connects a Type A USB cable. This is not used in the current version.

Battery Charging Status LED

Indicates the charging status of the battery connected to the unit.

SD memory card Slot

Inserts an SD memory card.

The relation between the battery charging status LED and the battery charging or energization status is as follows.

Upper LED Indicates the energization status of the battery connected to the unit by the AC adapter.

- Solid blue: The battery is energized by the AC adapter.
- Off: The battery is not connected to the unit, or not energized by the AC adapter.

Lower LED Indicates the charging status of the battery connected to the unit by the AC adapter.

- Solid green: The battery is being charged.
- Solid orange: The battery is put into the charging standby state due to increase in ambient temperature or other reasons.
- Off: Charging is completed.

Left Side View

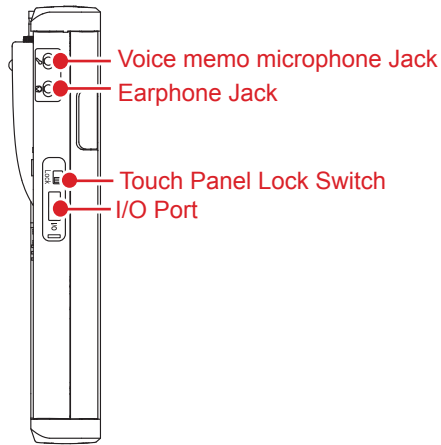

[Left Side View]

Voice memo microphone Jack

Connects a voice memo microphone.

Earphone Jack

Connects earphones for playback.

Touch Panel Lock Switch

Raising the switch locks the touch panel and disables window operations.

I/O Port

This is not used in the current version.

Back View

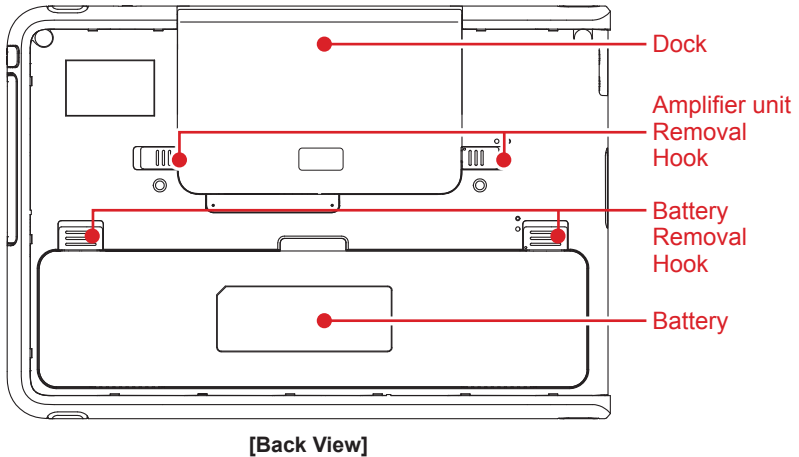

Dock

Connects the amplifier unit (SA-A1B2/B4).

Important

- When the amplifier unit is not connected, do not touch the connection port on the dock.

Amplifier unit Removal Hook

Slide the hook to remove the amplifier unit.

Battery Removal Hook

Slide the hook to remove the battery.

Battery

Attaches the battery.

Amplifier Unit (SA-A1B2/B4)

The figure shows the view of SA-A1B4.

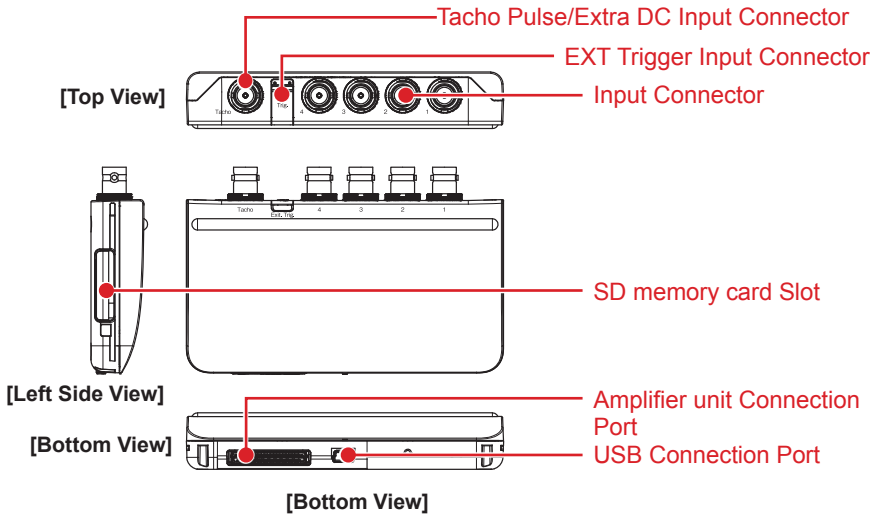

Tacho Pulse/Extra DC Input Connector

Inputs the tacho pulse signal for tracking analysis or DC signals.

EXT Trigger Input Connector

A type 2.5 mm dia. mono jack for external trigger signal input.

Input Connector

Connects a sensor such as a microphone or accelerometer.

Important - Do not short-circuit the ports while CCLD is ON.

SD memory card Slot

Allows an SD memory card to be inserted.

Amplifier unit Connection Port

Connects the amplifier unit to the dock.

USB Connection Port

This is not used in the current version.

Attaching/Removing the Battery



Note

- Be sure to power off and remove the power cable before attaching/removing the battery.

Attaching the Battery

Important

- Before attaching the battery, check that the right battery removal hook is held in the upper side.
- Do not touch the battery port with hands or short-circuit it.

1. Position the charging port on the battery with the battery port on the unit.

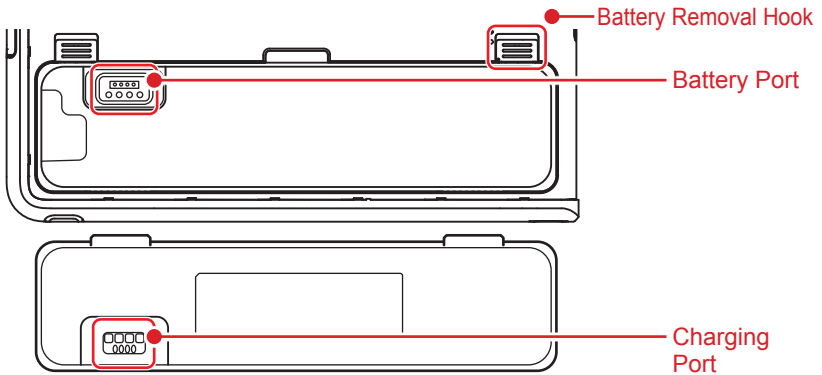

2. Slowly insert the battery in the direction of the arrow until it clicks.

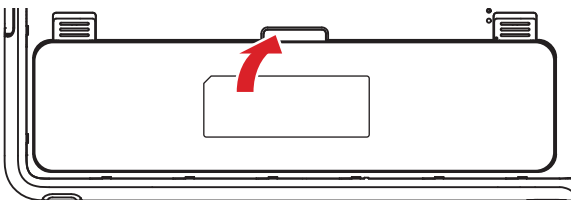

3. Slide the right battery removal hook and lock it.

Removing the Battery

1. Slide the right battery removal hook in the direction of the arrow and lock it.

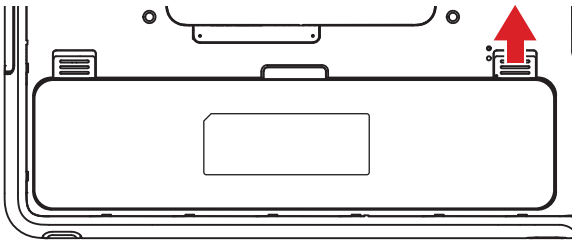

2. Slide the left battery removal hook in the direction of the arrow and put your fingertips on the battery through the recessed area of the unit and then remove the battery in the direction of the arrow.

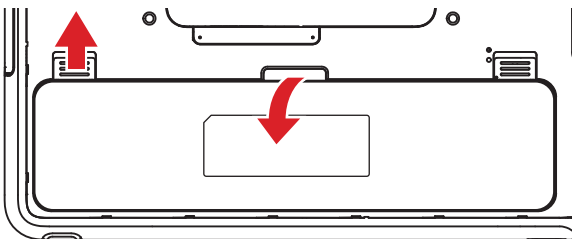

Charging

About Charging









When you purchase this product, the battery is not fully charged. Be sure to charge the battery before use. The battery lasts for about four hours when it is fully charged. However, please note that it depends on the usage environment and battery status.

MEMO

- Be sure to use the specialized battery.
- Use the AC adapter provided with the unit for charging.
- It is normal that the unit becomes slightly warm during charging.
- Charging may stop for safety reasons if the ambient temperature becomes higher than the allowable temperature of the battery during charging.
- We recommend to charge the battery after powering off the unit to prevent increase in ambient temperature.
- Remove or insert the AC adapter plug slowly without placing any excess force.
- Repeated charging shortens the operating time due to decrease in charging amount of the battery.

Battery Status

The battery status is displayed with an icon on the right side of the status bar.

Icon	Content
	AC adapter is connected
	AC adapter is not connected
	Battery is being charged
	Battery is full
	Battery is more than half charged
	Battery is low
	Battery is almost empty
	Battery is empty
	Battery is not connected

Charging

1. Connect the power cable to the AC adapter.

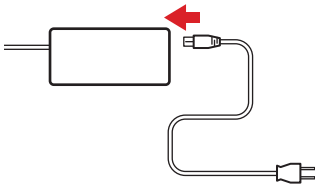

2. Insert the AC adapter plug to the power jack on the unit in the direction of the arrow.

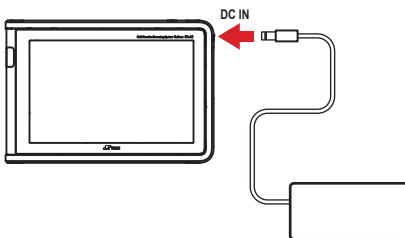

3. Insert the plug of the power cable to an outlet of 100 to 240 V AC.

Important

- Be sure to use the dedicated AC adapter. It has different polarity and port shape from our conventional AC adapters.

MEMO

- The battery can be charged with the unit powered on but it takes longer to finish charging.

Charging the Battery Only

1. Insert the AC adapter plug to the power jack on the battery in the direction of the arrow.

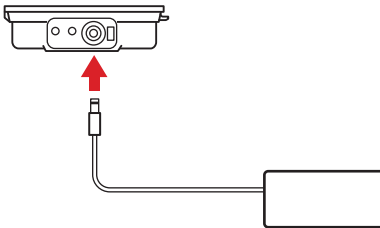

2. Connect the power cable to the AC adapter.
3. Insert the power plug of the power cable to a 100 V to 240 V AC outlet.

Important

- Be sure to use the AC adapter dedicated for RIONOTE to charge the battery.

MEMO

- The battery has a lamp to indicate the charging status.
- Solid blue of right lamp: AC adapter connected.
- Solid green of left lamp: Battery being charged.
- Solid orange of left lamp: Battery in the charging standby state due to increase or decrease in ambient temperature or other reasons.
Charging will start when the internal battery temperature falls within the range of +5°C to +35°C.
- Left lamp off: Charging completed.

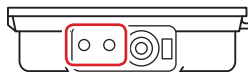

SD memory card

Important

- Be sure to power off and remove the power cable before installing/removing the SD memory card. If you install/remove the SD memory card accidentally while the power is on and this device does not recognize the SD memory card, power off with the SD memory card inserted and then power on again.
- Data in the SD memory card can be damaged if you remove the SD memory card when writing/reading the data.
- Use an SD memory card sold by RION Co., Ltd. Operation will not be guaranteed with a third-party SD memory card.
- RION Co., Ltd. will not be liable for any damages or loss of data recorded with the unit.

Installing the SD memory card to the unit

1. Open the side cover of the unit.
2. Slowly insert the SD memory card with the label side faced up to the SD memory card slot until it clicks.

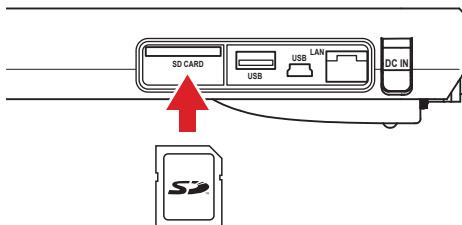

3. Close the side cover.

Important

- An SD memory card has the top/bottom sides and front/back sides. Inserting it forcefully may cause damage.
- Do not touch the port on the SD memory card.

MEMO

- This device may not recognize the SD memory card when it is full.
- An Android-secure file is created in the inserted SD memory card. You can either leave or delete the file.

Removing the SD memory card from the unit

1. Open the side cover of the unit.
2. Slowly insert the SD memory card as far as it goes.

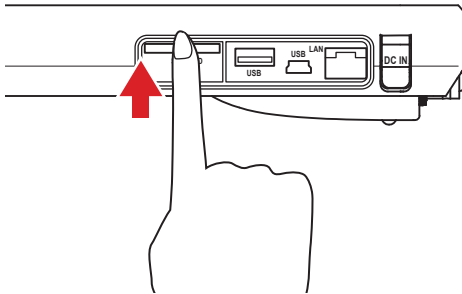

3. When it clicks, pull the card straight.

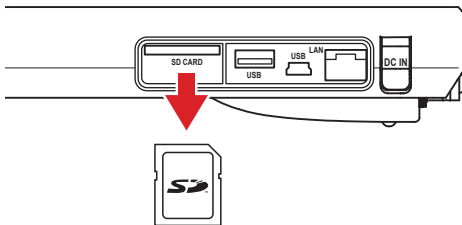

4. Close the side cover.

Important

- Do not remove the SD memory card while running a program, performing measurement or immediately after saving. It may cause damage or data loss.
- Do not pull the SD memory card forcefully. It may cause damage or data loss.

MEMO

- A removed SD memory card may be warm after a long period of use, but it is not a failure.

Amplifier Unit

The amplifier unit (SA-A1B2/B4) can be attached to the unit to connect the sensor. The amplifier unit is connected through the unit dock.



Note

- When you attach or remove the amplifier unit, be careful not to get your fingers caught in or hit your fingers against the unit.

Important

- Be sure to power off before attaching/removing the amplifier unit.

Attaching the Amplifier Unit to the Dock

Important

- Before attaching the amplifier unit, check that the right amplifier unit removal hook is held in the right side.

1. Power off the unit.
2. Position the connection port on the dock with the connection port on the amplifier unit.

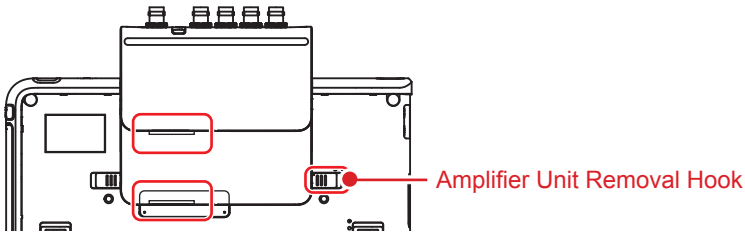

Important

- Do not touch the connection port on the dock. It may cause a failure.

3. Slide the amplifier unit in the direction of the arrow and insert until it clicks.

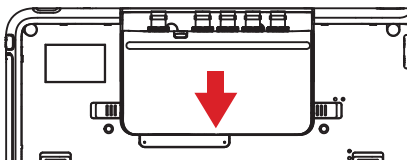

4. Slide the right amplifier unit removal hook and lock it.

Removing the Amplifier Unit from the Dock

1. Power off the unit.
2. Slide the right amplifier unit removal hook in the direction of the arrow and lock it.

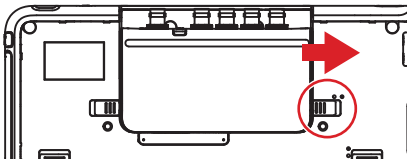

3. Slide the left amplifier unit removal hook in the direction of the arrow and slide the amplifier unit in the direction of the arrow.

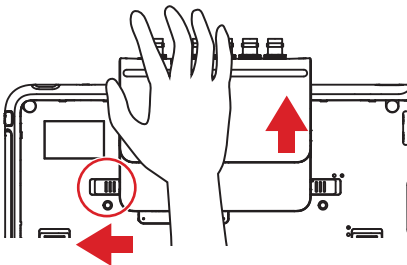

Important

- Do not remove the amplifier unit with the unit powered on. It may cause damage to the system.

Powering On/Off

Powering On

1. Press and hold the power key for more than two seconds.

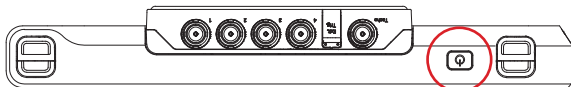

MEMO

- The touch panel is in the initialization state until it displays the HOME screen (P. 54) after power-on. Do not touch the screen. The touch panel may not work correctly.

Powering Off

1. Press and hold the power key for more than two seconds.
2. Tap [OK].

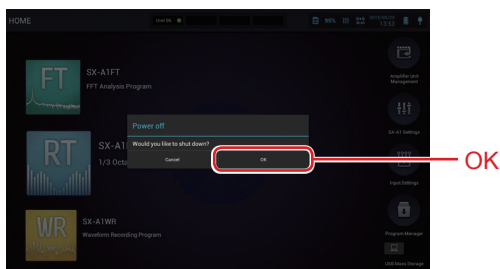

Important

- Remove the battery and AC adapter if you store the unit with the power off for a long time.

MEMO

- Wait for more than 10 seconds before powering on the unit again after powering off.
- If a lead battery is used as an external power supply, the automatic shut-down function is disabled. In this case, this device will be shut down forcibly when the battery runs out.

Forcefully Powering Off

If the screen freezes or the unit cannot be powered off, you need to forcefully power off.

- 1. Press and hold the power key for more than ten seconds.**

Important

- When you forcefully power off, be sure that the data is not being written/read.

Auto Screen Off

Auto Screen Off

A function to temporarily turn off the screen to save the battery is called "auto screen off".

If you press the power key or do not operate for a given time (specified time: P.68), the screen will be turned off automatically except during measurement.

Exiting the Screen Off State

1. Press the power key while the screen is turned off.

MEMO

- When you exit the screen off state, the screen before entering the screen off state may appear depending on the program in use.
- Do not touch the screen when you exit the screen off state. The touch panel may not work correctly.

Connecting External Devices

You can connect a sensor to the amplifier unit attached.

Input Jack Location

The amplifier unit input jacks are located as follows.

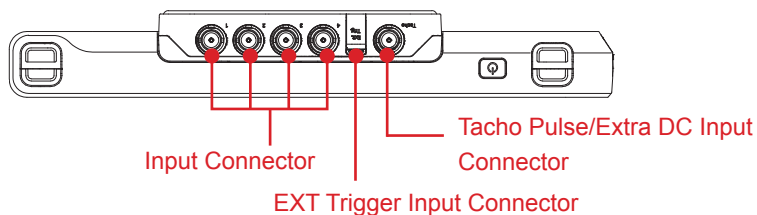

Input Connector

A connector to connect a sensor such as a microphone or accelerometer. You can connect up to two sensors for SA-A1B2 and up to four for SA-A1B4.

EXT Trigger Input Connector

A type 2.5 mm dia. mono jack for external trigger signal input.

Tacho Pulse/Extra DC Input Connector

Inputs the tacho pulse signal for tracking analysis or DC signals.

Connecting the Sensor

1. Insert the sensor code firmly to the BNC connector.

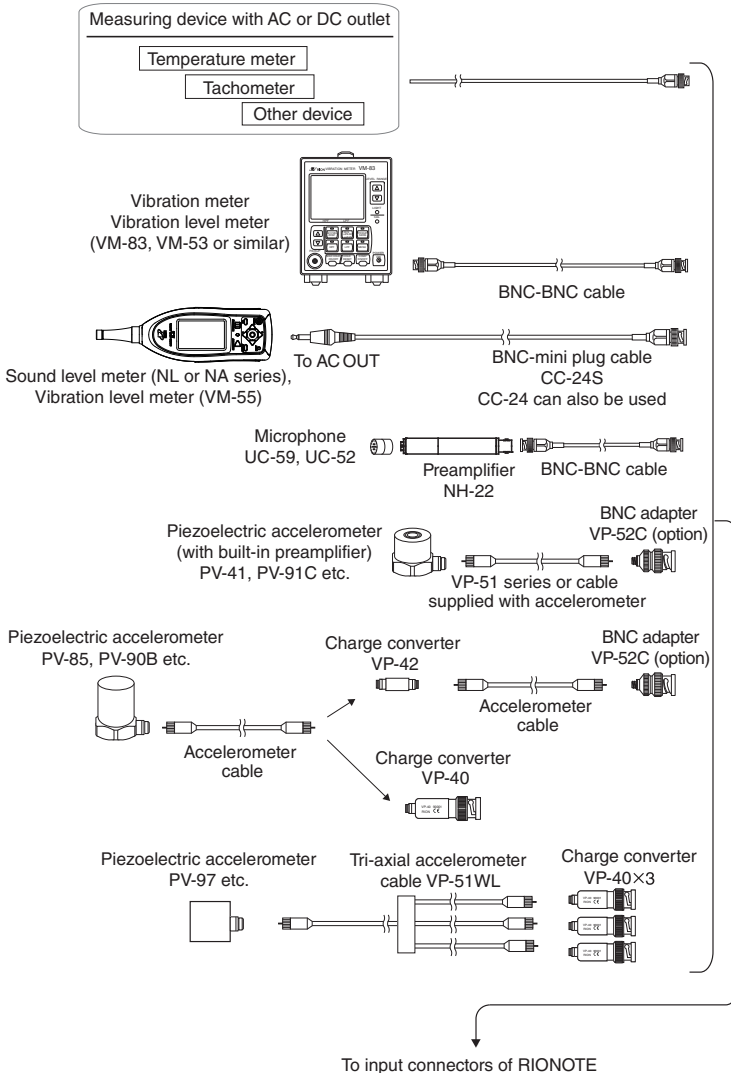

Removing the Sensor

1. **Power off the unit.**
2. **Hold the sensor code plug and remove the cord.**

Important - Remove the cord by holding the plug.

Connecting the Voice Memo Microphone/Earphones

Connecting the Voice Memo Microphone

When you input voice memo data, use a voice memo microphone that is provided with this product or sold separately. Insert a voice memo microphone 3.5 mm mini plug to the voice memo microphone jack.

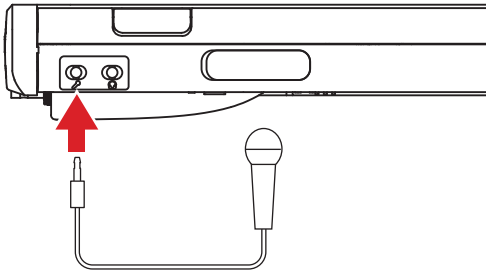

Connecting the Earphones

To play recorded data, use earphones that are provided with this product or sold separately. Insert an earphone 3.5 mm mini plug to the earphone jack.

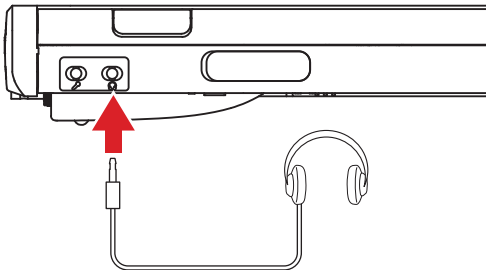

Important

- To protect ears from the noise generated at power-on, remove earphones from the jack or keep them away from ears.

MEMO

- The pin assignment of earphone jack is L, R and Ground from the end of the pin. Because there is one channel for output, the same signal is output to L and R channels.
- The data playback includes delay.
- The data at a frequency range of 5 kHz or more can be output to the monitor as a playback signal.

Connecting to Computer

An SD memory card inserted to the unit is recognized as a removable disk through USB connection with a computer.

Connecting to Computer

1. Connect the USB port (Mini B) of the unit to the USB port of a computer with an A-miniB USB cable sold separately (commercially available) as shown in the following figure.

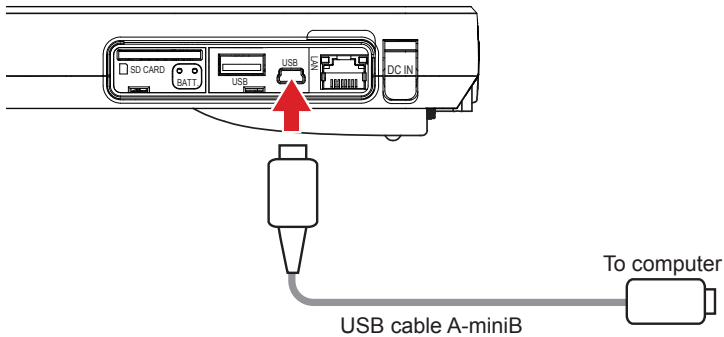

2. Power on the unit and tap [USB Mass Storage] on the HOME screen.

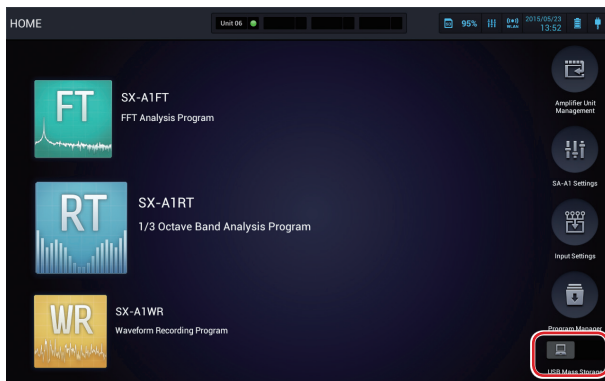

Configuring The unit

This section describes necessary settings when using the unit.

Use the following procedures to configure the settings before starting measurement using the unit. After the settings are complete, start the program for measurement.

1. Configuring The unit

Configure the unit as needed, such as for date and time and screen brightness.



2. Registering the Amplifier Unit

Register the amplifier unit connected to the unit. (P. 70)



3. Configuring the Calibration

Configure the channel type, sensor type, and calibration information. (P. 79)



4. Starting the Program

Start a program used for measurement and start measurement.

HOME Screen

HOME Screen Layout

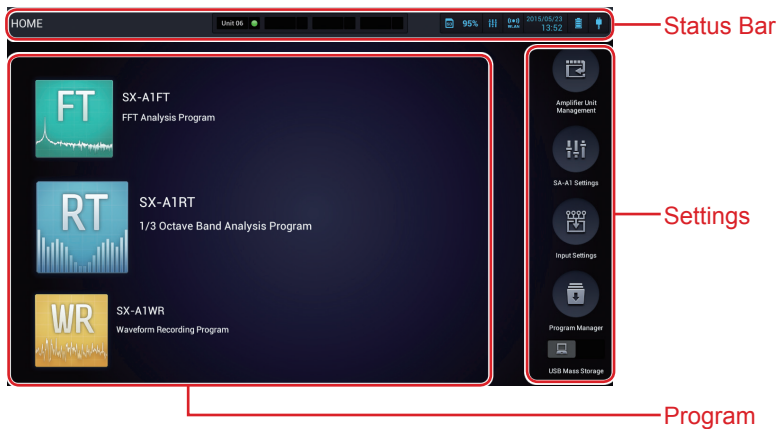

Status Bar

Displays the registered unit and battery status.

Program

Displays the buttons of programs installed on the unit. Tap the button to start the program.

Settings

Provided setting buttons for the unit. Tap the button to display its settings.

Basic Operation

Important

- The touch panel is designed to be gently touched by fingers or stylus pen. Do not press the panel hard with fingers or touch it with a sharp object (such as ballpoint pen/pin).
- Please note that the touch panel may not work correctly or cause malfunction on the following conditions.
 - Operation with a glove
 - Operation with a nail tip
 - Operation while putting foreign objects on the touch panel
 - Operation with a water droplet or condensation on the touch panel
 - Operation with wet or sweaty fingers

Tap/Double-Tap

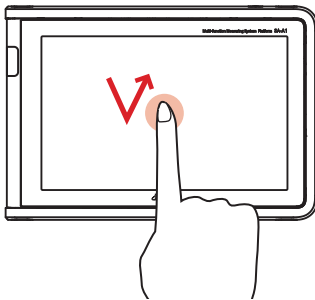

Tap is to lightly touch the screen with a finger and immediately release the finger. Tap is used to select an item or icon displayed on the screen.

Double-tap is to tap twice quickly.

Slide

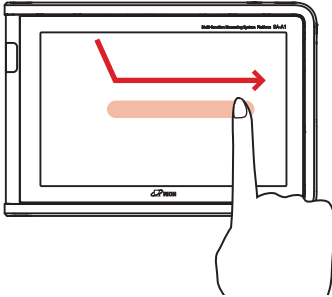

When all of data cannot be displayed on the screen, you can move the finger to the desired direction while lightly touching the screen. Slide is used to scroll the screen or switch pages. It is also used to move a gauge or bar to adjust the volume and brightness.

Pinch

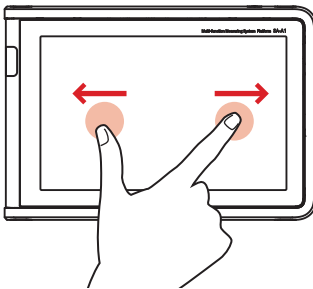

You can open two fingers (pinch out) or close (pinch in) while touching the screen. It can be used to zoom in or out of a graph.

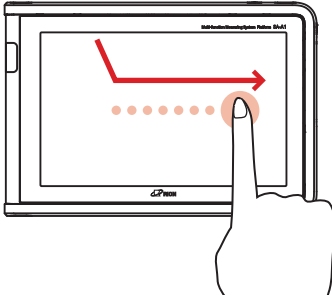
Drag

You can drag an item or icon to move to the desired location while lightly touching the screen.

Configuring The unit

Configuring the Screen Brightness

1. Tap the unit information display area of the status bar.

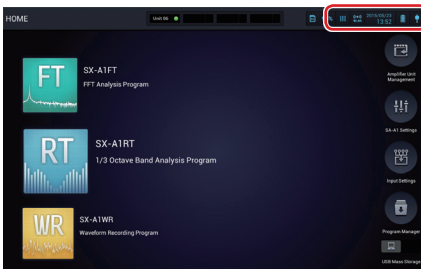

2. Slide the brightness adjustment slide bar to adjust the brightness.

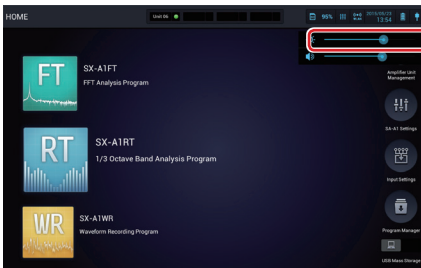

Slide the bar to the right to make it brighter and to the left to make it darker.

MEMO

- Making the screen brighter can drain the battery quicker.

Adjusting the Monitor Output Volume

Adjust the volume of the monitoring channel playback signal output from the earphone jack. This signal can be input to earphones or monitoring devices to check the recorded data contents.

1. Tap the unit information display area of the status bar.

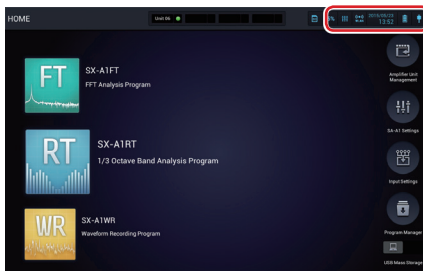

2. Slide the volume adjustment slide bar to adjust the volume.

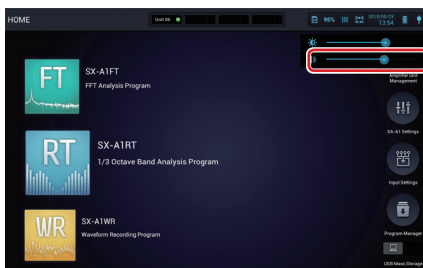

Slide the bar to the right to turn up the volume and to the left to turn down the volume.



Note

- Please note that the volume may get loud rapidly as you turn up.

Configuring the Language

Set the language used for the screen display.

1. Tap [SA-A1 Settings] on the HOME screen.
2. Tap [Language] and tap the language name.

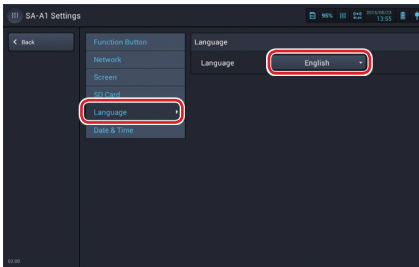

3. Select the language to display from [Language].

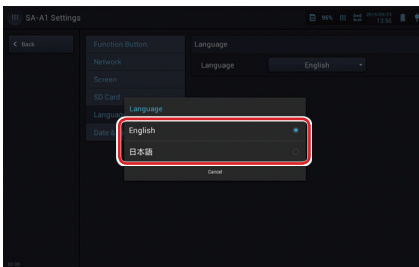

Configuring the Date and Time

1. Tap [SA-A1 Settings] on the HOME screen.
2. Tap [Date & Time] and tap the date area on the right side.

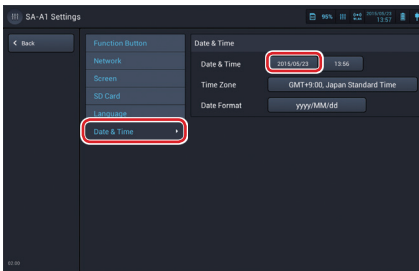

3. Slide the values of [Year], [Month] and [Day] up/down to configure and tap [OK].

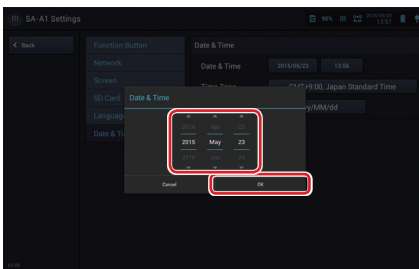

4. Tap the time area on the right side of [Date & Time].

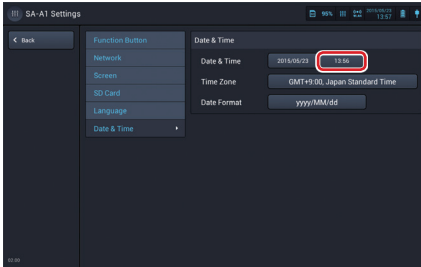

5. Slide the values of [Hour] and [Minute] up/down to configure and tap [OK].

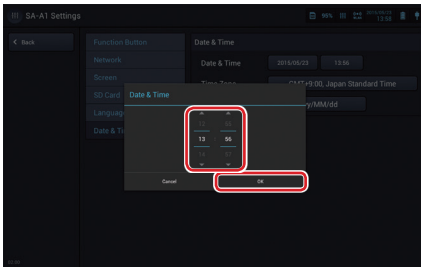

MEMO

- The date and time is recorded as a data and time for measured data. The date and time must be configured correctly.
- When you did not use the unit for a long time, be sure to configure the date and time before use again.
- The unit supports the date up to 2030/12/31.

Configuring the Time Zone

1. Tap [SA-A1 Settings] on the HOME screen.
2. Tap [Date & Time] and tap the button on the right side of [Time Zone].

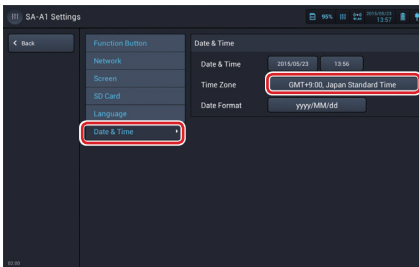

3. Slide the displayed time zone up or down and tap the time zone of your location.

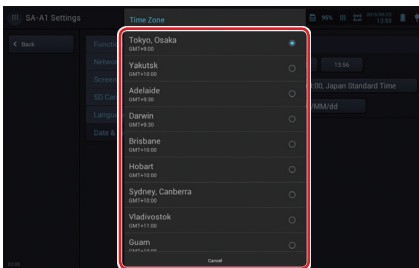

MEMO

- Date and time is adjusted based on the specified time zone. The time zone must be configured correctly.
- When you did not use the unit for a long time, be sure to configure the time zone before use again.

Configuring the Date Format

1. Tap [SA-A1 Settings] on the HOME screen.
2. Tap [Date & Time] and tap the button on the right side of [Date Format].

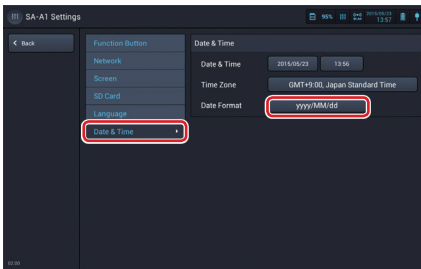

3. Tap the date format to display.

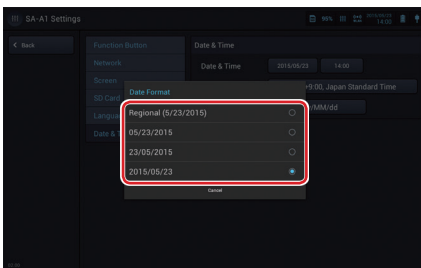

MEMO

- If you select [Region], the display format is automatically set up as configured in [Language].

Configuring the Function Button

You can assign a frequently-used function to the function button, so that it can be easily executed.

1. Tap [SA-A1 Settings] on the HOME screen.
2. Tap [Function Button] and tap [▼] on the right side of [Function].

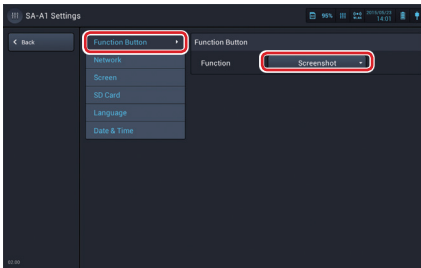

3. Tap the function to assign to the function button.

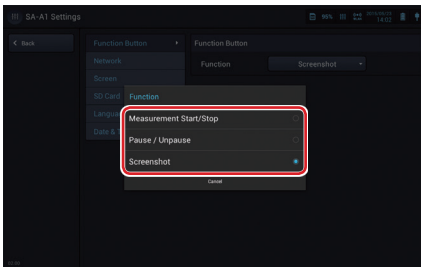

Configuring the Network

Enable wireless LAN connection to establish wireless communication with the wireless dock SA-A1WD.

1. Tap [SA-A1 Settings] on the HOME screen.
2. Tap [Network] and tap the button on the right side of [Wireless LAN].

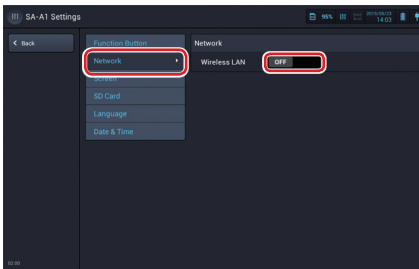

3. When the [Wireless LAN] setting becomes [ON], configure [WLAN frequency band] and [Channel] displayed.

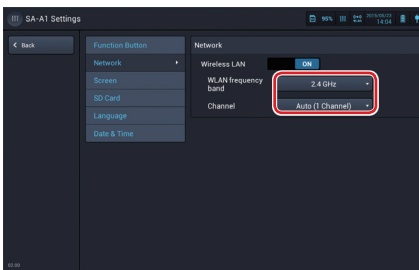

Select [2.4 GHz] or [5 GHz] for [WLAN frequency band]. [Channel] can be changed arbitrarily.

Configuring the Screen Off Time

If you do not operate the HOME screen for a given time, the screen will be turned off (except during measurement). Use the following procedures to set the time before the screen is turned off.

1. Tap [SA-A1 Settings] on the HOME screen.
2. Tap [Screen] and tap [▼] on the right side of [Auto Screen Off].

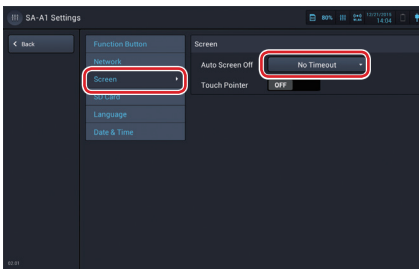

3. Tap the Auto Screen Off time.

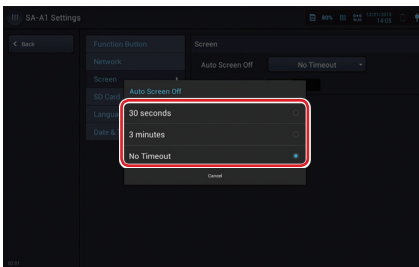

MEMO

- If you set to [No Timeout], the screen will not be turned off until you press the power key.

Configuring the Touch Pointer

Enable touch pointer to show the point to the part of touched screen.

1. Tap **[SA-A1 Settings]** on the **HOME** screen.
2. Tap **[Screen]** and tap the button on the right side of **[Touch Pointer]** to turn **[ON]**.

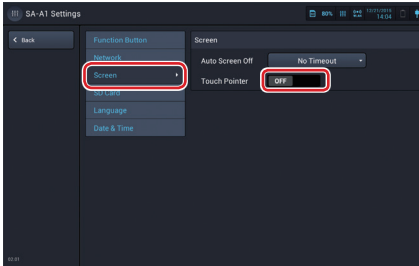

Formatting the SD Memory Card

Use the following procedures to delete all the data in the SD memory card inserted to this device and format it.

1. Tap **[SA-A1 Settings]** on the **HOME** screen.
2. Tap **[SD Card]**.

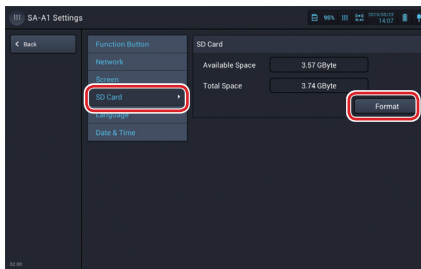

The SD Card screen is displayed. You can check the total space and available space of the SD memory card inserted to this device.

3. Tap **[Format]**.
4. Tap **[OK]**.

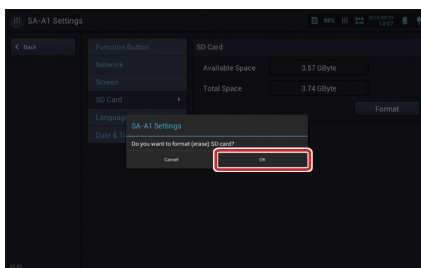

Managing the Amplifier Unit

Registering the Amplifier Unit Connected to The unit

When you connect the amplifier unit through the dock, you need to register the amplifier unit to the unit. Use the following procedures to register the amplifier unit.

1. Tap [Amplifier Unit Management] on the HOME screen.

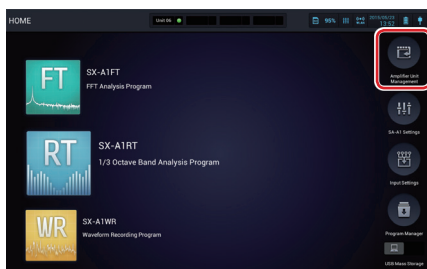

2. Tap [Register].

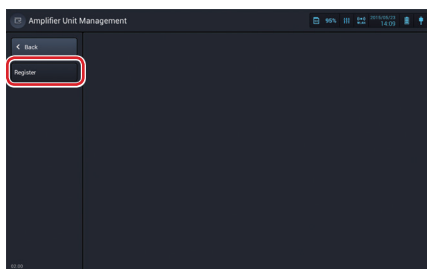

MEMO

- When no amplifier is registered, "Register Amplifier unit." is displayed. In this case, tap [OK].

3. Tap [Docking with SA-A1].

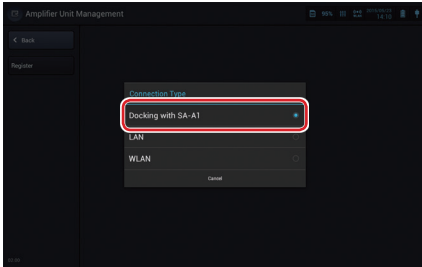

The amplifier unit connected to the dock at the back of the device is automatically detected and registered.

MEMO

- See the instruction manual of SA-A1WD to select [LAN] or [WLAN] for the connection type (when using the wireless dock SA-A1WD).

4. Tap [OK].

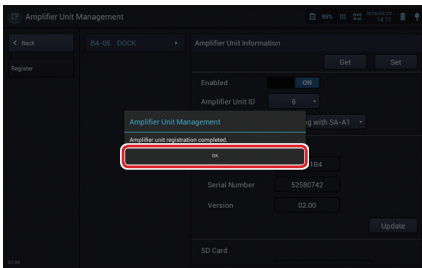

Configuring the Amplifier Unit

You can configure such as the amplifier unit name and channel name for the registered amplifier unit. It is useful when measuring if you use an easy-to-understand name depending on the purpose.

When the amplifier unit connected to the SA-A1WD has been registered, you can select the battery used for the SA-A1WD.

Two options are available: alkaline battery and nickel hydride rechargeable battery.

Important - Be sure to specify the actually used battery. If not, the operable time may be shortened or nickel hydride rechargeable battery may be damaged.

1. Tap [Amplifier Unit Management] on the HOME screen.

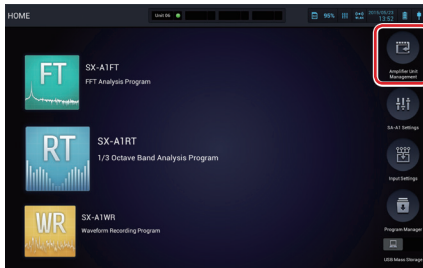

2. Configure each item in [Amplifier Unit Information].

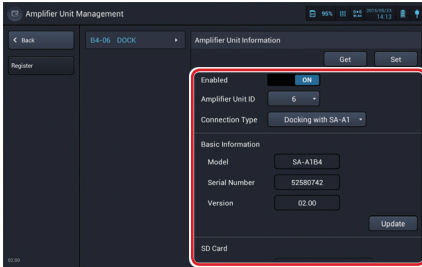

MEMO

- An edited setting item is displayed in yellow until [Set] is tapped to update. (The [Set] button is also displayed in yellow.)
- The displayed information is the amplifier unit settings last configured in the unit. If the amplifier unit settings were changed by other devices, tap [Get]. The amplifier unit settings are updated to the unit.
- For details on settings for each item, see "Instruction Manual Application" provided with the unit.

3. Tap [Set].

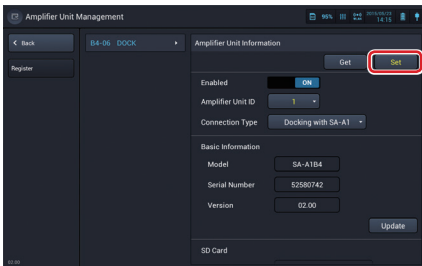

4. Tap [OK].

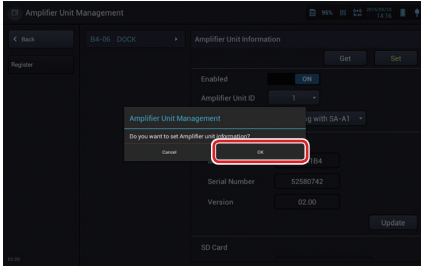

Updating the Amplifier Unit Program

Use the following procedures to update the amplifier unit program.

1. Tap [Amplifier Unit Management] on the HOME screen.

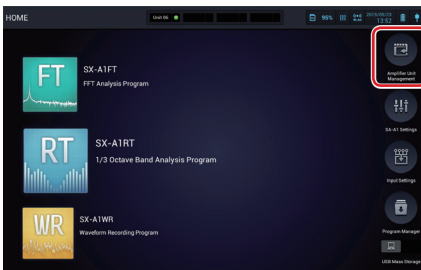

2. Tap [Update] in [Basic Information].

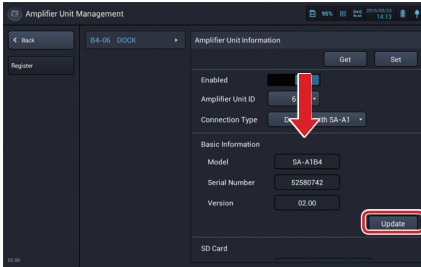

3. Tap [OK].

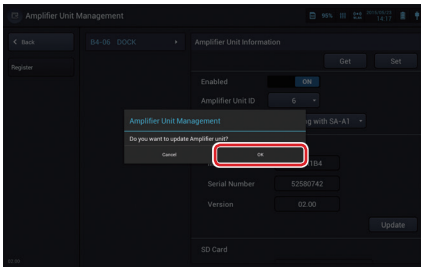

Confirm whether a program file which can be updated is saved on the SD memory card. When confirmation is complete, the update screen is displayed.

MEMO	<ul style="list-style-type: none"> - It takes long to check depending on the capacity. - If an installable program file is not found or more than one update program exists, “Available update program does not exist or multiple update programs exists.” is displayed. In this case, check if a program file is saved on the SD memory card or if multiple update programs exist.
-------------	---

4. Tap [OK].

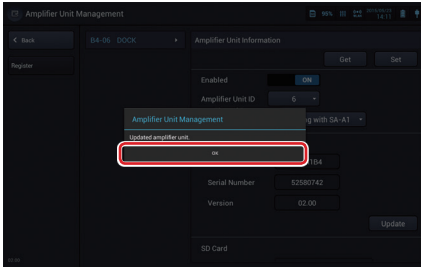

- Do not power off or pull out the SD memory card during update of the amplifier unit. It may cause the device to stop starting up.



- When a system update is required, it should be done first. Performing an amplifier unit update first causes the update to fail.

MEMO

- The amplifier unit cannot be updated with wireless connection. Update the amplifier unit while it is docked with the device or LAN connection is made.
- Use an external power supply to update the unit with LAN connection.

Deleting the Amplifier Unit

Use the following procedures to delete the amplifier unit not used in the unit.

1. Tap [Amplifier Unit Management] on the HOME screen.

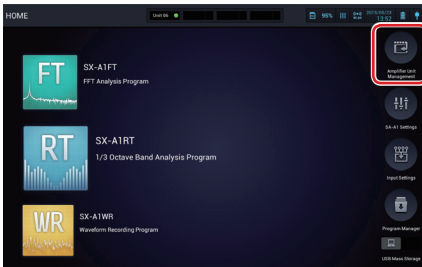

2. Slide the screen down and tap [Run] in [Unregister].

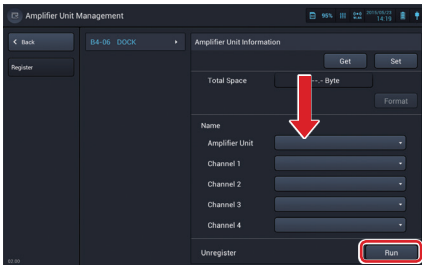

3. Tap [OK].

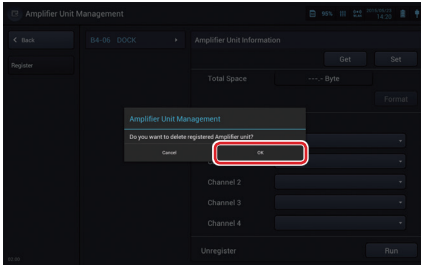

MEMO - If you use the deleted amplifier unit again, you need to register it again. (P. 70)

Amplifier Unit Mass Storage Function

When the amplifier unit is connected to a computer, the SD memory card inserted to the amplifier unit can be used as mass storage class (MSC) except during measurement and read/write of SD memory card. A Windows standard driver can be used for this MSC driver.

The amplifier unit is equipped with CDC Serial and RNDIS functions as well as MSC for debugging. Since these functions are unavailable, the unit is displayed as an unknown device on the Device Manager window. MSC can be used without problems in this situation.

Configuring the Calibration

Configuring the Calibration

Calibration information such as the channel or sensor type can be configured for each amplifier unit and channel. Be sure to perform the appropriate calibration for the connected sensor before starting measurement in order to obtain correct measurement results.

1. Tap [Input Settings] on the HOME screen.

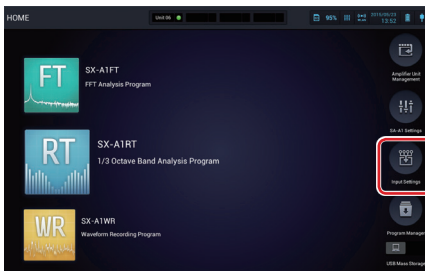

2. When multiple amplifier units are registered, tap the target amplifier unit.

3. Tap [▼] on the right side of [Channel].

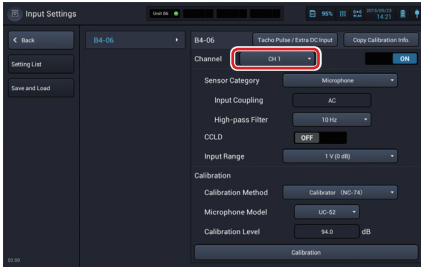

4. Tap the name of the channel of which you want to configure the calibration.

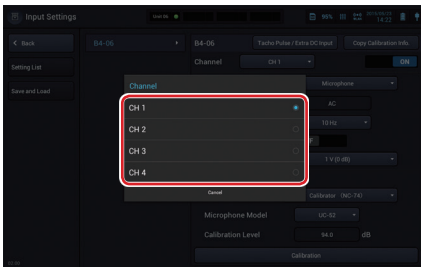

5. Tap [▼] on the right side of [Sensor Category].

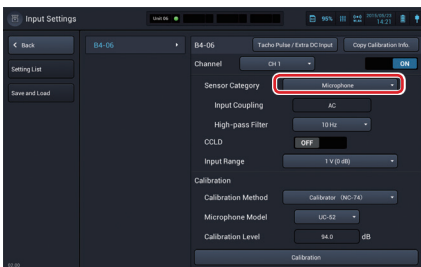

6. Tap the type of the sensor connected.

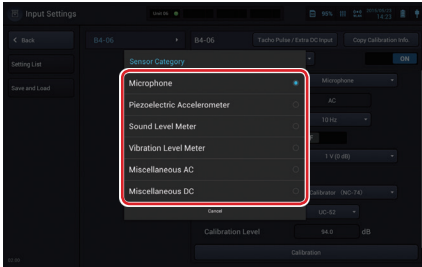

7. Configure each item as needed.

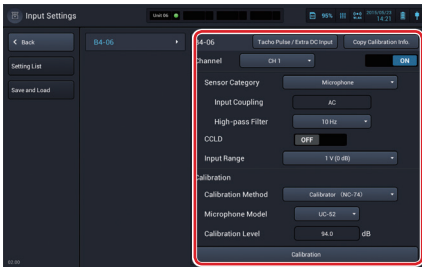

MEMO - For details on settings for each item, see "Instruction Manual Application" provided with the unit.

8. Tap [Calibration].

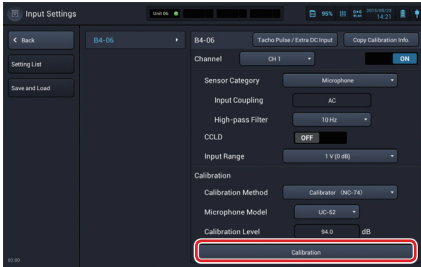

The calibration execution screen is displayed.

9. Tap [Calibration].



Monitoring stops and calibration settings are updated to the selected contents. When the update is completed, monitoring will be resumed.

MEMO - The step 8, 9 may be unnecessary depending on the calibration method.

10. Tap [Close].

Copying the Calibration Information

The calibration information of the selected amplifier unit or channel can be copied to another amplifier unit or another channel.

1. Tap [Input Settings] on the HOME screen.
2. Tap [Copy Calibration Info.].

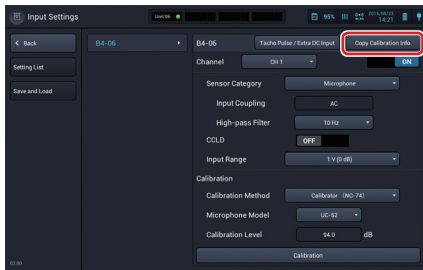

The calibration information copy screen is displayed.

3. Specify [Copy Mode] and [Original] and then tap [Copy].



4. Tap [OK].

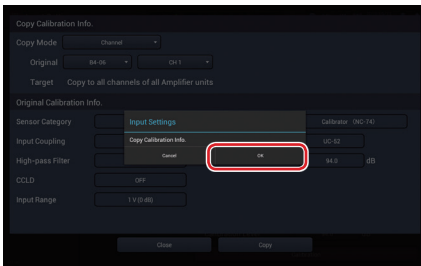

The calibration information will be copied.

5. Tap [OK].

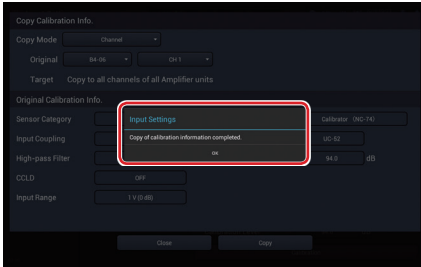

6. Tap [Close].

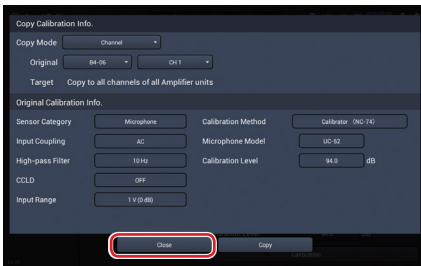

Displaying the Calibration Information List

The calibration information of each channel of the selected amplifier unit can be listed on the screen. You can configure the calibration information of each channel displayed or perform calibration.

1. Tap [Input Settings] on the HOME screen.
2. Tap [Setting List].

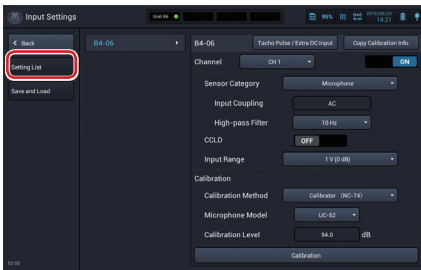

The calibration information list screen is displayed.

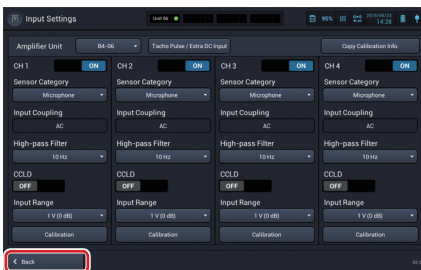

Tap [Back] to return to the previous screen.

Saving Calibration Values

You can save configured calibration information collectively. Up to five settings of calibration information can be saved in the internal memory, and one setting can be saved in the [CAL] folder in the SD memory card.

1. Tap [Input Settings] on the HOME screen.
2. Tap [Save and Load].

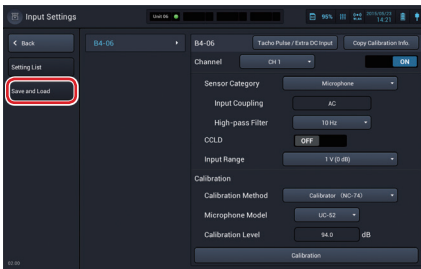

The calibration information save and load screen is displayed.

3. Tap [Save].

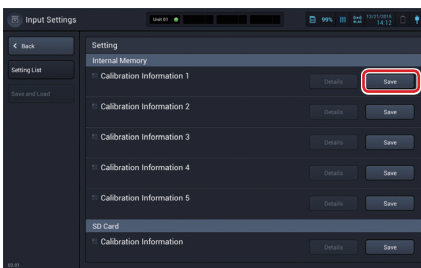

The entry screen for the setting name to save is displayed.

4. Enter a setting name and tap [OK].

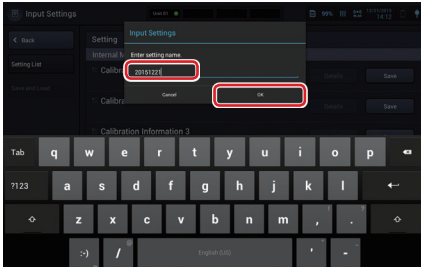

MEMO - You can use alphabetical and numeric characters and underscore for a setting name.

5. Tap [OK].

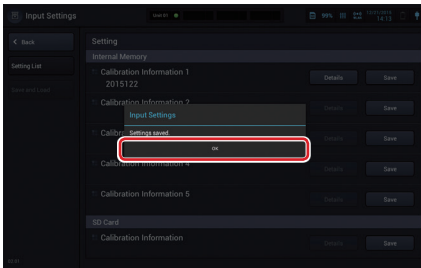

Important - You cannot load the calibration information if you change the name of the calibration information file saved in the SD memory card or edit it improperly.

Loading Calibration Values

Load the calibration information saved previously.

1. Tap [Input Settings] on the HOME screen.
2. Tap [Save and Load].

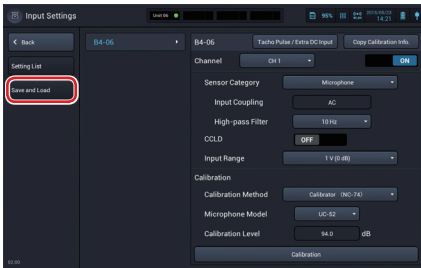

The calibration information save and load screen is displayed.

3. Tap [Details].

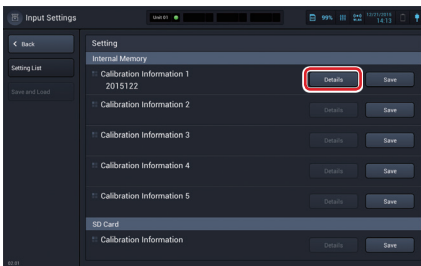

The calibration information screen is displayed.

4. Tap [Load].

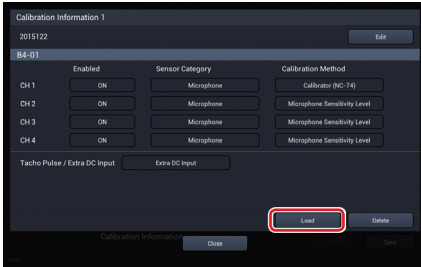

The confirmation screen for loading is displayed.

5. Tap [OK].

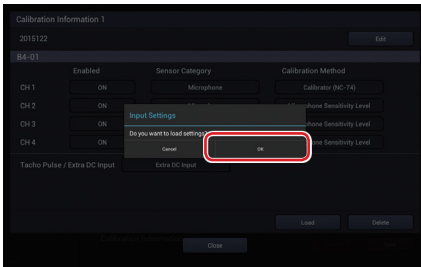

6. Tap [OK].

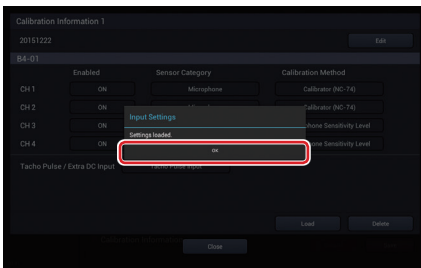

Editing the Setting Name

The setting name of saved calibration information can be changed.

1. Tap [Input Settings] on the HOME screen.
2. Tap [Save and Load].

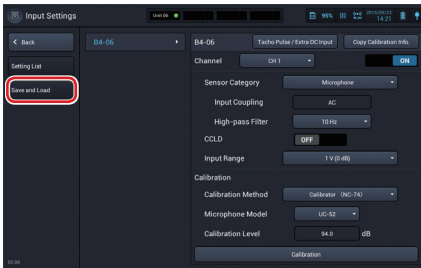

The calibration information save and load screen is displayed.

3. Tap [Details].

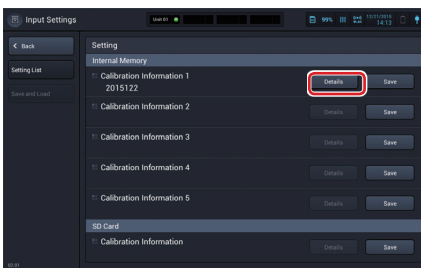

The calibration information screen is displayed.

4. Tap [Edit].

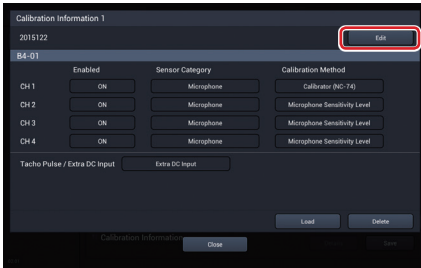

The entry screen for the setting name is displayed.

5. Enter a setting name and tap [OK].

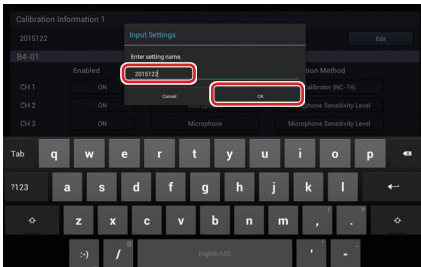

MEMO - You can use alphabetical and numeric characters and underscore for a setting name.

6. Tap [OK].

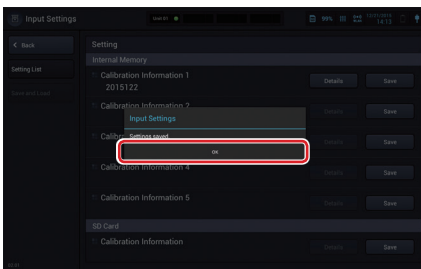

Deleting Calibration Values

Delete the calibration information saved previously.

1. Tap [Input Settings] on the HOME screen.
2. Tap [Save and Load].

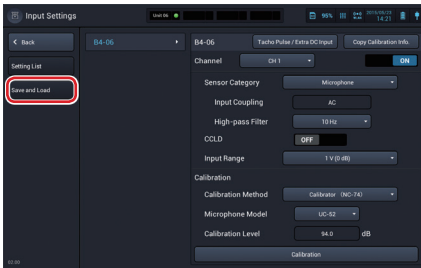

The calibration information save and load screen is displayed.

3. Tap [Details].

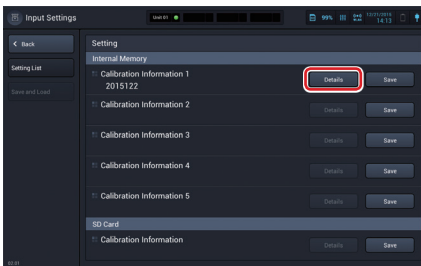

The calibration information screen is displayed.

4. Tap [Delete].

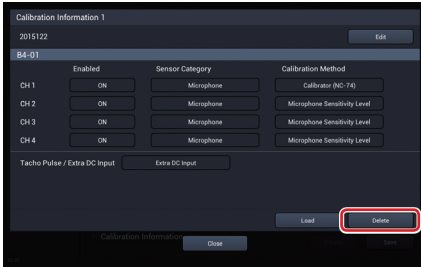

The confirmation screen for deletion is displayed.

5. Tap [OK].

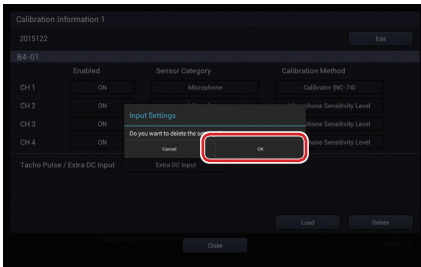

6. Tap [OK].

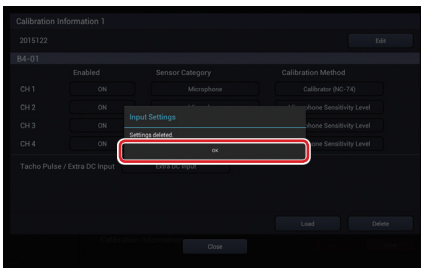

Managing the Program/System

Installing the Program

You can install a program on the unit to add new features.

1. Power off the unit and insert the SD memory card on which a program is saved to the SD memory card slot.
(P. 41)

Important

- Save an installation target program on an SD memory card without creating a folder.
- A zip file is used for the program, but there is no need to decompress it.

2. Power on the unit and tap [Program Manager] on the HOME screen.

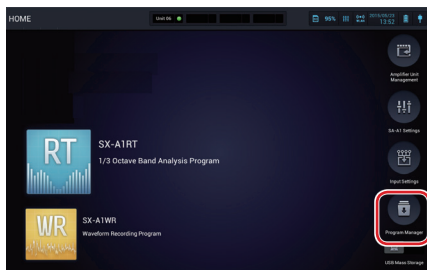

3. Tap [Program].

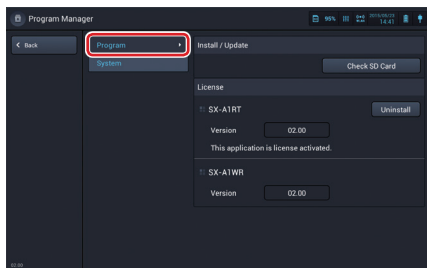

4. Tap [Check SD Card].

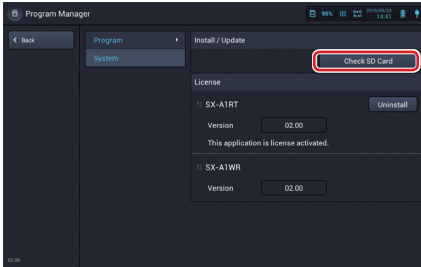

Check whether an installable program is saved on the SD memory card. If an installable program exists, the program name is displayed.

MEMO	<ul style="list-style-type: none">- It takes long to check depending on the capacity.- If an installable program file is not found or more than one update program exists, "Available update program does not exist or multiple update programs exists." is displayed. In this case, check if a program file is saved on the SD memory card or if multiple update programs exist.
-------------	--

5. Tap [Installation].

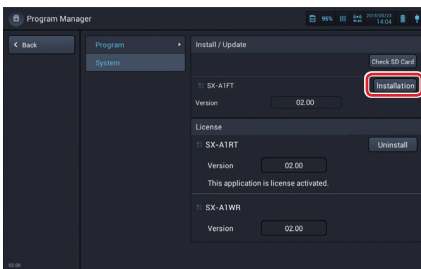

A message to check installation is displayed.

6. Tap [Install].

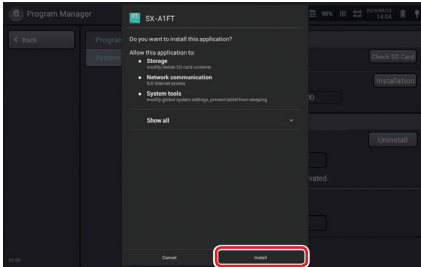

Installation is executed.

7. Tap [Done].

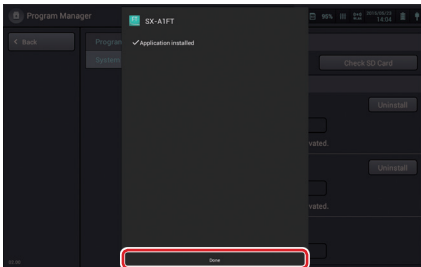

MEMO

- A program which is installed once can be updated, but cannot be uninstalled.

Checking the Program Version

1. Tap [Program Manager] on the HOME screen.
2. Tap [Program].

3. Check [Version] in the program name displayed.

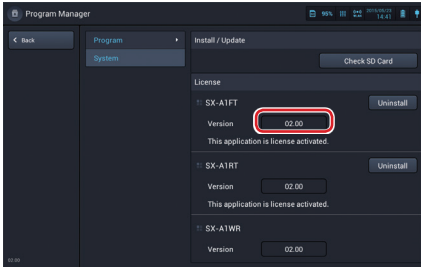

Updating the Program

The program version may be updated for the improved operations or functions. We recommend to use the latest version.

MEMO	<ul style="list-style-type: none">- It takes time to update the program. Connect the fully charged battery (three segments of the battery icon light up) and also the AC adapter before updating the program.
-------------	---

1. Power off the unit and insert the SD memory card on which the latest program is saved to the SD memory card slot. (P. 41)

Important	<ul style="list-style-type: none">- Save an update target program on an SD memory card without creating a folder.- Save one update file for a single program on an SD memory card. An error message is displayed when multiple update files exist for a single program.- A zip file is used for the program, but there is no need to decompress it.
------------------	---

2. Power on the unit and tap [Program Manager] on the HOME screen.

3. Tap [Program].

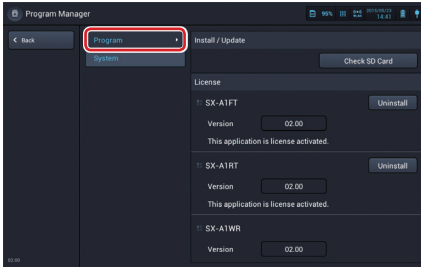

4. Tap [Check SD Card].

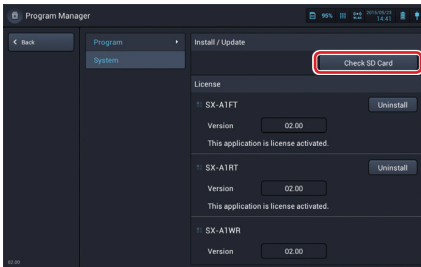

Confirm whether a program file which can be updated is saved on the SD memory card. If a program which can be updated exists, the program name is displayed.

MEMO	<ul style="list-style-type: none"> - It takes long to check depending on the capacity. - If an updatable program file is not found or more than one update program exists, "Available update program does not exist or multiple update programs exists." is displayed. In this case, check if a program file is saved on the SD memory card or if multiple update programs exist.
-------------	---

5. Tap [Update].

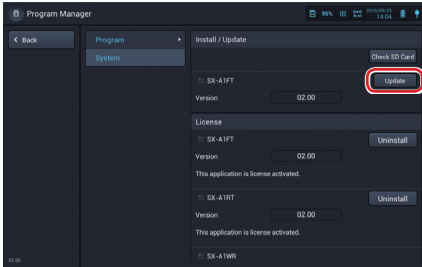

A message to check update is displayed.

6. Tap [OK].

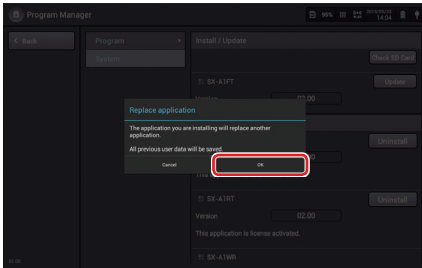

A message to check program update is displayed.

7. Tap [Install].

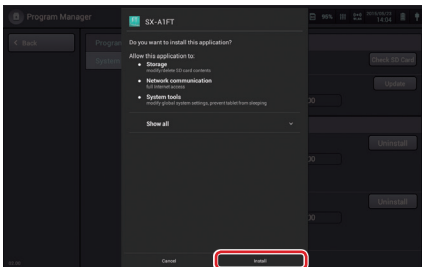

An update is executed.

8. Tap [Done].

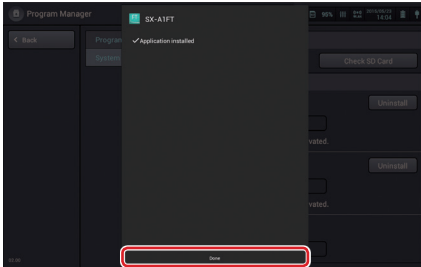

- Do not power off or pull out the SD memory card during installation of the program. It may cause the device to stop starting up.

Canceling the Program License

MEMO

- Insert the SD memory card that contains the program whose license you want to cancel to the SD memory card slot. License cancellation can be performed only when the appropriate SD memory card is inserted.

1. Tap [Program Manager] on the HOME screen.
2. Tap [Program].

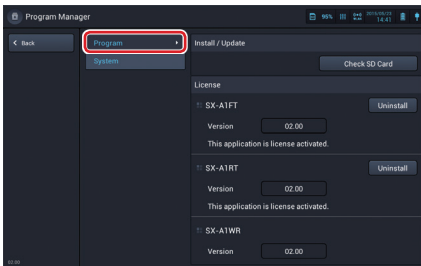

3. Tap [Uninstall] in the program to cancel the license.

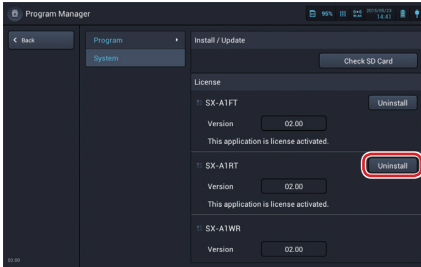

A message to check cancellation is displayed.

4. Tap [OK].

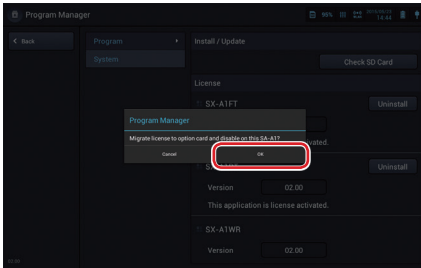

Cancellation is executed.

5. Tap [OK].

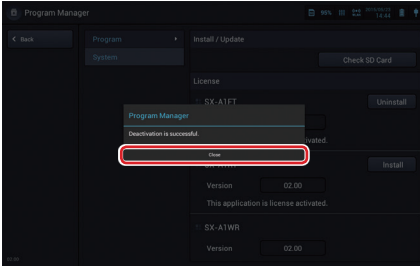

Now the license has been returned to the SD memory card from the RIONOTE.

MEMO

- License cancellation cannot be performed by the SX-A1WR since it is a program attached to the RIONOTE as standard.

Activating the Program License

MEMO

- Insert the SD memory card that contains the program whose license you want to cancel to the SD memory card slot. License cancellation can be performed only when the appropriate SD memory card is inserted.

1. Tap [Program Manager] on the HOME screen.

2. Tap [Program].

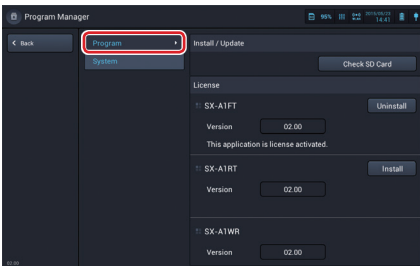

3. Tap [Install] in the program to activate the license.

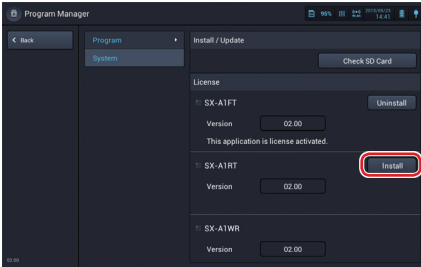

A message to check activation is displayed.

4. Tap [OK].

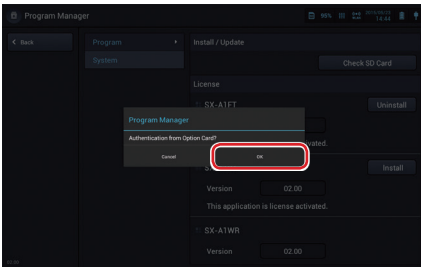

Activation is executed.

5. Tap [OK].

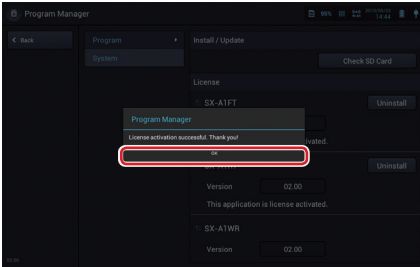

Now the license within the SD memory card has been transferred to the RIONOTE.

MEMO	- License activation cannot be performed by the SX-A1WR since it is a program attached to the RIONOTE as standard.
-------------	--

Checking the System Version

1. Tap [Program Manager] on the HOME screen.
2. Tap [System].

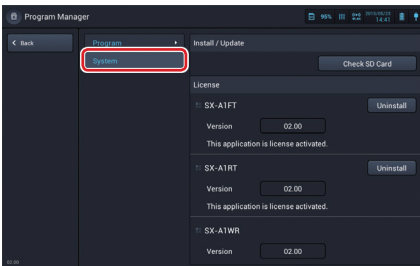

3. Check [Version].

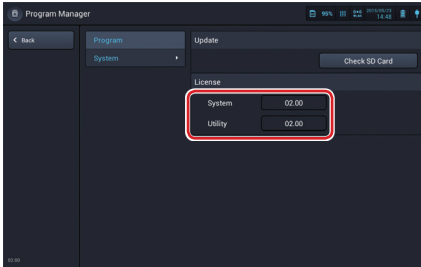

Updating the System

The system version may be updated for the improved operations or functions. We recommend to use the latest version.

MEMO	<ul style="list-style-type: none">- It takes time to update the program. Connect the fully charged battery (three segments of the battery icon light up) and also the AC adapter before updating the program.
-------------	---

- 1. Power off the unit and insert the SD memory card on which the latest system file is saved to the SD memory card slot. (P. 41)**

Important	<ul style="list-style-type: none">- Save an update target system file on an SD memory card without creating a folder.- A zip file is used for the system, but there is no need to decompress it.
------------------	---

- 2. Power on the unit and tap [Program Manager] on the HOME screen.**

3. Tap [System].

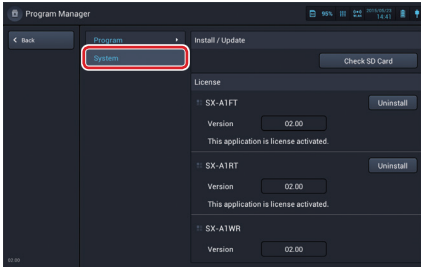

4. Tap [Check SD Card].

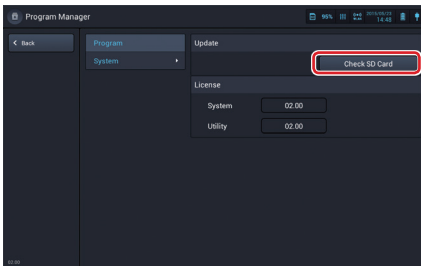

Confirm whether a system file which can be updated is saved on the SD memory card. When confirmation is complete, the update screen is displayed.

MEMO	<ul style="list-style-type: none"> - It takes long to check depending on the capacity. - If an updatable program file is not found or more than one update program exists, "Available update program does not exist or multiple update programs exists." is displayed. In this case, check if a program file is saved on the SD memory card or if multiple update programs exist.
-------------	---

5. Tap [Update].

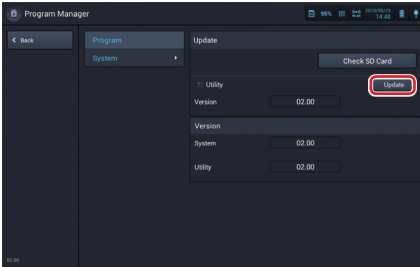

A screen to confirm the update is displayed.

6. Tap [Update].

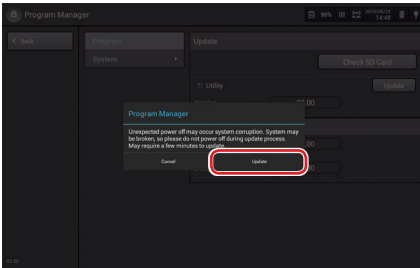

The screen displays “Preparing Update” and then “Updating”. When the update is complete, it returns to the version display screen.



Note

- Do not power off or pull out the SD memory card during update of the system. It may cause the device to stop starting up.

Updating the System and the program in a lump

The system version and the program version can be updated in a lump.

MEMO

- It takes time to update in a lump. Connect the fully charged battery (three segments of the battery icon light up) and also the AC adapter before updating the program.

- 1. Power off the unit and insert the SD memory card on which the latest mass update file is saved to the SD memory card slot. (P. 41)**

Important

- Save an update target mass update file on an SD memory card without creating a folder.
- A zip file is used for the mass update, but there is no need to decompress it.

- 2. Power on the unit and tap [Program Manager] on the HOME screen.**
- 3. Tap [System].**

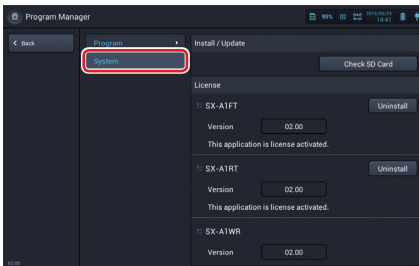

4. Tap [Check SD Card].

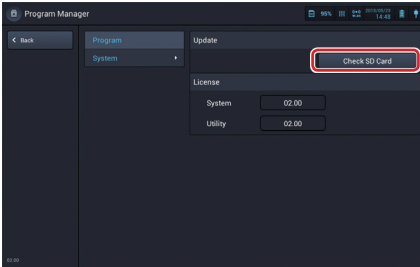

Confirm whether a mass update file which can be updated is saved on the SD memory card. When confirmation is complete, the update confirmation screen is displayed.

MEMO	<ul style="list-style-type: none">- It takes long to check depending on the capacity.- If an updatable program is not found or more than one update program exists, "Available update program does not exist or multiple update programs exists." is displayed. In this case, check if a program file is saved on the SD memory card or if multiple update programs exist.
-------------	---

5. Tap [Update].

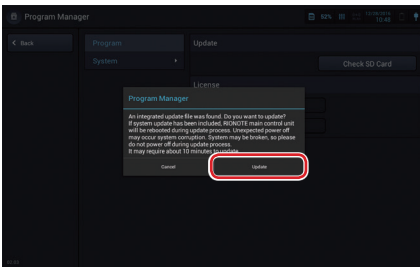

The screen displays "Preparing Update" and then "Updating". When the update is complete, it returns to the version display screen. It takes about 10 minutes to update.

 Note	<ul style="list-style-type: none">- Do not power off or pull out the SD memory card during update in a lump. It may cause the device to stop starting up.
---	---

Versions Required to Use SA-A1WD

The RIONOTE and SA-A1B2/B4, and measurement applications need to be updated to Ver. 2.0 or later versions to use the SA-A1WD.

Update them according to the following procedure.

Before starting update, download the latest firmware from the Rion website (<http://rion-sv.com/>) and save it on the SD memory card of the RIONOTE.

- 1. Update the RIONOTE utility to the latest version which should be Ver. 2.0 or later (see page 106).**
- 2. Update the RIONOTE system to the latest version which should be Ver. 2.0 or later (see page 106).**
- 3. Update the SA-A1B2/B4 system to the latest version which should be Ver. 2.0 or later.**

Register the SA-A1B2/B4 on the Amplifier unit management screen of RIONOTE to perform update (see page 74).

- 4. Update each measurement application to the latest version which should be Ver. 2.0 or later (see page 98).**

Important

- Keep this order also in updating from Ver 2.0 to Ver 2.1 or higher. Otherwise, updating may not be performed correctly.
- When updating SA-A1B2/B4 to Ver 2.1, it cannot be updated directly from Ver 1.0, Ver 1.1, etc. to Ver 2.1. Be sure to execute updating to Ver 2.1 after updating to Ver 2.0.

SA-A1 File Converter

The SA-A1 File Converter is a Windows application used to convert the data saved by RIONOTE programs such as SX-A1FT and SXA1RT to a text file in a required format. Files and project folders can be added individually, and also multiple files or folders can be added collectively by drag and drop. Also, the files on the list can be converted collectively. The saved text files can be imported using a text editor or Excel.

Software Installation

To install the File Converter software, proceed as follows. Supported operating systems are Microsoft Windows 7 Professional or Windows 8.1 Pro (every 32 bit or 64 bit), Japanese version or English version (The screen examples shown here are for Windows 7.)

- 1. Insert the CD-ROM supplied with the unit into the disc drive of a computer.**
- 2. Copy the “Setup” file from the “FileConverter” folder to the desktop of the computer, and double-click the file.**
- 3. A screen showing pre-requirements for installing the File Converter may appear. In such a case, click the [Install] button on this screen.**

4. After the required software shown on the pre-requirements screen has been installed, the initial screen for the File Converter installation will appear. Click the [Next] button to proceed.

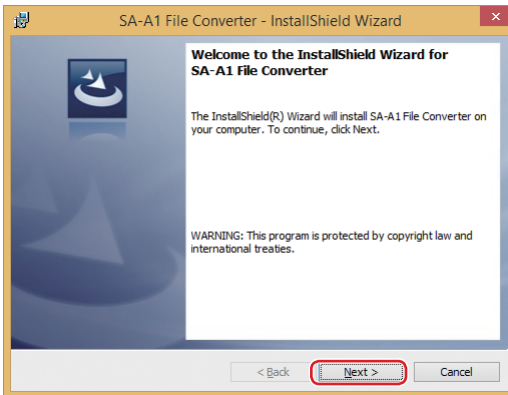

5. The Software Usage License Agreement will be shown. Select [I accept the terms in the license agreement] and click the [Next] button.



6. The screen for selecting the installation target folder appears. If there is no change necessary, click the [Next] button.

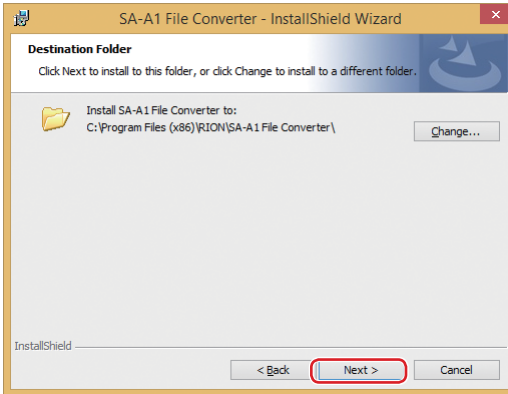

7. Specify the user(s) for whom to install the File Converter.

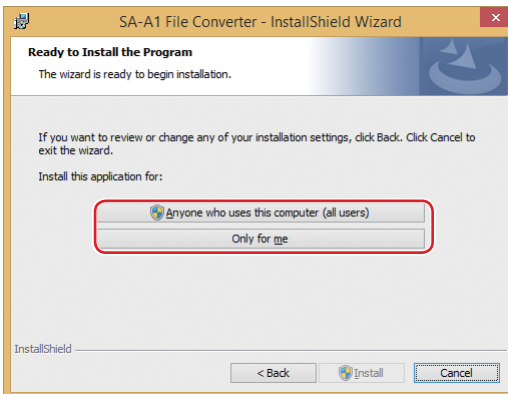

8. The installation process for the File Converter starts.
When the completion screen is shown, click the [Finish] button to terminate the process.

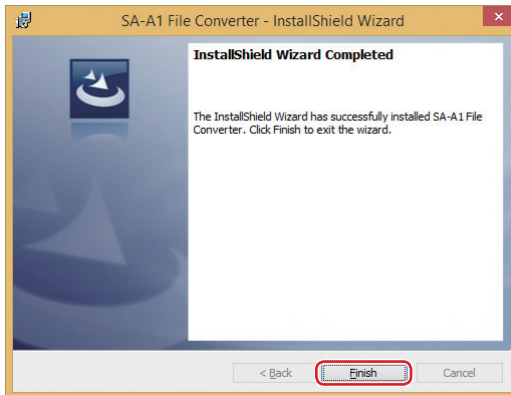

Starting the Software

After installation is completed, start the program by double-clicking the shortcut icon that was created on the desktop.

Screen Configuration

The main screen of the software has the elements shown below.

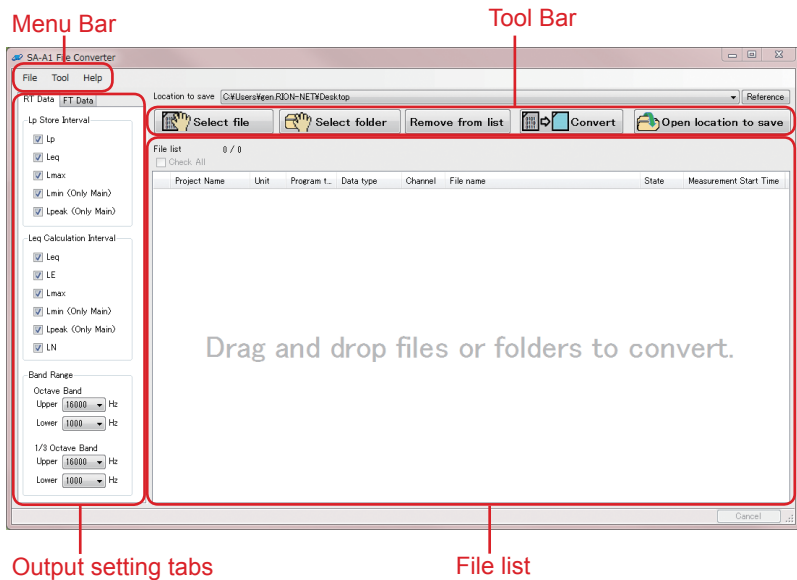

Converting Files

1. Use drag & drop to add a file or folder to the file list window. It is also possible to drag & drop multiple files or folders together. Another method to select a file or folder is accessing the [File] menu and clicking [Convert File], or clicking the [Select file] or [Select folder] button on the toolbar. To remove a file from the list, select a file on the list and click the [Remove from list] button or Delete key. You can select multiple entries (rows in the list) by using the Shift and Ctrl keys. Ctrl + A selects all entries. Files can also be removed from the list by using the Delete key.

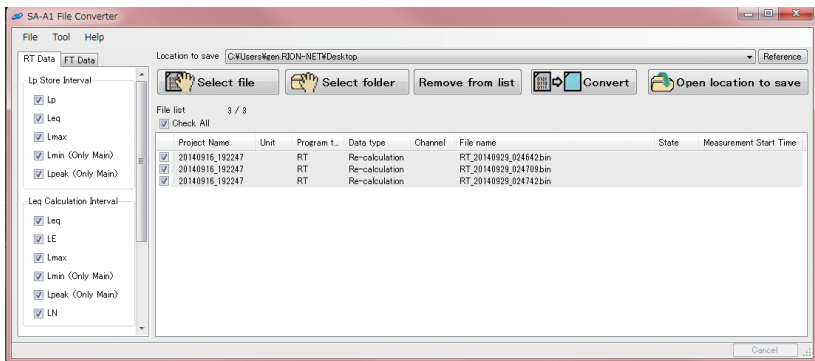

2. Click the [Reference] button and select the location where the converted files are to be saved.

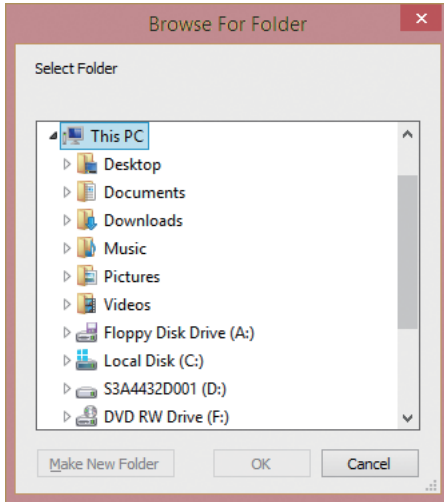

3. Click the [Convert] button on the tool bar to convert the files in the list. After conversion, each file will be saved in the location specified in step 2, and the “State” column for the file shows “Completed”.

Project Name	Unit	Program t.	Data type	Channel	File name	State	Measurement Start Time
<input checked="" type="checkbox"/> 20140916_192247	RT		Re-calculation		RT_20140929_024709.bin	Completed	
<input checked="" type="checkbox"/> 20140916_192247	RT		Re-calculation		RT_20140929_024742.bin	Completed	
<input checked="" type="checkbox"/> 20140916_192247	RT		Re-calculation		RT_20140929_024642.bin	Completed	

Clicking the [Open location to save] button on the tool bar opens the folder where the files are saved.

Unless the original binary files have been deleted, conversion can be performed as often as desired. The File Converter software does not modify or delete the original binary files.

Information about Text Files created by the Conversion (SX-A1RT)

Text files (extension “.txt”)

Conversion of one project will result in two files being created, which are named as follows: “<Project name>_0001_RT_Long.txt” and “<Project name>_0001_RT_Short.txt”. The contents are largely identical to the items in the “.rnh” file in the project folder.

Data files (extension “.csv” or “.tsv”)

With both file types, columns show the time and rows show the level for each frequency and the AP level in 0.1 dB units.

Rows are created for every 100 ms in the case of L_p store cycle data (data in files containing the “RT_Short” string). L_{eq} calculation interval data (data in files containing the “RT_Long” string) are created for each specified time interval (100 ms or higher, for example every second).

Columns contain the data for the band range specified with the File Converter software. For example, if the range from 100 Hz to 5000 Hz was specified, only data for these bands are saved.

An example is shown below. The “Date” column indicates year/month/date, and the “Time” column indicates hours/minutes/seconds in 100 ms units. The “Main AP” column indicates the all-pass level, and the “100” and “125” columns indicate the 100 Hz and 125 Hz band level respectively.

Date	Time	Main AP	100	125	...
2014/7/8	53:01.9	44.8	35.1	34.2	
2014/7/8	53:02.9	49.3	34.4	35.4	
2014/7/8	53:03.9	43.5	32.7	32.4	
2014/7/8	53:04.9	40.1	30	28.1	
2014/7/8	53:05.9	48.6	33.4	30.1	

Data files are created separately for each calculation type, as listed below.

a) LN file

Separate files are created for each time percentile level LN1, LN2, LN3, LN4, and LN5.

b) LE file

c) Leq file

d) Lmax file

e) Lmin file

f) Lpeak file

When opening CSV files in Microsoft Excel, the date and time columns may not show up correctly, depending on the display format settings for the cell. To ensure correct display, select the respective column, right-click to bring up the menu, select [Format Cells] and use the "Custom" option to specify "hh:mm:ss.0".

Settings

Changing the delimiter and date format for saved text files
Select [Tool] > [Settings] to open the “Settings” window.

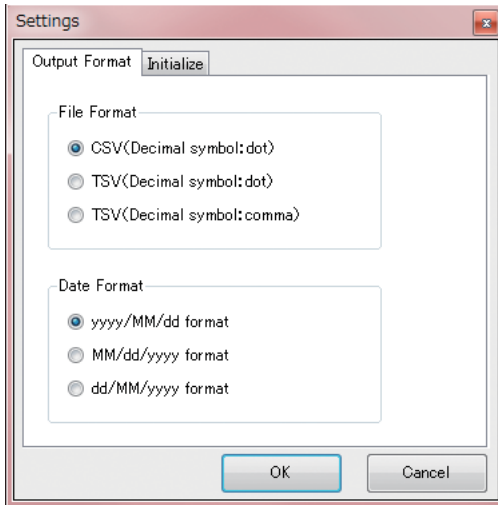

Selecting calculation type and data selection

Make sure that the required items are checked under the operation setting tabs [RT Data] and [FT Data]. In order to save the same data as the SX-A1FT results displayed on the RIONOTE screen, match the Power/Amplitude and Peak/RMS settings to the display settings of the RIONOTE.

List display

The sort order of list items can be changed by clicking on the column title such as “Project name” or “Data type”.

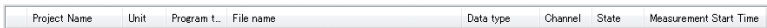

Project Name	Unit	Program t...	File name	Data type	Channel	State	Measurement Start Time
--------------	------	--------------	-----------	-----------	---------	-------	------------------------

Clicking on a list item toggles the sort order between ascending and descending.

Use of output setting tab [FT Data]

For the conversion output from SX-A1FT files, you can select the unit, linear or dB indication, dimension (power or amplitude), power spectral density, and peak/RMS.

If acceleration has been calibrated in m/s² in SX-A1FT, selecting “EU” as unit and selecting the “dB” check box allows conversion into a dB calibration unit value.

Use of output setting tab [RT Data]

For SX-A1RT files, the calculation types to be saved (L_p , L_{eq} , L_{max} etc.) can be specified separately for 100 ms L_p store interval data (data in files containing the “RT_Short” string) and for L_{eq} calculation interval data for each specified interval (data in files containing the “RT_Long” string). The required band range can also be specified. (The names “ L_p store interval data” and “ L_{eq} calculation interval data” are used for distinction, but the L_p store data also comprise L_{eq} data.)

For example, if only the L_p and L_{eq} data for each 100 ms interval are required, select only the “Lp” and “Leq” check boxes for Lp mode. Also, if only data in the range from 100 Hz to 5 kHz for 1/3 octave bands are required, specify “100 Hz” as lower limit and “5 kHz” as upper limit.

Specifications

System Requirements

Operating system

Microsoft Windows 7 Professional or Windows 8.1 Pro (every 32 bit or 64 bit), English version or Japanese version

CPU CPU supporting the above operating systems

RAM RAM capacity supporting the above operating systems

HDD Sufficient free space for handling data

Supported files

Binary files created by SX-A1RT or SX-A1FT

Language support

English, Japanese

Date formats

U.S. style (MM/dd/yyyy), European style (dd/MM/yyyy), or Japanese style (yyyy/MM/dd) can be selected. yyyy stands for the year, MM for the month, and dd for the day of the month.

File type

Text file format can be selected from CSV (comma delimited) or TSV (dot delimited, comma delimited).

Input Setting Details

Channel Settings

The channel setting items appearing on the input settings screen depend on the external equipment selected for the sensor category, as shown in the table below (if the [Enabled] setting for CH1 to CH4 is [ON]).

Sensor Category	Input Coupling	High-pass Filter	CCLD	Input Range
Microphone	Fixed to AC	OFF / 1 Hz / 10 Hz	OFF / ON	10 V (20 dB) 1 V (0 dB) 0.1 V (-20 dB) 0.01 V (-40 dB)
Piezoelectric Accelerometer	Fixed to AC	OFF / 1 Hz / 10 Hz	OFF / ON	Same as above
Sound Level Meter	Fixed to AC	OFF / 1 Hz / 10 Hz	Fixed to OFF	Same as above
Vibration Level Meter	Fixed to AC	Fixed to OFF	Fixed to OFF	Same as above
Miscellaneous AC	Fixed to AC	OFF / 1 Hz / 10 Hz	OFF / ON	Same as above
Miscellaneous DC	Fixed to AC	None	Fixed to OFF	Same as above

High-pass Filter

Select a high-pass filter setting suitable for the input signal. The frequency shown is the cutoff frequency.

CCLD

Set to ON if a CCLD (Constant Current Linear Drive) type microphone or sensor or an accelerometer with integrated pre-amplifier is connected.

Input Range

Set the input range for each channel. Choose a setting that is suitable for the magnitude of the input signal and the usage pattern of the unit.

Usually, the input range should be set as low as possible, without causing overload by excessive signals. However, in cases such as product inspections or periodic measurements, where products are to be compared or changes over time are to be monitored, the input range may have to be kept at the predetermined setting.

Calibration

The calibration items appearing on the input settings screen depend on the external equipment selected for the sensor category (if the [Enabled] setting for CH1 to CH4 is [ON]).

Also, the calibration items depend on the selected calibration method.

Calibration when the microphone is connected

The calibration items appear when the [Microphone] is selected for the sensor category, as shown in the table below.

Calibration Method	Sensitivity	Sound Pressure Level	Microphone Model	Static Pressure	Calibration Level	Current Level
Microphone Sensitivity Level	-100.0 to 10.0 dB re 1V/Pa	None	None	None	None	None
Calibrator (NC-72/ NC-72A)	None	113.0 dB to 115.0 dB	UC-52 UC-53A UC-57 UC-59 UC-54	90.0 kPa to 110.0 kPa	Set value of Sound Pressure Level	Bar graph reading
			Others	None	113.0 dB to 115.0 dB	
Calibrator (NC-74)	None	None	UC-52 UC-53A UC-57 UC-59	None	Characteristic value of microphone	
			Others	None	93.0 dB to 95.0 dB	
Calibrator (NC-75)	None	None	UC-52 UC-53A UC-57 UC-59	None	Characteristic value of microphone	
			Others	None	93.0 dB to 95.0 dB	

Calibration when the piezoelectric accelerometer is connected

The calibration items appear when the [Piezoelectric Accelerometer] is selected for the sensor category, as shown in the table below.

When the Calibration Method is [Pickup Sensitivity]

Sensitivity (unit: mV/[EU Unit])	Amplitude Reverse	EU Unit	Reference Value of decibels (unit: EU Unit)
0.0 to 100.0	OFF/ON	m/s ²	10 ⁻⁵ /10 ⁻⁶
		mm/s μm inch/s ² inch/s mil/s ² mil/s G	0.0 to 100.0

When the Calibration Method is [VE-10]

Pickup Model	Amplitude Reverse	Charge Converter	EU Unit	Reference Value of decibels (unit: EU Unit)	Calibration Value (unit: EU Unit)	Current Value
PV-97I PV-40 PV-41 PV-90T PV-91C PV-10B	None	None	m/s ²	10 ⁻⁵ /10 ⁻⁶	0.0001 to 15000	Bar graph reading
PV-93 PV-97C PV-03 PV-44A PV-63 PV-65 PV-90H PV-08A PV-90B PV-87 PV-85/PV-86 PV-94/PV-95	None	Fixed to [VP-40/ VP-42]	mm/s μm inch/s ² inch/s mil/s ² mil/s G	0.0 to 100.0		
Others	OFF/ON	None				

Calibration when the sound level meter is connected

The calibration items appear when the [Sound Level Meter] is selected for the sensor category, as shown in the table below.

Calibration Method	Measurement Range	Calibration Range	Calibration Level	Current Level
Internal Calibration	130 dB 120 dB 110 dB 100 dB 90 dB 80 dB 70 dB	130 dB	0.0 dB to 130.0 dB	Bar graph reading
Calibrator (NC-72/NC-72A)		120 dB		
Calibrator (NC-74)		110 dB		
		100 dB		
Calibrator (NC-75)	(None for internal calibration)			

Calibration when the vibration level meter is connected

The calibration items appear when the [Vibration Level Meter] is selected for the sensor category, as shown in the table below.

Calibration Method	Model	Reference Value of decibels (unit: m/s ²)	Measurement Range	Calibration Level	Current Level
Fixed to Internal Calibration	Fixed to [VM-53/VM-53A]	10 ⁻⁵ /10 ⁻⁶	120 dB 110 dB 100 dB 90 dB 80 dB 70 dB	0.0 dB to 130.0 dB	Bar graph reading

Calibration of miscellaneous AC

The calibration items appear when the [Miscellaneous AC] is selected for the sensor category, as shown in the table below.

When the Calibration Method is [Sensor Sensitivity]

Sensitivity (unit: V/[EU Unit])	EU Unit	Reference Value of decibels (unit: EU Unit)
0.0000000001 to 1000.0	Arbitrary	0.0000000001 to 100.0

When the Calibration Method is [Calibrator] and Linear (EU)/Log (dB) is [Linear (EU)]

EU Unit	Reference Value of decibels (unit: EU Unit)	Calibration Frequency	Calibration Value (unit: EU Unit)	Current Value (unit: EU Unit)
Arbitrary	0.0000000001 to 100.0	31.5 Hz to 1000.0 Hz	0.0 to 1500.0	Bar graph reading

When the Calibration Method is [Calibrator] and Linear (EU)/Log (dB) is [Log (dB)]

EU Unit	Reference Value of decibels (unit: EU Unit)	Calibration Frequency	Calibration Level (unit: EU Unit)	Current Level (unit: EU Unit)
Arbitrary	0.0000000001 to 100.0	31.5 Hz to 1000.0 Hz	0.0 to 1500.0	Bar graph reading

Calibration of miscellaneous DC

The calibration items that appear when [Miscellaneous DC] is selected for the sensor category are shown in the tables below.

EU Unit	Sensitivity (unit: EU Unit)	Offset Voltage
Arbitrary	0.0000000001 to 100.0	-20.0 V to 20.0 V

Setting of Tacho Pulse / Extra DC Input

The setting items of tacho pulse / extra DC input appear on the input settings screen, as shown in the table below.

Tacho Pulse / Extra DC Input	EU Unit	Sensitivity (unit: V/[EU Unit])	Offset Voltage	Number of pulses per rotation
OFF	None	None	None	None
Extra DC Input	Arbitrary	0.0000000001 to 100.0	-20.0 V to +20.0 V	None
Tacho Pulse Input	None	None	None	1 to 100

About the Calibration

Basic Relationship between Physical Quantity of Measurement Object and Recorded Data

A sensor produces a voltage (electrical signal) in response to a change in the physical quantity acting upon it. However, when the sensor is changed to one with a different sensitivity, the output voltage will also change significantly, even if the physical quantity remains the same.

Therefore sensors usually come with individual documentation stating the sensitivity of the sensor in response to a given physical quantity. Some examples are given below.

Examples

- Sensitivity of accelerometer with built-in preamplifier is $6.42 \text{ mV}/(\text{m/s}^2)$
When the normal acceleration unit of 1 m/s^2 is applied to this sensor, it will produce a voltage of 6.42 mV .
- Sensitivity of Microphone is -28 dBV/Pa
When the normal sound pressure unit of 1 Pa is applied to this sensor, it will produce a voltage of $-28 \text{ dBV} = 0.04 \text{ V}$.

When the sensor sensitivity is known, the sensor output can be used to calculate the physical quantity acting on the sensor according to the following equation:

$$\text{Physical quantity} = (1/\text{sensor sensitivity}) \times \text{sensor output voltage}$$

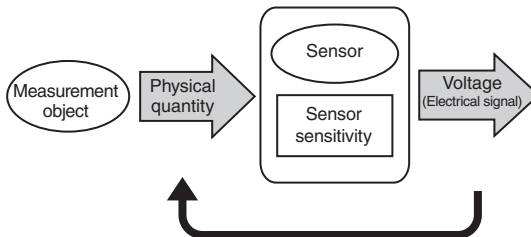

$$\text{Physical quantity} = (1/\text{sensor sensitivity}) \times \text{sensor output voltage}$$

Calibration with SX-A1WR

The SX-A1WR program performs A/D conversion of the input voltage to calculate the WAVE value. In this operation, $[(\text{input voltage range} \times \sqrt{2}) / (4072960 \times \sqrt{2})]$ is used as 1 unit when the bit length setting is 24 bit, and $[(\text{input voltage range} \times \sqrt{2}) / (15910 \times \sqrt{2})]$ is used as 1 unit when the bit length setting is 16 bit. The result is recorded as a WAVE file.

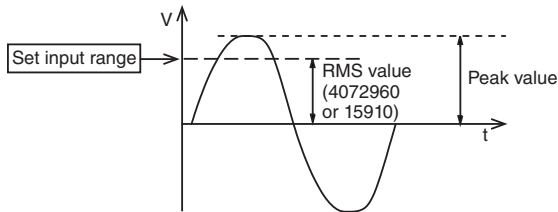

The relationship between the voltage output by the sensor and the WAVE value is expressed by the following equations.

Bit length 24 bit:

$$\begin{aligned} \text{WAVE value} &= \text{sensor output voltage} / (\text{input voltage range} \times \sqrt{2}) \times (4072960 \times \sqrt{2}) \\ \rightarrow \text{Sensor output voltage} &= [(\text{input voltage range} \times \sqrt{2}) / (4072960 \times \sqrt{2})] \times \\ &\quad \text{WAVE value} \end{aligned}$$

Bit length 16 bit:

$$\begin{aligned} \text{WAVE value} &= \text{sensor output voltage} / (\text{input voltage range} \times \sqrt{2}) \times (15910 \times \sqrt{2}) \\ \rightarrow \text{Sensor output voltage} &= [(\text{input voltage range} \times \sqrt{2}) / (15910 \times \sqrt{2})] \times \\ &\quad \text{WAVE value} \end{aligned}$$

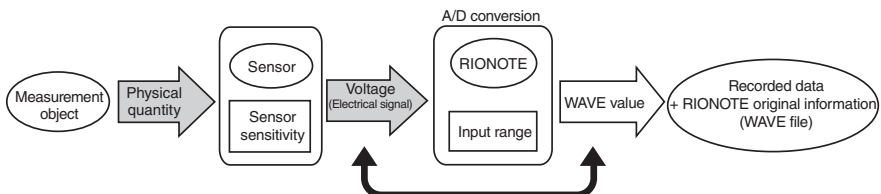

$$\begin{aligned} \text{Sensor output voltage} &= [(\text{input voltage range} \times \sqrt{2}) / (4072960 \times \sqrt{2})] \times \text{WAVE value, or} \\ \text{Sensor output voltage} &= [(\text{input voltage range} \times \sqrt{2}) / (15910 \times \sqrt{2})] \times \text{WAVE value} \end{aligned}$$

Consequently, the relationship between the physical quantity and the WAVE value recorded in the WAVE file is as follows.

Physical quantity

$$= (1 / \text{sensor sensitivity}) \times \text{sensor output voltage}$$

$$= (1 / \text{sensor sensitivity}) \times [(\text{input voltage range} \times \sqrt{2}) / (4072960 \times \sqrt{2})] \times \text{WAVE value}$$

When bit length setting is 24 bit

$$= (1 / \text{sensor sensitivity}) \times [(\text{input voltage range} \times \sqrt{2}) / (15910 \times \sqrt{2})] \times \text{WAVE value}$$

When bit length setting is 16 bit

This software calls

$$(1 / \text{sensor sensitivity}) \times [(\text{input voltage range} \times \sqrt{2}) / (4072960 \times \sqrt{2})]$$

or

$$(1 / \text{sensor sensitivity}) \times [(\text{input voltage range} \times \sqrt{2}) / (15910 \times \sqrt{2})]$$

as “ValuePerBit”. Using “ValuePerBit”, the physical quantity becomes as follows.

$$\text{Physical quantity} = \text{ValuePerBit} \times \text{WAVE value}$$

$$\text{Physical quantity} = (1/\text{sensor sensitivity}) \times [(\text{input voltage range} \times \sqrt{2}) / (4072960 \times \sqrt{2})] \times \text{WAVE value}$$

$$= \text{Value Par Bit (unit: /bit)} \times \text{WAVE value, or}$$

$$\text{Physical quantity} = (1/\text{sensor sensitivity}) \times [(\text{input voltage range} \times \sqrt{2}) / (15910 \times \sqrt{2})] \times \text{WAVE value}$$

$$= \text{Value Par Bit (unit: /bit)} \times \text{WAVE value}$$

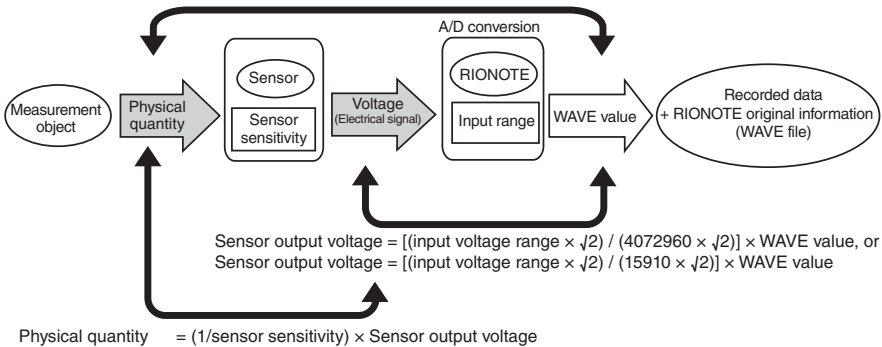

By performing calibration (read-out conversion) when making input settings, “sensor sensitivity” and “ValuePerBit” are set to appropriate values. Because WAVE files subsequently recorded with SX-A1WR also contain the relevant information, the measurement data can be read using physical quantity units. The physical quantity can be shown as a dB value by using the “Reference Value of decibels”. The dB value is calculated as follows.

$$\text{dB value} = 20 \log_{10} (\text{rms value of physical quantity} / \text{Reference Value of decibels})$$

The Reference Value of decibels is set as follows, depending on the sensor category selected on the input setting screen.

Sensor Category	Reference Value of decibels
Microphone	2×10^{-5}
Piezoelectric Accelerometer	When EU unit is m/s ² : 10^{-5} or 10^{-6} (10^{-6} for ISO, 10^{-5} for Japanese JIS) When EU unit is other than m/s ² : default value is 1 (can be changed by user)
Sound Level Meter	2×10^{-5}
Vibration Level Meter	10^{-5} or 10^{-6} (10^{-6} for ISO, 10^{-5} for Japanese JIS)
Miscellaneous AC	Default value is 1 (can be changed by user)
Miscellaneous DC	None

When “Miscellaneous AC” etc. is selected as sensor category, specify a suitable Reference Value of decibels if the display is to be in dB values.

In SX-A1WR, setting the graph scale to “Linear” results in display as physical quantity, and setting the graph scale to “Log” results in dB value display using the Reference Value of decibels.

Calibration with SX-A1RT

The SX-A1RT program shows the input voltage as a level-converted value (dB value) calculated using the “Sensitivity” and “Reference Value of decibels” parameters.

The relationship between the physical quantity and the dB value is as follows.

$$\text{dB value} = 20 \log_{10} (\text{rms value of physical quantity} / \text{Reference Value of decibels})$$

The Reference Value of decibels is set as follows, depending on the sensor category selected on the input setting screen.

Sensor Category	Reference Value of decibels
Microphone	2×10^{-5}
Piezoelectric Accelerometer	When EU unit is m/s^2 : 10^{-5} or 10^{-6} (10^{-6} for ISO, 10^{-5} for Japanese JIS) When EU unit is other than m/s^2 : default value is 1 (can be changed by user)
Sound Level Meter	2×10^{-5}
Vibration Level Meter	10^{-5} or 10^{-6} (10^{-6} for ISO, 10^{-5} for Japanese JIS)
Miscellaneous AC	Default value is 1 (can be changed by user)
Miscellaneous DC	None

When “Miscellaneous AC” etc. is selected as sensor category, specify a suitable Reference Value of decibels if the display is to be in dB values.

Calibration with SX-A1FT

With the SX-A1FT program, the displayed value changes depending on the Y axis type and the “Sensitivity” and “Reference Value of decibels” parameters, as shown below.

		Unit	
		V	EU
Graph Type (Y Axis)	Linear (EU)	Input voltage shown as is	$(1 / \text{sensor sensitivity}) \times \text{sensor output voltage}$
	Log (dB)	20Log_{10} (input voltage)	$20\text{Log}_{10} ([1 / \text{sensor sensitivity}] \times \text{sensor output voltage} / \text{Reference Value of decibels})$ $= 20\text{Log}_{10} (\text{physical quantity} / \text{Reference Value of decibels})$

The Reference Value of decibels is set as follows, depending on the sensor category selected on the input setting screen.

Sensor Category	Reference Value of decibels
Microphone	2×10^{-5}
Piezoelectric Accelerometer	When EU unit is m/s^2 : 10^{-5} or 10^{-6} (10^{-6} for ISO, 10^{-5} for Japanese JIS) When EU unit is other than m/s^2 : default value is 1 (can be changed by user)
Sound Level Meter	2×10^{-5}
Vibration Level Meter	10^{-5} or 10^{-6} (10^{-6} for ISO, 10^{-5} for Japanese JIS)
Miscellaneous AC	Default value is 1 (can be changed by user)
Miscellaneous DC	None

When “Miscellaneous AC” etc. is selected as sensor category, specify a suitable Reference Value of decibels if the display is to be in dB values.

Microphone Sensitivity Input

If “Microphone” has been selected as sensor category and “Microphone Sensitivity Level” as calibration method, take the preamplifier loss into consideration when entering the sensitivity value. Use the following equation to determine the sensitivity value to input.

$$\text{Sensitivity} = \text{microphone sensitivity} + \text{preamplifier loss}$$

Check the calibration chart supplied with the microphone to find the microphone sensitivity value.

Microphone sensitivity

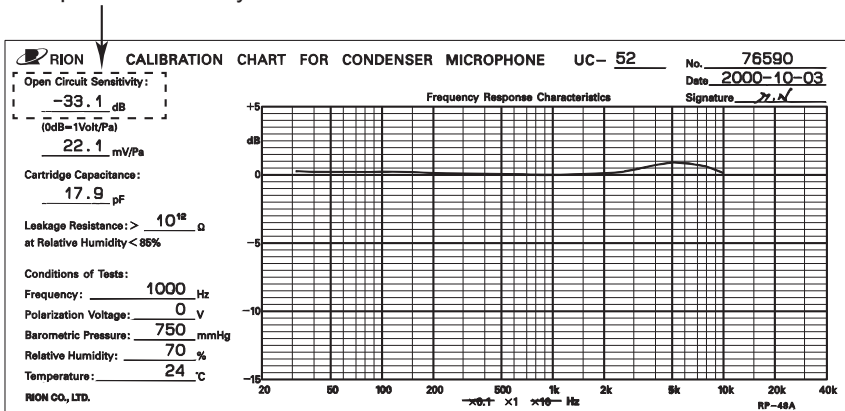

Calibration chart example

The “preamplifier loss” (due to the interaction of microphone capacitance and preamplifier capacitance) depends on the combination of microphone and preamplifier, as shown in the table below.

		Microphone				
		1 / 2 inch				1 / 4 inch
		UC-52	UC-53A	UC-57	UC-59	UC-54
Preamplifier	NH-22	-0.4	-0.6	-0.5	-0.5	-2.0*

* Using 1/4-inch to 1/2-inch conversion adapter UA-12

Unit: dB

For example, when the UC-53A (microphone sensitivity -28.5 dB) is used together with the NH-22, the following equation applies:

$$(-28.5) + (-0.6) = -29.1$$

Therefore “-29.1” should be used as sensitivity input value.

Calibration of DC Signals Including Offset

Calibrate DC output signals of sound level meters and vibration level meters and output signals of sensors and measuring devices that output DC voltages such as thermometers and anemometers as follows:

[Calibration of DC Output Signals of Sound Level Meters and Vibration level meters]

The DC output signals of sound level meters and vibration level meters have a fixed output voltage per decibel. Therefore, use it as the “sensitivity” (in V/dB). Then, obtain the “Offset Voltage” from the output level range upper of sound level meters and vibration level meters.

Obtain the offset voltage as follows:

The following figure shows the relationship between the DC OUT connector readings and output voltages of the NL-42 (appears in the instruction manual of the NL-42). This chart shows that, if the output level range upper of the NL-42 is “80 dB,” the output voltage is 0.5 V when the reading is 0 dB (“-80” on the horizontal axis in this chart). This is the offset voltage.

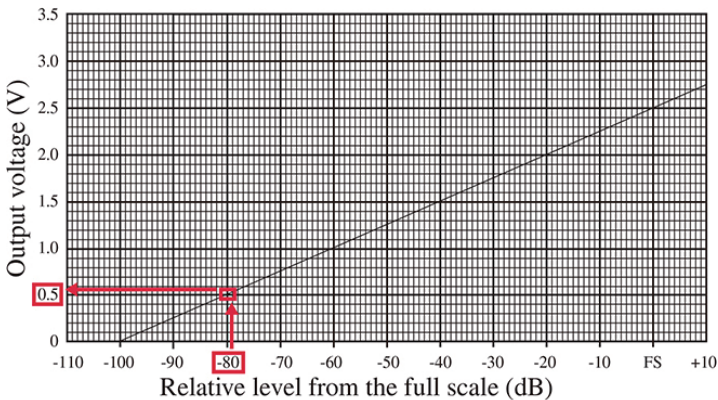

FS: Full-scale value

[Calibration of Output Signals of Sensors and Measuring Devices Such as Thermometers and Anemometers]

If the chart or documentation indicating relationship between the physical quantities and output voltage or the sensitivity and the offset voltage is supplied to the equipment, they can be calibrated in the same way as for the sound level meters and vibration meters.

Analysis of DC Signals

Normally, no frequency analysis (FFT analysis or octave analysis) is conducted on DC signals. This is because the DC signal is not regarded as a signal that switches periodically between positive and negative values centered around the certain reference value (normally 0 (zero)).

Unless the signal switches periodically, there is no necessity to conduct the frequency analysis which is focused on the periodicity of the signal.

However, the Fourier transformation theory can express even the DC signal as a signal with the infinite cycle, which superimpose the DC component with the frequency components that are integral multiples of the basic frequency. In this case, the frequency analysis results of DC signal change must be interpreted separately.

Specifications

RIONOTE specifications

Applied Laws, Regulations and Standards

Radio Certificate (Japan, U.S.A, China*)

*Only 2.4 GHz band is used for the unit in China

CE marking, WEEE Directive, Battery Directive

Chinese RoHS (only the products exported to China)

Input/Output

USB A Connector x 1

USB 2.0

USB Mini B Connector x 1

Mass storage class

GPIO Connector x 1 (for expanded use)

Dock Connector Dedicated for SA-A1B2/B4 Connection x 1

LAN port x 1

100BASE-TX

Monitor Output Port x 1 (Type 3.5 mm dia. Stereo Mini Jack)

Voice Memo Input Port x 1 (Type 3.5 mm dia. Mini Jack)

SD Memory Card Slot x 1

Battery Port (For BP-30) x 1

DC Jack x 1

Operation Area

Projected Capacitive Touch Panel

Up to two points can be detected.

Function Button x 1

Any one of the following functions can be selected.

(Note that the function depends on the program running on RIONOTE.)

- Measure Start/Stop
- Pause/Unpause
- Screenshot

Power Key

While power is off, press and hold the key to power on.

While power is on, press and hold the key and then operate the touch panel to shut down.

While power is on, press the key short to turn off LCD (except during measurement).

Press and hold the key for more than 10 seconds to force power-off.

Touch Panel Lock Switch

Disable the touch panel operations.

The function button and the power key are available.

Display

LCD 10.1-inch transmissive TFT color LCD (1280 x 800 pixels)

LED (Battery Status Display)

Charging energization status display (De-energized: None, Energized: Lights in blue)

Charging status display (Not charged: None, Charging: Lights in green, Standby: Lights in orange)

LED (LAN Status Display)

Link activity status display (No link: None, Link: Lights in yellow, In communication: blinks in yellow)

Communication speed status display (10BASE-T or no link: None, 100BASE-TX: Lights in green)

Language

Japanese/English/Korean

Status Bar Display

Amplifier status

RIONOTE power status

SD memory card available space

Time

Calibration Reading can be changed for the following sensors.

- Microphone
- Piezoelectric Accelerometer
- Sound Level Meter
- Vibration meter
- Miscellaneous AC
- Miscellaneous DC
- Tacho sensor
- (Available only for the tacho pulse/extra DC input port)
- Extra DC input (10 Hz sample)
- (Available only for the tacho pulse/extra DC input port)

Recording Area

Storage Media

SD memory card (operation guarantee is limited to those specified by RION Co., Ltd.)

Maximum capacity 32 GB (SDHC)

File system

FAT 16/FAT 32

Power Supply

Power Supply

Lithium-ion rechargeable battery dedicated for RIONOTE (BP-30)

Dedicated AC adapter for RIONOTE (NE-20P)

External DC

11 to 20 V

Continuous Measurement Time (23°C)

Application	LCD brightness setting	CCLD	Amplifier	Estimated battery life
SX-A1WR	0%	ON	SA-A1B2	Approx. 4:20
SX-A1WR	0%	ON	SA-A1B4	Approx. 4:00
SX-A1WR	0%	OFF	SA-A1B4	Approx. 4:30
SX-A1RT	100%	ON	SA-A1B4	Approx. 2:45

BP-30 is considered new.

Charging Time

Approx. 7.5 hours (at an ambient temperature within the charging temperature range)

Pre-installed Program

Waveform Recording Program SX-A1WR

Instruction Manual Browsing Function

RIONOTE, SX-A1RT, SX-A1FT and SX-A1WR instruction manuals in HTML format can be referenced.

Update

The application or system can be updated using an update file downloaded from the web site.

Waterproof Performance

IP Code IP54

The following conditions are required to maintain the waterproof performance.

RIONOTE is equipped with any one of the followings.

Blind cover for RIONOTE

SA-A1B2

SA-A1B4

Followings must be observed in attaching SA-A1B2 or SA-A1B4.

The BNC jack is not exposed to water.

A rubber cover is attached to the Ext trigger input connector.

The right connector cover of RIONOTE is attached.

The left connector cover of RIONOTE is attached.

The DC jack cover of RIONOTE is attached.

The earphone jack and voice memo microphone jack are not exposed to water.

BP-30 is attached.

Rubber seals are not worn out.

Temperature Range

Ambient conditions for use

Using BP-30 (lithium-ion rechargeable battery) only
-10°C to +40°C, 90%RH or less (No condensation)

Connecting NE-20P (AC adapter)
-10°C to +50°C, 90%RH or less (No condensation)

Charging Temperature Range

+5°C to +35°C

RIONOTE should be powered off.

Ambient conditions for storage

Same as the operating temperature/humidity range

Others Screw holes for fixing 2 (M4 screw depth: 8 mm)

Dimensions Approx. 30 mm (H) x 275 mm (W) x 188 mm (D)
(without SA-A1B2/SA-A1B4)

Approx. 40 mm (H) x 275 mm (W) x 188 mm (D)
(with SA-A1B2/SA-A1B4)

Weight Approx. 1120 g

(including the battery weighing 280 g, without SA-A1B2/
SA-A1B4)

Approx. 1200 g

(including the battery weighing 280 g, with SA-A1B2/SA-
A1B4)

Supplied accessories

AC adapter NE-20P 1

Lithium-ion rechargeable battery BP-30 1

Blind cover 1

CD-ROM 1

(SA-A1 File Converter, AS-70 Viewer, Readme, RIONOTE
Instruction Manual, SX-A1RT Instruction Manual, SX-A1FT
Instruction Manual, SA-A1WD Instruction Manual, RION-
OTE Online Help, SX-A1WR Online Help, SX-A1RT Online
Help, SX-A1FT Online Help)

Please Read This First	1
RIONOTE Precautions	1
SA-A1B2/B4 Precautions	1
Inspection certificate	1

Optional accessories

Lithium-ion rechargeable battery	BP-30
Shoulder strap	VA-12-015
AC adapter	NE-20P
Memory card (SD)	2 GBytes 32 GBytes
Voice memo microphone	iBUFFALO BSHSM03BK
Monitor earphone	Audio-Technica ATH-C320
BNC-BNC coaxial cable	EC-90 series
Preamplifier	NH-22
Charge converter	VP-40/VP-42
Microphone for measurement	UC series: Electret type only
Accelerometer	PV series
BNC-mini plug cable	CC-24/CC-24S
CCLD 4 mA modification (factory option)	
LCD protection sheet for RIONOTE	
Desktop stand for RIONOTE	

SA-A1B2/SA-A1B4 specifications

Applied Laws, Regulations and Standards

- CE marking
- WEEE Directive
- Chinese RoHS (only the products exported to China)

General input

Connector type

BNC × number of channels

Number of channels

SA-A1B2 2 channels

SA-A1B4 4 channels

Maximum input voltage

±13 V

Input impedance

approx. 300 kΩ

Input coupling

AC/DC (primary, $f_c=0.05$ Hz)

CCLD (Constant Current Line Drive)

2 mA, 24 V (change to 4 mA available as factory option)

on/off settings for each channel

Amplifier section

Input range

-40 dB to +20 dB in 20 dB steps

0 dB ref. $V_{rms}=1$ V

Frequency range

DC to 20 kHz or 0.25 Hz to 20 kHz (when the unit is set to AC coupling)

Inherent noise

Max. -85 dB of range full-scale (0 dB range, AP level, AC coupling)

Dynamic range

Min. 100 dB (0 dB range, $f_s=51.2$ kHz, noise level of 400 lines FFT)

Crosstalk

Max. -100 dB (0 dB range, 1 kHz)

Overload threshold

Range full-scale +2 dB

Inter-channel phase lag

± 1 deg max. (1 Hz to 20 kHz, same input range)

in -40 dB range

± 1 deg max. (1 Hz to 6 kHz)

± 3 deg max. (6 kHz to 20 kHz)

A/D converter section

A/D converter

24-bit delta-sigma type converter, simultaneous sampling of all channels

Rotary pulse input connector (shared with low sample DC input)

Common

Connector type

BNC \times 1

Input impedance

Approx. 100 k Ω

Rotary pulse

Input voltage range

0 to 12 V, open collector supported

Internal pull-up 3.3 V (pull-up resistor 1 k Ω)

H-L threshold level

2.5 V

Counting method

Periodic counting

Measurable revolution speed range

5,000 pulse/sec

Low sample DC input

Input voltage range

0 to 12 V

A/D converter

10 bit successive comparison method

Sampling frequency

Approx. 10 Hz

External trigger input

Connector type

Type 2.5 mm dia. mono phone jack

Trigger

Maximum input voltage

5 V

Threshold

H: 2.4 V

L: 0.6 V

Others

Open collector supported

Internal pull-up 3.3 V (pull-up resistor 51 kΩ)

Others

I/O RIONOTE or WD connection connector × 1

USB miniB port (for expanded use) × 1

SD memory card slot × 1

Do not insert or eject the card when the RIONOTE is connected to the main unit.

SDHC/SD (up to 32 GB) FAT16, FAT32

(Operation of SA-A1B2/B4 assured only with RION supplied SD memory cards)

Real time clock

Backed up by a secondary battery

Power consumption of SA-A1B2

When using SX-A1WR, using 2 channels and CCLD OFF mode:
approx. 1.1 W

When using SX-A1RT, using 2 channels and CCLD ON mode:
approx. 1.5 W

Power consumption of SA-A1B4

When using SX-A1WR, using 2 channels and CCLD OFF mode:
approx. 1.2 W

When using SX-A1RT, using 2 channels and CCLD ON mode:
approx. 2.0 W

Dimensions Approx. 23 mm (H) × 129 mm (W) × 84 mm (D)

Weight Approx. 120 g (SA-A1B2)

 Approx. 140 g (SA-A1B4)

Ambient conditions for use

-10°C to +50°C, 90% RH or less (no condensation)

Ambient conditions for storage

-10°C to +50°C, 90% RH or less (no condensation)

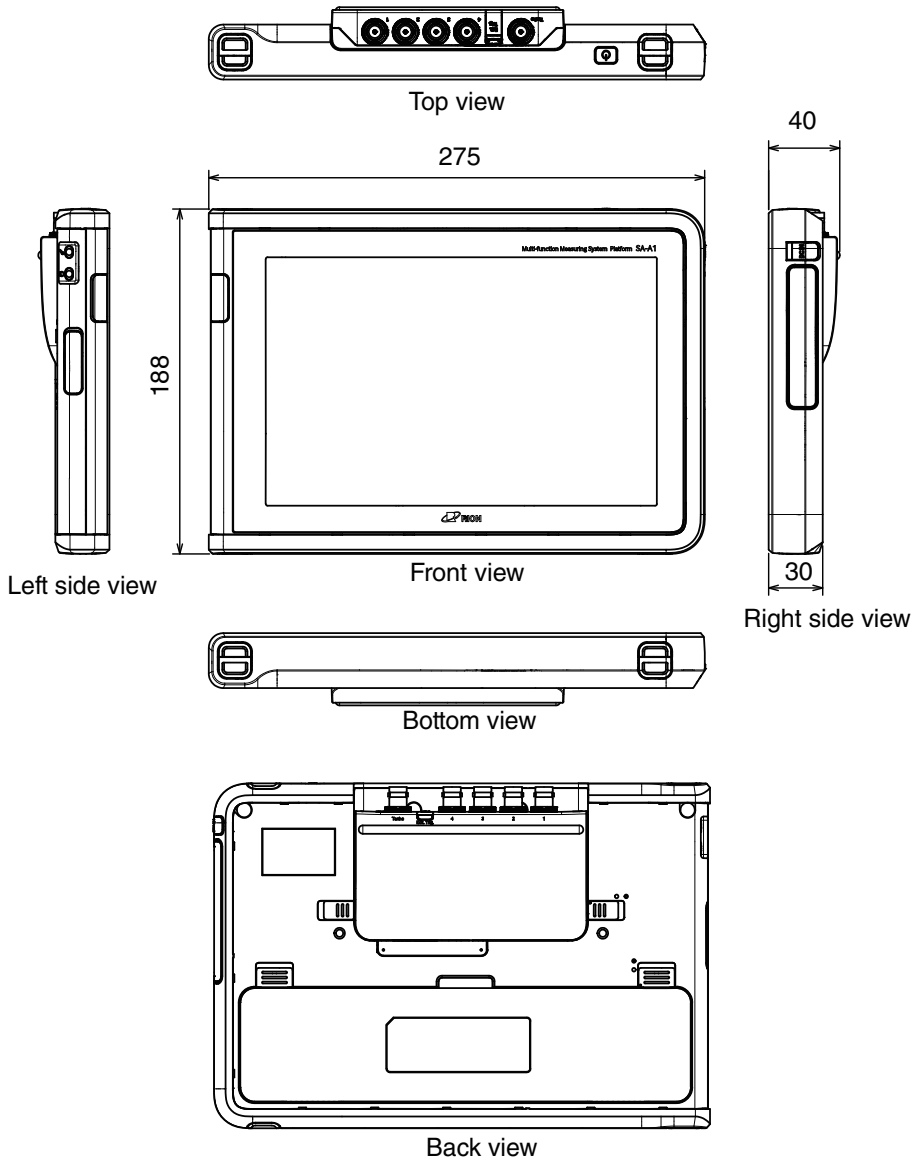

Unit: mm

Dimensional Drawings

Waveform Recording Program SX-A1WR

This section explains the operating and setup procedures of the Waveform Recording Program SX-A1WR.

Software Usage License Agreement

Important

In order to use this Software, you must agree to the terms of the Software Usage License Agreement (hereinafter “this Agreement”). Please read the following text carefully, and only proceed to use the Software if you agree to be bound by all the terms and conditions of this Agreement.

Article 1 Authorized Use

This Software (including updated or customized versions) is designed for use with the platform RIONOTE (hereinafter “the Product”). You are authorized to use the Software only in conjunction with the Product, in such a way as stipulated in this Agreement.

Article 2 Ownership of the Software

All rights to this Software are retained by RION Co., LTD, (hereinafter “RION”) and/or its rightful owners. This Agreement grants you only a limited right to use the Software. This Agreement does not grant you any other rights other than specified herein.

Article 3 Limitations to Use and Transfer

1. This Agreement does not grant you any rights to copy the Software and any associated documentation.
2. This Agreement does not grant you any rights to alter or modify the Software.
3. This Agreement does not grant you any rights to reverse engineer, decompile, recompile, or disassemble the Software.
4. Unless prior written permission from RION has been obtained, this Agreement does not grant you any rights to lend the Software to any third parties, regardless of whether this is done for payment or free of charge.
5. This Agreement does not grant you any rights to transfer the rights specified in this Agreement to any third parties.

Article 4 Warranty Scope

1. RION does not make any representation or promise that this Software will be able to perform without problems under any and all conditions. If a problem occurs while the Software is being used under normal conditions, contact RION using the information provided in the Instruction Manual. As far as possible based on the information provided by you about the problem, RION will provide guidance and information about possible errors, improved operation procedures and similar.
2. Rion (including any affiliated companies and subsidiaries) assumes no liability for any damages caused by alteration or loss of data stored in the Product which is attributable to a problem with the Software.
3. In no event does RION assume liability for any kind of direct or indirect damage, loss of profit or anticipated gain, or any other damage caused by the use of the Software, or the inability to use the Software.
4. In no event does RION assume liability for any problem caused by an alteration or modification of the Software by you. RION also does not assume liability for any damage caused to yourself by such an alteration or modification.

5. Liability of RION for any damages will not exceed the actual price that was paid for the license to use the Software. This limitation does not apply in the case of intentional faults or gross negligence.

Article 5 Remedy

1. RION guarantees that the Software as supplied contains the functions that are explicitly listed in the specifications.
2. If the software does not operate according to specifications, and the cause is the responsibility of RION, and if this is detected and RION is informed of this fact within 90 days from the purchase date of the Software, RION will undertake to remedy the problem free of charge.
3. In cases other than above, RION will undertake to remedy the problem against charge.

Article 6 Duration of this Agreement

1. You can terminate this Agreement at any time by stopping to use the Software and destroying the Software and all associated documentation.
2. If you violate any of the conditions of this Agreement, RION can cancel this Agreement and terminate the usage of the Software. In such a case, you are obligated to destroy the Software and all associated documentation (including any unauthorized copies).

Article 7 Other Items

If the Software and the Product are taken from Japan to any other country, the Japanese Foreign Exchange and Foreign Trade Law, the United States Export Administration Act, and all other applicable laws and regulations must be strictly observed. This Agreement shall be exclusively governed by the laws of Japan.

Article 8 Third Party Beneficiaries

This Software includes components for which the rights are held by other parties except RION. In the case of a violation of this Agreement, in addition to RION, such third parties shall also have the right to demand compensation for damages.

- * This Software comprises open source software components. For license information on open source software, refer to the Instruction Manual of the Product.
If there is any discrepancy between the conditions of this Agreement and the conditions of the open source software license, the open source software conditions shall take precedence.

SX-A1WR Overview

SX-A1WR is a waveform recording program that runs on the RIONOTE.

The recorded wave data is saved on an SD memory card connected to the RIONOTE or the amplifier unit docked with the SAA1WD. You can also record a voice memo and save a graph in an image format.

You can record frequency bands in six ranges of maximum of 20 kHz for data such as sound pressure, vibration, revolution speed, and temperature.

Screen Layout

Measurement Screen Layout



MEMO - The screen above is an example of the display with four graphs.

Status Bar

Displays the registered amplifier unit status, date and time, and battery status.

Operation Area

Provides measurement related buttons and information such as measurement start/stop button and measurement time display.

Time-Level Display Area

Provides a Time-Level display (for a maximum of 120 seconds) for the wave data currently input to the selected monitoring channel. By changing the channel, you can change the data to display.

MEMO - While measurement is performed by a system using wireless connection, there may be a case that the monitoring data cannot be received. In this case, a T-L graph may be displayed in gray. However, no data loss occurs in the SD memory card of the amplifier unit connected to the SA-A1WD.

Tacho Pulse/Extra DC Display Area

Displays the tacho pulse/extra DC input. You can select single or dual pane for the display, or hide it by changing the setting.

Bar Graph/Time-Level Display Area

Displays wave data currently being input. The number of graphs to display can be selected from one, two and four. You can also check the abnormal state during recording, such as OVERLOAD.

Amplifier Unit Settings Display Area

Displays the registered amplifier unit names, frequency range, frequency ratio and quantifying bit number.

Recall Screen Layout



Status Bar

Displays the selected project name, date and time, and battery status.

Operation Area

Provides the buttons and information for playing recall data and operating files.

Time-Level Display Area

Provides a Time-Level display (for a maximum of 120 seconds) for the wave data currently opened by the selected monitoring channel. By changing the channel, you can change the data to display.

Tacho Pulse/Extra DC Display Area

Displays the tacho pulse/extra DC input. You can change the settings to hide it.

Bar Graph Display Area

Displays wave data currently opened. The number of graphs to display can be selected from one, two and four.

Amplifier Unit Settings Display Area

Displays the registered amplifier unit names, frequency range, frequency ratio and quantifying bit number.

Project Select Screen Layout

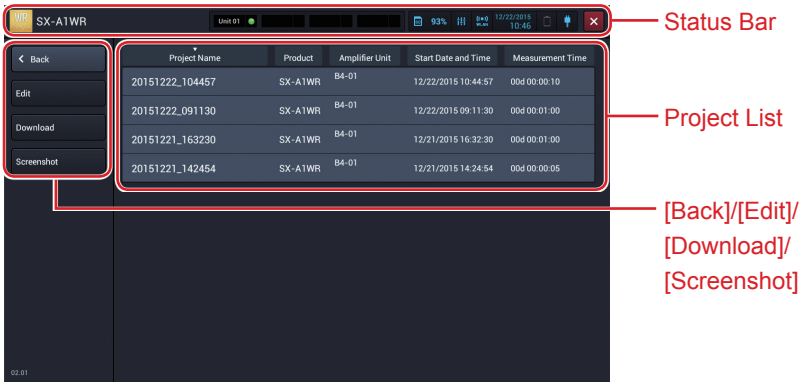

Status Bar

Displays the date and time and the battery status.

[Back]

Tap the button to return to the previous screen.

[Edit]

Tap the button to display the screen to change a project name or delete a project.

[Download]

Tap the button to download the projects saved in the wireless dock SA-A1WD amplifier unit. (See the instruction manual of SA-A1WD.)

[Screenshot]

Tap the button to list projects in which screenshots are saved.

Project List

Displays the list of saved projects.

Measurement Settings Screen Layout

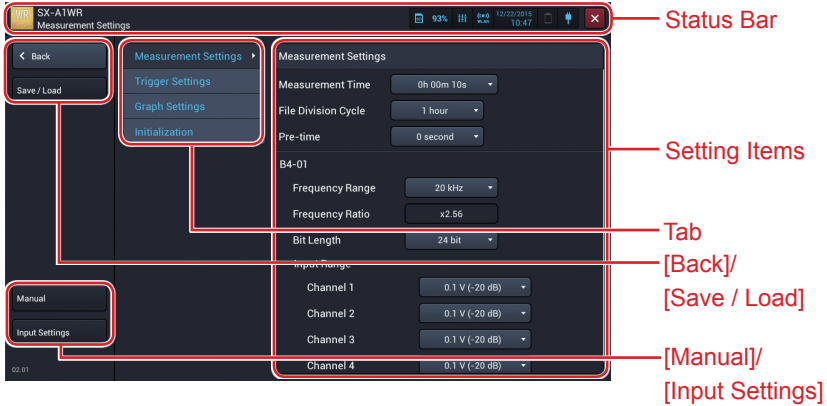

Status Bar

Displays the date and time and the battery status.

[Back]

Tap the button to return to the previous screen.

[Save / Load]

Tap the button to display the screen to save the settings. This button appears when you move from the Measurement screen to the Setting screen.

[Manual]

Tap the button to display HTML help.

[Input Settings]

Tap this to display the Input settings screen. This button appears when you move from the Measurement screen to the Setting screen.

Tab

The items settable on the Setting screen are displayed with tabs according to the purpose. You can tap to display items that can be configured on the tab.

Setting Items

Displays the setting items of the selected tab.

Starting/Exiting the SX-A1WR

Starting the SX-A1WR

1. Tap [SX-A1WR] on the HOME screen.

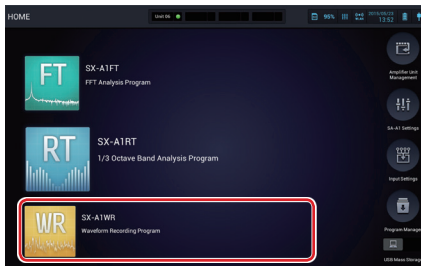

The SX-A1WR starts and the selection screen appears.

MEMO

- You may not see [SX-A1WR] displayed on the screen if multiple programs are installed. In this case, slide the programs up or down on the HOME screen to display [SX-A1WR].

2. Tap the desired screen tab.

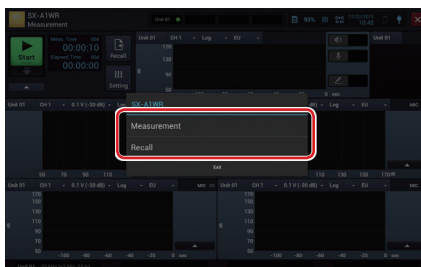

Tap [Measurement] to display the Measurement screen or [Recall] to display the Select project screen.

Exiting the SX-A1WR

1. Tap [X] on the right side of the status bar.



2. Tap [OK].

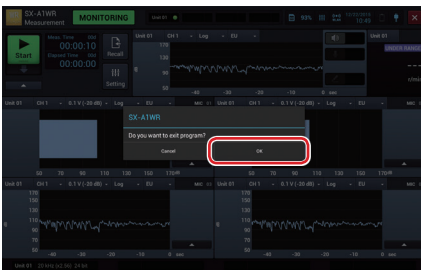

MEMO - You cannot exit the SX-A1WR during measurement.

Measuring Wave

Starting Measurement

1. Slide [Start] down.



Measurement is started and the data is saved on the SD memory card.

Important - Do not power off or pull out the SD memory card during measurement.

MEMO

- Depending on the Trigger Mode you selected, the operation after starting measurement becomes as follows.
 - Free: Starts measurement immediately. Measurement stops after the specified measurement time.
 - Single: Puts in a trigger standby state. Measurement starts when trigger conditions are met. Measurement stops after the specified measurement time.
 - Repeat: Puts in a trigger standby state. Measurement starts when trigger conditions are met. An operation goes back in a trigger standby state after a specified measurement time.
- When you start measurement, [Start] changes to [Stop].
- The screen displays [MEASUREMENT] during measurement, and [STANDBY] during a trigger standby period.
- You can change the graph size, channel to display or scale type during measurement. (The level range cannot be changed.)
- Measurement stops automatically when the available SD memory card space becomes small or the battery level becomes low.

Stopping Measurement

1. Slide [Stop] down.



MEMO

- Use this operation to stop measurement manually before the specified measurement time ends.
- When you stop measurement, [Stop] changes to [Start] and the screen displays [MONITORING].

Configuring the Measurement Time

Configure time to measure. You can configure measurement time between 1 second and 1000 hours.

1. Tap [Meas. Time].



2. Slide the measurement time to configure.

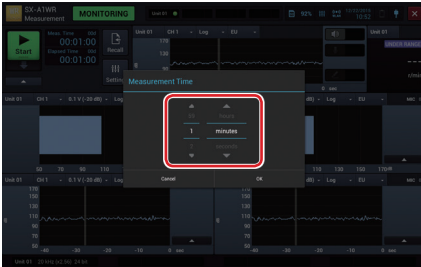

MEMO

- Select the unit from [seconds], [minutes], or [hours] and slide the measurement time to configure.
 [seconds]: Configure between 10 and 59.
 [minutes]: Configure between 1 and 59.
 [hours]: Configure between 0 01 and 10 00.
- If you select [hours], 24 hours are converted into 1 day and the measurement time displays it as "01d" and fractions as hours.
 <Example> If you set to 100 hours, the measurement time displays as "04d" and fractions as 4 hours.
- The measurement time can be configured on the Measurement settings screen as well.

3. Tap [OK].

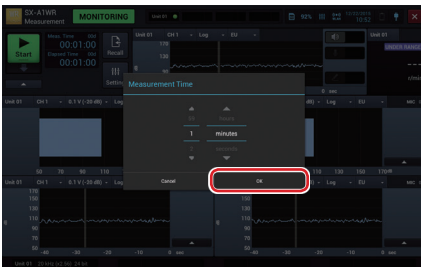

Changing the Amplifier Unit to Use

When multiple amplifier units are registered for measurement, the display can be changed on the Measurement screen.

1. Tap [Amplifier Unit Name].



2. Tap an amplifier unit name to display.



Capturing Screens during Monitoring and Measurement

You can save the entire screen during monitoring and measurement in a PNG format image file.

1. Tap [▲] under the slide bar of [Start/Stop] during monitoring and measurement.



2. Tap [Screenshot].



The screen is saved.

MEMO	<ul style="list-style-type: none">- A captured graph image file is highlighted for printing and saved.- A file of graph image captured during measurement is saved in the project folder.- A file of graph image captured other than during measurement is saved in the [Others] folder created in an SD memory card.- Image capturing with function button is also possible.- For capturing of individual graphs, refer to “Capturing the Graph” (P. 199).- The image files saved during measurement can be displayed on the RION-OTE (P. 188).
-------------	---

Inserting the Voice Memo

Voice memo is a function to record comments for measurement status, etc. during measurement. You can record a voice memo during measurement.

MEMO	<ul style="list-style-type: none">- You need a voice memo microphone to insert a voice memo. (P. 51)- You cannot use the voice memo microphone jack and earphone jack at the same time.
-------------	--

1. Slide  to the right during measurement.



It changes to , allowing the insert of a voice memo.

2. Speak what you want to record to the voice memo microphone.

3. To stop the insert, slide  to the left during the insert of the voice memo.



It changes to , stopping the insert of the voice memo.

MEMO

- Inserted voice memo is saved in the measured data project.
- This function is used to record a voice memo and not intended for measurement.

Playing the Voice Memo

The voice memo recorded during measurement can be played on the Recall screen.

MEMO

- Earphones are required to play a voice memo. (P. 51)
- You cannot use the microphone jack and earphone jack at the same time.

1. Open a project and display the Recall screen. (P. 183)
2. Tap the voice memo marker in the Time-Level display area.

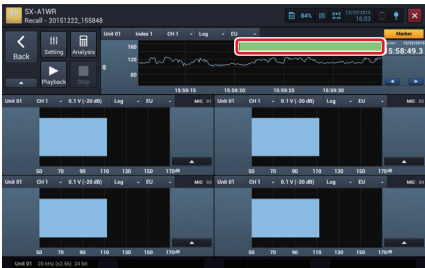

The cursor color changes to green and the voice memo playback is output from the earphone jack.

3. To stop the playback, tap the Stop button.



The voice memo playback is stopped.

Inserting the Marker during Measurement

Marker is a function to mark measured wave data. It is used to mark when you add notes during measurement.

1. Slide Marker icon to the right during measurement.



The marker is inserted in the measured data.

2. To end the insert, slide Marker icon to the left.



The insert of the marker is ended.

Inserting the Marker to Measured Wave Data

The marker can be inserted in the recall data in a project as well.

1. Open a project and display the Recall screen. (P. 183)
2. Tap [Marker].



3. Slide the marker to the position to which you want to insert the marker.



4. To change the marker starting point, tap the starting line of the marker.



The color of the marker starting line changes, enabling the move of the line.

5. Slide the starting line to the desired position.



MEMO - You cannot move the starting line after the ending line. If you move it after the ending line, the ending line moves too.

6. To change the marker ending point, tap the ending line of the marker.



The color of the marker ending line changes, enabling the move of the line.

7. Slide the ending line to the desired point.



MEMO - You cannot move the ending line before the starting line. If you move it before the starting line, the starting line moves too.

8. When you decide the marker position, tap [ENTER] below the marker.



The marker is inserted in the selected area.

9. Tap [Marker].



Deleting the Marker

- 1. Open a project and display the Recall screen. (P. 183)
- 2. Tap [Marker].



- 3. Tap [Delete] below the marker to delete.

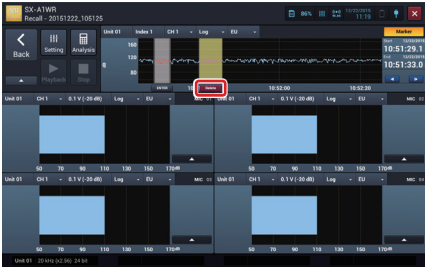

MEMO - You can delete an inserted marker during measurement.

Operating the Project

Project

Project is a folder to save data such as a measured record or voice memo. All data regarding measured records are saved in the same project.

The project name is saved as the starting date and time of recording measurement but can be changed to any name later.

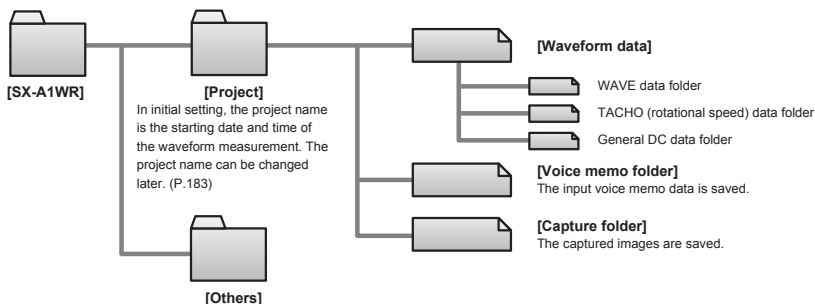

MEMO

- When a project has been transferred via an SD memory card to a computer, it can be transferred back and used again on the unit. Do this by saving the project directly into the "SD card\SX-A1WR" folder.

When a project created by the SA-A1WD is downloaded via wireless connection, the data measured under the following conditions cannot be loaded because the single file size is too large.

Measurement time	1 hour or more
Sampling frequency	20 kHz×2.56
Number of channels used	4 channels
Bit rate	24 bit
File division cycle	1 hour

In this case, change the file division cycle to ten minutes to avoid a decrease in the measurement quality.

Or connect to a computer using a USB cable and move the data, or remove the SD memory card and load the data with the RIONOTE.

Opening the Project

1. Tap [Recall] on the Measurement screen.



2. Tap the name of the project you want to open.

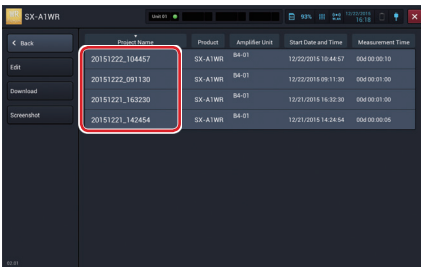

The Recall screen appears and displays wave data of the selected project .

While loading data, the indication within the red frame shown below is displayed.

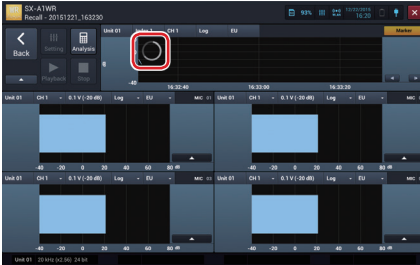

MEMO - If the recall data is large, it may take time to be ready for playing a waveform on the Recall screen.

Changing the Project Name

1. Tap [Recall] on the Measurement screen.
2. Tap [Edit].

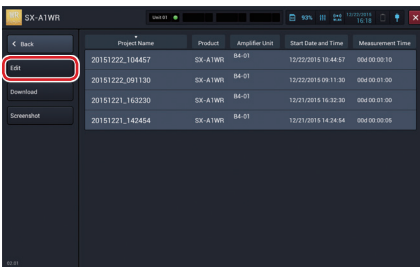

3. Tap the project of which you want to edit the name and tap [Project Rename].

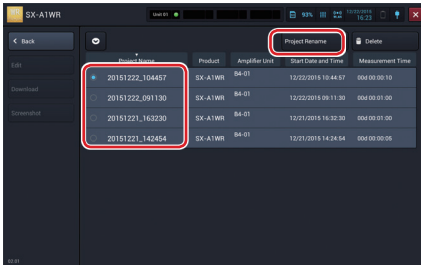

4. Enter the name and tap [OK].

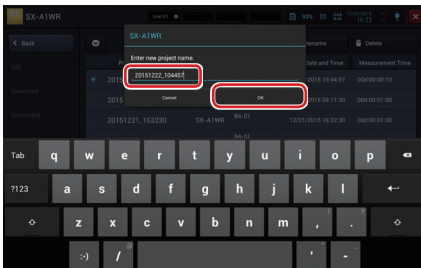

MEMO

- You can use alphabetical and numeric characters and underscore for a project name.

5. Tap [Back].

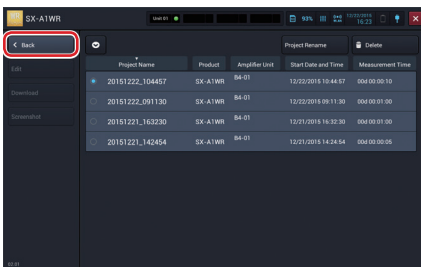

Deleting the Project

1. Tap [Recall] on the Measurement screen.
2. Tap [Edit].

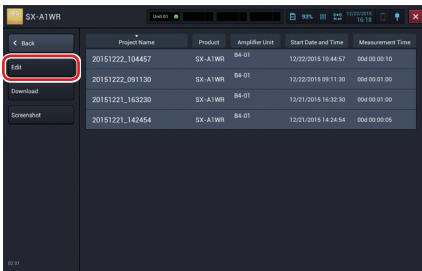

3. Tap the project to delete and tap [Delete].

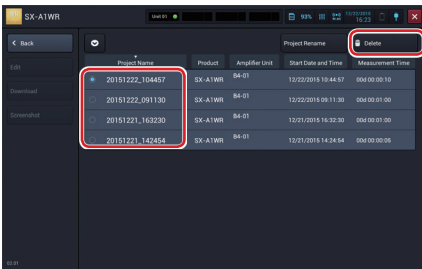

MEMO

- You can select multiple projects.
- When the project is selected, [●] appears to the left of the project.
- Tap the selected project again to cancel the selection.
- Tap [☑] to select all projects. Tap it again to cancel all the selections.

4. Tap [OK].

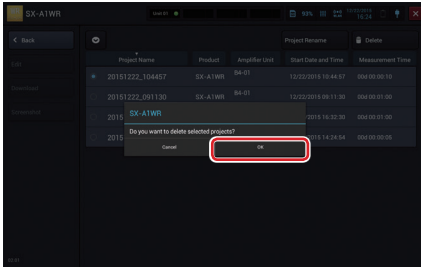

Important

- If you delete the project, you cannot restore data. Check if data is unnecessary before deleting.

5. Tap [Back].

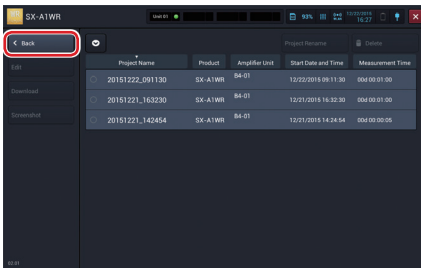

Displaying Captured Screen Data

You can display screens captured in the Measuring screen, Recall screen, Waveform analysis screen from the Recall screen by calling from inside of the project.

1. Tap [Recall] on the Measurement screen.
2. Tap [Screenshot].

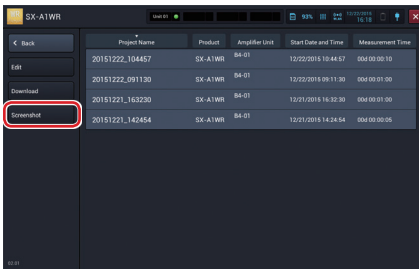

The project selection screen including the captured screen data is displayed.

3. Tap the project that includes the screen data you want to display.

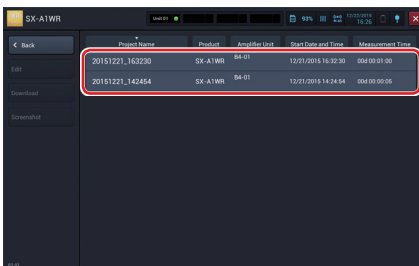

The screen data is displayed.

If multiple screen data exist, you can switch them by tapping the arrows beside the number of pages in the lower part.

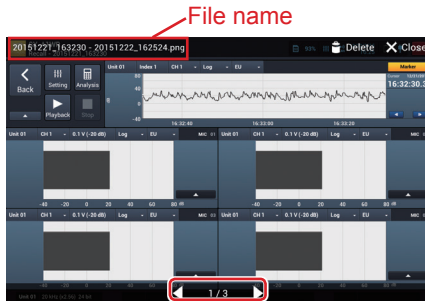

Tap [Delete] to delete the displayed screen data.



Tap [Close] to return to the project selection screen.



MEMO	<ul style="list-style-type: none"> - “File Name”, “Delete”, “Close”, and “Number of Pages” are hidden after a while. When you tap the screen, they are displayed again. - This function is intended to view screen data saved in the project, so you cannot view screen data saved in the [Others] folder.
-------------	--

Operating Recall Screen

Playing the Recall Data

1. Open a project and display the Recall screen. (P.183)
2. Tap [Playback].



The cursor in the Time-Level display area starts moving to play the wave data.

MEMO

- The playback signal is output from the earphone jack.
- Tap [Stop] to stop playback.
- Tap within the Time-Level display area while playback is stopped to cause the cursor to move to the tapping point.
- After moving the cursor, tap [Playback] to start playback from the moved cursor point.

Analyzing Recall Data

1. Open a project and display the Recall screen. (P.183)
2. Tap [Analysis].



The display is switched to the Waveform analysis screen of SX-A1FT. Tap [Back] on the Waveform analysis screen to return to the Recall screen of SX-A1WR.

MEMO - You cannot tap [Analysis] if SX-A1FT is not installed.

Capturing Recall Screen

You can save the Recall screen and Waveform analysis screen from the Recall screen in a PNG format image file.

1. Open a project and display the Recall screen (P. 183).
2. Tap [▲] under [Back] on the Recall screen and Waveform analysis screen that are displayed and played.



3. Tap [Screenshot].

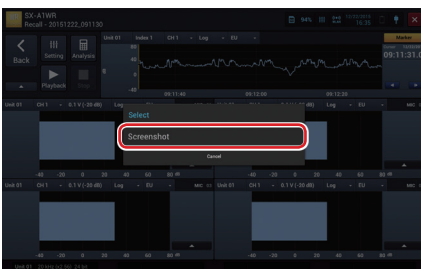

The screen is saved.

MEMO	<ul style="list-style-type: none">- A captured graph image file is highlighted for printing and saved.- A file of graph image captured during measurement is saved in the project folder.- Image capturing with function button is also possible.- The saved image files can be displayed on the RIONOTE (P. 188).
-------------	---

Checking the Recall Data Settings

1. Open a project and display the Recall screen. (P.183)
2. Tap [Setting].



The measurement settings of recall data are displayed.

Closing the Recall Screen

1. Tap [Back] on the Recall screen.



The Select project screen is displayed.

2. Tap [Back].

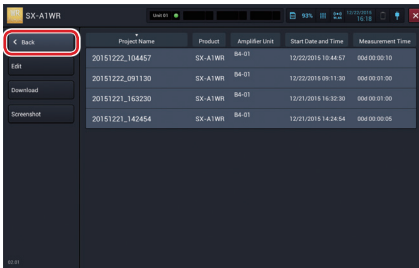

The Measurement screen is displayed.

Operating Graphs

Zooming in on the Time-Level Graph View

1. Pinch out on the graph on which you want to zoom in.



MEMO

- You cannot zoom in on the bar graph display.
- The zoomed in graph is returned to previous display by double-tapping a graph.

Zooming out of the Time-Level Graph View

1. Pinch in on the graph on which you want to zoom out.



MEMO

- You cannot zoom out on the bar graph display.
- The zoomed out graph is returned to previous display by double-tapping a graph.

Using the Single Graph View

When using the multiple graph display (two or four graphs), you can zoom in on the selected graph for the single graph view.

MEMO

- You can zoom in on a graph when using the multiple graph view. You cannot zoom in when using the single graph view.
- The number of graphs to display can be selected from [Graph Settings] in [Measurement Settings]. (P.218)

1. Tap [▲] on the graph on which you want to zoom in.



2. Tap [Single Graph View] on the graph.

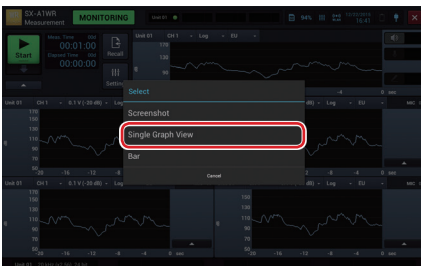

The selected graph is displayed all in the graph display area.

MEMO

- The graph view can also be switched by double-tapping a graph.

Returning the Graph to the Multiple View

You can return the graph view displayed all in the graph display area (single graph view) to the original multiple view.

MEMO - You can zoom out of a graph when using the multiple graph view. You cannot zoom out when using the single graph view.

1. Tap [▲] on the graph of which you want to zoom out.



2. Tap [View 2 Graphs] (or [View 4 Graphs]).

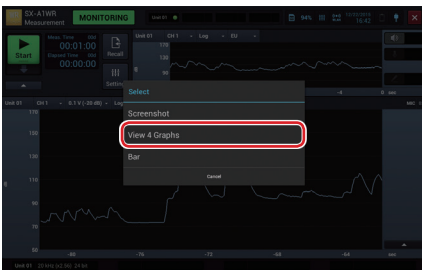

The graph is returned to the multiple view.

MEMO - The graph view can also be switched by double-tapping a graph.

Capturing the Graph

Graph capture is a function to save a graph currently displayed in a PNG format image file.

1. Tap [▲] on the graph you want to capture.



2. Tap [Screenshot].

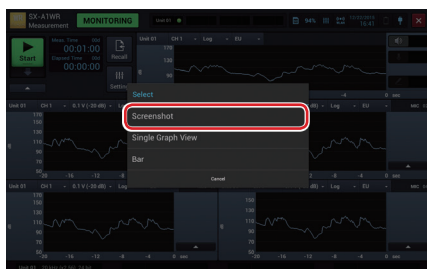

MEMO

- A captured graph image file is highlighted for printing and saved.
- A file of graph image captured during measurement is saved in the project folder.
- A file of graph image captured other than during measurement is saved in the [Others] folder created in an SD memory card.
- You can use the function button to capture all graphs currently displayed on the screen.
- The image files saved during measurement can be displayed on the RION-OTE (P. 188).

Changing Time-Level Graph into Bar Graph

1. Tap [▲] on the graph you want to capture.



2. Tap [Bar].

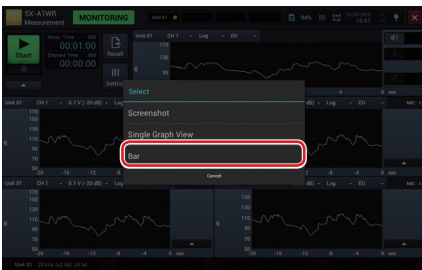

Changing Bar Graph into Time-Level Graph

1. Tap [▲] on the graph you want to capture.



2. Tap [Time-Level].

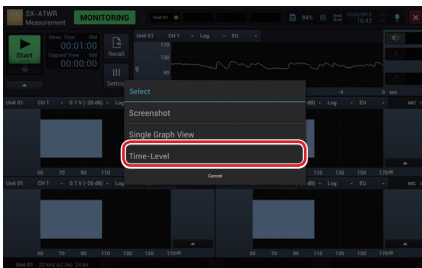

Changing the Display Contents on Graphs

The graph of the selected channel, input range, and scale is displayed. Changing the selection changes the graph view.

1. To change the channel, tap the channel number.



2. Tap the channel number to display.



3. To change the input range, tap the input range.



MEMO - Configure the setting so that OVERLOAD is not displayed when the input range is changed.

4. Tap the input range to display.



5. To change the X-axis on the graph, tap the scale name.



6. Tap the scale to display.



7. Tap the unit to change the unit of the X axis.



8. Tap the unit to display.



Settings

Configuring the Measurement Time

1. Tap [Setting] on the Measurement screen.
2. Tap [Measurement Range Settings] and tap [▼] on the right side of [Meas. Time].

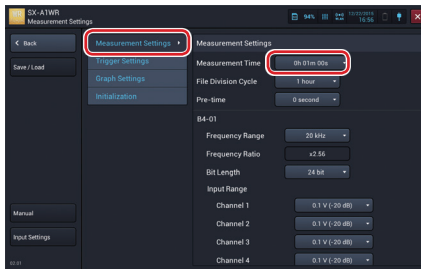

3. Slide the measurement time to configure and tap [OK].

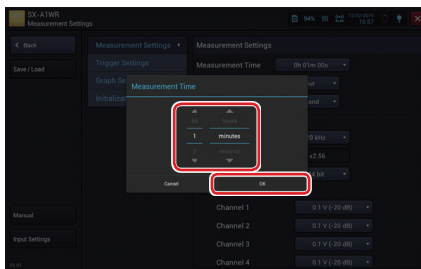

MEMO

- Select the unit from [seconds], [minutes], or [hours] and slide the measurement time to configure.
[seconds]: Configure between 10 and 59.
[minutes]: Configure between 1 and 59.
[hours]: Configure between 0 01 and 10 00.

Configuring the File Division Cycle

Select the size (duration) of a single file for measured data.

1. Tap [Setting] on the Measurement screen.
2. Tap [Measurement Settings] and tap [▼] on the right side of [File Division Cycle].

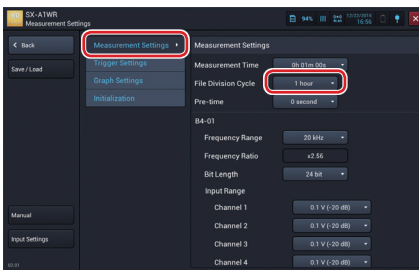

3. Tap the measured file division cycle to save.

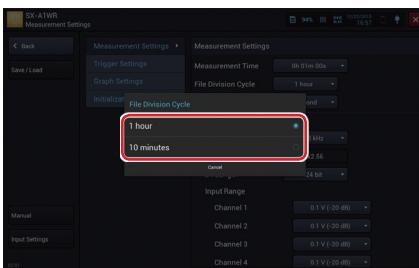

Configuring the Pre-time

Select the range (duration) to record past data for a certain period of time from the start of measurement. Pre-time is not displayed when [Time] is selected for [Trigger Source] in [Trigger Settings].

1. Tap [Setting] on the Measurement screen.
2. Tap [Measurement Settings] and tap [▼] on the right side of [Pre-time].

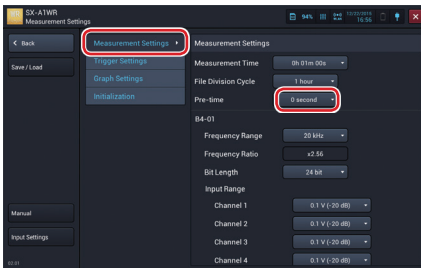

3. Tap the pre-time to configure (5 seconds, 1 seconds, or 0 second [no pre-time]).

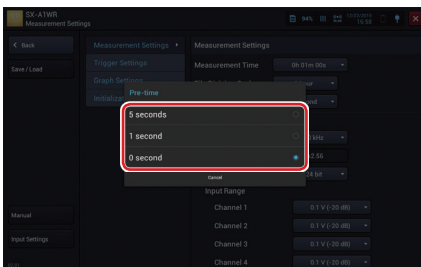

Configuring the Amplifier Unit Items

1. Tap [Setting] on the Measurement screen.
2. Tap [Measurement Range Settings] to configure each item for the amplifier unit.

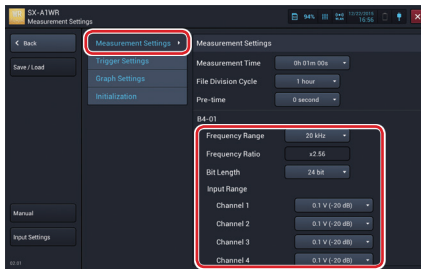

MEMO - For details on settings for each item, see "Manual" provided with the unit.

Configuring the Trigger

Configure the trigger conditions for starting measurement.

1. Tap [Setting] on the Measurement screen.
2. Tap [Trigger Settings] and tap [▼] on the right side of [Trigger Mode].

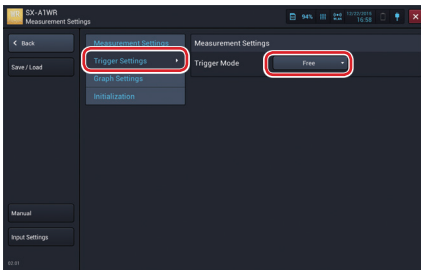

3. Tap the trigger mode to configure.

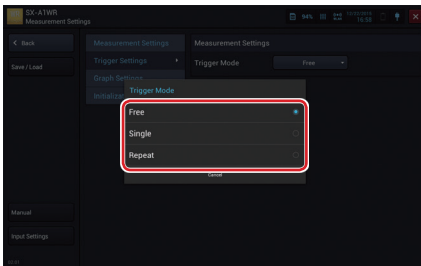

4. If you select [Single] or [Repeat], configure the trigger conditions.

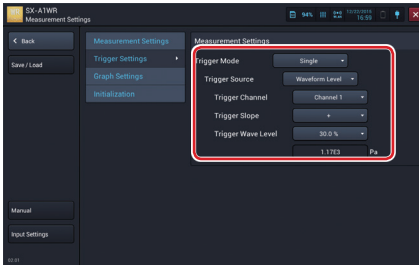
**MEMO**

- For details on settings for each item, see "Instruction Manual Application" provided with the unit.

Configuring the Number of Graphs to Display

1. Tap [Setting] on the Measurement screen.
2. Tap [Graph Settings] and tap [▼] on the right side of [Graphs].

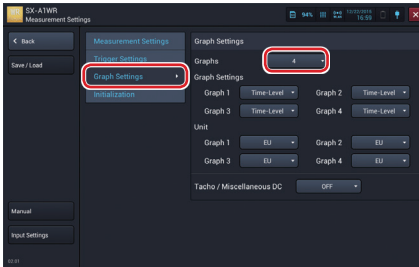

3. Tap the number of graphs to display.

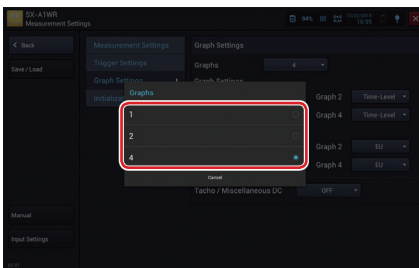

4. Tap [Graph Settings] and tap [▼] on the right side of each graph name.

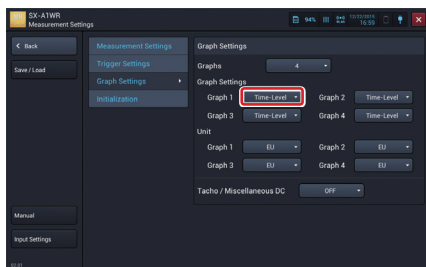

5. Select the type of the graph to display.

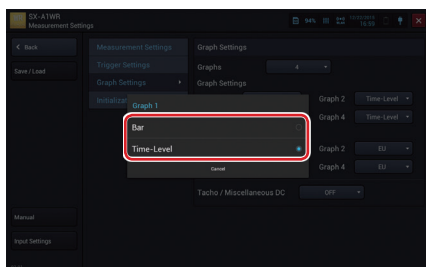

MEMO

- Configure as many graph types as the number of configured graphs.
- You can change the number of recall data graphs in the Settings Confirmation screen but cannot change the type.

6. Tap [Graph Settings] and tap [▼] on the right side of each unit.

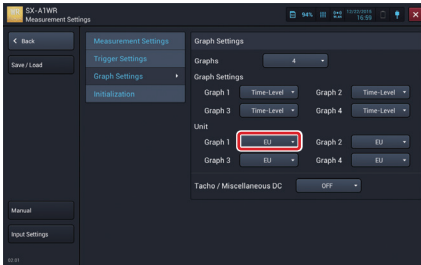

7. Select the type of the unit to display.

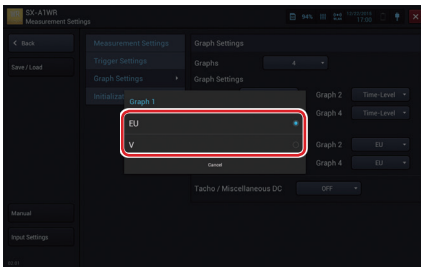

MEMO

- Configure as many units as the number of configured graphs.
- You can change the number of recall data graphs in the Settings Confirmation screen but cannot change the unit.

Configuring Tacho Display on the Graph

1. Tap [Setting] on the Measurement screen.
2. Tap [Graph Settings] and tap [▼] of [Tacho / Miscellaneous DC].

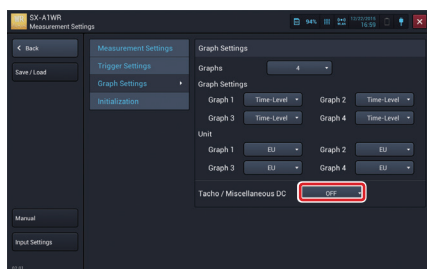

3. Select a value for Tacho/Miscellaneous DC. Tap [OFF] to hide.

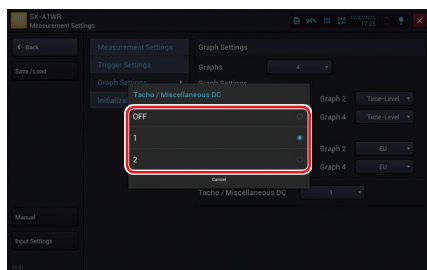

MEMO

- Up to two values can be displayed for Tacho/Miscellaneous DC depending on the number of registered amplifier units and settings.

Calibrating

1. Tap [Setting] on the Measurement screen.
2. Tap [Input Settings].

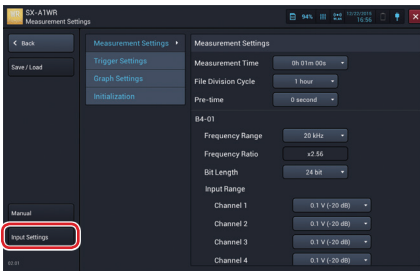

MEMO - For details on Input Settings, see "Configuring the Calibration" (P.79).

Initializing the Settings

1. Tap [Setting] on the Measurement screen.
2. Tap [Initialization] and then [Run].

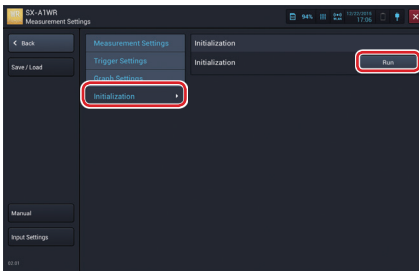

3. Tap [OK].

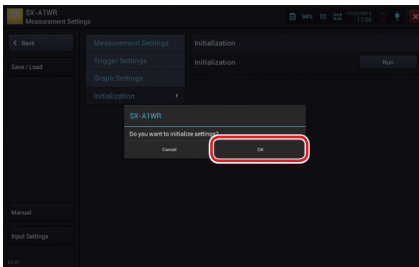

The default settings are as follows.

	Item	Default
Measurement Settings	Measurement Time	10 m
	File Division Cycle	1 hour
	Pre-time	0 seconds
	Frequency Range	20 kHz
	Frequency Ratio	× 2.56
	Bit Length	24 bit
	Input Voltage Range	10 V (20 dB)
Trigger Settings	Trigger Mode	Free
	Trigger Source	Waveform Level
	Trigger Channel	Channel1
	Trigger Slope	+
	Trigger Wave Level	30.0%
	Repeat Count	2
	Interval	1 hour
	Start Date and Time (Year/Month/Day)	Current date
	Start Date and Time (Hour:Minute)	Current time + 5 minutes
	Stop Date and Time (Year/Month/Day)	Current date + 1 day
	Stop Date and Time (Hour:Minute)	Current time + 5 minutes
Graph Settings	Graphs	2
	Graph Settings	Bar
	Unit	EU
	Tacho/Miscellaneous DC	OFF
Measurement Screen	Graph Display Type	Linear graph

Save the Current Settings

You can save settings configured in the Measurement settings screen. This allows you to load and restore the settings whenever you want. It is useful to save frequently-used settings. Up to five settings can be saved in the internal memory, and one setting can be saved as Startup File (P. 228) in the SD memory card.

MEMO

- The calibration information cannot be saved by saving settings. Save the calibration information on the Input settings screen. See “Saving Calibration Values” in the RIONOTE Instruction Manual.

1. Tap [Setting] on the Measurement screen.
2. Tap [Save / Load].

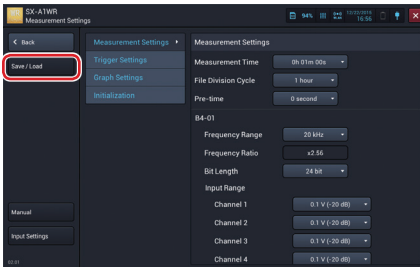

3. Tap [Save].

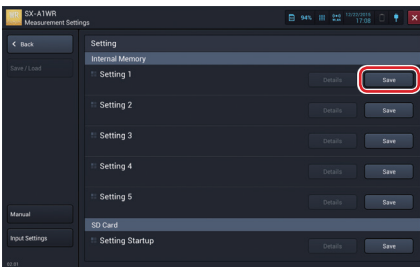

MEMO

- If you tap [Save] in a memo already saved, new settings overwrite the old settings.

4. Enter the name to save and tap [OK].

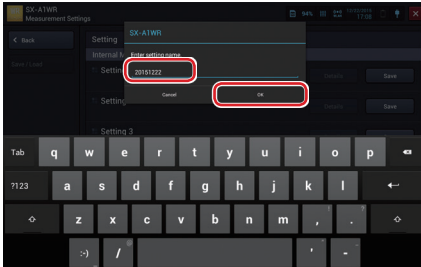

MEMO - You can use alphabetical and numeric characters and underscore for a setting name.

5. Tap [OK].

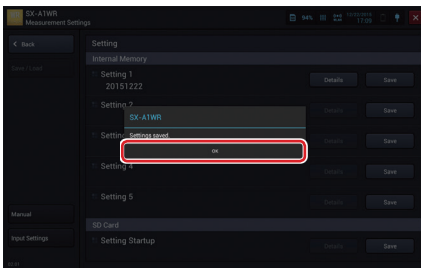

Confirming the Saved Settings

1. Tap [Setting] on the Measurement screen.
2. Tap [Save / Load].
3. Tap [Details] in the settings to check.

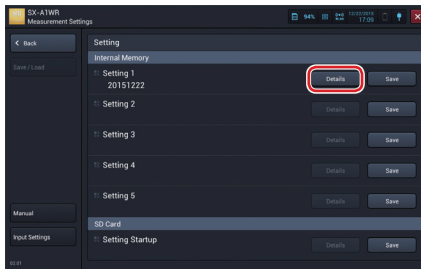

4. Check the settings and then tap [Close].

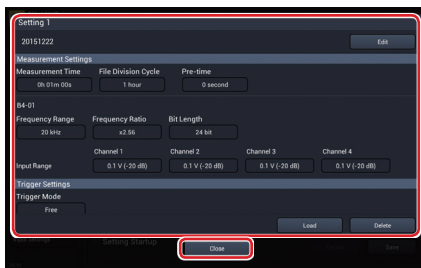

Load the Settings

1. Tap [Setting] on the Measurement screen.
2. Tap [Save / Load].
3. Tap [Details] in the settings to load.

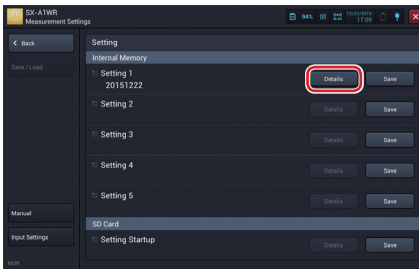

4. Tap [Load] in the settings to load.

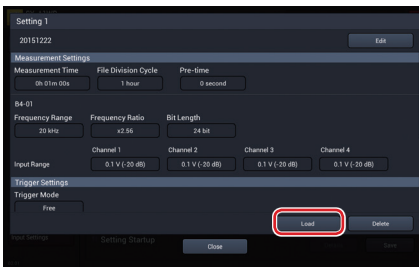

5. Tap [OK].

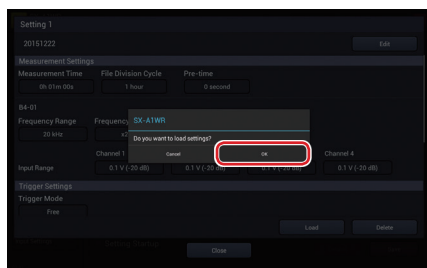

The settings are loaded.

6. Tap [OK].

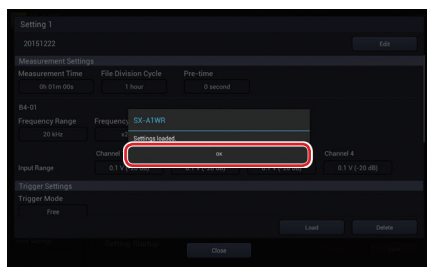

MEMO

- If you load the settings, the current settings will be deleted.

Editing Settings

You can change the name of saved settings.

1. Tap [Setting] on the Measurement screen.
2. Tap [Save / Load].
3. Tap [Details] in the settings to edit.

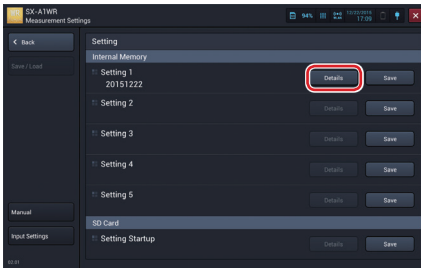

4. Tap [Edit] in the settings to edit.

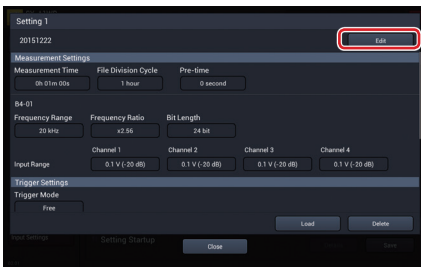

5. Enter a setting name and tap [OK].

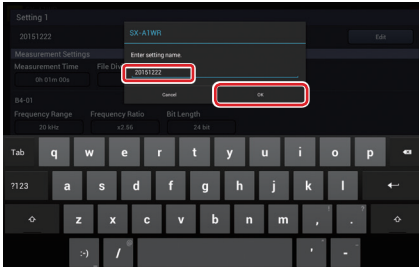

MEMO

- You can use alphabetical and numeric characters and underscore for a setting name.

6. Tap [OK].

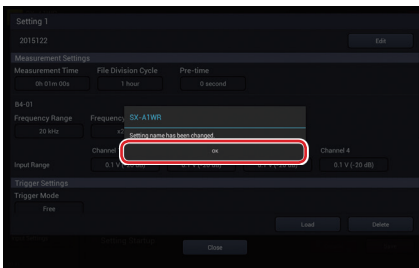

Delete the Settings

1. Tap [Setting] on the Measurement screen.
2. Tap [Save / Load].
3. Tap [Details] in the settings you want to delete.

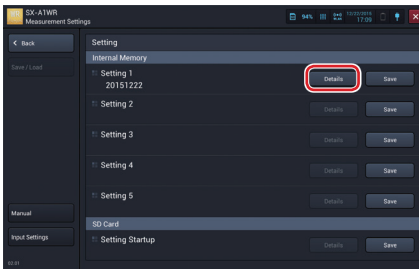

4. Tap [Delete] in the settings you want to delete.

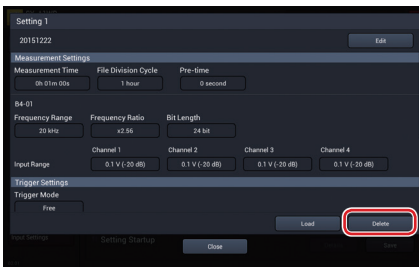

5. Tap [OK].

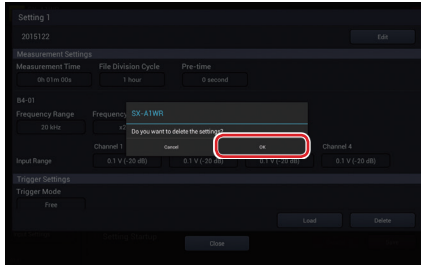

The settings are deleted.

6. Tap [OK].

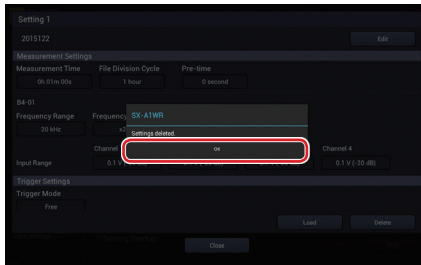

Setting Startup

If Startup File (setting startup file) is included in the SD memory card inserted into the RIONOTE, the following selection screen is displayed after “Measurement” is selected when SX-A1WR is started.

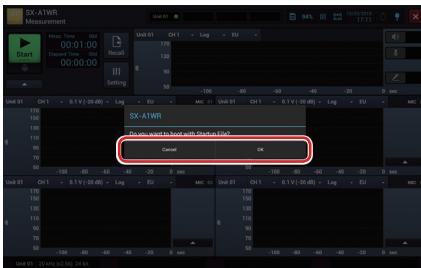

Tap [OK] on this screen to load the settings in Startup File.

Tap [Cancel] to start with the settings when SX-A1WR was shut down previously.

Saving Startup File, Etc.

The procedures to save and delete Startup File and to conduct other operations of Startup File are the same as those of the Setting file in the internal memory.

1. Tap [Setting] on the Measurement screen.
2. Tap [Save / Load].
3. Save or delete the setting startup file or conduct other operation.

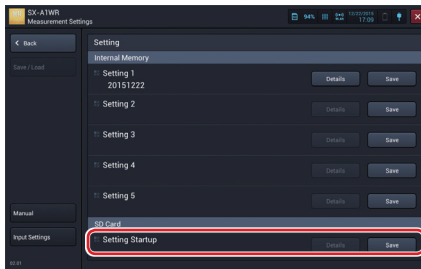

MEMO

- Startup File is saved in [SX-A1WR] - [SETTING] - [STARTUP] folder in the SD memory card.
- The settings can be taken over by loading the saved Startup File to other RIONOTE.

Important

- You cannot load the Startup File if you change the name of the file saved in the SD memory card or edit it improperly.

Items on Measurement Settings Screen

This section explains the setting items available on the Measurement Settings screen.

Measurement Settings

Configure the following items for each registered amplifier unit (ID is displayed).

Frequency Range

The value selected as the frequency range setting represents the highest effective frequency that can be included in the measured data.

Available settings are 20 kHz, 10 kHz, 5 kHz, 1 kHz, 500 Hz, and 100 Hz.

Frequency Ratio

This is fixed to 2.56. This value is commonly used by FFT analyzers.

Bit Length

Select the measurement data bit length. Increased accuracy of analysis and better sound quality can be obtained as the value increased, but the time which can be recorded becomes short.

Available settings are 16 bit and 24 bit.

Input Range

Specifies the input range for each channel. Choose a setting that is suitable for the magnitude of the input signal and the usage pattern of the unit.

Usually, the input range should be set as low as possible, without causing overload by excessive signals. However, in cases such as product inspections or periodic measurements, where products are to be compared or changes over time are to be monitored, the input range may have to be kept at the predetermined setting.

Available settings are 10V (20 dB), 1V (0 dB), 0.1V (-20 dB), and 0.01V (40 dB).

Trigger Settings

Trigger Mode

Specifies the basic operation pattern to perform when a trigger event occurs. If trigger operation is not required, select [Free].

Free

No trigger operation is performed. Measurement starts immediately when down-sliding [Start], and measurement stops when the data for the specified measurement time have been recorded.

Measurement also stops when down-sliding [Stop] or when the SD memory card has become full.

Single

Down-sliding [Start] sets the system to the trigger standby condition. When a trigger event occurs, measurement starts, and measurement stops when the data for the specified measurement time have been recorded.

Measurement also stops when down-sliding [Stop] or when the SD memory card has become full.

Repeat

Down-sliding [Start] sets the system to the trigger standby condition. When a trigger event occurs, measurement starts, and when the data for the specified measurement time have been recorded, the system again goes into the trigger standby condition. With this setting, the measurement will end when data for the selected number of repeats have been saved, or when the specified Stop Date and Time is reached.

Measurement also stops when down-sliding [Stop] or when the SD memory card has become full.

Trigger Source

Specifies the type of trigger signal to be used. If the trigger mode is set to [Free], this item is not displayed.

Waveform Level

The system will transit from the trigger standby condition to analysis start when the level of input signal in the specified channel (Trigger Channel) crosses the specified value (Trigger Wave Level).

Since the measurement start by a waveform level trigger may vary about the part of 1 or 2 samples, set up a pre-time if needed.

Time

When the trigger mode is set to Single, measurement for the specified time (Measurement Time) is performed when the specified start time (Start Date and Time) is reached.

When the trigger mode is set to Repeat, measurement for the specified time (Measurement Time) is repeatedly performed from the specified start time (Start Date and Time) to the specified stop time (Stop Date and Time), at the specified time interval (Interval).

External

The system will transit from the trigger standby condition to measurement start when the EXT trigger input connector is shorted.

MEMO

- When the measuring system consists of multiple connected systems, only Time is available as trigger source.

Trigger Channel

When the trigger source has been set to [Waveform Level], this item selects one channel of channels 1 to 4 (or channels 1 and 2) as the channel to be monitored for trigger. This is called the trigger channel.

Trigger Slope

When the trigger source has been set to [Waveform Level], this setting selects the direction of the signal in crossing the trigger level.

Available settings are + or -.

Trigger Wave Level

When the trigger source has been set to [Waveform Level], a trigger event occurs when the input signal's absolute value crosses the Trigger Wave Level setting. The setting is made as a percentage expressing the relative level of the signal versus the full scale value of the input range used for measurement. The setting range is -99.9 to 99.9.

Note that the input signal level required for a trigger event will change if the input range setting is changed.

Start Date and Time/Stop Date and Time

When the trigger source is set to Time and the trigger mode is set to Single, this setting specifies the start date and time of the measurement.

When the trigger source is set to Time and the trigger mode is set to Repeat, this setting specifies the start and stop date and time of the measurement. The setting can also span different years.

Interval

When the trigger source is set to Time and the trigger mode is set to Repeat, this setting specifies the measurement interval.

Available settings are 8 hours, 1 hours, 30 minutes, 15 minutes, 10 minutes, and 5 minutes.

MEMO - Set up the longer interval time than measurement time.

Repeat Count

When the trigger source has been set to [Waveform Level] or [External] and the trigger mode to [Repeat], this setting specifies the number of repeat operations.

The setting range is 2 to 1000.

WAVE File Format

This section provides details about the WAVE file format used by the SX-A1WR.

Basic Structure

The WAVE file is made up of variable-length blocks called “chunks”. The basic structure is as follows.

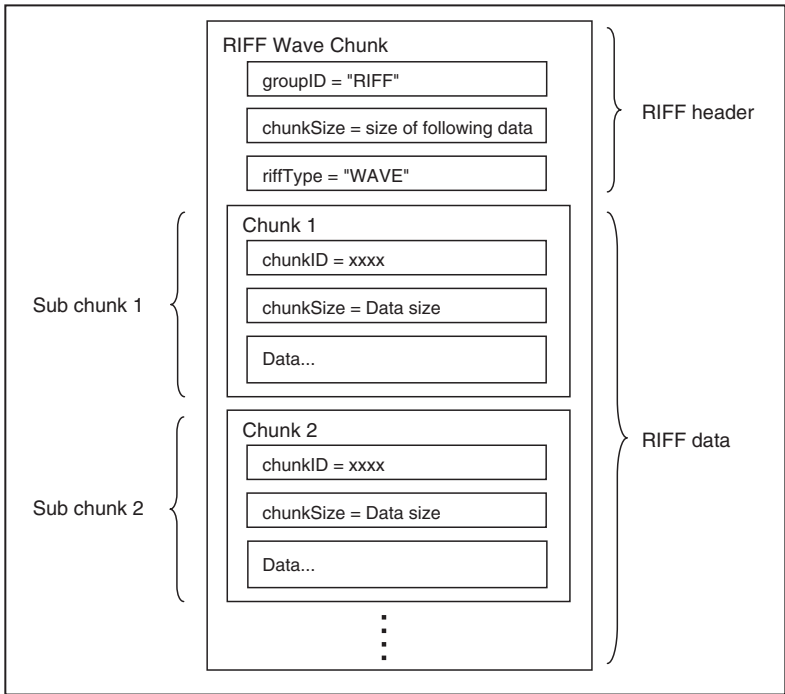

Basic WAVE file structure

The chunks and file structure used by the SX-A1WR are shown below.

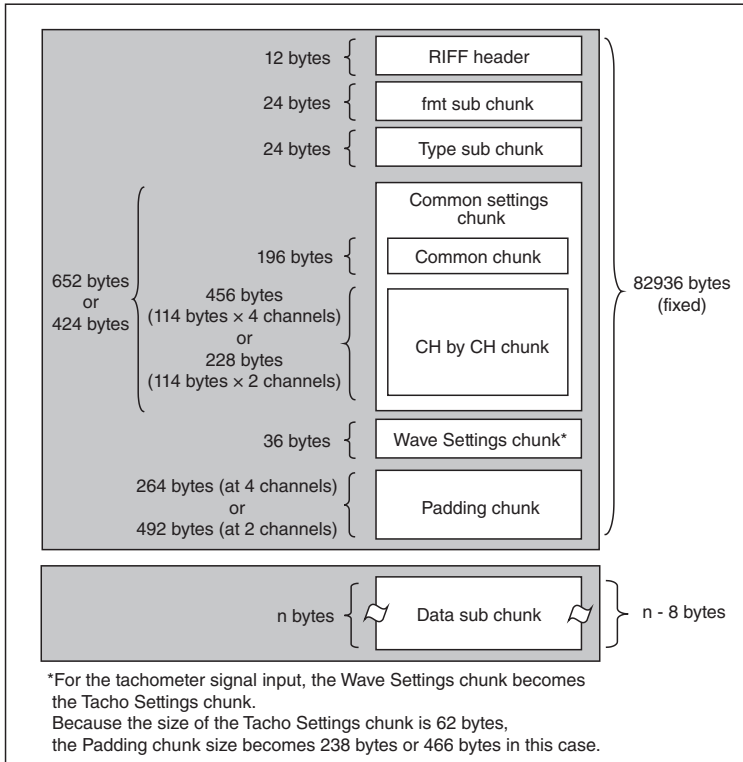

File structure and size

Invalid Values

For unused items, a value defined as an invalid value is inserted. The invalid values for the respective data types are shown in the table below.

Type	Invalid values
char	Blank
int16	Minimum value
uint16	Maximum value
int32	Minimum value
uint32	Maximum value
int64	Minimum value
uint64	Maximum value
float	Minimum value
double	Minimum value

Data Types

The SX-A1WR uses the following specially defined data types.

```
typedef struct {
    uint32    dwDataAddress;    /* < Address as counted from start of data chunk */
    uint32    dwDataSize;
    uint32    dwFatDateTime;
} MARKERFORMAT;
```

```
typedef struct {
    year    :6;                /* < Year (offset from 2000)          */
    mon     :4;                /* < Month (1 to 12)                  */
    day     :5;                /* < Day (1 to 31)                    */
    hour    :5;                /* < Hours (0 to 23)                  */
    min     :6;                /* < Minutes (0 to 59)                */
    sec     :6;                /* < Seconds (0 to 59)                */
} FATDATETIME;
```

dwFatDateTime

The date is a packed value with the following format.

Bits	Values	Meaning
0 to 5	0 to 59	Second
6 to 11	0 to 59	Minutes (0 to 59)
12 to 16	0 to 23	Hours (0 to 23, 24-hour format)
17 to 21	0 to 31	Day of the month (1 to 31)
22 to 25	1 to 12	Month (1 = January, 2 = February etc.)
26 to 31	0 to 63	Year offset from 2000 (add 2000 to get actual year)

Chunks

The following tables provide details about the structure of the RIFF header (RIFF chunk) and the various sub chunks listed in the section “File structure and size”.

RIFF chunk

Table 1 RIFF chunk

Type	Variable name	Size (Byte)	Description	Value
char[4]	Chunk ID	4	Indicates RIFF	"RIFF"
uint32	Chunk Size	4	Total size of following data (not including this item)	Depends on recording parameters
char[4]	riffType	4	Indicates RIFF type	"WAVE"

fmt sub chunk

Table 2 fmt sub chunk

Type	Variable name	Size (Byte)	Description	Value
char[4]	Chunk ID	4	Indicates chunk type	"fmt_"
uint32	Chunk Size	4	Total size of following data (not including this item)	16
uint16	wFormatTag	2	Format type	0x0001
uint16	nChannels	2	Number of channels	1 to 4
uint32	nSamplesPerSec	4	Number of samples per second	See Table 3
uint32	nAvgBytesPerSec	4	Number of bytes per second	See Fig. 1
uint16	nBlockAlign	2	Block size	See Fig. 2
uint16	wBitsPerSample	2	Number of bits per sample	16 / 24

Table 3 nSamplesPerSec

Range Rate	100 Hz	500 Hz	1 kHz	5 kHz	10 kHz	20 kHz
2.56	256	1280	2560	12800	25600	51200

$$nAvgBytesPerSec = nSamplesPerSec \times nChannels \times \frac{wBitsPerSample}{8}$$

Fig. 1 nAvgBytesPerSec

$$nBlockAlign = nChannels \times \frac{wBitsPerSample}{8}$$

Fig. 2 nBlockAlign**Type sub chunk****Table 4 Type sub chunk**

Type	Variable name	Size (Byte)	Description	Value
char[4]	Chunk ID	4	Indicates chunk type	"TYPE"
uint32	Chunk Size	4	Total size of following data (not including this item)	616
char[8]	File Type	8	File type	"WR_____"
uint16	File Revision	2	Chunk format version number	1 or more
Reserved		6		

CommonShareSetting (common) chunk

Stores setting information of the unit, including trigger settings etc.

Table 5 CommonShareSetting (common) chunk

Type	Variable name	Size (Byte)	Description	Value
char[4]	Chunk ID	4	Indicates chunk type	"CSET"
uint32	Chunk Size	4	Total size of following data (not including this item)	416 : SA-A1B2 644 : SA-A1B4
char[12]	Product Type	12	Product designation	"SX-A1WR____"
uint16	Repeat Serial Number	2	Repeat trigger sequential number	Top number is 1, <i>N</i> th number is <i>N</i>
uint16	File Serial Number	2	Split file sequential number	Top number is 1, <i>N</i> th number is <i>N</i>
int64	Start Time	8	File start time	UNIX time (msec)
int64	Actual Record Time	8	Actual record time from Start Time	Time accuracy is 10 ms. Refer to the Wave Data chunk for the exact number of samples.
int16	Unit Equipped Channels	2	Number of total channels	2 / 4
int16	Total Enabled Channels	2	Number of enabled channels	1 to 4
Reserved		2		
int16	Unit ID	2	Unit ID number	1 to 99
char[40]	Unit Name	40	Unit name	

Type	Variable name	Size (Byte)	Description	Value
char[8]	Unit Type	8	Unit type	B2 _____ / B4 _____
char[16]	Unit Serial Number	16	Serial number	
int32	Unit CPU Version	4	CPU version	AA.BB.XXYY (8 digits in hex number)
int32	Unit DSP Version	4	DSP version	AA.BB.XXYY (8 digits in hex number)
int32	Unit CPLD Version	4	CPLD version	AA.BB.XXYY (8 digits in hex number)
int32	Unit SubMicon Version	4	Sub-microcomputer version	AA.BB.XXYY (8 digits in hex number)
int16	Trigger Mode	2	Trigger mode	0: Free 1: Single 2: Repeat
int16	Trigger Source	2	Trigger source	4: External 16: Level 512: Time
int16	Trigger Channel	2	Trigger monitored channel	1 to 4
int32	Trigger Level Wave	4	Trigger level	Digit value in signed 16bit or 24bit is inputted by Int32 of MSB stuffing
Reserved		2		
Reserved		4		
int16	Trigger Slope	2	Trigger slope	0 : + 1 : -

Type	Variable name	Size (Byte)	Description	Value
int64	Trigger Start Date Time	8	Trigger start time	UNIX time
int64	Trigger Stop Date Time	8	Trigger stop time	UNIX time
int32	Trigger Interval	4	Trigger interval	Second time scale
int16	Measure Frequency Range	2	Frequency range	3: 100 Hz 5: 500 Hz 6: 1 kHz 8: 5 kHz 9: 10 kHz 10: 20 kHz
int16	Measure Frequency Ratio	2	Frequency ratio (Sampling frequency / Frequency range)	1: 2.56
int16	Tacho Codec Mode	2	Tacho meter codec mode	0: OFF 2: ON
Reserved		24		

CommonChSetting (each CH) chunk

Stores setting information of the unit, including each channel (for four channels or 2 channels) settings etc.

Table 6 CommonChSetting (each CH) chunk

Type	Variable name	Size (Byte)	Description	Value
char[40]	Chx Name	40	Channel name	
int16	Chx Number	2	Channel number	1 to 4
int16	Chx Enabled	2	Channel input enable	0: false 1: true
int16	ChxMeasure Enabled	2	Channel measurement enable	0: false 1: true
int16	Chx Sensor Type	2	Sensor type	2: Microphone 3: Piezoelectric Accelerometer 4: Sound Level Meter 6: Vibration Level Meter 20: Miscellaneous AC 21: Miscellaneous DC
int16	Chx Sensor Input Range	2	Input voltage range (V_{rms})	2: 0.01 V (-40 dB) 4: 0.1 V (-20 dB) 6: 1 V (0 dB) 8: 10 V (20 dB)
int16	Chx Coupling	2	Input coupling	0: AC 1: DC
int16	Chx CCLD	2	CCLD setting	0: false 1: true
int16	Chx Inversion	2	Input inversion	0: false 1: true

Type	Variable name	Size (Byte)	Description	Value
int16	Chx HPF Cutoff Frequency	2	High-pass digital filter cutoff frequency	0: OFF 4: 1 Hz 12: 10 Hz
Reserved		2		
char[8]	Chx Measurement Unit	8	Unit	V inputted EU unit dB m/s ²
double	Chx ValuePerBit	8	Calibration value (physical quantity per 1 bit)	Setting value on calibration
double	Chx ValuePerVolt	8	Calibration value (sensitivity)	Setting value on calibration
double	Chx Offset Value	8	Calibration value (offset value of physical quantity)	Setting value on calibration
double	Chx Zero dB Reference (EU)	8	Calibration value (notation of 0 dB reference index)	Setting value on calibration
uint16	Chx Overload	2	Overload information in the file	0: No overload has occurred 1: Overload has occurred at least once
Reserved		2		
Reserved		10		

Wave Settings chunk

Table 7 Wave Settings chunk

Type	Variable name	Size (Byte)	Description	Value
char[4]	Chunk ID	4	Indicates chunk type	"WSET"
uint32	Chunk Size	4	Total size of following data (not including this item)	28
Reserved		2		
int16	Pre-time	2	Pre-recording time	0 -1 -5
Reserved		24		

Padding chunk

Table 8 Padding chunk

Type	Variable name	Size (Byte)	Description	Value
char[4]	Chunk ID	4	Indicates chunk type	"padi"
uint32	Chunk Size	4	Total size of following data (not including this item)	Wave file: 260 Tacho file: 234
Reserved			Padding bytes to place the header on a 512 byte boundary	

Wave Data chunk

Recorded raw waveform data are stored here.

Table 9 Wave Data chunk

Type	Variable name	Size (Byte)	Description	Value
char[4]	Chunk ID	4	Indicates chunk type	"data"
uint32	Chunk Size	4	Total size of following data (not including this item)	See Fig. 3
WAVEData	Data	Depends on recording time	Store the recorded raw waveform data	

WAVEData follows the data conventions for regular WAVE files (16 bit/24 bit, little endian, 16 bit range full-scale value 15910, 24 bit range full-scale value 4072960).

$$nBlockAlign = nChannels \times \frac{wBitsPerSample}{8}$$

Fig. 3 Chunk Size

Approximate Recording Times

Approximate Recording Times

The approximate recording times available with an SD memory card inserted in the unit are as shown in the table below. The figures apply to a bit length setting of 16 bit. With the 24 bit setting, times are about one third shorter.

The maximum time for a single recording operation is 1,000 hours. When this limit is reached, recording is terminated automatically.

The available recording time differs depending on the type of SD memory card. Please note that these are approximate values provided for reference.

2 GByte SD memory card						
Number of channels	Frequency range					
	100 Hz	500 Hz	1 kHz	5 kHz	10 kHz	20 kHz
1	1066 h	213 h	106 h	21 h	10 h	5 h
	40 m	20 m	40 m	20 m	40 m	20 m
2	533 h	106 h	53 h	10 h	5 h	2 h
	20 m	40 m	20 m	40 m	20 m	40 m
3	355 h	71 h	35 h	7 h	3 h	1 h
	32 m	6 m	33 m	6 m	33 m	46 m
4	266 h	53 h	26 h	5 h	2 h	1 h
	40 m	20 m	40 m	20 m	40 m	20 m

Approximate Recording Times

16 GByte SD memory card						
Number of channels	Frequency range					
	100 Hz	500 Hz	1 kHz	5 kHz	10 kHz	20 kHz
1	8533 h 20 m	1706 h 40 m	853 h 20 m	170 h 40 m	85 h 20 m	42 h 40 m
2	4266 h 40 m	853 h 20 m	426 h 40 m	85 h 20 m	42 h 40 m	21 h 20 m
3	2844 h 16 m	568 h 48 m	284 h 24 m	56 h 48 m	28 h 24 m	14 h 12 m
4	2133 h 20 m	426 h 40 m	213 h 20 m	42 h 40 m	21 h 20 m	10 h 40 m

32 GByte SD memory card						
Number of channels	Frequency range					
	100 Hz	500 Hz	1 kHz	5 kHz	10 kHz	20 kHz
1	17066 h 40 m	3413 h 20 m	1706 h 40 m	341 h 20 m	170 h 40 m	85 h 20 m
2	8533 h 20 m	1706 h 40 m	853 h 20 m	170 h 40 m	85 h 20 m	42 h 40 m
3	5688 h 32 m	1137 h 36 m	568 h 48 m	113 h 36 m	56 h 48 m	28 h 24 m
4	4266 h 40 m	853 h 20 m	426 h 40 m	85 h 20 m	42 h 40 m	21 h 20 m

Specifications

Data Format WAVE

Frequency Range

20 kHz, 10 kHz, 5 kHz, 1 kHz, 500 Hz, 100 Hz

Frequency Ratio

(Ratio between Frequency Range and Sampling Frequency)

× 2.56

Quantization Bit Rate

24 bits, 16 bits

Measurement Time

Set arbitrarily from 10 to 59 seconds (at 1-sec interval),
1 to 59 minutes (at 1-min interval) and 1 to 1000 hours (at
1-hour interval).

File Division Cycle

10 minutes, 1 hour

Pre-time 0 second, 1 seconds, 5 seconds

Recording Function

Time-domain Waveform Recording

Save a time-domain waveform as a WAVE file.

Tacho Pulse Recording

Save the tacho pulse information when the tacho pulse is
enabled by the amplifier setting.

The pulse is measured by the counter of range 5,000
pulse/sec (300,000 r/min).

As a result, the revolving speed of 24 bit and 0.1 sec cy-
cle is obtained.

Extra DC Information Recording

Save the extra DC information when the extra DC is en-
abled by the amplifier setting.

Sampling frequency: approx. 10 Hz

Bit rate: 16 bits

Voice Memo Input

Save a voice memo recorded during measurement.

Sampling frequency: 12 kHz

Bit rate: 16 bits

Marker Input

Insert a marker to measured data.

Trigger Measurement

Waveform recording is performed when trigger conditions are met.

Trigger Measurement Settings

Trigger Mode: Free, Single, Repeat

Trigger Source: Waveform level, Time, External

Settings for Waveform Level Trigger

Trigger Slope: +, -

Trigger Wave Level: -99.9 to +99.9%

Repeat Count: 2 to 1000

Settings for Time Trigger

Start Time

Stop Time

Interval:

8 hours, 1 hour, 30 minutes, 15 minutes, 10 minutes,
5 minutes

Settings for External Trigger

Repeat Count: 2 to 1000

* Setting item for repeat trigger

Display

Graph Display

Display input data in a bar graph or Time-Level display form.

Up to four graphs are displayed simultaneously.

Overload Display

Display the Inst. Over indication when an excessive signal is input during monitoring or measurement.

Once an instantaneous overload occurs during measurement, the indication of excessive calculation value is displayed after Inst. Over lights up.

Underrange Display

Display the UNDERRANGE indication when a deficient signal is input during monitoring or measurement.

UNDERRANGE is displayed for the tacho data only.

Memo Marker and Voice Memo Display

Display a memo marker or voice memo recorded during measurement.

Memo Marker Input

Insert a memo marker to measured data.

Monitor Output Perform monitor output for the selected channel.

This function becomes available when the frequency range is set to 5 kHz, 10 kHz or 20 kHz.

This function is for monitoring and is not a re-analysis use.

Recall View saved projects or play a WAVE file.**Waveform Playback**

The WAVE file measured by SX-A1WR which is saved on an SD memory card is reproduced from the earphone jack.

This function becomes available when the frequency range is set to 5 kHz, 10 kHz or 20 kHz.

Voice Memo Playback

The voice memo recorded during measurement is reproduced from the earphone jack.

Marker Edit

Edit a marker inserted to measured data or add a new marker.

Function Button

Screen Capture

Capture the entire screen and save it as an image file.

Pause/Unpause

Pause/Unpause does not function on SX-A1WR.

Measure Start/Stop

Start measurement by pressing the function button during monitoring.

Stop measurement by pressing the function button again during measurement.

Initialization Initialize the settings.



<http://www.rion.co.jp/>