

Power Energy Logger Model PEL 102 & PEL 103

User Manual
ENGLISH



Measure up

www.aemc.com

 **AEMC**[®]
INSTRUMENTS
CHAUVIN ARNOUX GROUP

Copyright © Chauvin Arnoux®, Inc. d.b.a. AEMC® Instruments. All rights reserved.

No part of this documentation may be reproduced in any form or by any means (including electronic storage and retrieval or translation into any other language) without prior agreement and written consent from Chauvin Arnoux®, Inc., as governed by United States and International copyright laws.















Chauvin Arnoux®, Inc. d.b.a. AEMC® Instruments
15 Faraday Drive • Dover, NH 03820 USA
Tel: (800) 945-2362 or (603) 749-6434 • Fax: (603) 742-2346

This documentation is provided “as is,” without warranty of any kind, express, implied, or otherwise. Chauvin Arnoux®, Inc. has made every reasonable effort to ensure that this documentation is accurate; but does not warrant the accuracy or completeness of the text, graphics, or other information contained in this documentation. Chauvin Arnoux®, Inc. shall not be liable for any damages, special, indirect, incidental, or inconsequential; including (but not limited to) physical, emotional or monetary damages due to lost revenues or lost profits that may result from the use of this documentation, whether or not the user of the documentation has been advised of the possibility of such damages.

Chauvin Arnoux®, Inc, AEMC®, DataView®, AmpFlex®, MiniFlex® and PowerPad® are registered trademarks of AEMC® Instruments.

Thank you for purchasing a **Power Energy Logger Model PEL 102 or PEL 103**

For best results from your instrument and for your safety, read the enclosed operating instructions carefully and comply with the precautions for use. These products must be only used by qualified and trained users.

	WARNING, risk of DANGER! The operator must refer to these instructions whenever this danger symbol appears.		Ethernet socket (RJ45).
	CAUTION! Risk of electric shock. The voltage at the parts marked with this symbol may be dangerous.		Main power supply input.
	Equipment is protected by double insulation.		Ground/Earth.
	USB socket.		Useful information or hint to read.
	SD Card.		Magnetic fields can damage hard drives and medical devices.
	Important instructions to read and to fully understand.		
	Must not be applied to or removed from bare conductors carrying dangerous voltages. Type B current sensor as per EN 61010-2-032.		
	The product has been declared recyclable after analysis of its life cycle in accordance with the ISO14040 standard.		
	The CE marking guarantees conformity with European directives and with regulations covering EMC.		
	The trash can with a line through it means that in the European Union, the product must undergo selective disposal for the recycling of electric and electronic material, in compliance with Directive WEEE 2002/96/EC.		

Definition of Measurement Categories (CAT)

- **CAT IV** Measurement category IV corresponds to measurements taken at the source of low-voltage installations.
Example: power feeders, counters and protection devices.
- **CAT III** Measurement category III corresponds to measurements on building installations.
Example: distribution panel, circuit-breakers, machines or fixed industrial devices.
- **CAT II** Measurement category II corresponds to measurements taken on circuits directly connected to low-voltage installations.
Example: power supply to domestic electrical appliances and portable tools.

PRECAUTIONS FOR USE

This instrument complies with safety standard IEC 61010-2-030, the leads comply with IEC 61010-031 for voltages of 1000V in measurement category III or 600V in measurement category IV and the current sensors comply with IEC 61010-2-032. Failure to observe the safety instructions may result in electric shock, fire, explosion, and destruction of the instrument and of the installations.

- The operator and/or the responsible authority must carefully read and clearly understand the various precautions to be taken in use. Sound knowledge and a keen awareness of electrical hazards are essential when using this instrument.
- For your safety, use only the compatible leads and accessories delivered with the instrument, which comply with IEC standard 61010-031 (2002). When sensors or accessories having a lower voltage rating and/or category are connected to the instrument, the lower voltage and/or category applies to the system so constituted.
- Before each use, check that the leads, enclosures, and accessories are in perfect condition. Any lead, sensor or accessory on which the insulation is damaged (even partially) must be repaired or scrapped.
- Do not use the instrument on networks for which the voltage or category exceeds those mentioned.
- Do not use the instrument if it seems to be damaged, incomplete, or poorly closed.
- Use only the AC power adapter and battery pack supplied by the manufacturer, which include specific safety features.
- When removing and replacing the battery and/or the SD-Card, make sure that the device is disconnected and switched off.
- We recommend using Personal Protection Equipment where required.
- Keep your hands away from unused terminals.
- If the instrument is wet, dry it before connecting it.
- All troubleshooting and metrological checks must be performed by authorized (competent and accredited) personnel, with the instrument completely disconnected.

TABLE OF CONTENTS

1. INTRODUCTION	6
1.1 Receiving Your Shipment	6
1.2 Ordering Information	6
1.2.1 Accessories.....	7
1.2.2 Replacement Parts.....	7
2. PRODUCT FEATURES	8
2.1 Description	8
2.2 Front Panel Features	9
2.3 Back Panel Features	10
2.4 Lead Inputs	10
2.5 Installation of the Color-coded ID Markers	11
2.6 Connection Features.....	11
2.7 Mounting and Location	12
2.8 Button Functions.....	12
2.9 LCD Display (PEL 103).....	12
2.10 LED Status	13
2.11 Memory Capacity	15
3. OPERATION.....	16
3.1 Charging the Battery	16
3.2 Operating the PEL.....	16
3.3 Turning the Instrument ON/OFF	17
3.3.1 Turning the PEL ON	17
3.3.2 Turning the PEL OFF.....	17
3.4 Starting/Stopping a Recording and Enabling Bluetooth.....	18
3.5 Connections	18
3.5.1 Power Supply.....	18
3.5.2 Standby Mode (and Display Brightness).....	19
3.5.3 Memory Card (SD-Card)	19
3.5.4 USB Connection to the PEL	19
3.5.5 LAN Ethernet Connection to the PEL	19
3.5.6 Bluetooth Connection to the PEL	20
3.5.6.1 Pairing using Windows 7.....	20
3.6 Distribution Systems and PEL Hook-ups.....	22
3.6.1 Single Phase 2-Wire	22
3.6.2 Single Phase 3-Wire (Split Phase from a center tap transformer)	22
3.6.3 3-Phase 3-Wire Power Networks	23
3.6.3.1 3-Phase 3-Wire Δ (with 2 current sensors).....	23
3.6.3.2 3-Phase 3-Wire Δ (with 3 current sensors).....	23
3.6.3.3 3-Phase 3-Wire Open Δ (with 2 current sensors).....	24
3.6.3.4 3-Phase 3-Wire Open Δ (with 3 current sensors].....	24
3.6.3.5 3-Phase 3-Wire Y (with 2 current sensors)	25

3.6.3.6	3-Phase 3-Wire Y (with 3 current sensors]	25
3.6.3.7	3-Phase 3-Wire Δ Balanced (with 1 current sensor)	26
3.6.4	3-Phase 4-Wire Y Power Networks	26
3.6.4.1	3-Phase 4-Wire Y (with 3 current sensors)	26
3.6.4.2	3-Phase 4-Wire Y Balanced	27
3.6.4.3	3-Phase 4-Wire Y 2½ Element	27
3.6.5	3-Phase 4-Wire Δ	28
3.6.5.1	3-Phase 4-Wire Δ	28
3.6.5.2	3-Phase 4-Wire Open Δ	28
3.6.6	DC Power Networks	29
3.6.6.1	DC 2-Wire	29
3.6.6.2	DC 3-Wire	29
3.6.6.3	DC 4-Wire	30
3.7	LCD Display Modes (PEL 103 Only)	31
3.7.1	Base Measurements - Displayed Values	31
3.7.2	Energy - Displayed Values	34
3.7.3	Harmonic Display Values	37
3.7.4	Max Display Values	38
3.7.5	Information Display Values	39
3.7.6	Configuratio (PEL 103)	40

4. PEL CONTROL PANEL - DATAVIEW® SOFTWARE 42

4.1	Installing DataView	42
4.2	Connecting to a PEL	48
4.2.1	Add an Instrument Wizard	49
4.2.2	USB Connection	50
4.2.3	Ethernet Network Connection	52
4.2.4	Bluetooth Connection	53
4.3	PEL Control Panel	54
4.3.1	Opening and Using the Control Panel	54
4.3.2	Modifying a Connection Type	57
4.3.3	Reconnecting and Disconnecting an Instrument	57
4.3.4	Removing an Instrument from the PEL Network	57
4.4	Configuring the PEL	58
4.4.1	General Options	59
4.4.2	Communication Options	60
4.4.3	Measurement Tab Options	62
4.4.4	Current Sensors and Ratios	63
4.4.5	Recording Tab Options	65
4.4.6	Meters Tab Options	67
4.4.7	Configuring and Recording Data Example	68
4.4.8	Modifying an Instrument's Configuration	69
4.5	Downloading Recorded Data	69
4.6	Using the Download Folder	71
4.7	PEL Reports	72

4.7.1	Specifying the Default Report Template	72
4.8	Power & Energy Logger (PEL) Android App	72

5. SPECIFICATIONS 74

5.1	Reference Conditions	74
5.2	Electrical Specifications	74
5.2.1	Voltage Inputs	74
5.2.2	Current Inputs	74
5.2.3	Accuracy Specifications (excluding current sensors)	75
5.2.3.1	Specifications at 50/60Hz	75
5.2.3.2	Specifications @ 400Hz	77
5.2.3.3	Specifications @ DC.....	77
5.2.3.4	Temperature	78
5.2.3.5	Common Mode Rejection.....	78
5.2.3.6	Magnetic Field Influence.....	78
5.2.4	Current Sensors	78
5.2.4.1	Precautions for Use	78
5.2.4.2	Use and Characteristics.....	78
5.2.4.3	MiniFlex® MA193.....	79
5.2.4.4	Other Current Sensors	79
5.2.4.5	Accuracy	81
5.3	Bluetooth.....	83
5.4	Power Supply	83
5.5	Mechanical Specifications	84
5.6	Environmental Specifications.....	84
5.7	Safety Specifications.....	84
5.8	Electromagnetic Compatibility	84

6. MAINTENANCE 85

6.1	Battery	85
6.2	Battery Indicator.....	85
6.3	Cleaning	85
6.4	Updating the Internal Software	86

APPENDIX A..... 87

A.1	Measurements	87
A.1.1	Definition.....	87
A.1.2	Sampling.....	87
A.1.2.1	Sampling Period	87
A.1.2.2	Locking of Sampling Frequency	88
A.1.2.3	AC/DC.....	88
A.1.2.4	Measurement of Neutral Current	88
A.1.2.5	“1 second” Quantities.....	88
A.1.2.6	Aggregation	88
A.1.2.7	Max.....	88
A.1.2.8	Energy Calculations.....	89

A.2	Measurement Formulas	89
A.3	Aggregation.....	90
A.4	Supported Electrical Networks	92
A.5	Phase Order	94
A.5.1	Current Phase Order	94
A.5.2	Voltage Phase Order	95
A.5.3	Current vs Voltage Phase Order	96
A.6	Quantities According to the Supply Systems	97
A.7	Glossary of Terms	99
Repair and Calibration		102
Technical and Sales Assistance.....		102
Limited Warranty		103
Warranty Repairs		103

1. INTRODUCTION

1.1 Receiving Your Shipment

Upon receiving your shipment, make sure that the contents are consistent with the packing list. Notify your distributor of any missing items. If the equipment appears to be damaged, file a claim immediately with the carrier and notify your distributor at once, giving a detailed description of any damage. Save the damaged packing container to substantiate your claim.

1.2 Ordering Information

Power & Energy Logger Model PEL 102 (no LCD, w/3 MA193-10-BK sensors)	Cat. #2137.51
Power & Energy Logger Model PEL 103 (with LCD, w/3 MA193-10-BK sensors).....	Cat. #2137.52
Power & Energy Logger Model PEL 102 (no LCD, no sensors)	Cat. #2137.61
Power & Energy Logger Model PEL 103 (with LCD, no sensors).....	Cat. #2137.62

Shipping Contents:



OR

(1) of the following:
Power Energy Logger Model PEL 102
Power Energy Logger Model PEL 103
Cat. #2137.51 or Cat. #2137.52



(4) Black Test Leads and Alligator Clips
Cat. #2137.76



(3) MiniFlex® MA193-10-BK
Cat. #2140.48
(included only with the purchase of Cat. #2137.51 or Cat. #2137.52)



(1) Small Classic Tool Bag
Cat. #2133.72



(1) Power Cord, 5 ft 115V
Cat. #5000.14



(1) USB SD-Card Adapter
Cat. #5000.45

Also Included:

- (1) Safety Sheet for the PEL
- (1) Safety Sheet for the MiniFlex® Sensors
- (1) Compliance Sheet
- (1) 8 GB SD-Card
- (1) Quick Start User Guide
- (1) 4 GB USB Stick with User Manual & DataView® Software
- (1) Battery (NiMH AAA 8.4V) - Cat.#2137.81



(1) 5 ft USB Cable
Cat. #2140.46

1.2.1 Accessories

USB cable, A/B 10 ft (3m)	Cat. #2136.80
PEL Power Adapter	Cat. #2137.77
AC/DC Current Probe Model J93.....	Cat. #2140.49
AC/DC Current Probe Model MR193-BK.....	Cat. #2140.28
AC Current Probe Model MN93-BK.....	Cat. #2140.32
AC Current Probe Model SR193-BK.....	Cat. #2140.33
AmpFlex® Sensor 24" Model 193-24-BK (black connector)	Cat. #2140.34
AmpFlex® Sensor 36" Model 193-36-BK (black connector)	Cat. #2140.35
AC Current Probe Model MN193-BK (black connector)	Cat. #2140.36
MiniFlex® Current Sensor 10" Model MA193-10-BK (black connector).....	Cat. #2140.48
MiniFlex® Current Sensor 14" Model MA193-14-BK (black connector).....	Cat. #2140.50
AC/DC Current Probe Model SL261*	Cat. #1201.51
*BNC Adapter for Current Probe Model SL261.....	Cat. #2140.40

1.2.2 Replacement Parts

Small Classic Tool Bag.....	Cat. #2133.72
Battery (custom factory replacement NiMH AAA 8.4V)	Cat. #2137.81
Lead, Set of 4, 10 ft 4mm Straight Banana Plugs with Set of Alligator Clips (Black) UL and a Set of 12 Color-coded Input ID Markers	Cat. #2137.76
Set of 12 Color-coded Input ID Markers	Cat. #2140.45
USB Cable A/B, 5 ft (1.5m).....	Cat. #2140.46
Power Cord, 5 ft (1.5m) 115V	Cat. #5000.14
USB SD-card Adapter.....	Cat. #5000.45

DataView® Software Updates are Available at www.aemc.com

**PEL Android App Available on the Google Play Store at
<https://play.google.com/store/apps/details?id=com.aemc.pel&hl=en>**

2. PRODUCT FEATURES

2.1 Description

PEL: Power and Energy Logger

The PEL 102 and PEL 103 are simple-to-use, single, dual (split-phase) and three phase (Y, Δ) power and energy loggers.

The PEL offers all the necessary functions for Power/Energy data logging for most of the 50Hz, 60Hz, and 400Hz and DC distribution systems worldwide offering numerous distribution set-ups. The PEL is designed to work in 1000V CAT III and 600V CAT IV environments.

The PEL is compact in size and fits in many distribution panels.

The PEL provides the following measurements (or calculations):

- Direct voltage measurements up to 1000V CAT III and 600V CAT IV
- AC current measurements from 200mA up to 10,000A with MA193 external current sensors
- Power measurements: VA, W and var
- Energy measurements: VAh, Wh (source, load) and varh (4 quadrants)
- Power Factor (PF), Cos ϕ , and Tan Φ
- Crest Factor
- Total Harmonic Distortion (THD) for voltages and currents
- Harmonics from the fundamental signal up to the 50th order for 50/60Hz voltages and currents
- Frequency measurements
- RMS and DC measurements @ 128 samples/cycle – each phase simultaneously
- Bright triple LCD on the Model PEL 103 (3 phases shown simultaneously)
- Storage of measured and calculated values on a SD-Card or SDHC-Card
- Automatic recognition of the different types of current sensors
- Configuration of current and voltage ratios with external sensors
- 17 types of supported hook-ups or electrical distribution systems
- USB, LAN, and Bluetooth communication
- DataView® Software for data download, viewing of measurements, real-time communication with a PC and report generation with predefined or custom templates

2.2 Front Panel Features

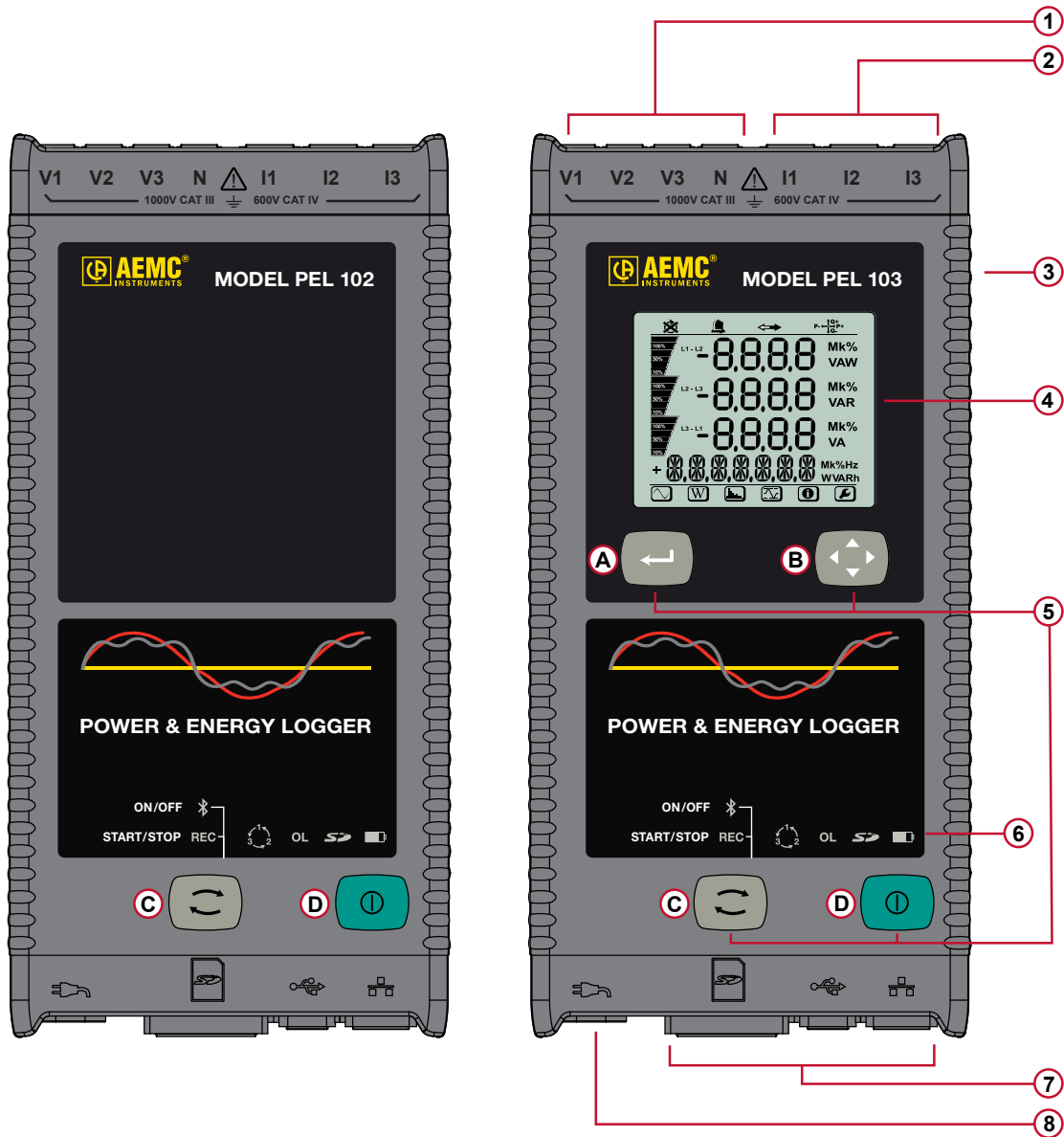

Figure 1

- ① Four voltage input terminals.
- ② Three current input terminals.
- ③ Rigid molded casing over-molded with thermo-adhesive rubber.
- ④ Digital LCD displaying measured, calculated and parameterizing quantities (see § 2.9).
- ⑤ Two (PEL 102) or Four (PEL 103) function buttons (see § 2.8).
 - Ⓐ Enter Button Ⓑ Navigation Button Ⓒ Control button Ⓓ On/Off button
- ⑥ Nine LEDs for status information (see § 2.10).
- ⑦ Connections for USB, Ethernet, SD memory card and terminal cover caps.
- ⑧ Standard (IEC C7 figure 8 terminal – non polarized) power connector for 110/250VAC power source.

2.3 Back Panel Features

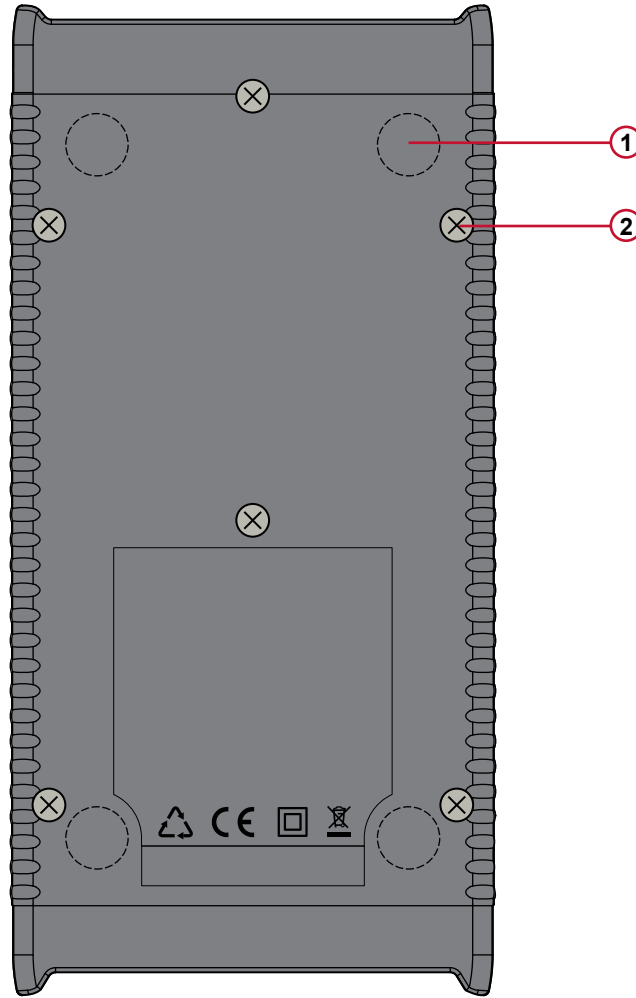

Figure 2

- ① Four magnets (molded into the rubber casing).
- ② Six recessed Torx® screws (for factory service use only).

2.4 Lead Inputs

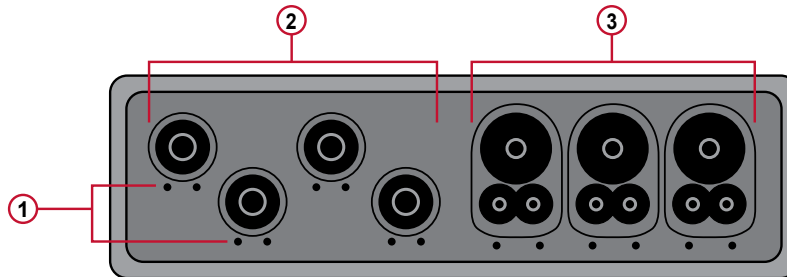

Figure 3

- ① (• •) are the color-coded ID marker insertion locations for the current or voltage inputs.
- ② Voltage input connectors (safety banana plug inputs).
- ③ Current sensor input connectors.

For multiple-phase measurements, start by marking the accessories using the color-coded ID markers supplied with the device; a different color for each current terminal.

Connect the measuring leads to your PEL as follows:

- Current measurement: I1, I2, I3 4-point connectors
- Voltage measurement: V1, V2, V3 and N terminals

The measuring leads must be connected to the circuit to be monitored according to the selected hook-up diagram. Do not forget to define the voltage and current transformer's ratios when necessary.

2.5 Installation of the Color-coded ID Markers

! Refer to the current sensor's safety sheet or user manual before connecting it.

Twelve sets of color-coded rings and inserts are supplied with your PEL instrument. Use these ID markers to identify the leads and input terminals.

- Detach the appropriate inserts from the color-coded marker and place them in the holes provided under the terminals (larger inserts for current terminals, smaller inserts for voltage terminals).
- Clip the rings of the same color to the ends of the lead you will be connecting to the terminal.

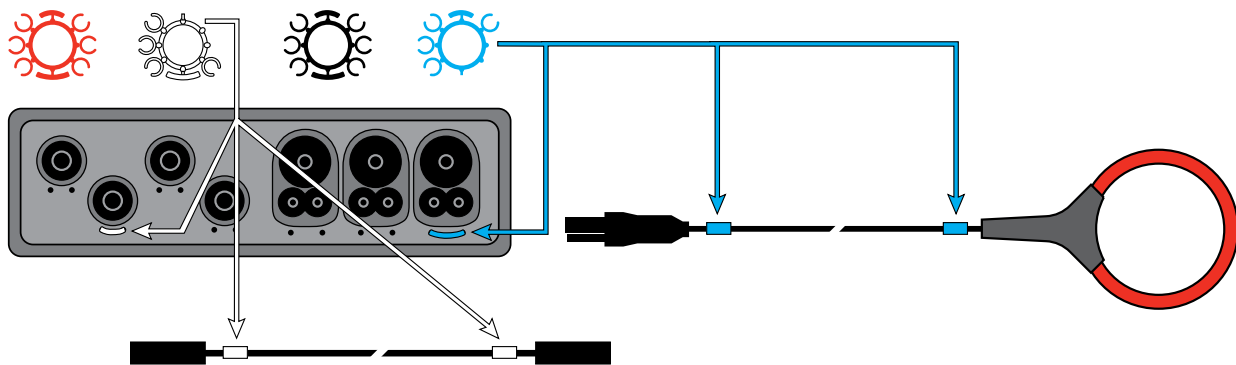

Figure 4

2.6 Connection Features

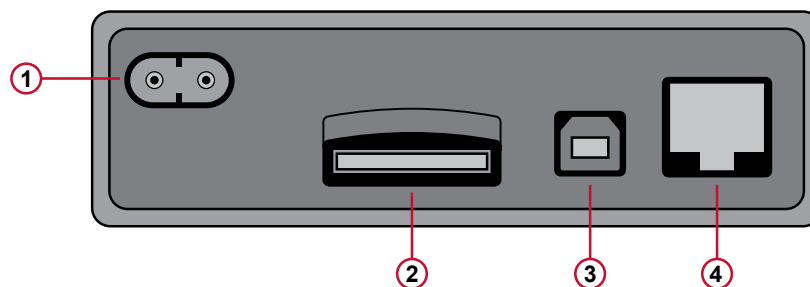

Figure 5

- ① Power cord connection (see § 3.5.1).
- ② SD card slot (see § 3.5.3).
- ③ USB connector (see § 3.5.4).
- ④ Ethernet RJ 45 connector (see § 3.5.5).

2.7 Mounting and Location



NOTE: Magnetic fields can damage hard drives and medical devices.

The PEL should be placed in a well-ventilated room; temperature not to exceed those specified in § 5.6.

The PEL 102 and PEL 103 can be mounted to a flat ferromagnetic vertical surface using the molded-in magnets.



Figure 6

2.8 Button Functions

BUTTON	DESCRIPTION
	ON/OFF Button: <ul style="list-style-type: none">- Turns the instrument ON or OFF (see § 3.1). NOTE: The instrument cannot be turned OFF while connected to an AC outlet or if a recording is in progress.
	Control Button: <ul style="list-style-type: none">- Starts/Stops the recording session and Enables/Disables Bluetooth (see § 3.4).
	Enter Button (PEL103): <ul style="list-style-type: none">- Displays phase angle values and partial energies (long push) (see § 3.7.2)
	Navigation Button (PEL103): <ul style="list-style-type: none">- Enables browsing and the selection of data displayed on the LCD (see § 3.7).

Table 1

2.9 LCD Display (PEL 103)

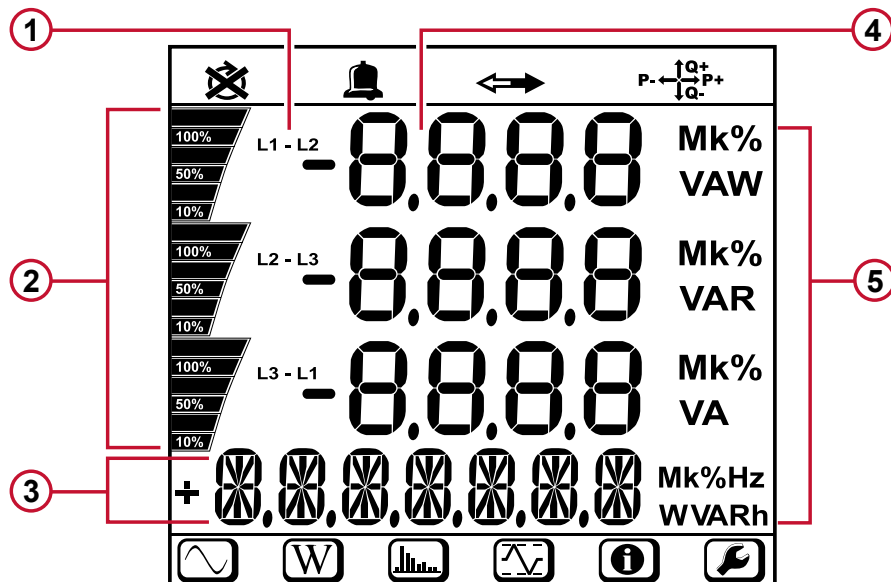

Figure 7

- ① Measured phase indicator.
- ② Bargraph (Load factor - Min - Max). The bargraph indicates the percentage (0% to 100%) of full range or full load as programmed into the PEL by the user through the DataView® software.
- ③ Measurements or page title.
- ④ Measurement values.
- ⑤ Measurement units.

Top and bottom display bars indicate the following:

ICON	DESCRIPTION
	Phase Sequence reversal indicator or missing phase (displayed only in Real-Time Measurement Mode)
	Data are available for recording (non-display indicates possible internal problem)
	Power quadrant indicator
	Real-time Measurement Mode
	Power and Energy Mode
	Harmonics Mode
	Max Mode
	Information Mode
	Configuration Mode

Table 2

2.10 LED Status

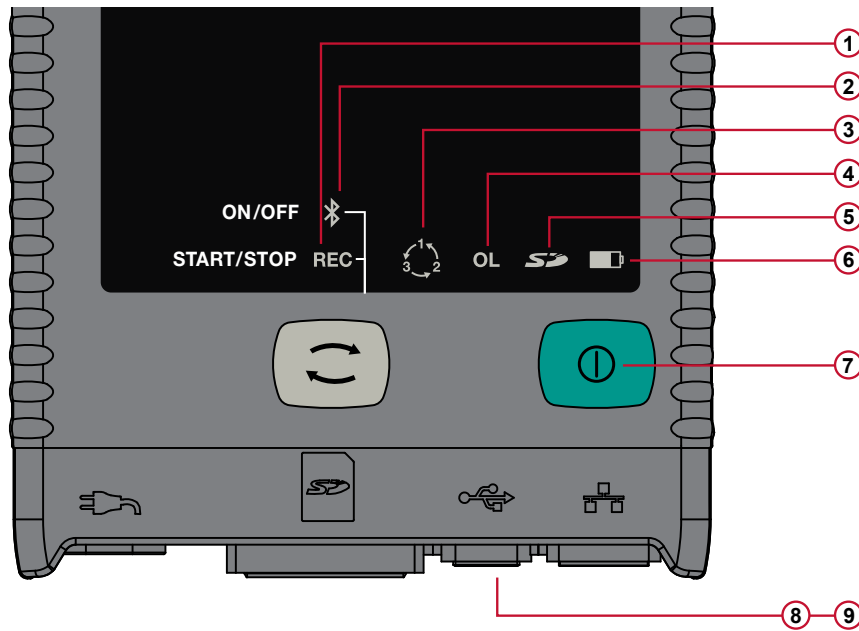

Figure 8

LED & COLOR	STATUS
①	Green LED: Recording Status <ul style="list-style-type: none"> - LED blinks once per second every 5 s: Logger in standby (not recording) - LED blinks twice per second every 5 s: Logger in recording mode
②	Blue LED: Bluetooth <ul style="list-style-type: none"> - LED OFF: Bluetooth OFF (disabled) - LED ON: Bluetooth ON (enabled - not transmitting) - LED blinks twice per second: Bluetooth ON (enabled - transmitting)
③	Red LED: Phase Order <ul style="list-style-type: none"> - OFF: Phase rotation order correct - LED blinks once per second: the order of phase rotation is incorrect. In this case, there are three possibilities: <ul style="list-style-type: none"> ■ phase difference between the phase currents is 30° greater than normal (120° in three-phase and 180° in two-phase). ■ phase difference between the phase voltages is 10° greater than normal. ■ phase difference between the currents and voltages of each phase is 60° greater than 0° (load) or 180° (source).
④	Red LED: Overload <ul style="list-style-type: none"> - OFF: No input overload - LED blinks once per second: At least one input is in overload - LED ON: Indicates a current probe is either mismatched or missing
⑤	Red/Green LED: SD-Card Status <ul style="list-style-type: none"> - Green LED ON: SD-Card is OK - Red LED blinks five times every 5 s: SD-Card is full - Red LED blinks four times every 5 s: less than 1 week capacity remaining - Red LED blinks three times every 5 s: less than 2 weeks capacity remaining - Red LED blinks twice every 5 s: less than 3 weeks capacity remaining - Red LED blinks once every 5 s: less than 4 weeks capacity remaining - Red LED ON: SD-Card is not present or locked
⑥	Yellow/Red LED: Battery Status <ul style="list-style-type: none"> - When the AC power cord is connected, the battery charges until it is full. - LED OFF: Battery full (with or without power supply) - Yellow LED ON: Battery is charging - Yellow LED blinks once per second: Battery is recovering from a full discharge - Red LED blinks twice per second: Low battery (and no power supply)

LED & COLOR	STATUS
<p>7 under ON/OFF button</p>	<p>Green LED: ON/OFF</p> <ul style="list-style-type: none"> - LED ON: External power supply present - LED OFF: No external power supply
<p>8 embedded in the connec- tor</p>	<p>Green LED: Ethernet</p> <ul style="list-style-type: none"> - LED OFF: No activity - LED blinking: Activity
<p>9 embedded in the connec- tor</p>	<p>Yellow LED: Ethernet</p> <ul style="list-style-type: none"> - LED OFF: The stack failed to initialize or the Ethernet controller failed to initialize - Blink Slow, toggle every second: The stack initialized properly - Blink Fast, toggle 10 times per second: The Ethernet controller initialized properly - Blink Twice, toggle 2 times, then pause: DHCP Error - LED ON: Network initialized and ready for use

Table 3

2.11 Memory Capacity

The PEL accepts FAT32 formatted SD or SDHC cards 8 to 32 GB in size. This much data can require a lot of demand on a computer and a long download time (depending on the performance of the PC and connection type being used). Furthermore, some computers may have problems handling such a large amount of data and spreadsheets can only accept a limited amount of data.

Recording rates for the different types of session data are as follows:

- 1s Harmonics: 83 MB per day.
- 1s Trends: 17 MB per day.
- Aggregated data: 1.2 MB per day for 1 minute periods.
For longer periods, this rate is divided by the period in minutes.
Example: for an aggregation period of 10 minutes, the rate will be 0.12 MB per day.

We recommend managing the data on the SD card and only recording that which is needed. For reference purposes, a 5 day recording, with a 15 minute demand interval and recording 1 second data and harmonics on a 3-phase 4-wire network would consume approximately 530 MB of storage space. If harmonics are not needed and the recording of them is disabled, the space requirement is reduced to about 87 MB.

The recommended maximum recording times are:

- seven days when the recording includes the aggregated values, 1-second data, and harmonics.
- one month when the recording includes the aggregated values and 1-second data but not the harmonics.
- one year when the recording contains only the aggregated values.

Also avoid exceeding 32 recorded sessions on the SD card.

NOTE: For recordings with harmonics or with a duration longer than one week, please use class 4 or higher SDHC cards.

We recommend not downloading large sessions through Bluetooth as it will take a very long time. If a Bluetooth download is required, consider not recording 1 second trends and harmonics. The same 30 day recording would be reduced to just 2.5 MB.

Downloading over USB and Ethernet may be acceptable depending on the session size and network speed. We recommend putting the SD card into your PC directly or with the external card reader for fastest download time.

3. OPERATION

3.1 Charging the Battery

Before the first use, start by fully charging the battery.

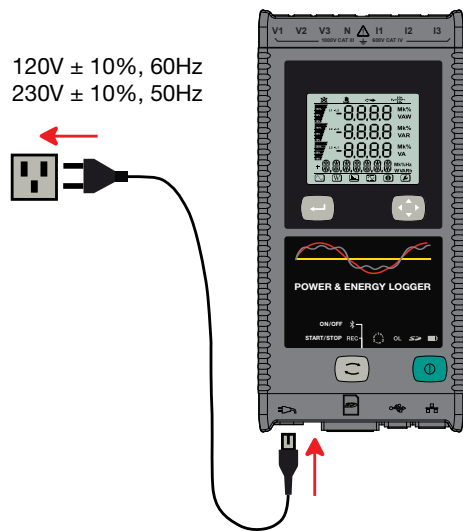





Figure 9

- Connect the supplied power cord to the instrument and AC power.
- The device will automatically turn ON.
- The  LED lights; it will go out only when the battery is fully charged.
- A low battery charging takes approximately 5 hours.

The Yellow/Red LED (see #6 Figure 8) is used to indicate the status of the battery.

- When the power is on, the battery is charging until it is full.
- LED OFF: Battery full (with or without power supply).
- Yellow LED ON/No blinks: Battery is charging.
- Yellow LED blinks twice per second: Battery is recovering after a full discharge.
- Red LED blinks twice per second: Low battery (and no power supply).

 After prolonged storage, the battery may be completely discharged. If so, the  LED blinks twice per second. In this case, at least 5 charge/discharge cycles will be necessary for your battery to recover 95% of its capacity.

3.2 Operating the PEL

 **IMPORTANT:** The following OPERATION instructions assume that the PEL has been configured by the user prior to use. The PEL can only be fully configured through the PEL Control Panel distributed with the DataView® software, although on the PEL 103 some parameters (such as hookup type) can also be set through the LCD display on the device itself. Please refer to § 4.3 for setup instructions using DataView®, and § 3.7.6 for setup through the PEL 103 LCD display.

- The PEL must be first programmed before recording. This is done through the PEL Control Panel (see § 4.3) or, for the PEL 103, this can also be done on the LCD display (see § 3.7.6).
- The PEL is then connected to a power supply and will turn on automatically (see § 3.3.1).
- Recording is started by pressing the **Control** button  (see § 3.4).
- The PEL can be turned OFF when disconnected from the power supply (and when the recording session is completed - see § 3.3.2).

3.3 Turning the Instrument ON/OFF

3.3.1 Turning the PEL ON

To turn the PEL ON:

- Connect the PEL to a power outlet with the AC power cord and the PEL will turn ON automatically. If it does not, press the ON/OFF button for >2 seconds.
- The GREEN LED under the **ON/OFF** button turns ON when the PEL is connected to a live supply source.

 **NOTE:** The batteries automatically begin recharging when the PEL is connected to a live power outlet. Battery life is limited to approximately 1/2 hour when the battery is completely charged. This enables ride through during brief power outages and power shutdowns.

3.3.2 Turning the PEL OFF

The PEL will not turn OFF as long as it is connected to a power supply source and if a recording is ON.

NOTE: This is done as a precaution to ensure that the PEL is not accidentally turned OFF when recording and to ensure that the PEL turns on when the power supply is turned back on after an outage.

To turn the PEL OFF:

- Unplug the AC power supply outlet.
- Press the **ON/OFF** button for more than 2 seconds until all LEDs turn on. Then release the **ON/OFF** button.
- All LEDs and the display will turn off as the PEL powers down.
- If the PEL has supply power present it will not turn OFF.
- If a recording is pending or in progress it will not turn OFF.

 **NOTE:** Pressing the **ON/OFF** button when the instrument is powered and/or recording (or pending) does not stop the instrument. This is done to avoid any accidental or unintentional recording stoppage by the user. You must first unplug the power cord from the supply outlet, stop any recording session, power down by pushing the **ON/OFF** button for more than 2 seconds until all LEDs light up and then release the **ON/OFF** button.

3.4 Starting/Stopping a Recording and Enabling Bluetooth

Recordings are stored only on the SD card.

To Start a Recording:

- Insert the SD-card into the PEL.
- Use the **Control** button  to start or stop a recording session and to enable or disable Bluetooth.
- Press the **Control** button for more than 2 seconds and hold it down.
- The green REC LED (see #1 Figure 8) will light up for 3 seconds, followed by the lighting of the blue Bluetooth LED (see #2 Figure 8) for 3s - one after another. During the time these LEDs are lit, you will be able to control their respective function as described below.
- Releasing the **Control** button during (and only during) the 3 seconds lighting of a particular LED performs the associated function:
 - **REC LED (START/STOP)**
 - A release while LED is lit starts a recording (if recording is OFF)
 - A release while LED is lit stops a recording (if recording is ON)
 - **BLUETOOTH LED (ON/OFF)**
 - A release while LED is lit turns ON Bluetooth (if Bluetooth is OFF)
 - A release while LED is lit turns OFF Bluetooth (if Bluetooth is ON)

If you want to make changes to both the Recording and Bluetooth, you need to go through the process twice.

 **NOTE:** If the **Control** button is locked (disabled) by the PEL Control Panel (see § 4), you cannot use it to start or stop a recording, or enable/disable Bluetooth. Instead, upon pressing the **Control** button while it is locked you will see the Bluetooth and REC lights blink twice, with no changes taking effect on the instrument. To enable the **Control** button, you must open the PEL Control Panel on your PC and de-select the “Lock out the Control button...” option in the Configure Instrument dialog box, as explained in the PEL Control Panel online Help.

3.5 Connections

3.5.1 Power Supply

The PEL is powered by standard AC power through an external C7 cord (figure-eight type, non-polarized power plug). This power cord is available in many computer or electrical supply stores. It is also referred to as a Laptop or Netbook C7 power cable. For replacement, be sure to buy the non-polarized cord. Replacement power cords are also available from the factory.

The PEL can be supplied from nominal 110V to 250V (accepts $\pm 10\%$) 50/60Hz to accommodate available supply voltages globally.

 **NOTE:** Never use power cords with inadequate rating.

- When the instrument is powered by AC power, the instrument is always ON.
- Applying AC power to the PEL turns the instrument ON if it was OFF and starts recharging the batteries automatically.
- When AC power is not present (power supply OFF or disconnected from a power supply), the instrument will run on battery power for approximately 30 minutes or less when Auto Power Off is enabled (see below).
- The PEL has a built in Auto Power OFF, which can be set to 3 to 15 min or disabled.
- When the battery level is too low and a Low Bat condition occurs (the red LED  blinks twice per second), the instrument will eventually turn OFF. The PEL will start up again once it has been reconnected to a power supply.

- When the instrument is not powered by AC power, it can be turned ON with the **ON/OFF** button (see § 3.3.1).
- When the instrument is not powered by AC power and no recording is pending or in progress, it can be turned OFF with the **ON/OFF** button (see § 3.3.2).

3.5.2 Standby Mode (and Display Brightness)

When the instrument is ON and there is no activity for a definite time period, the LCD (PEL103) automatically goes into Standby mode. The measurements and recording stay active, but the LCD backlight brightness diminishes to a user preset level. The Standby LCD brightness level is user programmed through the PEL Control Panel (see § 4.4.1). To re-establish the LCD brightness, press the Enter or Navigation buttons. Note that the overall display brightness is also programmed through the PEL Control Panel (see § 4.4.1).

3.5.3 Memory Card (SD-Card)

The PEL102 and PEL103 use an SD card for data storage. SD- and SDHC cards (8GB to 32GB) formatted FAT32 are supported. The PEL is delivered with a formatted SD card in the instrument. If you want to install a new SD card, you must format the card before use.

- Formatting the SD-Card is possible through the PEL DataView Control Panel when connected to the instrument and if no recording is pending or in progress.
- Hot extraction from the PEL is possible when no recording is in progress.
- PEL files use short names (8 characters), such as Ses00004.

3.5.4 USB Connection to the PEL

The PEL 102 and PEL 103 can be connected to a computer through a USB (type A/Type B connectors) to configure the PEL, prepare a recording session (real-time connection) and download recording sessions.

 **NOTE:** Connecting the USB between the PC and the PEL will not power the logger or recharge the batteries.

3.5.5 LAN Ethernet Connection to the PEL

A LAN connection can be used to view real-time data, instrument status, configure the PEL, setup and start a recording session and download recorded sessions.

The PEL has an IP address. When configuring the PEL with the PEL Control Panel, if the checkbox next to “Enable DHCP” is checked in the Communication tab of the Configure Instrument dialog box (see § 4.4.2), the instrument sends a request to the network DHCP server to automatically obtain an IP address.

If for any reason the DHCP server is not available, after 60 seconds the PEL Control Panel will enter auto-IP mode, using the default IP address **169.254.0.100** (the same IP address used when “Enable DHCP” is not selected). This auto-IP mode is compatible with APIPA (Automatic Private IP Addressing). A cross-over cable may be needed in auto-IP mode.

The Internet Protocol used is UDP. Port **3041** is used by default, but it can be modified in the PEL Control Panel (see § 4.4.2) to allow multiple PC connections to multiple PEL instruments behind a router.

 **NOTE:** The LAN parameters cannot be modified while connected over a LAN link. A USB connection must be used to modify them.

3.5.6 Bluetooth Connection to the PEL

The PEL 102 and PEL 103 are designed for a Bluetooth wireless connection to a computer. The Bluetooth connection can be used to configure the PEL, to prepare a recording session and to download recorded sessions.

To communicate using the Bluetooth connection you will need a computer with Bluetooth capability. Some computers are supplied with this capability, while others will need to have an external Bluetooth adapter.

The pairing procedure varies depending on your operating system, Bluetooth equipment and driver software.

The default pairing code is **0000** if needed. The pairing code cannot be modified through the PEL Control Panel (DataView® software).

 **NOTE:** The information in the following section is only necessary the first time an instrument is connected.

3.5.6.1 Pairing using Windows 7

The following example uses the Windows 7 operating system procedure. The pairing procedure for other versions of Windows may vary.

1. First, make sure Bluetooth is enabled on the instrument (see § 4.4.2)
2. Connect the USB adapter to the PC.
3. A Bluetooth symbol, similar to this , will appear in the taskbar (bottom-right side of your computer screen) once the driver is installed.
4. Double-click on the icon and select **“Add a Device”**.
5. In the **“Add a Device”** window, select the PEL model you wish to connect to and select **“Next”**.

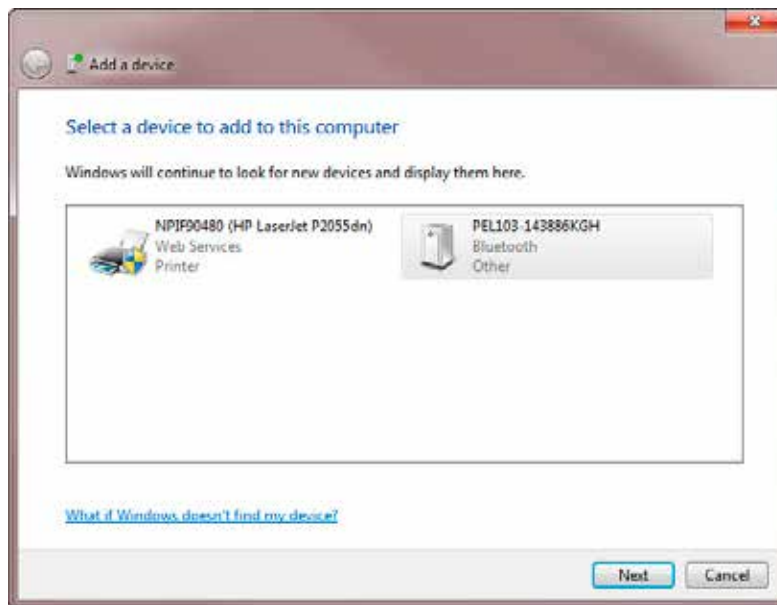



Figure 10

 **NOTE:** Depending on the Bluetooth setup and operating system, it may be necessary to enter a passkey to finalize the instrument connection. If so, the default passkey is: **0000**.

6. Once the instrument has been successfully added to the computer, a window similar to Figure 11 will be displayed. Select **“Close”**.

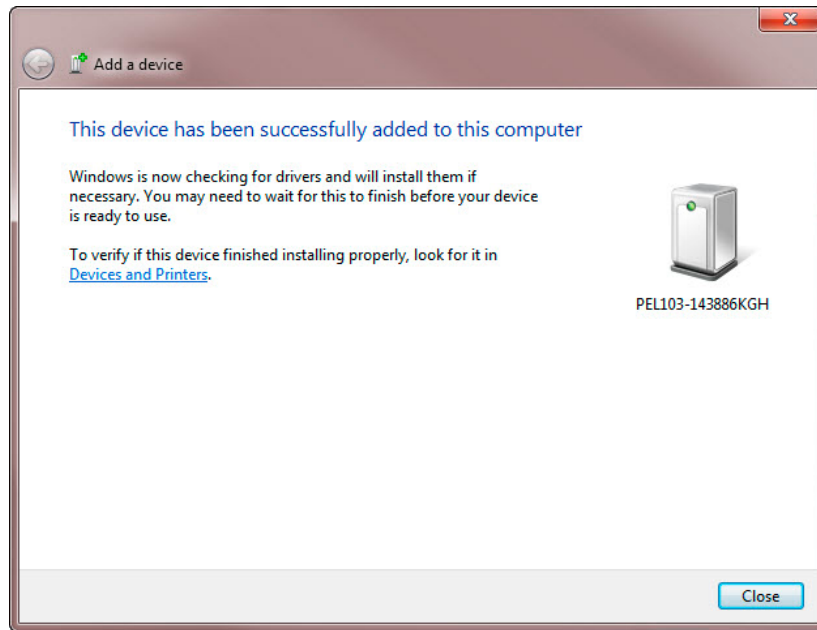

Figure 11

7. Launch the PEL Control Panel using the icon placed on the desktop during the Dataview® software installation, then connect the instrument via Bluetooth by performing the steps in §4.2.

3.6 Distribution Systems and PEL Hook-ups

This section describes how the current sensors and voltage test leads have to be connected to your installation according to its distribution system. The PEL shall also be configured (see § 4.4.3) for the selected distribution system.

Source  Load

3.6.1 Single Phase 2-Wire

For Single Phase 2-Wire measurements:

- Connect the terminal N test lead to the neutral conductor
- Connect the terminal V1 test lead to the L1 phase conductor
- Connect the current probe to the L1 phase conductor

Ensure that the current arrow on the sensor is directed towards the load. This ensures proper phase angle for power measurements and other phase sensitive measurements.

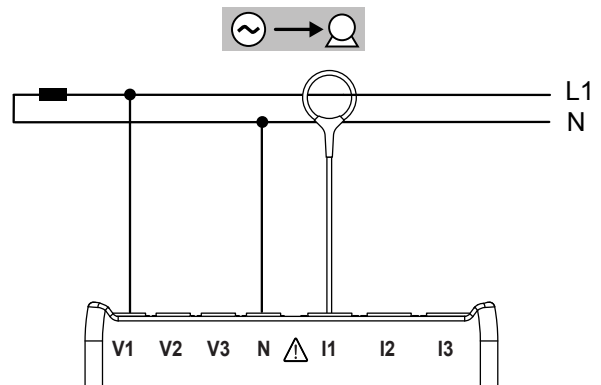

Figure 12

3.6.2 Single Phase 3-Wire (Split Phase from a center tap transformer)

For Single Phase 3-Wire (Split Phase) measurements:

- Connect the terminal N test lead to the neutral conductor
- Connect the terminal V1 test lead to the L1 phase conductor
- Connect the terminal V2 test lead to the L2 phase conductor
- Connect the terminal I1 current probe to the L1 phase conductor
- Connect the terminal I2 current probe to the L2 phase conductor

Ensure that the current arrow on the sensor is directed towards the load. This ensures proper phase angle for power measurements and other phase sensitive measurements.

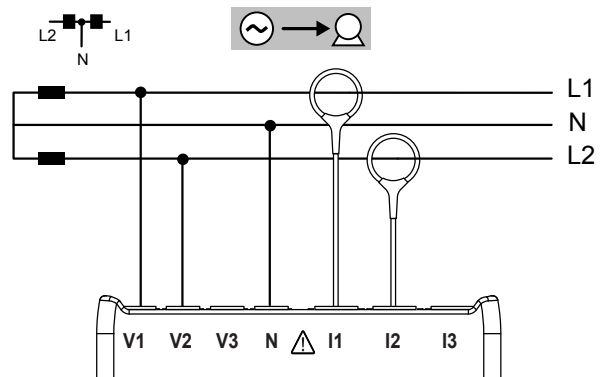

Figure 13

3.6.3 3-Phase 3-Wire Power Networks

3.6.3.1 3-Phase 3-Wire Δ (with 2 current sensors)

For 3-Phase 3-Wire Δ measurements using two current sensors:

- Connect the terminal V1 test lead to the L1 phase conductor
- Connect the terminal V2 test lead to the L2 phase conductor
- Connect the terminal V3 test lead to the L3 phase conductor
- Connect the terminal I1 current probe to the L1 phase conductor
- Connect the terminal I3 current probe to the L3 phase conductor

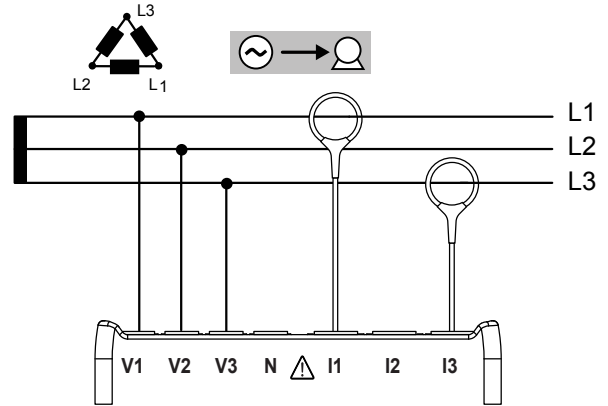

Figure 14

Ensure that the current arrow on the sensor is directed towards the load. This ensures proper phase angle for power measurements and other phase sensitive measurements.

3.6.3.2 3-Phase 3-Wire Δ (with 3 current sensors)

For 3-Phase 3-Wire Δ measurements using three current sensors:

- Connect the terminal V1 test lead to the L1 phase conductor
- Connect the terminal V2 test lead to the L2 phase conductor
- Connect the terminal V3 test lead to the L3 phase conductor
- Connect the terminal I1 current probe to the L1 phase conductor.
- Connect the terminal I2 current probe to the L2 phase conductor
- Connect the terminal I3 current probe to the L3 phase conductor

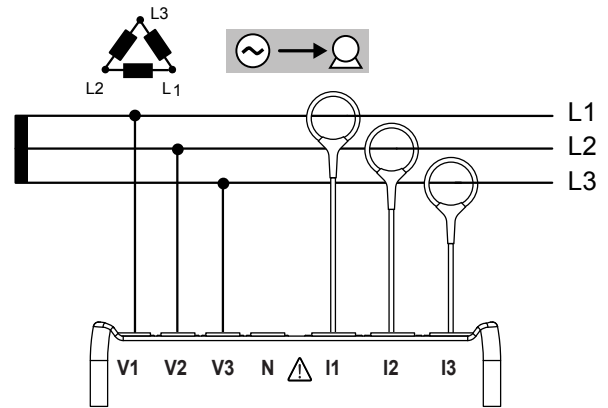

Figure 15

Ensure that the current arrow on the sensor is directed towards the load. This ensures proper phase angle for power measurements and other phase sensitive measurements.

3.6.3.3 3-Phase 3-Wire Open Δ (with 2 current sensors)

For 3-Phase 3-Wire Open Δ measurements using two current sensors:

- Connect the terminal V1 test lead to the L1 phase conductor
- Connect the terminal V2 test lead to the L2 phase conductor
- Connect the terminal V3 test lead to the L3 phase conductor
- Connect the terminal I1 current probe to the L1 phase conductor
- Connect the terminal I3 current probe to the L3 phase conductor

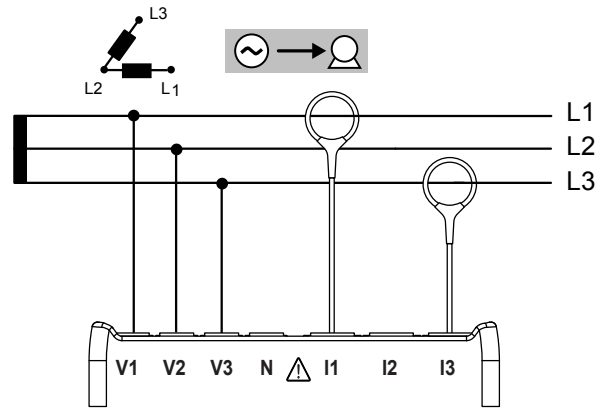

Figure 16

Ensure that the current arrow on the sensor is directed towards the load. This ensures proper phase angle for power measurements and other phase sensitive measurements.

3.6.3.4 3-Phase 3-Wire Open Δ (with 3 current sensors]

For 3-Phase 3-Wire Open Δ measurements using three current sensors:

- Connect the terminal V1 test lead to the L1 phase conductor
- Connect the terminal V2 test lead to the L2 phase conductor
- Connect the terminal V3 test lead to the L3 phase conductor
- Connect the terminal I1 current probe to the L1 phase conductor
- Connect the terminal I2 current probe to the L2 phase conductor
- Connect the terminal I3 current probe to the L3 phase conductor

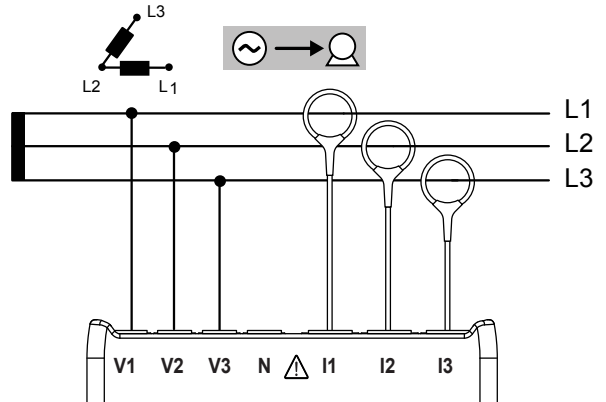

Figure 17

Ensure that the current arrow on the sensor is directed towards the load. This ensures proper phase angle for power measurements and other phase sensitive measurements.

3.6.3.5 3-Phase 3-Wire Y (with 2 current sensors)

For 3-Phase 3-Wire Y measurements using two current sensors:

- Connect the terminal V1 test lead to the L1 phase conductor
- Connect the terminal V2 test lead to the L2 phase conductor
- Connect the terminal V3 test lead to the L3 phase conductor
- Connect the terminal I1 current probe to the L1 phase conductor
- Connect the terminal I3 current probe to the L3 phase conductor

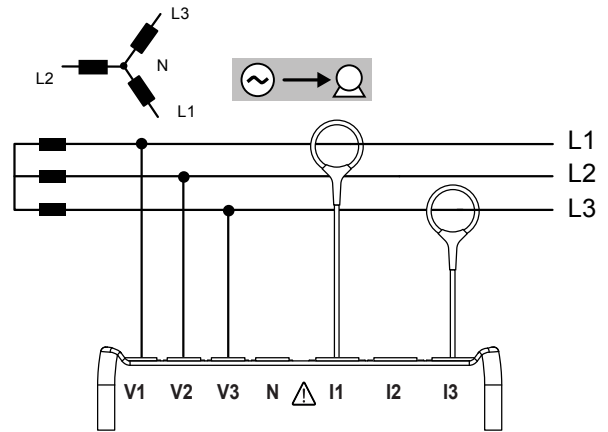

Figure 18

Ensure that the current arrow on the sensor is directed towards the load. This ensures proper phase angle for power measurements and other phase sensitive measurements.

3.6.3.6 3-Phase 3-Wire Y (with 3 current sensors]

For 3-Phase 3-Wire Y measurements using three current sensors:

- Connect the terminal V1 test lead to the L1 phase conductor
- Connect the terminal V2 test lead to the L2 phase conductor
- Connect the terminal V3 test lead to the L3 phase conductor
- Connect the terminal I1 current probe to the L1 phase conductor
- Connect the terminal I2 current probe to the L2 phase conductor
- Connect the terminal I3 current probe to the L3 phase conductor

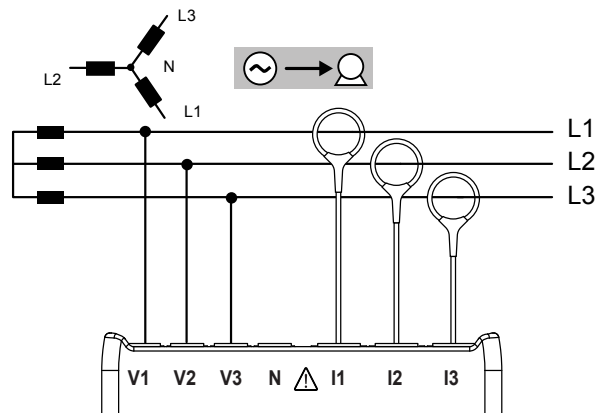

Figure 19

Ensure that the current arrow on the sensor is directed towards the load. This ensures proper phase angle for power measurements and other phase sensitive measurements.

3.6.3.7 3-Phase 3-Wire Δ Balanced (with 1 current sensor)

For 3-Phase 3-Wire Δ Balanced measurements using one current sensor:

- Connect the terminal V1 test lead to the L1 phase conductor
- Connect the terminal V2 test lead to the L2 phase conductor
- Connect the terminal I3 current probe to the L3 phase conductor

Ensure that the current arrow on the sensor is directed towards the load. This ensures proper phase angle for power measurements and other phase sensitive measurements.

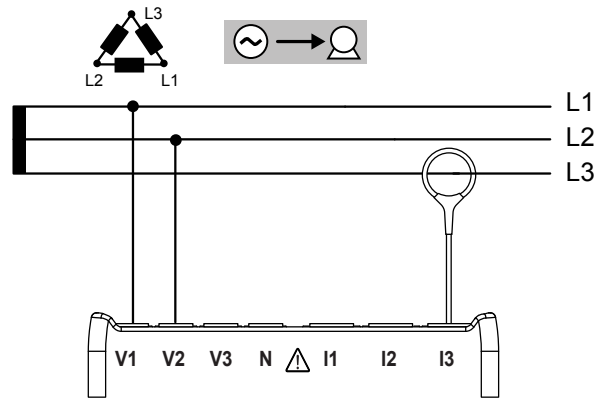

Figure 20

3.6.4 3-Phase 4-Wire Y Power Networks

3.6.4.1 3-Phase 4-Wire Y (with 3 current sensors)

For 3-Phase 4-Wire Y measurements using three current sensors:

- Connect the terminal N test lead to the neutral conductor
- Connect the terminal V1 test lead to the L1 phase conductor
- Connect the terminal V2 test lead to the L2 phase conductor
- Connect the terminal V3 test lead to the L3 phase conductor
- Connect the terminal I1 current probe to the L1 phase conductor
- Connect the terminal I2 current probe to the L2 phase conductor
- Connect the terminal I3 current probe to the L3 phase conductor

Ensure that the current arrow on the sensor is directed towards the load. This ensures proper phase angle for power measurements and other phase sensitive measurements.

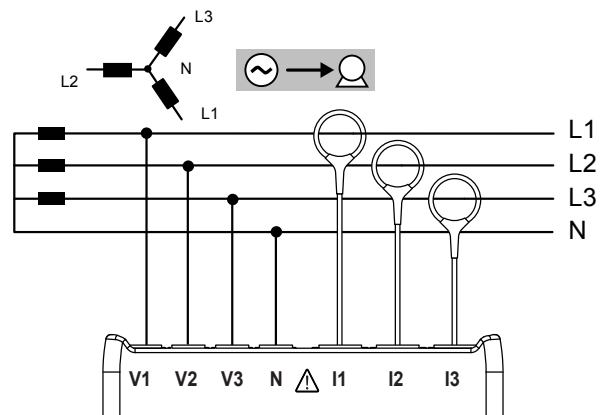

Figure 21

3.6.4.2 3-Phase 4-Wire Y Balanced

For 3-Phase 3-Wire Balanced Y measurements using one current sensor:

- Connect the terminal N test lead to the neutral conductor
- Connect the terminal V1 test lead to the L1 phase conductor
- Connect the terminal I1 current probe to the L1 phase conductor

Ensure that the current arrow on the sensor is directed towards the load. This ensures proper phase angle for power measurements and other phase.

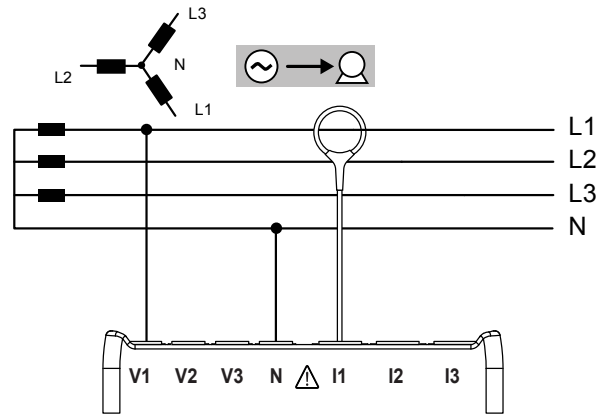

Figure 22

3.6.4.3 3-Phase 4-Wire Y 2½ Element

For 3-Phase 4-Wire Y 2½ Element measurements and using three current sensors:

- Connect the terminal N test lead to the neutral conductor
- Connect the terminal V1 test lead to the L1 phase conductor
- Connect the terminal V3 test lead to the L3 phase conductor
- Connect the terminal I1 current probe to the L1 phase conductor
- Connect the terminal I2 current probe to the L2 phase conductor
- Connect the terminal I3 current probe to the L3 phase conductor

Ensure that the current arrow on the sensor is directed towards the load. This ensures proper phase angle for power measurements and other phase sensitive measurements.

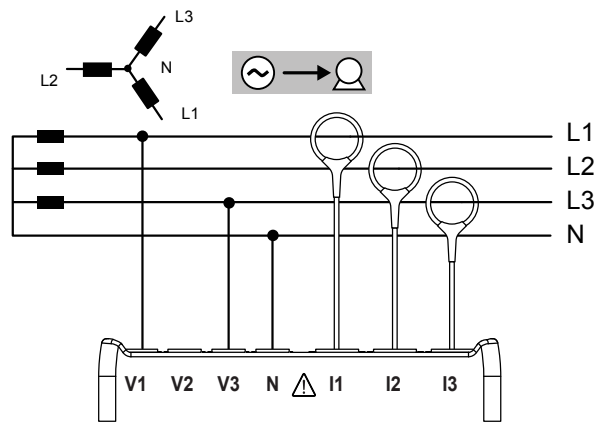

Figure 23

3.6.5 3-Phase 4-Wire Δ

High Leg configuration. No Potential Transformer (Voltage Transformer) is connected; the installation under test is supposed to be a low voltage distribution system.

3.6.5.1 3-Phase 4-Wire Δ

For 3-Phase 4-Wire Δ measurements and using three current sensors:

- Connect the terminal N test lead to the neutral conductor
- Connect the terminal V1 test lead to the L1 phase conductor
- Connect the terminal V2 test lead to the L2 phase conductor
- Connect the terminal V3 test lead to the L3 phase conductor
- Connect the terminal I1 current probe to the L1 phase conductor
- Connect the terminal I2 current probe to the L2 phase conductor
- Connect the terminal I3 current probe to the L3 phase conductor

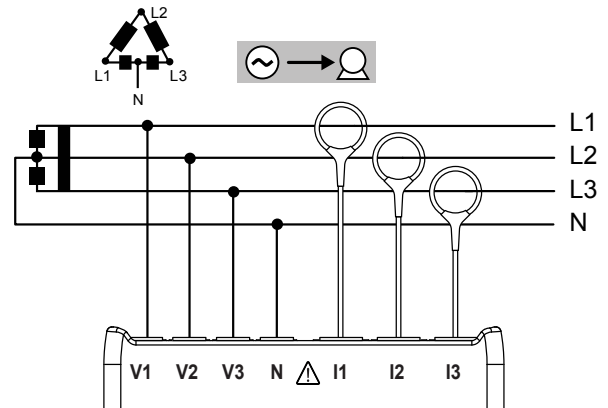

Figure 24

Ensure that the current arrow on the sensor is directed towards the load. This ensures proper phase angle for power measurements and other phase sensitive measurements.

3.6.5.2 3-Phase 4-Wire Open Δ

For 3-Phase 4-Wire Open Δ measurements and using three current sensors:

- Connect the terminal N test lead to the neutral conductor
- Connect the terminal V1 test lead to the L1 phase conductor
- Connect the terminal V2 test lead to the L2 phase conductor
- Connect the terminal V3 test lead to the L3 phase conductor
- Connect the terminal I1 current probe to the L1 phase conductor
- Connect the terminal I2 current probe to the L2 phase conductor
- Connect the terminal I3 current probe to the L3 phase conductor

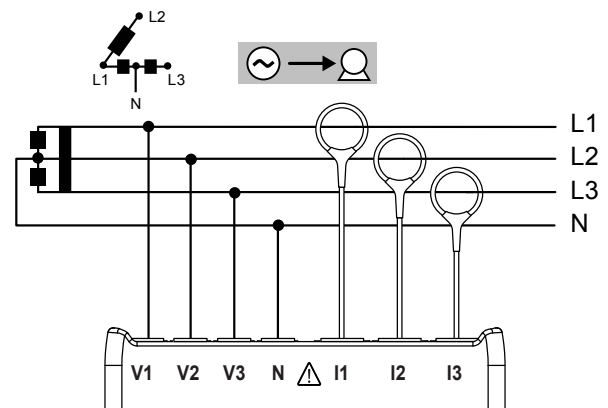

Figure 25

Ensure that the current arrow on the sensor is directed towards the load. This ensures proper phase angle for power measurements and other phase sensitive measurements.

3.6.6 DC Power Networks

3.6.6.1 DC 2-Wire

For DC 2- Wire measurements:

- Connect the terminal N test lead to the common conductor
- Connect the terminal V1 test lead to conductor +1
- Connect the terminal I1 current probe to conductor +1

Ensure that the current arrow on the sensor is directed towards the load. This ensures proper measurements for power and other sign sensitive quantities.

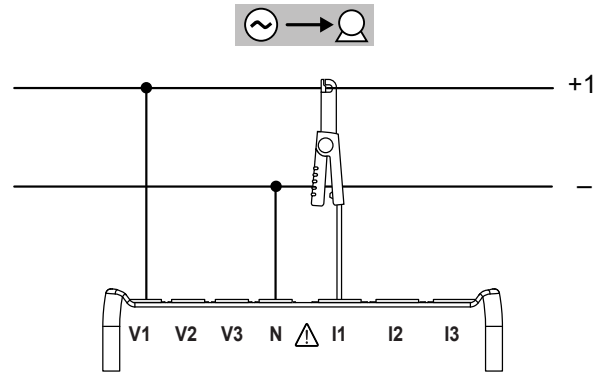

Figure 26

3.6.6.2 DC 3-Wire

For DC 3- Wire measurements:

- Connect the terminal N test lead to the common conductor
- Connect the terminal V1 test lead to conductor +1
- Connect the terminal V2 test lead to conductor +2
- Connect the terminal I1 current probe to conductor +1
- Connect the terminal I2 current probe to conductor +2

Ensure that the current arrow on the sensor is directed towards the load. This ensures proper measurements for power and other sign sensitive quantities.

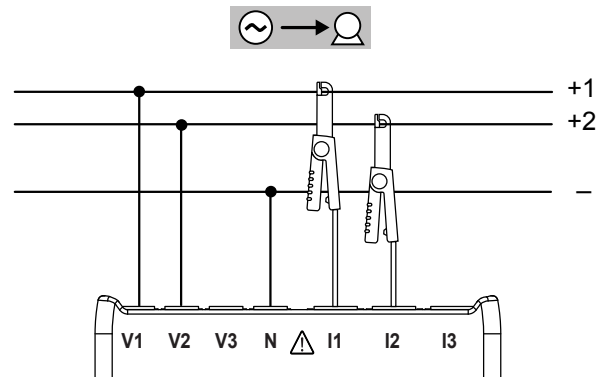

Figure 27

3.6.6.3 DC 4-Wire

For DC 4-Wire measurements and using three current sensors:

- Connect the terminal N test lead to the common conductor
- Connect the terminal V1 test lead to conductor +1
- Connect the terminal V2 test lead to conductor +2
- Connect the terminal V3 test lead to conductor +3
- Connect the terminal I1 current probe to conductor +1
- Connect the terminal I2 current probe to conductor +2
- Connect the terminal I3 current probe to conductor +3

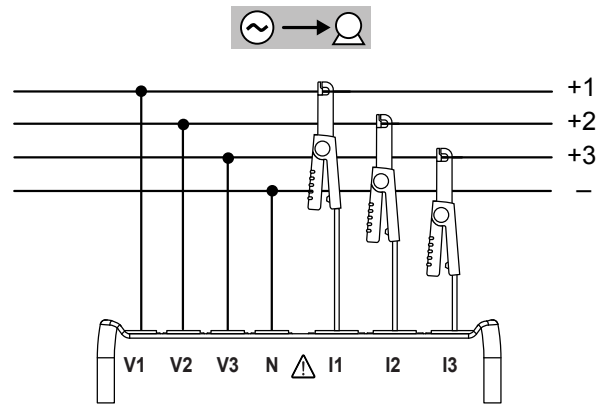



Figure 28

Ensure that the current arrow on the sensor is directed towards the load. This ensures proper measurements for power and other sign sensitive quantities.

3.7 LCD Display Modes (PEL 103 Only)

The PEL 103 includes an LCD display that allows you to view a variety of measurement values and set-up parameters. The display also lets you change several configuration settings.

 **NOTE:** Although the PEL 103 LCD display allows you to enter a limited number of set-up values, the PEL can only be fully configured through the PEL Control Panel (DataView® software). Note that the PEL 102 can only be configured with the PEL Control Panel. For detailed instructions on configuring, recording and downloading measurements, refer to § 4.

The ◀ and ▶ navigation buttons are used to scroll through the available modes LCD Display modes.

Five of these modes allow you to view several types of data:

 **(Base Measurements)** displays the measurement values V, A, Power, Frequency, Power Factor, and Target Angle

 **(Energy)** displays the energy values kWh, Vah, and Varh

 **(Harmonics)** displays harmonics for current and voltage

 **(Max)** displays the maximum values for the measurement, energy, and harmonic values

 **(Information)** displays hook-up and system information

In addition:

 **(Configuration)** allows you to enter several setup parameters, described later in this section.

3.7.1 Base Measurements - Displayed Values

The base measurements, or instantaneous readings, are displayed sequentially in screens showing all phases. The display sequence varies per type of power network. Table 4 shows the readings per network.

To navigate through the displays, use the **Navigation**  and **Enter**  buttons.

- Use the up and down arrows (▲ or ▼) on the **Navigation** button to step through the displays.
- Use the **Enter** button to display additional information. Note that this does not advance the display to the next step. Instead, a screen displayed by Enter can be considered a “sub step” in the display cycle.
- To exit a display called up by Enter, press the **Navigation** button once. This returns you to the previous screen; you can then use ▲ or ▼ to continue navigating through the displays.
- To exit and move to a different display mode, press ◀ or ▶ on the **Navigation** button.

 **NOTE:** In some distribution systems and steps, pressing Enter has no effect.

Table 4 displays the LCD (PEL 103) sequence for each type of hook-up. The displays on the left show an example of a 3-Phase 4-Wire network type. The Step column shows which button to use to display the step, either ▼ to display a main step or ↩ to display a “sub step” (1a, 2a, and so on).

Step	1-Phase 2-Wire	DC 2-Wire	1-Phase 3-Wire	DC 3-Wire	3-Phase 3-Wire ⁽¹⁾	3-Phase 3-Wire Balanced	3-Phase 4-Wire (3P-4WY; 3P-4WY2)	3-phase 4-wire Δ (3P-4WΔ; 3P-4W0Δ)	3-Phase 4-Wire Balanced	DC 4-Wire
1 ↔	P I V F	P DC I DC V DC	I1 I2 F	I1 DC I2 DC	I1 I2 I3	I3 I3 I3	I1 I2 I3 «IN» IN	I1 I2 I3 «IN» IN	I1 I1 I1	I1 DC I2 DC I3 DC
1a ↩	φ (I1, V1) « V-I ANGLE»		φ (I2, I1) «I ANGLE»		φ (I2, I1) φ (I3, I2) φ (I1, I3) «I ANGLE»		φ (I2, I1) φ (I3, I2) φ (I1, I3) «I ANGLE»	φ (I2, I1) φ (I3, I2) φ (I1, I3) «I ANGLE»		
2 ▼	P Q S «PF» PF		V1 V2 U12	V1 DC V2 DC	U12 U23 U31 F	U12 U12 U12 F	V1 V2 V3	V1 - V3	V1 V1 V1	V1 DC V2 DC V3 DC
2a ↩			φ (V2, V1) «V ANGLE»		φ (U31, U 23) φ (U12, U31) φ (U23, U12) «U ANGLE»		φ (V2, V1) φ (V3, V2) φ (V1, V3) «V ANGLE»	- - φ (V1, V3) «V ANGLE»		
3 ▼	P Q S «TAN» TAN		P Q S «<<PF>> PF	P DC	P Q S «PF» PF	P Q S «PF» PF	U12 U23 U31 F	U12 U23 U31 F	U12 U23 U31 F	P DC
3a ↩			φ (I1, V1) φ (I2, V2) «V-I ANGLE»		φ (I1, U12) φ (I2, U23) φ (I3, U31) «U-I ANGLE»	φ (I3, U12) «U-I ANGLE»	φ (U31, U23) φ (U12, U31) φ (U23, U12) «U ANGLE»	φ (U31, U23) φ (U12, U31) φ (U23, U12) «U ANGLE»		

4 ▼			P Q S «TAN» TAN		P Q S «TAN» TAN	P Q S «TAN» TAN	P Q S «PF» PF	P Q S «PF» PF	P Q S «PF» PF	
4a 							$\phi (I1, V1)$ $\phi (I2, V2)$ $\phi (I3, V3)$ «V-I ANGLE»	$\phi (I1, V1)$ - $\phi (I3, V3)$ «V-I ANGLE»	$\phi (I1, V1)$ «V-I ANGLE»	
5 ▼							P Q S «TAN» TAN	P Q S «TAN» TAN	P Q S «TAN» TAN	

Table 4

Note « ... » = displayed text

* 3-Phase 3-Wire includes:

- 3-Phase 3-Wire Δ (with 2 current sensors)
- 3-Phase 3-Wire Δ (with 3 current sensors)
- 3-Phase 3-Wire Open Δ (with 2 current sensors)
- 3-Phase 3-Wire Open Δ (with 3 current sensors]
- 3-Phase 3-Wire Y (with 2 current sensors)
- 3-Phase 3-Wire Y (with 3 current sensors]

3.7.2 Energy - Displayed Values W

The PEL measures the typical energy readings used. In addition, it enables advanced measurements for specialists or individuals doing in-depth analysis.

Individual power magnitudes for Power Flow Quadrants (per IEC 62053-23) are available by simply scrolling through each screen display. The values in each quadrant are often used by engineers addressing power flow issues

Energy measurements, which are time dependent (typically 10 or 15 minute integration or aggregation periods), are displayed sequentially in screens showing all phases. Table 2 shows the readings per network type.

- The down arrow ▼ scrolls downward and the up arrow ▲ scrolls upward through the displays.
- Each display is reached by pressing the down arrow ▼.

Energies are measured from the beginning of the recording session. Partial energies are the energies measured for a defined period (see §4.4.5).

- Partial Energy is reached by pressing the ← button for > 2 sec.
- To reenter the Energy setting, simply push the down arrow ▼.

Definitions:

- **P+**: Total Active Energy Imported (used by load) in kWh
- **P-**: Total Active Energy Exported (to source) in kWh
- **q1**: Active Energy Imported (by load) in Inductive Quadrant (Quadrant 1) in kvarh
- **q2**: Active Energy Exported (to source) in Capacitive Quadrant (Quadrant 2) in kvarh
- **q3**: Active Energy Exported (to source) in Inductive Quadrant (Quadrant 3) in kvarh
- **q4**: Active Energy Imported (by load) in Capacitive Quadrant (Quadrant 4) in kvarh
- **S+**: Total Apparent Energy Imported (by load) in kVAh
- **S-**: Total Apparent Energy Exported (to source) in kVAh

Typically, industrial users will focus on the following values. The other values are used for load analysis and utilities.

- **kWh**: Ep+ which is the traditional load Active Energy
- **kvarh**: Eq1 which is the traditional load Reactive Energy
- **kVAh**: Es+ which is the traditional load Apparent Energy

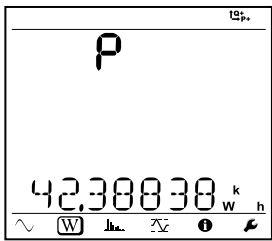
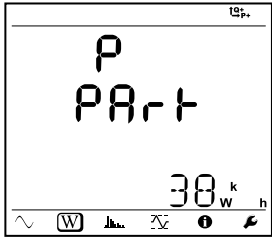
Step	Display AC	AC	DC
1 ↑ ↓		<<P>> P	<<P>> P
←			

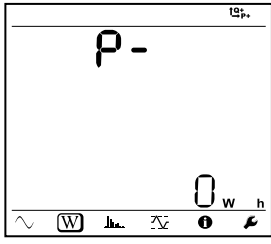
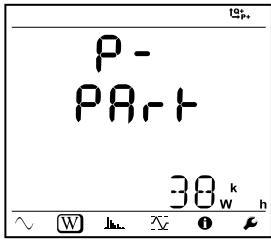
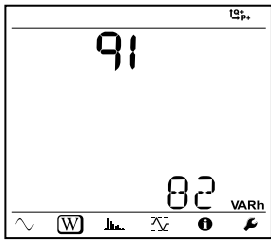
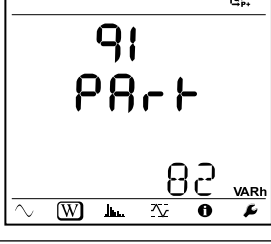
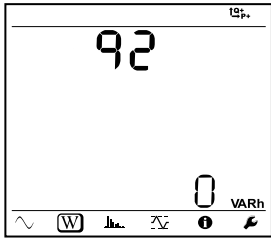
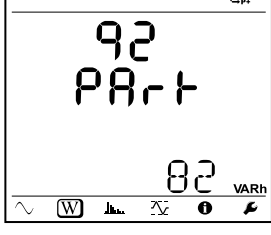
Step	Display AC	AC	DC
<p data-bbox="178 241 203 283">2</p> <p data-bbox="178 283 203 294">▼</p> <p data-bbox="162 514 219 556">↩</p>	 	<p data-bbox="803 199 893 231"><<P->></p> <p data-bbox="836 283 868 315">P-</p>	<p data-bbox="1063 199 1153 231"><<P->></p> <p data-bbox="1096 283 1128 315">P-</p>
<p data-bbox="178 766 203 808">3</p> <p data-bbox="178 808 203 819">▼</p> <p data-bbox="162 1018 219 1060">↩</p>	 	<p data-bbox="803 724 893 756"><<q1>></p> <p data-bbox="836 808 868 840">q1</p>	
<p data-bbox="178 1281 203 1323">4</p> <p data-bbox="178 1323 203 1333">▼</p> <p data-bbox="162 1533 219 1575">↩</p>	 	<p data-bbox="803 1239 893 1270"><<q2>></p> <p data-bbox="836 1323 868 1354">q2</p>	

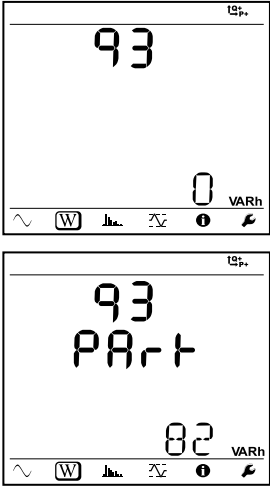
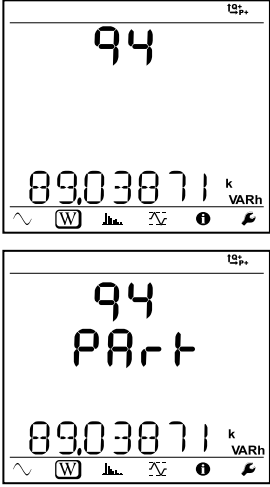
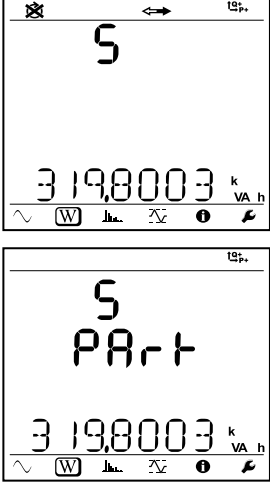
Step	Display AC	AC	DC
<p>5 ▼</p> <p>⏪</p>		<p><<q3>></p> <p>q3</p>	
<p>6 ▼</p> <p>⏪</p>		<p><<q4>></p> <p>q4</p>	
<p>7 ▼</p> <p>⏪</p>		<p><<S>></p> <p>S</p>	

Step	Display AC	AC	DC
8 ▼ ←	 	<<S->> S-	

Table 5

3.7.3 Harmonic Display Values

Table 6 displays the LCD (PEL 103) sequence for each type of hook-up.

Step	1-Phase 2-Wire	1-Phase 3-Wire	3-Phase 3-Wire ⁽¹⁾	3-Phase 3-Wire Balanced	3-Phase 4-Wire ⁽²⁾	3-Phase 4-Wire Balanced
1	THD_I THD_V <<THD I-V>>	THD_I1 THD_I2 « THD I»	THD_I1 THD_I2 THD_I3 « THD I»	THD_I3 THD_I3 THD_I3 <<THD I>>	THD_I1 THD_I2 THD_I3 « THD IN» IN	THD_I1 THD_I1 THD_I1 <<THD I>>
2		THD_V1 THD_V2 THD_U12 «THD V-U»	THD_U12 THD_U23 THD_U31 <<THD U>>	THD_U12 THD_U12 THD_U12 <<THD U>>	THD_V1 THD_V2 THD_V3 «THD V»	THD_V1 THD_V1 THD_V1 <<THD V>>

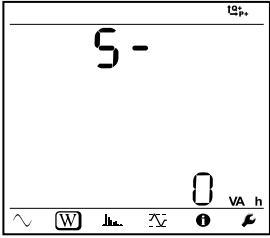
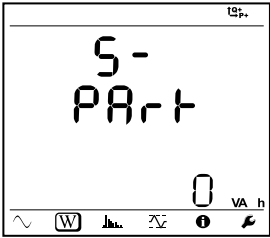
Table 6

Harmonics function is disabled in DC

(1) 3-Phase 3-Wire includes:

- 3-Phase 3-Wire Δ (with 2 current sensors)
- 3-Phase 3-Wire Δ (with 3 current sensors)
- 3-Phase 3-Wire Open Δ (with 2 current sensors)
- 3-Phase 3-Wire Open Δ (with 3 current sensors]
- 3-Phase 3-Wire Y (with 2 current sensors)
- 3-Phase 3-Wire Y (with 3 current sensors]

(2) 3-Phase 4-Wire includes:

- 3-Phase 4-Wire Y (with 3 current sensors)
- 3-Phase 4-Wire Y 2½ Element
- 3-Phase 4-Wire Δ
- 3-Phase 4-Wire Open- Δ

3.7.4 Max Display Values

Table 7 displays the LCD (PEL 103) sequence for each type of hook-up. Note that when a recording is in progress, Max is the maximum of the one second measurements during an aggregation period. This is reset either (1) when a new aggregation period starts, or (2) continuously, depending on how this setting is configured. You can also reset this value manually through the PEL Control Panel (see § 4.4.1). When no recording is in progress, Max represents the maximum of the one second measurements since the end of the last recording.

Step	1-Phase 2-Wire	DC 2-Wire	1-Phase 3-Wire	DC 3-Wire	3-Phase 3-Wire ⁽¹⁾	3-Phase 3-Wire Balanced	3-Phase 4-Wire ⁽²⁾	3-Phase 4-Wire Balanced	DC 4-Wire
1	I V	«DC Mode no max»	I1 I2	«DC Mode no max»	I1 I2 I3	I3 I3 I3	I1 I2 I3 «IN» IN	I1 I1 I1	«DC Mode no max»
2	P Q S «LOAD»		V1 V2 U12		U12 U23 U31	U12 U12 U12	V1 V2 V3	V1 V1 V1	
3	P Q S «SOURCE»		P Q S «LOAD»		P Q S «LOAD»	P Q S «LOAD»	U12 U23 U31	U12 U23 U31	
4			P Q S «SOURCE»		P Q S «SOURCE»	P Q S «SOURCE»	P Q S «LOAD»	P Q S «LOAD»	
5							P Q S «SOURCE»	P Q S «SOURCE»	

Table 7

(1) 3-Phase 3-Wire includes:

- 3-Phase 3-Wire Δ (with 2 current sensors)
- 3-Phase 3-Wire Δ (with 3 current sensors)
- 3-Phase 3-Wire Open Δ (with 2 current sensors)
- 3-Phase 3-Wire Open Δ (with 3 current sensors]
- 3-Phase 3-Wire Y (with 2 current sensors)
- 3-Phase 3-Wire Y (with 3 current sensors]

(2) 3-Phase 4-Wire includes:

- 3-Phase 4-Wire Y (with 3 current sensors)
- 3-Phase 4-Wire Y 2½ Element
- 3-Phase 4-Wire Δ
- 3-Phase 4-Wire Open- Δ

3.7.5 Information Display Values

This screen is disabled if three minutes elapse with no activity on the Enter or Navigation buttons. The display then returns to the Base Measurements screen.

Step	Value	Units
1	<<HOOK UP>> Distribution System Type	1P-2W = 1-phase 2-wire 1P-3W = 1-phase 3-wire 3P-3W Δ 3 = 3-phase 3-wire Δ (3 current sensors) 3P-3W Δ 2 = 3-phase 3-wire Δ (2 current sensors) 3P-3W02 = 3-phase 3-wire Open Δ (2 current sensors) 3P-3W03 = 3-phase 3-wire Open Δ (3 current sensors) 3P-3W Δ B = 3-phase 3-wire Δ balanced 3P-3WY = 3-phase 3-wire Y (3 current sensors) 3P-3WY2 = 3-phase 3-wire Y (2 current sensors) 3P-4WY = 3-phase 4-wire Y 3P-4WYB = 3-phase 4-wire Y balanced (fixed, voltage measurement) 3P-4WY2 = 3-phase 4-wire Y 2½ 3P-4W Δ = 3-phase 4-wire Δ 3P-4W0 Δ = 3-phase 4-wire Open Δ DC-2W = DC 2-wire DC-3W = DC 3-wire DC-4W = DC 4-wire
2	«PT PRIM» Primary VT	V / kV = Primary nominal voltage: 50V to 1000V
3	«PT SEC» Secondary VT	V = Secondary nominal voltage: 50V to 1000V
4	«CT PRIM» Primary CT	A / kA = Primary nominal line current for the connected sensor <ul style="list-style-type: none"> ■ For AmpFlex®: 100A, 400A, 2000A, 10 000A ■ For MN93A 5A range: 5A to 25 000A ■ For 5 A adapter box: 5A to 25 000A ■ For E3N clamp: 1A to 25 000A
5	«AGG.PERIOd» Aggregation period	Displays the aggregation period in minutes (1, 2, 3, 4, 5, 6, 10, 12, 15, 20, 30, 60)
6	Year Month Day Time	Displays the date/time
7	<<IP Addr>> IP address	Scrolling IP address

8	<<Soft>> Software Version Serial Number	1st number = DSP firmware version 2nd number = Microprocessor firmware version Scrolling serial number (a label is also pasted inside the PEL on the main board)
---	---	---

Table 8



3.7.6 Configuration (PEL 103)

The Configuration mode lets you select the distribution system (hook up), voltage ratio and primary current value, primary CT value, and aggregation period on the Model PEL 103 instrument. This screen is inactive when:

- The PEL is recording (pending or in progress).
- Configuration via the DataView PEL Control Panel is in progress.
- The button is locked through an option in the PEL Control Panel.
- Configuration is disabled by the **Control** button on the front panel.

 **NOTE:** To avoid conflicts, when the Configuration screen is displayed, configuration through the PEL Control Panel is disabled. You also cannot start a recording session with the **Control** button while the Configuration screen is displayed. If you attempt to use the **Control** button while it is locked by the PEL Control Panel, the Bluetooth ON/OFF indicator and the REC START/STOP light will flash twice simultaneously. The instrument will then continue its operation with no changes taking effect.

To change configuration settings on the Model PEL 103, enter the Configuration mode and do the following:

1. Scroll to the setting you want to change using the down arrow ▼ and up arrow ▲ buttons.
2. Press the **Enter**  button. The displayed setting will start blinking.
3. Use the **Navigation**  button to scroll through the allowable values for the setting.
4. When the desired value appears, press the **Enter** button. The setting will stop blinking.

As with the Information screen, the Configuration screen is disabled if three minutes elapse with no activity on the Enter or arrow buttons. The display then returns to the Base Measurements screen.

Step	Value	Units
1	<<HOOK UP>> Distribution System Type	1P-2W = 1-phase 2-wire 1P-3W = 1-phase 3-wire 3P-3WΔ3 = 3-phase 3-wire Δ (3 current sensors) 3P-3WΔ2 = 3-phase 3-wire Δ (2 current sensors) 3P-3W02 = 3-phase 3-wire Open Δ (2 current sensors) 3P-3W03 = 3-phase 3-wire Open Δ (3 current sensors) 3P-3WΔB = 3-phase 3-wire Δ balanced 3P-3WY = 3-phase 3-wire Y (3 current sensors) 3P-3WY2 = 3-phase 3-wire Y (2 current sensors) 3P-4WY = 3-phase 4-wire Y 3P-4WYB = 3-phase 4-wire Y balanced (fixed, voltage measurement) 3P-4WY2 = 3-phase 4-wire Y 2½ 3P-4WΔ = 3-phase 4-wire Δ 3P-4W0Δ = 3-phase 4-wire Open Δ DC-2W = DC 2-wire DC-3W = DC 3-wire DC-4W = DC 4-wire

2	«PT PRIM» Primary VT	V
3	«PT SEC» Secondary VT	V
4	«CT PRIM» Primary CT	<p>Primary nominal line current for the connected sensor. For AmpFlex: 100A, 400A, 2000A, 10,000A For MN193 5A range: 5A to 25,000A For 5A adapter box: 5A to 25,000A For BNC Adapter: 1A to 25,000A</p> <p>NOTE: This screen does not appear if no probe is connected to the PEL 103. If you want to configure the CT PRI setting in a PEL with no probes connected, you must use the DataView PEL Control Panel.</p>
5	«AGG.PERIOD» Aggregation period	Displays the aggregation period in minutes (1, 2, 3, 4, 5, 6, 10, 12, 15, 20, 30, 60)

Table 9

4. PEL CONTROL PANEL - DATAVIEW® SOFTWARE

 For contextual information on using DataView, refer to the Help Menu within the software.

4.1 Installing DataView

 **DO NOT CONNECT THE INSTRUMENT TO THE PC BEFORE INSTALLING THE SOFTWARE AND DRIVERS.**

1. Insert the USB stick into an available USB port (wait for driver to be installed).
2. If Autorun is enabled then an AutoPlay window should appear as shown.

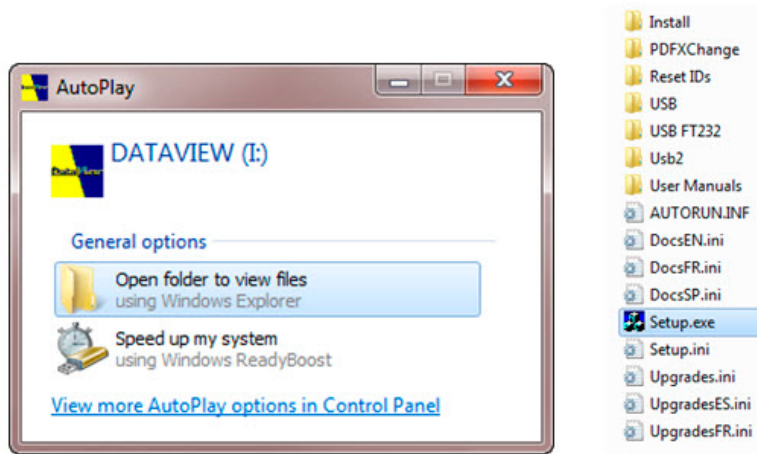



Figure 29

 **NOTE:** If Autorun is disabled, it will be necessary to open Windows Explorer, then locate and open the USB stick drive labeled "DataView" to view the files on the drive.

3. In the AutoPlay window, select "Open folder to view files".
4. Double-click on Setup.exe from the opened folder view to launch the DataView setup program.
5. A **Set-up** window, similar to the one below, will appear.

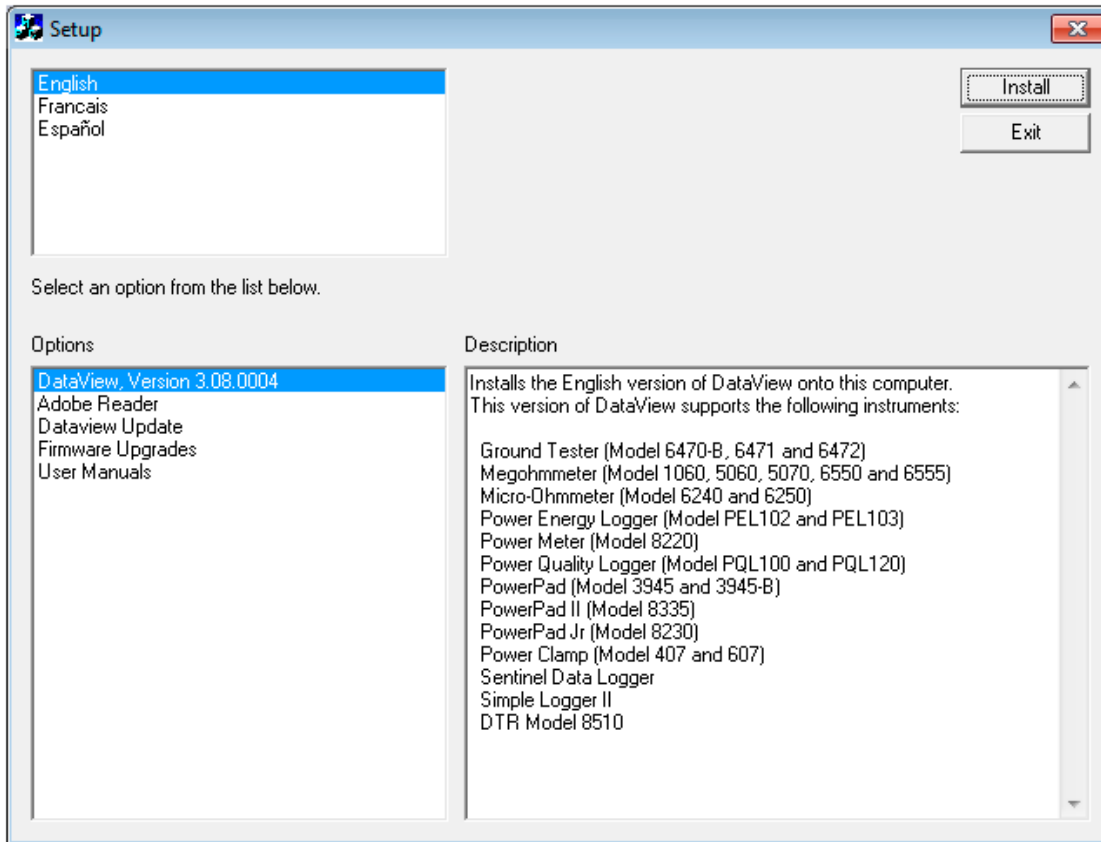

Figure 30

There are several different options to choose from. Some options^(*) require an internet connection.

- **DataView, Version x.xx.xxxx** - Installs DataView onto the PC.
 - ***Adobe Reader** - Links to the Adobe® website to download the most recent version of Adobe® Reader to the computer. Adobe® Reader is required for viewing PDF documents supplied with DataView.
 - ***DataView Updates** - Links to the online DataView software updates to check for new software version releases.
 - ***Firmware Upgrades** - Links to the online firmware updates to check for new firmware version releases.
 - **Documents** - Shows a list of instrument related documents that you can view. Adobe® Reader is required for viewing PDF documents supplied with DataView.
3. **DataView, Version x.xx.xxxx** option should be selected by default. Select the desired language and then click on **Install**.
 4. The **Installation Wizard** window will appear. Click **Next**.

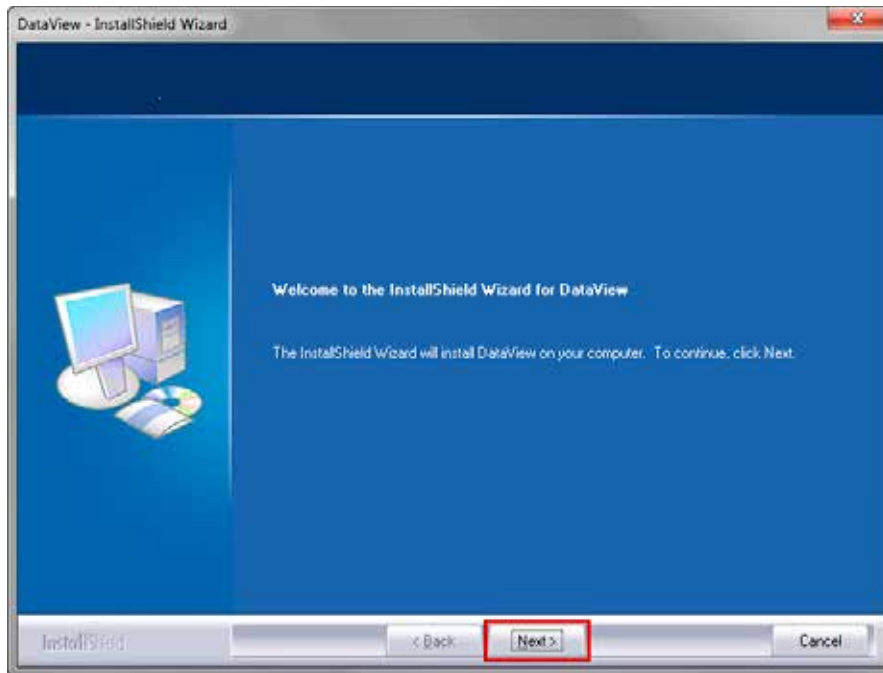

Figure 31

5. To proceed, click on the *I accept the terms of the license agreement* radio button, then click **Next**.

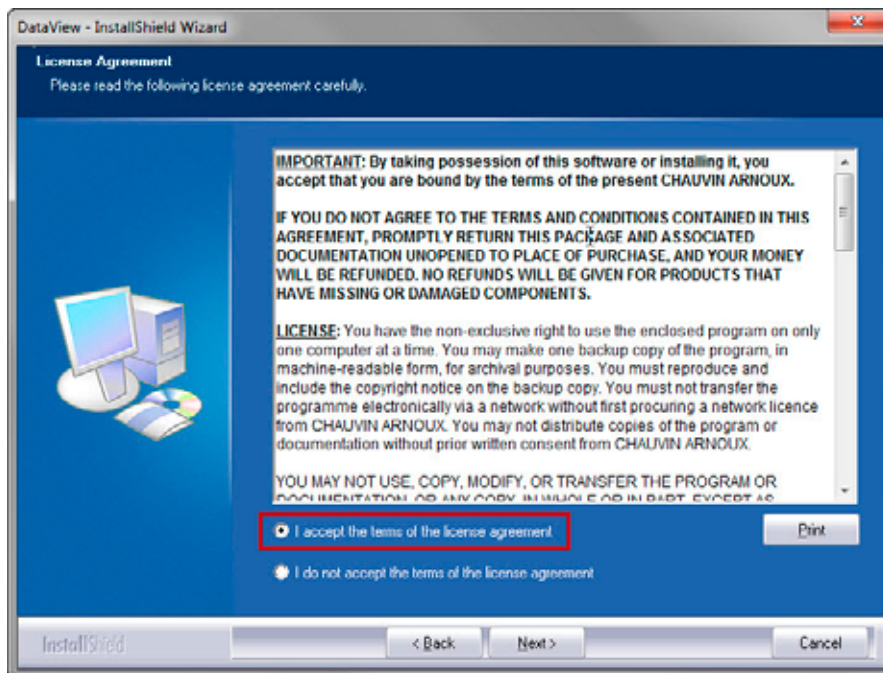

Figure 32

6. In the **Customer Information** window, enter a Name and Company, then click **Next**.

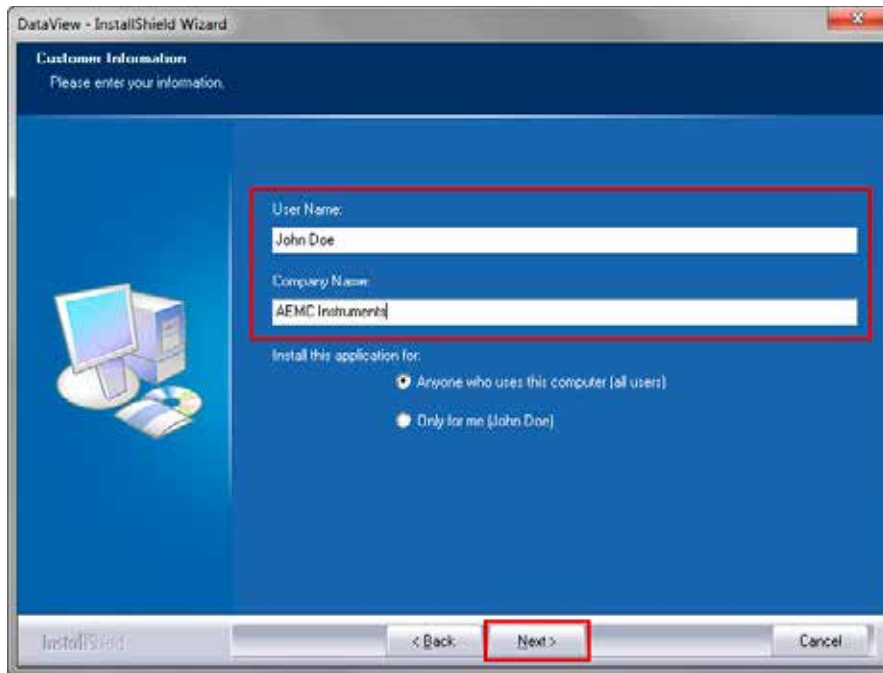

Figure 33

7. In the **Setup Type** window that appears, select the “**Complete**” radio button option, then click **Next**.

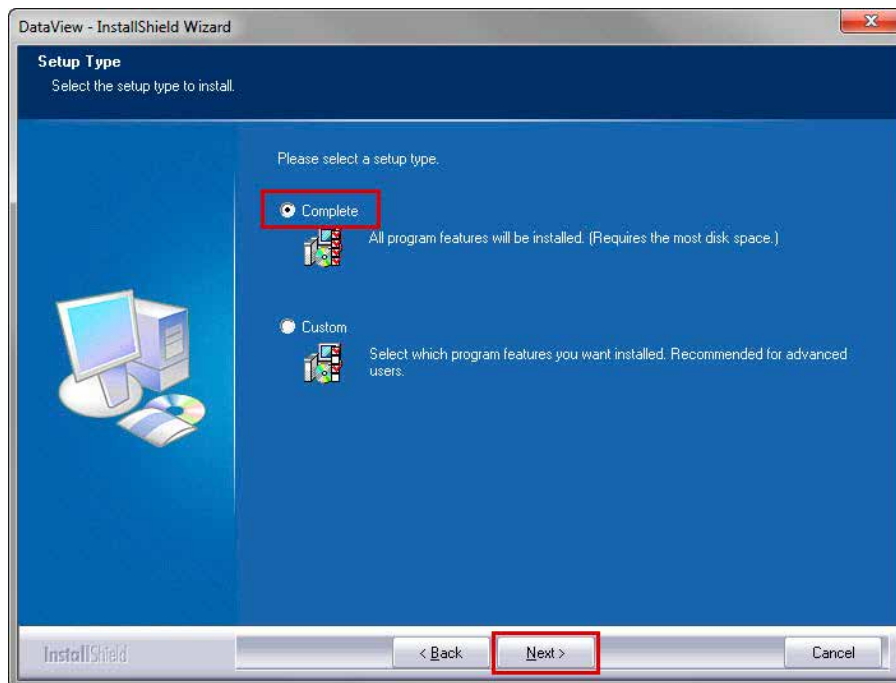

Figure 34

8. In the **Select Features** window that appears, uncheck any instrument that you do not need to install and select only the instrument control panels that you do want to install, then click **Next**.

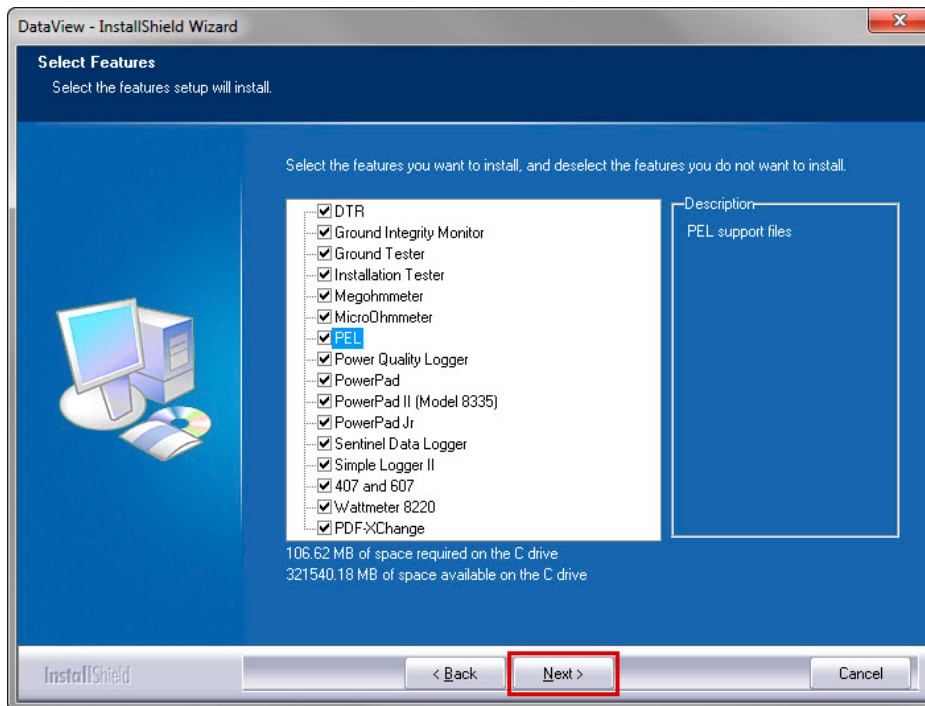



Figure 35

 The **PDF-XChange** option must be selected to be able to generate PDF reports from within DataView.

9. In the **Ready to Install the Program** window, click on **Install**.

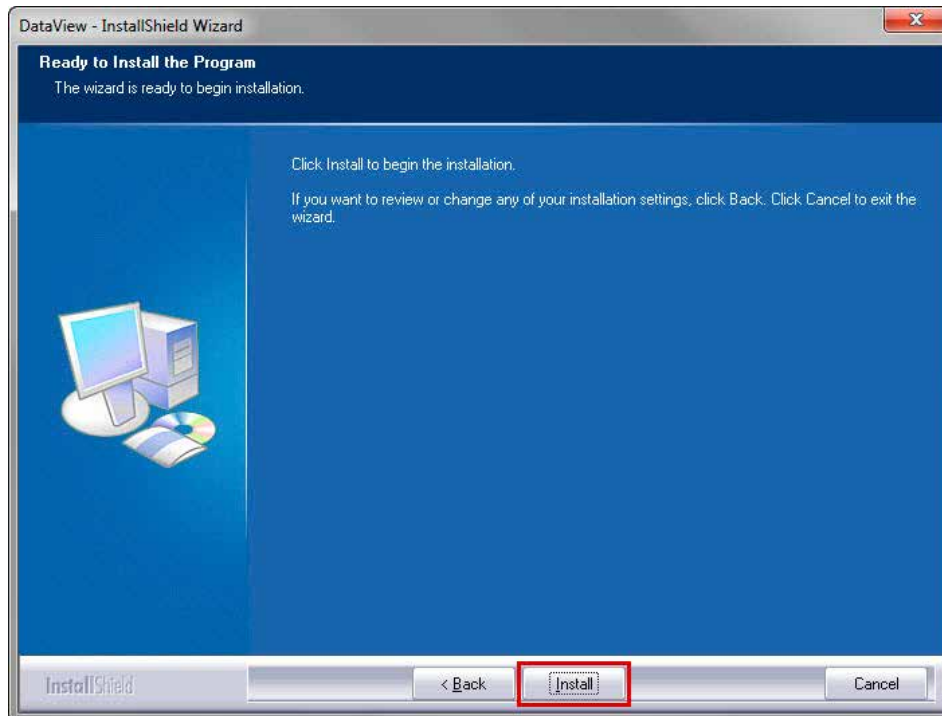

Figure 36

10. If the instrument selected for installation requires the use of a USB port, a warning box, similar to below, will appear. Click **OK**.

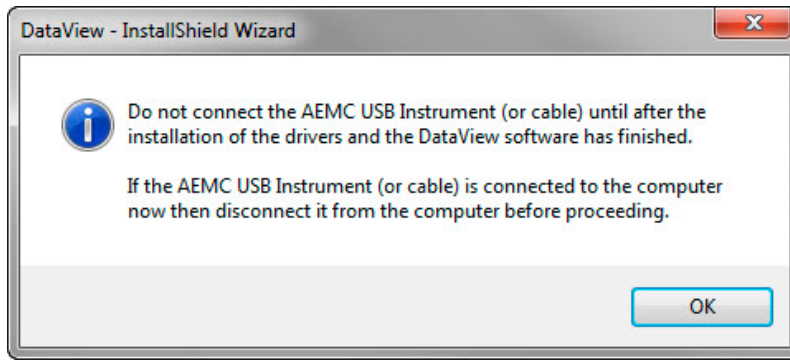



Figure 37

 The installation of the drivers may take a few moments. Windows may even indicate that it is not responding, however it is running. Please wait for it to finish.

11. When the drivers are finished installing, the **Installation Successful** dialog box will appear. Click on **OK**.
12. Next, the **Installation Wizard Complete** window will appear. Click on **Finish**.

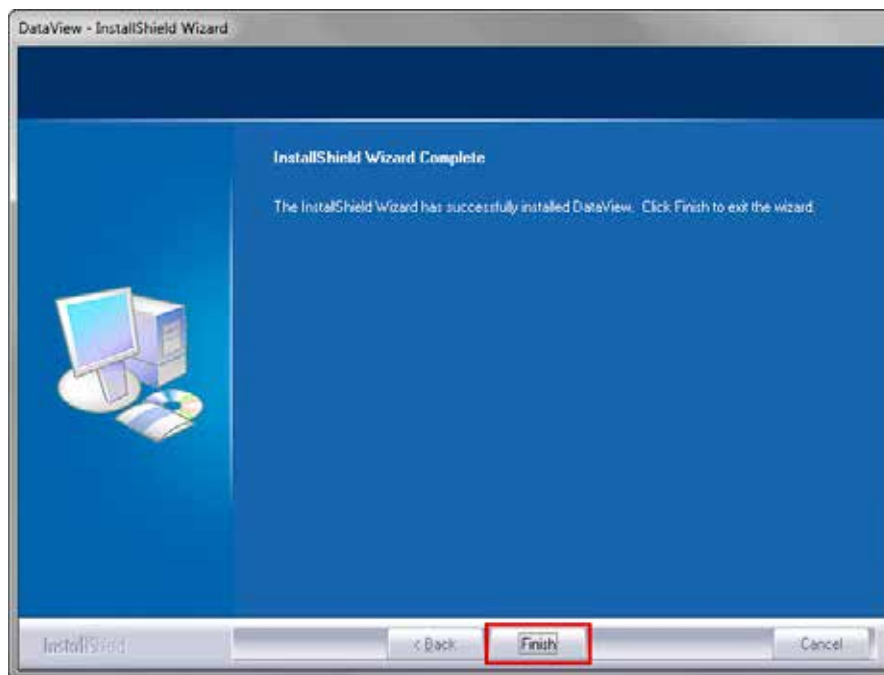



Figure 38

13. A **Question** dialog box appears next. Click **Yes** to read the procedure for connecting the instrument to the USB port on the computer.

 The Set-up window remains open. You may now select another option to download (e.g. Adobe® Reader), or close the window.

14. If necessary, restart your computer.

The DataView folder appears on your desktop. This folder contains shortcuts for DataView and each instrument control panel selected during Step 8 of the installation process.

You can now open the PEL Control Panel and connect your PEL to the computer.

4.2 Connecting to a PEL

To connect to a PEL, perform the following steps:

1. Connect the power cord to an AC outlet. The instrument will power on.
2. If you are connecting via USB, connect the supplied USB cable to the PEL and the PC. Wait for the drivers to finish installing before proceeding.
3. Open the PEL Control Panel by double-clicking the **PEL icon** , located in the DataView folder on the desktop, that was created during installation.

The Control Panel will be displayed:

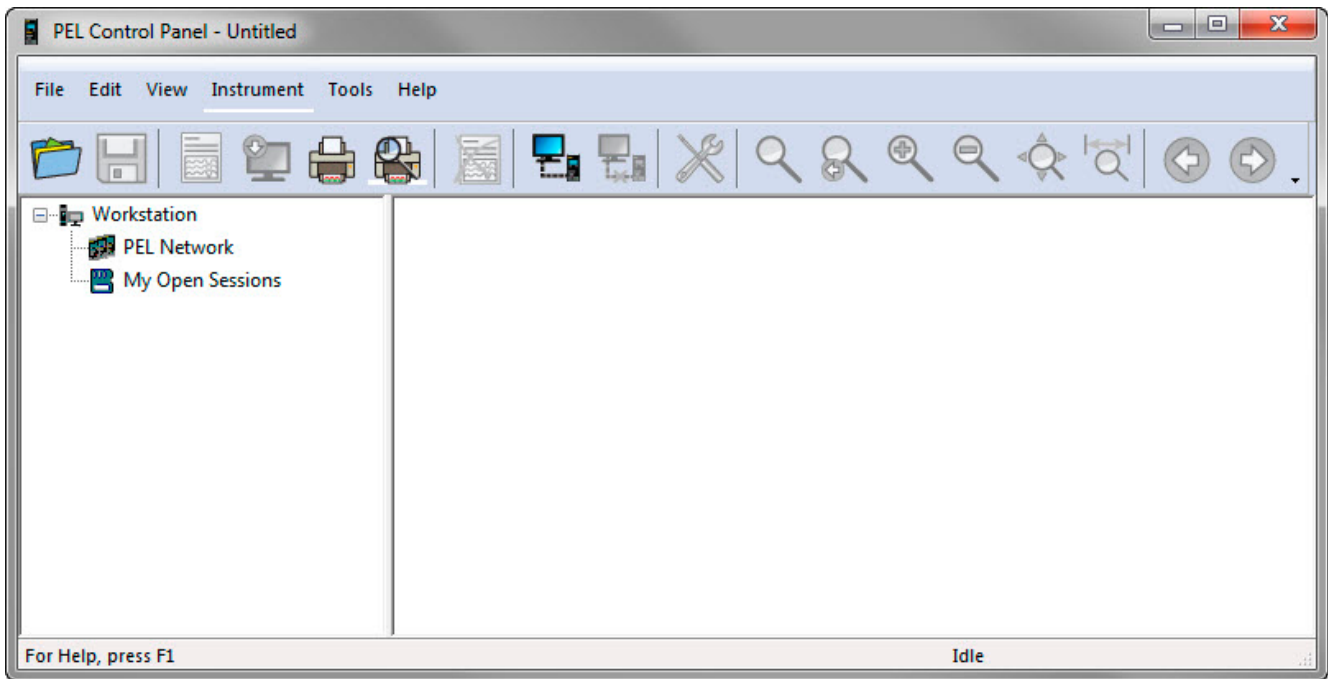

Figure 39

4. To connect to an instrument and open the **Add an Instrument Wizard** dialog box, perform one of the following:
 - From the **Instrument** menu, select **Add an Instrument**.
 - or
 - From the **Toolbar**, click on the **Add an Instrument** icon.



Figure 40



Figure 41

4.2.1 Add an Instrument Wizard

After choosing to Add an Instrument, the first dialog box of the **Add an Instrument Wizard** will be displayed:

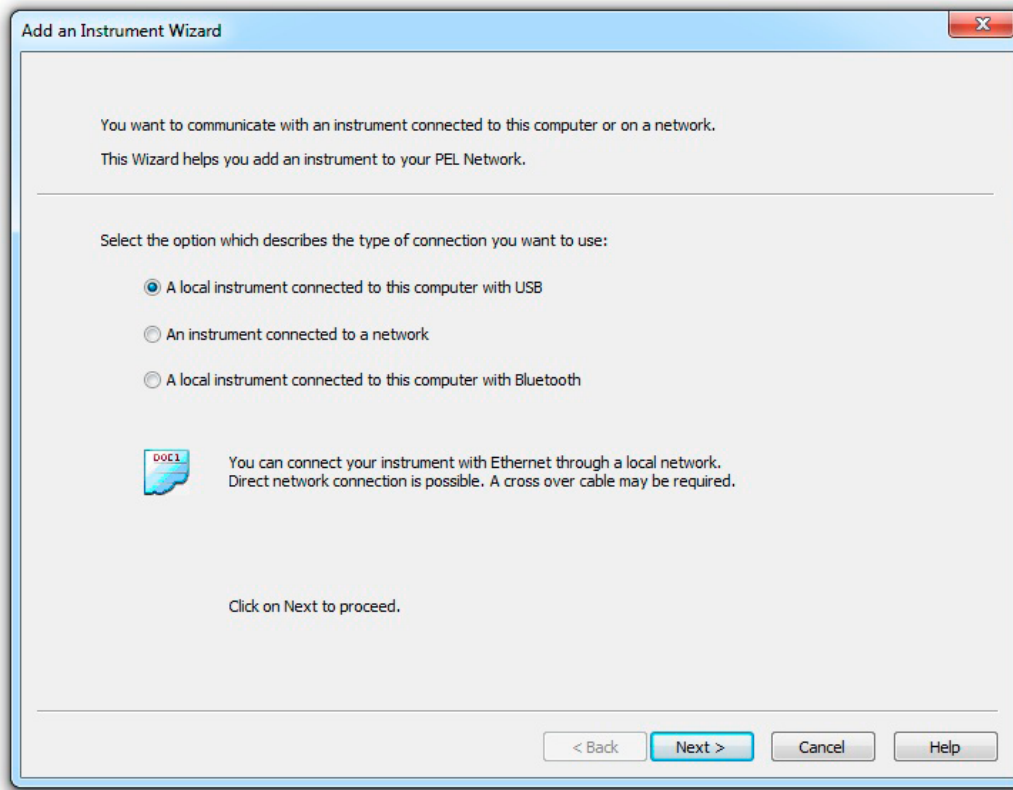

Figure 42

1. Click on the radio button associated with the desired connection type:
 - A local instrument connected to this computer with USB (see § 4.2.2)
 - A distant instrument connected to a network (see § 4.2.3)
 - A local instrument connected to this computer with Bluetooth (see § 4.2.4)



NOTE: The following dialog boxes in this section correspond to the connection type chosen in Figure 42.

4.2.2 USB Connection

i The simplest and easiest connection to establish is a USB connection and is recommended when first learning how to use the PEL and PEL Control Panel.

The USB connection dialog box will list all of the USB instruments that are currently connected to the computer. Before continuing, make sure an instrument is connected to your computer using the supplied USB cable.

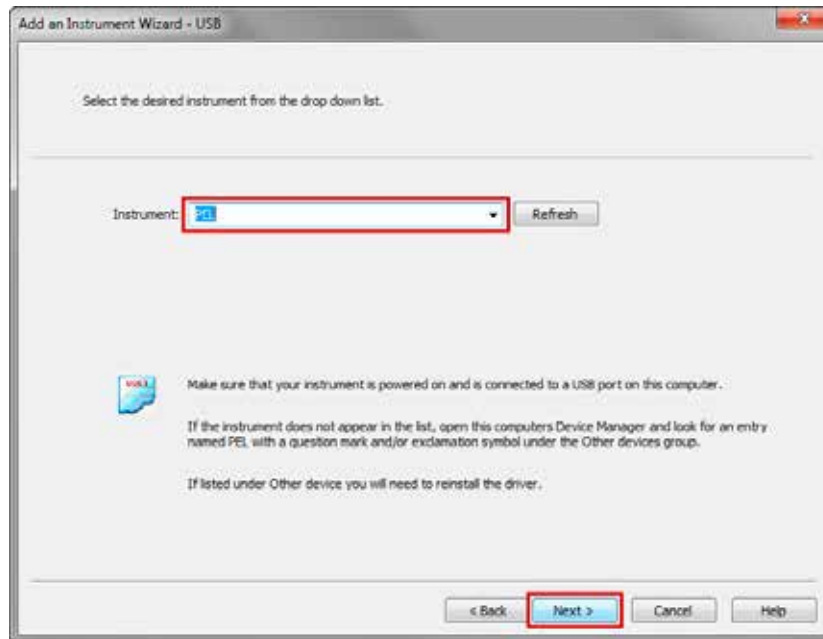

Figure 43

- From the **Instrument** drop-down list, select the desired instrument, then select the **Next** button.
- If a successful connection was established, the Finish button will be enabled. Click **Finish** to exit the Wizard.

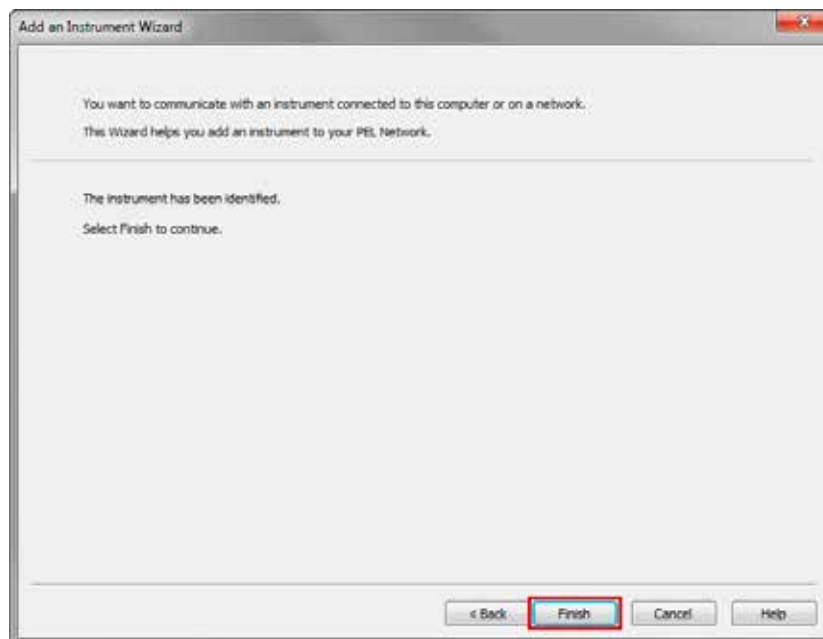

Figure 44

i **NOTE:** If a connection with the instrument cannot be established, the **Finish** button will remain disabled and the operation will need to be canceled. Verify that the instrument is connected with the desired communication medium and repeat the **Add an Instrument** process.

The instrument will then be added to the **PEL Network** until it is removed (see § 4.3.4).

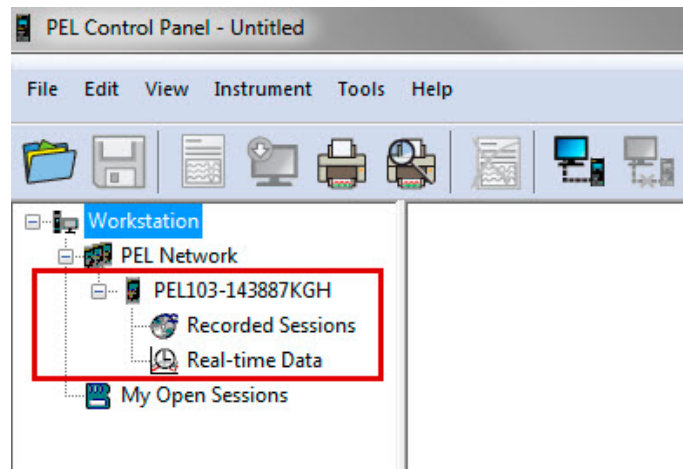



Figure 45

If the instrument is already in the **PEL Network** (either with the same connection type or a different connection type) a dialog box will be displayed indicating this condition. A PEL can be listed in the PEL Network only once.

 **NOTE:** The PEL Control Panel may become non-responsive under extreme EMC conditions. Disconnecting and reconnecting the USB cable will fix this issue.

4.2.3 Ethernet Network Connection

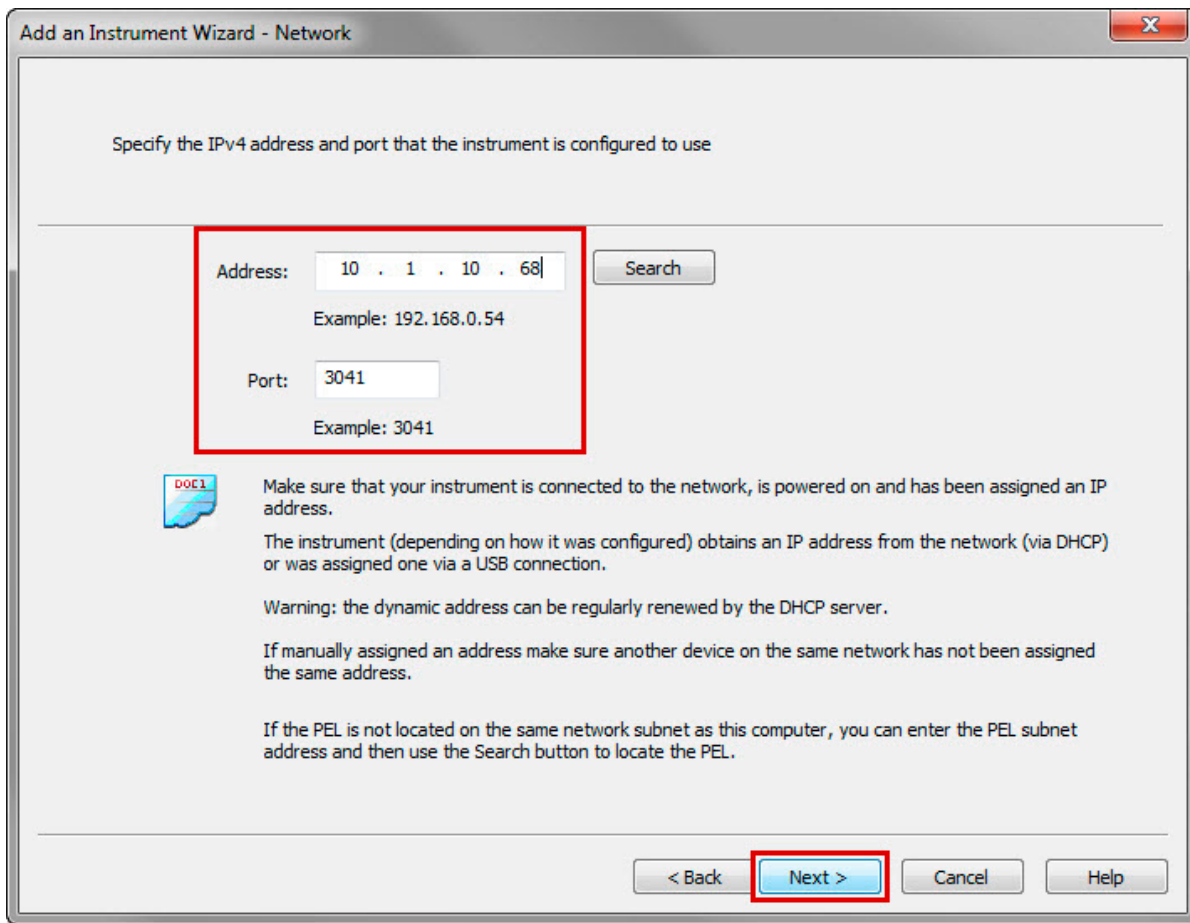

Figure 46

- In the **Address** field, specify the IP address assigned to the PEL.
 - For the PEL103, select the Info icon (**i**) on the LCD and use the ▼ button to scroll down to the **IP Addr** display screen (see § 3.7.5).
 - For the PEL102, a USB or Bluetooth connection will need to be established to determine the IP address assigned to the instrument.
- In the **Port** field, specify the port that the PEL is configured to.
 - By default the PEL uses port **3041 (UDP)**. However, the PEL can be configured to use a different port.
 - The only way to identify the port the PEL is using, is to first communicate with it. So, if the port has been changed from that of the default, use a USB or Bluetooth connection to identify the port used by the PEL.

i **NOTE:** If you do not know the IP Address and the PEL is located on the same network subnet as the computer, use the **Search** button (located to the right of the Address field) to locate the PEL. The search operation (if successful) will identify the IP address and port used by all the PEL instruments connected on the subnet.

- Once the IP address and port have been specified, click the **Next >** button.
- If a successful connection was established, the Finish button will be enabled. Click **Finish** to exit the Wizard (see Figure 44).
- The instrument will then be added to the **PEL Network** until it is removed (see § 4.3.4).

4.2.4 Bluetooth Connection

NOTE: Bluetooth must be enabled (see §4.4.2) and turned on before a Bluetooth connection can be established.

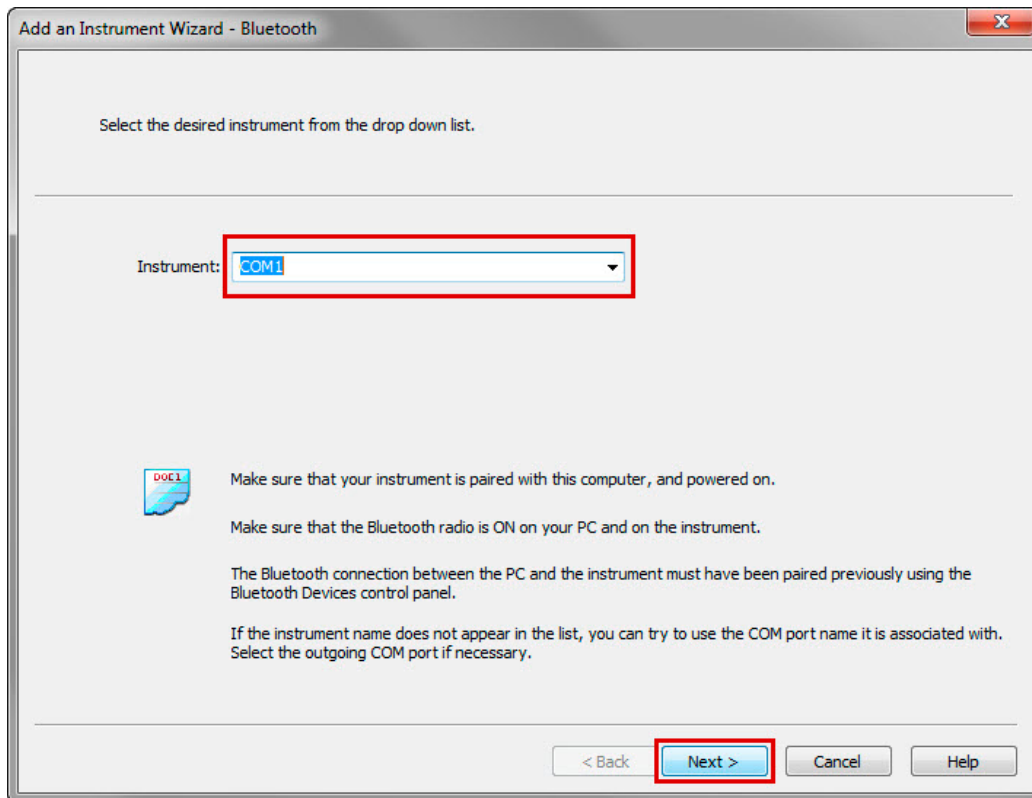

Figure 47

- From the **Instrument** drop-down list, select the desired instrument then click the **Next** button.
- If a successful connection was established, the Finish button will be enabled. Click **Finish** to exit the Wizard (see Figure 44).
- The instrument will then be added to the **PEL Network** until it is removed (see § 4.3.4).

NOTE: If the PEL cannot be identified and does not appear in the drop-down list, the communications port with which the PEL Bluetooth connection is associated will need to be selected.

To identify the associated communications port:

- Open the Bluetooth Devices dialog box. This dialog box can be displayed by double-clicking on the Bluetooth icon located on the bottom-right side of your computer screen in the taskbar.
- Double-click the PEL entry (the PEL properties dialog box will open).
- Select the Services tab. The communications port number associated with the PEL Bluetooth connection will be listed here.

When using a Bluetooth connection, make sure the Bluetooth radio in the computer and instrument is turned ON and that the PEL has been paired with the computer using the **Add a device** option in the Windows Bluetooth Devices dialog box (see § 3.5.6.1).

If the PEL is not listed in the Instrument drop-down list by name or the associated communications port, make sure the PEL is powered on, the Bluetooth radio in the PEL is on and that it is listed in the Bluetooth Devices dialog box. Also make sure that the **Enable Bluetooth** check box is checked in the Communications tabs of the **Configure Instrument** dialog box (see §4.4.2).

4.3 PEL Control Panel

4.3.1 Opening and Using the Control Panel

To open the PEL Control Panel:

- Double-click the **PEL icon**  that was created during installation, located in the DataView folder on the desktop.
- The Control Panel will be displayed. The **Control Panel** is used for instrument operation and configuration.

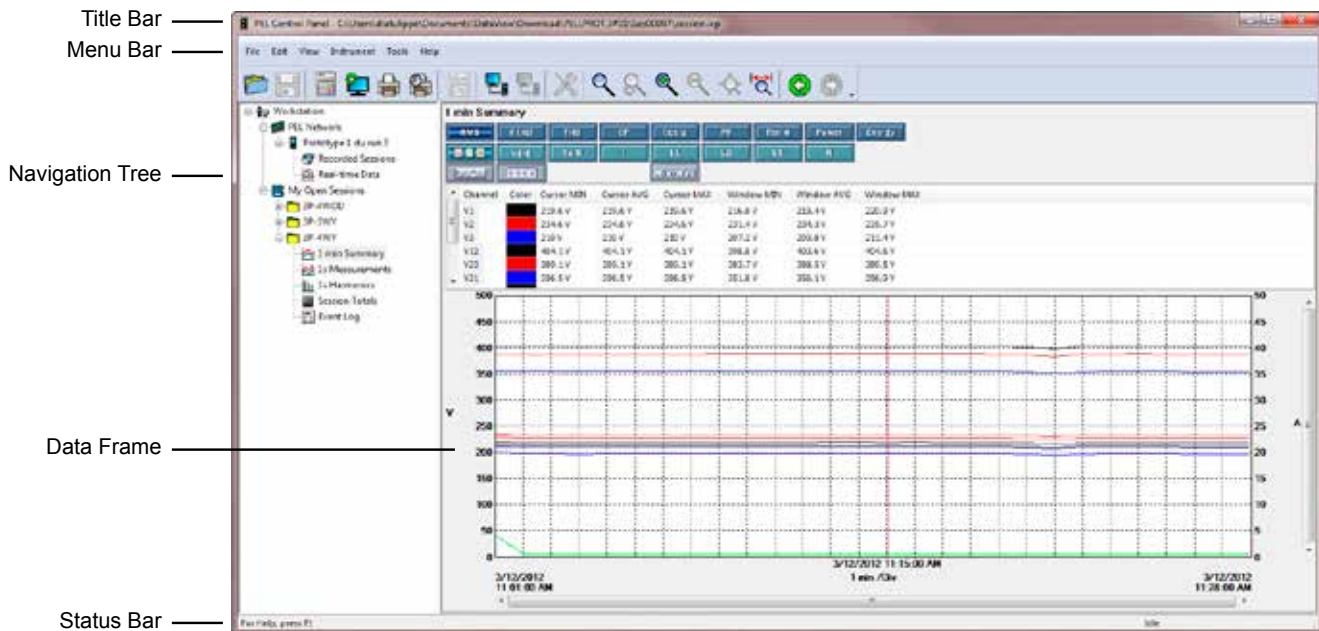

Figure 48

Using the PEL Control Panel:

- **Title Bar:** Displays the name of the application and the path to the open data file (if any).
- **Menu Bar:** Contains six drop-down menus. The top level names of these menus are File, Edit, View, Instrument, Tools and Help. Each of the items in these drop-down menus is associated with the menu top level name.
- **Navigation Tree:** Operates much like Windows Explorer does when exploring the folders on your computer. Selection of an entry in the Navigation Tree determines the information to be displayed in the data frame to the right.
- **Status Bar:** Displays a single line of help information (to the left) and instrument connection status (to the right).

The Menu Bar at the top of the window lists the following commands:

File



Open File: Loads a previously saved recording session into the My Open Sessions list



Close: Closes the currently selected session.



Save: Saves the currently selected session.



Save As: Saves the currently selected session under a different name.



Create DataView Report: Generates a DataView report from the currently selected session.



Export to a Spreadsheet: Saves measurement data into an Excel spreadsheet.



Print: Prints the current data display.



Print Preview: Displays the current data display as it would look if printed.



Print Setup: Opens the Print Setup dialog box allowing you to specify print options.

Exit: Closes the control panel.

Edit



Edit Address book: Opens the session properties address book.



Edit Session Parameters: Allows you to modify various parameters associated with the selected session.



Delete 1s trend: Removes the selected 1s Measurement data from the open session.

View



Customize Toolbar: Allows you to add and remove items from the toolbar.



Zoom Tool: Changes the cursor to the Zoom tool for zooming in a graph.



Zoom Previous: Restores the zoom level of a graph to its previous state.



Zoom In: Increases the magnification level of the displayed graph.



Zoom Out: Decreases the magnification level of the displayed graph.



Zoom All: Adjusts the magnification of the displayed graph such that all the samples are displayed.



Zoom To: Allows you to specify a time period for the displayed graph.



Backwards: Navigates to the previous display.



Forwards: Navigates forward undoing a backwards operation.

Instrument



Add an Instrument: Establishes a connection with an instrument.



Remove an Instrument: Removes the selected instrument from the PEL Network.



Disconnect an Instrument: Closes the connection between the control panel and the currently selected instrument in the PEL Network.



Reconnect Instrument: Establishes a connection between the control panel and the currently selected instrument in the PEL Network.



Configure: Opens the configuration dialog box for the selected instrument.



Download Recorded Data: Displays the Download dialog box containing a list of downloaded sessions.



Set Clock: Allows you to set the clock for the currently selected instrument in the PEL Network.



Start/Stop Recording: Allows you to start a recording if the instrument is not already recording. If the instrument is recording this operation stops the recording.



Delete a Session: Removes the currently selected session in the Recorded Sessions list from the SD-Card in the associated instrument.



Status: Displays the Status information of the currently selected instrument in the PEL Network.

Tools



Colors: Opens the Display Colors dialog box allowing you to customize the colors used to display trend data.



Download Folder: Opens the Download Folder dialog allowing you to manage the contents of the download folder for each instrument.



Select Report: Opens the Templates dialog box allowing you to select the default template to be used when creating a DataView report.



Options: Opens the Options dialog box allowing you to specify default rates and various program options.

Help



Help Topics: Displays the main Control Panel help topics.



PEL Manual: Displays the user manual.



Update: Determines the latest version of software.



About: Displays the About dialog box displaying version and copyright information.

4.3.2 Modifying a Connection Type

To change or modify the connection type (e.g. from USB to LAN), select the desired PEL listed in the **PEL Network**, then select the **Modify Connection Settings** button (), located at the top of the Status area below the Toolbar.

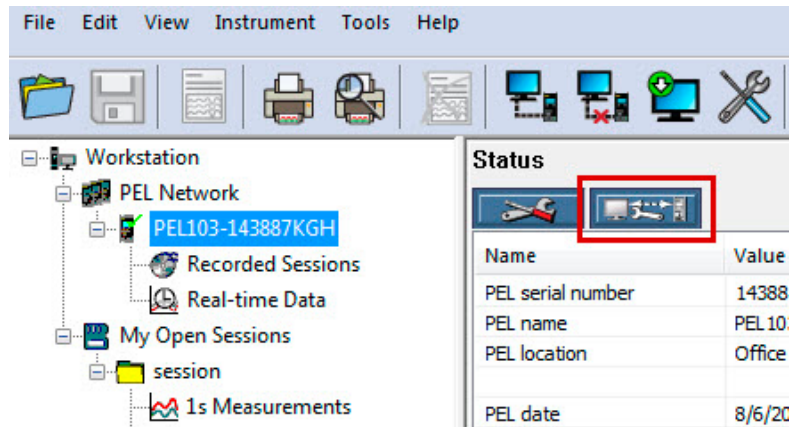

Figure 49

4.3.3 Reconnecting and Disconnecting an Instrument

Disconnecting:

To close the connection between the **PEL Control Panel** and the instrument, select the desired PEL listed in the **PEL Network**, then select **Instrument > Disconnect Instrument** in the main menu.

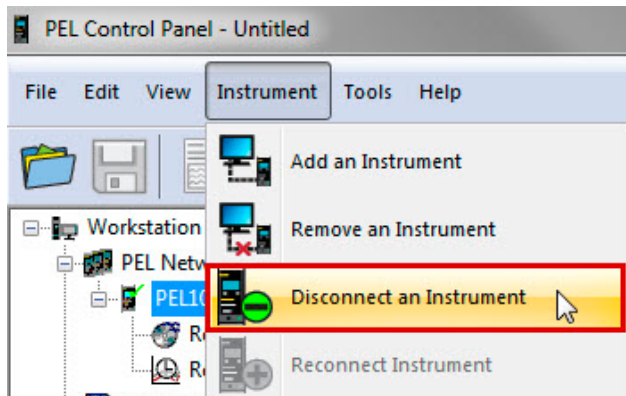

Figure 50

Reconnecting:

To reestablish a connection between the **PEL Control Panel** and the instrument, select the desired PEL listed in the **PEL Network**, then select **Instrument > Reconnect Instrument** in the main menu.

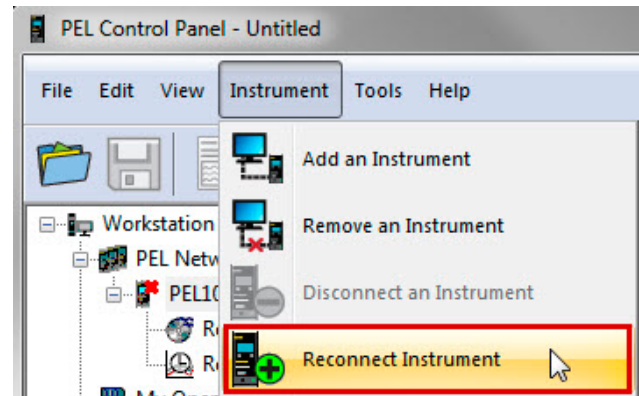

Figure 51

4.3.4 Removing an Instrument from the PEL Network

A connected instrument will remain in the PEL Network until it is removed.

- To remove an instrument, select the desired PEL listed in the **PEL Network** that you want to remove, then click on the **Remove an Instrument** icon in the Toolbar, or select **Instrument > Remove an Instrument** from the main menu.

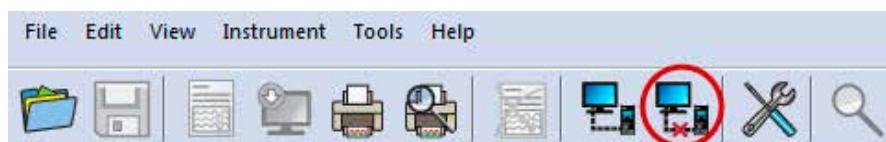



Figure 52

4.4 Configuring the PEL

1. Open the **PEL Control Panel** by double-clicking the **PEL icon**  in the DataView folder that was created during installation, located on the desktop. The Control Panel will appear.
2. Connect to an instrument (see § 4.2).
3. Open the **Configure Instrument** dialog box by performing one of the following:
 - From the **Instrument** menu, select **Configure**.
 - or
 - From the **Toolbar**, click on the **Add an Instrument** icon.

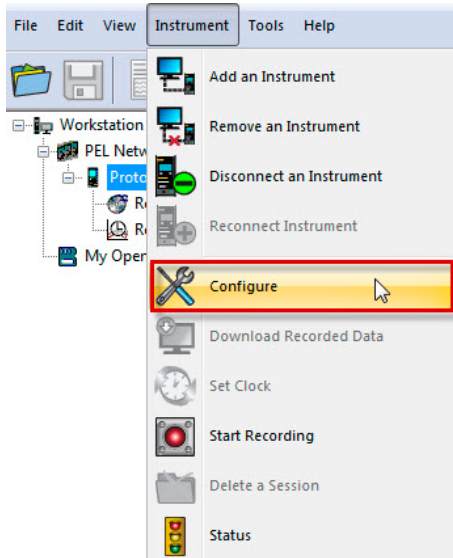

Figure 53



Figure 54

The **Configure Instrument** dialog box consists of five tabs. Each tab contains a specific set of options associated with the instrument to be configured.

 **NOTE:** Configuration of an instrument cannot be performed while a recording is in progress. If the instrument is recording, click on the Recording tab in the **Configure Instrument** dialog box, then click the **Stop Recording** button.

4.4.1 General Options

The **General** tab of the **Configure Instrument** dialog box provides information about the instrument (Model and Serial number) and allows other instrument configuration options.

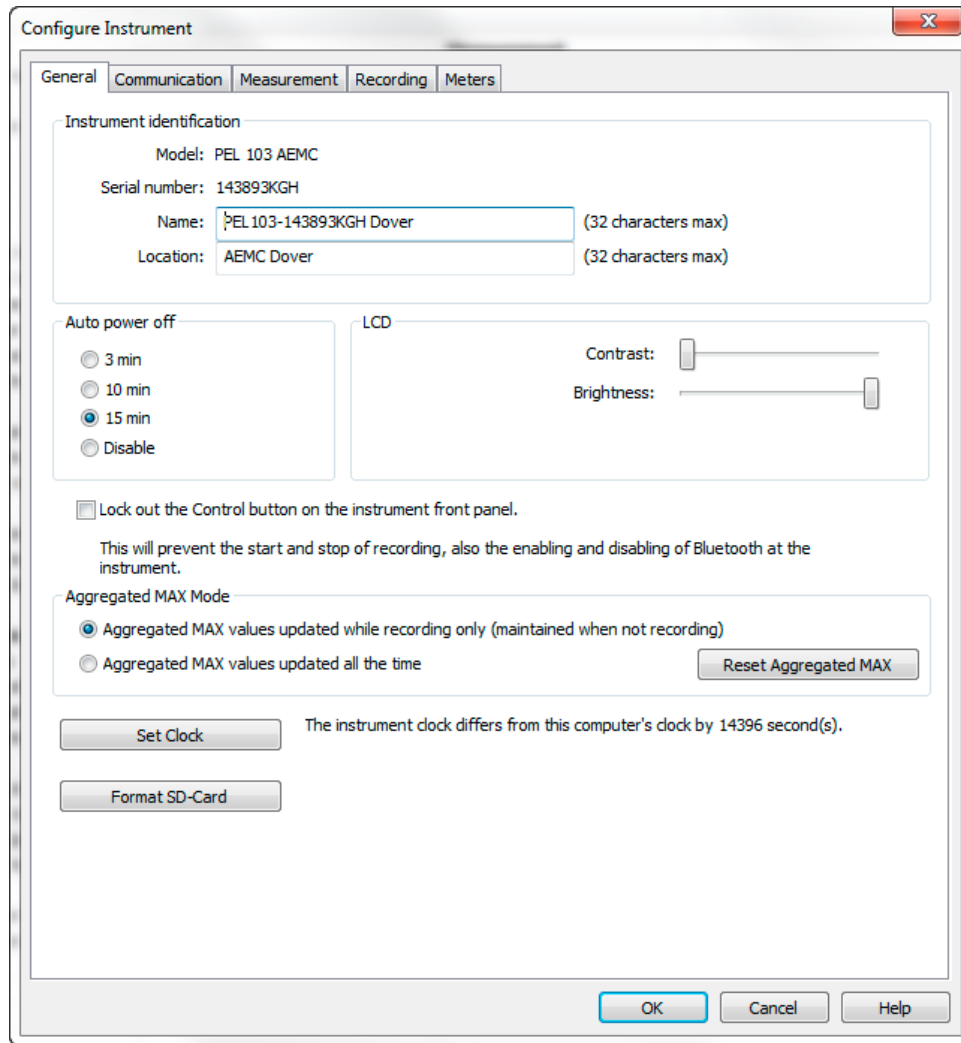

Figure 55

Instrument Identification:

- **Model:** Read only field that displays the model of the connected instrument.
- **Serial number:** Read only field that displays the unique serial number assigned to the connected instrument.
- **Name:** Field to provide the instrument's name. The instrument will be listed in the PEL Network using the name entered here. A maximum of 32 characters is allowed.
- **Location:** Optional field to provide the place/location of the instrument. A maximum of 32 characters is allowed.

Auto Power Off - Sets the automatic power down (battery saving function) to the selected interval:

- 3 min
- 10 min
- 15 min
- Disable

LCD (PEL 103):

- **Contrast:** Sets the contrast level of the instrument's LCD.
- **Normal mode brightness:** Sets the brightness level of the LCD when selecting various items to view.

Lock out the Control button on the instrument front panel:

- When checked, locks the **ON/OFF** and **Control** buttons. This can be useful to prevent unauthorized control of the instrument. Note that the **Enter** and **Navigation** buttons (PEL103) are not locked.

Aggregated MAX Mode. Aggregation is the process in which certain measured values are averaged over a specific period. The highest aggregated average for a period is listed as the MAX value in the PEL LCD display screen. This section includes two radio button options:

- **Aggregated MAX values updated while recording only (maintained when not recording)** instructs the PEL to update the aggregated MAX value only when the instrument is actively recording data. When not recording, the instrument will retain the current MAX value in its memory, but will not update it even if a higher aggregated value is encountered.
- **Aggregated MAX values updated all the time** results in the PEL continuously updating the aggregated MAX value, whether or not the instrument is actively recording.

The button **Reset Aggregated MAX** resets the current MAX value to zero. The PEL will then update the aggregated MAX value whenever the value for an aggregated period exceeds the previous high value.

In addition to these options, there are two buttons allowing additional control of the instrument:

- **Set Clock:** Displays the Date/Time dialog box for setting the date and time on the instrument.
- **Format SD-Card:** Allows the formatting of the SD memory card currently installed in the instrument.

 **NOTE:** The PEL can only operate with SD and SDHC cards that have been formatted to use the FAT32 file system and a maximum cluster size. If the card is formatted with a file system other than FAT32 and/or with a cluster size too small for the instrument to handle, an error message will be displayed. Formatting the card in the instrument will make sure that it is formatted with FAT32 and a maximum cluster size of the card.

4.4.2 Communication Options

The **Communication** tab of the **Configure Instrument** dialog box provides information about the various communication mediums supported by the instrument.

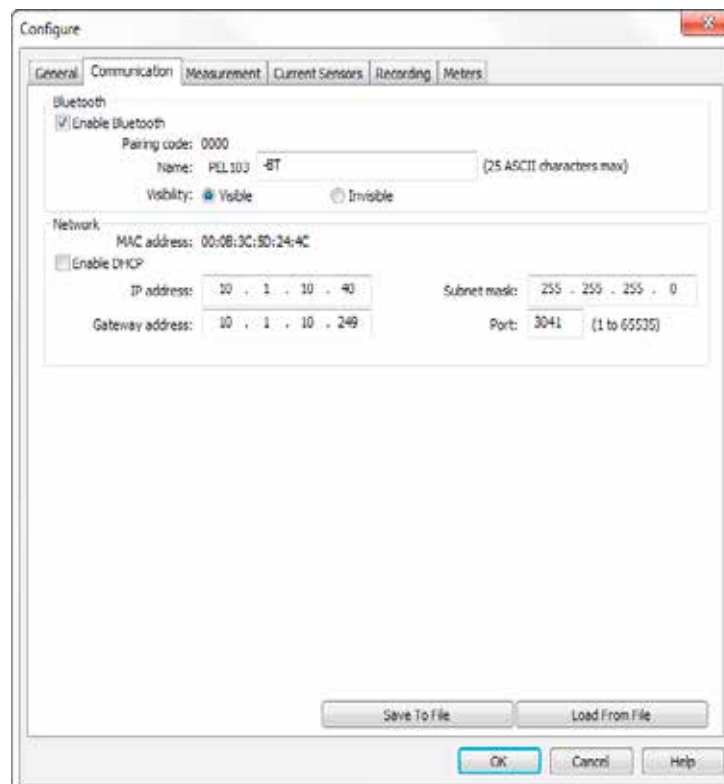

Figure 56

Bluetooth:

- **Enable Bluetooth:** When checked, enables the Bluetooth radio in the instrument.
- **Pairing code:** Displays the pairing code that must be used when pairing the instrument to a computer (the pairing code cannot be modified).
- **Name:** Field to provide the instrument's name when pairing the instrument. Only ASCII characters can be used.
- **Visibility:** Enables/Disables the presence of the instrument from the search option of computers.

USB:

- **Name:** Read only field that displays the name assigned to the USB interface. This is the name that will be displayed when adding the instrument via a USB connection.

Network:

- **MAC address:** Read only field indicating the MAC address of the network interface in the instrument. This can be used by a network administrator to assign an IP address to the instrument that is fixed via the DHCP server.
- **Enable DHCP:** When checked, a DHCP server must be available on the network. If Enable DHCP is checked but the DHCP server is not available, after 60 seconds the PEL Control Panel will enter auto-IP mode, using the default IP address 169.254.0.100. Note that if enabled, the IP address assigned to the instrument can change periodically (unless special consideration has been made by a network administrator).
- **IP address:** When DHCP is enabled, this field is read only and displays the IP address the instrument obtains from the DHCP server. When the DHCP option is disabled, the IP address must be specified.
- **Gateway address:** When DHCP is enabled, this field is read only and displays the Gateway address the instrument obtained from the DHCP server. When DHCP is disabled, you must enter the Gateway address you want the instrument to use.
- **Subnet mask:** When DHCP is enabled, this field is read only and displays the Subnet mask the instrument obtained from the DHCP server. When the DHCP option is disabled, enter the Subnet mask you want the instrument to use.

Bluetooth/Network password:

- **Enable password protection:** When checked, requires the user to enter a password when trying to configure the instrument over a network (UDP) and Bluetooth connections.
- **Password:** Field to specify the password to be used (up to 16 characters in length).

4.4.3 Measurement Tab Options

The **Measurement** tab of the **Configure Instrument** dialog box specifies the electrical distribution system, voltage ratios, nominal frequency and current probe options.

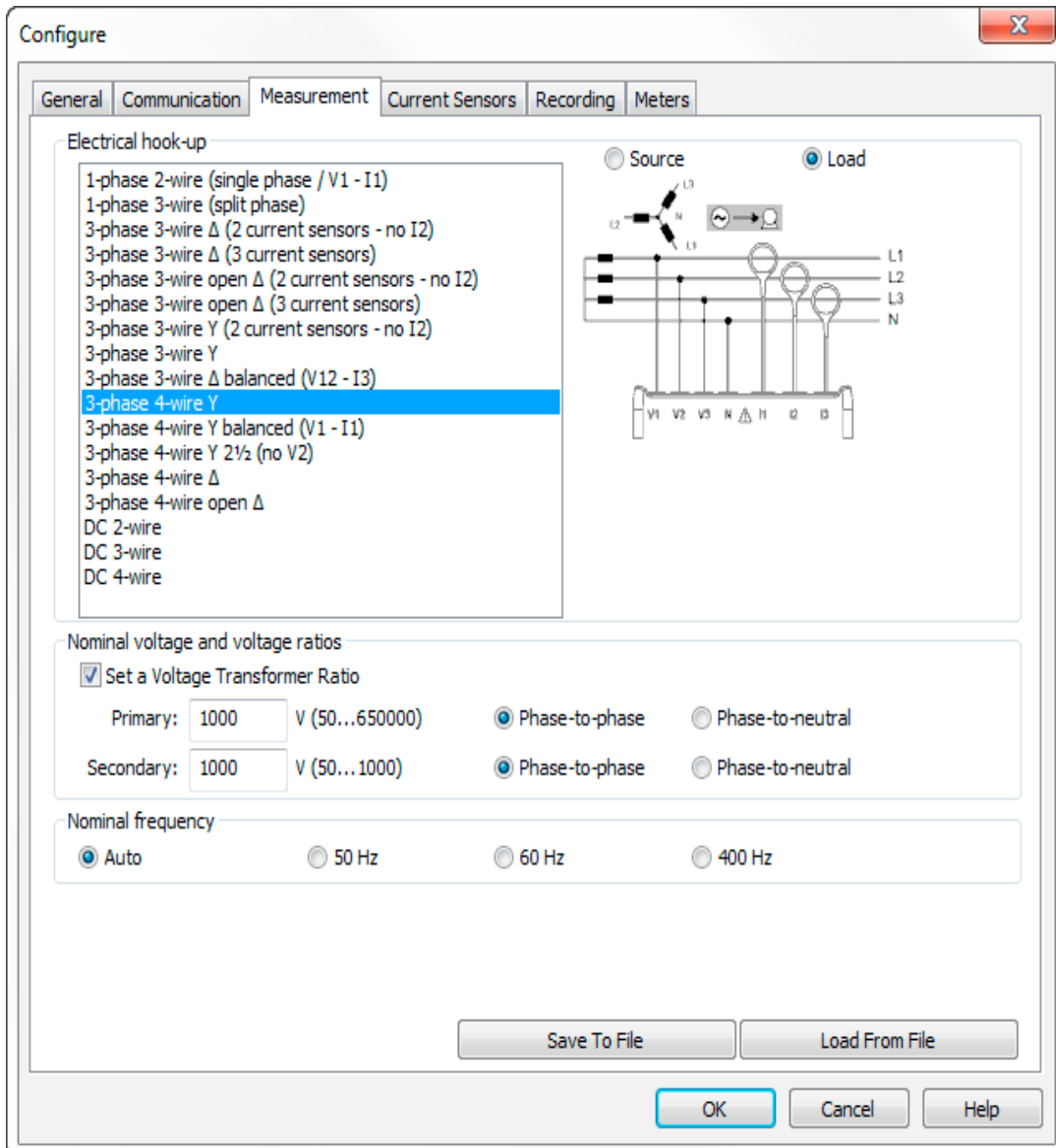

Figure 57

Distribution system:

- A box listing each of the distribution systems supported by the instrument (see §3.6 for available distribution systems descriptions).
- An image is displayed to the right of the list illustrating the connection diagram for the selected distribution system.

Selection of DC 2-, 3- or 4-Wire implies DC measurements only. Selection of other distribution systems implies AC measurements only.

Load/Source:

These radio buttons determine whether or not the measurement applies to the system's load or to the source. By default, Load is selected.

Nominal voltage and voltage ratio:

- **Set a Voltage Transformer Ratio:** When checked, the following fields are enabled (based on the selected distribution system):
 - **Primary:** Indicates a level on the primary side of the isolation transformer.
 - **Secondary:** Indicates a level on the secondary side of the isolation transformer.

The ratio between the specified primary and secondary will be used by the instrument for all related calculations.

- **Phase-to-phase and Phase-to-neutral:** Select either Phase-to-phase or Phase-to-neutral, depending on the selected distribution system, for each of the Primary and Secondary values. Note that some systems only allow one option.

The PEL 103 LCD will display a phase-to-phase voltage for secondary voltage if primary voltage is phase-to-phase and a phase-to-neutral voltage for secondary voltage if primary voltage is phase-to-neutral.

 **NOTE:** When no ratio is entered, 1000V primary and secondary voltages are displayed on the PEL 103 LCD.

Voltage Transformer Ratios

Parameter		Range	Increment
Primary Voltage	PV	50 to 650,000V	1V
Secondary Voltage	SV	50 to 1000V	1V

Table 10

VLOW (the value below which the line-to-neutral voltage is set to zero), is 2V, and is multiplied by $\sqrt{3}$ for phase-to-phase voltages.

Nominal frequency: Specifies the default frequency of the distribution network.

- **Auto:** Instructs the instrument to automatically identify the nominal frequency of the network.
- **50Hz, 60Hz and 400Hz:** The instrument will use the selected frequency for measurements.

 **NOTE:** Auto mode may lead to inconsistencies if the frequency varies on an unstable distribution system.

4.4.4 Current Sensors and Ratios

Current sensor ratios (and type) are automatically set with the identification of the current sensor detected on channel 1, or channel 2 if current sensor on channel 1 is missing, or channel 3 if current sensor on channel 1 and channel 2 are missing.

 **NOTE:** One type is allowed for the current sensor inputs. If different current sensors are mated (mismatch of current sensors), only the type of the current sensor connected on I1 is used for current sensor selection.

See § 5.2.4 for detailed specification of the current sensors.

- **AmpFlex®/MiniFlex®**
 - **Range:** Four ranges are available for the for AmpFlex®/MiniFlex® probes - 100A, 400A, 2000A and 10000A.
 - **Number of primary wraps:** Allows the sensor cable to be wrapped around the conductor multiple times to increase the sensitivity of the probe. Specify the number of times the sensor is “wrapped” around the conductor. The maximum current of the selected AmpFlex®/MiniFlex® range is divided by the number of wraps.
- **MN193 for 5A:**
 - **An external CT is used:** Check box that enables or disables a ratio for this probe. When enabled, the following options can be specified.
 - **Primary:** Indicates the primary current of the CT.
 - **Secondary:** Indicates the secondary current of the CT for the specified Primary current. The Primary

and Secondary values establish a ratio used by the instrument when the probe is connected to the instrument.

■ **5A Adapter Box:**

- **An external CT is used:** Check box that enables or disables a ratio for this probe. When enabled, the following options can be specified.
 - **Primary:** Indicates the primary current of the CT.
 - **Secondary:** Indicates the secondary current of the CT for the specified Primary current. The Primary and Secondary values establish a ratio used by the instrument when the probe is connected to the instrument.

■ **Current Sensor with BNC Adapter:**

- **Nominal current:** Indicates the current to be associated with the output voltage.
- **Output voltage:** Voltage that is applied to the BNC connector of the adapter for the specified Nominal current.

 **WARNING:** The potential of the internal conductors of the BNC adapter is held at the potential of the neutral terminal of the PEL. If the neutral terminal is accidentally connected to a phase voltage, the current sensor connected to the PEL via the BNC adapter can be held at the phase voltage. To prevent electric shocks or short-circuit hazards, always use current probes **fully** complying with IEC 61010-2-032.

Current Sensor		I nominal	CT ratio	Default detection thresholds ILOW
MR193		1000ADC	-	1A
SR193		1000AAC	-	500mA
J93		3500AAC/5000ADC	-	5A (0A in DC)
AmpFlex®		10000AAC	Primary turns	5A
		2000AAC	Primary turns	1A
		400AAC	Primary turns	200mA
		100AAC	Primary turns	50mA
MiniFlex®		10000AAC	Primary turns	5A
		2000AAC	Primary turns	1A
		400AAC	Primary turns	200mA
		100AAC	Primary turns	50mA
SL261 (BNC adapter)	Range 100mV/A	10ADC	-	50mA
	Range 10mV/A	100ADC	-	50mA
MN93		200AAC	-	100mA
MN193	Range 100A	100AAC	-	50mA
	Range 5A	5AAC	CT ratio	2.5mA
5A adapter		5AAC	CT ratio	2.5mA

Table 11

- Ranges for AmpFlex® and MiniFlex® are selected by the user with DataView® software (setup mode).
- ILOW, threshold at which the current measurement is zeroed.
- 1 to 3 turns can be set for MiniFlex® and AmpFlex®.
- Additional current ratio can be set for MN193 current sensors and 5A adapters (see Table 12).

 **NOTE:** When no ratio is entered, I nominal current is displayed on the PEL103 LCD (as primary current). No secondary current is displayed.

Current Transformer Ratios

Parameter		Range	Increment
Primary Current	PC	5 to 25,000A	1A
Secondary Current	SC	5A	–

Table 12

NOTE: The following conditions shall be fulfilled or the configuration will be rejected by the PEL Control Panel software:

- VT primary nominal voltage > VT secondary nominal voltage
- VT primary nominal voltage x CT primary nominal current < 650 MVA

4.4.5 Recording Tab Options

The **Recording** tab of the **Configure Instrument** dialog box specifies various recording related options.

The screenshot shows the 'Configure Instrument' dialog box with the 'Recording' tab selected. The 'Session' section has a name 'DCtest' (40 characters max). The 'Recording period' section has 'Record now' selected, a duration of '48 hours', and start/end dates of '10/16/2013' and '10/18/2013' respectively, with start/end times of '6:41:28 AM'. A 'Reset Start Date/Time' button is present. The 'Trends demand interval' section has a 'Demand period' of '1 min' and a note 'The aggregation starts at rounded hours'. The 'Recording options' section has 'Record one second trends for current, voltage, energy, power factor, THD, ...' checked, and 'Record individual harmonics (to the 50th) for current and voltage' unchecked. Below this, it states: 'The maximum recommended recording duration for proper SD-Card operation is: - one week with aggregated values, 1s trends and 1s harmonics, - one month with aggregated values and 1s trends (no 1s harmonics), - one year with only aggregated values (no 1s trends and no 1s harmonics). The number of sessions on the SD-Card should not exceed 32.' The 'Installed SD-Card status' section shows a progress bar at 26.00% and text: '26.00% of the SD-Card space has been used. 1412 MB is available on the installed SD-Card. 1909 MB is the total capacity of the SD-Card.' At the bottom are 'OK', 'Cancel', and 'Help' buttons.

Figure 58

Session:

- **Name:** Field to assign a session name (40 characters max) to the recording session.

Recording period:

- **Record Now:** When checked, will start a recording when the OK button is pressed.
- **Schedule Recording:** When checked, enables a start and end date/time to be set for the recording.
- **Duration:** Drop-down list containing predefined recording times.
- **Reset Start Date/Time:** This button is enabled when the “Schedule recording” option is checked. When selected, the Start date/time is set to the current PC date/time and the End date/time to the PC date/time plus the selected Duration.
- **Stop/Cancel Recording:** This button is displayed when the instrument is actively recording or a recording is pending. It allows you to end an active recording or cancel a pending one.
- **Modify End Date/Time:** This button is displayed when the instrument is actively recording. It allows you to change the ending time of the active recording.

Trends Demand Interval:

- **Demand period:** Drop-down list that allows the selection of one of the possible demand intervals supported by the instrument. The demand interval is a period of time over which the instrument determines the average value for a given measurement parameter. In addition to the average, the 1 second maximum values (along with time stamps) are also stored. This is the interval over which the instrument performs measurement aggregation.
 - Available periods = 1, 2, 3, 4, 5, 6, 10, 12, 15, 20, 30 and 60 min

Recording options:

- **Record one second trends for current, voltage, energy...:** Allows you to specify if 1s trend data is to be recorded or not.
- **Record current and voltage harmonics (to the 50th) for current and voltage:** Check box that allows harmonic measurements to record or not record. Harmonic measurements consume a large amount of SD-Card memory and increase downloading time. If these measurements are not needed, deselect this check box to improve system performance.

Installed SD-Card status:

- Gauge indicating the percentage of the SD-Card in the instrument that has been used.
- Text detailing the usage of the SD-Card in the instrument.

4.4.6 Meters Tab Options

The **Meters** tab of the **Configure Instrument** dialog box specifies which of the instruments total accumulation meters are to be reset when the configuration is written to the instrument.

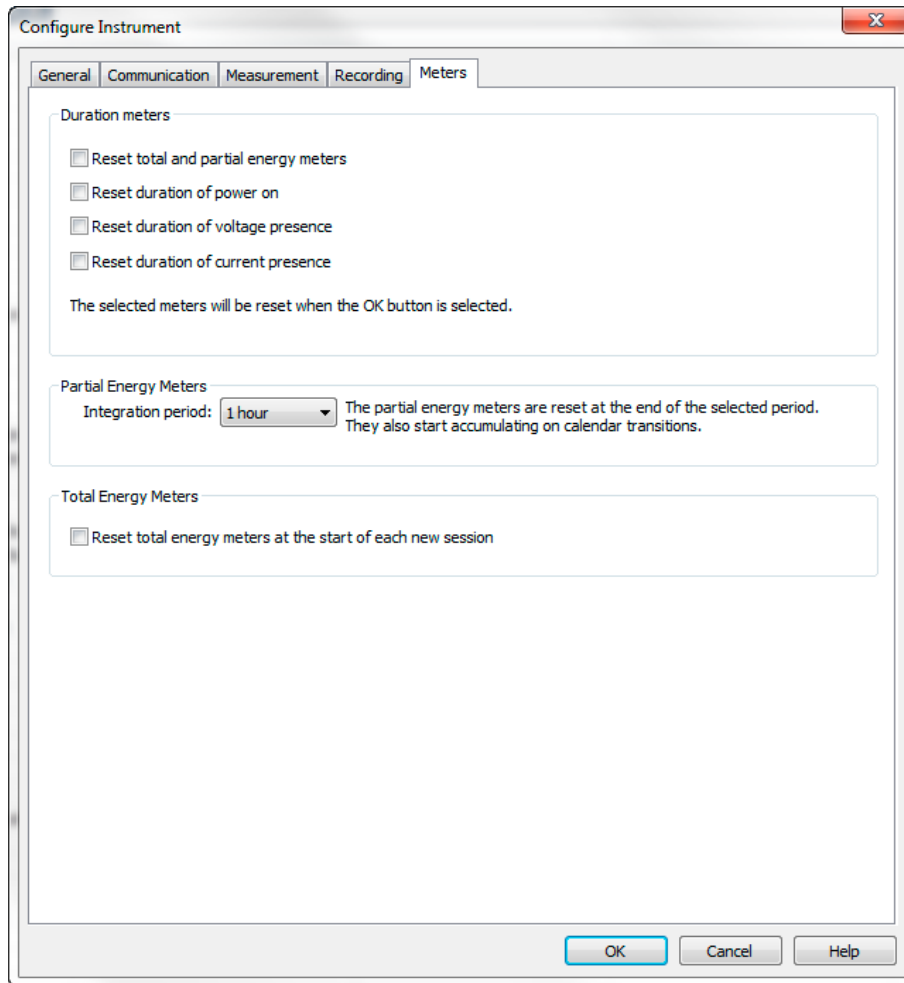

Figure 59

Duration meters:

- **Reset total and partial energy meters:** When checked, causes the total energy meters in the instrument to be reset.
- **Reset duration of power on:** When checked, causes the power on meter in the instrument to be reset.
- **Reset duration of voltage presence:** When checked, resets the voltage presence meter.
- **Reset duration of current presence:** When checked, resets the current presence meter.
- **Energy metering period:** Drop-down list containing periods for the instrument energy meters.

Partial Energy Meters:

- Drop-down list that allows the selection of intervals to be used by the instrument's partial energy accumulators. The instrument can accumulate the measurements for a group of measurements over a user specified period.
 - Available periods = Selected aggregation period, 1 h, 1 day, 1 week, 1 month.

Total Energy Meters:

- **Reset total energy meters at the start of each new session:** When checked, the instrument will reset the meters when a recording starts (either via software or the instrument's Control button). This allows the energy meters to represent just the recording period. When not checked, the meters will not reset at the start of each new recording.

4.4.7 Configuring and Recording Data Example

The following is intended as an example of measuring and recording over a period of 8 hours.



NOTE: Set the instrument's clock to the proper time as the clock may vary due to time zones.

1. If a recording is active, stop it by selecting **Instrument > Stop Recording** from the main menu.



Figure 60

2. Open the **Configure Instrument** dialog box (see § 4.4) and select the **Recording** tab.
3. Select an 8-hour recording duration by selecting the **8 hour** option from the **Duration** drop-down list.
4. Check the **Record now** checkbox.

At this point the Recording tab should look similar to the figure below.

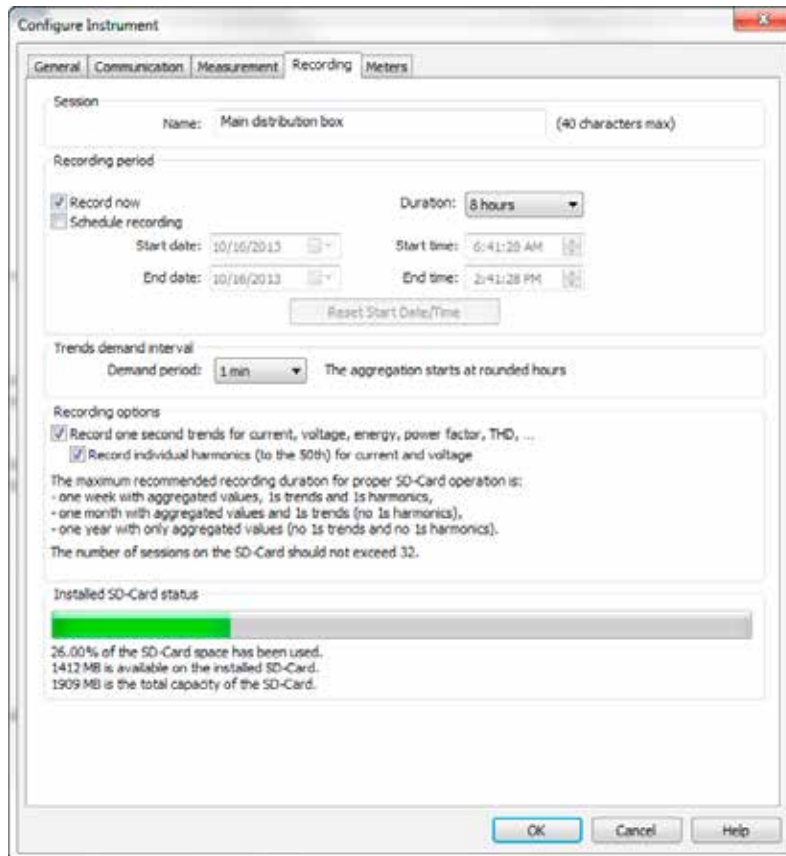



Figure 61

5. Press **OK**. This will write the configuration to the instrument and begin a recording (provided enough memory is available in the instrument).

4.4.8 Modifying an Instrument's Configuration

To change or modify the instrument's configuration, select the desired PEL listed in the **PEL Network**, then select the **Modify Instrument Configuration** button (), located at the top of the Status area below the Toolbar.

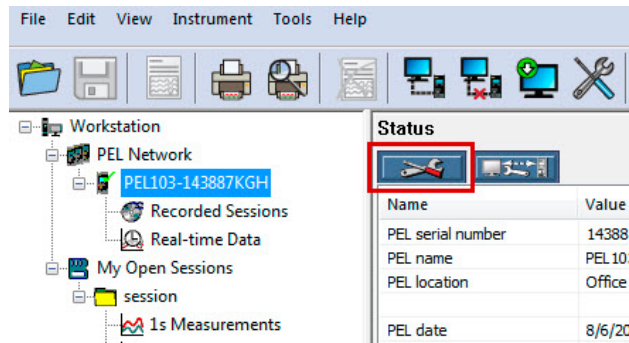

Figure 62

4.5 Downloading Recorded Data

Recorded measurements stored in the instrument are transferred to a database on the PC using the download command. Assuming a recording session has been started and stopped, the instrument should have at least one recording session.

To Download a Recording:

1. Select a recorded session from **Recorded session** branch of the PEL Network.

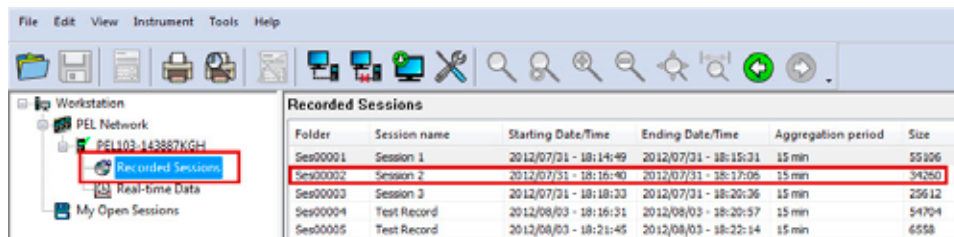

Figure 63

2. To download the session, perform one of the following:

- From the **Instrument** menu, select **Download Recorded Data**.
- or
- From the **Toolbar**, click on the **Download** icon.

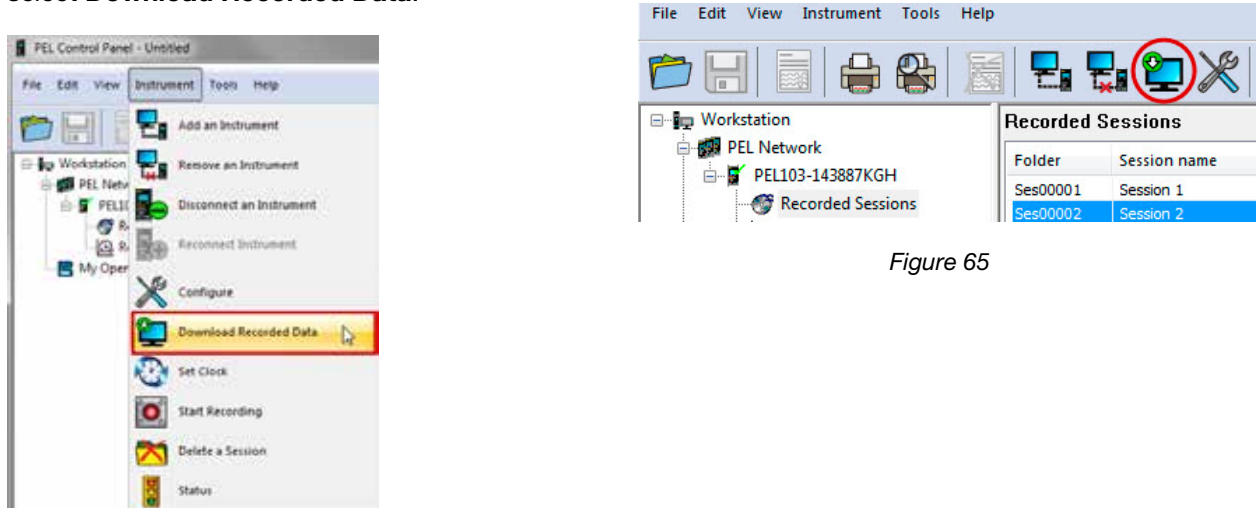

Figure 65

Figure 64

NOTE: You can also double-click on a recording to download it.

This opens the Download dialog box and begins the transfer of recorded data to the computer:

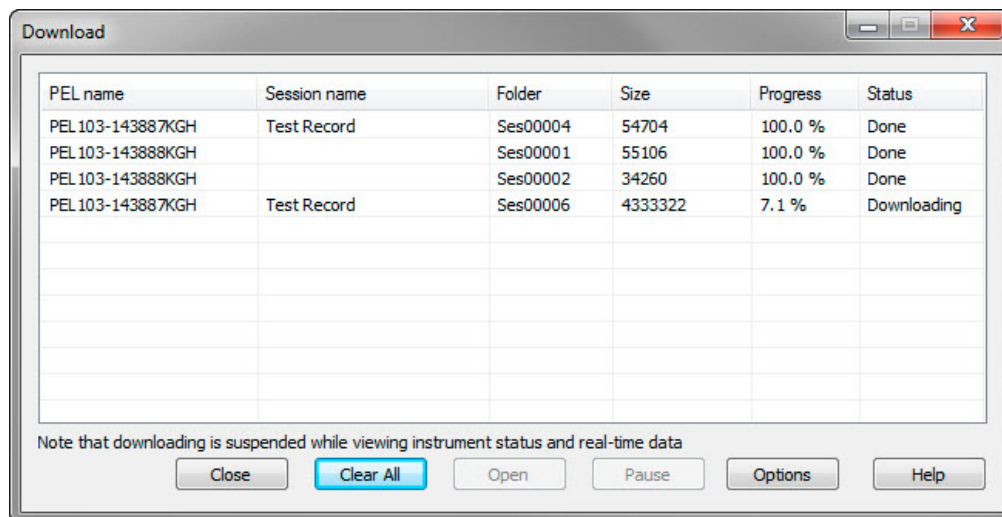

Figure 66

- You can hide the **Download** dialog box by selecting the **Close** button. This does not stop the download but simply hides the **Download** dialog box so you can continue to use the **PEL Control Panel**.
 - The **Clear All** button clears the list terminating the download of any downloads in progress. It does not delete them from the instrument or the download folder but simply removes them from the download list.
 - You can pause the download of a session by selecting it and clicking on the **Pause** button. To resume the download, repeat the process. The **Pause** button will change to a **Resume** button when you select a download that was previously paused. This indicates the action that will be taken when you select the button. The **Pause** button is disabled when a recording that has finished downloading is selected.
3. Once the file has been fully downloaded, it can be opened by selecting it in the **Download** dialog box and clicking on the **Open** button or by double-clicking on the file. Alternatively, it can be opened from the **Download Folder** dialog box (see § 4.6). The session will then be added to the **My Open Sessions** section:

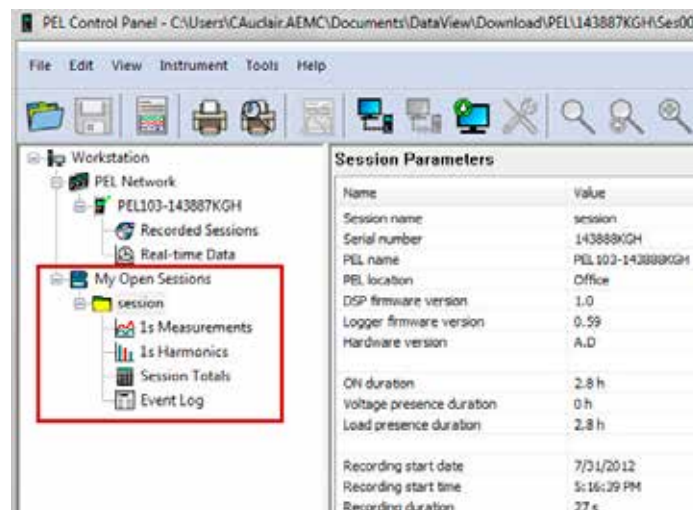

Figure 67

4. Selecting different items under the session name in **My Open Sessions** will display the associated data in the data frame on the right.

4.6 Using the Download Folder

Downloaded sessions are saved to the download folder, which is located in the "...My document\DataView\Download\PEL\" folder. Sessions are saved so they do not need to be downloaded more than once. They are also saved so that if you exit the **PEL Control Panel** while downloading, the download can resume (where it left off) the next time the program starts.

- To open the **Download Folder** dialog box select **Tools > Download Folder** from the main menu.

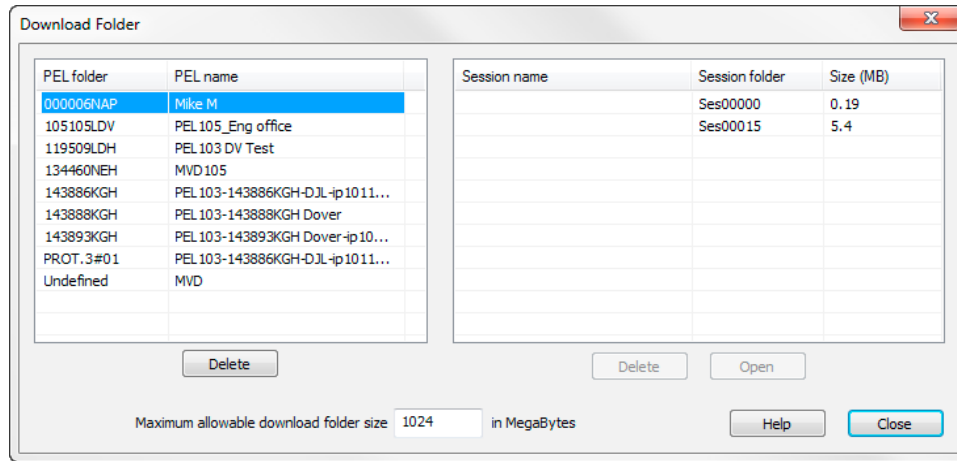

Figure 68

- The **Download Folder** dialog box contains a list of instruments on the left side. This list contains instruments from which sessions were previously downloaded. On the right is a list of sessions that are in the download folder for the selected instrument.
- Initially the list on the right is empty because no instrument is initially selected. Selecting an instrument on the left will update the list on the right to display all of the sessions associated with the selected instrument that are currently in the download folder.
- You can use the download folder to open recordings previously downloaded even when the instrument is not connected to the computer. To do this, select the instrument on the left that the session was downloaded from. Next, select the desired session from the list on the right. Finally, select the **Open** button to open the session and display it in the **My Open Sessions** navigation tree branch.
- You can remove individually saved sessions from the download folder by selecting the desired session and clicking on the **Delete** button located under the list on the right.

NOTE: A session cannot be deleted from the **Download Folder** dialog box if it is still currently listed in the **Download** dialog box. You must first open the **Download** dialog box (go to **Instrument > Download Recorded Data**) and hit the **Clear All** button.

- Note that there are two **Delete** buttons. The one on the left (under the list of instruments) will delete all of the saved items for the selected instrument. The **Delete** button on the right (under the list of saved sessions) will delete only the selected session from the download folder.

Each time the **PEL Control Panel** starts it will calculate how much space is being used on the computer's hard drive and compare it to the "Maximum allowable download folder size" specified at the bottom of the **Download Folder** dialog box.

If the amount of space being used by the download folder exceeds this amount, a warning message will be displayed. No action will be taken automatically; you are simply informed whenever the size of the download folder exceeds the amount specified here.

4.7 PEL Reports

Several predefined report templates are available for you to use. You can choose a report template either before or after a recording. You can also create your own custom templates.

A report is created by performing the following steps

1. Download recorded data from the instrument.
2. Open the downloaded data.
3. Select **Create DataView Report** from the File menu or by selecting the associated Toolbar button. The **Select Data to Export** dialog box will be displayed.
4. Specify the time period of the recording that is to be used in the report and select **OK**. After the database is generated, the **Create Report from Template** dialog box will be displayed.
5. Select the desired report template (Basic is a simplified report and Monitoring is a detailed report containing many worksheets). Once the template is selected, select the **OK** button.

At the bottom of the report screen is a series of tabs used to select the desired worksheet to view.

4.7.1 Specifying the Default Report Template

The previous example required that you select the template from the **Create Report from Template** dialog box. You can also specify a default template that should be used to automatically generate the report. Doing so will eliminate step 5 above.

To specify the default template, perform the following:

1. Select the **Select Report** option from the Tools menu. The **Templates** dialog box will be displayed.
2. Select the template to be used as the default.
3. Click on the **Select** button. An asterisk will be displayed next to the name of the default template.

You can select any of the listed templates as the default.

You can remove the selection of a default template (and be asked to select a template each time you create a report) by clicking on the **Reset** button.

4.8 Power & Energy Logger (PEL) Android App

Another way to connect to a PEL instrument is through the Power & Energy Logger (PEL) Android app. This app, which can be downloaded free from the Google Play Store (<https://play.google.com/store/apps/details?id=com.aemc.pel&hl=en>) enables you to work with a PEL instrument from an Android mobile device. Android is a platform for “touch screen” mobile devices such as tablets and smartphones. Introduced in 2007, Android has grown to become the most popular mobile operating system in the world, with over one billion devices sold globally.

The PEL app connects to the PEL via Bluetooth. And if the PEL is connected to a LAN network, you can also communicate with the instrument over Wi-Fi.

The PEL app provides a substantial subset of the functionality provided by the PEL Control Panel. For example, you can view data currently being measured by the instrument in real-time. This includes the type of distribution system currently being measured, and (for AC systems) the phasor diagram appropriate for this setup. Real-time data is organized in tables of related measurements for quick navigation and reference, and updated continuously from the instrument.

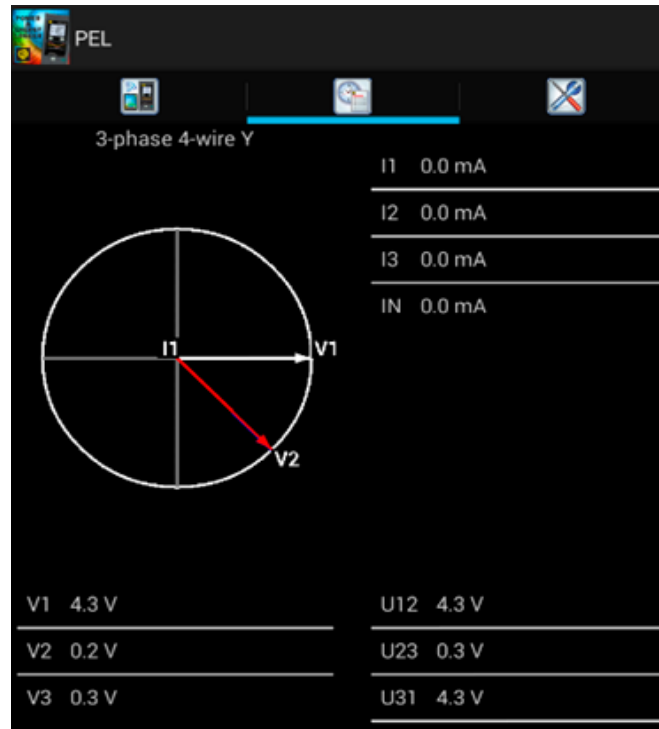

Figure 69

These data tables, which can require several pages to display, depend on the current distribution system. Different data appears for different distribution systems; the above example shows the first page of real-time data for a 3-phase 4-wire system.

You can also set parameters to schedule a recording session and specify what data will be recorded. This can be a recording that starts immediately, or at a future date and time. You can also choose which data to record. Recorded data is stored on the PEL instrument, where it can subsequently be downloaded to a PC and analyzed in detail using DataView.

In addition, you can view and/or set configuration variables on the PEL instrument. The PEL Android app enables you to review the current configuration settings on your PEL, and change these settings as required. You can change the type of distribution system being measured, voltage ratios, nominal frequency, current sensors options, communication-related settings, and other information related to the instrument and its operation.

The app is provided with a complete online Help system, which can be viewed independently at <http://www.pel100.us/help-en/index.html>. Consult this Help system for a complete description of the PEL app and all its capabilities.

5. SPECIFICATIONS

5.1 Reference Conditions

Parameter	Reference Conditions
Ambient temperature	73°F (23 °C) ± 2°F/C
Relative humidity	45% to 75% RH
Voltage	No DC component in AC, no AC component in DC (< 0.1%)
Current	No DC component in AC, no AC component in DC (< 0.1%)
Phase voltage	100 to 1000Vrms, without DC (< 0.5%)
Input voltage of current inputs (except AmpFlex®/MiniFlex®)	50mV to 1.2V without DC (< 0.5%) for AC measurement, without AC (< 0.5%) for DC measurement
Harmonics	< 0.1%
Voltage unbalance	0%
Preheating	Device powered for at least an hour
Common mode	Neutral input and enclosure are held at earth potential
	Instrument powered on battery, USB disconnected
Magnetic field	0 A/m AC
Electric field	0 V/m AC

Table 13

5.2 Electrical Specifications

5.2.1 Voltage Inputs

Operating Range: up to 1000Vrms for phase-to-neutral voltages
up to 1700Vrms for phase-to-phase voltages



NOTE: Phase-to-neutral voltages lower than 2V and phase-to-phase voltages lower than $2\sqrt{3}$ are zeroed.

Input Impedance: 1908kΩ (phase-to-neutral and neutral-to-earth/ground)

Max Overload: 1100Vrms

5.2.2 Current Inputs



NOTE: Current sensor inputs are “voltage” inputs (current probes have a voltage output).

Operating Range: 0.5mV to 1.2V (1V = I_{nom}) with crest factor = $\sqrt{2}$

Input Impedance: 1MΩ (except for AmpFlex®/MiniFlex® current sensors)
12.4kΩ (AmpFlex®/MiniFlex® current sensors)

Max Overload: 1.7V

5.2.3 Accuracy Specifications (excluding current sensors)

5.2.3.1 Specifications at 50/60Hz

Quantity	Measurement Range	Intrinsic Uncertainty
Frequency (f)	42.5 to 69Hz	± 0.1Hz
Phase to neutral voltage (V)	10 to 100V	± 0.2% ± 0.2V **
	100 to 1000V	± 0.2% ± 0.2V
Phase to phase voltage (U)	17 to 170V	± 0.2% ± 0.4V **
	170 to 1700V	± 0.2% ± 0.4V
Current (I) without current sensor *	0.2 to 5% Inom	± 0.2% ± 0.02% Inom **
	5 to 120% Inom	± 0.2% ± 0.02% Inom
Active power (P)	PF = 1 V = 100 to 1000V I = 5 to 120% Inom	± 0.5% ± 0.005% Pnom
	PF = [0.5 inductive ; 0.8 capacitive] V = 100 to 1000V I = 5 to 120% Inom	± 0.7% ± 0.007% Pnom
Reactive power (Q)	Sin φ = 1 V = 100 to 1000V I = 5 to 120% Inom	± 1% ± 0.01% Qnom
	Sin φ = [0.5 inductive ; 0.5 capacitive] V = 100 to 1000V I = 5 to 120% Inom	± 1% ± 0.015% Qnom
	Sin φ = [0.5 inductive ; 0.5 capacitive] V = 100 to 1000V I = 5 to 120% Inom	± 1.5% ± 0.015% Qnom
	Sin φ = [0.25 inductive ; 0.25 capacitive] V = 100 to 1000V I = 5 to 120% Inom	± 3.5% ± 0.003% Qnom
Apparent power (S)	V = 100 to 1000V I = 5 to 120% Inom	± 0.5% ± 0.005% Snom
Power factor (PF)	PF = [0.5 inductive ; 0.5 capacitive] V = 100 to 1000V I = 5 to 120% Inom	± 0.05
	PF = [0.2 inductive ; 0.2 capacitive] V = 100 to 1000V I = 5 to 120% Inom	± 0.1
Tan φ	Tan φ = [√3 inductive ; √3 capacitive] V = 100 to 1000V I = 5 to 120% Inom	± 0.02
	Tan φ = [3.2 inductive ; 3.2 capacitive] V = 100 to 1000V I = 5 to 120% Inom	± 0.05
Active energy (Ep)	PF = 1 V = 100 to 1000V I = 5 to 120% Inom	± 0.5%
	PF = [0.5 inductive ; 0.8 capacitive] V = 100 to 1000V I = 5 to 120% Inom	± 0.6 %

Quantity	Measurement Range	Intrinsic Uncertainty
Reactive energy (Eq)	Sin ϕ = 1 V = 100 to 1000V I = 5 to 120% Inom	$\pm 2\%$
	Sin ϕ = [0.5 inductive ; 0.5 capacitive] V = 100 to 1000V I = 5 to 120% Inom	$\pm 2\%$
	Sin ϕ = [0.5 inductive ; 0.5 capacitive] V = 100 to 1000V I = 5 to 120% Inom	$\pm 2.5\%$
	Sin ϕ = [0.25 inductive ; 0.25 capacitive] V = 100 to 1000V I = 5 to 120% Inom	$\pm 2.5\%$
Apparent energy (Es)	V = 100 to 1000V I = 5 to 120% Inom	$\pm 0.5\%$
Harmonics number (1 to 25)	PF = 1 V = 100 to 1000V I = 5 to 120% Inom	$\pm 1\%$
Total Harmonic Distortion (THD)	PF = 1 V = 100 to 1000V I = 5 to 120% Inom	$\pm 1\%$

Table 14

- *Inom* is the value of the measured current for a current sensor output of 1V. See Table 26 for the nominal current values.
- *Pnom* and *Snom* are the active power and apparent power for $V = 1000V$, $I = I_{nom}$ and $PF = 1$.
- *Qnom* is the reactive power for $V = 1000V$, $I = I_{nom}$, and $Sin \phi = 1$.
- * The intrinsic uncertainty for input current (*I*) is specified for an isolated input voltage of $1V = I_{nom}$. The intrinsic uncertainty of the connected current sensor should be added to this intrinsic uncertainty to determine the total intrinsic uncertainty. In the case of using sensors AmpFlex® and MiniFlex®, intrinsic uncertainty is given in Table 27.
The intrinsic uncertainty for neutral current is the maximum intrinsic uncertainty on I1, I2 and I3.
- ** Indicative maximum value of the intrinsic uncertainty. Higher uncertainties can be noted, in particular with EMI.

5.2.3.2 Specifications @ 400Hz

Quantity	Measurement Range	Intrinsic Uncertainty
Frequency (F)	340 to 460Hz	± 0.1Hz
Phase to neutral voltage (V)	10 to 100V	± 0.5% ± 0.5V **
	100 to 600V	± 0.5% ± 0.5V
Phase to phase voltage (U)	17 to 170V	± 0.5% ± 0.5V **
	170 to 1700V	± 0.5% ± 0.5V
Current (I) without current sensor *	0.2 to 5% Inom	± 0.5% ± 0.05% Inom **
	5 to 120% Inom ***	± 0.5% ± 0.05% Inom
Active power (P)	PF = 1 V = 100 to 600V I = 5 to 120% Inom	±2% ± 0.02% Pnom **
	PF = [0.5 inductive ; 0.8 capacitive] V = 100 to 600V I = 5 to 120% Inom	±3% ± 0.03% Pnom **
Active energy (Ep)	PF = 1 V = 100 to 600V I = 5 to 120% Inom	± 2% **

Table 15

- Inom is the value of the measured current for a current sensor output at 50/60Hz. See Table 26 for the nominal current values.
- Pnom is the active power for V = 600V, I = Inom and PF = 1.
- * The intrinsic uncertainty for input current (I) is specified for an isolated input voltage of 1V = Inom. The intrinsic uncertainty of the connected current sensor should be added to this intrinsic uncertainty to determine the total intrinsic uncertainty. In the case of using sensors AmpFlex® and MiniFlex®, intrinsic uncertainty is given in Table 27. The intrinsic uncertainty for neutral current is the maximum intrinsic uncertainty on I1, I2 and I3.
- ** Indicative maximum value of the intrinsic uncertainty. Higher uncertainties can be noted, in particular with EMI.
- *** For AmpFlex® and MiniFlex®, the maximum current is limited to 60% Inom at 50/60Hz, because of higher sensitivity.

5.2.3.3 Specifications @ DC

Quantity	Measurement Range	Typical Intrinsic Uncertainty **
Voltage (V)	V = 100 to 1000V	± 1% ± 3V
Current (I) without current sensor *	I = 5% to 120% Inom	± 1% ± 0.3% Inom
Power (P)	V = 100 to 1000V I = 5% to 120% Inom	± 1% ± 0.3% Pnom
Energy (Ep)	V = 100 to 1000V I = 5% to 120% Inom	± 1.5%

Table 16

- Inom is the value of the measured current for a current sensor output of 1 V. See Table 26 for the nominal current values.
- Pnom is the power for V = 1000V and I = Inom.
- * The intrinsic uncertainty for input current (I) is specified for an isolated input voltage of 1V = Inom. The intrinsic uncertainty of the connected current sensor should be added to this intrinsic uncertainty to determine the total intrinsic uncertainty. In the case of using sensors AmpFlex® and MiniFlex®, intrinsic uncertainty is given in Table 27.
- The intrinsic uncertainty for neutral current is the maximum intrinsic uncertainty on I1, I2 and I3.
- ** Indicative maximum value of the intrinsic uncertainty. Higher uncertainties can be noted, in particular with EMI.

5.2.3.4 Temperature

For V, U, I, P, Q, S, FP and E:

- 300 ppm/°C, with 5% < I < 120% and PF = 1
- 500 ppm/°C, with 10% < I < 120% and PF = 0.5 inductive
- Typical DC offset V: 10mV/°C
I: 30 ppm x Inom/°C

5.2.3.5 Common Mode Rejection

The common mode rejection ratio on neutral input is typically 140 dB. For example, 110V applied on the neutral input will add 11µV to AmpFlex®/MiniFlex® values, which is a 230mA error at 60Hz. A voltage of 110V applied on the neutral input will add 11µV to other current sensors' values, resulting in an additional error of 0.01% Inom.

5.2.3.6 Magnetic Field Influence

For Rogowski inputs (without sensors): 10 mA/A/m typical at 50/60 Hz.

5.2.4 Current Sensors

5.2.4.1 Precautions for Use

Refer to the safety sheet or user manual that was supplied with your current sensors for more information.

5.2.4.2 Use and Characteristics

Current clamps and flexible current sensors are used to measure the current flowing in a cable without opening the circuit. They also insulate the user from dangerous voltages in the circuit.

- The choice of current sensor to be used depends on the current to be measured and the diameter of the cables.
- When installing current sensors, face the arrow on the probe or the sensor in the direction of the load.

5.2.4.3 MiniFlex® MA193

The Flexible Current Sensor MiniFlex® Model MA193 can be used to measure the current in a cable without opening the circuit. It also serves to isolate the user from hazardous voltages in the circuit. This sensor can only be used as an accessory of an instrument. Before connecting it, if you have several sensors, you can mark each of them using one of the color-coded ID markers supplied with the instrument to identify the phase. Then connect the sensor to the instrument.

- Press the yellow opening device to open the Flexible coil. Then, place it around the conductor through which the current to be measured flows (only one conductor in the sensor).
- Close the coil. In order to optimize measurement quality, it is best to center the conductor in the coil and make the shape of the coil as circular as possible.
- To disconnect the coil, open it and withdraw it from the conductor. Then, disconnect the sensor from the instrument.

MiniFlex® MA193	
Nominal Range	100/400/2000/10,000AAC
Measurement Range	200mA to 3000AAC
Sensor	Length = 10" (250 mm); Ø = 2.75" (70 mm)
Variation of the position of the conductor in the sensor	≤ 1.5% typical, 2.5% max
Adjacent conductor carrying alternating current	≤ 1% for a conductor in contact with sensor and ≤ 2% near the snap device
Safety	EN 61010-2-032, Pollution Degree 2, 600V CAT IV, 1000V CAT III

Table 17

NOTE: Currents < 0.05% of the nominal range (100, 400, 2000 or 10,000A) will be displayed as zero. The nominal ranges are reduced to 50/200/1000/5000AAC at 400Hz. MiniFlex® will operate when 10,000A is selected.

5.2.4.4 Other Current Sensors

The measurement ranges are those of the sensors. In some cases, they may differ from the ranges that can be measured by the PEL. For use, see the manual distributed with the current sensor

NOTE: Power calculations will be zeroed when the current is zeroed.

Model MR193	
Nominal Range	1000AAC, 1400ADC max
Measurement Range	1A to 1000AAC, 10 to 1300APEAK AC+DC
Maximum Clamping Diameter	One 1.6" (42mm) or two 0.98" (25.4mm) or two bus bars 1.96 x 0.19" (50 x 5mm)
Variation of the position of the conductor in the sensor	< 0.5% DC to 440Hz
Adjacent conductor carrying alternating current	< 10mA/A at 50/60Hz
Safety	EN 61010-2-032, Pollution Degree 2, 300V CAT IV, 600V CAT III

Table 18

NOTE: Currents < 1AAC/DC will be displayed as zero.

Model SR193	
Nominal Range	1000AAC for f ≤ 1 kHz
Measurement Range	1 to 1200AAC max (I > 1000A not continuously)
Maximum Clamping Diameter	2" (52mm)
Variation of the position of the conductor in the sensor	< 0.5% DC to 440Hz
Adjacent conductor carrying alternating current	< 10mA/A at 50/60Hz
Safety	EN 61010-2-032, Pollution Degree 2, 600V CAT IV, 1000V CAT III

Table 19

NOTE: Currents < 0.5A will be displayed as zero.

AmpFlex® Sensors	
Nominal Range	100/400/2000/10,000AAC
Measurement Range	50mA to 12000AAC
Sensor	Length = 24" (610mm); Ø = 7.64" (190mm) Length = 36" (910mm); Ø = 11.46" (290mm)
Variation of the position of the conductor in the sensor	≤ 2% any position and ≤ 4% near snap device
Adjacent conductor carrying alternating current	≤ 1% any position and ≤ 2% near snap device
Safety	EN 61010-2-032, Pollution Degree 2, 600V CAT IV, 1000V CAT III

Table 20

NOTE: Currents < 0.05% for nominal range (100, 400, 2000 or 10,000A) will be displayed as zero. The nominal ranges are reduced to 50/200/1000/5000AAC at 400Hz.

Model MN93	
Nominal Range	200AAC for $f \leq 1$ kHz
Measurement Range	0.5A to 240AAC max (I >200A not permanent)
Maximum Clamping Diameter	0.8" (20mm)
Variation of the position of the conductor in the sensor	< 0.5% at 50/60Hz
Adjacent conductor carrying alternating current	≤ 15mA/A
Safety	EN 61010-2-032, Pollution Degree 2, 300V CAT IV, 600V CAT III

Table 21

NOTE: Currents < 0.1A will be displayed as zero.

Model MN193	
Nominal Range	5A and 100AAC
Measurement Range	5A: 0.005 to 6AAC max 100A: 0.2 to 120AAC max
Maximum Clamping Diameter	0.8" (20mm)
Variation of the position of the conductor in the sensor	< 0.5% at 50/60Hz
Adjacent conductor carrying alternating current	≤ 15mA/A at 50/60Hz
Safety	EN 61010-2-032, Pollution Degree 2, 300V CAT IV, 600V CAT III

Table 22

The 5A range of the MN193 is designed to work with secondary current transformers.

NOTE: Currents < 2.5mA x ratio on the 5A range and < 0.05A on the 100A range will be displayed as zero with this probe.

Model SL261	
Nominal Range	10A and 100AAC/DC
Measurement Range	100mV/A: 100mA to 10A peak 10mV/A: 1 to 100A peak
Probe Output Signal	1000mV peak max
Maximum Clamping Diameter	0.46" (11.8mm)
Variation of the position of the conductor in the sensor	< 0.5%
Adjacent conductor carrying alternating current	-33 dB typical, DC to 1 kHz
Safety	EN 61010-2-032, Pollution Degree 2, 600V CAT III

Table 23

Model J93	
Nominal Range	3500AAC and 5000ADC
Measurement Range	50 to 3500AAC 50 to 5000ADC
Maximum Clamping Diameter	2.83" (72 mm)
Variation of the position of the conductor in the sensor	< ± 2%
Adjacent conductor carrying alternating current	> 35 dB typical, DC to 2kHz
Safety	IEC 61010-2-032, pollution degree 2, 600V CAT IV, 1000V CAT III

Table 24

5A Adapter Box /Essailec® adapter	
Nominal Range	5AAC
Measurement Range	250mAAC to 6AAC
Probe Output Signal	200mVAC/AAC
Number of transformer inputs	3
Safety	EN 61010-2-032, Pollution degree 2, 300V CAT III

Table 25

NOTE: Currents < 2.5mA will be displayed as zero.

5.2.4.5 Accuracy

The RMS current measurement accuracy and the phase accuracy correspond to addition values (which must therefore be added to the instrument's accuracy), indicated as influences on the calculations carried out by the instrument (powers, energies, power factors, tangents, etc.).

The following specifications are considered to be in the conditions of references of the current sensor.

Current sensors with 1V output at Inom specifications

Model	I nominal	Current (RMS or DC)	Intrinsic uncertainty at 50/60 Hz	Intrinsic uncertainty on ϕ at 50/60 Hz	Typical uncertainty on ϕ at 50/60 Hz	Typical uncertainty on ϕ at 400 Hz
MR193	1000ADC	1 to 50A	± 1.5% ± 1A **	-	-	- 4.5° @ 100A
		50 to 100A	± 1.5% ± 1A	± 2.5°	-0.9°	
		100 to 800A	± 2.5%	± 2°	- 0.8°	
		800 to 1000A	± 4%		- 0.65°	
SR193	1000AAC	1 to 50A	± 1% **	-	-	+ 0.1° @ 1000A
		50 to 100A	± 0.5%	± 1°	+ 0.25°	
		100 to 1200A	± 0.3%	± 0.7°	+ 0.2°	
MN93	200AAC	0.5 to 5A	± 3% ± 1A **	-	-	-
		5 to 40A	± 2.5% ± 1A	± 5°	+ 2°	- 1.5° @ 40A
		40 to 100A	± 2% ± 1A	± 3°	+ 1.2°	- 0.8° @ 100A
		100 to 240A	± 1% + 1A	± 2.5°	± 0.8°	- 1° @ 200A

Model	I nominal	Current (RMS or DC)	Intrinsic uncertainty at 50/60 Hz	Intrinsic uncertainty on ϕ at 50/60 Hz	Typical uncertainty on ϕ at 50/60 Hz	Typical uncertainty on ϕ at 400 Hz
MN193	100A _{AC}	200mA to 5A	$\pm 1\% \pm 2\text{mA}^{**}$	$\pm 4^\circ$	-	-
		5 to 120A	$\pm 1\%$	$\pm 2.5^\circ$	+ 0.75°	- 0.5° @100A
	5A _{AC}	5 to 250mA	$\pm 1.5\% \pm 0.1\text{mA}^{**}$	-	-	-
		255mA to 6A	$\pm 1\%$	$\pm 5^\circ$	+ 1.7°	- 0.5° @ 5A
SL261	100A _{AC/DC}	5 to 40A	$\pm 4\% \pm 50\text{mA}$	$\pm 1^\circ$	-	-
		40 to 100A	$\pm 15\%$	$\pm 1^\circ$	-	-
	10A _{AC/DC}	50mA to 10A	$\pm 3\% \pm 50\text{mA}$	$\pm 1.5^\circ$	-	-
5A Adapter	5A _{AC}	5 to 250mA	$\pm 0.5\% \pm 2\text{mA}^{**}$	-	-	-
		250mA to 6A	$\pm 0.5\% \pm 1\text{mA}$	$\pm 0.5^\circ$	-	-
J93	3500A _{AC} 5000A _{DC}	50 to 250A	$\pm 2\% + 2.5\text{A}$	$\pm 3^\circ$	-	-
		250 to 500A	$\pm (1.5\% + 2.5\text{A})$	$\pm 2^\circ$		
		500 to 3500A	$\pm 1\%$	$\pm 1.5^\circ$		
		3500 to 5000A (DC only)	$\pm 1\%$	-		

Table 26

** Indicative maximum value of the intrinsic uncertainty. Higher uncertainties can be noted, in particular with EMI.

AmpFlex® and MiniFlex® Specifications

Sensor type	I nominal	Current (RMS or DC)	Typical intrinsic uncertainty at 50/60Hz	Intrinsic uncertainty at 400Hz	Intrinsic uncertainty on ϕ at 50/60Hz	Typical uncertainty on ϕ at 400Hz
AmpFlex® A193 *	100A _{AC}	200mA to 5A	$\pm 1.2\% \pm 50\text{mA}^{**}$	$\pm 2\% \pm 0.1\text{A}^{**}$	-	-
		5 to 120A *	$\pm 1.2\% \pm 50\text{mA}$	$\pm 2\% \pm 0.1\text{A}$	$\pm 0.5^\circ$	- 0.5°
	400A _{AC}	0.8 to 20A	$\pm 1.2\% \pm 0.2\text{A}^{**}$	$\pm 2\% \pm 0.4\text{A}^{**}$	-	-
		20 to 500A *	$\pm 1.2\% \pm 0.2\text{A}$	$\pm 2\% \pm 0.4\text{A}$	$\pm 0.5^\circ$	- 0.5°
	2000A _{AC}	4 to 100A	$\pm 1.2\% \pm 1\text{A}^{**}$	$\pm 2\% \pm 2\text{A}^{**}$	-	-
		100 to 2400A *	$\pm 1.2\% \pm 1\text{A}$	$\pm 2\% \pm 2\text{A}$	$\pm 0.5^\circ$	- 0.5°
10,000A _{AC}	20 to 500A	$\pm 1.2\% \pm 5\text{A}^{**}$	$\pm 2\% \pm 10\text{A}^{**}$	-	-	
	500 to 12,000A *	$\pm 1.2\% \pm 5\text{A}$	$\pm 2\% \pm 10\text{A}$	$\pm 0.5^\circ$	- 0.5°	
MiniFlex® MA193 *	100A _{AC}	200mA to 5A	$\pm 1.2\% \pm 50\text{mA}^{**}$	$\pm 2\% \pm 0.1\text{A}^{**}$	-	-
		5 to 120A *	$\pm 1.2\% \pm 50\text{mA}$	$\pm 2\% \pm 0.1\text{A}$	$\pm 0.5^\circ$	- 0.5°
	400A _{AC}	0.8 to 20A	$\pm 1.2\% \pm 0.2\text{A}^{**}$	$\pm 2\% \pm 0.4\text{A}^{**}$	-	-
		20 to 500A *	$\pm 1.2\% \pm 0.2\text{A}$	$\pm 2\% \pm 0.4\text{A}$	$\pm 0.5^\circ$	- 0.5°
	2000A _{AC}	4 to 100A	$\pm 1.2\% \pm 1\text{A}^{**}$	$\pm 2\% \pm 2\text{A}^{**}$	-	-
		100 to 2400A *	$\pm 1.2\% \pm 1\text{A}$	$\pm 2\% \pm 2\text{A}$	$\pm 0.5^\circ$	- 0.5°
3000A _{AC}	20 to 500A	$\pm 1.2\% \pm 5\text{A}^{**}$	$\pm 2\% \pm 10\text{A}^{**}$	-	-	
	500 to 3000A *	$\pm 1.2\% \pm 5\text{A}$	$\pm 2\% \pm 10\text{A}$	$\pm 0.5^\circ$	- 0.5°	

Table 27

* The nominal ranges are reduced to 50/200/1000/5000A_{AC} at 400Hz.

** Indicative maximum value of the intrinsic uncertainty. Higher uncertainties can be noted, in particular with EMI.

When no current sensor is connected, the current values are forced to zero.

Distribution system	Abbreviation	I_1	I_2	I_3
Split phase (1-phase 2-wire)	1P-2W	•	–	–
Split phase (1-phase 3-wire)	1P-3W	•	•	–
3-phase 3-wire Δ	3P-3W Δ 2	•	–	•
3-phase 3-wire Open Δ	3P-3W02	•	–	•
3-phase 3-wire Y 2	3P-3WY2	•	–	•
3-phase 3-wire Δ	3P-3W Δ 3	•	•	•
3-phase 3-wire Open Δ	3P-3W03	•	•	•
3-phase 3-wire Y	3P-3WY	•	•	•
3-phase 3-wire Δ balanced	3P-3W Δ B	–	–	•
3-phase 4-wire Y	3P-4WY	•	•	•
3-phase 4-wire Y balanced	3P-4WYB	•	–	–
3-phase 4-wire Y 2½	3P-4WY2	•	•	•
3-phase 4-wire Δ	3P-4W Δ	•	•	•
3-phase 4-wire Open Δ	3P-4WO Δ	•	•	•
DC 2-wire	DC-2W	•	–	–
DC 3-wire	DC-3W	•	•	–
DC 4-wire	DC-4W	•	•	•

5.3 Bluetooth

Bluetooth 2.1

- Class 1 (range: 100 m)
- Nominal sensitivity: -82 dBm
- Nominal output power: +15 dBm
- Rate : 115.2 kbits/s

5.4 Power Supply

AC Power (external power supply) - Overvoltage CAT II

- **Operating Range:** 110V/230V (\pm 10%) @ 50/60Hz
- **Max Power:** 15VA (rated to 30 VA max)

Battery Power

- **Type:** Rechargeable NiMH battery
- **Charge Time:** 5 hours approx
- **Recharging Temperature:** 50° to 104°F (10° to 40°C)



NOTE: Configuration data is saved for up to 5 years during a low battery condition. When the instrument is off, the real-time clock is maintained for two weeks or longer.

Autonomy

- 30 minutes minimum
- 60 minutes typical

5.5 Mechanical Specifications

Dimensions: 10.08 x 4.92 x 1.46" (256 x 125 x 37mm)

Weight: < 1 kg

Drop Test: 1 m in the most severe position without permanent mechanical damage and functional deterioration

Degrees of Protection: Provided by enclosure (IP code) according to IEC 60529
IP 54 instrument not connected (de-energized) / not including the terminals
IP20 instrument connected (operating)

5.6 Environmental Specifications

Reference Temperature: 20 to 26°C (68 to 78.8°F) from 45 to 75% RH

Operating Temperature: 0 to 42.5°C (32 to 108.5°F) from 10 to 85% RH
0 to 50°C (32 to 122°F) from 45 to 75% RH

Storage Temperature:

With batteries: -20 to 35°C (-4 to 95°F) from 0 to 95% RH
-20 to 50°C (-4 to 122°F) from 0 to 75% RH

Without batteries: -20 to 70°C (-4 to 158°F) from 0 to 75% RH

Recharging Temperature: n/a

Altitude: Operating: 0 to 2000 m (6560 ft); Non-Operating: 0 to 10000m (32800 ft)

5.7 Safety Specifications

Electrical Safety 

The instrument complies with IEC 61010-1, and IEC 61010-2-030 for the following:

- Measurement inputs and enclosure: 600V CAT IV / 1000V CAT III, pollution degree 2
- Power supply: 300V overvoltage category II, pollution degree 2



Conforms to UL Std. UL 61010-1
Conforms to UL Std. UL 61010-2-030
Cert. to CAN/CSA Std. C22.2 No. 61010-1
Cert. to CSA Std. C22.2#61010-2-030

For current sensors, see § 5.2.4.4

The current sensors comply with IEC 61010-2-032

The test leads and alligator clips comply with IEC 61010-031

5.8 Electromagnetic Compatibility

- Emissions and immunity in an industrial setting compliant with IEC 61326-1 (with an influence of 0.5% typical of the full scale)

Specifications are subject to change without notice.

6. MAINTENANCE

6.1 Battery

Your instrument is equipped with a NiMH battery. This technology offers several advantages:

- Long battery charge life for a limited volume and weight.
- Possibility of quickly recharging your battery.
- Significantly reduced memory effect: you can recharge your battery even if it is not fully discharged.
- Respect for the environment: no pollutant materials such as lead or cadmium, in compliance with the applicable regulations.

After prolonged storage, the battery may be completely discharged. If so, it must be completely recharged.

Your instrument may not function during part of this recharging operation.

Full recharging of a completely discharged battery may take several hours.

 In this case, at least 5 charge/discharge cycles will be necessary for your battery to recover 95% of its capacity.

To make the best possible use of your battery and extend its effective service life:

- Only charge your instrument at temperatures between 50°F and 104°F (10°C and 40°C).
- Comply with the conditions of use defined in the operating manual.
- Comply with the storage conditions specified in the operating manual.

 Before first use, charge and discharge the instrument one or two cycles to ensure the proper level display of the battery indicator.

Note that if you are unsure about changing the battery, we recommend having this done at our Service Center as part of the PEL instrument's regular maintenance.

6.2 Battery Indicator

The Yellow/Red LED (see #6 Figure 8) is used to indicate the status of the battery.

When the power is on, the battery is charging until it is full.

- LED OFF: Battery full (with or without power supply).
- Yellow LED ON/No blinks: Battery is charging.
- Yellow LED blinks twice per second: Battery is recovering after a full discharge.
- Red LED blinks twice per second: Low battery (and no power supply).

6.3 Cleaning

 **Disconnect the instrument from any source of electricity.**

- Use a soft cloth, dampened with soapy water. Rinse with a damp cloth and dry rapidly with a dry cloth.
- Do not use the instrument if the terminals or keyboard are wet. Dry them first.
- Do not use alcohol, solvents, or hydrocarbons.
- Do not splash water directly on the instrument.

6.4 Firmware Update

The PEL 102 and 103 firmware controls the features and functionality of the instrument. AEMC provides firmware updates free of charge to download through our DataView PEL Control Panel software.

 **NOTE:** Updating the firmware could reset the configuration and causes the loss of the stored data. As a precaution, save the stored data to a computer before updating.

To update the firmware, your computer must be running DataView with the PEL Control Panel (V2.2.9665 or later).

1. Power ON the instrument using external power, to ensure the instrument remains ON throughout the update procedure. Also ensure that the battery is at least 50% charged. **Do not perform an update with the instrument running on battery power, or with low battery charge. If the instrument turns OFF while firmware updating is in progress, it could become inoperative. External power with a sufficiently charged battery for backup helps minimize the risk of power interruptions during updating.**
2. Connect the PEL instrument to the computer using the USB cable.
3. Launch the DataView PEL Control Panel.
4. Ensure the instrument is listed in the PEL Network navigation tree. If it is, skip this step and go to step 5 below. If not, click **Instrument** in the menu bar and select **Add an Instrument**, then connect the instrument using the Add an Instrument Wizard. (Press F1 if you need assistance.).
5. Ensure the instrument is listed with a green check next to its name, indicating it is connected. If not, select the instrument and click **Instrument > Reconnect Instrument**. When the instrument is connected, select it.
6. By default, the PEL Control Panel automatically checks the connected instrument's firmware. If it is out of date, the Firmware Update dialog box appears, listing the instrument and any others running out-of-date firmware. Click **Update** (or **Select All** to update multiple instruments). This displays the Firmware Upgrade dialog box listing the latest firmware revisions for the PEL DSP and microprocessor; proceed as instructed in Step 7 below.

If the PEL Control Panel option "Check automatically for new firmware for connected instruments upon start of program" has been previously de-selected, the automatic firmware check does not occur. In this case, click **Instrument** in the menu bar. This includes the option **Firmware Upgrade**. If the selected instrument is running the latest firmware, this option is grayed out and inactive. If the instrument is not running the latest firmware, click Firmware Upgrade to display the Firmware Upgrade dialog box.

7. Click the **Start** button to begin the update. During this process, status bars display the progress of the DSP and microprocessor firmware updates. (Note that if only one of these requires updating, only its status bar appears.)
8. When the firmware update is complete, click the **Close** button to exit.

A.1 Measurements

A.1.1 Definition

Calculations are done according to IEC 61557-12 and IEC 61010-4-30.

Geometric representation of active and reactive power:

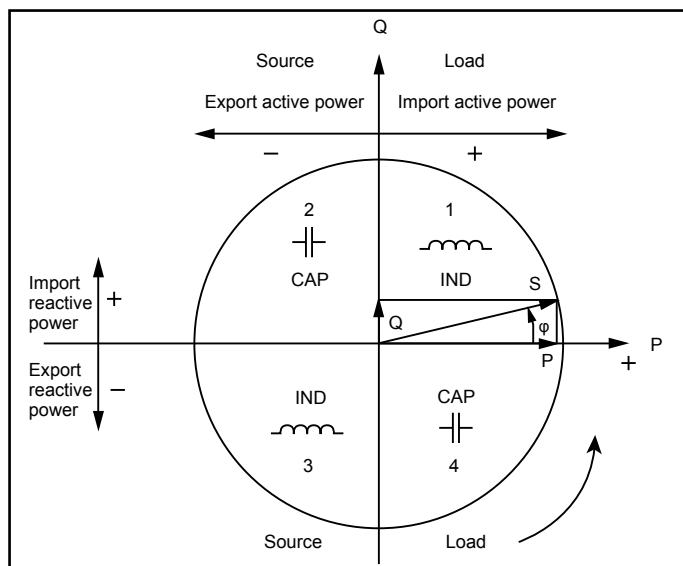

Figure 70

Diagram in accordance with clauses 12 and 14 of IEC 60375.

Reference of this diagram is the current vector (fixed on right-hand line).

The voltage vector V varies its direction according to the phase angle φ .

The phase angle φ between voltage V and current I is taken to be positive in the mathematical sense (counter-clockwise).

A.1.2 Sampling

A.1.2.1 Sampling Period

Depends on main frequency: 50Hz, 60Hz or 400Hz

Sampling period is calculated every second

- Main frequency $f = 50\text{Hz}$
 - Inside 42.5 to 57.5Hz ($50\text{Hz} \pm 15\%$), sampling period is locked to main frequency. 128 samples are available for each main cycle.
 - Outside 42.5 to 57.5Hz, sampling period is $128 \cdot 50\text{Hz}$.
- Main frequency $f = 60\text{Hz}$
 - Inside 51 to 69Hz ($60\text{Hz} \pm 15\%$), sampling period is locked to main frequency. 128 samples are available for each main cycle.
 - Outside 51 to 69Hz, sampling period is $128 \cdot 60\text{Hz}$.

- Main frequency $f = 400\text{Hz}$
 - Inside 340 to 460Hz ($400\text{Hz} \pm 15\%$), sampling period is locked to main frequency. 16 samples are available for each main cycle.
 - Outside 340 to 460Hz, sampling period is $16 \cdot 400\text{Hz}$.

DC is not a frequency parameter for sampling. A pure DC measured signal is considered to be outside the frequency ranges. Then, the sampling frequency is, according to the preselected main frequency, 6.4kHz (50/400Hz) or 7.68kHz (60Hz).

A.1.2.2 Locking of Sampling Frequency

- By default, sampling frequency is locked on V1
- If V1 is missing, sampling frequency tries to lock to V2, then V3, I1, I2 and I3

A.1.2.3 AC/DC

The PEL performs AC and DC measurements for alternative current and/or direct current distribution systems. Selection of AC or DC is done by the user.

AC +DC values are not available with PEL.



NOTE: AC+DC values could be calculated after download using the DataView® software.

A.1.2.4 Measurement of Neutral Current

For the PEL 102 and PEL 103, according to the distribution system, neutral current is calculated.

A.1.2.5 “1 second” Quantities

The instrument calculates the following quantities every second, according to § A.2.

“1 second” quantities are used for:

- Real time values
- “1 second” trends
- Aggregation of values for “aggregated” trends (see § A.1.2.6)
- Min and max determination for “aggregated” trends

All “1 second” quantities are saved on the SD-Card, during the recording time.

A.1.2.6 Aggregation

An aggregated quantity is a value calculated for a defined period, according to the formulas specified in Table 29.

Aggregation periods always start on rounded hours/minutes. Aggregation period is the same for all quantities. The period is one of the following: 1, 2, 3, 4, 5, 6, 10, 12, 15, 20, 30 and 60mn.

All aggregated quantities are saved on the SD-Card, during the recording session. They can be displayed in the PEL Control Panel (see § 4.3).

A.1.2.7 Max

Max represents the maximum values of the “1 second” quantities for the considered aggregation period. They are saved with the date and time of the Max (see Table 28 for the available values).

A.1.2.8 Energy Calculations

Energies are calculated every second.

The “Total” energy is the demand during the recording session.

The “Partial” energy can be determined during an integration period with the following values: 1 h, 1 day, 1 week, 1 month. The partial energy index is available only in real-time. It is not recorded.

However, the “Total” energy is available with the recording session data.

A.2 Measurement Formulas

PEL measures 128 samples per cycle (except 400 Hz with 16 samples) and calculates the voltage, current and active power quantities on a cycle.

PEL instruments measure or calculate the following quantities on a cycle (128 samples per cycle, except 400Hz with 16 samples). Then the PEL calculates an aggregated value for 10 cycles (50Hz), 12 cycles (60Hz) or 80 cycles (400Hz).

The 10/12 cycles quantities (50Hz) are aggregated for 50/60 cycles (“1 second” quantities).

Quantities	Formula	Comments
AC RMS Line-to-neutral voltage (V_L)	$V_L[1s] = \sqrt{\frac{1}{N} \times \sum_1^N v_L^2}$	$v_L = v_1, v_2$ or v_3 elementary sample N = Number of samples
DC voltage (V_L)	$V_L[1s] = \frac{1}{N} \times \sum_1^N v_L$	L = v_1, v_2 or v_3 elementary sample N = Number of samples
AC RMS Line-to-line voltage (U_L)	$U_{ab}[1s] = \sqrt{\frac{1}{N} \times \sum_1^N u_{ab}^2}$	ab = u_{12}, u_{23} or u_{31} elementary sample N = Number of samples
AC RMS Current (I_L)	$I_L[1s] = \sqrt{\frac{1}{N} \times \sum_1^N i_L^2}$	$i_L = i_1, i_2$ or i_3 elementary sample N = Number of samples
DC Current (I_L)	$I_L[1s] = \frac{1}{N} \times \sum_1^N i_L$	$i_L = i_1, i_2$ or i_3 elementary sample N = Number of samples
Voltage crest factor (V-CF)	$V-CF[1s] = \frac{1}{5} \times \sum_1^5 CF_{VL}$	CF_{vL} is the ratio of average crest values and rms value of 10/12 periods
Current crest factor (I-CF)	$I-CF[1s] = \frac{1}{5} \times \sum_1^5 CF_{IL}$	CF_{iL} is the ratio of average crest values and rms value of 10/12 periods
Unbalance (u_2) (real-time only)	$u_2[1s] = \sqrt{\frac{1 - \sqrt{3 - 6\beta}}{1 + \sqrt{3 - 6\beta}}}$ with $\beta = \frac{U_{12fund}^4 + U_{23fund}^4 + U_{31fund}^4}{(U_{12fund}^2 + U_{23fund}^2 + U_{31fund}^2)^2}$	
Active Power (P_L)	$P_L[1s] = \frac{1}{N} \times \sum_1^N (v_L \times i_L)$	L = I1, I2 or I3 elementary sample N = Number of samples $P_T[1s] = P_1[1s] + P_2[1s] + P_3[1s]$
Reactive Power (Q_L)	$Q_L[1s] = sign[1s] \times \sqrt{S_L^2[1s] - P_L^2[1s]}$	Reactive power includes harmonics. "sign[1s]" is the reactive power sign
	$Q_T[1s] = Q_1[1s] + Q_2[1s] + Q_3[1s]$	Total reactive power calculation $Q_T[1s]$ is vector.
Apparent Power (S_L)	$S_L[1s] = V_L[1s] \times I_L[1s]$	
	$S_T[1s] = S_1[1s] + S_2[1s] + S_3[1s]$	Total apparent power $S_T[1s]$ is an arithmetic value
Power Factor (PF_L)	$PF_L[1s] = \frac{P_L[1s]}{S_L[1s]}$	

Quantities	Formula	Comments
$\cos \varphi_L$	$\cos(\varphi_L)[1s] = \frac{1}{5} \times \sum_1^5 \cos(\varphi_L)[10/12]$	$\cos \varphi$ [10/12] is the cosinus of the difference between the phase of the fundamental of the current I and the phase of the fundamental of the line-to-neutral voltage V for 10/12 cycles values
TAN φ	$tg(\varphi)[1s] = \frac{1}{5} \times \sum_1^5 \frac{Q[10/12]}{P[10/12]}$	Q[10/12] and P[10/12] are the 10/12 periods value for Q and P.
Line-to-neutral voltage harmonic distortion rate THD_VL (%)	$THD_V=100 \times \sqrt{\frac{(V_{eff}^2 - V_m^2)}{V_m^2}}$	THD is calculated as % of fundamental VH1 is the value of fundamental
Line-to-line voltage harmonic distortion rate THD_Uab (%)	$THD_U=100 \times \sqrt{\frac{(U_{eff}^2 - U_m^2)}{U_m^2}}$	THD is calculated as % of fundamental UH1 is the value of fundamental
Current harmonic distortion rate THD_IL (%)	$THD_I=100 \times \sqrt{\frac{(I_{eff}^2 - I_m^2)}{I_m^2}}$	THD is calculated as % of fundamental IH1 is the value of fundamental

Table 28

A.3 Aggregation

Aggregated quantities are calculated for a defined period according to the following formulas based on 50/60 cycles. Aggregation can be averaging or quadratic averaging, or other methods.

Quantities	Formula
Line-to-neutral voltage (V_L) (RMS)	$V_L[agg] = \sqrt{\frac{1}{N} \times \sum_{x=0}^{N-1} V_{Lx}^2[1s]}$
Line-to-neutral voltage (V_L) (DC)	$V_L[agg] = \frac{1}{N} \times \sum_{x=0}^{N-1} V_{Lx}[200ms]$
Line-to-line voltage (U_{ab}) (RMS)	$U_{ab}[agg] = \sqrt{\frac{1}{N} \times \sum_{x=0}^{N-1} U_{abx}^2[1s]}$ ab = 12, 23 or 31
Current (I_L) (RMS)	$I_L[agg] = \sqrt{\frac{1}{N} \times \sum_{x=0}^{N-1} I_{Lx}^2[1s]}$
Current (I_L) (DC)	$I_L[agg] = \frac{1}{N} \times \sum_{x=0}^{N-1} I_{Lx}[200ms]$
Voltage crest factor (CF_{VL})	$CF_{VL}[agg] = \frac{1}{N} \times \sum_1^N CF_{VL}[1s]$
Current crest factor (CF_{IL})	$CF_{IL}[agg] = \frac{1}{N} \times \sum_1^N CF_{IL}[1s]$
Frequency (F)	$F[agg] = \frac{1}{N} \times \sum_{x=0}^{N-1} F_x[1s]$
Active Power on source (P_L)	$P_{SL}[agg] = \frac{1}{N} \times \sum_{x=0}^{N-1} P_{SLx}[1s]$
Active Power on load (P_L)	$P_{SL}[agg] = \frac{1}{N} \times \sum_{x=0}^{N-1} P_{SLx}[1s]$
Reactive Power on source (Q_L)	$Q_{SL}[agg] = \frac{1}{N} \times \sum_{x=0}^{N-1} Q_{SLx}[1s]$

Quantities	Formula
Reactive Power on load (Q_L)	$Q_{RL}[agg] = \frac{1}{N} \times \sum_{x=0}^{N-1} Q_{RLx}[1s]$
Apparent Power (S_L)	$S_L[agg] = \frac{1}{N} \times \sum_{x=0}^{N-1} S_{Lx}[1s]$
Power Factor on source (PF_L) with associated quadrant	$PF_{SL}[agg] = \frac{1}{N} \times \sum_{x=0}^{N-1} PF_{SLx}[1s]$
Active Power on load (P_L)	$P_{SL}[agg] = \frac{1}{N} \times \sum_{x=0}^{N-1} P_{SLx}[1s]$
Reactive Power on source (Q_L)	$Q_{SL}[agg] = \frac{1}{N} \times \sum_{x=0}^{N-1} Q_{SLx}[1s]$
Reactive Power on load (Q_L)	$Q_{RL}[agg] = \frac{1}{N} \times \sum_{x=0}^{N-1} Q_{RLx}[1s]$
Apparent Power (S_L)	$S_L[agg] = \frac{1}{N} \times \sum_{x=0}^{N-1} S_{Lx}[1s]$
Power Factor on source (PF_L) with associated quadrant	$PF_{SL}[agg] = \frac{1}{N} \times \sum_{x=0}^{N-1} PF_{SLx}[1s]$
Power Factor on load (PF_L) with associated quadrant	$PF_{RL}[agg] = \frac{1}{N} \times \sum_{x=0}^{N-1} PF_{RLx}[1s]$
Cos ϕ_L on source with associated quadrant	$\text{Cos}(\phi_L)_S[agg] = \frac{1}{N} \times \sum_{x=0}^{N-1} \text{Cos}(\phi_L)_{Sx}[1s]$
Cos ϕ_L on load with associated quadrant	$\text{Cos}(\phi_L)_R[agg] = \frac{1}{N} \times \sum_{x=0}^{N-1} \text{Cos}(\phi_L)_{Rx}[1s]$
Tan ϕ_S on source	$\text{Tan}(\phi)_S[agg] = \frac{1}{N} \times \sum_{x=0}^{N-1} \text{Tan}(\phi)_{Sx}[1s]$
Tan ϕ_L on load	$\text{Tan}(\phi)_R[agg] = \frac{1}{N} \times \sum_{x=0}^{N-1} \text{Tan}(\phi)_{Rx}[1s]$
Line-to-neutral voltage harmonic distortion rate THD $_V$ (%)	$THD_V_L[agg] = \frac{1}{N} \times \sum_{x=0}^{N-1} THD_V_{Lx}[1s]$
Line-to-line voltage harmonic distortion rate THD $_U$ (%)	$THD_U_{ab}[agg] = \frac{1}{N} \times \sum_{x=0}^{N-1} THD_U_{abx}[1s]$
Current harmonic distortion rate THD $_I$ (%)	$THD_I_L[agg] = \frac{1}{N} \times \sum_{x=0}^{N-1} THD_I_{Lx}[1s]$

Table 29

NOTE: N is the number of “1 second” values for the considered aggregation period (1, 2, 3, 4, 5, 6, 10, 12, 15, 20, 30 or 60 min).

A.4 Supported Electrical Networks

The following types of distribution systems are supported:



- V1, V2, V3 are the line-to-neutral voltages of the installation under test
- $[V1=VL1-N; V2=VL2-N; V3=VL3-N]$.
- Low caps v1, v2, v3 are used for time values
- U12, U23, U31 are the line-to-line voltages of the installation under test.
- Low caps are used for time values $[u12 = v1-v2; u23= v2-v3, u31=v3-v1]$
- I1, I2, I3 are the currents flowing in the line conductors of the installation under test.
- Low caps i1, i2, i3 are used for time values

Distribution System	Abbreviation	Comments	Reference Diagram
Single phase (1-Phase 2-Wire)	1P-2W	Voltage measurements are performed between L1 and N. Current measurements are performed on L1 conductor.	see § 3.6.1
Split phase (1-Phase 3-Wire)	1P-3W	Voltage measurements are performed between L1, L2 and N. Current measurements are performed on L1 and L2 conductors. Neutral current is calculated: $iN = i1 + i2$	see § 3.6.2
3-Phase 3-Wire Δ [2 current sensors]	3P-3W Δ 2	Power measurement method is based on 3 wattmeters method with virtual neutral.	see § 3.6.3.1
3-Phase 3-Wire Open- Δ [2 current sensors]	3P-3WO2	Voltage measurements are performed between L1, L2 and L3. Current measurements are performed on L1 and L3 conductors. I2 current is calculated (no current sensor connected on L2): $i2 = -i1 - i3$	see § 3.6.3.3
3-Phase 3-Wire Y [2 current sensors]	3P-3WY2	Neutral is not available for current and voltage measurement	see § 3.6.3.5
3-Phase 3-Wire Δ	3P-3W Δ 3	Power measurement method is based on 3 wattmeters method with virtual neutral.	see § 3.6.3.2
3-Phase 3-Wire Open- Δ	3P-3WO3	Voltage measurements are performed between L1, L2 and L3. Current measurements are performed on L1, L2 and L3 conductors.	see § 3.6.3.4
3-Phase 3-Wire Y	3P-3WY3	Neutral is not available for current and voltage measurement	see § 3.6.3.6
3-Phase 3-Wire Δ balanced	3P-3W Δ B	Power measurement is based on 1 wattmeter method. Voltage measurements are performed between L1 and L2. Current measurements are performed on L3 conductor. $U23 = U31 = U12$. $I1 = I2 = I3$	see § 3.6.3.7
3-Phase 4-Wire Y	3P-4WY	Power measurement method is based on 3 wattmeters method with neutral. Voltage measurements are performed between L1, L2 and L3. Current measurements are performed on L1, L2 and L3 conductors. Neutral current is calculated: $iN = i1 + i2 + i3$.	see § 3.6.4.1
3-Phase 4-Wire Y balanced	3P-4WYB	Power measurement is based on single phase wattmeter method. Voltage measurements are performed between L1 and N. Current measurements are performed on L1 conductor. $V1 = V2 = V3$ $U23 = U31 = U12 = V1 \times \sqrt{3}$. $I1 = I2 = I3$	see § 3.6.4.2

3-Phase 4-Wire Y 2½	3P-4WY2	<p>This method is named 2½ element method.</p> <p>Power measurement method is based on 3 wattmeters method with virtual neutral.</p> <p>Voltage measurements are performed between L1, L3 and N.</p> <p>V2 is calculated: $v_2 = -v_1 - v_3$, $u_{12} = 2 \cdot v_1 + v_3$, $u_{23} = -v_1 - 2 \cdot v_3$. It supposes that V2 is balanced.</p> <p>Current measurements are performed on L1, L2 and L3 conductors.</p> <p>Neutral current is calculated: $i_N = i_1 + i_2 + i_3$</p>	see § 3.6.4.3
3-Phase 4-Wire Δ	3P-4WΔ	<p>Power measurement method is based on 3 wattmeters method with neutral, but no power information for each phase is available.</p> <p>Voltage measurements are performed between L1, L2 and L3.</p>	see § 3.6.5.1
3-Phase 4-Wire Open-Δ	3P-4WOΔ	<p>Current measurements are performed on L1, L2 and L3 conductors.</p> <p>Neutral current is calculated only for a transformer branch: $i_N = i_1 + i_2$</p>	see § 3.6.5.2
DC 2-Wire	DC-2W	<p>Voltage measurements are performed between L1 and N.</p> <p>Current measurements are performed on L1 conductor.</p>	see § 3.6.6.1
DC 3-Wire	DC-3W	<p>Voltage measurements are performed between L1, L2 and N.</p> <p>Current measurements are performed on L1 and L2 conductors.</p> <p>Negative (return) current is calculated : $i_N = i_1 + i_2$</p>	see § 3.6.6.2
DC 4-Wire	DC-4W	<p>Voltage measurements are performed between L1, L2, L3 and N.</p> <p>Current measurements are performed on L1, L2 and L3 conductors.</p> <p>Negative (return) current is calculated : $i_N = i_1 + i_2 + i_3$</p>	see § 3.6.6.3

Table 30

A.5 Phase Order

Every second, the PEL determines the phase order. If the phase order is incorrect, the red Phase Order indicator  on the PEL front panel blinks (see § 2.11). In addition, on the PEL 103, the Phase Order Incorrect icon  appears on the LCD Display screen.

Setting the correct phase order for a distribution system requires that the current phase order, voltage phase order, and current vs voltage phase order for that distribution system are all correct. Note that:

- Phase order for voltage channels only is displayed when voltages are displayed on the LCD screen. The voltage phase order is derived from the FFT analysis.
- Phase order for current channels only is displayed when currents are displayed.
- Phase order for voltage and current channels is displayed when the other screens are displayed.
- Load or Source is set by the DataView PEL Control Panel.

In some distribution systems (such as DC) the phase order does not apply in every instance.

The following three tables show information for each distribution system for setting the correct current phase order, voltage phase order, and current vs voltage phase order respectively.

A.5.1 Current Phase Order

Distribution System	Abbreviation	Current Phase Order	Comments
Single phase (1-Phase 2-Wire)	1P-2W	No	
Split phase (1-Phase 3-Wire)	1P-3W	Yes	$\phi (I_2, I_1) = 180^\circ \pm 30^\circ$
3-Phase 3-Wire Δ [2 current sensors]	3P-3W Δ 2	Yes	$\phi (I_1, I_3) = 120^\circ \pm 30^\circ$ No I2 current sensors
3-Phase 3-Wire Open- Δ [2 current sensors]	3P-3WO2		
3-Phase 3-Wire Y [2 current sensors]	3P-3WY2		
3-Phase 3-Wire Δ	3P-3W Δ 3	Yes	$[\phi (I_1, I_3), \phi (I_3, I_2), \phi (I_2, I_1)] = 120^\circ \pm 30^\circ$
3-Phase 3-Wire Open- Δ	3P-3WO3		
3-Phase 3-Wire Y	3P-3WY3		
3-Phase 3-Wire Δ balanced	3P-3W Δ B	No	
3-Phase 4-Wire Y	3P-4WY	Yes	$[\phi (I_1, I_3), \phi (I_3, I_2), \phi (I_2, I_1)] = 120^\circ \pm 30^\circ$
3-Phase 4-Wire Y balanced	3P-4WYB	No	
3-Phase 4-Wire Y 2½	3P-4WY2	Yes	$[\phi (I_1, I_3), \phi (I_3, I_2), \phi (I_2, I_1)] = 120^\circ \pm 30^\circ$

3-Phase 4-Wire Δ	3P-4W Δ	Yes	$[\phi (I1, I3), \phi (I3, I2), \phi (I2, I1)] = 120^\circ \pm 30^\circ$
3-Phase 4-Wire Open- Δ	3P-4WO Δ		
DC 2-Wire	DC-2W	No	
DC 3-Wire	DC-3W	No	
DC 4-Wire	DC-4W	No	

A.5.2 Voltage Phase Order

Distribution System	Abbreviation	Voltage Phase Order	Comments
Single phase (1-Phase 2-Wire)	1P-2W	No	
Split phase (1-Phase 3-Wire)	1P-3W	Yes	$\phi (V2, V1) = 180^\circ \pm 10^\circ$
3-Phase 3-Wire Δ [2 current sensors]	3P-3W Δ 2	Yes (on U)	$[\phi (U12, U31), \phi (U31, U23), \phi (U23, U12)] = 120^\circ \pm 10^\circ$
3-Phase 3-Wire Open- Δ [2 current sensors]	3P-3WO2		
3-Phase 3-Wire Y [2 current sensors]	3P-3WY2		
3-Phase 3-Wire Δ	3P-3W Δ 3		
3-Phase 3-Wire Open- Δ	3P-3WO3		
3-Phase 3-Wire Y	3P-3WY3		
3-Phase 3-Wire Δ balanced	3P-3W Δ B	No	
3-Phase 4-Wire Y	3P-4WY	Yes (on V)	$[\phi (V1, V3), \phi (V3, V2), \phi (V2, V1)] = 120^\circ \pm 10^\circ$
3-Phase 4-Wire Y balanced	3P-4WYB	No	
3-Phase 4-Wire Y 2½	3P-4WY2	Yes (on V)	$\phi (V1, V3) = 120^\circ \pm 10^\circ$ No V2
3-Phase 4-Wire Δ	3P-4W Δ	Yes (on U)	$\phi (V1, V3) = 180^\circ \pm 10^\circ$ $[\phi (U12, U31), \phi (U31, U23), \phi (U23, U12)] = 120^\circ \pm 10^\circ$
3-Phase 4-Wire Open- Δ	3P-4WO Δ		
DC 2-Wire	DC-2W	No	
DC 3-Wire	DC-3W	No	
DC 4-Wire	DC-4W	No	

A.5.3 Current vs Voltage Phase Order

Distribution System	Abbreviation	Current vs Voltage Phase Order	Comments
Single phase (1-Phase 2-Wire)	1P-2W	Yes	$\phi(I1, V1) = 0^\circ \pm 60^\circ$ for load $\phi(I1, V1) = 180^\circ \pm 60^\circ$ for source
Split phase (1-Phase 3-Wire)	1P-3W	Yes	$[\phi(I1, V1), \phi(I2, V2)] = 0^\circ \pm 60^\circ$ for load $[\phi(I1, V1), \phi(I2, V2)] = 180^\circ \pm 60^\circ$ for source
3-Phase 3-Wire Δ [2 current sensors]	3P-3W Δ 2	Yes	$[\phi(I1, U12), \phi(I3, U31)] = 30^\circ \pm 60^\circ$ for load $[\phi(I1, U12), \phi(I3, U31)] = 210^\circ \pm 60^\circ$ for source No I2 current sensor
3-Phase 3-Wire Open- Δ [2 current sensors]	3P-3WO2		
3-Phase 3-Wire Y [2 current sensors]	3P-3WY2		
3-Phase 3-Wire Δ	3P-3W Δ 3	Yes	$[\phi(I1, U12), \phi(I2, U23), \phi(I3, U31)] = 30^\circ \pm 60^\circ$ for load $[\phi(I1, U12), \phi(I2, U23), \phi(I3, U31)] = 210^\circ \pm 60^\circ$ for source
3-Phase 3-Wire Open- Δ	3P-3WO3		
3-Phase 3-Wire Y	3P-3WY3		
3-Phase 3-Wire Δ balanced	3P-3W Δ B	Yes	$\phi(I3, U12) = 90^\circ \pm 60^\circ$ for load $\phi(I3, U12) = 270^\circ \pm 60^\circ$ for source
3-Phase 4-Wire Y	3P-4WY	Yes	$[\phi(I1, V1), \phi(I2, V2), \phi(I3, V3)] = 0^\circ \pm 60^\circ$ for load $[\phi(I1, V1), \phi(I2, V2), \phi(I3, V3)] = 180^\circ \pm 60^\circ$ for source
3-Phase 4-Wire Y balanced	3P-4WYB	Yes	$\phi(I1, V1) = 0^\circ \pm 60^\circ$ for load $\phi(I1, V1) = 180^\circ \pm 60^\circ$ for source
3-Phase 4-Wire Y 2½	3P-4WY2	Yes	$[\phi(I1, V1), \phi(I3, V3)] = 0^\circ \pm 60^\circ$ for load $[\phi(I1, V1), \phi(I3, V3)] = 180^\circ \pm 60^\circ$ for source No V2
3-Phase 4-Wire Δ	3P-4W Δ	Yes	$[\phi(I1, U12), \phi(I2, U23), \phi(I3, U31)] = 30^\circ \pm 60^\circ$ for load $[\phi(I1, U12), \phi(I2, U23), \phi(I3, U31)] = 210^\circ \pm 60^\circ$ for source
3-Phase 4-Wire Open- Δ	3P-4WO Δ		
DC 2-Wire	DC-2W	No	
DC 3-Wire	DC-3W	No	
DC 4-Wire	DC-4W	No	

A.6 Quantities According to the Supply Systems

● = YES

Quantities		1P-2W	1P-3W	3P-3W Δ 2 3P-3WO2 3P-3WY2	3P-3W Δ 3 3P-3WO3 3P-3WY3	3P-3W Δ B	3P-4WY	3P-4WYB	3P-4WY2	3P-4W Δ 3P-4WO Δ	DC-2W	DC-3W	DC-4W
V_1	RMS	●	●				●	●	●	●			
V_2	RMS		●				●	●(1)	●(1)	●			
V_3	RMS						●	●(1)	●	●			
V_1	DC										●	●	●
V_2	DC											●	●
V_3	DC												●
U_{12}	RMS		●	●	●	●	●	●(1)	●(1)	●			
U_{23}	RMS			●	●	●(1)	●	●(1)	●(1)	●			
U_{31}	RMS			●	●	●(1)	●	●(1)	●	●			
I_1	RMS	●	●	●	●	●	●	●	●	●			
I_2	RMS		●	●(2)	●	●(1)	●	●(1)	●	●			
I_3	RMS			●	●	●(1)	●	●(1)	●	●			
I_N	RMS		●(5)				●(5)	●(1)	●(5)	●(5)			
I_1	DC										●	●	●
I_2	DC											●	●
I_3	DC												●
I_N	DC											●(5)	●(5)
$V1_{CF}$		●	●				●	●	●	●			
$V2_{CF}$			●				●	●(1)	●	●			
$V3_{CF}$							●	●(1)	●	●			
$I1_{CF}$		●	●	●	●	●	●	●	●	●			
$I2_{CF}$			●	●(2)	●	●(1)	●	●(1)	●	●			
$I3_{CF}$				●	●	●	●	●(1)	●	●			
u_2				●	●	●(4)	●	●(4)	●(4)	●(3)			
F		●	●	●	●	●	●	●	●	●			
P_1		●	●				●	●	●	●	●	●	●
P_2			●				●	●(1)	●(1)	●(3)		●	●
P_3							●	●(1)	●	●			●
P_T			●	●	●	●	●	●(1)	●	●		●	●
P_1	Source	●	●				●	●	●	●	●	●	●
P_2	Source		●				●	●(1)	●(1)	●(3)		●	●
P_3	Source						●	●(1)	●	●			●
P_T	Source		●	●	●	●	●	●(1)	●	●		●	●
P_1	Load	●	●				●	●	●	●	●	●	●
P_2	Load		●				●	●(1)	●(1)	●(3)		●	●
P_3	Load						●	●(1)	●	●			●
P_T	Load		●	●	●	●	●	●(1)	●	●		●	●
Q_1		●	●				●	●	●	●			
Q_2			●				●	●(1)	●(1)	●(3)			
Q_3							●	●(1)	●	●			
Q_T			●	●	●	●	●	●(1)	●	●			

Quantities		1P-2W	1P-3W	3P-3W Δ 2 3P-3WO2 3P-3WY2	3P-3W Δ 3 3P-3WO3 3P-3WY3	3P-3W Δ B	3P-4WY	3P-4WYB	3P-4WY2	3P-4W Δ 3P-4WO Δ	DC-2W	DC-3W	DC-4W
Q ₁	Source	●	●				●	●	●	●			
Q ₂	Source		●				●	●(1)	●(1)	●(3)			
Q ₃	Source						●	●(1)	●	●			
Q _T	Source		●	●	●	●	●	●(1)	●	●			
Q ₁	Load	●	●				●	●	●	●			
Q ₂	Load		●				●	●(1)	●(1)	●(3)			
Q ₃	Load						●	●(1)	●	●			
Q _T	Load		●	●	●	●	●	●(1)	●	●			
S ₁		●	●				●	●	●	●			
S ₂			●				●	●(1)	●(1)	●(3)			
S ₃							●	●(1)	●	●			
S _T			●	●	●	●	●	●(1)	●	●			
PF ₁		●	●				●	●	●	●			
PF ₂			●				●	●(1)	●(1)	●(3)			
PF ₃							●	●(1)	●	●			
PF _T			●	●	●	●	●	●(1)	●	●			
PF ₁	Source	●	●				●	●	●	●			
PF ₂	Source		●				●	●(1)	●(1)	●(3)			
PF ₃	Source						●	●(1)	●	●			
PF _T	Source		●	●	●	●	●	●(1)	●	●			
PF ₁	Load	●	●				●	●	●	●			
PF ₂	Load		●				●	●(1)	●(1)	●(3)			
PF ₃	Load						●	●(1)	●	●			
PF _T	Load		●	●	●	●	●	●(1)	●	●			
Cos φ_1		●	●				●	●	●	●			
Cos φ_2			●				●	●(1)	●(1)	●(3)			
Cos φ_3							●	●(1)	●	●			
Cos φ_T			●	●	●	●	●	●(1)	●	●			
Cos φ_1	Source	●	●				●	●	●	●			
Cos φ_2	Source		●				●	●(1)	●(1)	●(3)			
Cos φ_3	Source						●	●(1)	●	●			
Cos φ_M	Source		●	●	●	●	●	●(1)	●	●			
Cos φ_1	Load	●	●				●	●	●	●			
Cos φ_2	Load		●				●	●(1)	●(1)	●(3)			
Cos φ_3	Load						●	●(1)	●	●			
Cos φ_T	Load		●	●	●	●(3)	●	●(1)	●	●			
TAN Φ		●	●	●	●	●(3)	●	●	●(1)	●(3)			
TAN Φ	Source	●	●	●	●	●(3)	●	●	●	●			
TAN Φ	Load	●	●	●	●	●(3)	●	●	●	●			
Hi_V ₁	i=1 to 50(6)	●	●				●	●	●	●			
Hi_V ₂		●					●	●(1)	●	●(3)			
Hi_V ₃								●	●(1)	●	●		

Quantities		1P-2W	1P-3W	3P-3W Δ 2 3P-3W Δ 3 3P-3W Δ B	3P-3W Δ 3 3P-3W Δ O3 3P-3W Δ Y3	3P-3W Δ B	3P-4WY	3P-4WYB	3P-4WY2	3P-4W Δ 3P-4W Δ O Δ	DC-2W	DC-3W	DC-4W
Hi_U ₁₂	i=1 to 50(6)		●	●	●	●	●	●(1)	●(1)	●			
Hi_U ₂₃				●	●	●(1)	●	●(1)	●(1)	●			
Hi_U ₃₁				●	●	●(1)	●	●(1)	●	●			
Hi_I ₁	i=1 to 50(6)	●	●	●	●	●	●	●	●	●			
Hi_I ₂			●	●(2)	●	●(1)	●	●(1)	●	●			
Hi_I ₃				●	●	●(1)	●	●(1)	●	●			
Hi_I _N			●(2)				●(2)	●(1)	●(2)	●(2)			
THD_V ₁		●	●				●	●	●	●			
THD_V ₂			●				●	●(1)	●	●(3)			
THD_V ₃							●	●(1)	●	●			
THD_U ₁₂			●	●	●	●	●	●(1)	●(1)	●			
THD_U ₂₃				●	●	●(1)	●	●(1)	●(1)	●			
THD_U ₃₁				●	●	●(1)	●	●(1)	●	●			
THD_I ₁		●	●	●	●	●	●	●	●	●			
THD_I ₂			●	●(2)	●	●(1)	●	●(1)	●	●			
THD_I ₃				●	●	●(1)	●	●(1)	●	●			
THD_I _N			●(2)				●(2)	●(1)	●(2)	●(2)			
V ₁ Angle		●	●				●	●	●	●			
V ₂ Angle			●				●	●(1)	●(1)	●(3)			
V ₃ Angle							●	●(1)	●	●			
U ₁₂ Angle			●	●	●	●	●	●(1)	●(1)	●			
U ₂₃ Angle				●	●	●(1)	●	●(1)	●(1)	●			
U ₃₁ Angle				●	●	●(1)	●	●(1)	●	●			
I ₁ Angle		●	●	●	●	●	●	●	●	●			
I ₂ Angle			●	●(2)	●	●(1)	●	●(1)	●	●			
I ₃ Angle				●	●	●(1)	●	●(1)	●	●			

Table 31

(1) Extrapolated

(2) Calculated

(3) Not a significant value

(4) Always = 0

(5) Calculated

(6) Rank 7 for 400Hz

A.7 Glossary of Terms

Symbol or Terminology	Description
≈	AC and DC components.
~	AC component only.
≡	DC component only.
∠	Inductive phase shift.
∠	Capacitive phase shift.
°	Degree.
%	Percentage.

Symbol or Terminology	Description
CF	Crest factor (Peak Factor) in current or voltage: ratio of the peak value of a signal to the RMS value.
Cos φ	Cosine of the phase shift of the fundamental voltage with respect to the fundamental current.
DC	DC component (current or voltage)
Ep	Abbreviation for active energy.
Eq	Abbreviation for reactive energy.
Es	Abbreviation for apparent energy.
Frequency	Number of full voltage or current cycles in one second.
Fundamental Component	Component at the fundamental frequency.
Harmonics	In electrical systems, voltages and currents at frequencies that are multiples of the fundamental frequency.
Hz	Frequency of network studied.
I	Abbreviation for current.
I-CF	Crest (peak) factor of current.
I-THD	Total harmonic distortion of current.
I_x-H_h	Current value or percentage for harmonic rank n.
L	Phase (Line).
MAX	Maximum value
Measurement Method	All measurement methods associated to an individual measurement.
MIN	Minimum value
Nominal Voltage	Reference voltage of a network.
P	Abbreviation for active power.
PF	Power Factor: ratio of active power to apparent power.
Phase	Temporal relationship between current and voltage in alternating current circuits.
Q	Abbreviation for reactive power.
Rank of a Harmonic	Ratio of the frequency of the harmonic to the fundamental frequency; a whole number.
RMS	RMS (Root Mean Square) value of current or voltage. Square root of the mean of the squares of the instantaneous values of a quantity during a specified interval.
S	Abbreviation for apparent power.
Tan Φ	Ratio between reactive power and active power.
THD	Total Harmonic Distortion. The total harmonic distortion describes the proportion of the harmonics of a signal with respect to the fundamental RMS value (%f).
U	Phase-to-phase voltage
U-CF	Phase-to-phase voltage crest factor
U_h	Phase-to-phase voltage harmonic
Unbalance in voltage in a polyphased electrical power network	Status where efficient values for voltages between conductors (fundamental component) and/or differences in phase between successive conductors are not equal.
U_x-H_n	Phase-to-phase voltage value or percentage for harmonic rank n.
U_{xy}-THD	Total phase-to-phase voltage harmonic distortion.
V	Abbreviation for phase-to-neutral voltage or the unit "volt".
V-CF	Voltage crest (peak) factor.
VA	Apparent power unit (Volt - Ampere).
var	Reactive power unit.
varh	Reactive energy unit.
V-THD	Voltage crest (peak) factor.
V_h	Phase-to-neutral voltage harmonic.
V	True RMS phase-to-neutral voltage.
V-THD	Total harmonic distortion of phase-to-neutral voltage.
V_{unb}	Phase-to-neutral voltage unbalance.

Symbol or Terminology	Description
Vx-Hn	Phase-to-neutral voltage value or percentage for harmonic rank n.
W	Active power unit (Watt).
Wh	Active energy unit (Watt - hour).

Table 32

Prefixes of International System (SI) units

Prefix	Symbol	Multiplies by
milli	m	10^{-3}
kilo	k	10^3
Mega	M	10^6
Giga	G	10^9
Tera	T	10^{12}
Peta	P	10^{15}
Exa	E	10^{18}

Table 33

REPAIR AND CALIBRATION

To ensure that your instrument meets factory specifications, we recommend that it be scheduled back to our factory Service Center at one-year intervals for recalibration, or as required by other standards or internal procedures.

For instrument repair and calibration:

You must contact our Service Center for a Customer Service Authorization Number (CSA#). This will ensure that when your instrument arrives, it will be tracked and processed promptly. Please write the CSA# on the outside of the shipping container. If the instrument is returned for calibration, we need to know if you want a standard calibration, or a calibration traceable to N.I.S.T. (Includes calibration certificate plus recorded calibration data).

Ship To: Chauvin Arnoux®, Inc. d.b.a. AEMC® Instruments
15 Faraday Drive • Dover, NH 03820 USA
Phone: (800) 945-2362 (Ext. 360)
(603) 749-6434 (Ext. 360)
Fax: (603) 742-2346 or (603) 749-6309
E-mail: repair@aemc.com

(Or contact your authorized distributor)

Costs for repair, standard calibration, and calibration traceable to N.I.S.T. are available.

NOTE: You must obtain a CSA# before returning any instrument.

TECHNICAL AND SALES ASSISTANCE

If you are experiencing any technical problems, or require any assistance with the proper operation or application of your instrument, please call, fax or e-mail our technical support team:

Chauvin Arnoux®, Inc. d.b.a. AEMC® Instruments
Phone: (800) 343-1391 • (508) 698-2115
Fax: (508) 698-2118
E-mail: techsupport@aemc.com

LIMITED WARRANTY

The Model PEL 102 & 103 are warranted to the owner for a period of two years from the date of original purchase against defects in manufacture. This limited warranty is given by AEMC® Instruments, not by the distributor from whom it was purchased. This warranty is void if the unit has been tampered with, abused or if the defect is related to service not performed by AEMC® Instruments.

Full warranty coverage and product registration is available on our website at: www.aemc.com/warranty.html.

Please print the online Warranty Coverage Information for your records.

What AEMC® Instruments will do:

If a malfunction occurs within the two-year period, you may return the instrument to us for repair, provided we have your warranty registration information on file or a proof of purchase. AEMC® Instruments will, at its option, repair or replace the faulty material.

WARRANTY REPAIRS

What you must do to return an Instrument for Warranty Repair:

First, request a Customer Service Authorization Number (CSA#) by phone or by fax from our Service Department (see address below), then return the instrument along with the signed CSA Form. Please write the CSA# on the outside of the shipping container. Return the instrument, postage or shipment pre-paid to:

Ship To: Chauvin Arnoux®, Inc. d.b.a. AEMC® Instruments
15 Faraday Drive • Dover, NH 03820 USA
Phone: (800) 945-2362 (Ext. 360)
(603) 749-6434 (Ext. 360)
Fax: (603) 742-2346 or (603) 749-6309
E-mail: repair@aemc.com

Caution: To protect yourself against in-transit loss, we recommend you insure your returned material.

NOTE: You must obtain a CSA# before returning any instrument.



99-MAN 100412
v24 9/18