



**Advanced Test Equipment Rentals**  
**www.atecorp.com 800-404-ATEC (2832)**

**Agilent E5070B/E5071B ENA Series RF Network Analyzers**

# **Installation and Quick Start Guide**

**Seventh Edition**



**Manufacturing No. E5070-90081**  
**November 2007**

---

## Notices

The information contained in this document is subject to change without notice.

This document contains proprietary information that is protected by copyright. All rights are reserved. No part of this document may be photocopied, reproduced, or translated to another language without the prior written consent of Agilent Technologies.

Microsoft®, MS-DOS®, Windows®, Visual C++®, Visual Basic®, VBA® and Excel® are registered

UNIX is a registered trademark in U.S. and other countries, licensed exclusively through X/Open Company Limited.

Portions ©Copyright 1996, Microsoft Corporation. All rights reserved.

© Copyright 2002, 2003, 2004, 2005, 2007 Agilent Technologies

---

## Manual Printing History

The manual's printing date and part number indicate its current edition. The printing date changes when a new edition is printed (minor corrections and updates that are incorporated at reprint do not cause the date to change). The manual part number changes when extensive technical changes are incorporated.

August 2002	First Edition (part number: E5070-90031)
March 2003	Second Edition (part number: E5070-90041, revising minor errata)
July 2003	Third Edition (part number: E5070-90051, add Standard accessories)
January 2004	Fourth Edition (part number: E5070-90051, add power cable information, notes, and cautions)
May 2005	Fifth Edition (part number: E5070-90061, add Standard accessories)
February 2007	Sixth Edition (part number: E5070-90071)
November 2007	Seventh Edition (part number: E5070-90081)

---

## Safety Summary

The following general safety precautions must be observed during all phases of operation, service, and repair of this instrument. Failure to comply with these precautions or with specific WARNINGS elsewhere in this manual may impair the protection provided by the equipment. Such noncompliance would also violate safety standards of design, manufacture, and intended use of the instrument. Agilent Technologies assumes no liability for the customer's failure to comply with these precautions.

---

**NOTE**

The E5070B/E5071B complies with INSTALLATION CATEGORY II as well as POLLUTION DEGREE 2 in IEC61010-1. The E5070B/E5071B is an INDOOR USE product.

---

---

**NOTE**

The LEDs in the E5070B/E5071B are Class 1 in accordance with IEC60825-1, CLASS 1 LED PRODUCT

---

- **Ground the Instrument**

To avoid electric shock, the instrument chassis and cabinet must be grounded with the supplied power cable's grounding prong.
- **DO NOT Operate in an Explosive Atmosphere**

Do not operate the instrument in the presence of inflammable gasses or fumes. Operation of any electrical instrument in such an environment clearly constitutes a safety hazard.
- **Keep Away from Live Circuits**

Operators must not remove instrument covers. Component replacement and internal adjustments must be made by qualified maintenance personnel. Do not replace components with the power cable connected. Under certain conditions, dangerous voltage levels may remain even after the power cable has been disconnected. To avoid injuries, always disconnect the power and discharge circuits before touching them.
- **DO NOT Service or Adjust the Instrument Alone**

Do not attempt internal service or adjustment unless another person, capable of rendering first aid and resuscitation, is present.
- **DO NOT Substitute Parts or Modify the Instrument**

To avoid the danger of introducing additional hazards, do not install substitute parts or perform unauthorized modifications to the instrument. Return the instrument to an Agilent Technologies Sales and Service Office for service and repair to ensure that safety features are maintained in operational condition.
- **Dangerous Procedure Warnings**

Warnings, such as the example below, precede potentially dangerous procedures

throughout this manual. Instructions contained in the warnings must be followed.

---









**WARNING**      **Dangerous voltage levels, capable of causing death, are present in this instrument. Use extreme caution when handling, testing, and adjusting this instrument.**

---

---

## Safety Symbols

General definitions of safety symbols used on the instrument or in manuals are listed below.

-  Instruction Manual symbol: the product is marked with this symbol when it is necessary for the user to refer to the instrument manual.
-  Alternating current.
-  Direct current.
-  On (Supply).
-  Off (Supply).
-  In-position of push-button switch.
-  Out-position of push-button switch.
-  A chassis terminal; a connection to the instrument's chassis, which includes all exposed metal structure.
-  Stand-by.

---

**WARNING**      **This warning sign denotes a hazard. It calls attention to a procedure, practice, or condition that, if not correctly performed or adhered to, could result in injury or death to personnel.**

---

---

**CAUTION**      This Caution sign denotes a hazard. It calls attention to a procedure, practice, or condition that, if not correctly performed or adhered to, could result in damage to or destruction of part or all of the instrument.

---

---

**NOTE**      This Note sign denotes important information. It calls attention to a procedure, practice, or condition that is essential for the user to understand.

---

---

## **Certification**

Agilent Technologies certifies that this product met its published specifications at the time of shipment from the factory. Agilent Technologies further certifies that its calibration measurements are traceable to the United States National Institute of Standards and Technology, to the extent allowed by the Institution's calibration facility or by the calibration facilities of other International Standards Organization members.

---

## **Documentation Warranty**

The material contained in this document is provided "as is," and is subject to being changed, without notice, in future editions. Further, to the maximum extent permitted by applicable law, Agilent disclaims all warranties, either express or implied with regard to this manual and any information contained herein, including but not limited to the implied warranties of merchantability and fitness for a particular purpose. Agilent shall not be liable for errors or for incidental or consequential damages in connection with the furnishing, use, or performance of this document or any information contained herein. Should Agilent and the user have a separate written agreement with warranty terms covering the material in this document that conflict with these terms, the warranty terms in the separate agreement will control.

---

## **Exclusive Remedies**

The remedies provided herein are Buyer's sole and exclusive remedies. Agilent Technologies shall not be liable for any direct, indirect, special, incidental, or consequential damages, whether based on contract, tort, or any other legal theory.

---

## **Assistance**

Product maintenance agreements and other customer assistance agreements are available for Agilent Technologies products.

For any assistance, contact your nearest Agilent Technologies Sales and Service Office. Addresses are provided at the back of this manual.

---

## Typeface Conventions

**Sample (bold)**

Boldface type is used when a term is defined or emphasized.

*Sample (Italic)*

Italic type is used for emphasis and for titles of manuals and other publications.

**Sample** menu/button/box/tab

Indicates a menu/button/box/tab on the screen labeled “Sample” which can be selected/executed by clicking. “menu”, “button”, “box”, or “tab” may be omitted.

Sample key

Indicates a hardkey (key on the front panel or external keyboard) labeled “Sample.” “key” may be omitted.

**[Sample]**

Indicates the hardkey whose key label is “Sample”.

**[Sample] - Item**

Indicates a series of key operations in which you press the **[Sample]** key, make the item called “Item” on the displayed menu blink by using the [↓] or in other ways, and then press the **[Enter]** key.

---

## E5070B/E5071B Documentation Map

The following manuals are available for the E5070B/E5071B.

- ***User's Guide (Part Number: E5070-900x0, attached to optional ABA)***

This manual describes most of the basic information necessary to use the E5070B/E5071B. It provides a function overview, detailed operation procedure for each function (from preparation for measurement to analysis of measurement results), measurement examples, specifications, and supplemental information. For programming guidance on performing automatic measurement with the E5070B/E5071B, please see the *Programming Manual*.
- ***Installation and Quick Start Guide (Part Number: E5070-900x1, attached to optional ABA)***

This manual describes installation after it is delivered and the basic operation procedures for applications and analysis. Refer to this manual when you use the E5070B/E5071B for the first time.
- ***Programmer's Guide (Part Number: E5070-900x2, attached to optional ABA)***

This manual provides programming information for performing automatic measurement with the E5070B/E5071B. It includes an outline of remote control, procedures for detecting measurement start (trigger) and end (sweep end), application programming examples, command reference, and related information.
- ***VBA Programmer's Guide (Part Number: E5070-900x3, attached to optional ABA)***

This manual describes programming information for performing automatic measurement with internal controller. It includes an outline of VBA programming, some sample programming examples, a COM object reference, and related information.

---

### NOTE

The number position shown by "x" in the part numbers above indicates the edition number. This convention is applied to each manual, CD-ROM (for manuals), and sample programs disk issued. Here, "3" indicates the initial edition, and each time a revision is made this number is incremented by 1. The latest edition allows the customer to specify Option ABJ (Japanese) or Option ABA (English) of the product.

---





<b>1. Introduction of This Manual</b>	
Contents of This Manual . . . . .	12
Overview of the E5070B/E5071B . . . . .	13
<b>2. Installation</b>	
Checking the Shipment . . . . .	17
Environmental Requirements . . . . .	20
Operating Environments . . . . .	20
Ventilation Requirements . . . . .	21
Protection Against Electrostatic Discharge (ESD) . . . . .	22
Ensuring Adequate Free Space around Analyzer for Immediate Disconnection of Power Cable in Case of Emergency . . . . .	22
Installing Front Handles/Rack Mounting Flanges . . . . .	23
How to Install the Handle Kit (Option 1CN) . . . . .	24
How to Install the Rack-mount Kit (Option 1CM) . . . . .	25
How to Install the Rack-mount and Handle Kit (Option 1CP) . . . . .	25
Connecting the Accessories . . . . .	26
Connecting the Mouse and Keyboard . . . . .	26
Connecting the BNC Adaptor (Option 1E5) . . . . .	27
Connecting a LAN Cable . . . . .	28
Connecting a Printer . . . . .	29
Connecting the Ecal Module . . . . .	30
Power Supply and Blown Fuses . . . . .	31
Verification of the Power Supply . . . . .	31
Verification and Connection of Power Cable . . . . .	31
Blown Fuses . . . . .	33
Starting the E5070B/E5071B . . . . .	34
Turning the Power ON and OFF . . . . .	34
Disconnection from Supply Source . . . . .	35
Setting the Internal Clock . . . . .	36
Setting the Date/Time . . . . .	36
Turning the Date/Time Display ON and OFF . . . . .	37
Initial Registration of E5070B/E5071B . . . . .	38
Daily Maintenance . . . . .	41
Cleaning Method . . . . .	41
Maintaining an N-type Connector on Each Port . . . . .	41
Self-test When Turning on the Power . . . . .	41
Considerations When Shipping to a Service Center Due to Breakdown or Other Problem . . . . .	42
<b>3. Quick Start Guide</b>	
Names and Descriptions of E5070B/E5071B parts . . . . .	45
Front Panel . . . . .	45
Display Area . . . . .	47
Three Methods of Operation . . . . .	49
Operating Method Using Keys . . . . .	50
Operation Method Using a Mouse . . . . .	51
Operation Method Using the Touch Screen (Option 016) . . . . .	52
Basic Measurement Procedures . . . . .	53

---

# Contents

Basic Measurement Flow . . . . .	53
Measurement Example of a Bandpass Filter . . . . .	54
STEP 1. Determining Measurement Conditions . . . . .	54
STEP 2. Calibration . . . . .	55
STEP 3. Connecting the Device Under Test(DUT) . . . . .	57
STEP 4. Analyzing Measurement Results . . . . .	58
STEP 5. Outputting Measurement Results (Save) . . . . .	61
<b>A. Manual Changes</b>	
Manual Changes . . . . .	64
Change 2 . . . . .	64
Change 1 . . . . .	64

---

# 1 Introduction of This Manual

This chapter provides an overview of this manual to use this manual efficiently and describes the features of the Agilent E5070B/E5071B briefly. See this manual first when you use the E5070B/E5071B for the first time.

## Contents of This Manual

This Quick Start Guide has been prepared to quickly familiarize users with the E5070B/E5071B basic operation and measurement. The following shows the contents of this manual.

❑ Chapter 1, “Introduction of This Manual”

This chapter provides an overview of this manual to use this manual efficiently and describes the features of the Agilent E5070B/E5071B briefly. See this manual first when you use the E5070B/E5071B for the first time.

❑ Chapter 2, “Installation”

This chapter provides information about how to set up the Agilent E5070B/E5071B RF network analyzer, and about daily maintenance.

❑ Chapter 3, “Quick Start Guide”

This chapter describes the functions of parts on the front panel and display area of the Agilent E5070B/E5071B RF Network Analyzer. Using the example of measuring a bandpass filter, you will quickly learn how to easily operate the E5070B/E5071B by understanding the basic measurement procedures and operation of the E5070B/E5071B.

❑ Appendix A, “Manual Changes,”

This appendix contains the information required to adapt this manual to versions or configurations of the E5070B/E5071B manufactured earlier than the current printing date of this manual.

---

**NOTE**

The Chapter 3, “Quick Start Guide,” on page 43 describes only a measurement example of the bandpass filter. For other measurement examples, see Chapter “Measurement Examples” in the *E5070B/E5071B User's Guide*.

---

---

## Overview of the E5070B/E5071B

The E5070B/E5071B RF Network Analyzer is an instrument that can quickly and accurately evaluate multi-port device measurements. The major features of the E5070B/E5071B are described as follows.

1. You can equip the instrument with a measurement frequency range at high frequencies required when you measure RF multi-port devices such as mobile communication components (E5070B:300 kHz to 3 GHz; E5071B:300 kHz to 8.5 GHz) and with up to four test ports.
2. Simultaneously measuring all the built-in test ports realizes high-speed measurement, while executing full-port calibration removes error factors thoroughly to achieve high accuracy measurement.
3. The built-in balanced measurement function, matching circuit simulation function, and port impedance transformation function enables you to correctly evaluate RF balanced devices such as balanced SAW filters.
4. The ease of operation based on the use of a GUI (Graphic User Interface), excellent connection compatibility with peripherals, and graphical programming environment created by the built-in VBA enables the user to efficiently process measurement data.
5. The instrument is capable of simultaneously displaying up to 16 measurement channels as well as up to 16 measurement parameters per channel.

Introduction of This Manual  
**Overview of the E5070B/E5071B**

---

# 2

## Installation

This chapter provides information about how to set up the Agilent E5070B/E5071B RF network analyzer, and about daily maintenance.

**Contents of this  
Chapter**

❑ **Checking the Shipment** on page 17

After you receive the analyzer, check all the items in the packing container.

❑ **Environmental Requirements** on page 20

Describes the system requirements needed to install the E5070B/E5071B and how to secure space for heat radiation.

❑ **Installing Front Handles/Rack Mounting Flanges** on page 23

Shows how to mount the front handles used to transport the E5070B/E5071B and how to install the flanges needed to install it in a rack.

❑ **Connecting the Accessories** on page 26

Provides information for connecting the mouse, keyboard, BNC adaptor, and Ecal module to the E5070B/E5071B.

❑ **Power Supply and Blown Fuses** on page 31

Shows how to check the power supply as well as check and connect the power cable. This section also describes what to do for a blown fuse.

❑ **Starting the E5070B/E5071B** on page 34

Describes turning on/off of the Power switch and cutting off the power supply. In this section you can also find how to set the internal clock.

❑ **Daily Maintenance** on page 41

Describes the daily maintenance for the E5070B/E5071B.



---

## Checking the Shipment

After you receive the analyzer, carry out checks during unpacking according to the following procedure.

---

### WARNING

**When unpacking the analyzer, if the external face of the analyzer (such as the cover, front/rear panel, LCD screen, power switch, and port connectors) appear to be damaged during transport, do not turn on the power switch. Otherwise, you may get an electric shock.**

- 
- Step 1.** Check that the packing box or shock-absorbing material used to package the analyzer has not been damaged.

---

### NOTE

If the packing box or shock-absorbing material has been damaged, leave the packing box and shock-absorbing material as is until other inspection items are checked as follows:

- Step 2.** Check the packaged items supplied with the analyzer for any damage or defects.
- Step 3.** By referring to Table 2-1 and Figure 2-1, check that all packaged items supplied with the analyzer have been provided as per the specified options.
- Step 4.** After checking, if one of the following applies, contact your nearest Agilent Technologies sales and service office.
1. The packing box or shock-absorbing material used to package the analyzer has been damaged or the shock-absorbing material has traces where extreme force has been applied.
  2. A packaged item supplied with the analyzer has mechanical damage or defects.
  3. A packaged item supplied with the analyzer is missing.
  4. A fault has been detected in the subsequent operation check of the analyzer.

If an abnormality is detected in step 1, contact the company that transported the analyzer as well as your nearest Agilent Technologies sales and service office. For inspection by the transport company, save the packing box, shock-absorbing material, and packaged items as you received them.

Installation  
**Checking the Shipment**

**Table 2-1 Items Packaged with the E5070B/E5071B**

Name	Agilent Product/ Part Number	Qty
Standard Accessories		
<input type="checkbox"/> E5070B/E5071B* <sup>1</sup>	E5070B/E5071B	1
<input type="checkbox"/> Power cable* <sup>2</sup>	-	1
<input type="checkbox"/> CD-ROM (of the manual)* <sup>3</sup>	E5070-905xx	1
<input type="checkbox"/> CD-ROM (of the Agilent IO Libraries Suite)	E2094-60003	1
<input type="checkbox"/> System recovery disk	E5070-16000	1
<input type="checkbox"/> GPIB adapter* <sup>4</sup>	E2078-62101	1
Options		
<input type="checkbox"/> Keyboard (Option 810)	-	1
<input type="checkbox"/> Mouse (Option 820)	-	1
<input type="checkbox"/> Manual (Option ABA)* <sup>5</sup>		
• User's Guide	E5070-900x0	1
• Installation and Quick Start Guide	E5070-900x1	1
• Programmer's Guide	E5070-900x2	1
• Sample program disk	E5070-180x0	1
<input type="checkbox"/> BNC adaptor (Option 1E5)	1250-1859	1
<input type="checkbox"/> Handle Kit (Option 1CN)* <sup>6</sup>	5063-9229	1
<input type="checkbox"/> Rack Mount Kit Without Handles (Option 1CM)* <sup>6</sup>	5063-9216	1
<input type="checkbox"/> Rack Mount Kit With Handles (Option 1CP)* <sup>6</sup>	5188-4430	1

\*1. Figure 2-1 shows the E5070B/E5071B main unit when Option 413 (4-port S-parameter test set) is specified.

\*2. This accessory varies from country to country. For the power cable option, see Figure 2-10.

\*3. The CD-ROM contains the same information as in the *User's Guide*, *Installation and Quick Start Guide*, *Programmer's Guide*, *VBA Programmer's Guide* and two Sample Program Disks. The 'xx' in the part number is a number that is incremented each time a revision is made, with '00' regarded as the first edition. The network analyzer will always be supplied with the latest versions of these items.

\*4. Use this adapter when a GPIB cable is connected to the rear panel GPIB connector.

\*5. The 'x' in the part number of the Manual, or sample program disk is a number that is incremented each time a revision is made, with '0' regarded as the first edition. The network analyzer will always be supplied with the latest versions of these items.

\*6. This accessory is not shown in Figure 2-1. For the detail contents, see Table 2-3 on page 23.

Figure 2-1

E5070B/E5071B Accessories

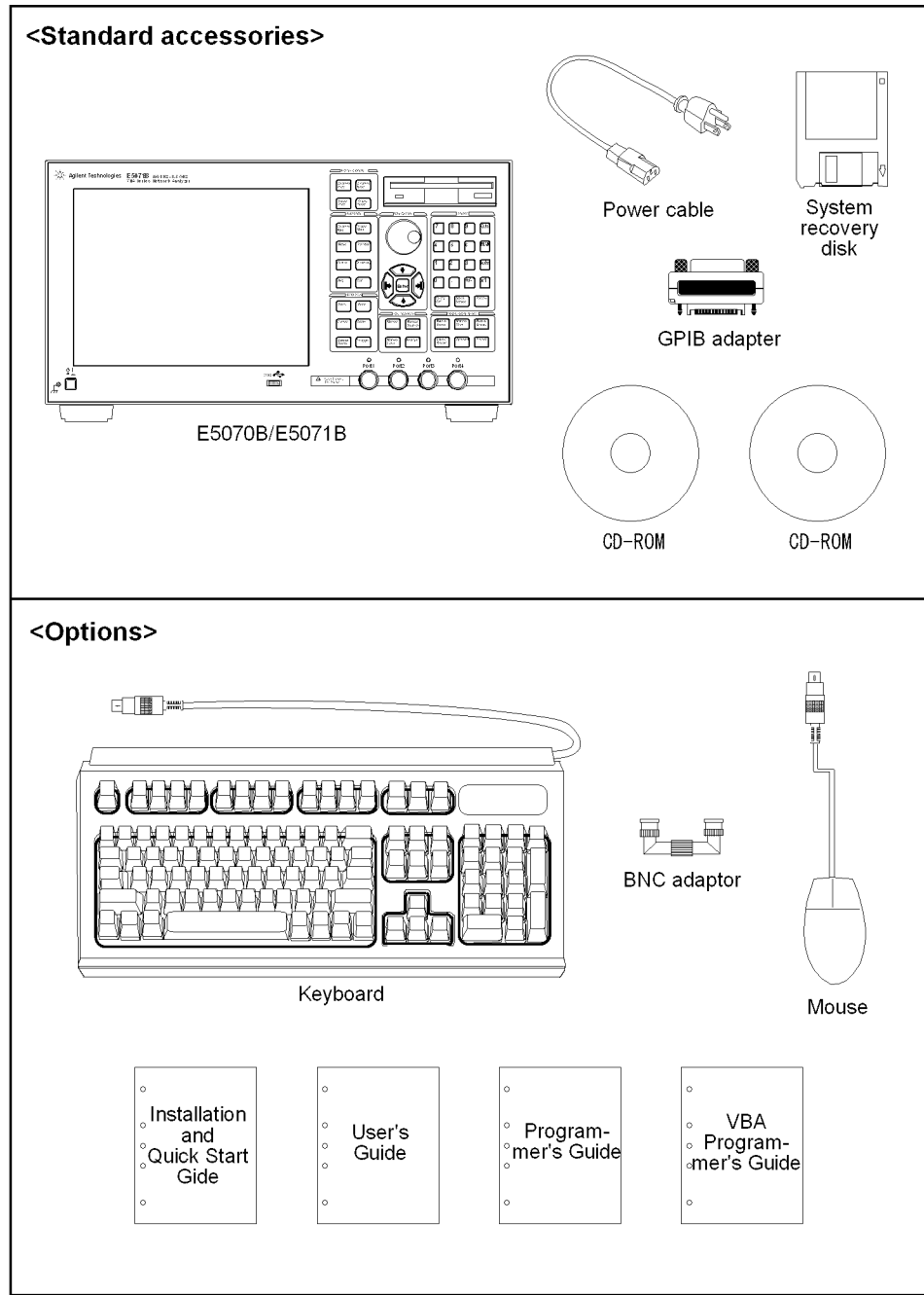

e5070bqe5001

2. Installation

## Environmental Requirements

Set up the E5070B/E5071B where the following environmental requirements are met.

### Operating Environments

Ensure that the operating environment meets the following requirements.

Temperature	5 °C to 40 °C
Temperature range at the error-correction	23 °C ± 5 °C (< 1 °C deviation from the temperature when performing the error-correction)
Humidity	20% to 80% at wet bulb temperature < +29 °C (non-condensation)
Altitude	0 to 2,000 m (0 to 6,561 feet)
Vibration	0.5 G maximum, 5 Hz to 500 Hz

---

#### NOTE

Above environmental requirements are NOT for the specifications and measurement accuracy of the analyzer, but for the operating environment of the analyzer.

**Ventilation Requirements**

To ensure safety requirements, the specifications and measurement accuracy of the analyzer, you must keep environmental temperature within the specified range by providing appropriate cooling clearance around the analyzer or, for the rackmount type, by forcefully air-cooling inside the rack housing. For more information on environmental temperature to satisfy the specifications and measurement accuracy of the analyzer, see “Specifications And Supplemental Information” in the *E5070B/E5071B User’s Guide*.

When the environmental temperature around the analyzer is kept within the temperature range of the operating environment specification (See Section “Operating Environments” on page 20), the analyzer conforms to the requirements of the safety standard. Furthermore, under that temperature requirement, the analyzer still conforms to the requirements of the safety standard even when placing the analyzer with cooling clearance as follows:

	Requirements
Back	≥ 180 mm
Sides	≥ 60 mm (both right and left)

Figure 2-2

**Ventilation space at the installation**

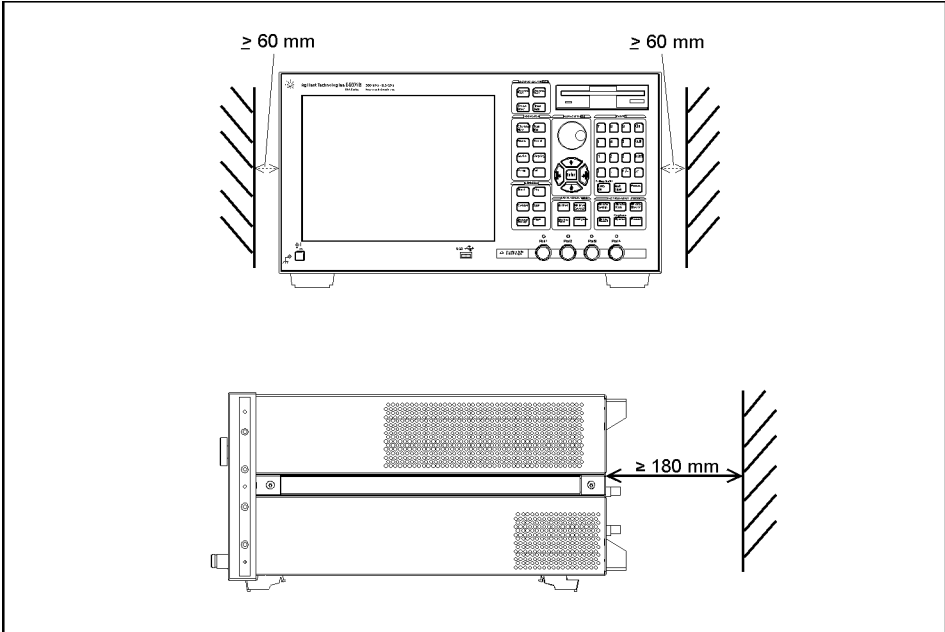

e5070bj007

### Protection Against Electrostatic Discharge (ESD)

Set up a static-safe work-station to protect the electronic components from the damage by the electrostatic discharge (ESD) as shown in Figure 2-3. Table 2-2 shows the accessories available that provide ESD protection.

Figure 2-3

Example of the static-safe work-station

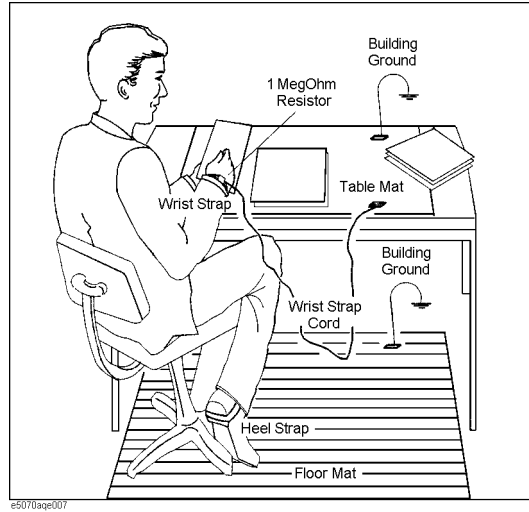

### Ensuring Adequate Free Space around Analyzer for Immediate Disconnection of Power Cable in Case of Emergency

As described in “Disconnection from Supply Source” on page 35, the power supply is disconnected by removing the power cable’s connector plug from either the AC outlet or the E5070B/E5071B unit. When installing the E5070B/E5071B, ensure that there is sufficient free space around the unit to permit quick disconnection of the plug (from AC outlet or E5070B/E5071B unit) in case of emergency.

## Installing Front Handles/Rack Mounting Flanges

The E5070B/E5071B can be installed on a workbench or in a rack. This section describes how to install the front handles (Option 1CN) used for moving or transporting the instrument, and how to install the analyzer in an equipment rack as part of a measurement system (Option 1CM: without the handles, Option 1CP: with the handles).

**Table 2-2**

**Agilent E5070B/E5071B handles/rack mounting options**

Option	Name	Agilent Part Number
1CN	Handle Kit	5063-9229
1CM	Rack-mount Kit	5063-9216
1CP	Rack-mount and Handle Kit	5188-4430

**Table 2-3**

**Contents of each option**

Option	Contents	Quantity
1CN	Front Handles	2
	Screws	6
	Trim Strips	2
1CM	Rack-mounting flanges (locking side plate)	2
	Screws	6
1CP	Rack-mounting flanges (locking side plate)	2
	Front Handles	2
	Screws	8

Figure 2-4 Installing front handle/rack-mount kits

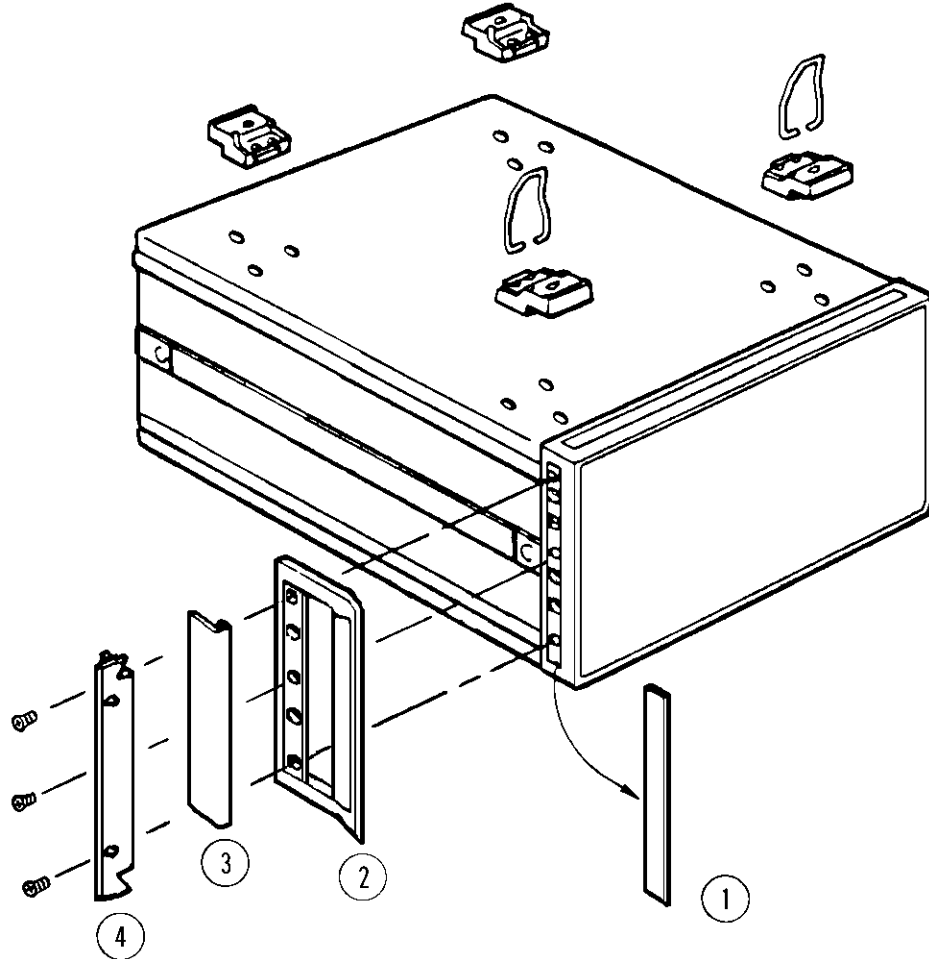

e5070aqj009

### How to Install the Handle Kit (Option 1CN)

The handle kit is used for transport and relocation of the E5070B/E5071B. While referring to Figure 2-4, install the handle kit by following these steps.

- Step 1.** Remove the adhesive-backed trim strip (1) from each side of the outer frame of the E5070B/E5071B front panel.
- Step 2.** Use the provided screws to mount the front handles (2) on each side of the E5070B/E5071B front panel frame.
- Step 3.** Attach the provided modified trim strip (3) to each front handle in order to cover the front panel locking screws.

---

**WARNING**

If the installed front handle becomes damaged, replace it with a new one immediately. A damaged handle can break while moving or lifting the instrument and cause personal injury or damage to the instrument.

---



### How to Install the Rack-mount Kit (Option 1CM)

The rack-mount kit includes two flanges (locking side plates) for mounting the E5070B/E5071B on a rack (482.6 mm/19 inches) conforming to the EIA Standard. While referring to Figure 2-4, install the rack-mount kit by following these steps.

- Step 1.** Remove the adhesive-backed trim strip (1) from each side of the outer frame of the E5070B/E5071B front panel.
- Step 2.** Use the provided screws to mount a rack-mounting flange (4) on each side of the E5070B/E5071B front panel frame.
- Step 3.** Remove the four bottom feet of the E5070B/E5071B (lift the bar marked TAB on the inner side of the foot and slide the foot toward the bar).
- Step 4.** Mount the E5070B/E5071B on the rack.

### How to Install the Rack-mount and Handle Kit (Option 1CP)

The rack-mount and handle kit includes both the rack-mounting flanges (locking side plates) and front handles. While referring to Figure 2-4, install the rack-mount kit by following these steps.

- Step 1.** Remove the adhesive-backed trim strip (1) from each side of the outer frame of the E5070B/E5071B front panel.
- Step 2.** Use the provided screws to mount a front handle (2) and rack-mounting flange (4) on each side of the E5070B/E5071B front panel frame.

---

**CAUTION**

**Use both a front handle and a rack-mounting flange in the same time certainly. Do not attempt to install flanges or handles separately with hardware provided. Serious electrical damage will occur to the instrument.**

---

- Step 3.** Remove the four bottom feet of the E5070B/E5071B (lift the bar marked TAB on the inner side of the foot and slide the foot toward the bar).
- Step 4.** Mount the E5070B/E5071B on the rack.

## Connecting the Accessories

The E5070B/E5071B allows you to connect a variety of accessories using the USB ports on the front panel or each of the ports on the rear panel.

### Connecting the Mouse and Keyboard

As shown in Figure 2-5, connect the mouse and keyboard to the mini-DIN mouse port and mini-DIN keyboard port, respectively, before turning ON the power.

Figure 2-5

Connecting the mouse and keyboard

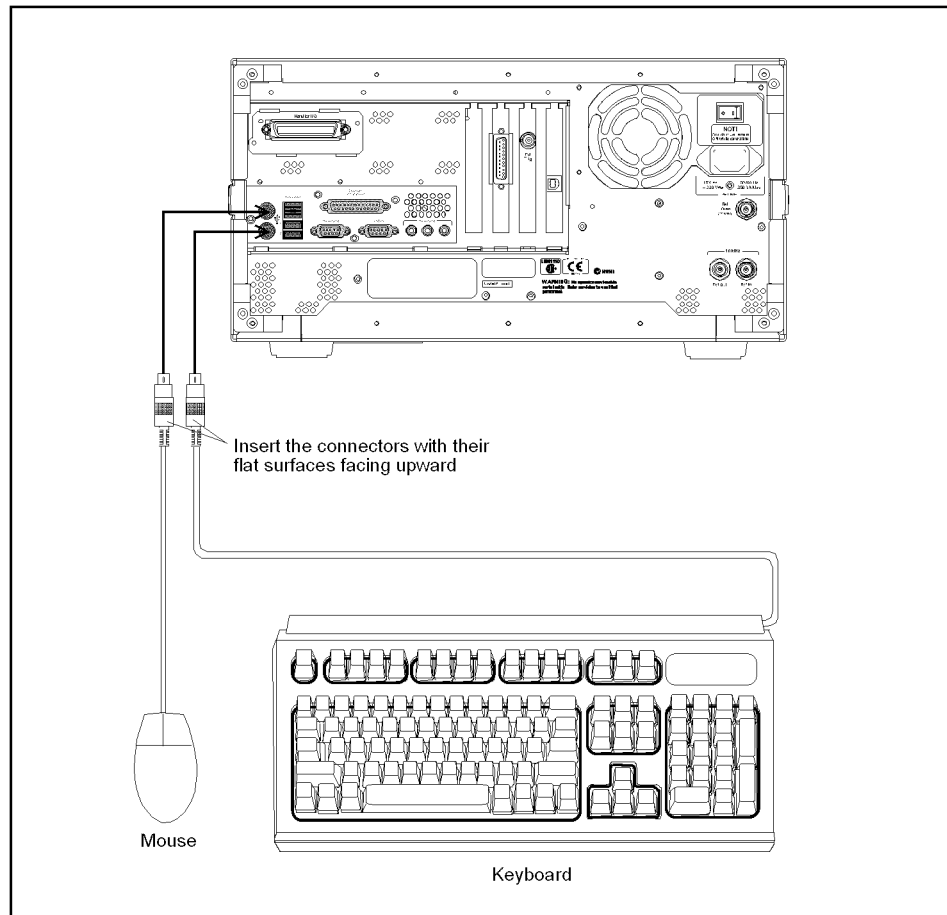

### Connecting the BNC Adaptor (Option 1E5)

When the E5070B/E5071B is equipped with Option 1E5 (high-stability frequency standard), connect the BNC adaptor from the Ref Oven terminal to the Ref In terminal on the rear panel as shown in Figure 2-6. The BNC adaptor is included in Option 1E5. When Option 1E5 is installed, the frequency accuracy and stability of the E5070B/E5071B will further improve.

Figure 2-6

Connecting the BNC adaptor

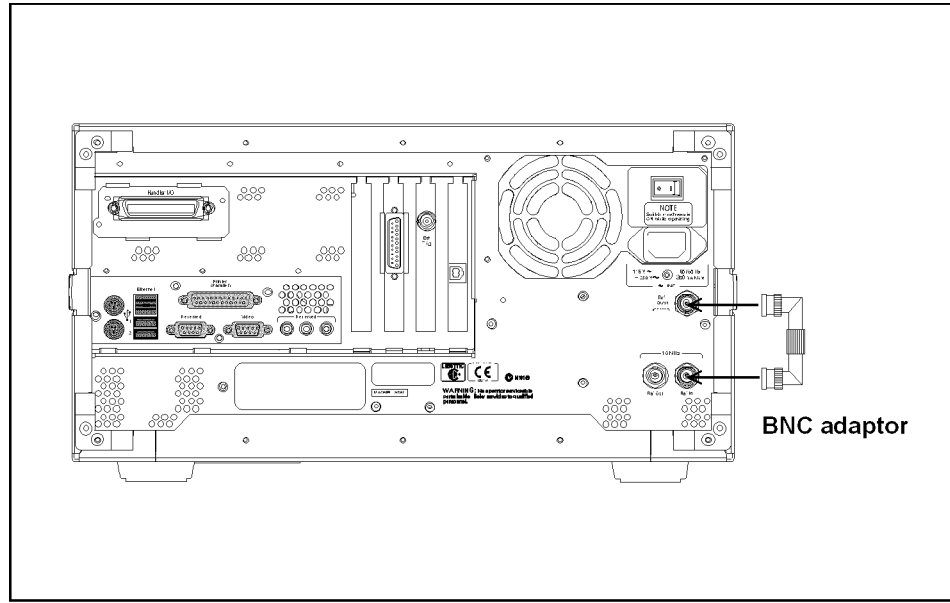

e5070bqe5002

## Connecting a LAN Cable

When using a LAN (local area network), follow the procedure below to connect the E5070B/E5071B to the LAN.

- Step 1.** By referring to Section “Configuring the Network” in the *E5070B/E5071B User’s Guide*, set the E5070B/E5071B LAN.
- Step 2.** As shown in Figure 2-7, connect a LAN cable to the LAN port on the rear panel of the E5070B/E5071B.

Figure 2-7 Connecting the LAN cable

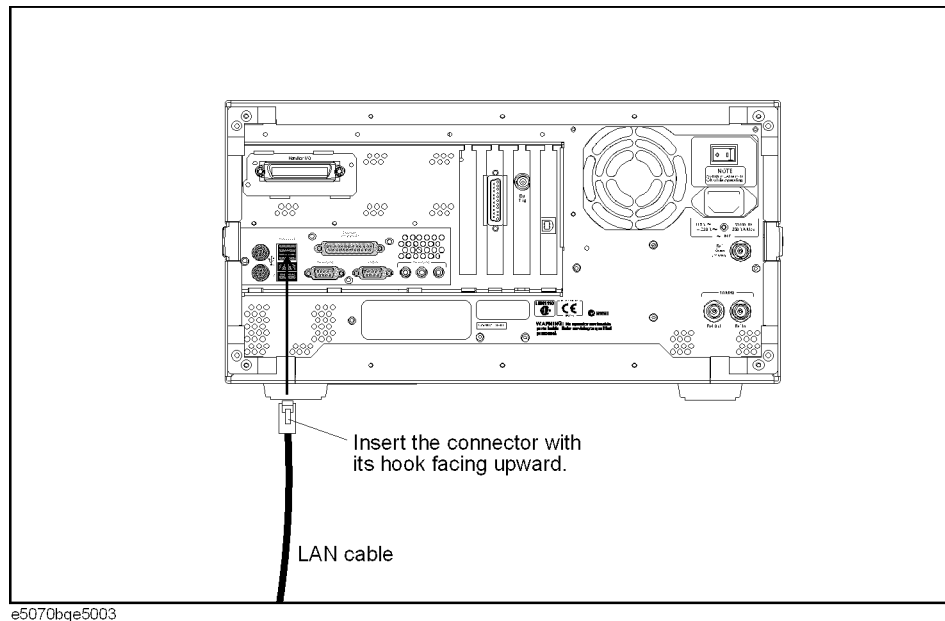

---

### NOTE

When connecting the E5070B/E5071B to a LAN for use, consult the network administrator about proper LAN settings.

Do not connect a LAN cable until the proper LAN settings have been completed. Connecting the E5070B/E5071B to a LAN with improper settings may cause a problem in the network.

---

## Connecting a Printer

When using a printer, connect an available printer to the printer parallel port or USB (Universal Serial Bus) port on the rear panel of the E5070B/E5071B as shown in Figure 2-8.

For the available printers of the E5070B/E5071B in its factory-shipped condition, see Section “Compatible Printers” in the *E5070B/E5071B User’s Guide*.

Figure 2-8

### Connecting the printer

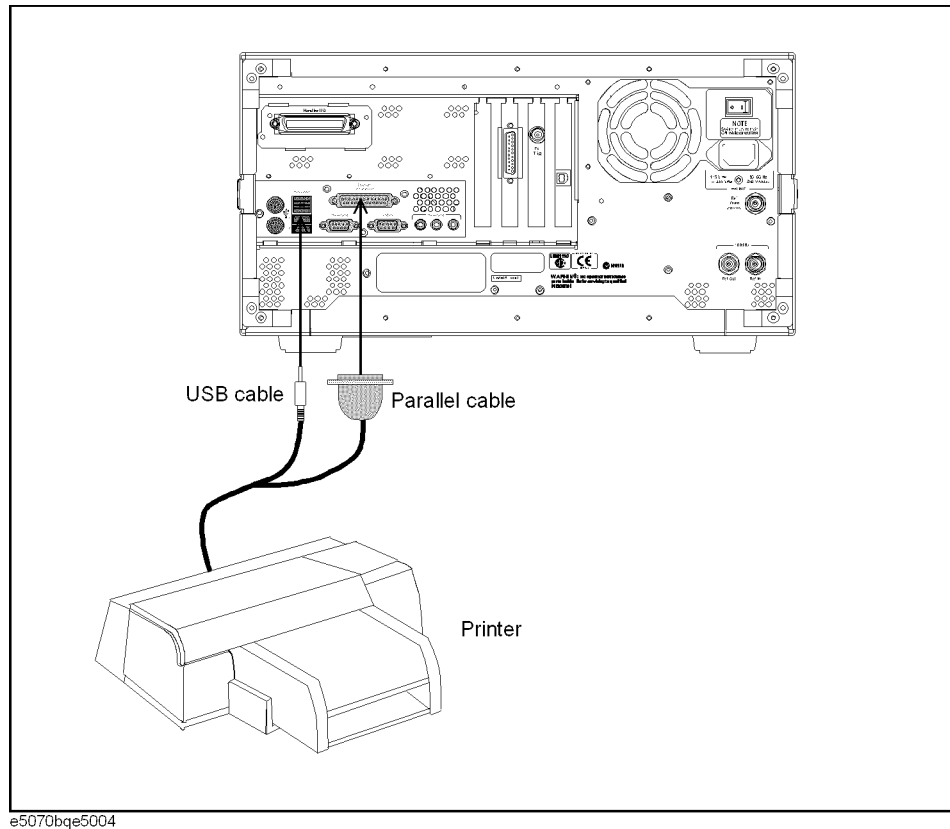

## Connecting the Ecal Module

When using the Ecal module, connect one end of the USB cable to the Ecal module and the other end to the USB port on the front panel as shown in Figure 2-9.

Figure 2-9

Connecting the ECal module

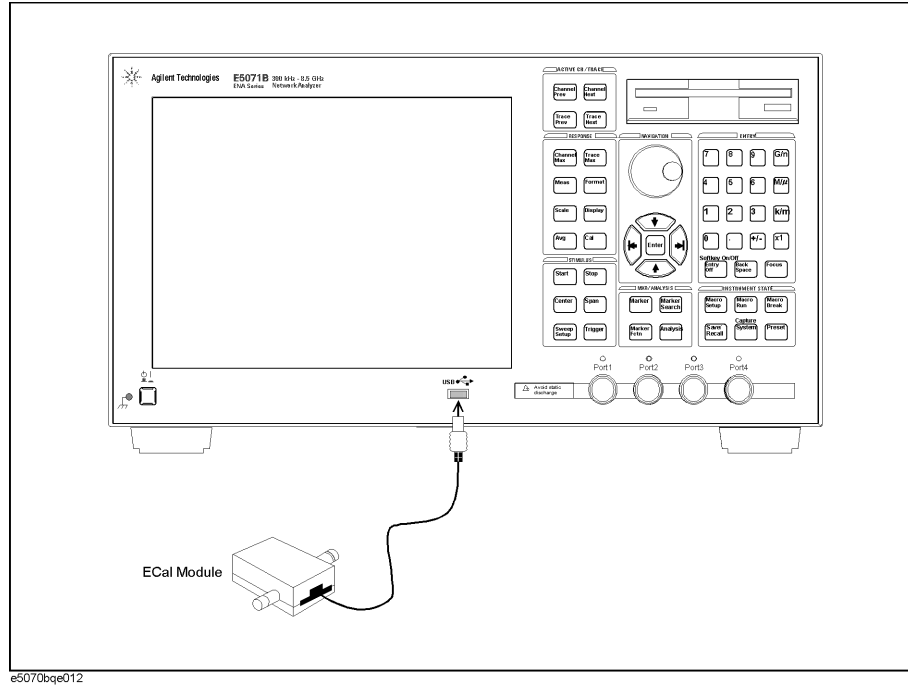

e5070bqe012

## Power Supply and Blown Fuses

Before turning on the E5070B/E5071B power, check the following.

### Verification of the Power Supply

Confirm that the power supplied to the E5070B/E5071B meets the following requirements:

	Requirements
Voltage	90 to 132 VAC or 198 to 264 VAC *1
Frequency	47 to 63 Hz
Maximum power consumption	350 VA

\*1. Switched automatically by the E5070B/E5071B in conformity to the voltage used.

### Verification and Connection of Power Cable

The three-wire power cable attached to the E5070B/E5071B has one wire serving as a ground. Using this power cable allows the E5070B/E5071B to be grounded, thereby protecting you against electrical shock from the power outlet.

**Step 1.** Confirm that the power cable is not damaged.

---

**WARNING** NEVER use a power cable showing any sign of damage. Faulty cables can cause electrical shock.

---

**Step 2.** Use the supplied cable to connect between the power cable receptacle (Figure 2-11 on page 35) on the rear panel of the E5070B/E5071B and a three-wire power outlet with the grounding prong firmly connected in the ground slot.

---





**WARNING** Use the supplied power cable with grounding wire to securely ground the E5070B/E5071B.

---

Figure 2-10 shows the power cable options.

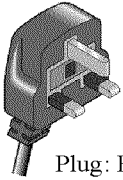
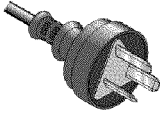
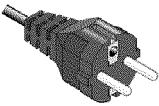
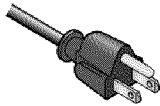
Installation  
Power Supply and Blown Fuses

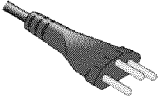
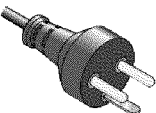
Figure 2-10 Power cable options

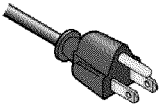
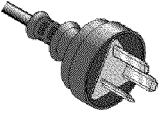
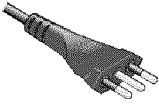
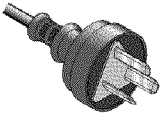
<p>OPTION 900</p>  <p>United Kingdom</p> <p>Plug: BS 1363/A, 250V, 10A Cable: 8120-1351, 8120-8705</p>	<p>OPTION 901</p>  <p>Australia/New Zealand</p> <p>Plug: AS 3112, 250V, 10A Cable: 8120-1369</p>
<p>OPTION 902</p>  <p>Continental Europe</p> <p>Plug: CEE 7 Standard Sheet VII, 250V, 10A Cable: 8120-1689</p>	<p>OPTION 903</p>  <p>U.S./Canada</p> <p>Plug: NEMA 5-15P, 125V, 10A Cable: 8120-1378</p>
<p>OPTION 904</p>  <p>U.S./Canada</p> <p>Plug: NEMA 6-15P, 250V, 6A Cable: 8120-0698</p>	<p>OPTION 906</p>  <p>Switzerland</p> <p>Plug: SEV Type 12, 250V, 10A Cable: 8120-2104</p>
<p>OPTION 912</p>  <p>Denmark</p> <p>Plug: SR 107-2-D, 250V, 10A Cable: 8120-2956</p>	<p>OPTION 917</p>  <p>India/Republic of S. Africa</p> <p>Plug: IEC 83-B1, 250V, 10A Cable: 8120-4211</p>
<p>OPTION 918</p>  <p>Japan</p> <p>Plug: JIS C 8303, 125V, 12A Cable: 8120-4753</p>	<p>OPTION 920</p>  <p>Argentina</p> <p>Plug: Argentine Resolution 63, Annex IV, 250V, 10A Cable: 8120-6870</p>
<p>OPTION 921</p>  <p>Chile</p> <p>Plug: CEI 23-16, 250V, 10A Cable: 8120-6978</p>	<p>OPTION 922</p>  <p>China</p> <p>Plug: GB 1002, 250V, 10A Cable: 8120-8376</p>
<p>NOTE: Each option number includes a 'family' of cords and connectors of various materials and plug body configurations (straight, 90° etc.).</p>	

power\_e



### Blown Fuses

If the fuse appears to have blown during operation, this instrument may be subject to failure and must be repaired. Ship the E5070B/E5071B to the nearest Agilent Technologies Service Center by seeing Section “Considerations When Shipping to a Service Center Due to Breakdown or Other Problem” on page 42

The E5070B/E5071B uses the following fuse type: UL/CSA Type, Slow-Blo, 6.3 A/250 Vac

---

**WARNING**

---

**Do NOT replace the fuse yourself; doing this may expose you to dangerous electrical shock.**



## Starting the E5070B/E5071B

This section describes how to turn on/off the E5070B/E5071B power, how to cut off the power supply in an emergency, and how to set the internal clock.

### Turning the Power ON and OFF

Perform the following steps to turn the power ON or OFF.

#### Turning the Power ON

**Step 1.** If the standby switch (  ) in the lower-left part of the front panel is in the depressed (  ) position, press it to put it in the popped up position (  ).

**Step 2.** Press the standby switch to put it in the depressed position (  ).



This operation turns ON the power, and the E5070B/E5071B starts the self-test.

**Step 3.** Confirm that the self-test indicates normal operation.

Normal operation is confirmed by the self-test if no error message appears.

#### Turning the Power OFF

**Step 1.** Use either of the following methods to turn the power OFF.

- Press the standby switch (  ) in the lower-left part of the front panel (now in the pressed down (  ) position) to put it in the popped up (  ) position.
- Send the shutdown command from an external controller.

These operations will start the E5070B/E5071B shutdown process (required software and hardware processes for turning the power off), and the power will turn OFF after a few seconds.

---

#### NOTE

Under normal circumstances, always press the standby switch (  ), or send the shutdown command from an external controller, to execute the E5070B/E5071B shutdown process. **Never cut off the power supply directly by disconnecting the power cable plug from the rear panel of the unit.**

If the power supply is cut off directly by disconnecting the power cable plug from the instrument or the AC outlet, the shutdown process is not carried out and there is a risk of damage to the E5070B/E5071B's software or hardware.

---

Figure 2-11

Line switch (Always ON) and power cable receptacle

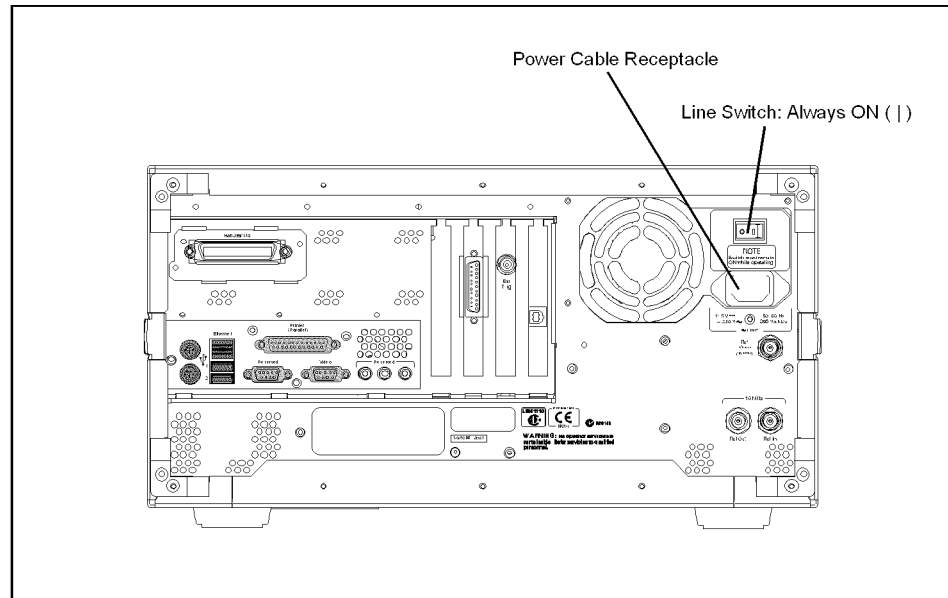

### Disconnection from Supply Source

The power supply of the E5070B/E5071B is cut off by disconnecting the plug of the power cable (on either AC outlet side or E5070B/E5071B side). When it is necessary to disconnect the power supply in order to avoid shock hazards, etc., pull out the power cable plug from either the AC outlet side or the E5070B/E5071B side.

#### NOTE

To allow this operation to be performed smoothly, be sure to follow the guidelines in “Ensuring Adequate Free Space around Analyzer for Immediate Disconnection of Power Cable in Case of Emergency” on page 22.

When turning the power OFF under normal circumstances, always follow the methods described in “Turning the Power OFF” on page 34.

## Setting the Internal Clock

You can set the date/time displayed at the lower right of the screen. When you save data in the storage unit, for example, the internal clock data will be used. The following describes the setting procedure that uses keys on the front panel.

### NOTE

When turning on the instrument power for the first time after delivery, always be sure to set the internal clock.

## Setting the Date/Time

- Step 1.** Press the **[System]** key in the INSTR STATE block. Press the [↓] or [↑] key to move the focus to the **Misc Setup** button and then press the **[Enter]** or **[→]** key. Press the [↓] or [↑] key to move the focus to the **Clock Setup** button and then press the **[Enter]** or **[→]** key. Point the focus to the **Set Date and Time** button and press the **[Enter]** key. The Date/Time Properties dialog box will appear (Figure 2-12).

Figure 2-12

Date/Time Properties Dialog Box (“Date & Time” Tab)

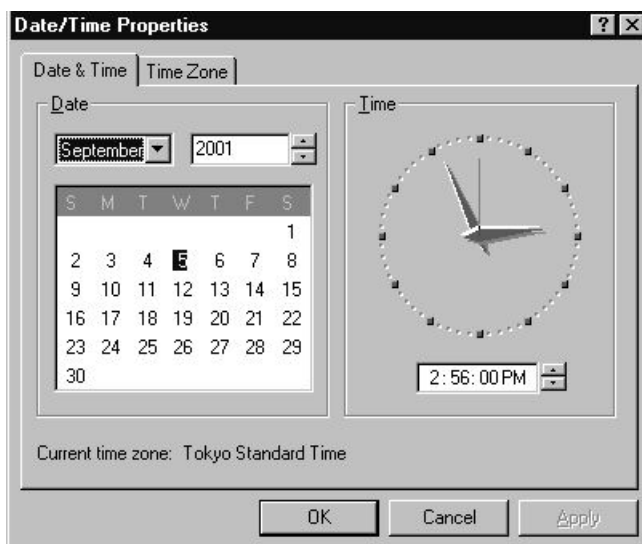

e5070aqi006

- Step 2.** Turn the rotary knob (⊙) on the front panel to point the focus to the **Date & Time** tab and press the **[→]** key to move the focus to the **Time Zone** tab (Figure 2-13).

Figure 2-13

Date/Time Properties Dialog Box (“Time Zone” Tab)



e5070aqj005

- Step 3.** Turn the rotary knob (⊙) on the front panel to point the focus to the **Time Zone** box and press the [←]/[→] or [↓]/[↑] key to select the time zone.

**NOTE**

When you select the time zone for summer time, the **Automatically adjust clock for daylight saving changes** box becomes selectable. To set the function of automatically making summertime adjustment to ON, turn the rotary knob (⊙) to point the focus to the **Automatically adjust clock for daylight saving changes** box and press the rotary knob (⊙) to display the √ mark (Figure 2-13).

- Step 4.** Turn the rotary knob (⊙) on the front panel to point the focus to the **Time Zone** tab and press the [←] key to move the focus to the **Date & Time** tab.
- Step 5.** By referring to Figure 2-12, turn the rotary knob (⊙) on the front panel to point the focus to the desired item. Press the [←]/[→] or [↓]/[↑] key to set each item.
- Step 6.** Turn the rotary knob (⊙) on the front panel to point the focus to the **OK** button and then press [Enter] key.

**Turning the Date/Time Display ON and OFF**

The Date/time is displayed within the instrument status bar at the lower right of the display screen.

- Step 1.** Press the [System] key in the INSTR STATE block. Press the [↓] or [↑] key to move the focus to the **Misc Setup** button and then press the [Enter] or [→] key. Press the [↓] or [↑] key, move the focus to the **Clock Setup** button, and press the [Enter] or [→] key. Point the focus to the **Show Clock** button and press the [Enter] key to set the date/time display on/off.

---

## Initial Registration of E5070B/E5071B

When you start up the E5070B/E5071B for the first time or after executing system recovery, you need to perform the initial registration of the Windows 2000 operating system of the E5070B/E5071B.

---

**NOTE** You cannot use the front panel keys during the initial registration of the E5070B/E5071B therefore connect the mouse and the keyboard before turning on the power.

---

**NOTE** If you perform the following procedure incorrectly, a message asking you whether to return to the previous registration screen and perform the registration appears. In this case, follow the instruction to return to the previous registration screen.

---

**Step 1.** Turns on the E5070B/E5071B.

**Step 2.** The Windows 2000 Professional Setup wizard appears. Click the **Next >** button (Figure 2-14).

**Figure 2-14** Windows 2000 Professional Setup wizard



**Step 3.** In the Windows 2000 Professional Setup dialog box, select the **I accept this agreement** box and click the **Next >** button (Figure 2-15). Then, the Windows 2000 operating system is restarted automatically.

**Figure 2-15** Windows 2000 Professional Setup dialog box

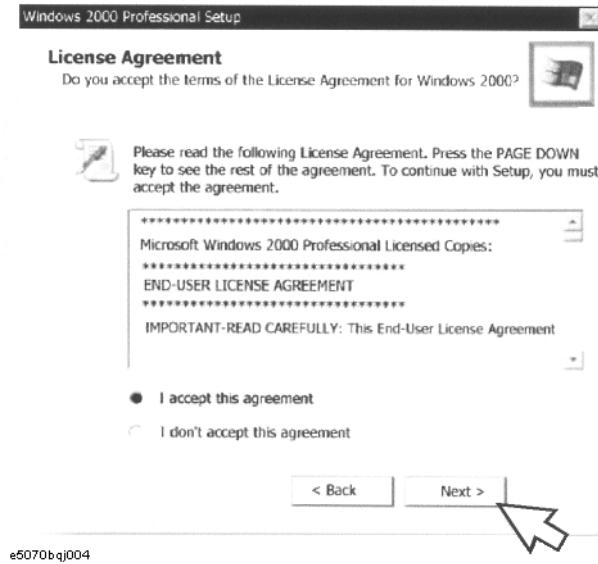

**Step 4.** The Network Identification wizard appears. Click the **Next >** button (Figure 2-16).

**Figure 2-16** Network Identification wizard

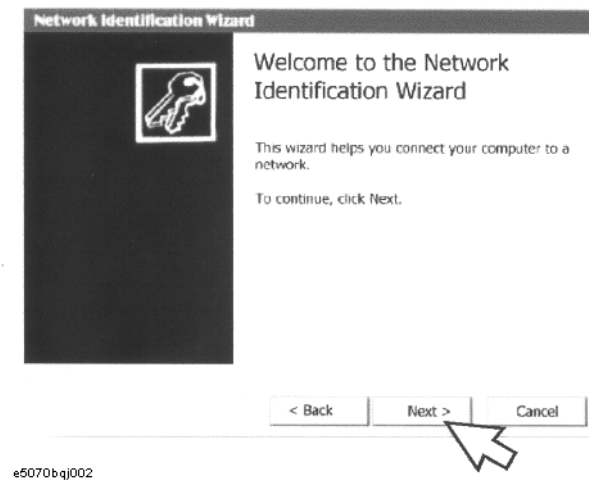

Installation  
Initial Registration of E5070B/E5071B

**Step 5.** In the Network Identification Wizard dialog box (1/2), select the **Windows always assumes the following user has logged on to this computer** box and check that **agena** is in the **User Name** box. If not, type in **agena**. Finally, click the **Next>** button (Figure 2-17).

**Figure 2-17** Network Identification Wizard dialog box (1/2)

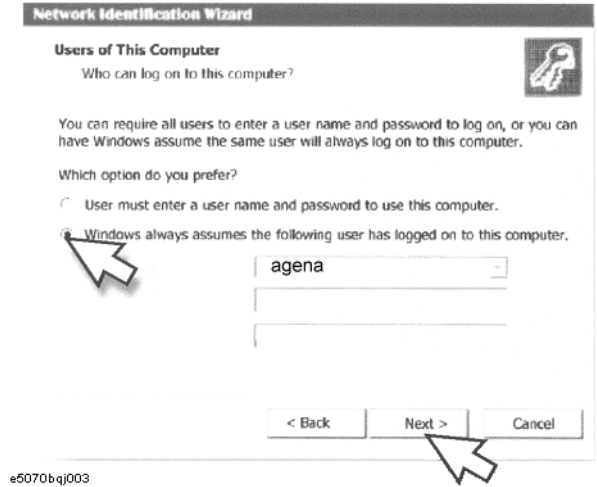

**Step 6.** In the Network Identification Wizard dialog box (2/2), click the **Finish** button to finish the initial registration of the E5070B/E5071B (Figure 2-17). Then, the measurement display of the E5070B/E5071B appears.

**Figure 2-18** Network Identification Wizard dialog box (2/2)

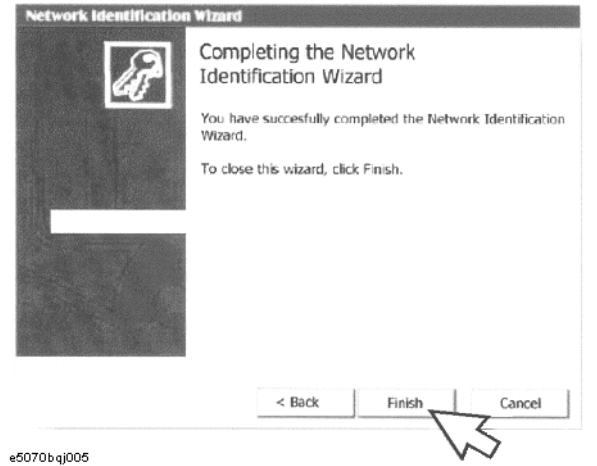



## Daily Maintenance

This section provides the maintenance information for the E5070B/E5071B and describes the self-test function (which checks the instrument for failure). This section also provides information required for shipping the E5070B/E5071B due to breakdown or other problem.

### Cleaning Method

To clean the surface of the E5070B/E5071B, wipe the surface gently with a dry cloth or soft cloth dampened with water and wrung dry. Never attempt to clean the inside of the instrument.

---

#### WARNING

**To avoid an electric shock, always disconnect the power cord of the E5070B/E5071B from the power outlet when cleaning.**

---

#### NOTE

To clean a touch screen type LCD (Option 016), do not wet the cloth with water. Occasionally, a few pixels may appear on the screen as a fixed point of blue, green or red. Please note that this is not a failure and does not affect the performance of your product.

---

### Maintaining an N-type Connector on Each Port

Each port on the front panel of the E5070B/E5071B has an N-type connector (female). In the RF band, soil or damage on the connector or cable will affect the measurements. The following describes how to handle and maintain these N-type connectors.

- The connectors should always be kept clean and away from dirt.
- To prevent the electrostatic discharge (ESD), do not touch the contact face of the connector.
- Never attempt to use a damaged or nicked connector.
- When cleaning, blow air on the connector. Never attempt to use abrasives such as emery paper.

---

#### NOTE

Each port on the front panel of the E5070B/E5071B is a 50  $\Omega$ -based N-type connector (female). Note that use of an N-type connector for 75  $\Omega$  cables will result in an electrical contact failure.

---

### Self-test When Turning on the Power

When the power is turned on, the E5070B/E5071B automatically performs a self-test. If any error is detected by the self-test at power-on, the error message “Power on test fail” appears in the instrument status bar. This causes the E5070B/E5071B to enter the service mode. When being in the service mode, ship the E5070B/E5071B to the nearest Agilent Technologies Service Center by seeing Section “Considerations When Shipping to a

Service Center Due to Breakdown or Other Problem” on page 42.

### **Considerations When Shipping to a Service Center Due to Breakdown or Other Problem**

When shipping the E5070B/E5071B to an Agilent Technologies Service Center because of breakdown or other problem, for shipment use the packing box and shock-absorbing material used to package the analyzer or static-protective package that replaces them. For your nearest Agilent Technologies Service Center, contact the Agilent Technologies Customer Center shown at the end of the Manual.

---

**NOTE**

**Occasionally, a few pixels may appear on the screen as a fixed point of blue, green or red. Please note that this is not a failure and does not affect the performance of your product.**

---

---

# 3

## Quick Start Guide

This chapter describes the functions of parts on the front panel and display area of the Agilent E5070B/E5071B RF Network Analyzer. Using the example of measuring a bandpass filter, you will quickly learn how to easily operate the E5070B/E5071B by understanding the basic measurement procedures and operation of the E5070B/E5071B.

## Chapter Contents

- ❑ **Names and Descriptions of E5070B/E5071B parts** on page 45  
Describes the front panel, display area, and three methods of operation (keys, mouse, and touch panel).
- ❑ **Basic Measurement Procedures** on page 53  
Describes the basic measurement procedures for using the E5070B/E5071B.
- ❑ **Measurement Example of a Bandpass Filter** on page 54  
Illustrates the basic measurement method for the E5070B/E5071B through an example of the transmission measurement of a bandpass filter.

## Names and Descriptions of E5070B/E5071B parts

This section describes the names and outlines of the E5070B/E5071B parts on the front panel and display area. For more information, see Chapter 2 “Overview of Functions” in the *E5070B/E5071B User’s Guide*. This section also describes three operation methods using the keys, mouse, and touch panel (Option 016).

### Front Panel

The names and short descriptions of the E5070B/E5071B parts on the front panel are as shown as follows.

Figure 3-1 Front Panel

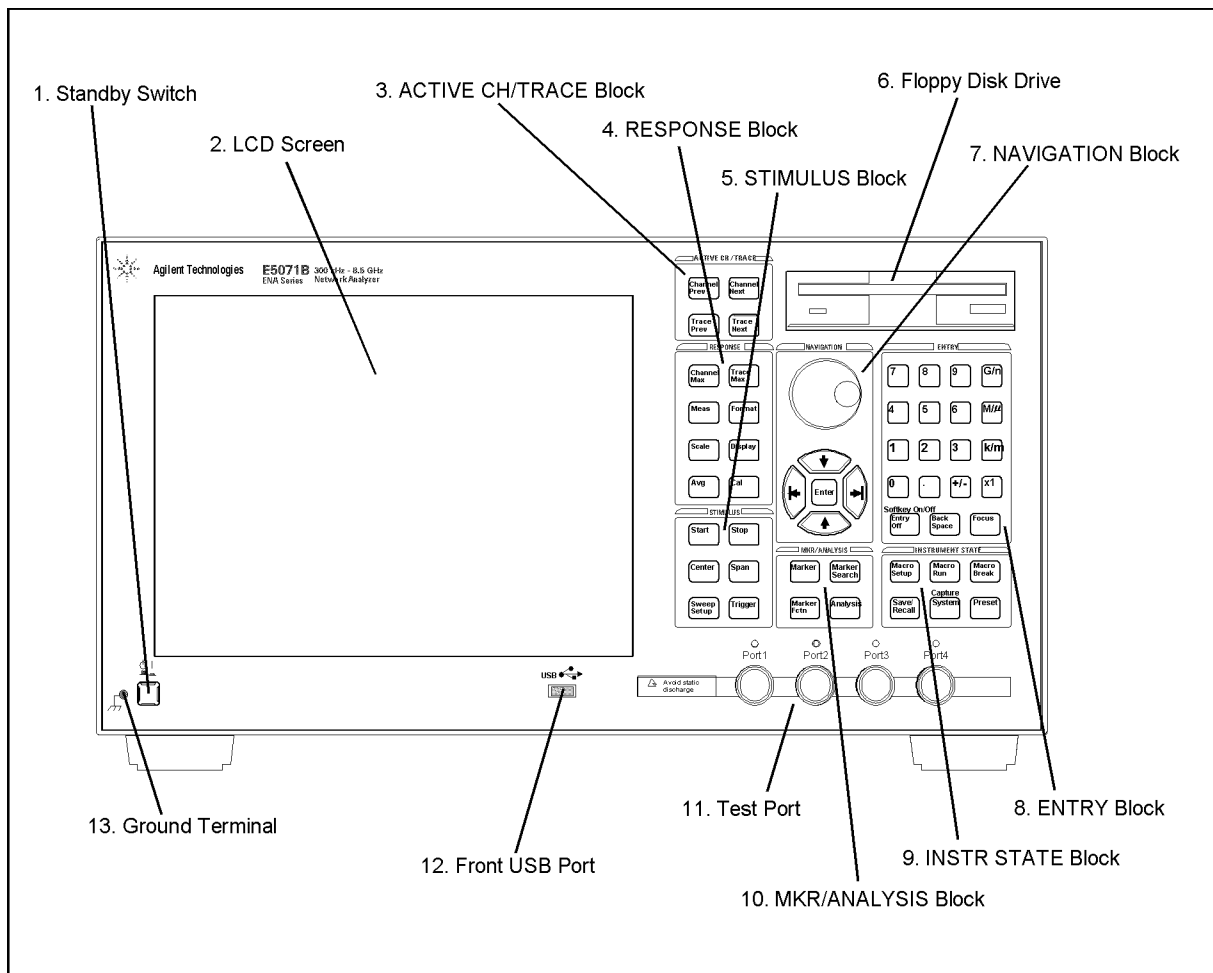

e5070bue032

3. Quick Start Guide

### 1. Standby Switch

Allows the switch between power-on (I) and standby mode (⏻) on the E5070B/E5071B.

### 2. LCD Screen

Displays measurement traces, instrument setting conditions, menu bars, the Visual Basic Editor, etc. Consists of a 10.4-inch TFT color LCD. For details on the information displayed on the LCD screen, see “Display Area” on page 47.

### 3. ACTIVE CH/TRACE Block

A group of keys used for selecting the active channel and an active trace. For more information on the functions of the keys in the ACTIVE CH/TRACE Block, see Chapter 2 “Overview of Functions” in the E5070B/E5071B *User’s Guide*.

### 4. RESPONSE Block

A group of keys used for the selection of a measurement parameters/data formats , displaying, calibration, etc. For more information on the functions of the keys in the RESPONSE Block, see Chapter 2 “Overview of Functions” in the E5070B/E5071B *User’s Guide*.

### 5. STIMULUS Block

A group of keys used for specifying the setup for signal sources, trigger, etc. For more information on the keys in the STIMULUS Block, see Chapter 2 “Overview of Functions” in the E5070B/E5071B *User’s Guide*.

### 6. Floppy Disk Drive

Stores/installs from/to the E5070B/E5071B the files containing the instrument setting conditions of the E5070B/E5071B, measurement data, the VBA (Visual Basic for Applications) program, etc. Compatible with 3.5-inch, 1.44 MB, DOS (Disk Operating System) formatted floppy disks.

### 7. NAVIGATION Block

A group of keys used for the movement/selection of the focus in menu bars/softkey menu bar/dialog boxes and for manipulating markers. For the functions of the keys in the NAVIGATION Block, see Chapter 2 “Overview of Functions” in the E5070B/E5071B *User’s Guide*.

### 8. ENTRY Block

A group of keys used for entering numeric data on the E5070B/E5071B settings. For more information on the functions of the keys in the ENTRY Block, see Chapter 2 “Overview of Functions” in the E5070B/E5071B *User’s Guide*.

### 9. INSTR STATE Block

A group of keys used for specifying the setup for controlling and managing the E5070B/E5071B such as executing the limit test function, printing measurement results, executing VBA macros, and presetting (initializing) the E5070B/E5071B. For more information on the keys in the INSTR STATE Block, see Chapter 2 “Overview of Functions” in the E5070B/E5071B *User’s Guide*.

### 10. MKR/ANALYSIS Block

A group of keys used for analyzing measurement results through markers, the fixture simulator function, etc. For more information on the keys in the MKR/ANALYSIS Block, see Chapter 2 “Overview of Functions” in the E5070B/E5071B *User’s Guide*.

### 11. Test Port

While the signal is being output from a test port, the yellow LED above the test port lights up. The connector type adopted is the 50 Ω-based N-type (female) connector.

### 12. Front USB Port

Used to connect a printer, a multiport test set or an ECal module compatible with the USB (Universal Serial Bus). Using a USB port allows the accessories to be connected after the E5070B/E5071B has been powered on.

### 13. Ground Terminal

Connected to the chassis of the E5070B/E5071B. You can connect a banana type plug to this terminal.

## Display Area

The names and short description of the E5070B/E5071B parts on the display area are shown as follows.

Figure 3-2

### Display area



### **1. Menu Bar**

Using a menu bar, you can perform the same operations as when using the keys in the ACTIVE CH/TRACE Block, RESPONSE Block, STIMULUS Block, MKR/ANALYSIS Block, and INSTR STATE Block on the front panel of the E5070B/E5071B.

### **2. Data Entry Bar**

Using the data entry bar, you can enter numeric data or label names.

### **3. Channel Title Bar**

Using the channel title bar, you can cause a title arbitrarily entered by the user to appear on each channel.

### **4. Softkey Menu**

A group of softkeys used for specifying the setup of the E5070B/E5071B.

### **5. Trace Bar**

Displays the settings for each trace (from left: trace number, S-parameter, data format, and scale). Using the mouse, you can also select the active trace.

### **6. Marker Indicator**

Indicates a marker position on the horizontal axis.

### **7. Marker Value**

Displays the stimulus value and response value of each marker. Symbol > displayed to the left of a marker number indicates that that marker is the active marker. When the reference marker is set ON, symbol  $\Delta$  is displayed instead of the marker number and indicates the marker value of the reference marker. When the reference marker is set ON, the stimulus value and response value of other markers indicate the differences from the values of the reference marker.

### **8. Reference Line Indicator**

Displays the position of the reference line.

### **9. Marker**

Used for reading out values on a trace. Using a marker makes it easy to analyze measurement results or change stimulus settings. The active marker is represented with an inverted triangle.

### **10. Channel Status Bar**

Displays channel-specific information on the E5070B/E5071B for each channel. This information consists of the channel number, the start frequency (center frequency), the stop frequency (span frequency), ON/OFF of the error correction function, and whether or not the sweep is in progress. When the averaging function is ON, the channel status bar also displays that information.

### **11. Instrument Status Bar**

Displays the information on the status of the E5070B/E5071B that is common to all channels.



## Three Methods of Operation

You can operate the E5070B/E5071B using one of three operating methods: using keys on the front panel, using a mouse and keyboard, and using a touch screen (Option 016). This section illustrates these three operating methods through the example in which the channel window layout is set to the four-channel display as shown in Figure 3-3.

In the next section and those following it, a series of operations is expressed as follows:

- **[Display] - Allocate Channels -** 

Figure 3-3

### Four-Channel Display

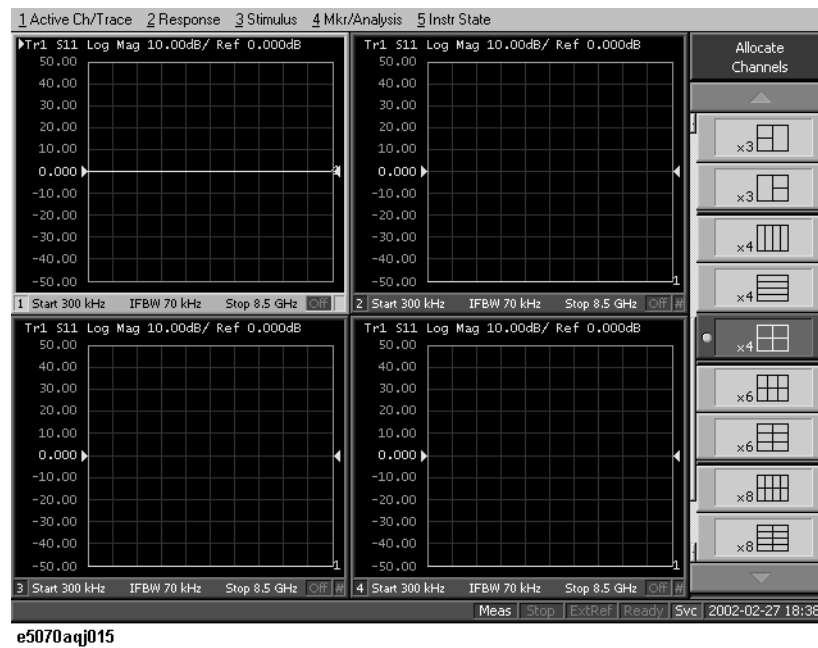

## Operating Method Using Keys

**Step 1.** Press the **Display** key in the RESPONSE Block.

Figure 3-4

### Step 1

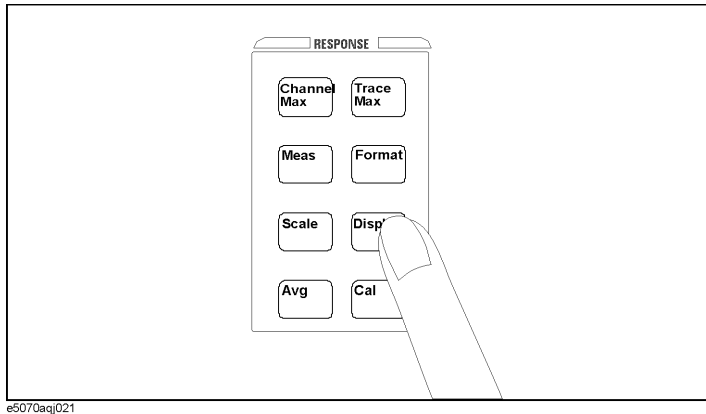





**Step 2.** Press the  or the  key to move the cursor to the **Allocate Channels** button, then press the  or the  key.

Figure 3-5

### Step 2





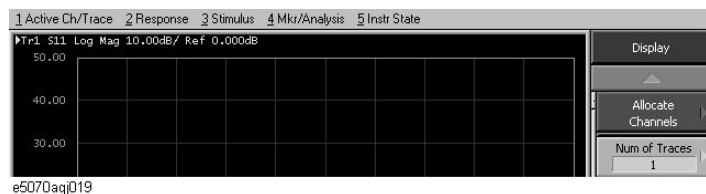

• Press the  or the  key to move the cursor to the  button, then press the  key.

Figure 3-6

### Step 3

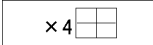

## Operation Method Using a Mouse

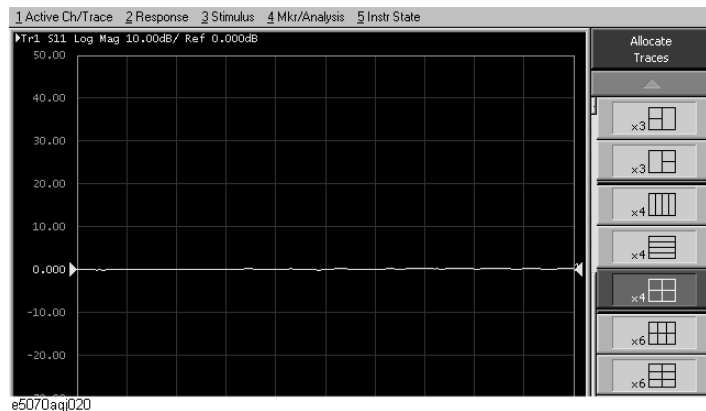
**Step 1.** From the **Response** menu, click the **Display** button.

**Figure 3-7**

**Step 1**

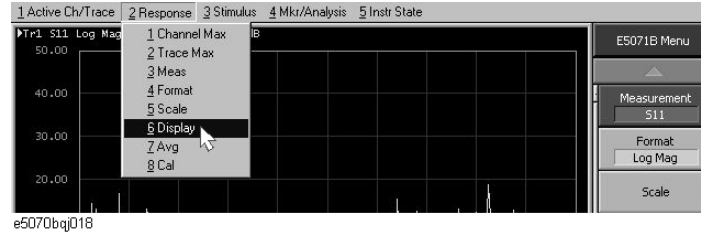

**Step 2.** Click the **Allocate Channels** button.

**Figure 3-8**

**Step 2**

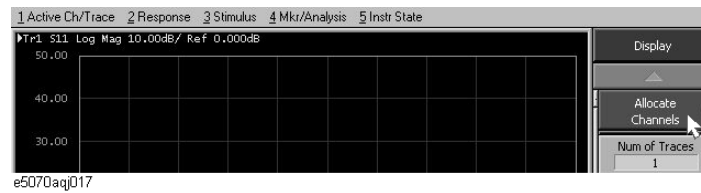

**Step 3.** Click the  button.

**Figure 3-9**

**Step 3**



### Operation Method Using the Touch Screen (Option 016)

**Step 1.** Press the **Display** button after presetting the E5070B/E5071B (Executing **[Preset]** key).

Figure 3-10

#### Step 1

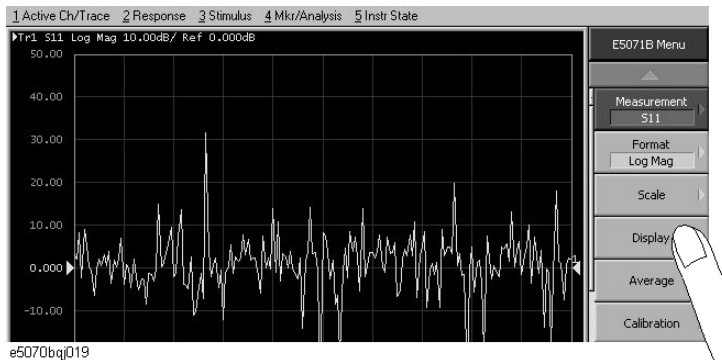

**Step 2.** Press the **Allocate Channels** button.

Figure 3-11

#### Step 2

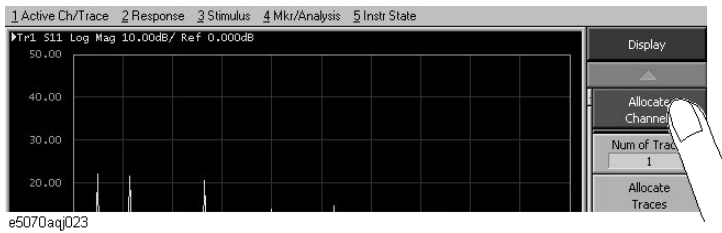

- Press the **[x4]** button.

Figure 3-12

#### Step 3

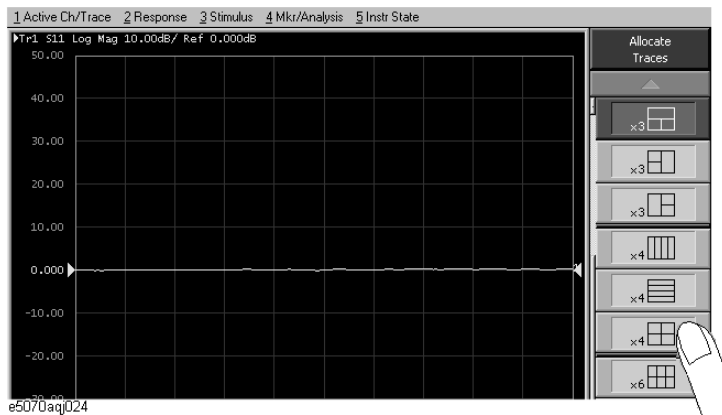

## Basic Measurement Procedures

To better understanding how to use the E5070B/E5071B, this section describes the basic measurement procedure using the E5070B/E5071B and presents an example of the transmission measurement of a bandpass filter.

### Basic Measurement Flow

<p><b>STEP 1. Determining measurement conditions</b></p> <ul style="list-style-type: none"><li><input type="checkbox"/> Presetting the E5070B/E5071B</li><li><input type="checkbox"/> Selecting the S-parameter</li><li><input type="checkbox"/> Selecting the data format</li><li><input type="checkbox"/> Specifying the frequency range</li><li><input type="checkbox"/> Specifying the number of measurement points</li><li><input type="checkbox"/> Specifying the power level</li><li><input type="checkbox"/> Specifying the IF bandwidth</li></ul>
<p><b>STEP 2. Calibration</b></p> <ul style="list-style-type: none"><li><input type="checkbox"/> Specifying the calibration kit</li><li><input type="checkbox"/> Selecting the calibration type</li><li><input type="checkbox"/> Measuring the calibration data</li><li><input type="checkbox"/> Making the error correction ON</li><li><input type="checkbox"/> Saving the calibration data</li></ul>
<p><b>STEP 3. Connecting the device under test (DUT)</b></p> <ul style="list-style-type: none"><li><input type="checkbox"/> Connecting the device under test (DUT)</li><li><input type="checkbox"/> Adjusting the scale</li></ul>
<p><b>STEP 4. Analyzing measurement results</b></p> <ul style="list-style-type: none"><li><input type="checkbox"/> Analysis using the markers</li></ul>
<p><b>STEP 5. Outputting measurement results</b></p> <ul style="list-style-type: none"><li><input type="checkbox"/> Storing the measurement file to a disk</li></ul>

## Measurement Example of a Bandpass Filter

This section describes how to measure the transmission characteristics of a 947.5 MHz bandpass filter. The measurement conditions for this measurement example are those suitable for a 947.5 MHz bandpass filter. To measure another device under test (DUT), change the measurement conditions to suit the particular DUT.

For other measurement examples of the E5070B/E5071B, see Chapter “Measurement Examples” in the *E5070B/E5071B User’s Guide*.

### STEP 1. Determining Measurement Conditions

**Step 1.** Preset the E5070B/E5071B.

- **[Preset] - OK**

**Step 2.** Set the S-parameter to S21.

- **[Meas] - S21**

---

**NOTE**

When measuring the reverse transmission characteristics, set the S-parameter to S12.

**Step 3.** Set the data format to the log magnitude format.

- **[Format] - Log Mag**

**Step 4.** Set the center frequency to the bandpass filter center frequency. Next, specify the span frequency, which is set to 200 MHz in this measurement example.

- **[Center] - [9] [4] [7] [.] [5] [M/μ]**
- **[Span] - [2] [0] [0] [M/μ]**

---

**NOTE**

When entering the frequency unit using the keyboard, type "G" for GHz, "M" for MHz, and "k" for kHz.

**Step 5.** Specify the number of measurement points per sweep. The number of measurement points in this measurement example is set to 401.

- **[Sweep Setup] - Points - [4] [0] [1] [x 1]**

**Step 6.** Specify the power level of the signal source. The power level in this measurement example is set to -10 dBm.

- **[Sweep Setup] - Power - [+/-] [1] [0] [x 1]**

**Step 7.** Specify the IF bandwidth of the receiver as necessary. In this measurement example, the IF bandwidth is set to 10 kHz because of the need to lower the noise floor.

- **[Avg] - IF Bandwidth - [1] [0] [k/m]**

## STEP 2. Calibration

To turn the error correction ON, set the calibration type to the full 2-port calibration and measure the calibration data.

For details about calibration, see Chapter “Calibration” in the *E5070B/E5071B User’s Guide*.

**Step 1.** Select the calibration kit suitable for the measurement cable. In this measurement example, Calibration Kit 85032F is selected.

- [Cal] - Cal Kit - 85032F

**Step 2.** Set the calibration type to the full 2-port calibration using the test port 1 and 2.

- [Cal] - Calibrate - 2-Port Cal - Select Ports - 1-2

**Step 3.** Connect the OPEN standard (included in the calibration kit) to the other end of the measurement cable that is connected to the test port 1 as shown in Figure 3-13, and measure the open calibration data at the test port 1. After measuring the open calibration data, symbol  $\surd$  is displayed to the left of the **Port 1 Open** button.

- [Cal] - Calibrate - 2-Port Cal - Reflection - Port1 Open

In the same way, measure the calibration data for the SHORT/LOAD standards at the test port 1.

Figure 3-13

Connecting the OPEN/SHORT/LOAD standards

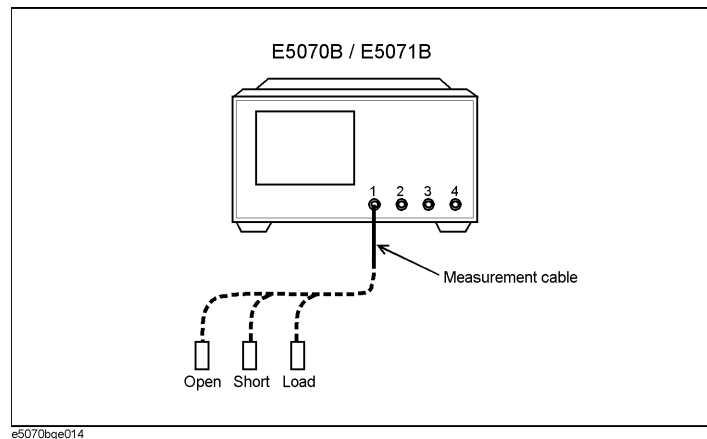

**Step 4.** In the same way as described above, measure the calibration data for the OPEN/SHORT/LOAD standards at the test port 2.

**Step 5.** Connect the THRU standard (included in the calibration kit) between the measurement cables as shown in Figure 3-14, and measure the thru calibration data. After measuring the thru calibration data, symbol  $\checkmark$  is displayed to the left of the **Port 1-2 Thru** button.

- **[Cal] - Calibrate - 2-Port Cal - Transmission - Port 1-2 Thru**

**Figure 3-14**

**Connecting the THRU standard**

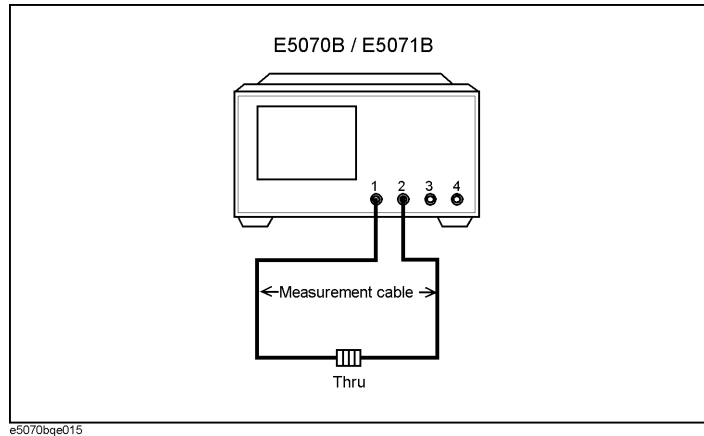

**Step 6.** Make the full 2-port calibration measurement DONE. The calibration factor is calculated based on the calibration data acquired, and the error correction is turned ON.

- **[Cal] - Calibrate - 2-Port Cal - Done**

**Step 7.** Select the type in which the data is to be saved before saving the calibration factor (calculated based on the calibration data).

- **[Save/Recall] - Save Type - State & Cal**

**Step 8.** Store the calibration file to the disk of the E5070B/E5071B. The symbol “X” appearing in the operations below represent the assigned numbers to be used when the file is saved.

- **[Save/Recall] - Save State - State 0X**

For more information on saving/reading internal data, see Chapter “Data Output“ in the *E5070B/E5071B User’s Guide*.



### STEP 3. Connecting the Device Under Test(DUT)

Step 1. Connect t the DUT to the E5070B/E5071B. (See Figure 3-15.)

Figure 3-15

Connecting the DUT

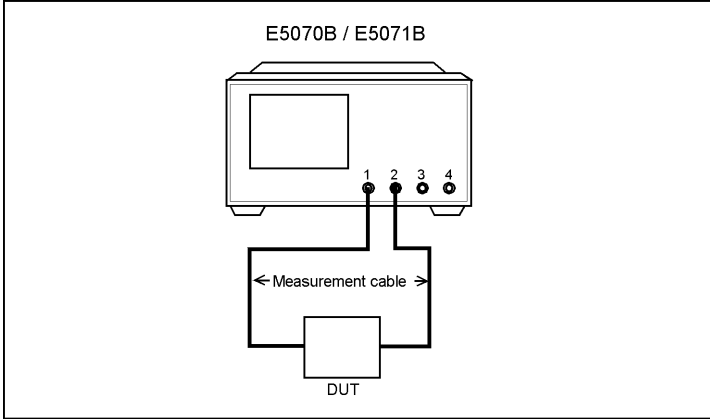

**NOTE**

Applying the setting value for the power level (-10 dBm) may destroy some DUTs. Should this occur, first select the proper power level and then connect the DUT to the E5070B/E5071B.

Step 2. Set the appropriate scale by executing the auto scale. (See Figure 3-16.)

- [Scale] - Auto Scale

You can also adjust the scale by entering arbitrary values in the **Scale/Div** button, **Reference Position** button, and **Reference Value**.

Figure 3-16

S21 trace after executing the auto scale

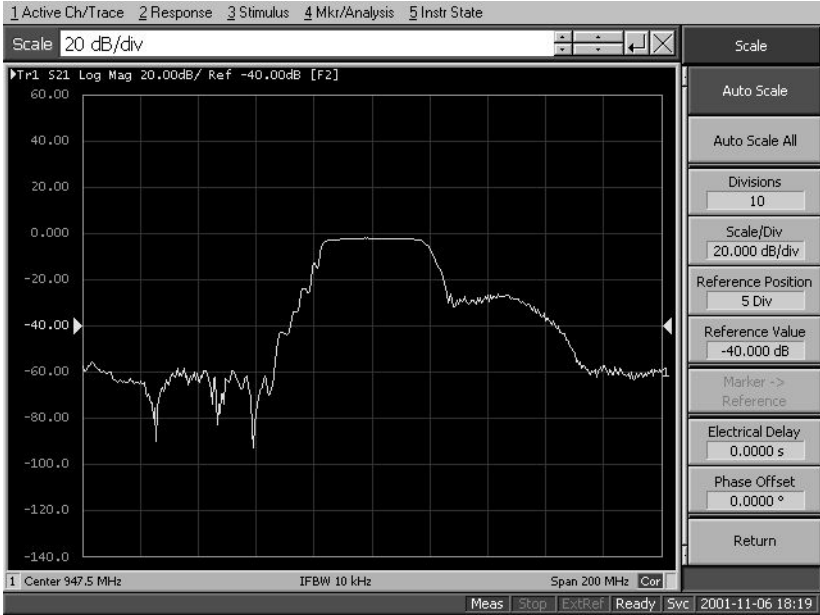

## STEP 4. Analyzing Measurement Results

This section describes how to use the marker function to read out important parameters for the transmission measurement of the bandpassfilter (insertion loss, -3 dB bandwidth).

### Measuring the Insertion Loss

**Step 1.** Display a marker.

- **[Marker] - Marker 1**

**Step 2.** Using one of the following methods, move the marker to the center frequency of the bandpass filter.

- On the entry bar, press **[9] [4] [7] [.] [5] [M/μ]**.
- Turn the rotary knob (⊙) on the front panel to set it to the center frequency (947.5 MHz).

**Step 3.** Read the marker value displayed as shown in Figure 3-17. In this example, the response value denotes the insertion loss.

Figure 3-17

### Measuring an Insertion Loss

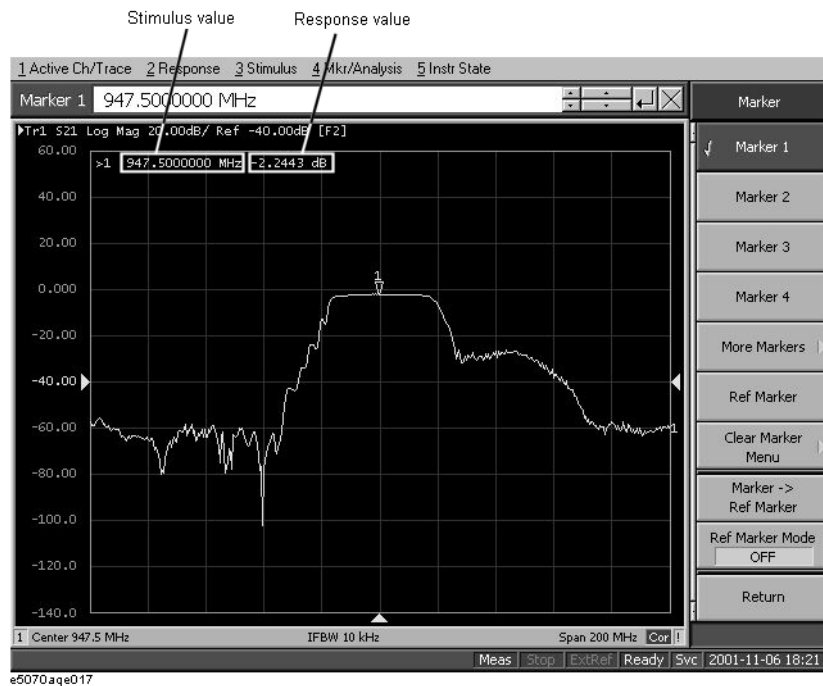

### Measuring the -3 dB Bandwidth

Using the marker bandwidth search function, the bandwidth, center frequency between two cutoff frequency points, Q value, and insertion loss are all read out. These parameters are described in Table 3-1.

**NOTE** If the two cutoff frequency points are not found, all data items except the insertion loss revert to zero.

**Table 3-1 Parameters for the Bandwidth Search Function**

Parameter	Description
BW (Bandwidth)	Stimulus width between two cutoff frequency points (low and high)
cent (Center Frequency)	Center point between cutoff frequency points (low and high)
low (Left-side Cutoff Frequency)	The lower frequency of the two cutoff frequency points
high (Right-side Cutoff Frequency)	The higher frequency of the two cutoff frequency points
Q (Q Value)	$Q = \frac{cent}{BW}$
loss (Insertion Loss)	The amplitude difference between at the center frequency and at 0 dBm

- Step 1.** Display the marker.
  - **[Marker] - Marker 1**
- Step 2.** Using one of the following methods, move the marker to the center frequency of the bandpass filter.
  - On the entry bar, press **[9] [4] [7] [.] [5] [M/μ]**.
  - Turn the rotary knob (  ) on the front panel to set it to the center frequency (947.5 MHz).
- Step 3.** Specify the bandwidth definition value that defines the pass band of the filter. In this measurement example, it is set to -3 dB.
  - **[Marker Search] - Bandwidth Value - [+/-] [3] [x 1]**
- Step 4.** Set the bandwidth search function ON.
  - **[Marker Search] - Bandwidth**
- Step 5.** The bandwidth data items (BW, cent, low, high, Q, loss) will be displayed. (See Figure 3-18.)

Figure 3-18 Measuring the -3 dB Bandwidth



## STEP 5. Outputting Measurement Results (Save)

You can save not only the internal data but also the measurement results such as trace data and display screens to the disk .

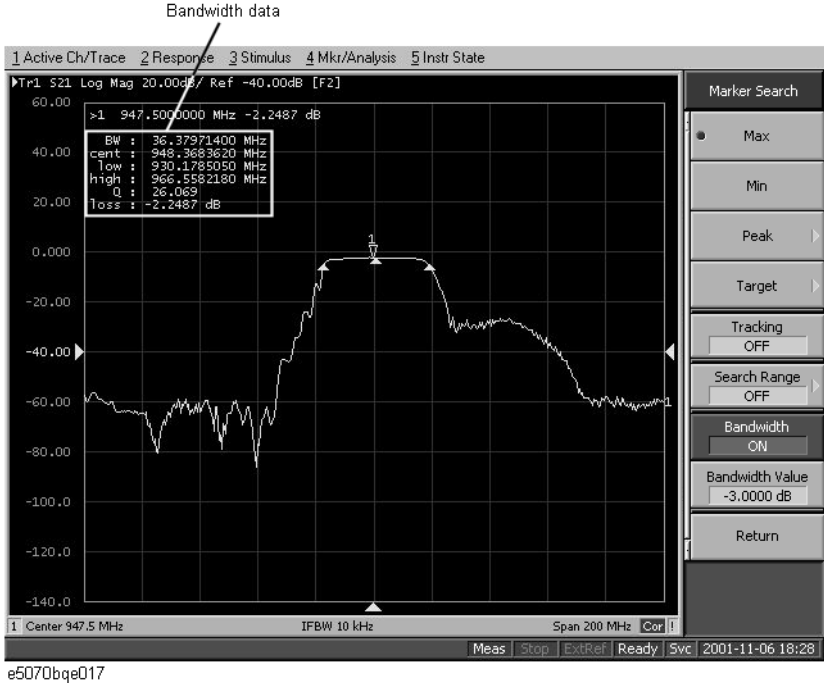
### Saving the Trace Data(in CSV format)

You can save the trace data to the disk of the E5070B/E5071B in CSV file format (extension: .csv). Since the CVS-formatted data to be saved is a text file, you can analyze the data using Microsoft Excel.

**Step 1.** Follow the operation method described below to save the trace data.

- **[Save/Recall] - Save Trace Data**

### Saving the Display Screen

You can save the screen displayed on the E5070B/E5071B to the disk of the E5070B/E5071B in Windows bitmap file format (extension: .bmp) or Portable Network Graphics format (extension: .png).

**Step 1.** Follow the operation method described below to save the display screen.

- **[System] - Dump Screen Image**

---

#### NOTE

---

The image on the LCD display memorized in the volatile memory (clipboard) (the image on the LCD display when the **[Capture] ([System])** key is pressed) is saved.



---

## **A** **Manual Changes**

This appendix contains the information required to adapt this manual to versions or configurations of the E5070B/E5071B manufactured earlier than the current printing date of this manual.

---

## Manual Changes

To adapt this manual to your E5070B/E5071B, refer to Table A-1 and Table A-2.

**Table A-1** Manual Changes by Serial Number

Serial Prefix or Number	Make Manual Changes
MY424	Change 2
MY42100211 (E5070B) MY42100407 (E5071B)	Change 1

**Table A-2** Manual Changes by Firmware Version

Version	Make Manual Changes

Agilent Technologies uses a two-part, ten-character serial number that is stamped on the serial number plate (Figure A-1). The first five characters are the serial prefix and the last five digits are the suffix.

**Figure A-1** Example of Serial Number Plate

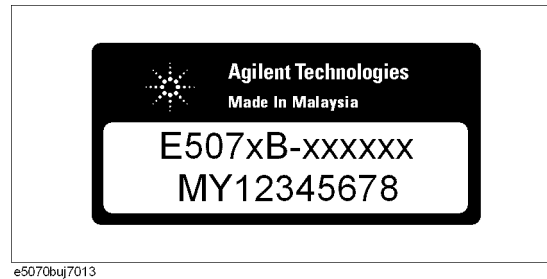

### Change 2

- CD-ROM (of the Agilent IO Libraries Suite) is added as standard accessories.
- Sample program disk and VBA sample program disk are deleted as options.

### Change 1

- GPIB adapter is added as standard accessories.



**A**

- accessories
  - connecting accessories, 26
  - items packaged with the E5070B/E5071B, 18
- ACTIVE CH/TRACE block, 46
- Agilent Technologies sales and service office
  - shipping considerations due to breakdown, etc., 42
- analysis
  - analyzing measurement results, 58
- assistance, 5
- auto scale
  - executing auto scale, 57

**B**

- bandpass filter
  - basic measurement example, 54
- bandwidth search function
  - measuring -3dB bandwidth, 59
- BNC cable
  - connecting the BNC cable, 27
- BW
  - bandwidth search function, 59

**C**

- cable
  - power cable options, 31
- calibration
  - performing full 2-port calibration, 55
- calibration kit
  - selecting the calibration kit, 55
- cent
  - bandwidth search function, 59
- certification, 5
- channel status bar, 48
- channel title bar, 48
- cleaning
  - how to clean the instrument, 41
  - maintaining an N-type connector, 41
- clock
  - setting the internal clock, 36
- connection
  - connecting accessories, 26
  - connecting the DUT, 57
  - connecting the standards, 55
- connector
  - maintaining an N-type connector, 41

**D**

- data entry bar, 48
- date
  - setting the date/time, 36
- display
  - names and descriptions of the LCD screen, 47
  - saving the display screen, 61
  - turning the date/time display ON and OFF, 37
- Documentation Warranty, 5

**DUT**

- connecting the DUT, 57

**E**

- E5070B/E5071B
  - basic measurement procedures, 53
  - items packaged with the E5070B/E5071B, 18
  - overview of the E5070B/E5071B, 13
  - starting the E5070B/E5071B, 34
  - three methods of operation, 49
- Ecal module
  - connecting the Ecal module, 30
- ENTRY block, 46
- environmental requirements
  - operation environment, 20
  - ventilation space, 21
- error correction
  - performing full 2-port calibration, 55
- exclusive remedies, 5

**F**

- features
  - overview of the E5070B/E5071B, 13
- floppy disk drive, 46
- front handles
  - how to install the handle kit, 24
- front panel
  - names and description of E5070B/E5071B parts, 45
- fuse
  - fuse type of the E4991A, 33

**G**

- GPIB adapter, 64

**H**

- handle and rack-mount kit
  - how to install the rack-mount and handle kit, 25
- handle kit
  - how to install the handle kit, 24
- high
  - bandwidth search function, 59
- history,
  - manual printing, 2

**I**

- IF bandwidth
  - specifying the IF bandwidth, 54
- Initial registration, 38
- insertion loss
  - measuring the insertion loss, 58
- inspection
  - checking the shipment, 17
- Installation and Quick Start Guide, 7
- INSTR STATE block, 46
- instrument status bar, 48

## K

keyboard  
connecting the keyboard, 26

## L

LAN cable  
connecting the LAN cable, 28  
LCD screen, 46  
names and descriptions of the LCD screen, 47  
LOAD standard  
Connecting LOAD standard, 55  
loss  
bandwidth search function, 59  
low  
bandwidth search function, 59

## M

maintenance, 41  
manual  
contents, 12  
manual changes, 63  
manual printing history, 2  
marker, 48  
analyzing measurement results, 58  
marker indicator, 48  
marker value, 48  
measurement  
basic measurement procedures, 53  
measurement conditions  
determining measurement conditions, 54  
menu bar, 48  
MKR/ANALYSIS block, 47  
mouse  
connecting the mouse, 26

## N

NAVIGATION block, 46  
Network Identification Wizard, 38

## O

OPEN standard  
Connecting OPEN standard, 55  
operations  
three methods of operation, 49  
outputting  
outputting measurement results(save), 61

## P

power  
check the power supply, 31  
disconnecting device, 35  
disconnection from supply source, 35  
power cable options, 31  
power-on test, 41  
shutdown, 34

turning the power ON and OFF, 34  
verification and connection of power cable, 31  
power supply  
blown fuse, 33  
presetting the E5070B/E5071B, 54  
printer  
connecting the printer, 29  
product  
overview of the E5070B/E5071B, 13  
Professional Setup wizard, 38  
Programmer's Guide, 7

## Q

Q  
bandwidth search function, 59  
Quick Start Guide, 7  
contents, 12

## R

rack-mount and handle kit  
how to install the rack-mount and handle kit, 25  
rack-mount kit  
how to install the rack-mount kit, 25  
reference line indicator, 48  
Registration, 38  
RESPONSE block, 46

## S

safety  
symbols, 4  
safety summary, 3  
save  
outputting measurement results, 61  
saving the calibration factor, 56  
self-test, 41  
Serial number plate, 64  
service center  
shipping considerations due to breakdown, etc., 42  
shipment  
shipment considerations due to breakdown, etc., 42  
SHORT standard  
Connecting SHORT standard, 55  
shutdown  
turning the power OFF, 34  
softkey menu, 48  
standby switch, 46  
status bar  
channel status bar, 48  
instrument status bar, 48  
STIMULUS block, 46  
system  
installing rack mount flanges, 23

## T

test port, 47  
THRU

---

- connecting THRU standard, 56
- time
  - setting the date/time, 36
- title
  - channel title bar, 48
- trace bar, 48
- trace data
  - saving trace data, 61
- transmission
  - measurement example of a bandpass filter, 54
- typeface conventions, 6

**U**

- USB port
  - front panel, 47
- User's Guide, 7

**V**

- VBA Programmer's Guide, 7

**W**

- Windows 2000, 38

# REGIONAL SALES AND SUPPORT OFFICES

*For more information about Agilent Technologies test and measurement products, applications, services, and for a current sales office listing, visit our web site: <http://www.agilent.com/find/tmdir>. You can also contact one of the following centers and ask for a test and measurement sales representative. 21/01/2004*

## **United States:**

Test and Measurement Call Center  
(tel) 1 800 452-4844  
(fax) 1 888 900-8921

## **Australia/New Zealand:**

(tel) (61 3) 9210-5555 (Australia)  
(fax) (61 3) 9210-5899  
(tel) (64 4) 939-0636 (New Zealand)  
(fax) (64 4) 972-5364

## **Canada:**

Test and Measurement Call Center  
(tel) 1 877 894-4414  
(fax) 1 888 900-8921

## **Asia Pacific:**

(tel) (65) 6375-8100  
(fax) (65) 6836-0252  
Email: [tm\\_asia@agilent.com](mailto:tm_asia@agilent.com)

## **China:**

(tel) 800 810-0189  
(fax) 800 820-2816

## **Europe:**

(tel) (31 20) 547-2323  
(fax) (31 20) 547-2390

## **Japan:**

Call Center  
(tel) 0120 421-345  
(tel) (81) 426 56-7832  
(fax) (81) 426 56-7840

## **Korea:**

(tel) (82 2) 2004-5004  
(fax) (82 2) 2004-5115

## **Latin America:**

(tel) (305) 269-7500  
(fax) (305) 269-7599

## **Taiwan:**

(tel) 0800 047 866  
(fax) 0800 286 331