



**Advanced Test Equipment Rentals**  
**www.atecorp.com 800-404-ATEC (2832)**

## **User Manual**

**Tektronix**

**YBA250**  
**Antenna and Transmission Line**  
**Analyzer**

**071-1047-02**

This document supports firmware version 1.402  
and greater.

**[www.tektronix.com](http://www.tektronix.com)**

Copyright © Tektronix, Inc. All rights reserved.

Tektronix products are covered by U.S. and foreign patents, issued and pending. Information in this publication supercedes that in all previously published material. Specifications and price change privileges reserved.

Tektronix, Inc., P.O. Box 500, Beaverton, OR 97077

TEKTRONIX, TEK, and NetTek are registered trademarks of Tektronix, Inc.

## **WARRANTY**

Tektronix warrants that the products that it manufactures and sells will be free from defects in materials and workmanship for a period of one (1) year from the date of purchase from an authorized Tektronix distributor. If any such product proves defective during this warranty period, Tektronix, at its option, either will repair the defective product without charge for parts and labor, or will provide a replacement in exchange for the defective product. Batteries are excluded from this warranty.

In order to obtain service under this warranty, Customer must notify Tektronix of the defect before the expiration of the warranty period and make suitable arrangements for the performance of service. Customer shall be responsible for packaging and shipping the defective product to the service center designated by Tektronix, shipping charges prepaid, and with a copy of customer proof of purchase. Tektronix shall pay for the return of the product to Customer if the shipment is to a location within the country in which the Tektronix service center is located. Customer shall be responsible for paying all shipping charges, duties, taxes, and any other charges for products returned to any other locations.

This warranty shall not apply to any defect, failure or damage caused by improper use or improper or inadequate maintenance and care. Tektronix shall not be obligated to furnish service under this warranty a) to repair damage resulting from attempts by personnel other than Tektronix representatives to install, repair or service the product; b) to repair damage resulting from improper use or connection to incompatible equipment; c) to repair any damage or malfunction caused by the use of non-Tektronix supplies; or d) to service a product that has been modified or integrated with other products when the effect of such modification or integration increases the time or difficulty of servicing the product.

**THIS WARRANTY IS GIVEN BY TEKTRONIX WITH RESPECT TO THE LISTED PRODUCTS IN LIEU OF ANY OTHER WARRANTIES, EXPRESS OR IMPLIED. TEKTRONIX AND ITS VENDORS DISCLAIM ANY IMPLIED WARRANTIES OF MERCHANTABILITY OR FITNESS FOR A PARTICULAR PURPOSE. TEKTRONIX' RESPONSIBILITY TO REPAIR OR REPLACE DEFECTIVE PRODUCTS IS THE SOLE AND EXCLUSIVE REMEDY PROVIDED TO THE CUSTOMER FOR BREACH OF THIS WARRANTY. TEKTRONIX AND ITS VENDORS WILL NOT BE LIABLE FOR ANY INDIRECT, SPECIAL, INCIDENTAL, OR CONSEQUENTIAL DAMAGES IRRESPECTIVE OF WHETHER TEKTRONIX OR THE VENDOR HAS ADVANCE NOTICE OF THE POSSIBILITY OF SUCH DAMAGES.**





# Table of Contents

<b>Preface</b> .....	<b>xi</b>
Product Overview .....	xi
About this Manual .....	xiii
Additional Information .....	xiv
Conventions .....	xiv
Software Version .....	xiv
Contacting Tektronix .....	xv
<b>General Safety Summary</b> .....	<b>xvii</b>

## Getting Started

The NetTek Analyzer Platform .....	1-1
YBA250 Input Connector .....	1-3
Installing and Removing a Module .....	1-4
Connecting External Power Supplies .....	1-6
Batteries .....	1-7
Powering On the Instrument .....	1-11
Calibrating the Touch-Screen Display .....	1-11
Powering Off the Instrument .....	1-12
Preventing Personal Injury from the Effects of Lightning ....	1-14
Attaching Accessories .....	1-16

## Operating Basics

Navigating the Desktop .....	2-1
Getting Help .....	2-4
Starting the YBA250 Software .....	2-5
Setting the YBA250 Software to Load at Startup .....	2-6
YBA250 User Interface Elements .....	2-7
YBA250 Menus .....	2-13
Entering Text .....	2-17
<b>Connecting a Signal</b> .....	<b>2-19</b>
Use Precision Connectors and Cables .....	2-19
Attaching and Removing Precision Connectors .....	2-20
Connecting an RF Signal .....	2-21

<b>Measurement Overview</b> .....	<b>2-23</b>
One-Port Measurements .....	2-23
Two-Port Measurements .....	2-23
<b>Calibration and Normalization</b> .....	<b>2-25</b>
Calibrating the YBA250 .....	2-25
Normalizing the YBA250 .....	2-40
<b>Configuring the Instrument</b> .....	<b>2-53</b>
Enabling Signal Standards .....	2-53
Setting the Output Power Level .....	2-54
Setting Measurement Method .....	2-56
Setting Display Preferences .....	2-57
Display Trace Smoothing .....	2-58
Changing Settings for Saved Files .....	2-58
Saving GPS Coordinates with your Results .....	2-61

## Reference

<b>Setting the Signal Standards and Test Frequency Range</b> ..	<b>3-1</b>
Selecting Signal Standards .....	3-1
The Test Frequency Range .....	3-2
Setting the Test Frequency Range by Standard and Direction .....	3-3
Setting the Test Frequency Range by Start and Stop Frequency .....	3-5
<b>Measuring Return Loss and VSWR</b> .....	<b>3-7</b>
The Return Loss Display .....	3-7
Measuring Return Loss/VSWR .....	3-8
Measuring Cable Loss .....	3-11
<b>Measuring the Distance to a Fault</b> .....	<b>3-13</b>
The Distance to Fault Display .....	3-13
Measuring the Distance to a Fault .....	3-14
Changing the Vertical Scale Units .....	3-16
Limiting the Bandwidth for a Bandpass Filter .....	3-16
Setting Cable Types .....	3-17
Creating a User-Defined Cable Type .....	3-19
Customizing the Cable Standards Table .....	3-20
Improving the Display of Distance Measurements .....	3-22
Resolution of Distance to Fault Measurement .....	3-23

<b>Measuring Insertion Gain and Loss</b> .....	<b>3-25</b>
The Insertion Gain/Loss Window .....	3-26
Measuring Insertion Gain or Loss .....	3-26
<b>Generating a Continuous Wave (CW) Signal</b> .....	<b>3-31</b>
<b>Working with Traces</b> .....	<b>3-33</b>
Setting the Trace Type .....	3-33
Changing the Units of the Distance to Fault Display .....	3-35
Saving Results .....	3-36
Displaying a Saved Trace .....	3-37
Comparing Traces .....	3-38
<b>Using Markers and Band Edge Cursors</b> .....	<b>3-43</b>
Displaying Markers .....	3-43
Band Edge Cursors .....	3-49
Markers and Mask Testing .....	3-50
<b>Mask Testing</b> .....	<b>3-51</b>
The Mask Maker Window .....	3-51
Using the Mask Maker .....	3-53
Mask Maker Guidelines .....	3-56
Defining (Selecting) a Mask for Testing .....	3-57
Performing a Mask Test .....	3-58
<b>Saving and Recalling Results, Screens, and Setups</b> .....	<b>3-61</b>
Saving Measurement Results .....	3-61
Recalling Measurement Results .....	3-63
Exporting Measurement Results .....	3-64
Exporting a Screen .....	3-65
Differences Between Exported Screens and Results .....	3-66
Saving Setups .....	3-68
Recalling Setups .....	3-69
Customizing the Setup menu .....	3-70

## Appendices

<b>Appendix A: Specifications</b> .....	<b>A-1</b>
<b>Appendix B: Accessories</b> .....	<b>B-1</b>
Standard Accessories .....	B-1
Optional Accessories .....	B-2
<b>Appendix C: Options</b> .....	<b>C-1</b>

<b>Appendix D: Upgrading/Reinstalling Software</b> .....	<b>D-1</b>
<b>Appendix E: Functional Verification Procedure</b> .....	<b>E-1</b>
Self Tests .....	E-1
Functional Tests .....	E-3
<b>Appendix F: Supported Signal Standards</b> .....	<b>F-1</b>
<b>Appendix G: Customizing the Channel Table</b> .....	<b>G-1</b>

## **Glossary**

## **Index**



# Figures

<b>Figure 1-1: NetTek Analyzer Layout</b> .....	<b>1-1</b>
<b>Figure 1-2: Front Panel Controls</b> .....	<b>1-2</b>
<b>Figure 1-3: I/O ports (Y400 NetTek Analyzer Platform)</b> .....	<b>1-3</b>
<b>Figure 1-4: YBA250 test port.</b> .....	<b>1-3</b>
<b>Figure 1-5: Removing the bus cover</b> .....	<b>1-4</b>
<b>Figure 1-6: Attaching the YBA250 module</b> .....	<b>1-5</b>
<b>Figure 1-7: External power supplies</b> .....	<b>1-6</b>
<b>Figure 1-8: Opening the battery compartment</b> .....	<b>1-7</b>
<b>Figure 1-9: Opening the battery retainer</b> .....	<b>1-8</b>
<b>Figure 1-10: Installing/removing a battery</b> .....	<b>1-8</b>
<b>Figure 1-11: NetTek Analyzer Platform tilt stand</b> .....	<b>1-16</b>
<b>Figure 1-12: Installing the tilt stand on multiple instrument modules</b> .....	<b>1-17</b>
<b>Figure 1-13: NetTek Analyzer Platform shoulder strap and strand hook</b> .....	<b>1-18</b>
<b>Figure 2-1: The YBA250 display</b> .....	<b>2-5</b>
<b>Figure 2-2: Setting the StartUp Application</b> .....	<b>2-6</b>
<b>Figure 2-3: YBA250 user interface elements</b> .....	<b>2-7</b>
<b>Figure 2-4: The Soft Keyboard</b> .....	<b>2-17</b>
<b>Figure 2-5: How to attach a precision connector</b> .....	<b>2-21</b>
<b>Figure 2-6: TEST PORT location</b> .....	<b>2-22</b>
<b>Figure 2-7: The Calibration window</b> .....	<b>2-26</b>
<b>Figure 2-8: Precision terminations from YBAC1 Calibration Kit</b> .....	<b>2-28</b>
<b>Figure 2-9: Ready to perform calibration</b> .....	<b>2-29</b>
<b>Figure 2-10: Calibration window after calibration is done</b> .....	<b>2-31</b>

<b>Figure 2-11: Ready to perform calibration with cable</b> . . . .	2-32
<b>Figure 2-12: Calibration window after calibration is done</b> . . . . .	2-33
<b>Figure 2-13: Calibration browser window</b> . . . . .	2-35
<b>Figure 2-14: The Calibration window</b> . . . . .	2-36
<b>Figure 2-15: Normalization window</b> . . . . .	2-41
<b>Figure 2-16: Normalization type status label</b> . . . . .	2-43
<b>Figure 2-17: Normalization Browser window</b> . . . . .	2-47
<b>Figure 2-18: Save Normalization window</b> . . . . .	2-48
<b>Figure 2-19: Load Saved Normalization window</b> . . . . .	2-49
<b>Figure 2-20: The Signal Standards tab of the Options window</b> . . . . .	2-53
<b>Figure 2-21: Setting the output power level</b> . . . . .	2-55
<b>Figure 2-22: Location of Method drop-down list</b> . . . . .	2-56
<b>Figure 2-23: Preferences tab showing available color schemes</b> . . . . .	2-57
<b>Figure 2-24: The Save &amp; Export tab</b> . . . . .	2-59
<b>Figure 3-1: The Signal Standards tab of the Options window</b> . . . . .	3-1
<b>Figure 3-2: Frequency range controls</b> . . . . .	3-3
<b>Figure 3-3: Select Channel dialog box</b> . . . . .	3-5
<b>Figure 3-4: Entering the frequency with the keypad</b> . . . . .	3-6
<b>Figure 3-5: The Return Loss window</b> . . . . .	3-7
<b>Figure 3-6: Example of a Return Loss measurement</b> . . . . .	3-10
<b>Figure 3-7: Example of a VSWR measurement</b> . . . . .	3-10
<b>Figure 3-8: Example of a cable loss measurement</b> . . . . .	3-12
<b>Figure 3-9: The Distance to Fault display</b> . . . . .	3-13
<b>Figure 3-10: The Distance Options tab</b> . . . . .	3-15
<b>Figure 3-11: An example of a distance to fault measurement</b> . . . . .	3-16
<b>Figure 3-12: The Cable Types window</b> . . . . .	3-18

**Figure 3-13: User Defined Cable window . . . . . 3-19**

**Figure 3-14: A portion of the cablestandards text file . . . . . 3-22**

**Figure 3-15: The Return Gain/Loss window . . . . . 3-26**

**Figure 3-16: Setting output power for CW  
signal mode . . . . . 3-31**

**Figure 3-17: Setting the trace type . . . . . 3-34**

**Figure 3-18: Setting the distance units . . . . . 3-36**

**Figure 3-19: Defining Trace 2 . . . . . 3-39**

**Figure 3-20: Selecting the first result file . . . . . 3-40**

**Figure 3-21: Selecting the second result file . . . . . 3-41**

**Figure 3-22: Two compared traces . . . . . 3-41**

**Figure 3-23: Display with markers . . . . . 3-43**

**Figure 3-24: Display without markers . . . . . 3-44**

**Figure 3-25: Assigning markers to a trace . . . . . 3-47**

**Figure 3-26: Band Edge Cursor displayed . . . . . 3-49**

**Figure 3-27: Band Edge Cursors always visible . . . . . 3-50**

**Figure 3-28: The Mask Maker utility . . . . . 3-51**

**Figure 3-29: Example of a recalled results display . . . . . 3-63**

**Figure 3-30: Sample Exported Results file . . . . . 3-65**

**Figure 3-31: Example of an Exported Results file . . . . . 3-68**

**Figure 3-32: Setup menu controls . . . . . 3-70**

**Figure 3-33: Specifying the List of Setups . . . . . 3-72**

**Figure E-1: Settings to run diagnostics . . . . . E-2**

**Figure E-2: Calibration window prior to calibration . . . . . E-4**

**Figure E-3: Ready to perform calibration . . . . . E-4**

**Figure E-4: Calibration window after calibration  
is done . . . . . E-6**

## Tables

<b>Table i: Standard module accessories</b> .....	<b>xiii</b>
<b>Table 1-1: Approximate battery charge times</b> .....	<b>1-9</b>
<b>Table 2-1: Status area icons</b> .....	<b>2-3</b>
<b>Table 2-2: Help window buttons</b> .....	<b>2-4</b>
<b>Table 2-3: Command bar area buttons and icons</b> .....	<b>2-8</b>
<b>Table 2-4: Tuning control area buttons and icons</b> .....	<b>2-9</b>
<b>Table 2-5: Shared control area buttons and icons</b> .....	<b>2-10</b>
<b>Table 2-6: Instrument area buttons and icons</b> .....	<b>2-12</b>
<b>Table 2-7: The File menu</b> .....	<b>2-13</b>
<b>Table 2-8: The View menu</b> .....	<b>2-14</b>
<b>Table 2-9: The Setup menu</b> .....	<b>2-15</b>
<b>Table 2-10: The Tools menu</b> .....	<b>2-16</b>
<b>Table 2-11: Calibration window elements</b> .....	<b>2-27</b>
<b>Table 2-12: Calibration Browser Fields</b> .....	<b>2-37</b>
<b>Table 2-13: Normalization window elements</b> .....	<b>2-41</b>
<b>Table 2-14: Performance versus Resolution</b> .....	<b>2-56</b>
<b>Table 3-1: Channel table file contents</b> .....	<b>3-21</b>
<b>Table 3-2: Trace type options</b> .....	<b>3-33</b>
<b>Table 3-3: Elements of Marker Readouts</b> .....	<b>3-45</b>
<b>Table 3-4: Marker placement</b> .....	<b>3-47</b>
<b>Table 3-5: Mask maker buttons and icons</b> .....	<b>3-52</b>
<b>Table 3-6: Differences between exported screens and traces</b> .....	<b>3-66</b>
<b>Table 3-7: Comparison of file formats for exporting screens</b> .....	<b>3-67</b>

<b>Table A-1: Measurement characteristics</b>	<b>A-1</b>
<b>Table A-2: Measurement port characteristics</b>	<b>A-5</b>
<b>Table A-3: Calibration characteristics</b>	<b>A-5</b>
<b>Table A-4: Environmental characteristics</b>	<b>A-6</b>
<b>Table A-5: Physical characteristics</b>	<b>A-7</b>
<b>Table A-6: Miscellaneous characteristics</b>	<b>A-7</b>
<b>Table A-7: Safety compliance</b>	<b>A-8</b>
<b>Table A-8: Electromagnetic compatibility (EMC)</b>	<b>A-9</b>
<b>Table B-1: Standard accessories</b>	<b>B-1</b>
<b>Table B-2: Optional accessories</b>	<b>B-2</b>
<b>Table C-1: Configuration option</b>	<b>C-1</b>
<b>Table F-1: Cellular standards supported</b>	<b>F-1</b>
<b>Table G-1: Channel table file contents</b>	<b>G-2</b>

## Table of Contents

---

# Preface

The YBA250 Antenna and Transmission Line Analyzer is part of the NetTek Analyzer Platform BTS Field Tool family. This high performance, portable, field-ready tester is optimized for fast trouble resolution and easy BTS antenna and tower mounted amplifier (TMA) performance verification.

## Product Overview

The standard YBA250 configuration consists of two components; the YBA250 application module and the NetTek Analyzer Platform. The application module contains the hardware and software needed to analyze antenna characteristics and performance. The NetTek Analyzer Platform provides the power and user interface to run the YBA250 application module software and hardware. The YBA250 can be purchased separately to install on a NetTek Analyzer Platform that you already have.

The YBA250 Antenna and Transmission Line Analyzer application features include:

- One-port Return Loss and VSWR measurements to quickly analyze a system
- One-port Cable Loss measurement to analyze system cable characteristics
- One-port distance-to-fault (DTF) measurement to identify the location
- Two-port Insertion Gain and Loss measurements to analyze the characteristics of active components (such as TMAs and directional couplers) and passive devices (such as bandwidth filters and cables)
- Advanced calibration and normalization techniques to eliminate the need to perform a calibration each time the frequency or display range is changed

- User-defined calibration and normalization data sets for testing and measuring specific frequencies and power levels
- User-defined test masks to provide fast pass/fail testing of antenna, device, or system performance

The NetTek Analyzer Platform user interface uses the Microsoft Windows CE operating system, so you spend less time learning the instrument and more time troubleshooting the network. Key NetTek Analyzer Platform features include:


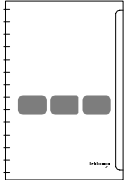
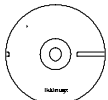
- High-visibility color display with a touch-screen interface
- Extendible instrument architecture lets you add other NetTek-compatible measurement modules (up to three) as your testing and troubleshooting needs change
- Ruggedized package for real-world testing conditions
- Removable battery packs to extend in-field testing time
- I/O ports connect the instrument to a printer, an external keyboard, and the Internet
- Two PCMCIA card slots for adding storage memory, additional measurement capabilities, and using PCMCIA Ethernet and modem cards to connect to a network or the internet
- Software applications and utilities that support communications, power management, instrument configuration, text editing, Web browsing and more



## Standard Accessories

Table i provides a list of the standard accessories supplied with the YBA250 Antenna and Transmission Line Analyzer Module. For a complete list of standard and optional accessories, see *Appendix B*, beginning on page B-1.

**Table i: Standard module accessories**

	<b>N Connector Plastic Cover.</b> Used to protect the TEST PORT signal connector.
	<b>User Manual.</b> Contains information on setup, basic operation, and taking measurements.
	<b>CD-ROM.</b> Contains instrument software and an Adobe Acrobat PDF version of the User Manual.

## About this Manual

This manual is divided into four sections: *Getting Started*, *Operating Basics*, *Reference* and *Appendices*.

The *Getting Started* section explains how to set up and start using your YBA250 Antenna and Transmission Line Analyzer.

The *Operating Basics* section explains how to operate the YBA250.

The *Reference* section explains how to perform specific tests with the YBA250.

The *Appendices* contain specifications, a functional verification procedure, and other information that you might need occasionally.

## Additional Information

The YBA250 Antenna and Transmission Line Analyzer contains online help to enable you to quickly get explanations of how to use your YBA250. The online help is the first place you should look for information about operating the YBA250 or the NetTek Analyzer Platform.

## Conventions

This manual uses the following convention. The statement **Start > Help** is requesting that you open the Start menu and select Help. To do this, tap the Start button in the toolbar at the bottom of the desktop window; then tap Help in the resulting menu.

## Software Version

This manual supports YBA250 Antenna and Transmission Line Analyzers running software version 1.402 or greater. To determine your software version, select **Tools > Software Info** when the YBA250 application is running.

## Contacting Tektronix

<b>Phone</b>	1-800-833-9200*
<b>Address</b>	Tektronix, Inc. Department or name (if known) 14200 SW Karl Braun Drive P.O. Box 500 Beaverton, OR 97077 USA
<b>Web site</b>	<a href="http://www.tektronix.com">www.tektronix.com</a>
<b>Sales support</b>	1-800-833-9200, select option 1*
<b>Service support</b>	1-800-833-9200, select option 2*
<b>Technical support</b>	<a href="http://www.tektronix.com/support">www.tektronix.com/support</a> 1-800-833-9200, select option 3* 6:00 a.m. - 5:00 p.m. Pacific Standard Time

---

\* **This phone number is toll free in North America. After office hours, please leave a voice mail message. Outside North America, contact a Tektronix sales office or distributor; see the Tektronix web site for a list of offices.**



# General Safety Summary

Review the following safety precautions to avoid injury and prevent damage to this product or any products connected to it. To avoid potential hazards, use this product only as specified.

*Only qualified personnel should perform service procedures.*

While using this product, you may need to access other parts of the system. Read the *General Safety Summary* in other system manuals for warnings and cautions related to operating the system.



---

**WARNING.** *Do not connect to any source which may be subject to the effects of lightning.*

---

## To Avoid Fire or Personal Injury

**Use Proper Power Cord.** Use only the power cord specified for this product and certified for the country of use.

**Connect and Disconnect Properly.** Do not connect or disconnect probes or test leads while they are connected to a voltage source.

**Observe All Terminal Ratings.** To avoid fire or shock hazard, observe all ratings and markings on the product. Consult the product manual for further ratings information before making connections to the product.

The common terminal is at ground potential. Do not connect the common terminal to elevated voltages.

**Replace Batteries Properly.** Replace batteries only with the proper type and rating specified.

**Recharge Batteries Properly.** Recharge batteries only as specified.

**Use Proper AC Adapter.** Use only the AC adapter specified for this product.

**Do Not Operate Without Covers.** Do not operate this product with covers or panels removed.

**Do Not Operate With Suspected Failures.** If you suspect there is damage to this product, have it inspected by qualified service personnel.

**Do Not Operate in an Explosive Atmosphere.**

## Safety Terms and Symbols

**Terms in This Manual.** These terms may appear in this manual:



---

**WARNING.** *Warning statements identify conditions or practices that could result in injury or loss of life.*

---



---

**CAUTION.** *Caution statements identify conditions or practices that could result in damage to this product or other property.*

---

**Terms on the Product.** These terms may appear on the product:

DANGER indicates an injury hazard immediately accessible as you read the marking.

WARNING indicates an injury hazard not immediately accessible as you read the marking.

CAUTION indicates a hazard to property including the product.

**Symbols on the Product.** These symbols may appear on the product:



CAUTION  
Refer to Manual

## Battery Recycling

The NetTek Analyzer Platform uses rechargeable Lithium Ion batteries, which must be recycled or disposed of properly. For the location of a local battery recycler in the U.S. or Canada, please contact:

RBRC  
Rechargeable Battery Recycling Corp.  
P.O. Box 141870  
Gainesville, Florida 32614

(800) BATTERY  
(800) 227-7379  
www.rbrc.com



# Getting Started



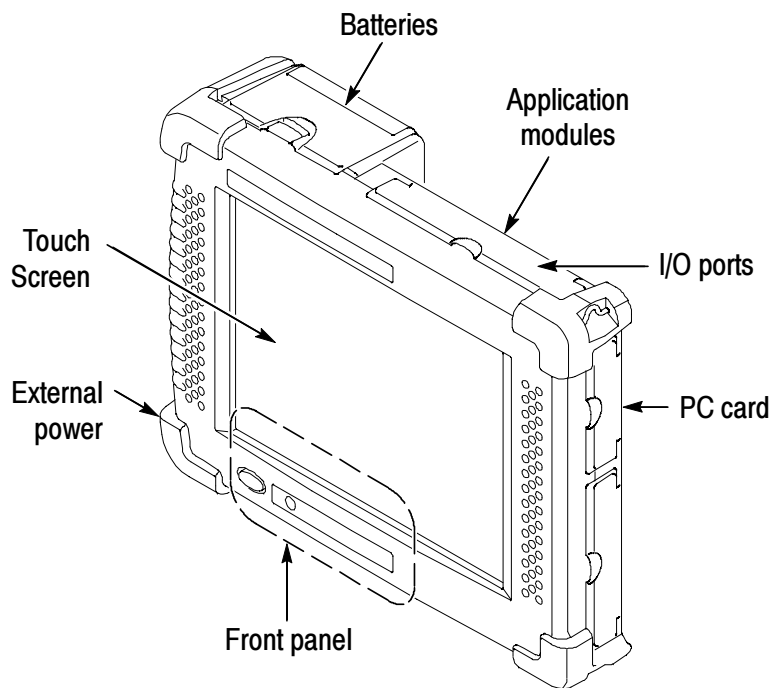


# Getting Started

This section describes the Y400 NetTek Analyzer Platform, on which the YBA250 Antenna and Transmission Line Analyzer operates.

## The NetTek Analyzer Platform

Figure 1-1 shows the NetTek Analyzer Platform layout. Figure 1-2 shows the front-panel controls and indicators. Figure 1-3 shows the input and output ports.



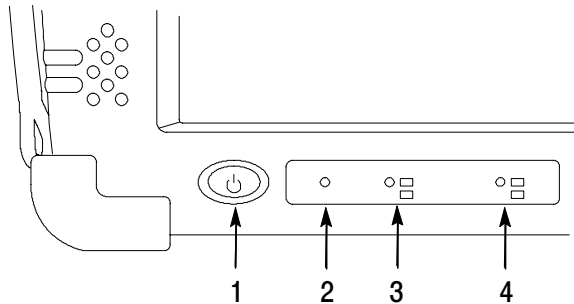
**Figure 1-1: NetTek Analyzer Layout**



---

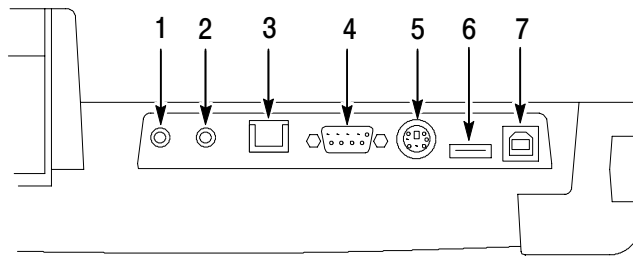
**CAUTION.** Only use soft objects, such as plastic or your finger, to tap the touch-screen display. Do not use metal or other abrasive materials because they will damage the display surface.

---



**Figure 1-2: Front Panel Controls**

- 1. Power/Suspend Switch.** Push on; push off. See pages 1-11 and 1-12 for additional information.
- 2. Reset Switch.** Push to perform a hardware reset if a lock-up occurs. All programs and data loaded into volatile memory since startup are lost.
- 3. Status Indicator.** Green indicates that the instrument is powered on. Amber indicates that the instrument is powered on but the display is turned off (for power conservation).
- 4. Batteries Indicator.** Green indicates that the instrument is connected to an external power source (and charging any installed batteries). Red indicates a low battery.

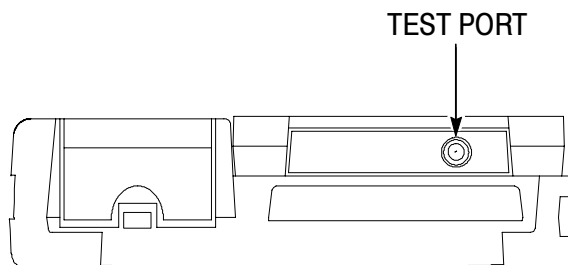


**Figure 1-3: I/O ports (Y400 NetTek Analyzer Platform)**

1. Microphone input
2. Headphone jack
3. Ethernet connector (RJ-45)
4. Serial port (RS-232)
5. PS/2 keyboard connector
6. USB Host connector
7. USB Slave connector

## YBA250 Input Connector

Figure 1-4 shows the location of the YBA250 Application Module TEST PORT input connector.



**Figure 1-4: YBA250 test port.**

## Installing and Removing a Module

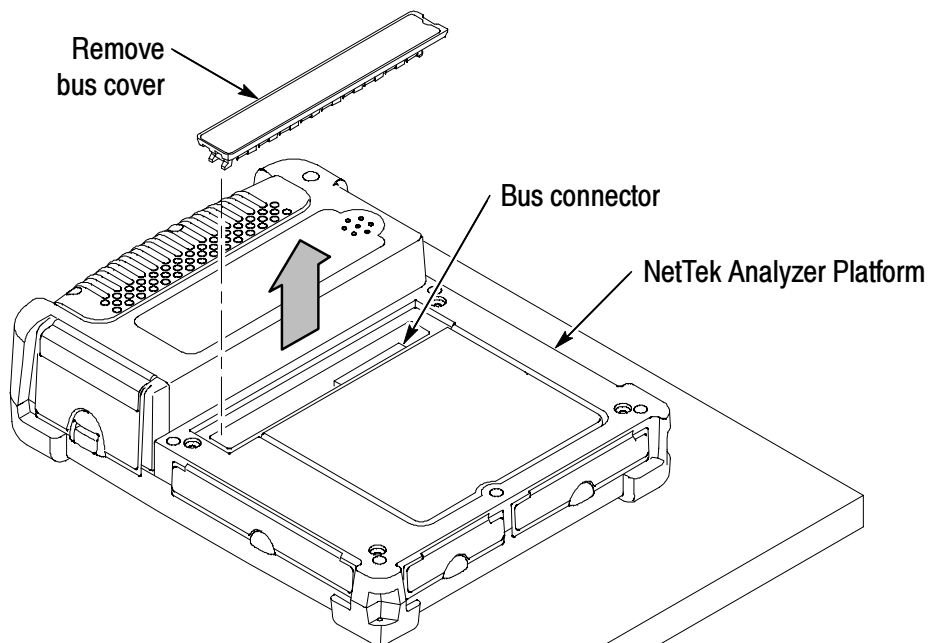
If you purchased the YBA250 as a separate item, you must install the module on a NetTek Analyzer platform before you can take measurements. Refer to Figures 1-5 and 1-6 to install or remove the YBA250 module.



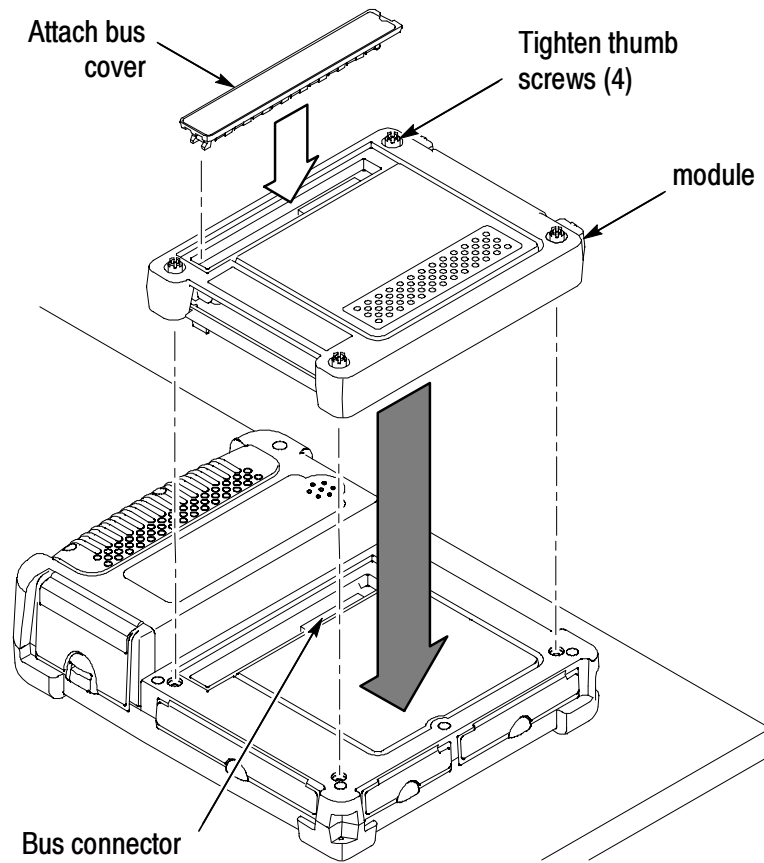
---

**CAUTION.** *To prevent damage to the NetTek Analyzer Platform or YBA250 module, you must power down the NetTek Analyzer Platform and remove all cables or connectors before installing a YBA250 module.*

---



**Figure 1-5: Removing the bus cover**



**Figure 1-6: Attaching the YBA250 module**

---

**NOTE.** Tighten the screws by pressing in slightly on them and turning them in a clockwise direction. Use the coin slot in the top of the thumb screw if you require additional torque. Tighten all screws evenly, but do not overtighten. To recess the thumb screw heads, push and turn each screw head 1/4 turn in a clockwise direction.

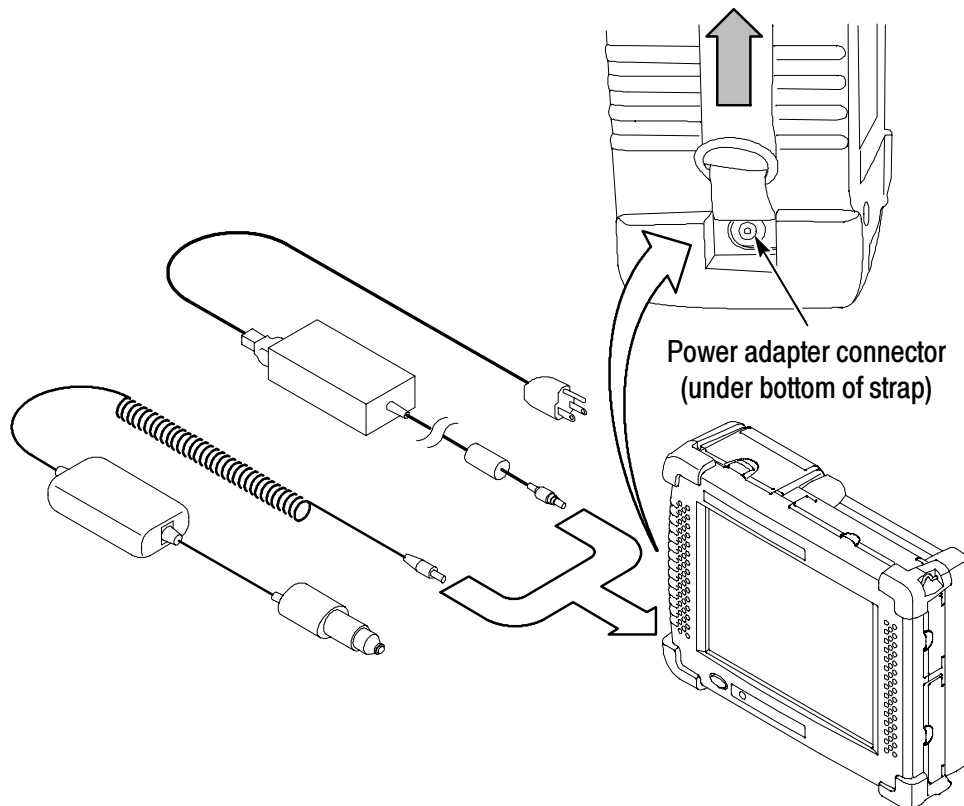
To install additional modules (up to three), remove the bus cover from the installed module and install the additional module as shown in the above figures.

To maintain the module or instrument seal integrity, reinstall the bus cover onto the outermost module, or onto the NetTek Analyzer if removing a module.

---

## Connecting External Power Supplies

To power the NetTek Analyzer Platform from AC mains or DC vehicle voltage, or recharge installed batteries, connect the Desktop Power Supply or the In-Vehicle Adapter to the NetTek Analyzer Platform as shown in Figure 1-7. The Desktop Power Supply operates from 100 VAC to 240 VAC mains.



**Figure 1-7: External power supplies**

## Batteries

### Installing or Removing a Battery

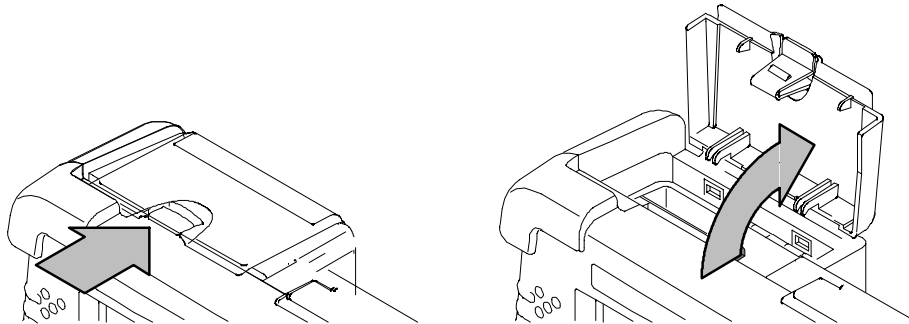
The NetTek Analyzer Platform comes standard with a single battery, which is not installed when the instrument is shipped. Refer to Figures 1-8 through 1-10 for battery installation or removal steps.

---

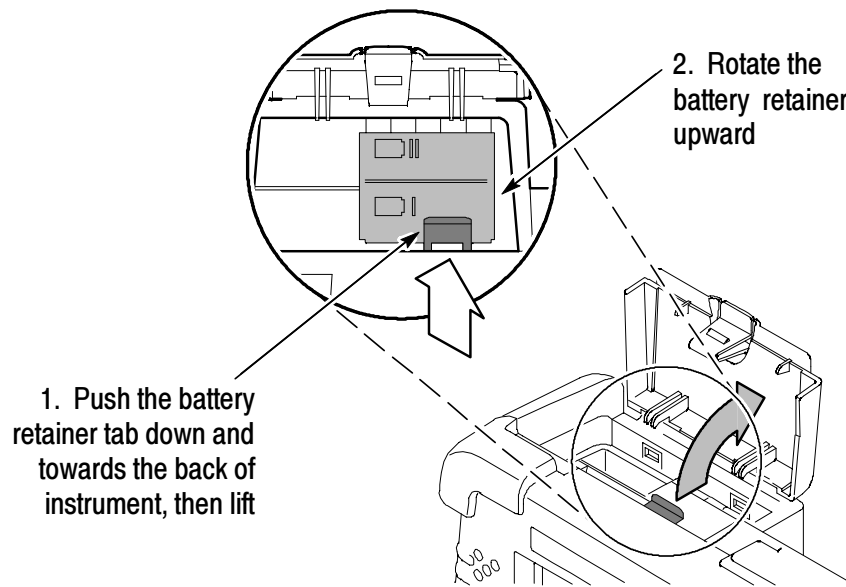
**NOTE.** *Disconnect power supply cables from the NetTek Analyzer Platform before installing or removing batteries.*

*New batteries, or batteries that have not been used for an extended period, must be charged before using them to power the instrument. Refer to Charging a Battery on page 1-9 for more information.*

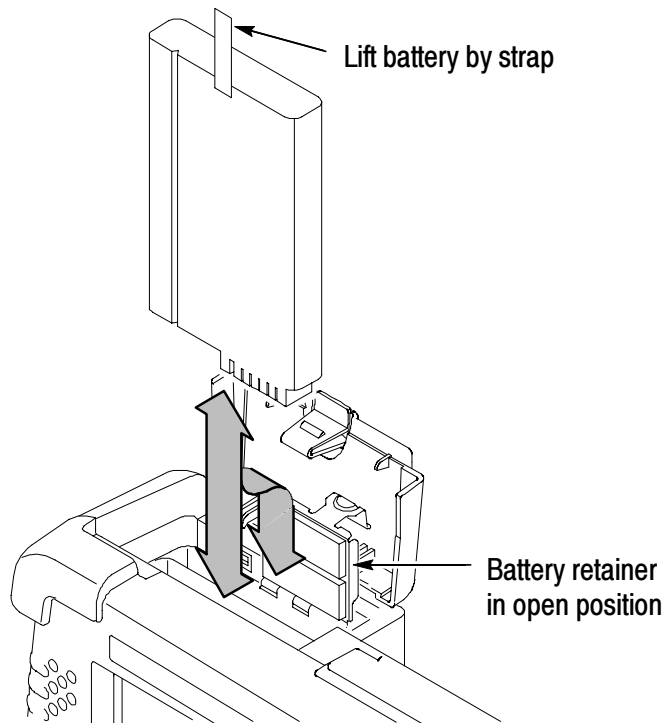
---



**Figure 1-8: Opening the battery compartment**



**Figure 1-9: Opening the battery retainer**



**Figure 1-10: Installing/removing a battery**



---

**NOTE.** *The battery electrical contacts, on the bottom of the battery, must face in the direction shown in Figure 1-10.*

*Close and latch the battery retainer and battery compartment door after installing or removing batteries.*

---

You can add a second battery to increase the operating time. Replace a battery with the specified type only. To purchase a battery from Tektronix, please contact your Tektronix Service Center for the correct part number.

### **Charging a Battery**

To charge batteries installed in the NetTek Analyzer Platform, connect the instrument to an external power supply (see Figure 1-7 on page 1-6) and let the battery or batteries recharge in the instrument. Table 1-1 lists the approximate charge times for fully-discharged batteries. You can also charge batteries in the optional external battery charger.

**Table 1-1: Approximate battery charge times**

<b>Number of batteries in instrument</b>	<b>Instrument powered on</b>	<b>Instrument powered off</b>
1	8 hours	3 hours
2	16 hours	6 hours

---

**NOTE.** *To achieve optimum performance from a new battery, fully charge the battery. Then fully discharge the battery by leaving the YBA250 running (see **Start > Help > Settings > Power Management** for information on disabling the power saver function), then fully charge the battery again.*

---

Batteries are partially charged and calibrated at the factory. A calibrated battery allows the NetTek Analyzer Platform to more accurately estimate how much longer the YBA250 can operate before the instrument automatically powers off. The YBA250 always warns you before it powers off, so that you can save important test results or settings.

To verify the status of your batteries at any time:

1. Select **Start > Settings > Control Panel**.
2. Double-tap the **Power Management** icon. The Batteries tab lists the status of each battery.

If the battery charge is low, connect the NetTek Analyzer Platform to an external power source and let the battery or batteries recharge in the instrument for eight hours. For more information, select **Start > Help > Settings > Power Management > Charging Batteries**.

### **Maximizing Battery Operating Time**

For tips on how to maximize battery operating time, select **Start > Help > Settings > Power Management > Optimizing Battery Life**.

### **Transporting Lithium-Ion Batteries**

Regulations regarding transportation of lithium-ion batteries on passenger aircraft may subject this product to special handling restrictions. Consult your air carrier for applicability and determination of any special lithium-ion battery transportation requirements.

Each NetTek Analyzer Platform lithium-ion battery pack contains less than 8 grams of lithium, with individual cells each containing less than 1.5 grams of lithium, as measured by International Civil Aviation Organization (ICAO) standards.

## Powering On the Instrument

To power on the NetTek Analyzer Platform, press the large blue oval front-panel switch in the lower-left corner. The green status indicator to the right of the switch lights and the system begins its power-on process. The touch-screen display and human interface are described in the *Operating Basics* section.

### How the Software Loads

When you press the power switch on the front panel, the NetTek Analyzer Platform powers on and runs its startup diagnostics (if enabled). Once the NetTek Analyzer Platform has completed its power-on sequence, the YBA250 software begins to load.

If there is enough flash memory available, the software loads into flash memory. If there is not enough flash memory available, then the YBA250 software loads into volatile memory (this happens only with user-installed modules; if your YBA250 was purchased already installed on a NetTek Analyzer Platform the software was loaded into flash memory at the factory).

Loading the software into flash memory reduces the YBA250 application power-on startup time. If the software is not loaded in flash memory, the software must be loaded into the NetTek Analyzer Platform each time the instrument is powered on, resulting in a longer start up time. Note that the software load process is automatic; there are no user decisions required or settings available that affect the software load process.

## Calibrating the Touch-Screen Display

For the touch-screen display to respond correctly to your taps, you must set the stylus centering and double-tap speed.

### Setting the stylus tap rate

1. Select **Start > Settings > Control Panel**.
2. Open (double-tap) the Stylus icon.
3. In the **Double-Tap** tab, double-tap the checkerboard grid at a comfortable speed with your stylus or finger to set the tap rate.

4. Double-tap the checkerboard grid to verify your settings.

### **Setting the stylus centering**

1. Select **Start > Settings > Control Panel**.
2. Open the Stylus icon.
3. In the **Calibration** tab, select **Recalibrate**.
4. Follow the on-screen instructions to set the location and amount of pressure needed for the touch-screen to respond to your taps. Apply pressure to the touch-screen for approximately 5 seconds at each position, until the target moves.
5. Select **OK** to close the dialog box and save your settings.

## **Powering Off the Instrument**

The NetTek Analyzer Platform has separate, but related, standby and power off functions.

### **Suspend Mode**

Use Suspend mode to place the NetTek Analyzer Platform in a suspended (standby or sleep) state. This is the typical power down mode that allows the YBA250 software to remain in volatile memory. If the NetTek Analyzer Platform remains in Suspend mode for an extended time (approximately two hours), it automatically enters Shutdown mode.

To suspend analyzer operation, choose one of the following methods:

- Press the front-panel power switch.
- Select **Start > Programs > Shutdown**. In the Shut Down dialog box, select **Suspend**.

To cancel Suspend mode and wake up the NetTek Analyzer Platform, press the front-panel power switch. The instrument returns to the state that existed before suspend mode was invoked.

### **Shutdown Mode**

To completely power down the NetTek Analyzer Platform, do the following:

1. Select **Start > Programs > Shutdown**.
2. In the Shut Down dialog box, select **Shutdown**.

A shutdown clears volatile memory, including the YBA250 software if it is loaded in volatile memory, user setups, and measurement data not saved to nonvolatile memory. For information on how to save these items to nonvolatile memory:

1. Select **Start > Help**.
2. In the Help window select **Tektronix Basics**.
3. Select **Store Data in Nonvolatile Memory**.

The next time you press the front-panel power switch, the NetTek Analyzer Platform cycles through the complete power up process, taking about 30 seconds to completely power up.

### **Restart (Software Reset)**

If the NetTek Analyzer Platform or YBA250 application stops responding correctly, try performing a restart to clear the problem.

To restart the YBA250, do the following:

1. Select **Start > Programs > Shutdown**.
2. In the Shut Down dialog box, select **Restart**.

The display blanks for approximately five seconds. The YBA250 software reloads and restarts. A restart does not empty volatile memory.

### Front-Panel Power Switch

Depending on the current state of the NetTek Analyzer Platform, pressing the front-panel power switch performs one of the following functions:

- If the NetTek Analyzer Platform is shut down: powers on the instrument.
- If the NetTek Analyzer Platform is operating: initiates Suspend mode.
- If the NetTek Analyzer Platform is in Suspend mode: cancels Suspend mode and activates the YBA250.
- If the analyzer is in PowerSaver mode (touch-screen display off): activates the display.

## Preventing Personal Injury from the Effects of Lightning



---

**WARNING.** *To prevent personal injury from the effects of lightning, exercise the following precautions when using this product:*

---

### Before connecting this product to any source

- Check your local weather forecast for the possibility of thunderstorms or lightning.
- If weather conditions could allow thunderstorms or lightning to develop, be sure to visually check the sky and weather conditions in your area frequently.
- If you can hear thunder or if you see lightning, do not connect this product to any source which may be exposed to the effects of lightning.

- Use your own good judgement and common sense. You must protect yourself from the effects of lightning.
- You must assume that hazardous voltages will be present on exposed surfaces of this product if it is connected to a source exposed to lightning. The insulation of this product will not protect you from these hazardous voltages.

**Do not connect this product to any source which might be subject to the effects of lightning**

If thunderstorms or lightning are in your vicinity:

- When weather conditions that could lead to lightning activity exist in your area, *you could be at risk of a lightning strike* before the cloud is close enough for you to hear thunder or see lightning.
- When lightning strikes a structure or facility, current travels through the rebar, concrete, pipes, cables, vent stacks, and electrical system.
- Lightning can induce electric and magnetic fields into structures and portions of wiring. The length of a conductor affected by the magnetic field of a lightning strike may exceed two miles.

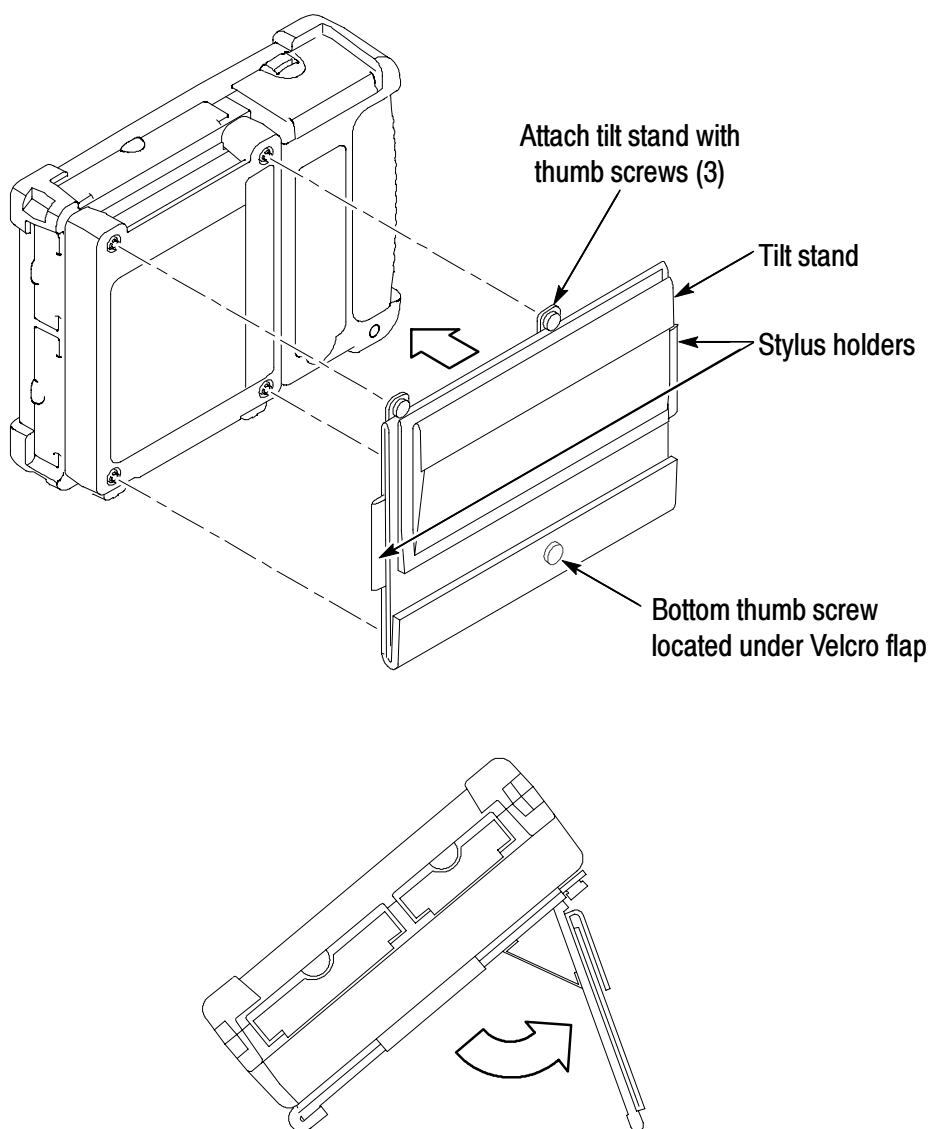
**Be alert and aware of the effects of lightning**

- When lightning strikes a conductor, which in turn introduces the current into an area some distance from the ground strike point, *equipment can be damaged and personnel injured* if they become an indirect path in the completion of the ground circuit.
- Conductors such as the braided shields of cables or unshielded wires will have significant transient currents flowing in them in regions exposed to the electric field effect of lightning.
- Induced voltages may cause breakdown of insulation in wiring at connectors and in electrical components or breakdown of air.

## Attaching Accessories

### Setting Up the Tilt Stand

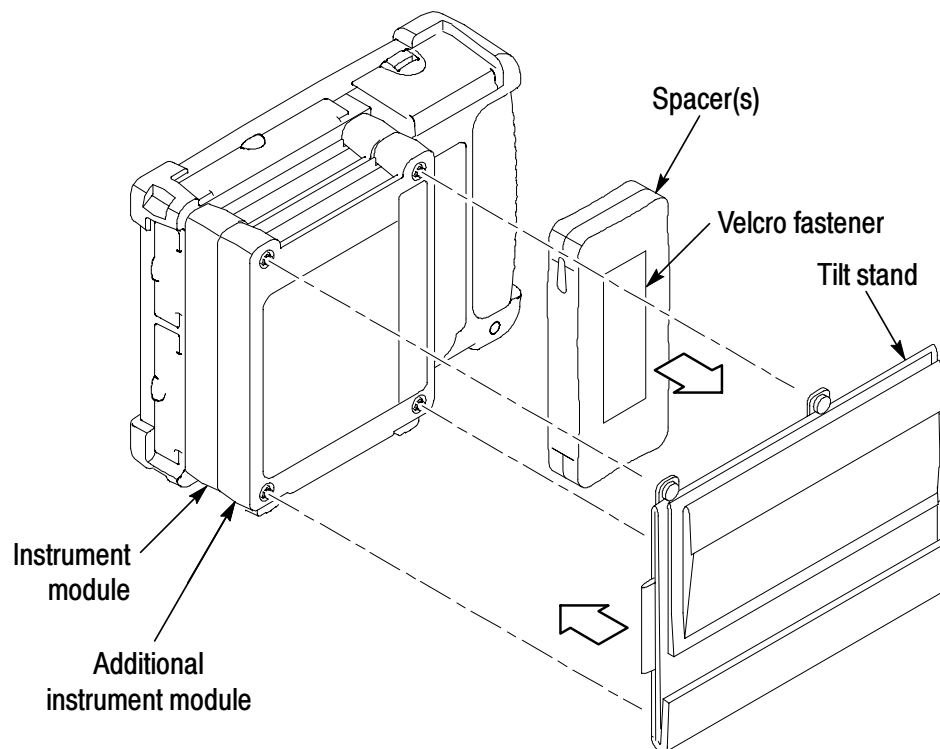
For floor or desktop use, attach the tilt stand to the NetTek Analyzer Platform and fold into place. See Figure 1-11.



**Figure 1-11: NetTek Analyzer Platform tilt stand**



To install the tilt stand with two or more instrument modules attached, use the provided storage pack spacers as shown in Figure 1-12.



**Figure 1-12: Installing the tilt stand on multiple instrument modules**

### Installing the Shoulder Strap and Strand Hook

Use the shoulder strap to carry the NetTek Analyzer Platform to the job site. Install the strap on the instrument as shown in Figure 1-13. You can also install the strap on the soft case.

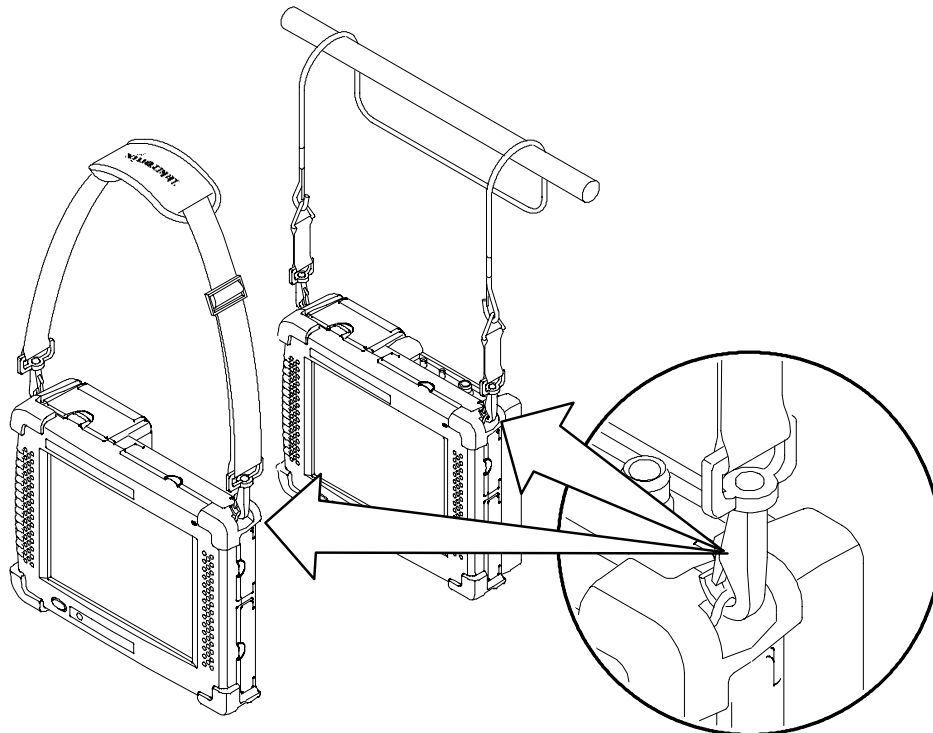
Use the Strand hook to hang the instrument from a wire strand, ladder, or other support. Install the strand hook as shown in Figure 1-13.



---

**CAUTION.** *The NetTek Analyzer Platform can weigh in excess of 12 kg (25 lbs), depending on the number of batteries and instrument modules installed. Use caution when hanging the instrument from any support.*

---



**Figure 1-13: NetTek Analyzer Platform shoulder strap and strand hook**



# **Operating Basics**

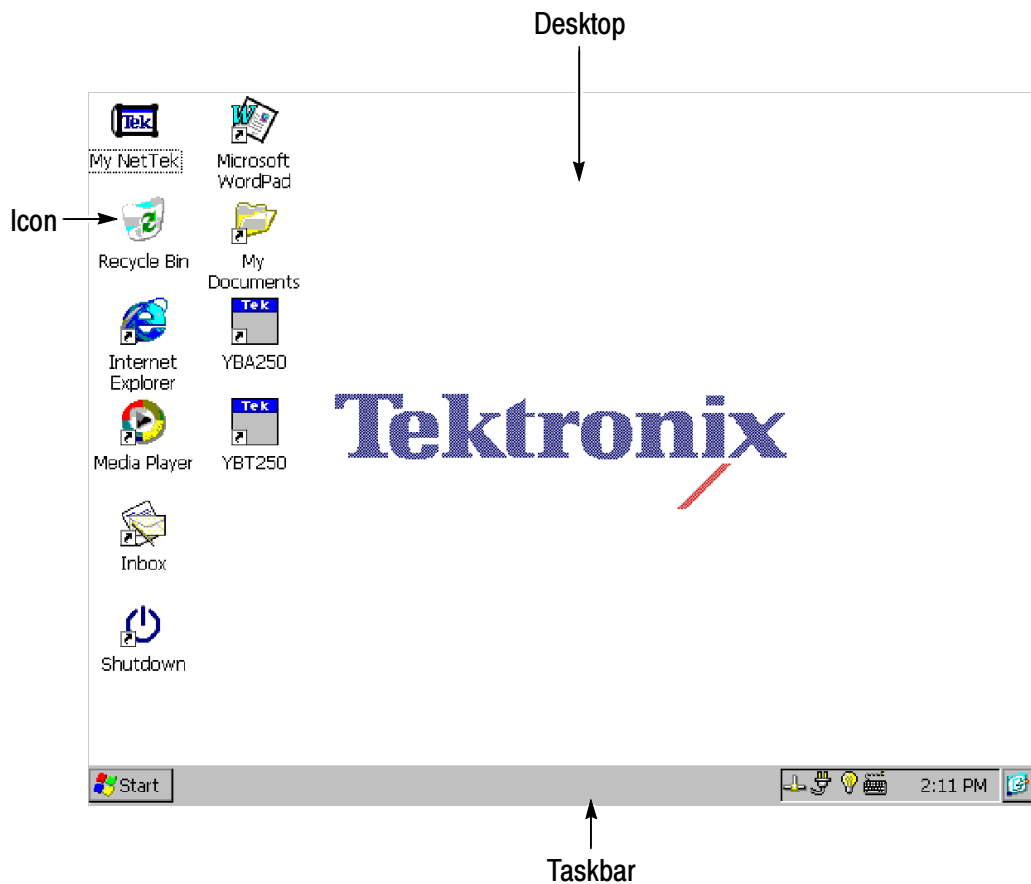


# Operating Basics

This section explains the essential things you need to know to before operating the YBA250 Antenna and Transmission Line Analyzer.

## Navigating the Desktop

The NetTek Analyzer Platform desktop is your primary workspace. Use the desktop to configure hardware and software, adjust settings, establish communications, and access built-in applications.

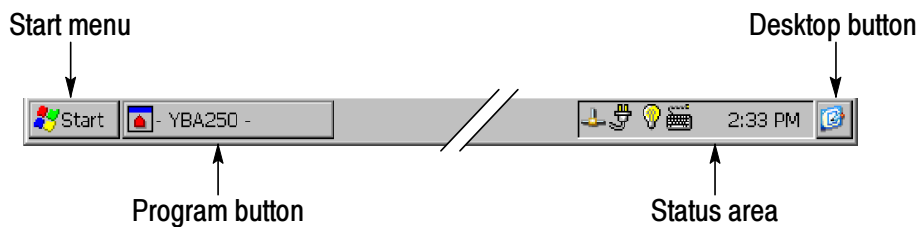


### Icons

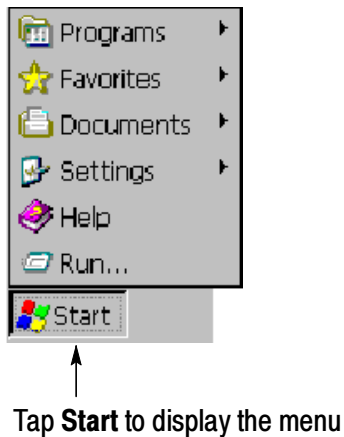
Double-tap desktop icons to open folders or to start programs.

### Taskbar

The Taskbar contains the Start menu, buttons to identify the programs you are running, a status area, and a desktop icon.



**Start Menu.** Use the Start menu to load and run other instrument modules and other programs, access settings, open documents, and obtain help. Select (tap) **Start** to open the menu; then select the entry you want.








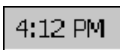

**Program Buttons.** To hide a program that is running, tap its taskbar button. To restore the program, tap the button again.

**Status Area.** Icons and buttons appearing in this area indicate status, activate features, or open settings windows. Double-tap the icons for further information.

Table 2-1 describes the functions of some common status icons. For a complete list and explanation of all status area icons, refer to the NetTek Analyzer Platform online help:

1. Select **Start > Help**.
2. In the Help window select **Windows CE Basics**
3. Select **Understanding Taskbar Icons**.


**Table 2-1: Status area icons**

Tap this icon	Action	Details
	Double-tap to open the Power Management utility.	The analyzer is operating on external AC power.
	Double-tap to open the Power Management utility.	The analyzer is charging batteries.
	Double-tap to open the Power Management utility.	The analyzer is operating on battery power. Also indicates charge level.
	Double-tap to open the Backlight utility.	Adjust the backlight brightness.
	Single-tap to open the Input Panel soft keyboard.	Single-tap to close the keyboard.
	Double-tap to open the Date/Time utility.	Set the date and time.
	Single-tap to minimize all windows and display the desktop.	Tap again to restore all windows.

## Getting Help

To open the Help window and obtain general information on YBA250 topics, select **Help** from the Start menu. Select **YBA250** to get help on the YBA250.










There are three ways to display Help when you are running the YBA250 software:

- Tap the  icon in the upper-right corner of the YBA250 display. This displays the top level of the YBA250 help.
- Tap underlined text on the screen. This displays the Help topic for the item selected.
- Display Help from some dialog boxes by selecting the **Help** button in the bottom-right corner of the dialog box.

### The Help Window

Table 2-2 explains how to use the Help window buttons.

**Table 2-2: Help window buttons**

Tap this button	To
 All Topics	Display the main table of contents.
 Back	Return to the previous help screen.
 Contents	Display the current program or local table of contents.
	Display full-screen help text.
	Display the help text in its own window. Drag the Help window title bar to move the window.
	Minimize the Help window. To restore the window, tap the Help button in the taskbar.
	Close the Help window and quit help.
	Display information farther up the window.
	Display information farther down the window.



## Starting the YBA250 Software

If you purchased your YBA250 installed on NetTek Analyzer Platform, it comes from the factory set to automatically start the YBA250 software when the NetTek Analyzer Platform is powered up. If you added your YBA250 module to a NetTek Analyzer Platform you already own, you will need to start the YBA250 software or set the software to load at startup.

To start the YBA250 software, double-tap the YBA250 icon on the desktop or select **Start > Programs > NetTek > YBA250**. Figure 2-1 shows a typical YBA250 application display.

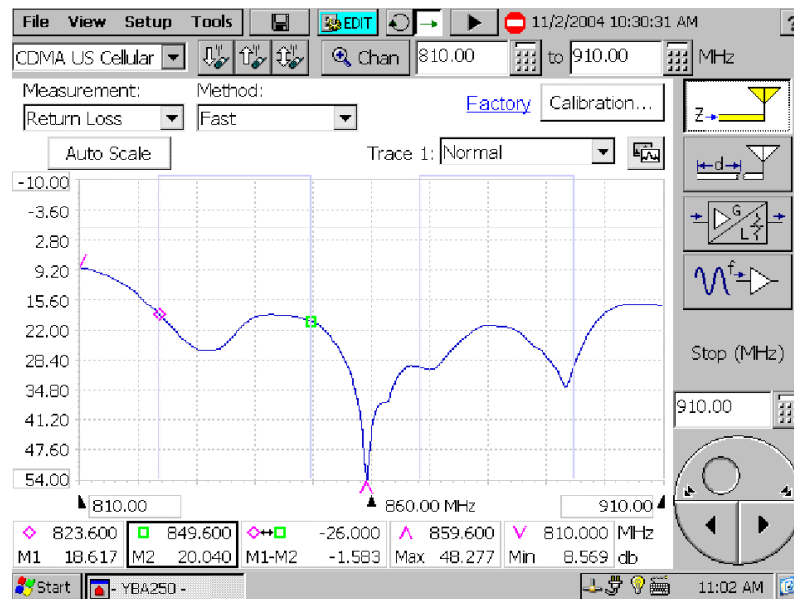


Figure 2-1: The YBA250 display

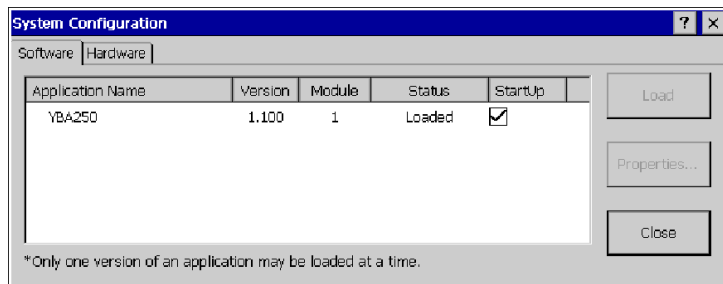
## Setting the YBA250 Software to Load at Startup

If you purchased your YBA250 as a module to use on an existing NetTek Analyzer Platform, you may want to set the YBA250 to load at startup.

To set the YBA250 as the startup application:

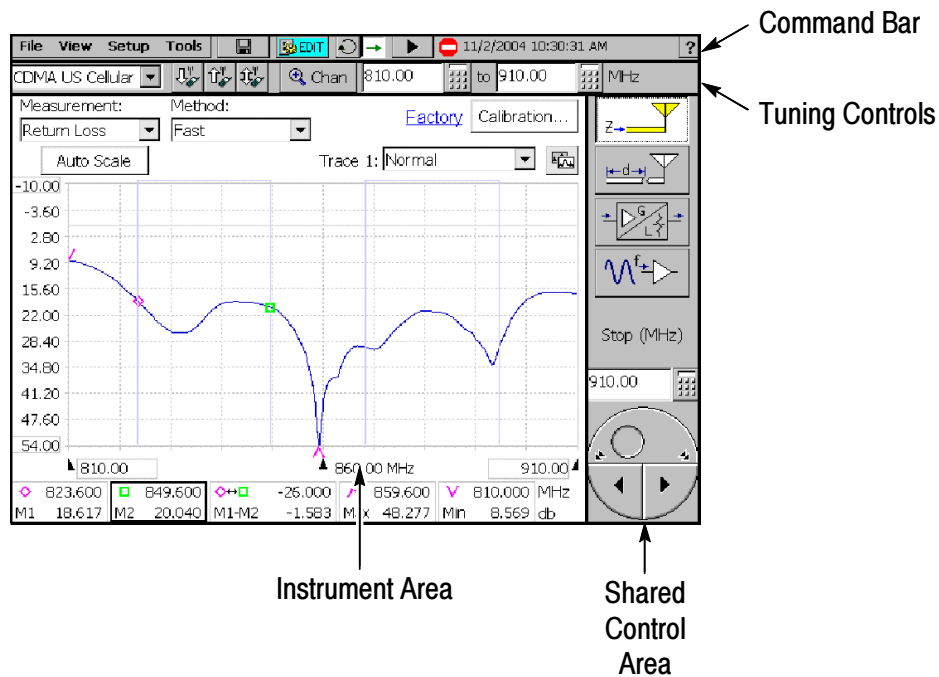
1. Select **Start > Programs > Tektronix Utilities > System Configuration**.
2. On the Software tab, select the StartUp checkbox for the YBA250. See Figure 2-2.
3. Close the System Configuration window.

The next time the NetTek Analyzer Platform is powered on, the YBA250 software will start up automatically.



**Figure 2-2: Setting the StartUp Application**

## YBA250 User Interface Elements



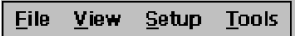










**Figure 2-3: YBA250 user interface elements**

- **Command Bar:** This area contains the menu bar and some instrument control buttons. This area is always visible.
- **Tuning Controls Area:** This area contains the controls used to specify the signal standard and measurement frequency. This area is always visible.
- **Shared Control Area:** This is where the instrument function buttons appear and the input box appears. This area is always visible.
- **Instrument Area:** This is where the waveforms are displayed and measurement results appear. The appearance of this area changes depending on the instrument function.

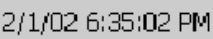

### Command Bar Area

Table 2-3 describes the elements of the Command Bar Area of the display.

**Table 2-3: Command bar area buttons and icons**

Button/Icon	Function
	These are the application menus
	Save button. Saves latest measurement results to a file.
	Edit button. Displays the Setup window, which enables you to edit the YBA250 setup.
	Open button. Displays the Open dialog box, which enables you to select a saved YBA250 setup to load. Replaces Edit button when Hide Setup Controls is selected.
	Continuous measurement button. Sets the YBA250 to take continuous measurements.
	Single measurement button. Sets the YBA250 to take a single measurement.
	Pause button. Pauses trace acquisition (stops measurements).
	Restart/Play button. Starts/Restarts trace acquisition.
	Acquisition active bar. Shows that the YBA250 is acquiring measurements. The number of vertical bars displayed cycles to indicate measurements are in progress.
	Recalled data icon. Shown when displaying recalled data.
	Stop icon. Shown when the measurements are paused.

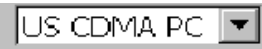



**Table 2-3: Command bar area buttons and icons (Cont.)**

Button/Icon	Function
	Timestamp. Shows the time and date the displayed results were acquired (not present on live displays).
	Displays the YBA250 Online Help.



**Tuning Control Area**

Table 2-4 describes the elements of the Tuning Control Area of the display.

**Table 2-4: Tuning control area buttons and icons**

Button	Function
	Standards list. This drop-down list selects the signal standard and channel table.
	Forward Link button. Changes the start and stop frequency settings to the forward link (downlink) frequency for the selected channel.
	Reverse Link button. Changes the start and stop frequency settings to the reverse link (uplink) frequency for the selected channel.
	Both button. Changes the start and stop frequency settings to cover both the forward and reverse link frequencies for the selected channel.

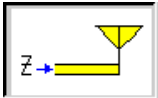
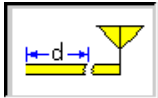
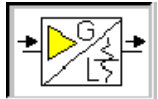
**Table 2-4: Tuning control area buttons and icons (Cont.)**

Button	Function
	Channel button. Selects the channel number to measure. The frequency is set to the appropriate value for the selected channel and standard.
	Frequency start/stop fields. Sets the start and stop frequencies. Tap the keypad button to use the numeric keypad; tap the box to use the knob.

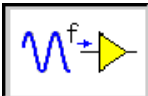
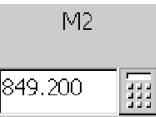

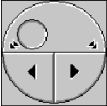
**Shared Control Area**

Table 2-5 describes the elements of the Shared Control Area of the display.

**Table 2-5: Shared control area buttons and icons**

Button	Function
	Impedance button. Displays the Frequency window for measuring return loss, VSWR and cable loss versus frequency (one-port measurements).
	DTF button. Displays the Distance to Fault window for measuring the distance to a fault (one-port measurements).
	Insertion Gain/Loss button. Displays the Insertion Gain/Loss window for measuring insertion gain or loss (in dB) of active devices, such as filters, duplexers, splitters, combiners, and cable (two-port measurements). Requires that both a YBA250 and YBT250 module be installed on the NetTek Analyzer.


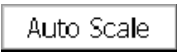



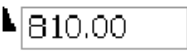
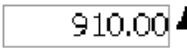
**Table 2-5: Shared control area buttons and icons (Cont.)**

Button	Function
	<p>Carrier Wave button. Displays the CW Mode window for outputting a CW signal.</p>
	<p>This area shows the control assigned to the knob and the value of that control.</p>
	<p>Keypad button. Enter numbers using an on-screen numeric keypad.</p> <p>To use the keypad, tap the control or field whose value is to be changed: this assigns the field to the numeric keypad. Then tap the numeric keypad button above the control knob. Type the new value, including units when present. Tap <b>OK</b>, when present, to accept the new value.</p>
	<p>Knob icon. The Knob icon lets you change the value of the assigned control or field.</p> <p>Tap the left/right arrows on the bottom half of the control knob to make small changes.</p> <p>Tap to the left or right of the small circle (on the top half) to make larger changes.</p> <p>Touch a finger inside the “circle” and drag it until the control is set to the desired value.</p>

### Instrument Area

Icons and buttons in the Instrument Area of the display change depending on the selected function. Table 2-6 describes the buttons and icons that appear in the instrument area. For descriptions of marker buttons and icons, see page 3-45.

**Table 2-6: Instrument area buttons and icons**

Button	Function
Measurement: 	Measurement list. Lists the type of measurements available in the current window.
	Auto Scale button. Automatically adjusts the vertical scale to achieve the best display.
<a href="#">User</a>	Calibration/Normalization status. Shows the current Calibration or Normalization status.
	Calibration button. Displays the Calibration dialog where you can create specify the calibration set to be used for one-port measurements. Available when Impedence or Distance measurement windows are selected.
	Normalization button. Displays the normalization dialog where you can create or load the normalization set to be used for two-port measurements. Available when the Insertion Gain/Loss measurement window is selected.
	Trace order button. Rotates the order of the traces in the display (and displays Trace 2 if it is not already displayed).
	Graph start field. Indicates and changes the start frequency or distance of the graph.
	Graph stop field. Indicates and changes the stop frequency or distance of the graph.



## YBA250 Menus

The YBA250 menu bar has four menus. These menus are File, View, Setup, and Tools. Some menu commands have keyboard shortcuts for use when an optional keyboard is attached to the NetTek Analyzer Platform, but not all menu commands have keyboard shortcuts.

Tables 2-7 through 2-10 describe the YBA250 menus.

**Table 2-7: The File menu**

Menu item	Control key	Description
<u>O</u> pen	Ctrl + O	Displays Open Results dialog.
<u>S</u> ave Results	Ctrl + S	Saves measurement results to a file. The file is automatically named and stored in \BuiltIn-Disk\YBA250\AppData\Results.
Save Results <u>A</u> s...	---	Saves measurement results to a file, displays Save As dialog so you can name the file and specify where it is saved.
Compare Saved...	---	Displays two saved results for visual comparison.
<u>E</u> xport Results As...	---	Saves measurement results in a file format that can be used by word processing or spreadsheet applications.
Export <u>S</u> creen	---	Stores an image of the display that can be used by word processing or image editing applications. The file is automatically named and stored in \BuiltInDisk\YBA250\AppData\Results.

**Table 2-7: The File menu (Cont.)**

<b>Menu item</b>	<b>Control key</b>	<b>Description</b>
Export Screen As...	---	Stores an image of the display that can be used by word processing or image editing applications. Displays Save As dialog so you can name the file and specify where it is saved.
Print	Ctrl + P	Prints the displayed window's data.
Results Properties	---	Displays a dialog that shows information saved with a results file.
Exit	---	Quits the YBA250 program.

**Table 2-8: The View menu**

<b>Menu item</b>	<b>Control key</b>	<b>Description</b>
Trace 2	---	Displays/Hides second trace.
Rotate Trace Order	---	Changes the order of traces in the graph (front versus back).
Define Trace 2	---	Displays the Frequency, Insertion, or Distance tab of the Setup window (depending on the current window), enabling you to specify the source of Trace 2.
Smoothing	---	Smooths the trace between data points.
Mask	---	Enables Mask Testing.
Define Mask	---	Displays the Masks tab of the Setup window, enabling you to specify the mask file to use for mask testing and any action to perform on mask failure.

**Table 2-8: The View menu (Cont.)**

<b>Menu item</b>	<b>Control key</b>	<b>Description</b>
Markers	Ctrl + M	Displays/Hides marker controls and readouts.
Band Edge Cursor	---	Displays/Hides band edge cursors.
Marker 1 (T1/T2/FG)	---	Places M1 marker on Trace 1 (T1), Trace 2 (T2), or the Foreground trace (FG).
Marker 2 (T1/T2/FG)	---	Places M2 marker on Trace 1 (T1), Trace 2 (T2), or the Foreground trace (FG).
Marker Min (T1/T2/FG)	---	Places Min marker on Trace 1 (T1), Trace 2 (T2), or the Foreground trace (FG).
Marker Max (T1/T2/FG)	---	Places Max marker on Trace 1 (T1), Trace 2 (T2), or the Foreground trace (FG).

**Table 2-9: The Setup menu**


<b>Menu item</b>	<b>Control key</b>	<b>Description</b>
Edit..	Ctrl + T	Displays the Setup window.
Open...	---	Displays the Open Setup dialog.
Save...	---	Saves current setup to a file.
<Saved Setup 1-N>		Displays the name of most recently used setup files or files specified in Tools > Options > Settings Menu. Up to 10 files can be displayed.

**Table 2-10: The Tools menu**

<b>Menu item</b>	<b>Control key</b>	<b>Description</b>
Options...	---	Displays the Options window.
Keyboard	Ctrl + K	Displays/Hides the soft keyboard.
Touchscreen Calibration	---	Displays the Windows CE Stylus utility.
Mask Maker...	---	Displays the Mask Maker utility.
Factory Reset	---	Resets all YBA250 settings to original factory values; overwrites existing settings.
Upgrade Software	---	Displays the utility for enabling software options or installing a new version of the YBA250 application.
Technical Support	---	Displays technical support contact information.
Software Info	---	Displays the SW Properties window which lists, among other things, the installed options, and Options key.
Hardware Info	---	Displays the HW Properties window which lists, among other things, serial number, hardware versions and Global ID.

## Entering Text

The Input Panel soft keyboard lets you type characters into text boxes or address fields without using an external keyboard.

To display and use the soft keyboard, tap the  icon in the toolbar status area. Figure 2-4 shows the default keyboard.

Input Panel																
Esc	F1	F2	F3	F4	F5	F6	F7	F8	F9	F10	F11	F12	Home	End	Prop	
`	1	2	3	4	5	6	7	8	9	0	-	=	BS			
Tab	q	w	e	r	t	y	u	i	o	p	[	]	\			
Caps Lock	a	s	d	f	g	h	j	k	l	;	'	return				
Shift	z	x	c	v	b	n	m	,	.	/	up		pgup			
Ctrl	win	Alt						ins	del	lt	dn	rt	pgdn			

**Figure 2-4: The Soft Keyboard**

To set soft keyboard properties, or switch between a large keyboard (default) and a smaller keyboard, select **Start > Settings > Control Panel**. Open the Input Panel icon, and then select **Options**.



# Connecting a Signal

This section explains the importance of using precision cables and connectors, how to connect the YBA250 to an antenna, and how to calibrate the YBA250.

## Use Precision Connectors and Cables

To ensure that your measurements are accurate, always use precision cables and connectors. Quality of materials and construction is what separates a precision connector from a standard connector. A precision connector is manufactured with precisely machined connection surfaces and tight tolerances. Precision female center connectors often have six fingers instead of the four fingers common on less expensive connectors.

Precision cables are specially constructed to have an exact 50-ohm impedance. However, the only real way to tell if a connector is a precision one is to know the VSWR and loss specifications over the frequency range to be measured. While the loss specification is important to accurate measurements, the VSWR of the cable is critical.

### How cables and connectors affect measurements

Reflection measurements are usually made as a comparison of the unknown (device being measured) to a known standard. This standard is assumed to be perfect.

Any non-precision cable can dramatically affect a reflection measurement. The higher the frequency of measurement, the worse the degradation will likely be. There are two distinct types of errors introduced by a cable.

The first error is simply the reflection and loss of the cable itself. This usually causes a device being tested to seem to have a worse VSWR or Return Loss than it really does.

The second type of error is the change in reflection, phase, or loss of the cable as it is flexed or bent. This causes readings to change as the jumper is bent (particularly for measurements of antennas with good VSWR).

Any non-precision connector also affects reflection measurements. The effect non-precision connectors have is to decrease return loss by reflecting part of the signal. As with cables, the higher the frequency of measurement, the worse the degradation will likely be.

## Attaching and Removing Precision Connectors

There is a correct way to attach and remove precision connectors. Precision connectors are exceptionally sensitive to mishandling.



**CAUTION.** *Attaching or removing a precision connector incorrectly will damage the connector. You must attach and remove precision connectors using the proper procedure to avoid damaging the connector.*

---

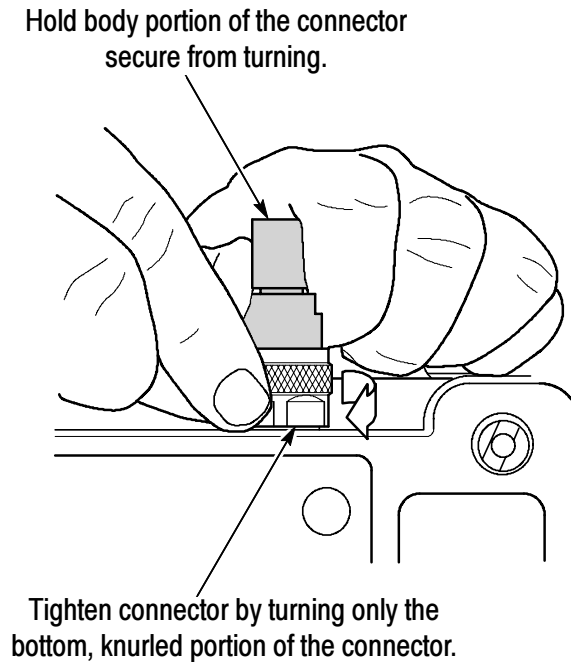
Precision connectors that have been damaged by improper handling will not provide dependable measurements.

### Attaching Precision Connectors

To properly attach a precision connector to the YBA250:

1. Gently push the connector straight onto the Test Port. *DO NOT* turn the body of the connector while pushing it onto the Test Port.
2. To secure the connector, hold the body of the connector still while turning the nut until it is finger-tight. Turn *ONLY* the nut to secure the connector. See Figure 2-5.





**Figure 2-5: How to attach a precision connector**

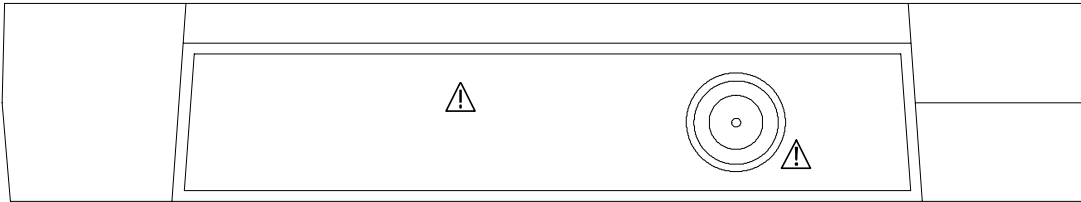
### Removing Precision Connectors

To properly remove a precision connector from the YBA250:

1. Hold the body of the connector still while turning the nut to loosen it. Turn only the nut to remove the connector.
2. Gently pull the connector straight away from the RF input. Do not turn the body of the connector while pulling it off the Test Port.

## Connecting an RF Signal

The YBA250 has a single RF signal input, labeled TEST PORT. The input impedance is 50  $\Omega$ . The input frequency range is 25 MHz to 2500 MHz. Figure 2-6 shows the location of the TEST PORT.



**Figure 2-6: TEST PORT location**

To connect an antenna to the YBA250:



---

**WARNING.** *To prevent personal injury from the effects of lightning, do not connect this product to any source that might be subject to the effects of lightning. Use your own good judgement and common sense. You must protect yourself from the effects of lightning.*

---

1. Following your standard practice, disconnect the antenna to be tested from the transmitter or receiver.
2. Discharge the antenna (short the center conductor to the cable ground shield).
3. Connect one end of a precision cable to the antenna.
4. Connect the other end of the precision cable to the TEST PORT on the YBA250.

# Measurement Overview

YBA250 measurements are divided into two categories; one-port and two-port measurements.

## One-Port Measurements

One-port measurements, also known as reflection measurements, use a single port on the YBA250 module to measure return loss, VSWR, cable loss, and distance to fault (DTF). One-port measurements connect one end of a signal path to the YBA250 module, with the other end of the signal path connected to the device under test (such as an antenna).

One-port insertion loss is best for measuring losses in signal paths that contain passive, low-loss components such as cables and attenuators. The one-port insertion loss measurement is not as accurate as the two-port insertion loss measurement, but does not require access to both ends of a signal path.

## Two-Port Measurements

Two-port measurements, also known as transmission measurements, provide insertion gain and loss measurements such as filter response (loss) versus frequency and tower-mounted amplifier (TMA) gain versus frequency. Both a YBA250 and YBT250 module must be installed on the NetTek Analyzer to perform two-port Insertion Gain/Loss measurements. The YBA250 module injects a signal into the device or system under test, and the YBT250 module receives and measures the resultant signal.

Two-port insertion gain and loss measurements are best for measuring signal paths that contain active, wide-dynamic-range components, such as circulators, amplifiers, and directional couplers. Two-port loss measurements are more accurate than one-port measurements. Two-port measurements connect both ends of a signal path to the YBA250 and YBT250 modules to measure insertion gain and insertion loss.

# Calibration and Normalization

To get the most accurate measurements, calibrate the YBA250 before you begin to make measurements at a site. One-port measurements (return/cable loss, VSWR, and DTF) require a calibration process (described below). Two-port measurements (insertion gain/loss) require a normalization process (starting on page 2-40).

## Calibrating the YBA250

To get the most accurate one-port measurements, calibrate the YBA250 each time before taking measurements at a site.

There are two types of one-port measurement calibration; Factory and User. The Factory calibration is a calibration data set generated during manufacture and saved in non-volatile memory that can be recalled at any time. The Factory calibration provides good measurement accuracy without requiring the use of a calibration kit.

The User calibration is a calibration data set generated using the YBAC1 Calibration Kit (or an equivalent calibration kit) with the instrument, and saved in non-volatile memory that can be recalled at any time. Using a User calibration data set compensates for changes in instrument temperature, power level and component aging, to ensure the most accurate measurements.

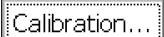
The YBAC1 is a set of three high-precision measurement standards. You connect each of the measurement standards in the kit to the YBA250 Test Port and run a calibration procedure that normalizes measurements to the accuracy of the calibration kit standards.

### When to Calibrate the YBA250

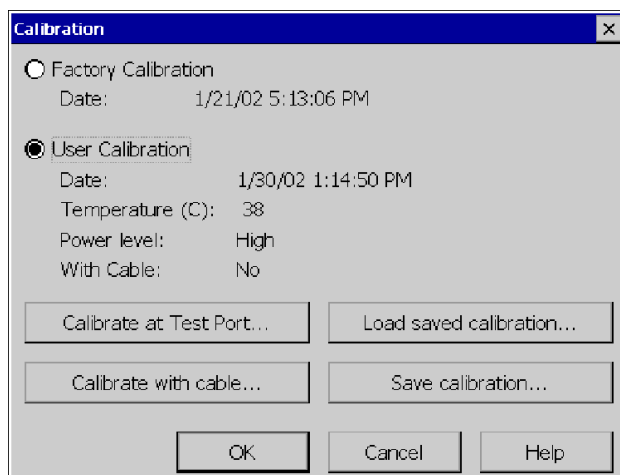
Calibration is most sensitive to changes in temperature. When the YBA250 senses that its internal temperature has changed more than  $\pm 10$  °C ( $\pm 18$  °F) from its temperature at the last calibration, it changes the calibration status to **User Cal?** to inform you that you should perform a calibration to ensure the most accurate measurements. You can choose not to perform the calibration and still make measurements, but the results may not be as accurate as measurements performed with a valid calibration.

A calibration is performed across the entire frequency range of the YBA250, so if you change the measurement frequency range or the start/stop frequencies, you do not need to recalibrate the YBA250. However, if you change the power level setting from that of the current calibration set, you should perform a calibration.

### Elements of the Calibration Window

To access the calibration window, tap the  button.

The Calibration window lets you select which type of calibration to use (Factory or User), create a User calibration, save a User calibration, or load a saved User calibration set. See Figure 2-7.



**Figure 2-7: The Calibration window**

Table 2-11 describes the elements of the Calibration window.

**Table 2-11: Calibration window elements**

<b>Field</b>	<b>Description</b>
Factory Calibration	Select this option button when you want to use the Factory Calibration set.
Date	Date the Factory Calibration was performed.
User Calibration	Select this option button when you want to use a calibration that you have performed.
Date	The date and time the current calibration was performed.
Temperature (C)	The internal temperature of the YBA250 at the time the current calibration was performed.
Power level	The output power setting when the current calibration was performed.
Calibrate at Test Port	Select this button to perform a new calibration when you are not using an intermediate cable to connect to the antenna.
Calibrate with cable	Select this button to perform a new calibration when you are using a cable (less than 10 feet or 3 meters long) to connect to the antenna.
Load saved calibration	Select this button to load a saved calibration set.
Save calibration	Select this button after you have performed a new calibration to save the calibration.

### What is the Current Calibration Status?

The YBA250 displays the current calibration status next to the Calibration button. There are three calibration status labels:

- **Factory:** When this status is displayed, the YBA250 is using the Factory calibration set.
- **User:** When this status is displayed, the YBA250 is using a User calibration set. A User calibration is listed as valid for seven days.
- **User Cal?:** This indicates that the YBA250 is using a User Calibration set but either too much time has elapsed since the last calibration (more than seven days), the internal temperature has changed more than  $\pm 10$  °Celsius ( $\pm 18$  °Fahrenheit), or the power level doesn't match what it was at the last calibration.

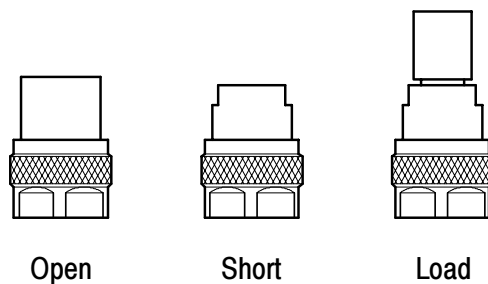
### Performing a User Calibration

To perform a User calibration, you must have a YBAC1 Calibration Kit (or an equivalent calibration kit). The YBAC1 is a set of precision terminations: an Open, a Short, and a Load. The terminations are calibrated and the connectors are precision connectors.

---

**NOTE.** *The accuracy of the YBA250 cannot be guaranteed if you perform a new calibration with terminations that are not part of a YBAC1 Calibration Kit (or an equivalent calibration kit).*

---



**Figure 2-8: Precision terminations from YBAC1 Calibration Kit**



There are two methods of User calibration: Calibrate at Test Port and Calibrate with cable. If you are using a precision cable to connect to the antenna, you can use either method. If you are using a non-precision cable to connect to the antenna, it is important to use the Calibrate with cable method.

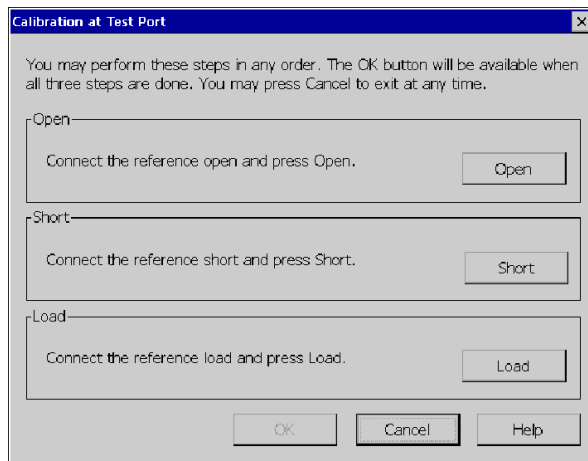
When using the Calibrate at Test Port method, you attach the calibration standards directly to the TEST PORT connector. When using the Calibrate with cable method, you first connect the cable you will use to connect to the antenna to TEST PORT connector of the YBA250, and then you connect the calibration standards to the other end of the cable. In this way, the YBA250 can compensate for the loss in the cable, resulting in a more accurate measurement. Note that the Calibrate with cable method is valid only for cable lengths up to 10 feet (3 meters).

**Calibrate at Test Port.** To perform a calibration at the test port:

1. In the main display, tap the **Calibration...** button .

This displays the **Calibration** window.

2. Tap the **Calibrate at Test Port...** button (). This displays the **Calibration at Test Port** window. See Figure 2-9.

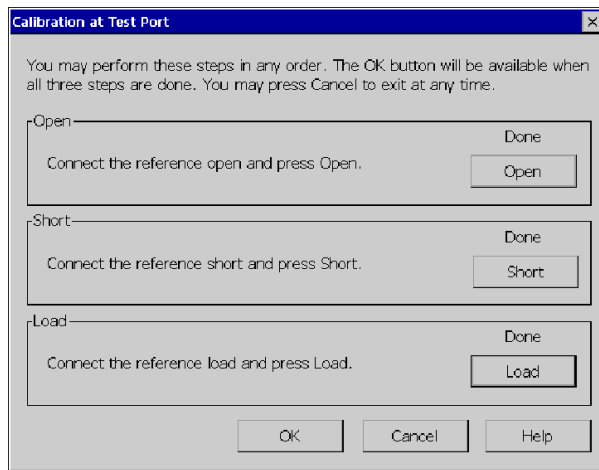


**Figure 2-9: Ready to perform calibration**

3. Carefully attach the OPEN calibration standard to the **TEST PORT** using the procedure described on page 2-20.

You can perform steps 4 through 8 in any order. Note that the OK button is not selectable until all three steps have been completed. If you accidentally tap the wrong button (for example, you tap Open while you have the Short calibration standard connected), just repeat the step. To cancel the calibration, tap **Cancel** at any time.



4. Tap the **Open** button in the Calibration at Test Port window. When the calibration is completed, **Done** appears above the Open button.
5. Carefully replace the OPEN calibration standard with the SHORT calibration standard.
6. Tap the **Short** button in the Calibration at Test Port window. When the calibration is completed, **Done** appears above the Short button.
7. Carefully replace the SHORT calibration standard with the LOAD calibration standard.
8. Tap the **Load** button. When the calibration is completed, **Done** appears above the Load button.
9. Carefully remove the LOAD calibration standard from the TEST PORT.
10. Once calibration has been completed for all three standards, tap the **OK** button. The OK button is not selectable until all three calibration standards have been marked as done. See Figure 2-10.

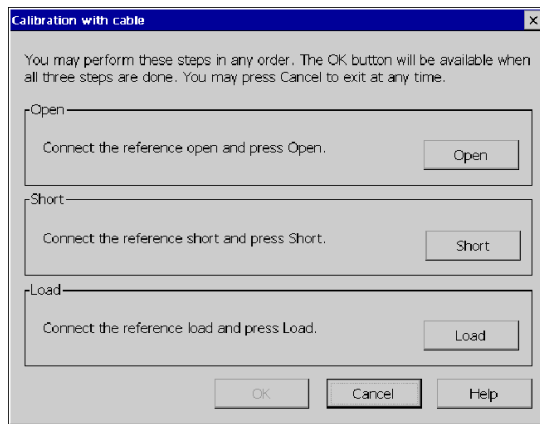


**Figure 2-10: Calibration window after calibration is done**

This loads new calibration settings that remain valid until the temperature of the YBA250 changes by more than  $\pm 10$  °C ( $\pm 18$  °F) or more than seven days have elapsed since the calibration was performed.

**Calibrate with Cable.** To perform a calibration with a cable that is 10 feet (3 meters) or less in length:

1. In the main display, tap the **Calibration...** button . This displays the **Calibration** window.
2. Tap the **Calibrate with cable...** button . This displays the **Calibration with Cable** window. See Figure 2-11.



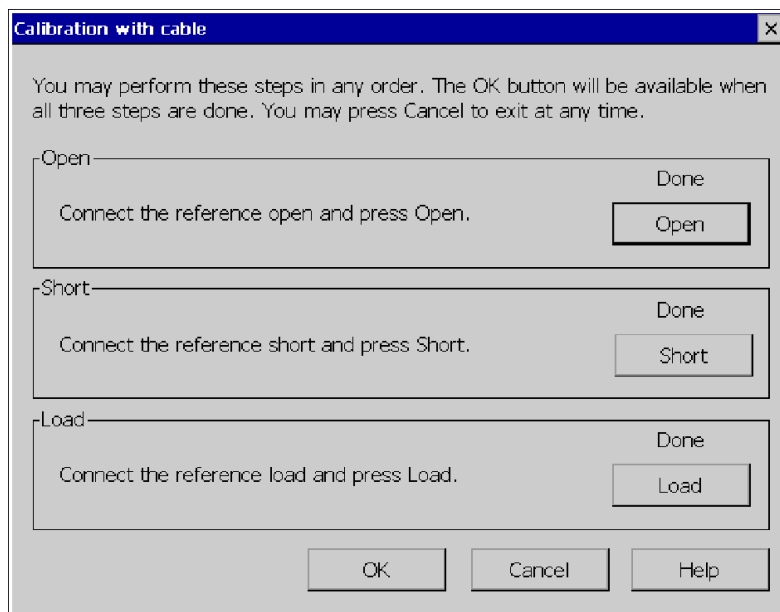
**Figure 2-11: Ready to perform calibration with cable**

3. Carefully attach the cable to the TEST PORT using the procedure on page 2-20. Note that this calibration method is valid only cables up to 10 feet (3 meters) long.

You can perform steps 4 through 8 below in any order. Note that the OK button is not selectable until all three steps have been completed. If you accidentally tap the wrong button (for example, you tap Open while you have the Short calibration standard connected), just repeat the step. To cancel the calibration, tap **Cancel** at any time.

4. Carefully attach the OPEN calibration standard to the end of the cable. You may need an adapter to connect the calibration standard to the end of the cable. If you need an adapter, be certain to use a precision adapter.
5. Tap the **Open** button in the Calibration with cable window. When the calibration is completed, **(Done)** appears above the Open button.
6. Carefully replace the OPEN calibration standard with the SHORT calibration standard.
7. Tap the **Short** button in the Calibration with cable window. When the calibration is completed, **(Done)** appears above the Short button.

8. Carefully replace the SHORT calibration standard with the LOAD calibration standard.
9. Tap the **Load** button. When the calibration is completed, **(Done)** appears above the Load button.
10. Carefully remove the LOAD calibration standard from the cable and remove the cable from the TEST PORT.
11. Once the calibration has been completed for all three standards, tap the **OK** button. The OK button is not selectable until all three calibration standards have been marked as done.  
See Figure 2-12.



**Figure 2-12: Calibration window after calibration is done**

This loads new calibration settings into non-volatile memory that remain valid (while using the cable with which the calibration was performed) until the temperature of the YBA250 changes by more than  $\pm 10$  °Celsius ( $\pm 18$  °Fahrenheit) or more than seven days have elapsed since the calibration was performed.

### **Saving User Calibration Data Sets**

User Calibration data sets can be saved in non-volatile memory so that they can be loaded at another time. One reason to do this is so that you do not have to carry a calibration kit with you in the field.

To save calibration sets for later recall:


1. Perform a new calibration as described starting on page 2-28.
2. Tap the **Save calibration...** button in the Calibration window.
3. Name the calibration set (for example, “Nehalem Mountain” to denote the location where the calibration was performed) and tap **OK**.

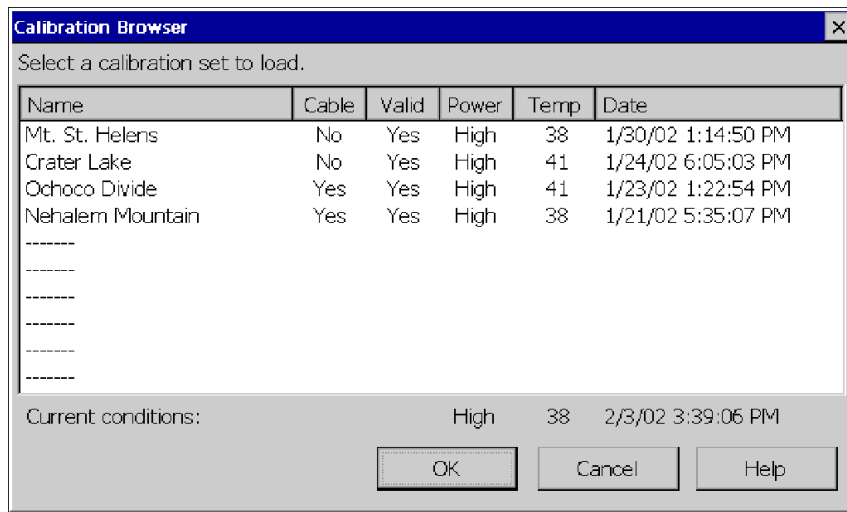
This saves the calibration set in non-volatile memory so that it can be loaded at another time. Calibration data sets are stored within the module, so that if the YBA250 module is moved to another NetTek Analyzer Platform the calibration data set stays with the module.

### **Loading a Saved Calibration Set**

If you are in the field and need to perform a calibration but do not have the YBAC1 Calibration Kit with you, you can load a saved calibration set.

To load a saved calibration set:

1. Tap the **Calibration...** button . This displays the **Calibration window**.
2. To load a saved calibration set, tap the **Load saved calibration...** button. This displays the Calibration Browser window. See Figure 2-13.



**Figure 2-13: Calibration browser window**

There is a line of text that appears below the list of saved calibration sets. The line of text begins with **Current conditions:**. It displays the the power level, temperature of the YBA250, and the date. This information is provided to help you decide which calibration set to load. For details on how to use this information, see *Which Calibration Set Should You Use?* on page 2-37.


3. Select the saved calibration set you want to use and tap **OK**.

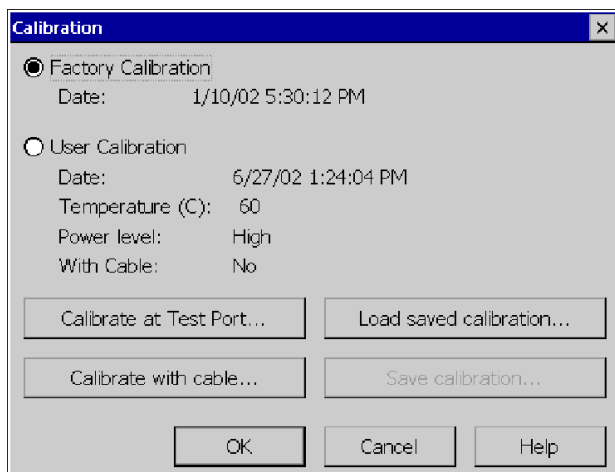
This loads the saved calibration set which will remain valid until the temperature of the YBA250 changes by more than  $\pm 10$  °C ( $\pm 18$  °F) or more than one week has elapsed since the calibration was performed.

### Using the Factory Calibration

A Factory Calibration is a special calibration performed with a set of very high-precision calibration standards at the factory. The Factory Calibration set is saved in non-volatile memory so it can be recalled at any time. The Factory Calibration set cannot be changed.

To load the Factory Calibration set:

1. Tap the **Calibration...** button . This displays the Calibration window.
2. To load the Factory Calibration settings, select the **Factory Calibration** checkbox. See Figure 2-14.



**Figure 2-14: The Calibration window**

3. Tap **OK**.

This loads the calibration set stored at the factory. The Factory Calibration can be used across the entire YBA250 operating temperature range. (For details on accuracy specifications, see *Appendix A, Specifications*.)



### Which Calibration Set Should You Use?

There are three factors to consider when deciding which saved calibration set you should use: temperature, power level, and length of time since the calibration was performed.

1. Temperature (that is, the internal temperature of the module) has the greatest effect on measurement accuracy; therefore, it should be considered the most important factor when selecting among saved calibration sets. Choose the calibration set with the temperature closest to the current temperature.
2. The next factor to consider is the power level. Always try to use a calibration set that was performed at the same power level.
3. The next factor to consider is the time since the calibration was performed. The most recent calibration is the best choice.

### Elements of the Calibration Browser Window

The Calibration Browser window is used to select a saved calibration to load. But, how do you know which calibration set to load? There are several fields of information in the browser window that can help you decide which calibration set to load.

**Table 2-12: Calibration Browser Fields**

Field	Description
Name	The name given to the calibration set when it was saved.
Cable	Either Yes or No. Yes indicates the calibration was performed using <b>Calibrate with cable</b> . No indicates the calibration was performed with <b>Calibrate at Test Port</b> .
Valid	Either Yes or No. If Yes, the temperature at the time of the calibration was run is within $\pm 10$ °C ( $\pm 18$ °F) of the current temperature, less than a week has elapsed since the calibration set was saved and the current power level is that same as that of the calibration set. If No, the temperature when the calibration set was saved is too different from the current temperature, more than one week has elapsed since the calibration set was saved (possibly both), or the current power level is different from the power level setting of the calibration set.

**Table 2-12: Calibration Browser Fields (Cont.)**

<b>Field</b>	<b>Description</b>
Power	Either High or Low. The output power setting when the calibration was performed.
Temp	The internal temperature of the YBA250 at the time the calibration was performed.
Date	The date the calibration was performed.
Current Conditions	<p>A line below the list of saved calibration sets that lists current conditions:</p> <p>Output level: Either High or Low</p> <p>Temperature: Current temperature in degrees Celsius.</p> <p>Date: The current date set on the NetTek Analyzer Platform.</p> <p>Time: The time on the NetTek Analyzer Platform when the Calibration Browser was opened.</p>

**Calibration Guidelines**

- Calibration is most sensitive to changes in temperature. When the YBA250 senses its internal temperature has changed more than  $\pm 10\text{ }^{\circ}\text{C}$  ( $\pm 18\text{ }^{\circ}\text{F}$ ) from its temperature at the last calibration, it changes the calibration status to User Cal? to inform you that you should perform a calibration to ensure the most accurate measurements.

You can choose not to perform the calibration and still make measurements, but the results may not be as accurate as measurements performed with a valid calibration.

- A calibration is performed across the entire frequency range of the YBA250, so if you change the measurement frequency range or the start/stop frequencies, you do not need to recalibrate the YBA250.

- If you change the power level setting from that of the current calibration set, you should perform a calibration. See General Tab for information on changing the power level.
- To achieve the most accurate results, always perform a User calibration before you begin taking measurements at a site. However, if this isn't possible (for example, you don't have a YBAC1 Calibration Kit or an equivalent calibration kit with you), you can load saved user calibration sets or use the Factory Calibration. Factory calibration is always available and provides reasonably accurate results.
- If you have saved calibration sets, load the calibration set that most closely matches the current conditions. Saved calibration sets will provide more accurate results than a Factory calibration set or the User Cal? status.

## Normalizing the YBA250

Normalization generates measurement correction data to compensate for signal source variations, test cable and attenuator losses, and cable/attenuator reflections, for two-port measurements. Normalization data (Default or User) must be loaded before you can perform accurate two-port insertion gain or loss measurements.

There are two types of normalization: Default and User. The Default normalization data set covers the entire YBA250 frequency range (30 MHz to 2500 MHz) and all signal source levels (+3dBm to -60dBm). This provides a general baseline measurement reference across all frequencies and signal levels. Default normalization provides good measurement accuracy across all frequencies any time a User normalization is not available or is not valid.

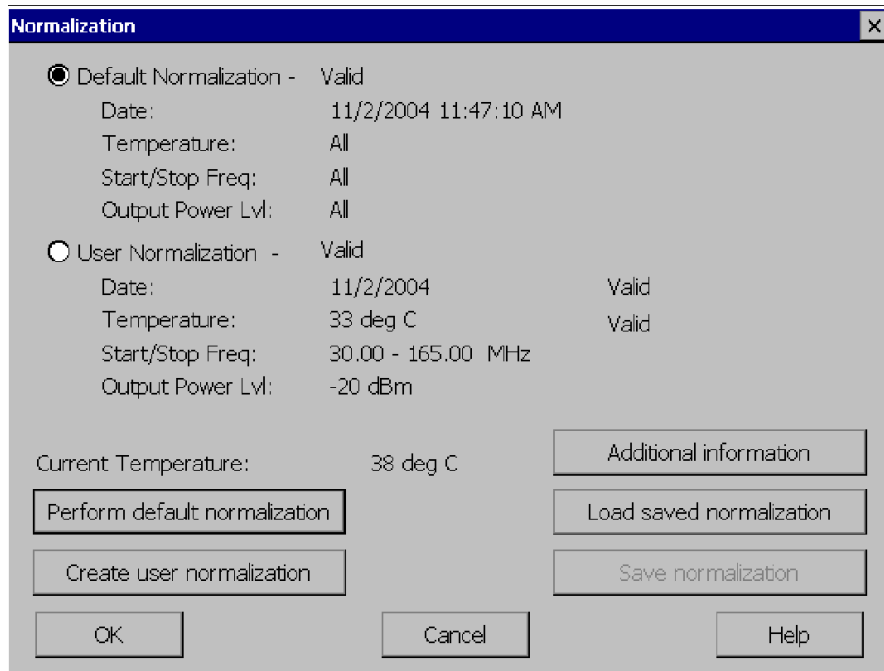
The User normalization data set covers a specified frequency range and output power level, based on the instrument settings when the User normalization data was created. A User normalization provides the most accurate measurements.

Both Default and User normalizations generate correction data using precision cables and attenuators connected between the YBA250 and the YBT250 modules. The normalization data, plus instrument state information (such as date/time and internal module temperature), is saved to non-volatile memory.

### The Normalization Window Elements

The Normalization window is where you select which type of normalization to use (Default or User), create a new Default or User normalization, save normalization data to a file, or load a saved normalization set.

To display the two-port Normalization window, tap the **Normalization...** button while in the Insertion Gain/Loss window. Figure 2-15 shows the Normalization window. Table 2-13 describes the contents of the Normalization window.



**Figure 2- 15: Normalization window**

**Table 2- 13: Normalization window elements**

Field/Button	Description
Default Normalization	Sets the Default normalization set as the current Normalization.
User Normalization	Sets the User normalization set (newly-created or loaded from a saved file) as the current Normalization.
Date	Displays the date the normalization was created.
Temperature (C)	Displays the internal temperature, in degrees Celsius, of the YBA250 at the time the normalization was created.
Start/Stop Freq	Displays the start and stop frequencies of the normalization.
Output Power Lvl	Displays the output power setting of the normalization.
Current Temperature	Displays the highest temperature of the two modules.

**Table 2- 13: Normalization window elements (Cont.)**

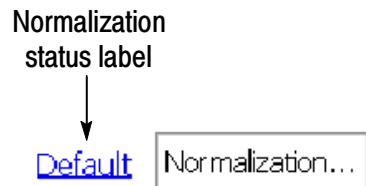
<b>Field/Button</b>	<b>Description</b>
Perform default normalization	Creates a new default normalization set.
Create user normalization	Creates a new User normalization based on the YBA250 current settings and conditions (frequency start/stop, power level, date/time, and internal module temperature).
Additional information	Opens a window to display more information about the selected Default or User normalization.
Load saved normalization	Loads a saved normalization set into the YBA250.
Save normalization	Saves the current User normalization data to a file.

There are three possible normalization data status labels shown in the Normalization window: Valid, Not Valid, and Unusable.

- **Valid:** The specified data is within the accepted tolerances of the current NetTek Analyzer/YBT250/YBA250 configuration or conditions.
- **Not Valid:** The specified data is not within the accepted tolerances of the current NetTek Analyzer/YBT250/YBA250 configuration or conditions.
- **Unusable:** The specified data was created on a different NetTek Analyzer/YBT250/YBA250 configuration, or normalization data does not exist.

### Normalization Type Status

The YBA250 displays the current normalization type status next to the Normalization button on the main Insertion Gain/Loss screen.



**Figure 2-16: Normalization type status label**

There are four normalization status labels:

**User** indicates that the YBA250 is using a valid User normalization set.

**User?** indicates that the YBA250 is using a non-valid User normalization set, and the measurements may not be as accurate as possible. The YBA250 automatically changes normalization status from User to User? under any of the following conditions (the YBA250 continues to use the current User normalization):

- The User normalization is more than seven days old.
- The internal temperature of either module has changed more than  $\pm 5$  °C ( $\pm 9$  °F) from the temperature values in the User normalization.

**Default** indicates that the YBA250 is using the Default normalization set. The YBA250 automatically replaces the current User normalization set with the Default normalization set, and changes the normalization status from User or User? to Default, under any of the following conditions:

- New frequency start and/or stop values were entered that are different than those in the User normalization.
- A new power output level value was entered that is different than the one in the User normalization.

**UnNormalized** indicates one of the following:

- Neither a User or Default normalization set is loaded.
- Either or both YBA250 or YBT250 modules were replaced with a different serial numbered module.
- The YBA250 module determines that the available Default normalization is not usable with the current module configuration.

---

**NOTE.** *The Default normalization is always usable, when used with the same YBA250/YBT250 module combination used to create the default normalization. The Default normalization is also usable when the creation date is older than seven days or the module temperature exceeds the above limits.*

---

### Creating a Default Normalization

To create a Default normalization, do the following:

1. Tap the **Insertion Gain/Loss** button to display the Insertion Gain/Loss screen.
2. Tap the **Normalization...** button to display the Normalization window.
3. Tap the **Perform default normalization** button to display the Default Normalization window.
4. Follow the on-screen instructions and diagram to connect the precision cables and attenuators between the YBA250 and YBT250 modules. Make sure to use the same cables and attenuators during the Default normalization process that you will use to take the insertion gain/loss measurements.
5. Tap the **Normalize** button. The instrument takes a minute or so to generate the normalization data, and then saves the Default normalization to memory, closes the window and returns you to the Normalization window.



---

**NOTE.** *Note: The Default normalization data set is not accessible as a file; it is stored in memory and set as the current Default normalization. To replace the existing Default normalization data, create a new Default normalization.*

---

### Creating a User Normalization

To create a User normalization, do the following:

1. Tap the **Insertion Gain/Loss** button to display the Insertion Gain/Loss screen.
2. Select the measurement type (Insertion Loss or Insertion Gain).
3. Select the signal standard from the drop-down list located below the menu bar.
4. Set the specific start/stop frequencies using any of the following methods:
  - Tap the **Channel** button to set the frequency span to a specific channel. The YBA250 centers the display at the center frequency of the selected channel and sets the span to twice the bandwidth specified by the signal standard, or 1.5 MHz, whichever is greater. If a Forward/Reverse/Both button is selected, it is taken into account when the Start and Stop frequencies are set. After you have selected a channel, tap **OK**.
  - Enter the Start and Stop frequencies in the frequency fields adjacent to the Channel button by using the numeric keypads or the knob.
  - To measure across just the forward or reverse bands, tap the **Forward** or **Reverse** button. To measure across both the Forward and Reverse bands, tap the **Both** button.
5. Select the signal power output level from the Power Output Level: list.
6. Tap the **Normalization...** button.

7. Tap the **Create User Normalization** button to display the User Normalization, Step 1 window. Verify the settings in the window; if they are incorrect, exit the window and enter the correct settings.
8. If the settings are correct, tap **Continue**. Follow the User Normalization, Step 2 window instructions and diagram to connect the precision cables and attenuators between the YBA250 and YBT250 modules.

---

**NOTE.** *Make sure to use the same cables and attenuators during the User normalization process that you will use to take the on-site insertion gain/loss measurements. Using attenuators on the module ports improves measurement accuracy by minimizing impedance mismatch errors between the module ports and the system or device under test.*

---

---

**NOTE.** *If you are measuring an amplifier that requires the use of a bias-tee, perform the normalization with the bias-tee in the normalization setup if possible; otherwise, subtract the bias-tee absolute loss value from the gain measurement value.*

---

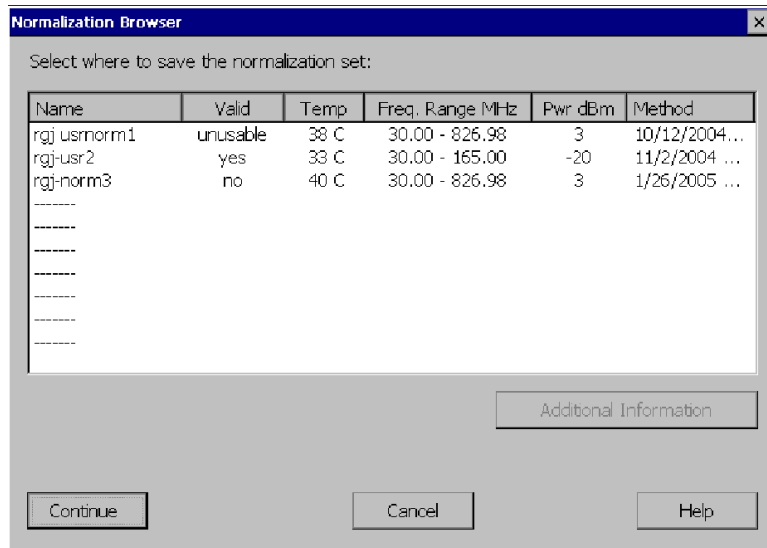
9. Tap the **Normalize** button. The instrument generates the normalization data, and then closes the window and returns you to the Normalization window.

The newly-created User normalization is stored in memory and is set as the current User normalization, until explicitly overwritten by creating a new User normalization or loading a saved User normalization.

### **Saving a User Normalization**

To save a User normalization to a file, do the following:

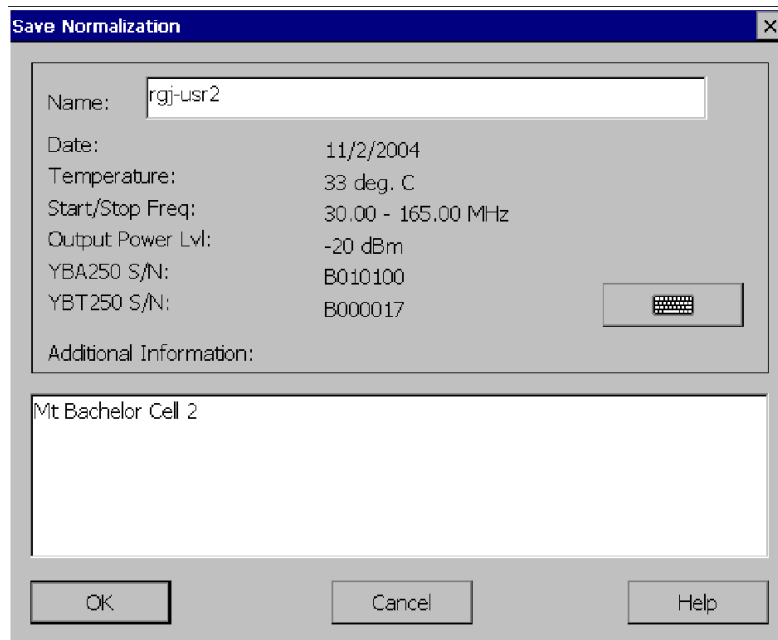
1. Tap the **Save Normalization** button to display the Normalization Browser window.



**Figure 2-17: Normalization Browser window**

2. Select the file slot in which to save the normalization data. Unused slot are indicated with dashes. To replace an existing User normalization file, select the file name to replace.

3. Tap the **Continue** button to display the Save Normalization window.



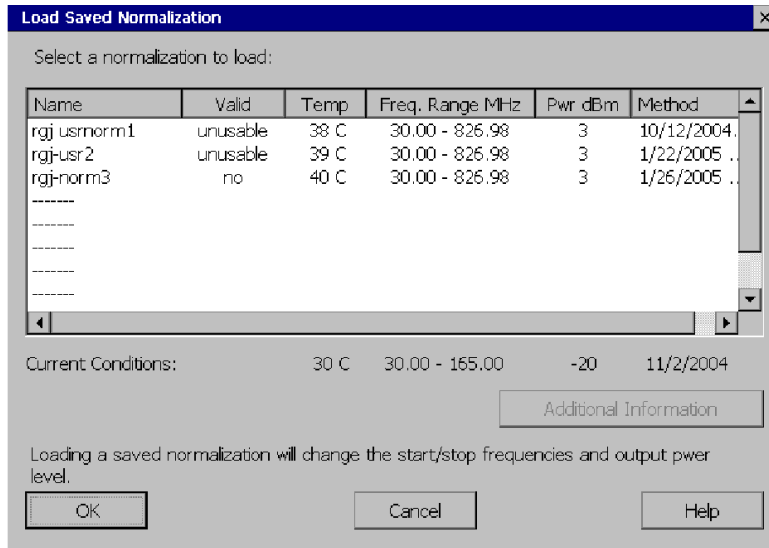
**Figure 2-18: Save Normalization window**

4. Enter a file name in the Name: field. The file name can have a maximum of 31 alpha-numeric characters, including spaces. Use an external keyboard, or tap the keyboard icon to display a touch-screen keyboard. Tap the keyboard icon in the task bar to close the keyboard.
5. Enter any other necessary descriptive text in the Additional Information field.
6. Tap **OK** to save the file to the specified name.

### **Loading a User Normalization**

1. To load a User normalization file, do the following:
2. Tap the **Insertion Gain/Loss** button.
3. Tap the **Normalization...** button.

4. Tap the **Load Saved Normalization** button to display the Load Saved Normalization window.



**Figure 2-19: Load Saved Normalization window**

5. Select the file from which to load the normalization data. Tap the **Additional Information** button to display more information about the file.
6. Tap **OK** to load the selected User normalization file into the instrument.

---

**NOTE.** Loading a normalization sets the instrument start/stop frequency and output power level values to those stored in the normalization. Other instrument settings, including measurement standard, measurement type, and measurement method, do not change when loading a normalization.

---

### **Normalization Guidelines**

- Two-port User normalizations created for a specific frequency range and power output provide the most accurate two-port insertion gain and loss measurements.
- The YBA250 does not ship with any User normalizations. You can create User normalizations any time before taking measurements. For best accuracy, create a new User normalization on site before taking measurements.
- The Default normalization is excellent for locating high-level malfunctions, such as testing an amplifier with low or no gain, isolating a transmission line problem, or testing a lightning-damaged filter.
- The YBA250 does not ship with a Default normalization; you should create one before performing any measurements. The YBA250 can take measurements without a Default or User normalization loaded, but the measurements will not be accurate. For reasonable accuracy, create a new Default normalization on site before taking measurements.
- A User normalization is only valid for the frequency range and power level used when the normalization data was collected. The normalization frequency and power information is shown in the normalization screens.
- Bias Tees, filters, and attenuators required to take a measurement (as opposed to filters and attenuators you are testing for correct operation) should be connected to the attenuators on the NetTek Analyzer ports, and a new normalization created to remove their effects from the measurement path.
- For maximum measurement accuracy, use the same cables and attenuators used to create the normalization data set to take measurements.

- The User normalization becomes less accurate and the YBA250 automatically changes normalization status from **User** to **User?** under the following conditions (the YBA250 continues to use the current User normalization):
  - The User normalization is more than seven days old.
  - The internal temperature of either module changes by more than  $\pm 5$  °C ( $\pm 9$  °F) from the temperature values at which the User normalization was created.
- The YBA250 automatically replaces the current User normalization set with the Default normalization (if present) and changes the normalization status from User or User? to Default under the following conditions:
  - Frequency start and/or stop values were entered that are different than those in the User normalization.
  - A power output level value was entered that is different than the one in the User normalization.
- The YBA250 automatically changes the normalization status from **User**, **User?**, or **Default** to **UnNormalized**, if either or both YBA250 or YBT250 modules are replaced with a different serial numbered module.
- The Default normalization data is always usable when used with the same YBT250/YBA250 module combination used to create the default normalization, even when the data is older than seven days or the module temperatures exceed the above limits.
- If you use multiple frequency ranges or power levels to take measurements, it may be convenient to create and save a user normalization entry for each of the measurements. Loading a saved User Normalization sets the instrument to the frequency range and power setting associated with that normalization.
- Default and User normalization data sets work only with the specific YBA250/YBT250 module pair used to create that data. The YBA250 reports the normalization set as not valid if you use the normalization data with different YBT250 and/or YBA250 modules.





# Configuring the Instrument

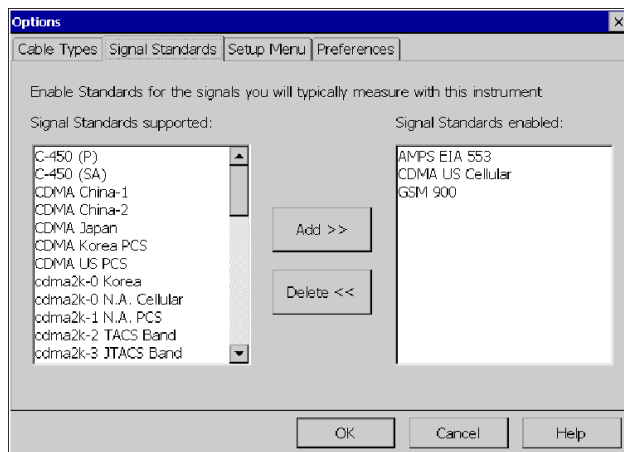
Before you can use the YBA250 to take measurements, you should configure the following instrument settings.

## Enabling Signal Standards

The currently selected signal standard controls the channels available from the signal standard list. Before you begin using the YBA250, you need to enable the signal standards that you want to test. Enabled signal standards are added to the Signal Standards drop-down list.

To enable a signal standard (add it to the Signal Standards drop-down list):

1. Select **Tools > Options**.
2. Tap the **Signal Standards** tab. This displays the window shown in Figure 2-20. The standards supported in the YBA250 are shown in the list on the left side of the window.



**Figure 2-20: The Signal Standards tab of the Options window**

3. To enable a signal standard, tap the name of the standard you want to enable and then tap **Add>>**.
4. When you have enabled all the standards you will be testing, tap **OK**.


Only enabled standards are displayed in the Signal Standards drop-down list.

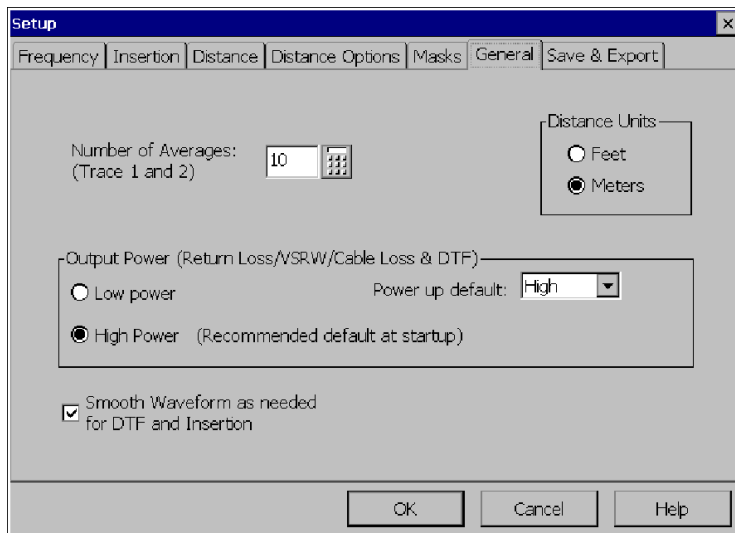
## Setting the Output Power Level

You can set the output power used for Calibration, Return Loss, Distance to Fault and Cable Loss measurements to either Low or High power. The default setting is High. The advantage of the High power setting is that it makes measurements more immune to interference from other signal sources. The advantage of the Low power setting is that it is less likely to disrupt calls on other transmitters.

The High power setting is also a good choice when testing long cables or cables with a high cable-loss value. If you are trying to measure cable with an active device on it, you may need to choose the Low power setting to avoid over driving the active device.

To set the Output Power level:

1. Tap the Edit button  or select **Setup > Edit** from the menu bar.
2. Tap the **General** tab.
3. Select the option button for Low power or High Power. See Figure 2-21.



**Figure 2-21: Setting the output power level**

---

**NOTE.** Each time the YBA250 is powered up, the Output Power is set to the level specified by Power up. The output power can be set to Low or High. The Low power level is approximately -20 dBm and the High power level is about +3 dBm.

---

To set the default Output Power level, tap **Low** or **High** from the Power up drop-down list.

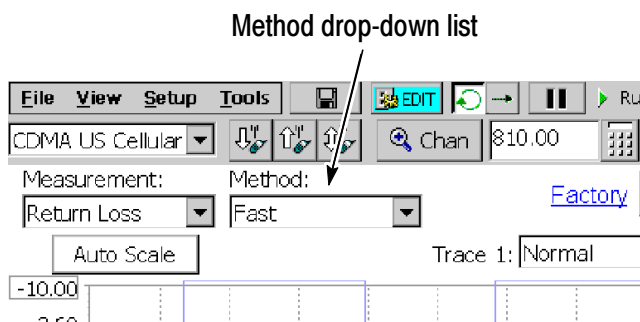
---

**NOTE.** Setting the Output Power Level does not affect the CW Signal Mode output power setting.

---

## Setting Measurement Method

The Method setting allows you to choose between a faster measurement with fewer data points or a slower measurement that contains more data points. The more data points in the measurement, the higher the resolution of the measurement, but the longer it takes to acquire the measurement. Figure 2-22 shows the location of the measurement Method function.



**Figure 2-22: Location of Method drop-down list**

To change the method setting, select the desired setting from the **Method** drop-down list. Table 2-14 shows how the Method setting affects the resolution.

**Table 2-14: Performance versus Resolution**

Method	Maximum Resolution for all measurements except Insertion Gain/Loss <sup>1</sup>	Average Resolution for Insertion Gain/Loss <sup>1</sup>
Fast	256	100
Normal	1024	200
High Resolution	4096	400

<sup>1</sup> Resolution is the number of data points acquired per measurement. The actual number of data points depends on several interacting factors. The number of data points displayed may be less than the maximum.

---

**NOTE.** *The measurement method setting is not shared between different measurement modes. Impedance, DTF, and Insertion Gain/Loss measurements can be set to different measurement methods.*

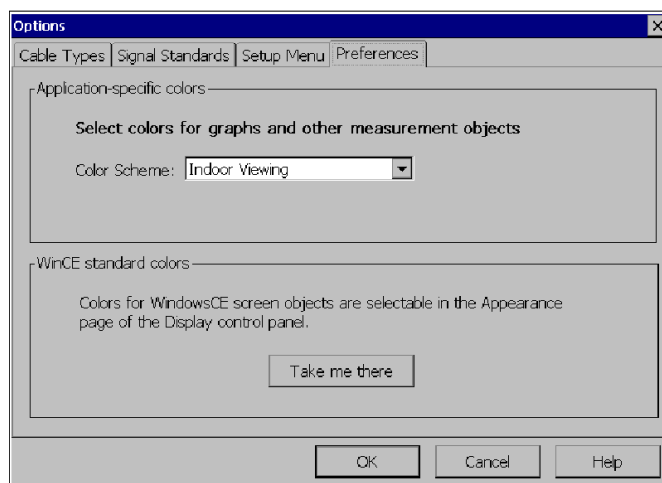
---

## Setting Display Preferences

The YBA250 enables you to change the color scheme used in the display. There are three color schemes, one monochrome scheme, and a black and white printout scheme. Color schemes specified in the YBA250 do not affect standard Windows CE screen items. The YBA250 color schemes affect only measurement graphs in the display.

To specify the color scheme used by the YBA250:

1. Select **Tools > Options**.
2. Select the **Preferences** tab. This displays the window shown in Figure 2-23.



**Figure 2-23: Preferences tab showing available color schemes**

3. To display a list of the available color schemes, tap the **Color Scheme** list box. Available color schemes are Indoor Viewing, Outdoor Viewing, Dark on white, Monochrome grays, and Black on White for Printer.
4. To select a color scheme, tap the name of the desired color scheme.
5. To change the Windows CE display properties, tap **Take Me There**. This displays the Windows CE Display Properties window, where you can set the display background and window color scheme.
6. Tap **OK** to save changes.
7. To view the changed color scheme, quit the YBA250 program and restart it.

### Display Trace Smoothing

For DTF and Insertion Gain/Loss measurements, when increasing the Start distance, decreasing the Stop distance, or reducing the frequency measurement range, the graph trace may become "blocky" because there are fewer data points to display. You can use the **View > Smoothing** command to smooth the displayed trace between data points.

You can also set trace smoothing as the default for DTF and Insertion Gain/Loss measurements by selecting **Smooth Waveform as needed for DTF and Insertion** on the **Setup > General** tab. When a measurement has less than 128 data points, the YBA250 automatically applies the smoothing function to the trace.

### Changing Settings for Saved Files

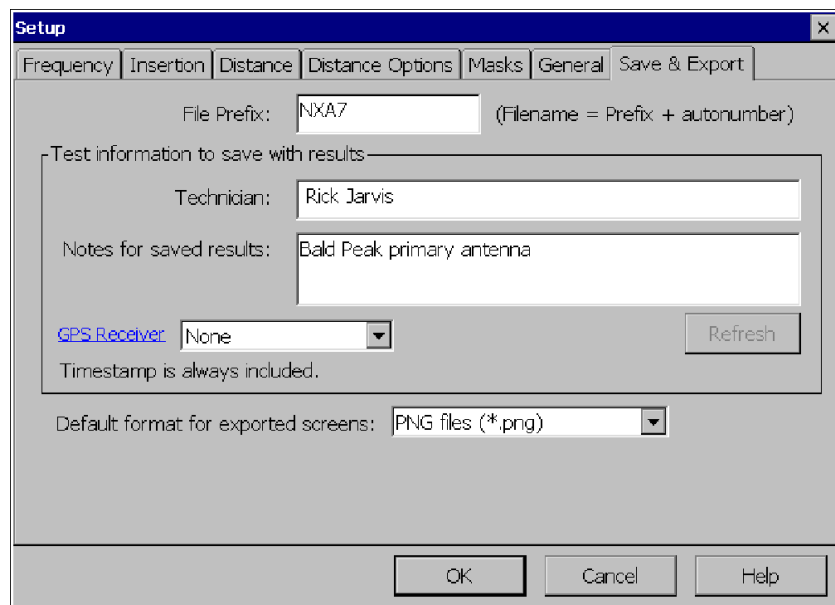
The YBA250 enables you to specify settings for saved files such as prefixes for filenames, the name of a technician making a test, notes to be included in saved results files, and the default format for exported screens.

## Setting File Options

The **Save & Export** tab is where you specify saved file options.

To display the Save & Export tab:

1. Select **Setup > Edit**.
2. Tap the **Save & Export** tab. See Figure 2-24.



**Figure 2-24: The Save & Export tab**

## Setting the Filename Prefix

The YBA250 allows you to save a file, such as a results file, with a name you enter each time you save a file. You can also allow the YBA250 to automatically name files for you. When files are saved without a specified prefix, the file name is simply a number, for example: 0004.r01. However, you can specify a prefix for automatically named files so that you can more easily identify saved files. Actual filenames will consist of the prefix you specify attached to a number, which is generated when the file is saved. For example, if you are testing Site 5 you could set the prefix to s5, resulting in a filename of s50004.r01.

---

**NOTE.** *The length of a file name is variable, depending on the length of the path (where the file is located). The limit of the path and file name is 256 characters. The shorter the path to the file, the longer the file name can be.*

---

To specify the file name prefix:

1. Select **Setup > Edit**. This displays the Setup window.
2. Tap the **Save & Export** tab. See Figure 2-24.
3. Tap the box after **File Prefix:**.
4. Enter text (using the soft keyboard or an external keyboard) to use as the prefix of file names.
5. Tap **OK** to save your changes.

### **Setting the Technician Name**

The YBA250 allows you to store the name of the technician performing a test in the results file for the test.

To specify the technician's name:

1. Select **Setup > Edit**. This displays the Setup window.
2. Tap the **Save & Export** tab. See Figure 2-24.
3. Tap the box after **Technician:**.
4. Enter the technician name. You can also use this space for additional test information instead of a technician name.
5. Tap **OK** to save the technician name field.

### **Entering Notes for Saved Results**

The YBA250 lets you enter a note to be saved in results files. Thus, if there are any special conditions about a test, you can save notes within the results file. You can enter up to 254 characters in the notes field.



To specify notes for saved results:

1. Select **Setup > Edit**. This displays the Setup window.
2. Tap the **Save & Export** tab. See Figure 2-24.
3. Tap the box after **Notes for saved results:**.
4. Enter text (using the soft keyboard or an external keyboard) for the note.
5. Tap **OK** to save the notes you entered.

## Saving GPS Coordinates with your Results

You can connect a GPS (Global Positioning System) receiver to your NetTek Analyzer to collect location coordinates that are saved with your measurement results. The most recent position read from the GPS receiver is included with your results when you save or export your results.

---

**NOTE.** *For correct coordinates when using the GPS function, save or export your results while the GPS receiver is at the location where you made the test. If you take a measurement, move the instrument, and then save your results, you will not be saving the coordinates of the location where you took the test. You will be saving the coordinates of your new location.*

---

### Selecting a Compatible GPS Receiver

You can use any GPS receiver that supports NMEA 0183 V2.0. Specifically, the GPS must output the \$GPRMC sentence on a regular basis.

The YBA250 application reads the GPS position from the GPS receiver once per second, or at the rate the GPS receiver sends the \$GPRMC sentence, whichever is slower.

**Connecting through the Serial Port.** The GPS receiver can connect to the serial port (4800 baud rate). The Garmin GPS III and Garmin GPS III Plus have been tested with the YBA250 application.

**Connecting through the PCMCIA Slot.** The GPS receiver can connect through the PCMCIA slot and emulate a serial port on COM4. The Teletype GPS WorldNavigator (product #1351) has been tested with the YBA250 application.

### **Setting Up YBA250/GPS receiver communications**

To set up the GPS receiver to work with the YBA250:

1. Set your GPS receiver to regularly output NMEA sentences.
2. Connect the GPS receiver (by serial cable or through the PCMCIA slot) to the NetTek Analyzer platform.
3. In the YBA250 application, tap the **Edit** button and then the **Save & Export** tab.
4. Select the correct GPS receiver interface type (Serial or PCMCIA) from the **GPS Receiver** drop-down list.

The YBA250 displays the latitude and longitude just to the right of the drop-down list box a short time after the GPS receiver sends the \$GPRMC sentence. Tap the **Refresh** button to update the displayed coordinates.

You can also view the latest GPS position in the Results Properties dialog box (**File > Results Properties**). When you open a saved results file, the Results Properties shows information about the results file, including the GPS position at the time the results file was saved.

### **Troubleshooting Your GPS Receiver**

After you have selected the GPS receiver type in the Save & Export dialog box, a position should appear immediately to the right of the list box.

**Error Message: Invalid Position.** If, after you select the GPS receiver type in the Save & Export dialog, the message “Invalid Position” appears, then the communication connection to the receiver has been successfully established, and the \$GPRMC sentence is being successfully read from the receiver, but the position supplied in that sentence is not valid. In this case, check your GPS receiver to see if it does have a valid position, and, if not, refer to the GPS receiver documentation to resolve this problem.

**Error Message: Unable to Read Position Information** If the instrument displays an error dialog indicating that the application was unable to read position information from the GPS receiver, do the following:

- Make sure the cable from the receiver to the serial port is connected and that the PCMCIA card is firmly seated.
- Ensure that the receiver is set to regularly output NMEA sentences.

If you have purchased the vxHpc terminal emulator, you can view the NMEA sentences being sent.

Open the vxHpc terminal emulator by tapping **Start > Programs > Communication > vxHpc**.

To view the NMEA sentences being sent, you need to set up vxHpc to connect to the correct port:

- For a serial port GPS receiver, set up vxHpc to connect to **COM1**.
- For the Teletype WorldNavigator, set up vxHpc to connect to **Teletype\_1358** (for Y350C NetTek Analyzer Platforms) or **COM4** (for Y400 NetTek Analyzer Platforms).

Configure the serial port as follows:

- 4800 baud
- 8 data bits
- No parity
- 1 stop bit
- No flow control

Open the session. You should see NMEA sentences being sent the GPS receiver.

If you do not see NMEA sentences, either the GPS receiver is not sending the sentences or the connection to the GPS receiver is not passing them (check the cables again). Refer to your GPS receiver documentation to find out how to output NMEA sentences regularly.





# Reference



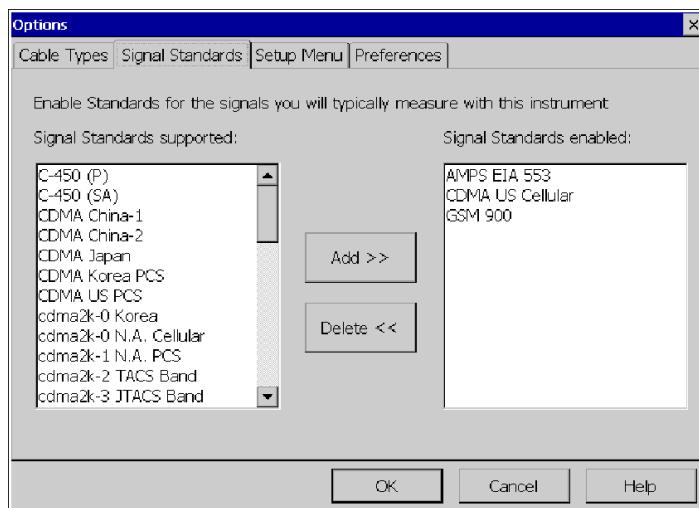
# Setting the Signal Standards and Test Frequency Range

## Selecting Signal Standards

The signal standards provide a fast way to specify the test frequency range available for taking measurements. Before you begin using the YBA250, you should add the signal standards you need for your testing to the standards list. Signal standards are selected from the Options window.

To add a signal standard to the Signal Standard list:

1. Select **Tools > Options**.
2. Tap the **Signal Standards** tab to display the window shown in Figure 3-1. The Signal Standards supported list (left side of window) lists all available standards.



**Figure 3-1: The Signal Standards tab of the Options window**

3. Tap the name of the standard to enable in the Signal Standards supported list.

4. Tap **Add>>**. This moves the standard name from one list to the other.
5. Repeat steps 3 and 4 until you have added all necessary signal standards to the list.
6. When you have enabled all the standards you will be testing, tap **OK**.

Only enabled standards are listed in the signal standards list that appears in the tuning controls area of the measurement displays.

---

**NOTE.** *You can also double-tap on a standard to move it from one list to the other.*

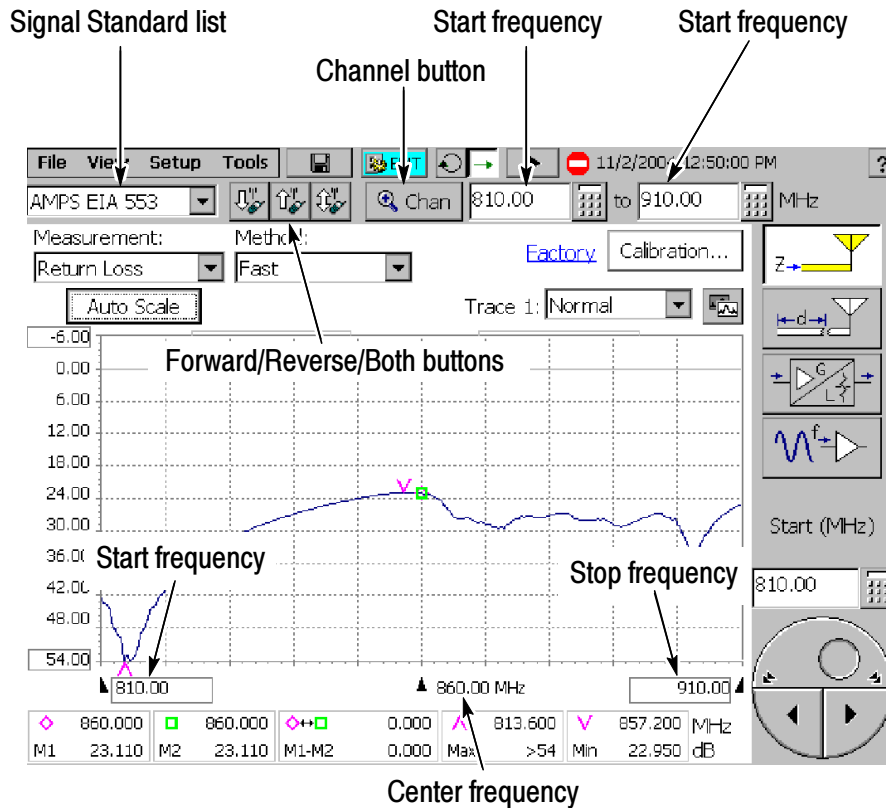
---

## The Test Frequency Range

All measurements (except DTF) are made across a test frequency range. The test frequency range is defined by specifying a start and a stop frequency. You must set the test frequency range before making a measurement.

Figure 3-2 shows the location of the frequency information, as well as the buttons and controls used to set the test frequency range.





**Figure 3-2: Frequency range controls**

There are two ways to set the test frequency range:

- Select the signal standard, channel, and direction
- Set the start and stop frequencies manually (see page 3-5)




## Setting the Test Frequency Range by Standard and Direction

The easiest way to set the test frequency range is to select the signal standard and direction. This way you don't have to remember the specific frequencies for a signal standard. Setting the signal standard and direction sets the test frequency range so that it covers the span of the entire selected standard plus 10% of the total span above and below.

To set the test frequency range by selecting the signal standard and direction:

1. Select the signal standard from the drop-down list. See Figure 3-2.


Only “enabled” signal standards are listed in the drop-down list. If a supported signal standard is not listed, you can add it by selecting **More..** from the drop-down list. For more information on enabling signal standards, see page 3-1.

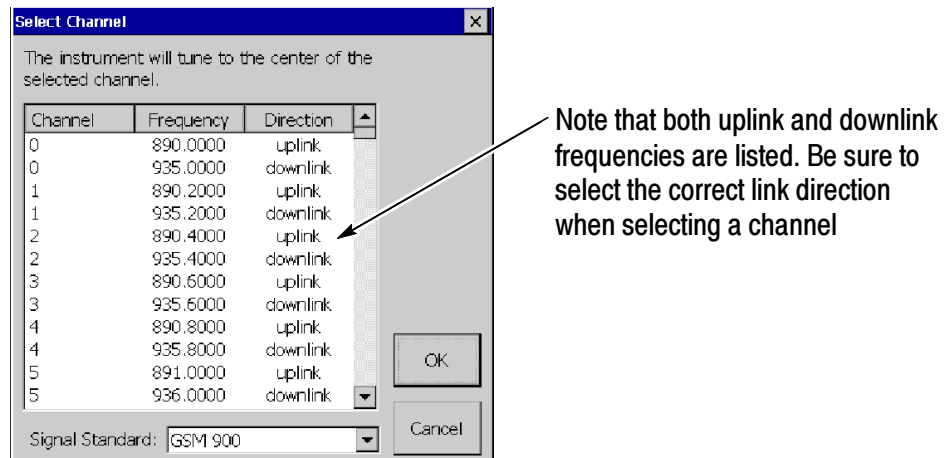
2. To set the bandwidth, tap one of the Forward , Reverse , or Both  buttons.

### Setting the Test Frequency Range by Channel

To test a specific channel within a signal standard, use the **Channel** button. When you set the test frequency range using the Channel button, the center of the frequency display is set to the center frequency of the specified channel. The test frequency range is set at twice the channel bandwidth (with a minimum test frequency range of 1.5 MHz). The start frequency is set one channel bandwidth below the channel center frequency and the stop frequency is set one channel bandwidth above the channel center frequency.

To set the test frequency range by selecting the Channel:

1. Select the signal standard from the drop-down list.
2. Tap the Channel button . This displays the **Select Channel** dialog box. See Figure 3-3.



**Figure 3-3: Select Channel dialog box**

3. Scroll through the list until you find the channel to test and tap the desired channel number to select it.

Note that the list shows both the uplink and downlink frequencies. Be sure to tap the correct direction when selecting a channel.

4. Tap **OK**.

You can customize the Channel Table contents to suit your specific measurement needs. See *Customizing the Channel Table* on page G-1 for more information.

## Setting the Test Frequency Range by Start and Stop Frequency

To set the test frequency range by specifying the start and stop frequencies:

1. Tap the numeric keypad next to the Start or Stop frequency entry box located below the menu bar (see Figure 3-2). This displays the **Enter Frequency** dialog shown in Figure 3-4.




**Figure 3-4: Entering the frequency with the keypad**

2. Enter the desired frequency by tapping the keypad.

You enter a frequency by tapping a number followed by a multiplier. You must include the multiplier (GHz, MHz, kHz, or Hz) to complete your input.

- For example, to enter a frequency of 370 MHz, tap **3 7 0 MHz**.
- To enter a frequency of 370.330 MHz, tap **3 7 0 . 3 3 0 MHz**.

To correct a mistyped number, tap the backspace button . If you enter a number that is outside the frequency range of the YBA250, the frequency is set to the maximum or minimum, depending on the value you entered.

To set the start and stop frequencies using the knob:

1. Tap the box at the bottom of the frequency display containing the Start or Stop frequency. This assigns the knob to the selected frequency. The label above the knob display will change to either **Start (MHz)** or **Stop (MHz)**.
2. Tap the knob to change the frequency.
  - Tap the top half of the knob to make large changes to the specified frequency. Tapping the knob to the right of the circle increases the frequency. Tapping the knob to the left of the circle decreases the frequency.
  - Tapping the arrow buttons on the lower half of the knob makes smaller changes than tapping the top half.

# Measuring Return Loss and VSWR

The YBA250 provides measurement capabilities to quickly and easily determine the condition of an antenna by measuring its return loss or VSWR.

## The Return Loss Display

The Return Loss displays return loss and VSWR measurements. Figure 3-5 shows an example return loss display.

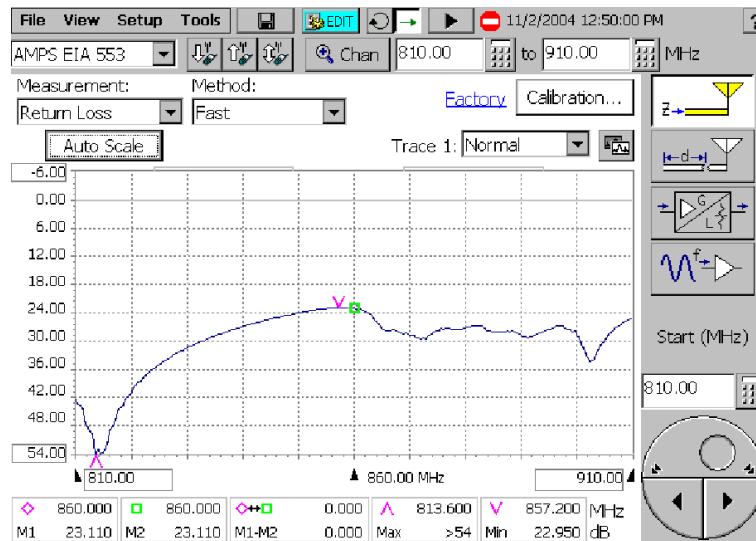


Figure 3-5: The Return Loss window

## Measuring Return Loss/VSWR

One way to measure the condition of an antenna system is to measure its Return Loss or VSWR. The YBA250 makes it easy to measure the Return Loss or VSWR of an antenna.

Return Loss is a ratio of the power sent to the antenna versus the power reflected by the antenna. A larger Return Loss is better because less power is reflected.

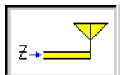

VSWR (Voltage Standing Wave Ratio) is a measure of the difference (ratio) of impedance between a transmission line and the attached load. For VSWR, the lower the number, the better. The best possible VSWR is 1.0, which means the impedance of a transmission line and its load match perfectly.

To measure Return Loss or VSWR:




---



**NOTE.** *To ensure accurate measurements, calibrate the YBA250 according to the procedures beginning on page 2-25. If possible, use the Calibrate with cable procedure to achieve the best results.*

---

1. Tap the **Impedance** button  .
2. Select **Return Loss** or **VSWR** from the Measurement: drop-down list.
3. Connect the cable from the antenna to be tested to the YBA250 Test Port connector.
4. Set the Output Power level, if needed.
5. Select the signal standard from the drop-down list located below the menu bar.
6. Set the start/stop frequencies using any of the following methods:
  - Tap the **Channel** button  to set the frequency span to a specific channel. The YBA250 centers the display at the center frequency of the selected channel and sets the span to twice the bandwidth specified by the signal standard, or 1.5 MHz, whichever is greater.

If a Forward, Reverse, or Both button is selected, the band information is taken into account when the Start and Stop frequencies are set. After you have selected a channel, tap OK.

- Enter the Start and Stop frequencies in the frequency fields adjacent to the Channel button by using the numeric keypad icons or the knob.
- Tap either the **Forward**  or **Reverse**  button to measure across just the forward or reverse bands. To measure across both the Forward and Reverse bands, tap the **Both**  button.

7. Set the measurement mode to either **Single** measurement  or **Continuous** measurement .

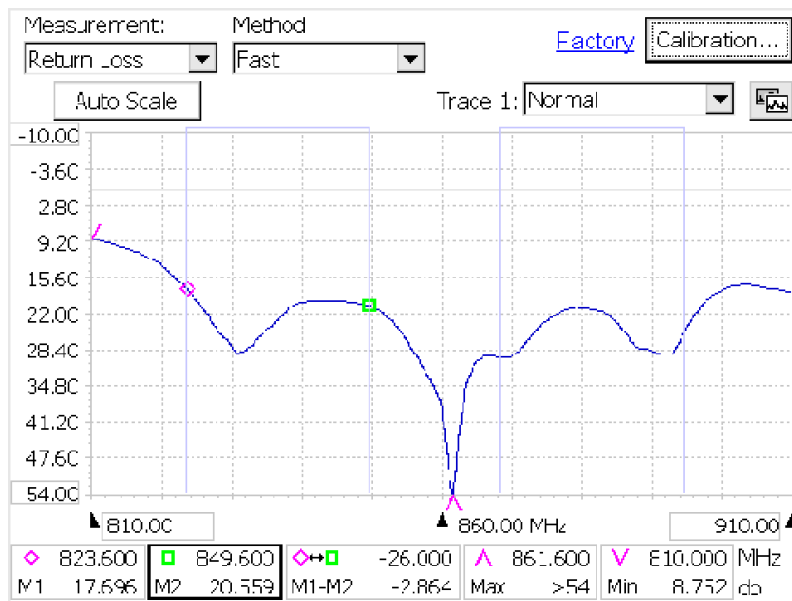
---

**NOTE.** *Continuous measurements consume more battery power than single-shot measurements. To extend battery-based operation, use single-shot mode whenever possible.*

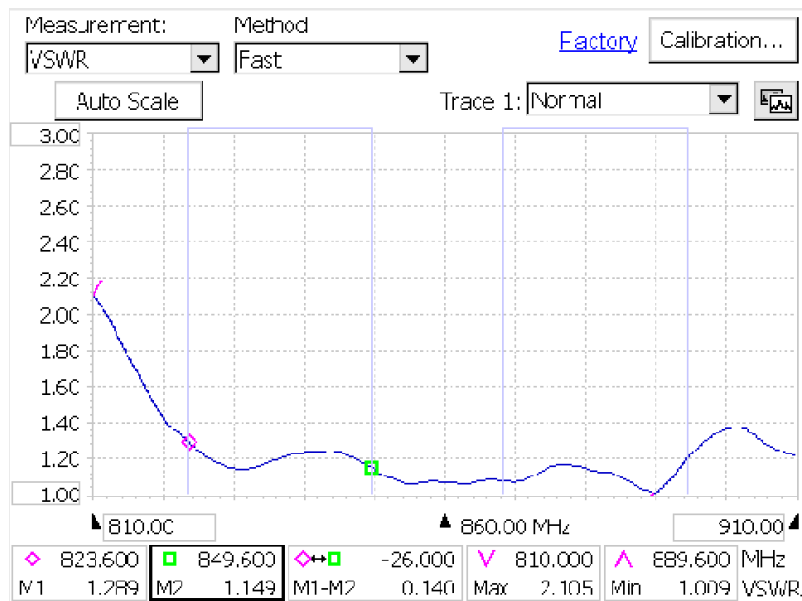
---

The YBA250 starts taking measurements. Figures 3-6 and 3-7 show example measurements for return loss and VSWR measurements.

## Measuring Return Loss and VSWR



**Figure 3-6: Example of a Return Loss measurement**



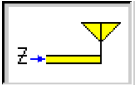

**Figure 3-7: Example of a VSWR measurement**



## Measuring Cable Loss






The YBA250 can measure the loss of a cable using a one-port measurement method. When measuring the loss of a cable, you must terminate the other end of the cable with either a short or an open termination. Cable loss measurements are not valid if the cable is connected to a load.

To measure the loss of a cable:

1. Tap the **Impedance** button .
2. Select **Cable Loss** from the Measurement: drop-down list.
3. Connect one end of the cable to be tested to the YBA250 Test Port connector.
4. Connect either a short or an open termination to the other end of the cable.
5. Set the Output Power level, if needed.
6. Select the signal standard from the drop-down list located below the menu bar.
7. Set the start/stop frequencies using any of the following methods:
  - Tap the Channel button  to set the frequency span to a specific channel. The YBA250 centers the display at the center frequency of the selected channel and sets the span to twice the bandwidth specified by the signal standard, or 1.5 MHz, whichever is greater.

If a Forward, Reverse, or Both button is selected, the associated band information is taken into account when the Start and Stop frequencies are set. After you have selected a channel, tap OK.

- Enter the Start and Stop frequencies in the frequency fields adjacent to the Channel button by using the numeric keypad icons or the knob.

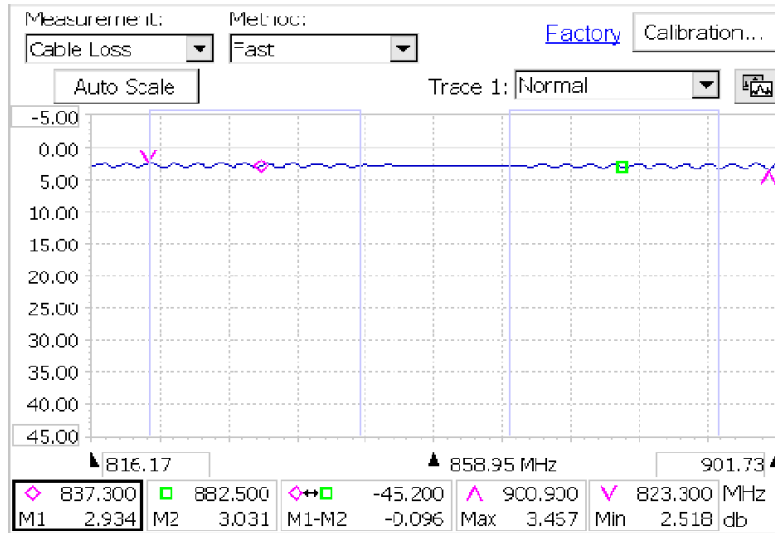
- Tap either the **Forward**  or **Reverse**  button to measure across just the forward or reverse bands. To measure across both the Forward and Reverse bands, tap the **Both**  button.
  
- 8. Set the measurement mode to either **Single** measurement  or **Continuous** measurement .

---

**NOTE.** *Continuous measurements consume more battery power than single-shot measurements. To extend battery-based operation, use single-shot mode whenever possible.*

---

Figure 3-8 shows an example cable loss measurement.



**Figure 3-8: Example of a cable loss measurement**

# Measuring the Distance to a Fault

The YBA250 can measure the distance to a fault, enabling you to quickly locate faults on your antenna.

## The Distance to Fault Display

The Distance to fault window shows distance to fault measurement results. Figure 3-9 shows a typical distance to fault display.

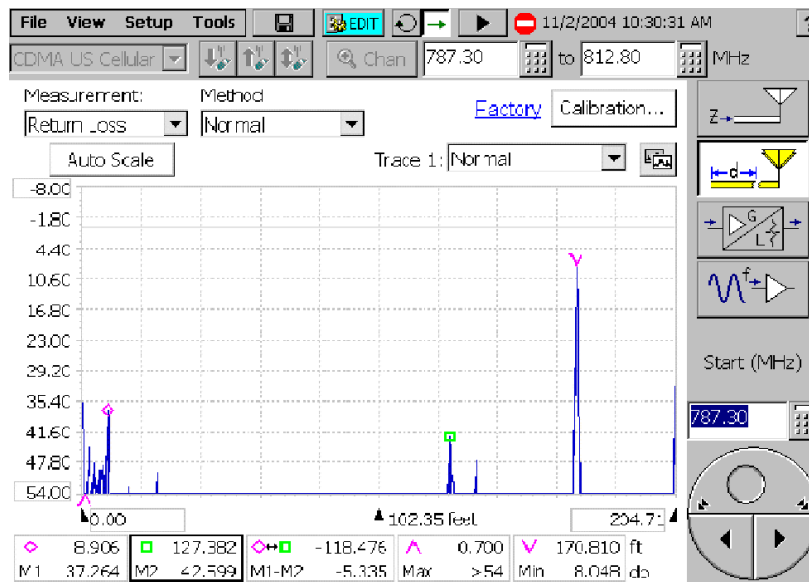


Figure 3-9: The Distance to Fault display

## Measuring the Distance to a Fault



---

**WARNING.** *To prevent personal injury from the effects of lightning, do not connect this product to any source that might be subject to the effects of lightning. Use your own good judgement and common sense. You must protect yourself from the effects of lightning.*

---

To measure the distance to a fault:

1. Following your standard practice, disconnect the antenna to be tested from the transmitter.
2. Discharge the antenna line (short the center conductor to the cable ground shield).



---

**CAUTION.** *Failure to discharge the antenna line can cause severe damage to the YBA250 from the static electrical charge, which may be present on the antenna and cable.*

---

3. Connect the cable/antenna assembly to be tested to the YBA250 test port.

4. Tap the **Distance** button .

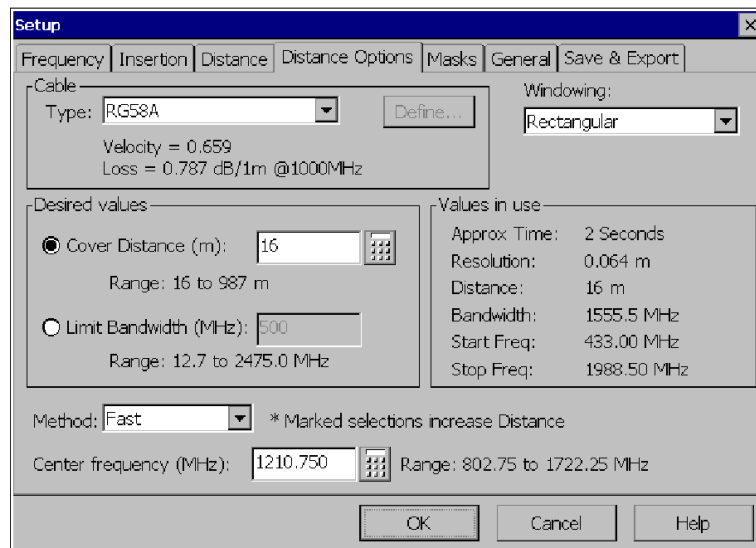
5. Set the Output Power level, if needed.

6. Specify the cable type to be tested:

- a. Tap the **Edit** button  **EDIT**.

- b. Tap the **Distance Options** tab.

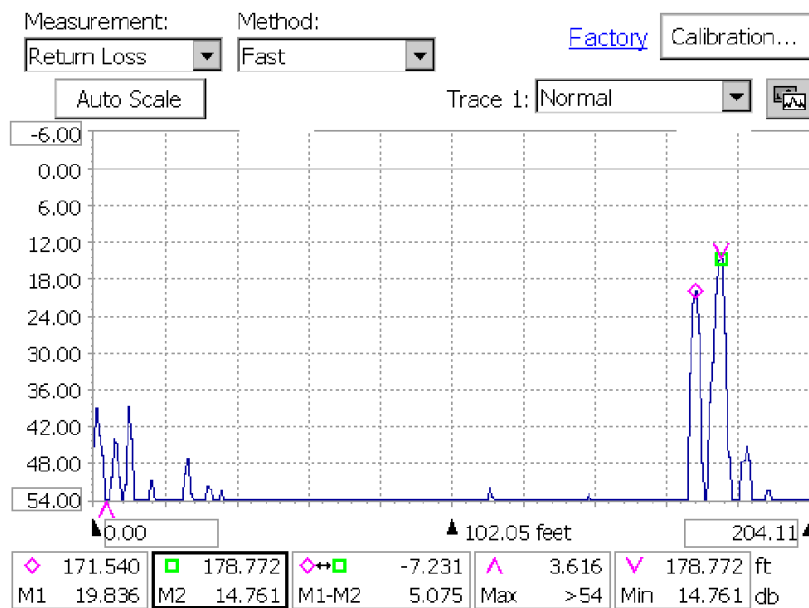
- c. Select the cable type to be tested from the drop-down list next to **Type:**. See Figure 3-10.



**Figure 3-10: The Distance Options tab**

**NOTE.** The cables listed in the Type drop-down list are defined in the Cable Types list (Tools > Options > Cable Types tab).

- d. The selected cable’s velocity and loss specifications are shown below the Type drop-down list. If the cable type you want to test is not listed, see *Setting Cable Types* on page 3-19, *Creating a User-Defined Cable Type* on page 3-19, and *Customizing The Cable Standards Table* on page 3-10 for further information.
  - e. Tap **OK**.
7. The YBA250 begins taking distance to fault (DTF) measurements. Figure 3-11 shows an example DTF measurement.



**Figure 3-11: An example of a distance to fault measurement**

## Changing the Vertical Scale Units


The default setting for Vertical Scale Units is dB. You can also display faults using VSWR as the vertical scale unit.

To change the vertical scale unit to VSWR, select **VSWR** from the **Measurement** drop-down list.

## Limiting the Bandwidth for a Bandpass Filter

The YBA250 automatically adjusts the frequencies it uses to make the distance-to-fault measurement depending on the Method and Cover Distance settings. If your antenna uses a bandpass filter to minimize interference from other sources, you will need to limit the bandwidth used by the YBA250 so its measurement signal can pass through the filter.

To set the bandwidth for the distance-to-fault measurement:

1. Tap the **Edit**  button. This displays the Setup window.
2. Tap the **Distance Options** tab. See Figure 3-10.
3. Select the **Limit Bandwidth** option button.
4. Tap the numeric keypad next to the **Limit Bandwidth** box.
5. Enter the bandwidth of the filter.
6. Tap the numeric keypad next to the **Center frequency** box.
7. Enter the center frequency of the bandpass filter.
8. Tap **OK** to save your changes.

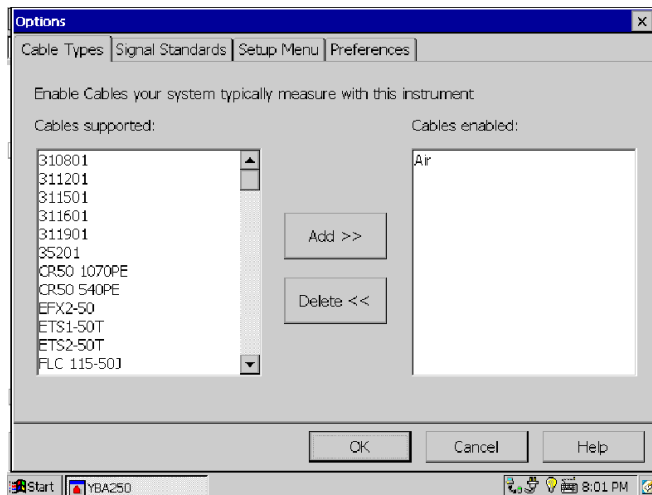
Note that values in the **Values in use** box will change as you change values for the Limit Bandwidth or the Center Frequency. Most importantly, by limiting the range of frequencies available for the distance to fault measurement, the maximum distance that can be measured will be limited. The exact distance will depend on the Limit Bandwidth and method selected.

## Setting Cable Types

It is essential to specify the cable type being tested to achieve accurate measurements. It is impossible to determine the true distance to a fault if the wrong cable type (propagation velocity and loss) is specified.

To select the cable types you will be testing:

1. Select **Tools > Options** menu item.
2. Tap the **Cable Types** tab to display the Cable Types window, as shown in Figure 3-12.



**Figure 3-12: The Cable Types window**

3. Select a cable type you use in your system from the **Cables supported** list on the left side of the window.
4. Tap **Add>>** to add the selected cable to the list of enabled cables.
5. Continue to add cables to the **Cables enabled** list until you have enabled all the cables which you use in your system.
6. Tap **OK** to close the window. The cable types you added are now listed in the cable Type field of the Distance Options tab.

---

**NOTE.** Double-tapping on a cable type moves the cable from one list to the other without needing to use the Add button.


---

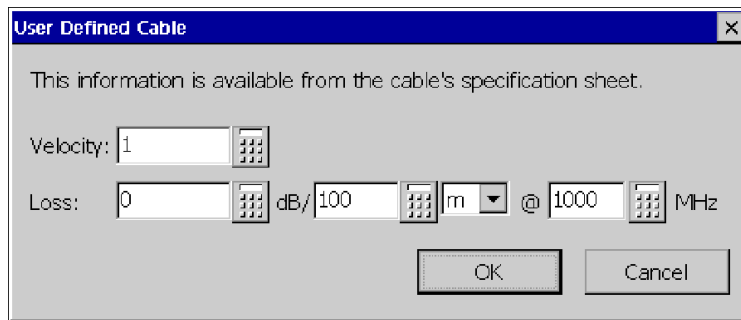


## Creating a User-Defined Cable Type

If your system uses a cable type not listed in the Cable Type drop-down list, you can define your own cable type. To create a user-defined cable type, you need to know the velocity of propagation and cable loss characteristics of your cable.

To create a user-defined cable type:

1. Tap the **Edit** button .
2. Tap the **Distance Options** tab. See Figure 3-10.
3. On the Distance Options tab, select **User defined** from the Type: drop-down list.
4. Tap the **Define...** button to display the User Defined Cable dialog. See Figure 3-13.



**Figure 3-13: User Defined Cable window**

5. To specify the velocity of propagation, tap the numeric keypad button next to the **Velocity** entry box. Enter a number between 0.1 and 1. Tap **OK** when you have entered the number.
6. To specify the cable loss, first tap the numeric keypad button next to the **Loss:** entry box. Enter a number between 0 and 100. Fractional values are acceptable. Tap **OK** when you have entered the number.

7. To specify the distance at which the cable loss is specified, tap the numeric keypad button to the right of “**dB**”. Enter a number for the distance. Tap **OK** when you have entered the number.
8. Tap the drop-down list (there is only one) to specify the unit distance, either **ft** (feet) or **m** (meters).
9. To specify the frequency at which the cable loss is specified, tap the numeric keypad button next to **MHz**. Enter a number between 1 and 10000. Tap **OK** when you have entered the number.
10. Tap **OK** when you have entered all the necessary numbers. These values are assigned to the **User defined** cable type in the list.

The specifications you entered for your cable type are shown below the Type drop-down list. These are the values that are used for distance to fault measurements when you select User defined.

## Customizing the Cable Standards Table

The Cable Standards Table is a plain text file used by the YBA250 to specify the characteristics of the cable types that are tested. You can customize the Cable Standards Table to suit the specific needs of your system. For example, if there are cable types in your system that are not included in the default list of cable types, you could add them to the cable standards table. This allows you to select your cable types from the Type drop-down list whenever you want to make a distance to fault measurement. You can also shorten the Type drop-down list by deleting cables from the cable standards list if you never test those cable types.

The YBA250 looks for a file named CableStandards.txt in the \BuiltInDisk\NetTekApps\YBA250 folder when it starts up. You can edit this file to include cable types not originally included in the file from the factory.

### Customizing the Cable Standards Table

To customize the cable standards table:

1. Locate the existing **CableStandards.txt** file in either the **\BuiltInDisk\NetTekApps\YBA250** folder or **\NetTekApps\YBA250** folder (only if the application software loaded into volatile memory instead of flash memory).
2. Make a copy of the original file and store the copy in another location within the BuiltInDisk folder as a backup.
3. Use Pocket Word to edit the contents of the file to suit your systems settings. When saving the file, be certain to save the file as a TEXT file (txt), not as a Pocket Word file (pwd).

When editing your CableStandards.txt file, it is more reliable to copy a row and then edit the copied row to meet your requirements than to modify an existing row.

Table 3-1 lists the elements of the CableStandards.txt file.

**Table 3-1: Channel table file contents**

Column heading	Description
Cable ID	An identification number assigned to the cable.
Cable Name	This is the name of the cable that appears in the Type drop-down list.
Velocity	The cable's velocity of propagation.
Loss	The loss of the cable per the loss distance, in dB.
Loss Distance	The distance over which the cable loss is specified.
Loss Frequency	The frequency at which the cable loss is specified.
Metric T/F	Indicates whether the Loss distance is metric or not. If True, the loss distance is in meters.


cable id	cable name	velocity	loss	Loss Distance	Loss Frequency	metric T/F
1	Air	1	0	100	1000	TRUE
2	None	1	0	100	1000	TRUE
3	RG8	0.659	0.262	1	1000	TRUE
4	RG8A	0.659	0.262	1	1000	TRUE
5	RG9	0.659	0.289	1	1000	TRUE
6	RG9A	0.659	0.289	1	1000	TRUE
7	RG17	0.659	0.18	1	1000	TRUE
8	RG17A	0.659	0.18	1	1000	TRUE
9	RG55	0.659	0.541	1	1000	TRUE
10	RG55A	0.659	0.541	1	1000	TRUE
11	RG55B	0.659	0.541	1	1000	TRUE
12	RG58	0.659	0.558	1	1000	TRUE
13	RG58B	0.659	0.558	1	1000	TRUE...

**Figure 3-14: A portion of the cablestandards text file**

## Improving the Display of Distance Measurements

The Distance to fault display will show a large main lobe at a fault location, surrounded by series of side lobes of decreasing amplitude. The YBA250 provides a choice of windowing functions that enable you to make a tradeoff between resolution of the fault location and suppression of waveform “noise” (side lobe magnitude).

To select a windowing function:

1. Tap the **Edit** button  .
2. Tap the **Distance Options** tab. See Figure 3-10.
3. Select **Rectangular** or **Blackman** from the Windowing drop-down list.


The Rectangular window produces a display with a narrow main lobe and relatively higher side lobes (possibly making the main lobe more difficult to spot), resulting in better distance resolution but a “noisier” waveform. The Blackman window produces a display with a wider main lobe and relatively smaller side lobes, which emphasizes the main lobe (making it easier to spot) but reduces distance resolution.

## Resolution of Distance to Fault Measurement

The resolution (distance between data points) shown in the Distance display is based on several interacting factors. Resolution is important because it limits how accurately you can locate a fault. The resolution varies with the Method, the bandwidth used, and the maximum distance setting.

The maximum distance, bandwidth, and Method settings can be changed. Normally, the only settings you need to adjust are the maximum distance and the Method. However, if your antenna has a bandpass filter installed, you will need to limit the bandwidth on the YBA250 to make correct distance-to-fault measurements. Limiting the bandwidth used by the YBA250 may limit the distance and resolution of the measurement.

To increase the resolution:

1. Tap the **Edit**  button.
2. Tap the **Distance Options** tab. See Figure 3-10.
3. Tap the **Cover Distance** option button if it is not selected.
4. Tap the numeric keypad next to the Cover Distance box.
5. Enter the distance from the receiver to the antenna.

Review the displayed value for **Resolution** in the **Values in use** box. Note that as you shorten the **Cover Distance** sufficiently (without changing the Method), the Resolution will improve, that is, the distance between data points will shorten. When you change the method to **Normal** or **High Resolution** (without changing the Cover Distance), the **Approx Time** will increase as will the Resolution.



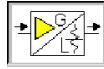
## Measuring Insertion Gain and Loss

The YBA250 can quickly and easily take two-port insertion gain and loss measurements. Two-port measurements, also known as transmission measurements, provide insertion gain and loss measurements by using two test ports; a signal source (the YBA250 module) and a signal receiver (the YBT250 module). Results are displayed as a graph (level versus frequency) and a single numeric readout that shows the average gain or loss value over the specified frequency span.

Insertion gain measures the gain (in dB) of active devices such as tower-mounted amplifiers (TMA), repeaters, and boosters. Active devices may be integrated with other components, including filters, duplexers, splitters, and combiners. You can also measure the insertion gain of an entire RF path that includes amplifiers and passive devices. Insertion loss measures the loss (in dB) of active devices such as filters, duplexers, splitters, combiners, as well as passive components such as cable.

Two-port insertion gain and loss measurements are best for measuring signal paths that contain active, wide-dynamic-range components, such as circulators, filters, tower mounted amplifiers (TMA), and directional couplers. Two-port loss measurements are more accurate than one-port measurements.

## The Insertion Gain/Loss Window

Tap the **Insertion Gain/Loss** button  to display the Insertion Gain/Loss window (Figure 3-15).

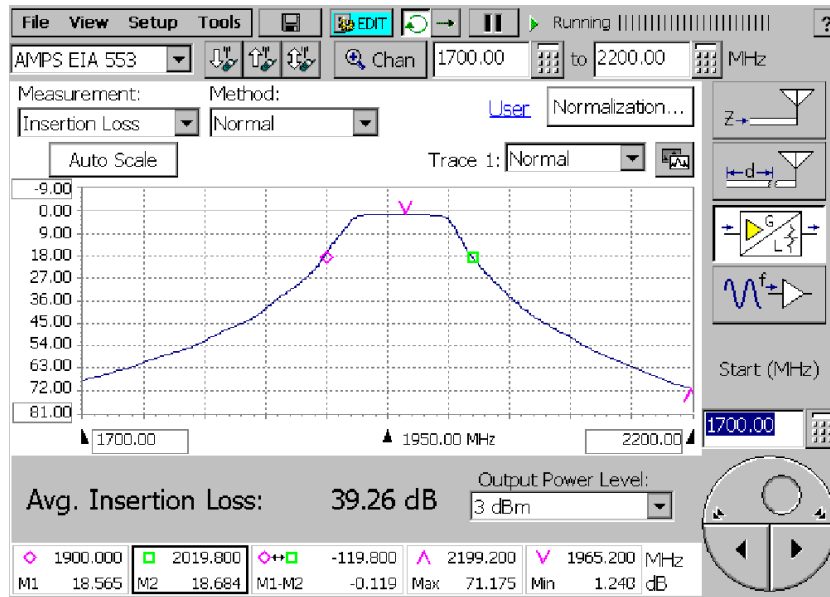


Figure 3-15: The Return Gain/Loss window

## Measuring Insertion Gain or Loss

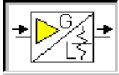

### Requirements:

- Both a YBT250 and a YBA250 module must be installed on the NetTek Analyzer. The YBT250 should be the outermost-installed module.
- The precision cables and attenuators used to create the Default or User normalizations. See page 2-40 for information on creating and using normalizations.
- For testing cable insertion loss, you must have access to both ends of the cable to connect to the NetTek analyzer.








To measure insertion gain or loss:

1. Connect the NetTek Analyzer to the device or system under test:
  - a. Using the same cable and attenuator that you used to create the normalization, connect the device or system under test signal input to the YBA250 TEST PORT connector. Then connect the YBT250 RF INPUT to the device or system under test signal output connector.
  - b. If measuring cable loss only, use the same cable and attenuator that you used to create the normalization to connect one end of the cable being tested to the YBA250 TEST PORT connector. Then connect the other end of the cable being tested to the normalization cable/attenuator attached to the YBT250 RF INPUT connector.
  - c. If measuring the gain of a tower-mounted amplifier (TMA), see *Connecting to a Tower Mounted Amplifier (TMA)* on page 3-28 for information on connecting the NetTek analyzer to a TMA.

2. Tap the **Insertion Gain/Loss** button  .
3. Select the measurement type (Insertion Loss or Insertion Gain).
4. Select the signal standard from the drop-down list located below the menu bar.
5. Set the start/stop frequencies using any of the following methods:
  - **Preferred Method:** Create or load a User normalization that contains the frequency start/stop values and output power level required for the measurement. For maximum accuracy, create a User normalization on site before taking measurements.
  - Tap the **Channel** button  to set the frequency span to a specific channel to measure. The YBA250 centers the display at the center frequency of the selected channel and sets the span to twice the bandwidth specified by the signal standard, or 1.5 MHz, whichever is greater.

If a Forward, Reverse, or Both button is selected, the associated band information is taken into account when the Start and Stop frequencies are set. After you have selected a channel, tap **OK**.

- Enter the Start and Stop frequencies in the frequency fields adjacent to the Channel button by using the numeric keypad icons or the knob.
  - Tap either the **Forward**  or **Reverse**  button to measure across just the forward or reverse bands. To measure across both the Forward and Reverse bands, tap the **Both**  button.
6. Select the signal power output level from the **Power Output Level:** list.
  7. Set the measurement mode to either **Single** measurement  or **Continuous** measurement .
  8. If necessary, tap the **Play** button to start taking measurements.

---

**NOTE.** *Continuous measurements consume more battery power than single-shot measurements. To extend battery-based operation, use single-shot mode whenever possible.*

---

### Connecting to a Tower Mounted Amplifier (TMA)



---

**CAUTION.** *Please check your country's laws regarding transmitters before using the NetTek Analyzer to transmit a test signal.*

---

To connect the NetTek Analyzer to a TMA to perform insertion gain or loss measurements, perform the following procedure:

**Requirements:**

- A Bias Tee connector.
- A Bias Tee power supply.
- The same precision cables and attenuators used to create the Default and/or User normalization.

---

**NOTE.** *Bias tees designed for TMAs often contain 1/4-wave shorting stubs and gas discharge tubes for protection. These protection circuits can affect the accuracy of the measurement and can cause peaks and dips in the waveform. Use a wideband bias tee without protection circuits (such as Tektronix part number 015-0718-00) to avoid or reduce this problem.*

---

1. Connect the YBA250 TEST PORT to the TMA Antenna input port, using the same cable and attenuator used to create the normalization.
2. Connect the Bias Tee to the attenuator on the YBT250 RF INPUT. Use the same attenuator used to create the normalization.
3. Connect the Bias Tee to the BTS connector on the TMA using the same cable used to create the normalization.
4. Connect the Bias Tee power supply to the Bias Tee.

**TMA Bias Tee Connection Notes:**

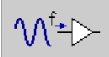
- Check that the bias tee power supply voltage and polarity rating are compatible with the TMA before applying power.
- Create a User normalization with the bias tee attached before taking measurements, unless you want to include the loss of the bias tee in the measurement.
- You do not need to turn on the bias tee power supply to create the User normalization.

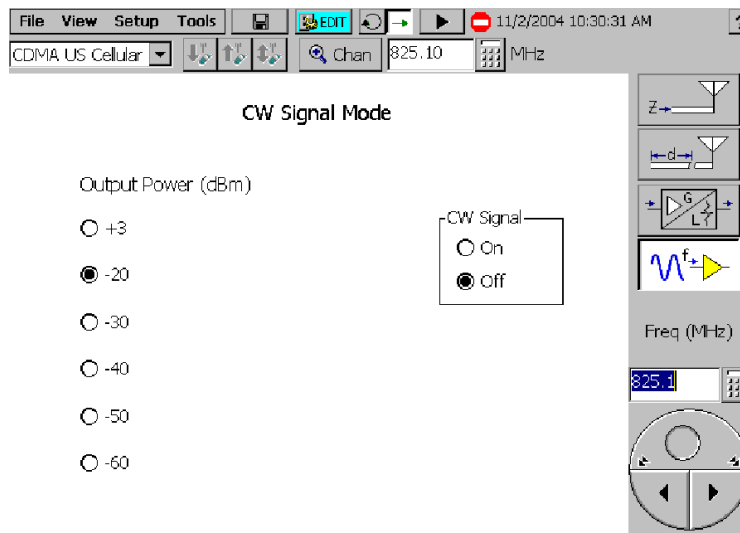


# Generating a Continuous Wave (CW) Signal


A continuous wave (CW) signal source, used in combination with a test receiver such as the Tektronix YBT250, can test a variety of two-port devices. The YBA250 can generate a CW signal that is adjustable across the entire YBA250 frequency band and over power levels from +3 dBm to -60 dBm.

To generate a CW signal:

1. Connect the cable from the device to be tested to the YBA250 **TEST PORT** connector.
2. Tap the **CW Signal Mode** button . See Figure 3-16.



**Figure 3-16: Setting output power for CW signal mode**

3. Select the signal standard from the drop-down list located below the menu bar.
4. Set the desired frequency using the frequency controls or the knob. A quick way to do this is to use the **Channel** button  to set the frequency to a channel.
5. Tap the appropriate Output Power option button to set the output level.
6. Tap CW Signal **On** or **Off** to turn the signal on or off.

---

**NOTE.** *The CW Signal Mode Output Power setting does not affect the Output Power setting on the General tab of the Setup window.*

---

# Working with Traces

The YBA250 enables you to control the display of traces several ways. You can set the type of trace display, whether or not a second trace is displayed, display saved traces and compare traces.

## Setting the Trace Type

You can change how a trace is displayed to make it easier to analyze. There are five trace types you can choose from. See Table 3-2.

**Table 3-2: Trace type options**

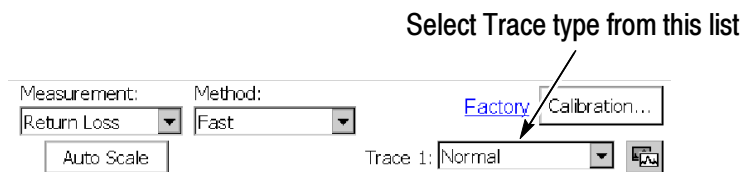
Trace type	Description
Normal	Each point in the trace represents a single acquisition. Updates display with each new acquisition.
Average	Each point in the trace represents an average of a number of acquisitions. The number of acquisitions averaged is set on the General tab of the Setup window.
Min	Each point in the trace represents the minimum amplitude measured at that frequency since the acquisition was started. Acquisition can be restarted by tapping the restart button. Updates displayed point only if new point < old point.

**Table 3-2: Trace type options (Cont.)**

Trace type	Description
Max	Each point in the trace represents the maximum amplitude measured at that frequency since the acquisition was started. Acquisition can be restarted by tapping the the restart button. Updates displayed point only if new point > old point.
Min/Max	This is a combination of Min and Max. Each point in the trace has both a minimum and maximum value that correspond, respectively, to the minimum and maximum values measured at that frequency since the acquisition was started. Acquisition can be restarted by tapping the restart button. Displays a bar between Max and Min points.

The usual trace type is Normal. However, you can set the trace type to any of the other four trace types.

To specify the trace type, select the desired trace type from the **Trace** drop-down list. See Figure 3-17.



**Figure 3-17: Setting the trace type**



You can also set the trace type in the Setup window:

1. Select **Setup > Edit**.
2. Tap the appropriate tab to set the trace type for a particular measurement:
  - a. Tap the **Frequency** tab to set the trace type for Return Loss measurements
  - b. Tap the **Insertion** tab to set the trace type for the Insertion Gain/Loss measurements.
  - c. Tap the **Distance** tab to set the trace type for Distance to Fault measurements.
3. Select the desired trace type from the drop-down list.

If you select Average, you can also set the number of traces averaged together to create the trace display. The default number of averages is 10. This number applies to both Trace 1 and 2.

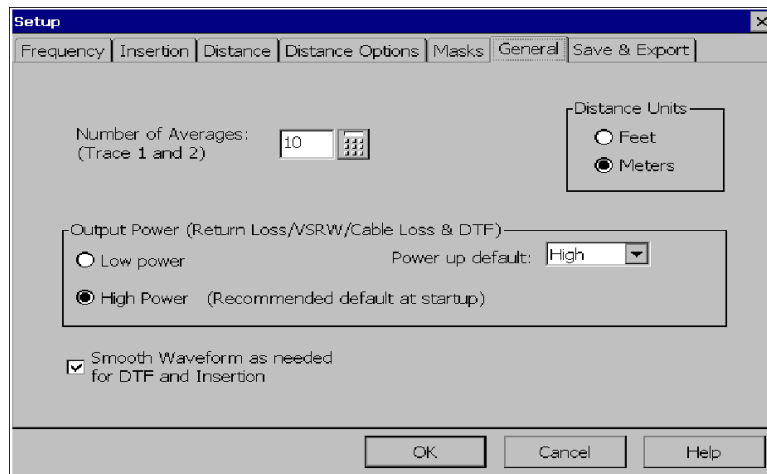
- a. To set the number of averages, tap the **General** tab. Then tap the keypad next to **Number of Averages**.
  - b. Enter the number of traces to average and then tap **OK**.
4. Tap **OK** to save your changes.

## Changing the Units of the Distance to Fault Display

The units of distance in the Distance to Fault display can be set to either feet or meters.

To change the distance units of the Distance to Fault display:

1. Tap the Edit button  or select **Setup > Edit**.
2. Tap the **General** tab. See Figure 3-18.



**Figure 3-18: Setting the distance units**

3. Change the distance units by tapping the appropriate **Distance Units** option button.

## Saving Results

You can save a trace for later recall. For example, you can save an example of a good trace for comparison with a live trace later.

To save a trace with an automatically generated filename:

- Select **File > Save Results**.

Traces are saved in the `\BuiltInDisk\YBA250\AppData\Results` directory by default, but that can be changed for future save operations by selecting a different path in the **Save Results As** window. Remember that only traces saved within the **BuiltInDisk** folder (or removable storage such as a PC memory card) are stored in non-volatile memory. Traces saved outside the **BuiltInDisk** folder are lost when the NetTek Analyzer Platform is shutdown.

To save a trace with a name and location you specify:

1. Select **File > Save Results As...** The Save As dialog box appears.
2. Enter a name and location for the file and tap **OK**.

---

**NOTE.** *Traces are saved with the settings in effect at the time the trace is saved.*

---


## Displaying a Saved Trace

You can display a previously saved trace for review or comparison with another trace.

To display a saved trace:

1. Select **File > Open**. The Open dialog box appears.
2. Locate the saved trace, tap the name of the trace and then tap **OK**.

---

**NOTE.** *Traces are saved with the settings in effect at the time the trace is saved. When a saved trace is displayed, the stored settings values will be shown for reference, though no actual instrument settings will change. As soon as you press  to return to making new acquisitions, the settings will be restored to what they were before the saved trace was opened.*

---

## Comparing Traces

The YBA250 enables you to compare traces two ways. The first allows you to compare a live trace to a reference trace. The second way compares two saved traces.

### Comparing a Live Trace to a Reference Trace

The YBA250 provides the ability for you to visually compare the current live trace against a reference trace. The reference trace, called Trace 2, can be another current trace or a saved trace.

To display a second trace:

- Select **View >Trace 2**.

or

- Tap the Rotate Traces icon .

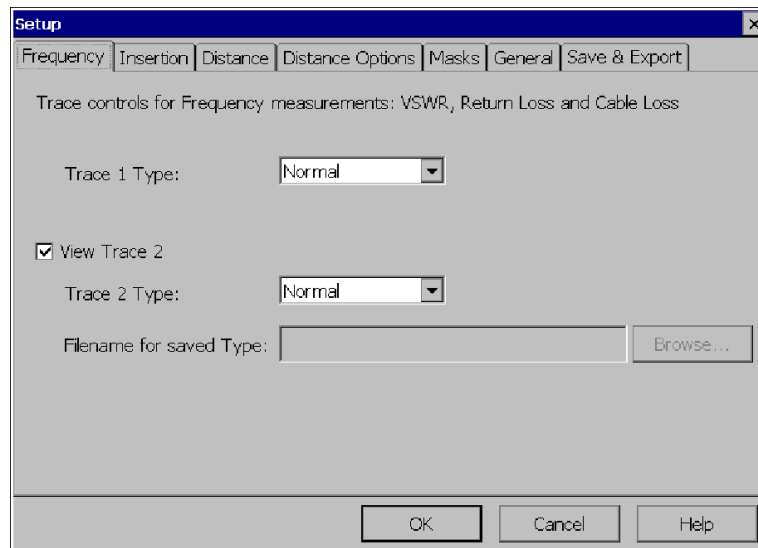
If Trace 2 is not enabled, selecting the Rotate Trace icon enables the Trace 2 display.

### Defining Trace 2

Trace 2 can be a live trace (for example, an averaged display of the latest acquisitions) or a saved trace.

To define Trace 2:

1. Select **View >Define Trace 2....** The Setup window appears when you select the **Frequency**, **Distance**, or **Insertion** tab. See Figure 3-19.



**Figure 3-19: Defining Trace 2**

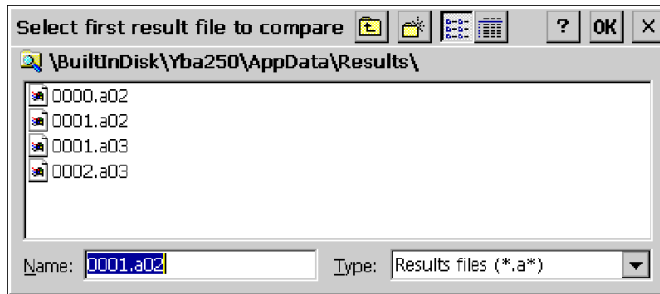
2. By default, Trace 2 is a live trace. You can set the trace type for a live trace. Set the trace type for Trace 2 with the drop-down list. You can choose Normal, Average, Min, Max, or Min/Max.
3. To set Trace 2 to a saved trace, select **Saved:** from the drop-down list. Enter the path to the saved trace in the input box, or tap **Browse**. Select the desired results file from the **Select Saved Result** dialog box and tap **OK**.
4. Tap **OK** to save your changes and close the Setup window.

### Comparing Two Results Files

The YBA250 provides the ability for you to compare two saved results to each other. This would be useful in comparing previous antenna test results.

To compare two saved results:

1. Select **File > Compare Saved...**. The Open dialog appears. See Figure 3-20. For the first result selected, the dialog is labeled **Select first result file to compare**.



**Figure 3-20: Selecting the first result file**

There are four types of results files:

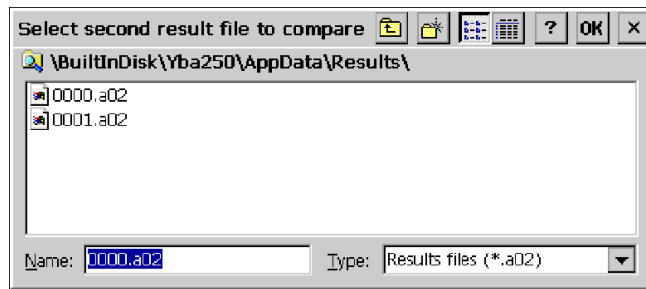
- Return Loss and VSWR results files have a file extension of “a02”.
- Distance to fault results files have a file extension of “a03”.
- Insertion Loss results files have a file extension of “a05”.
- Insertion Gain results files have a file extension of “a06”.

Note that both results file types are displayed for the first file selection.

2. Select the first result file you wish to compare. Tap **OK**.

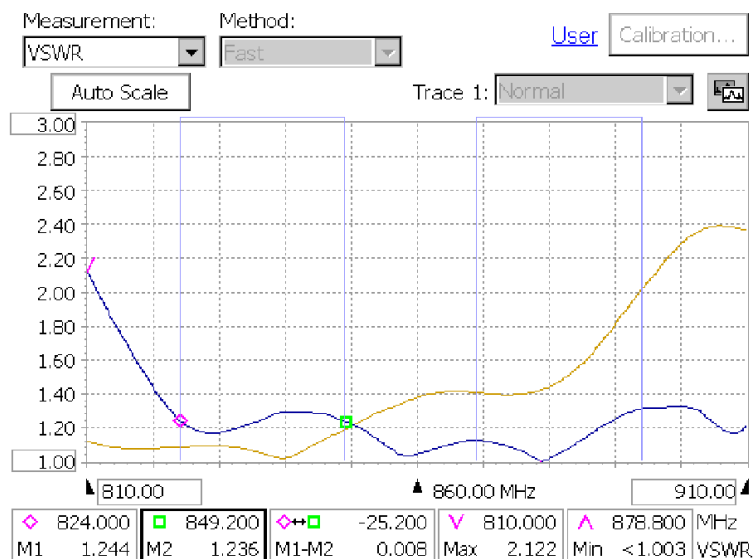
After you select the first result, the Open dialog is displayed again for you to select the second result file. See Figure 3-21. Note the label **Select second result file to compare**.

Note that the only file type available to select are those that match the results file you selected first. If you selected a Return Loss results file in the first dialog (a02 file extension), only Return Loss results files are displayed for you to select as the second file to compare.



**Figure 3-21: Selecting the second result file**

Once you have selected both traces, they are displayed. The two traces are displayed in different colors so that they are easier to compare. See Figure 3-22. You can use markers on the saved traces to compare points on the traces.



**Figure 3-22: Two compared traces**





# Using Markers and Band Edge Cursors

The YBA250 provides a function named Markers that lets you easily take measurements on a displayed trace. Markers can be used to identify the maximum and minimum value on a trace as well as the differences between two user-selectable points on a trace. Another feature, known as Band Edge Cursors, graphically identifies the frequency band for the selected signal standard.

## Displaying Markers

The YBA250 provides markers that let you measure differences between two points of the displayed trace or between two traces. Markers can be used with Return Loss, VSWR, and Insertion Gain/Loss measurements.

To display the markers, select **View > Markers**. Figures 3-23 and 3-24 shows the display with and without markers.

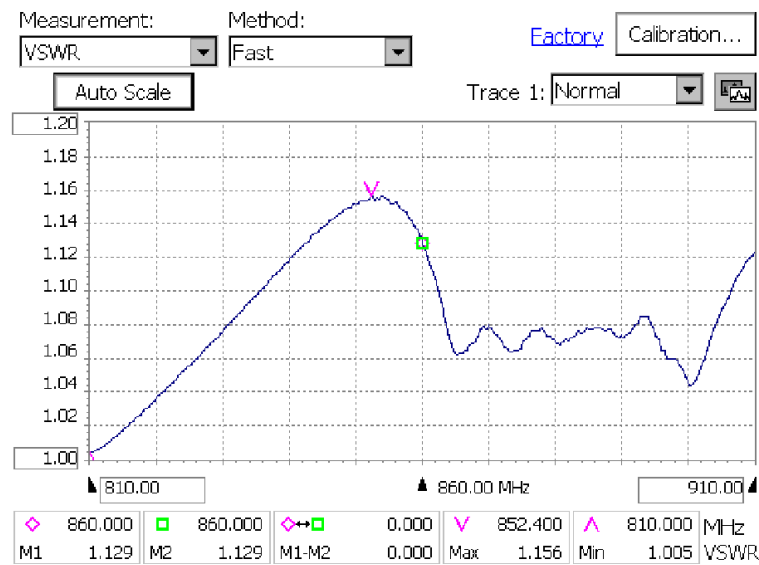
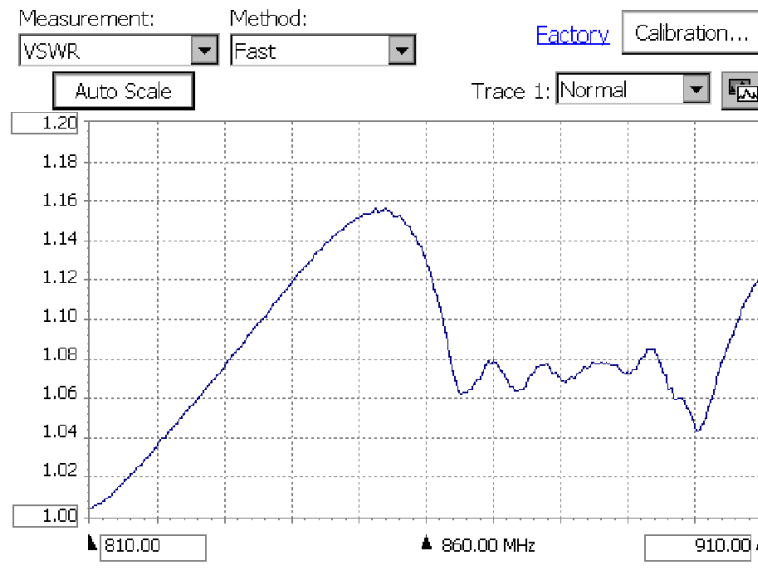


Figure 3-23: Display with markers



**Figure 3-24: Display without markers**

Markers are used to display frequency, Return Loss, Insertion Gain or Loss, and VSWR at specific points on traces. There are five marker readouts: M1, M2, M1-M2, Max, and Min. At the right end of the marker readouts the units for the numeric values are shown (f = frequency, dB = return loss in decibels, VSWR = Voltage Standing Wave Ratio).

The elements of the marker readouts are described in Table 3-3. Refer to the following sample marker readout when reading the table.

◇ 824.000	□ 849.200	◇↔□ -25.200	▲ 839.600	▼ 905.600	MHz
M1 27.058	M2 20.848	M1-M2 6.210	Max 38.172	Min 7.760	db

**Table 3-3: Elements of Marker Readouts**

Element	Location in Readout	Function
Symbol	Top-left	The symbol (diamond, square, arrowhead pointing up or down) on the display associated with the readout.
Name	Bottom-left	The name of the readout: M1, M2, M1-M2, Max or Min.
Frequency	Top-right	The frequency at which the marker is located. On the M1-M2 readout, it is the difference in frequency between M1 and M2.
Measurement	Bottom-right	The measured value at the marker position. If the Measurement is Return Loss or Cable Loss, the readout is in dB. If the Measurement is VSWR, the readout is in VSWR units.

The M1 and M2 markers can be placed on the same trace or on different traces (with Trace 2 enabled). The Max marker (▲ or ▼) indicates the maximum signal level and relevant measurement on any trace. The Min marker (▲ or ▼) indicates the minimum signal level and relevant measurement on its assigned trace. The Max or Min indicator can point in either direction depending on settings, so be sure to look at the indicator in the marker display to determine which marker indicator you are looking at.

The M1-M2 readout (◆↔■) displays the difference in frequency, Return Loss, or VSWR between M1 and M2, depending on the measurement being taken.

To display the Return Loss or VSWR at a specific frequency:

1. Select **View > Markers** if Markers are not already visible.
2. Select the measurement, **Return Loss**, **VSWR** or **Cable Loss**.

3. To place Marker 1:
  - a. Tap the **M1** box. This assigns the knob to Marker 1. Note the readout above the knob changes to **M1**.
  - b. Tap the point on the waveform where you want the marker placed. You can also tap the numeric keypad, next to the knob, to enter the frequency where the marker should be placed or use the knob to change the location of the marker.
  - c. Read the M1 frequency, Return Loss, and VSWR in the M1 readout.
4. To place Marker 2:
  - a. Tap the **M2** box. This assigns the knob to Marker 2. Note the readout above the knob changes to **M2**.
  - b. Tap the point on the waveform where you want the marker placed. You can also tap the numeric keypad, next to the knob, to enter the frequency where the marker should be placed or use the knob to change the location of the marker.
  - c. Read the M2 frequency, Return Loss, and VSWR in the M2 readout.

To place markers on two traces:

1. If it is not already selected, select **Trace 2** from the **View** menu.  
This displays Trace 2 as defined on the Loss tab.
2. From the View menu, select the desired location for the markers.  
See Figure 3-25.



**Figure 3-25: Assigning markers to a trace**

When Trace 2 is enabled, markers can be located as follows:

**Table 3-4: Marker placement**

Menu selection	Location of markers
<b>Marker 1</b>	Assigns M1 to Trace 1, Trace 2 (rotating the trace order does not change the marker assignment), or to the trace assigned to the foreground.
<b>Marker 2</b>	Assigns M2 to Trace 1, Trace 2 (rotating the trace order does not change the marker assignment), or to the trace assigned to the foreground.
<b>Marker Min</b>	Assigns Min to Trace 1, Trace 2 (rotating the trace order does not change the marker assignment), or to the trace assigned to the foreground.
<b>Marker Max</b>	Assigns Min to Trace 1, Trace 2 (rotating the trace order does not change the marker assignment), or to the trace assigned to the foreground.

If Trace 2 is not enabled, all markers are placed on Trace 1.

### Measuring Return Loss or VSWR Between Points on a Single Trace

To measure the difference in Return Loss and VSWR between two points on a single trace:

1. Display the markers by selecting **View>Markers**.
2. Tap the **M1** readout. This assigns the marker to the knob and to the touch screen in the display area.
3. Tap the display where you want to place the marker. You can also use the knob to position the marker.
4. Tap the **M2** readout. This assigns the marker to the knob and to the touch screen in the display area.
5. Tap the display where you want to place the marker. You can also use the knob to position the marker.
6. Read the difference in Return Loss and VSWR in the M1-M2 marker display.

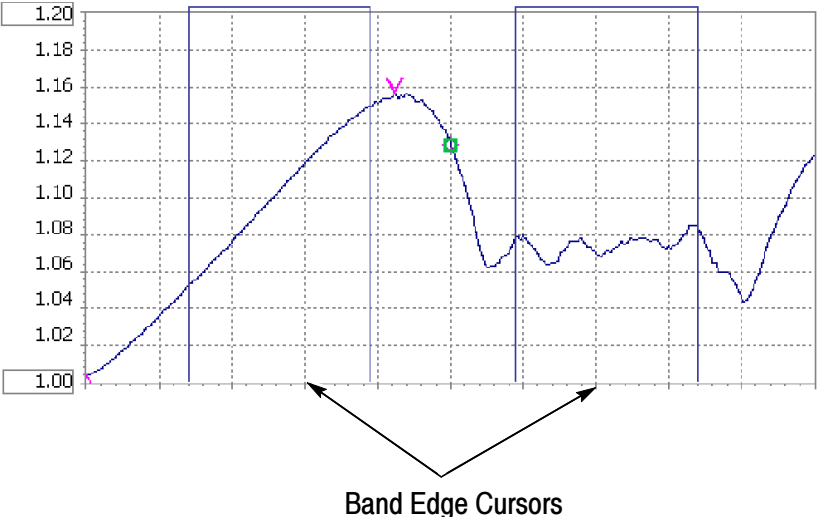
### Measuring Return Loss or VSWR Differences Between Two Traces

When Trace 2 is displayed, you can measure the difference in Return Loss and VSWR between points on two traces:

1. If Trace 2 is not displayed, select **View > Trace 2**.
2. Display the markers by selecting **View > Markers**.
3. Specify the location of the markers by choosing one of the menu selections shown in Table 3-4 from the **View** menu.
4. Tap the **M1** readout. This assigns the marker to the control knob and to the touch screen in the display area.
5. Tap the display where you want to place the marker. You can also use the knob to position the marker.
6. Tap the **M2** readout. This assigns the marker to the knob and to the touch screen in the display area.
7. Tap the display where you want to place the marker. You can also use the knob to position the marker.
8. Read the difference in frequency and level at the right side of the marker display.

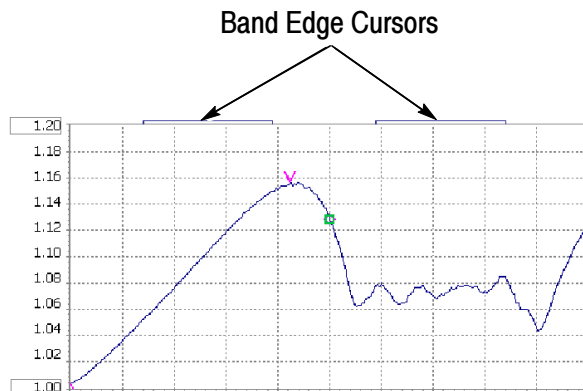
## Band Edge Cursors

The Band Edge cursors identify the start and stop frequencies for the transmit and receive bands of the selected standard. See Figure 3-26.



**Figure 3-26: Band Edge Cursor displayed**

There are two parts to the cursors; the main part appears in the main trace display and the second part appears along the top edge of the graph. The portion in the main display can be switched off, but the part along the top edge of the graph is always visible. See Figure 3-27.



**Figure 3-27: Band Edge Cursors always visible**

To turn on the display of Band Edge Cursors:

- Select **View > Band Edge Cursor** so that it is checked.

To turn off the display of Band Edge Cursors:

- Select **View > Band Edge Cursor** so that it is *not* checked.


## Markers and Mask Testing

Markers are available when mask testing is enabled. There are two things to note about markers when mask testing is enabled:

- Markers cannot be placed on a mask.
- When mask testing is enabled, the marker difference readout displays the difference between the marker and the mask.



# Mask Testing

Mask testing is used to determine if Impedance measurements (Return Loss, VSWR) or Insertion Gain/Loss measurements exceed specified levels. The YBA250 can perform several actions when an input signal exceeds limits defined by a mask. The default action is to display an icon  to the left of the graph (which cannot be switched off) and sound a beep (which can be switched off). A measurement trace that exceeds limits can trigger additional actions such as pausing the display, exporting a screen and saving results to a file.

## The Mask Maker Window

Masks are created with the Mask Maker utility. To display the mask Maker window, select **Tools > Mask Maker**. See Figure 3-28.

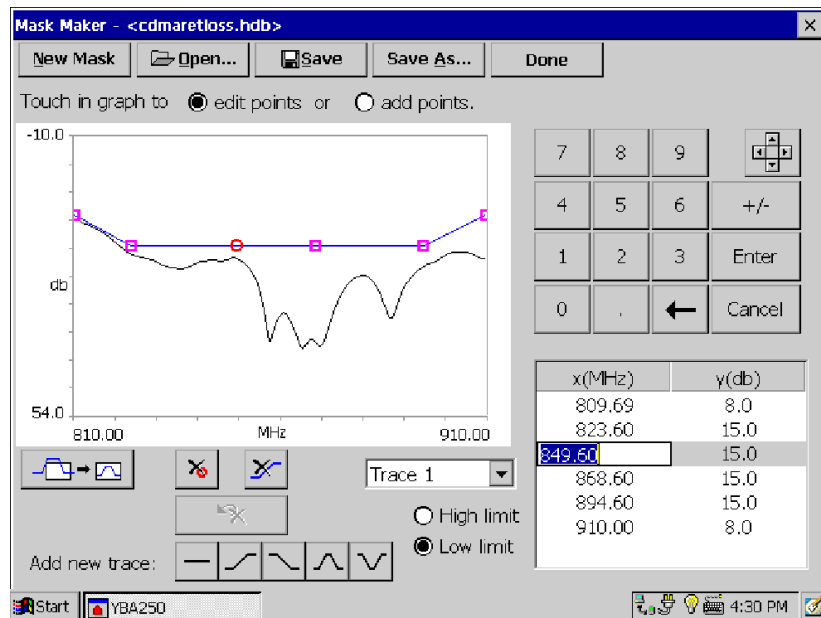



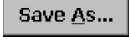




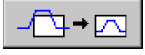


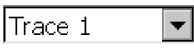








Figure 3-28: The Mask Maker utility

**Table 3-5: Mask maker buttons and icons**

Button/Icon	Description
	Creates a new mask.
	Opens an existing mask for editing.
	Saves changes to the current mask.
	Save changes to the current mask with a different name or to a different location.
	Cursor arrows button. Tap to display the cursor arrows.
	Cursor arrow. Tap to move the selected point in the desired direction.
	Keypad button. Tap to display the numeric keypad.
	Done. Tap to exit the Mask Maker utility.
	Rescale button. Tap to scale the current mask so all points are visible in the graph.
	Delete Point. Tap to delete the selected point from the mask.
	Delete Trace. Tap to delete the selected trace from the mask.
	Trace Select list box. Tap to select which trace to edit.
	Undo Delete. Tap to undo the last Delete Point or Delete Trace action.
	Flat Trace button. Tap to add a 2-point trace to the mask.
	Rising Trace button. Tap to add a 4-point trace to the mask.
	Falling Trace button. Tap to add a 4-point trace to the mask.



**Table 3-5: Mask maker buttons and icons (Cont.)**

Button/Icon	Description
	Positive Pulse button. Tap to add a 6-point trace to the mask.
	Negative Trace button. Tap to add a 6-point trace to the mask.

## Using the Mask Maker

### Defining Mask Frequency Range and Trace

Before creating a mask, you must define the mask start and stop frequencies.

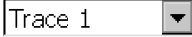
1. Tap the measurement button for which you want to create a mask ( Impedance  or Insertion Gain/Loss  ).
2. Select the measurement for which you want to create a mask from the **Measurement** drop-down list.
3. Set the frequency range of the display by selecting the signal standard, band (Forward/Reverse/Both), selecting the channel, and/or by setting the Start and Stop frequencies.
4. If possible, use a known signal input to create a measurement trace with the correct wave shape. You can use this as the reference trace for creating a mask.

### Opening the Mask Maker

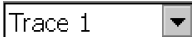

From the **Tools** menu, select **Mask Maker** to open the Mask Maker window. The Mask Maker trace window shows the current measurement trace and one of two mask types:

- If Mask testing was already defined (enabled), the selected mask is displayed in the Mask Maker window.
- If Mask testing was not enabled, a new default mask (the pulse-shaped trace) is displayed.

### Adding a Point to a Trace

1. If more than one trace is displayed, select the desired trace by tapping on it or tap the down arrow  on the trace selector and select the desired trace from the list.
2. Tap the **add points** option button above the graph.
3. Tap the graph at the desired point.

### Moving a Trace Point

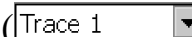

1. If more than one trace is displayed, select the desired trace by tapping on it or tap the down arrow  on the trace selector and select the desired trace from the list.
2. Tap the **edit points** button above the graph.
3. To move a point, use any of the following methods:
  - Touch the desired point and drag it to the new location.
  - Touch the desired point, then tap the cursor arrows icons  to move the selected point in the desired direction.
  - Tap the value to change in the table (the number in either the x column or the y column). Then tap the keypad icon to display the keypad and enter a new value.

---

**NOTE.** *If you want to adjust a vertical value, you can tap the desired point in the graph and its vertical value is selected in the table.*

---

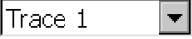
### Deleting a Point from a Trace

1. If more than one trace is displayed, tap the down arrow  on the trace selector. Select the desired trace from the list.
2. Tap the point to be deleted so it is selected (point indicator changes to a circle).
3. Tap the delete point button .


### Adding a Trace to a Mask

To add a trace to the mask, tap one of the **Add new trace** buttons. A trace of the selected shape will appear on the graph.

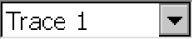
### Deleting a Trace from a Mask

1. Tap the down arrow  on the trace selector.
2. Select the trace to delete from the list.

If the **edit points** option button is selected, you can also select a trace by touching it near one of its points.

3. Tap the delete trace button .

### Setting Mask Violation Limits

1. Tap the down arrow  on the trace selector.
2. Select the desired trace from the list.
3. Tap **High limit** to indicate a violation when a signal trace has a value higher than the mask trace.
4. Tap **Low limit** to indicate a violation when a signal trace has a value lower than the mask trace.

### Saving a Mask


1. Tap the **Save** button. If this is a new mask that has not been saved before, the instrument opens the **Save As** window.
2. Enter the mask file name in the **Name** field.
3. Tap **OK**.
4. To save a mask to a different file name, tap the **Save As...** button and enter the new mask file name.




### Loading a Mask

You can load a saved mask to use for mask testing or as the starting point for creating a new mask.

1. Tap the **Open..** button to display the **Open** window.
2. Select the mask file to load from the displayed list.
3. Tap **OK**.

## Mask Maker Guidelines

- A mask consists of one or more traces, with each trace containing at least one point.
- You can add as many points as you want to a mask trace.
- You can place as many traces on a mask as you want.
- The selected point on a mask trace is indicated by a circle. Other points are indicated by a square.
- A mask trace does not have to cover the entire test frequency range. Signal points at frequencies that don't have associated mask points are not tested for violations. This allows you to check only those parts of the signal that are critical to your specific measurement, for example the attenuation in adjacent channels.
- If you place points outside the visible area of the graph, tap the rescale button  to bring all points into view.

- If you accidentally delete a point or a trace, you can undo the last delete action by tapping the Undo Delete button .
- Tap the numeric keypad  to switch to the numeric keypad from the cursor keys.
- Tap the cursors keys button  to switch to the cursor keys from the numeric keypad.

## Defining (Selecting) a Mask for Testing

Before you can perform a mask test, you must define (select) the mask to be used. Defining a mask specifies the mask to be used for mask testing. If you have not yet created a mask, see *Using the Mask Maker* on page 3-53.

To define a mask:

1. Select **View > Define Mask**. This displays the **Masks** tab of the Setup window.
2. Decide which type of mask you want to use (Return Loss, VSWR, Cable Loss, Insertion Gain, or Insertion Loss) and tap the appropriate **Browse** button to display the **Select mask file** window.
3. Select the mask you want to use for your mask test, and then tap **OK**.
4. Tap the **Enable Mask Testing** check box.
5. To have the YBA250 perform an action (in addition to displaying the violation icon) when a mask violation occurs, tap the appropriate check box.
  - Tap **Beep** to sound an alarm when a violation occurs (this is selected by default).
  - Tap **Pause** to cause the YBA250 to pause when a violation occurs.


- Tap **Export Screen** to save the screen as a graphics file when a violation occurs.
- Tap **Save Results** to cause the YBA250 to save the measurements results to a file when a violation occurs.

6. Tap **OK** to accept your changes.

Mask testing is enabled with the defined mask displayed.

### Performing a Mask Test

To perform a mask test, Select **View > Mask** so that there is a check mark next to **Mask**.

The defined mask is displayed. If the trace exceeds the mask, the violation icon  will appear on the left side of the spectrum graph and the violated mask trace will change color (the specific color depends on the selected color scheme).

---

**NOTE.** *A mask trace does not have to cover the entire test frequency range. Signal points at frequencies that don't have associated mask points are not tested for violations. This allows you to check only those parts of the signal that are critical to your specific measurement, for example the attenuation in adjacent channels.*

---

### Mask Testing and Markers

When Mask testing is enabled, the marker difference readout displays the difference between the marker and the mask. A positive value indicates a “pass.” A negative value indicates a “fail.” A positive value for an upper limit means the signal level is lower than the mask level at the marker frequency. A negative value means the signal level is higher than the mask level, thus violating the mask. For a lower limit mask, a positive difference means that the signal level is higher than the mask level and a negative difference means that the signal level is lower than the mask level.



The YBA250 calculates the difference between the marker and the mask using the preceding rule to determine the sign of the difference. The YBA250 calculates the difference between the signal level and the level of each of the traces in the mask. The YBA250 then displays the worst case difference between the signal level and all the traces in the mask.

For example, suppose there are two traces in a mask: one is an upper limit and the other is a lower limit. The upper limit mask trace level at the marker frequency is 0 dB, the signal level is -10 dB, and the lower limit mask trace level is -30 dB. Thus, the difference between the upper limit and the signal is 10 dB and the difference between the signal level and the lower limit is 20 dB. The YBA250 will display the M1 marker difference as 10 dB because the signal is closer to the upper limit than it is to the lower limit.

Alternately, assume that the upper limit mask trace level is 0 dB, the signal level is -30 dB, and the lower limit mask trace level is -25 dB. Thus, the difference between the upper limit and the signal is 30 dB and the difference between the signal level and the lower limit is -5 dB. The YBA250 will display the M1 marker difference as -5 dB because the signal is closer to the lower limit than it is to the upper limit. And because the signal is lower than the lower limit, the signal fails the mask test.

If the YBA250 displays dashes (----) for the marker difference instead of a number, it means that there is no mask defined at the marker frequency.



# Saving and Recalling Results, Screens, and Setups

The YBA250 can save measurement results and screens (screen captures) for later recall or for transfer to a PC. You can also set up the YBA250 for specific tests and save the setup to a file for later recall, saving you time when making measurements in the field.



When saving files, it is important to save the files in the correct location. There are two types of memory in the YBA250. Volatile memory is memory that loses data when power is removed. Non-volatile memory retains data when power is removed. When the YBA250 is powered down, any data stored in volatile memory is lost. Only data stored in non-volatile memory is retained when the YBA250 is powered down. On the YBA250, the **BuiltInDisk** folder (and associated sub-folders) is the only folder maintained in non-volatile memory.

When saving results, screens, or setups, be sure to save them to a folder located within the BuiltInDisk folder. The default folder for saved results is \BuiltInDisk\YBA250\AppData\Results. The default folder for saved screens is \BuiltInDisk\YBA250\AppData\Results. The default folder for saved setups is \BuiltInDisk\YBA250\AppData\Settings. Because these locations are all located within the BuiltInDisk directory, any data saved there is maintained after the NetTek Analyzer Platform is powered down.

## Saving Measurement Results

The YBA250 enables you to save a measurement result to a file for later recall. Saving measurement results is meant for use in reproducing a display at a later time. When results are recalled, they appear in the display just as they did when saved. To use measurement data results in another program for analysis or generating a report, use the **Export Results** function; see page 3-64.

To save measurement results:

1. Take the measurement you want to save.
2. Select **File > Save Results**. (Save Results appears only when the Measure window is selected; Save Trace appears when the Spectrum and Interference windows are selected.)
3. Select the folder where you want to save the results.
4. Type a name for the file. Tap  in the taskbar, to display the soft keyboard. Tap  again to hide the keyboard when you are finished.
5. Tap **OK** to save the file.

### What is Saved in a Measurement Results File

The following information is saved in the results file for each included measurement:

- Name of the measurement
- Measurement results and units
- Time and date of the measurement

Additional information saved in a results file includes:

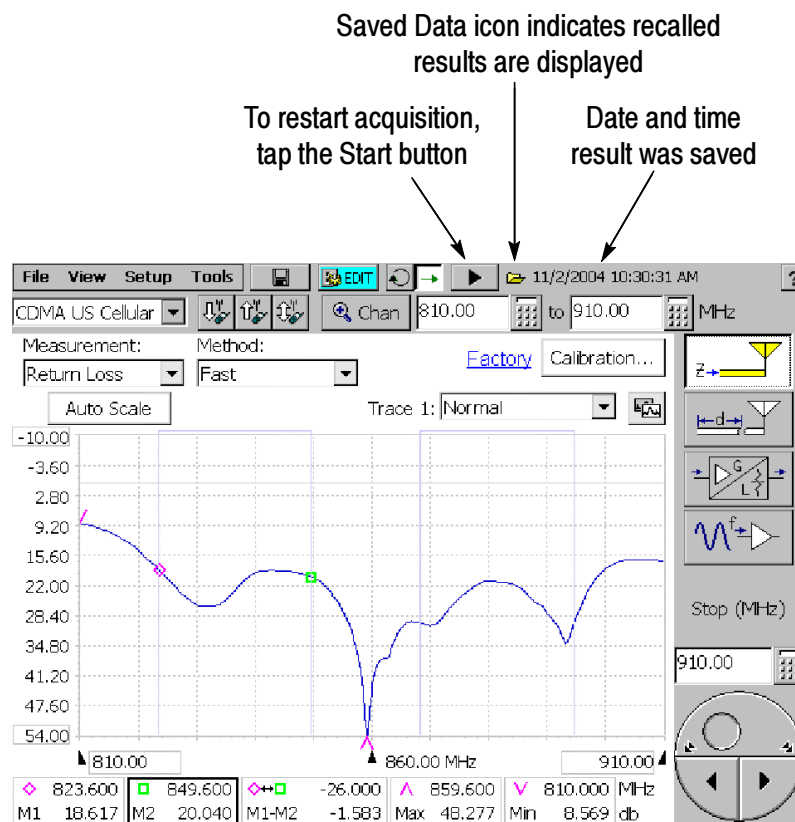
- Technician name
- User notes
- Setup information that is visible in the results display
- Error information (if errors were present)

## Recalling Measurement Results


You can recall saved measurement results for display. When saved measurement results are displayed, the display appears just as it did when the measurement was saved except for the status area of the control bar.

To recall measurement results for display:

1. Select **File > Open**.
2. Locate the directory that contains the measurement results file (the default is \BuiltInDisk\YBA250\AppData\Results).
3. Select the results file to recall and tap **OK**. The instrument displays the saved results.



**Figure 3-29: Example of a recalled results display**

4. To restart measurements, tap the Play button .

When a recalled results file is displayed, the Saved Data icon is displayed at the top of the screen, next to the time and date the file was saved.

## Exporting Measurement Results

The YBA250 can save measurement results in a file for use in other applications, such as Microsoft Excel. The YBA250 exports files as tab-separated or comma-separated files. Files that use tabs to separate data fields are saved with a “txt” extension. Files that use commas to separate data fields are saved with a “csv” extension.

To export measurement results:

1. Select **File > Export Results**.
2. Select a file format from the Type list.
3. Enter a name for the file.
4. Choose the location where the file should be saved.
5. Tap **OK** to save the file.

Figure 3-30 shows an exported results file.

Name	Value	Units	Pass/Fail
Measurement Name	Frequency		
Timestamp	10/3/02 7:20:31 PM		
Calibration in use	Factory		
Cal set name	Factory cal set		
Calibration timestamp	1/10/02 5:30:12 PM		
Technician	Trip Tucker		
Note for saved results	test of NX-01 primary antenna		
Message			
Output power	High		
Start Freq (Hz)	25000000		
Stop Freq (Hz)	2500000000		
Vert Scale Min (dB)	-10		
Vert Scale Max (dB)	40		

Trace 1 mode	Normal
Trace 2 on	False
Trace 2 mode	Normal
Mask test enabled	False
Mask Filename	\\BuiltInDisk\YBA250\AppData\Results\r\mask1.hdb
Mask Limit Test	Pass
Measurement	Return Loss
Method	Fast

Trace 1 return loss data	Trace 1 VSWR data
0.014	99.010
0.023	99.010
0.029	99.010...

**Figure 3-30: Sample Exported Results file**

---

**NOTE.** *The Technician name and User notes are entered from the Save & Export page of the Setup dialog; see page 2-58.*

---

## Exporting a Screen

The YBA250 can export an image of the screen for use in other programs such as Microsoft Word. An exported screen is a graphic image of the YBA250 display. A screen can be saved in three formats: BMP, JPEG and PNG. An exported screen cannot be displayed by the YBA250, it can be viewed only by a program that can display graphic images.

To export a screen image:

1. Select **File > Export Screen As....**
2. Select the image format from the **Type** list.
3. Enter a name for the file.
4. Choose the location where the file should be saved.
5. Tap **OK** to save the file.

## Differences Between Exported Screens and Results

Although an exported screen and an exported results file might seem as though they are the same thing, they are significantly different. You can think of an exported screen as a photograph of the YBA250 display. A saved or exported results file contains information about the displayed signal. Table 3-6 shows the differences between an exported screen and a trace.

**Table 3-6: Differences between exported screens and traces**

File type	Menu command	Read by other programs	File format
Exported Screen	Export Screen	Yes	BMP, JPEG PNG
	Export Screen As...	Yes	BMP, JPEG PNG
Saved Results	Save Results	No	binary <sup>1</sup>
	Save Results As...	No	binary <sup>1</sup>
Exported Results	Export Results As...	Yes	tab or comma-separated text

<sup>1</sup>Binary files can be read only by the YBA250



### Exported Screen File Formats

BMP is an uncompressed format and uses a lot of space, but maintains sharp images. JPEG is a compressed format and uses far less space than BMP, but can blur lines and text. PNG is a compressed format and maintains sharp lines and text. Table 3-7 compares the relative features of each of the export file formats.

**Table 3-7: Comparison of file formats for exporting screens**

Format	Export speed	File Size	Quality
BMP	Medium	Large	Very Good
JPEG	Very Slow	Medium	Medium/Poor
PNG	Fast	Small	Good

An exported results file contains information about the YBA250 settings and data that represents the trace. Figure 3-31 shows an example of an exported trace saved as a tab-separated text file. The numbers at the end (following “Trace 1 data”) represent the data points of the trace on the display. To save space, only a few numbers are shown in this example.

Name	Value	Units	Pass/Fail
Measurement Name	Frequency		
Timestamp	10/3/02 7:20:31 PM		
Calibration in use	Factory		
Cal set name	Factory cal set		
Calibration timestamp	1/10/02 5:30:12 PM		
Technician	Trip Tucker		
Note for saved results	test of NX-01 primary antenna		
Message			
Output power	High		
Start Freq (Hz)	25000000		
Stop Freq (Hz)	2500000000		
Vert Scale Min (dB)	-10		
Vert Scale Max (dB)	40		
Trace 1 mode	Normal		
Trace 2 on	False		
Trace 2 mode	Normal		
Mask test enabled	False		
Mask Filename	\BuiltInDisk\YBA250\AppData\Results\rlmask1.hdb		
Mask Limit Test	Pass		
Measurement	Return Loss		
Method	Fast		
Trace 1 return loss data	Trace 1 VSWR data		
0.014	99.010		
0.023	99.010		
0.029	99.010...		

**Figure 3-31: Example of an Exported Results file**

## Saving Setups

The YBA250 can save its settings in Setup files for later recall. Recalling a saved setup changes the YBA250 settings to match those in the saved setup. Using saved setups minimizes your setup time in the field and helps to ensure more consistent measurement results. For example, you could save a setup for measuring return loss on a specific frequency band.

The saved setup contains the measurement settings as well as all other instrument control settings. Once the setup is saved, it can be copied to other YBA250 instruments to save setup time in the field.

To save YBA250 setups:

1. Set all the YBA250 settings the way you want them.
2. Select **Setup > Save...**
3. Enter a name for the file.
4. Choose the location where the file should be saved (the default is \BuiltInDisk\YBA250\AppData\Settings).
5. Tap **OK** to save the setup file.

### Recalling Setups

Recalling a saved setup changes the YBA250 settings to match those in the saved setup file.

To recall setups:

1. To recall a setup, select **Setup > Open...**
2. Locate the directory that contains the setup file (the default is \BuiltInDisk\YBA250\AppData\Settings).
3. Select the setup file to recall and tap **OK**.

## Customizing the Setup menu

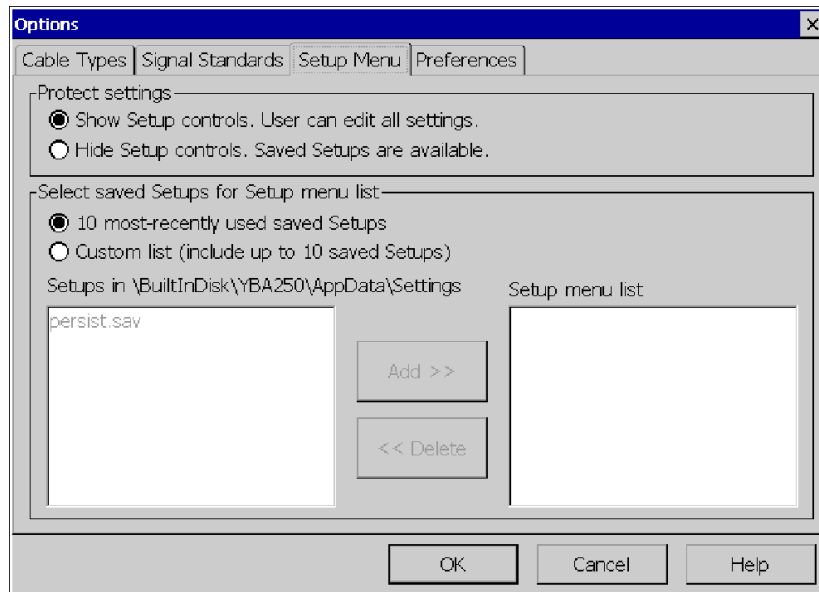
The YBA250 allows you to customize the Setup menu to include a list of standard setups and to prevent accidental changes to existing setup files.

### Preventing Changes to Saved Setups

The YBA250 enables you to hide setup controls so that accidental changes to saved setups cannot occur.


To hide setup controls:

1. Select **Tools > Options...** .
2. Select the **Setup Menu** tab. See Figure 3-32.



**Figure 3-32: Setup menu controls**

3. To prevent a user from changing saved setups, select **Hide Setup controls**.
4. Tap **OK** to save the **Setup Menu** changes.

When **Hide Setup controls** is selected, the Edit button changes to the Open button. Tapping the **Open** button  displays the Open dialog box instead of the Setup window. This allows the user to select a saved setup for recall, but not to edit any settings or save any setups. Additionally, when **Hide Setup controls** is selected, the **Setup > Edit** and **Setup > Save** menu items are disabled.

### Enabling Changes to Saved Setups

If setup controls have been hidden, you cannot create new setup files. You must show setup controls so you can create new setup files.

To show setup controls:

1. Select **Tools > Options...** .
2. Select the **Setup Menu** tab. See Figure 3-32.
3. Select **Show Setup Controls**.

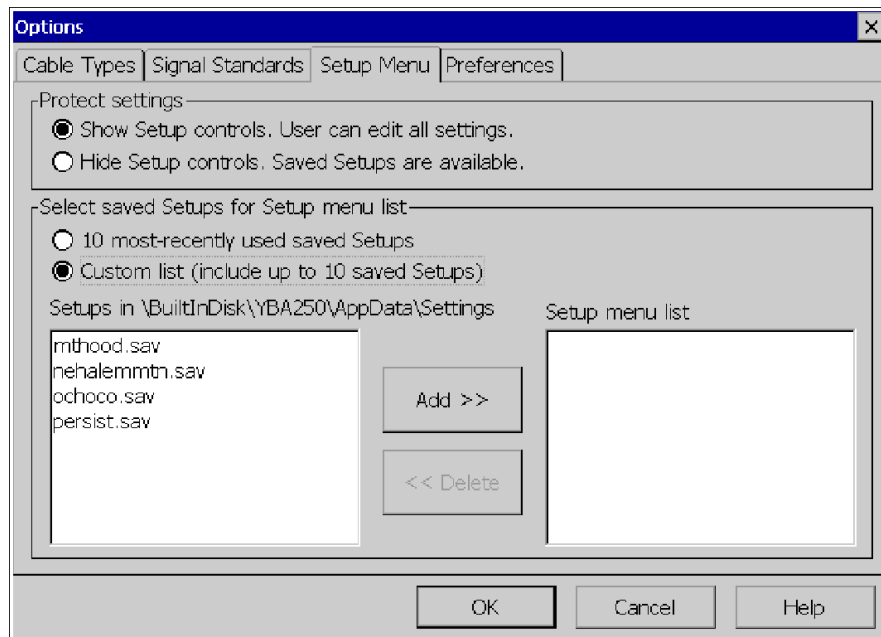
Once setup controls are visible, you can create new setup files.

### Specifying the List of Saved Setups

The YBA250 enables you to specify the list of saved setups that appears in the Setup menu. You can choose to either list the 10 most recently used saved setups or display a custom list of setups. A custom list of saved setups provides consistent and quick access to a standard group of setup files.

To specify the list of setups in the Setup menu:

1. Copy or move all the setup files you want to list in the Setup menu to the `\BuiltInDisk\YBA250\AppData\Settings` folder. The YBA250 will allow you to select only setups located in the `\BuiltInDisk\YBA250\AppData\Settings` folder for display in the Setup menu.
2. Select **Tools > Options...** .
3. Select the **Setup Menu** tab. See Figure 3-33.
4. To display the 10 most recently used saved setups in the Setup menu, select **10 most-recently used saved Setups**.



**Figure 3-33: Specifying the List of Setups**

5. To display only a selected list of saved setups, select **Custom List**.
  - a. Select a setup from the list on the left and tap **Add>>** to add the selected setup to the Setup menu.
  - b. Select additional setups until you have selected all the setups you want in the Setup menu. (You can select up to 10 setups to appear in the Setup menu.)

To remove a setup from the Setup menu list, select the setup to remove from the Setup menu List window and tap **<<Delete**.
6. Once you have selected all the setups you want listed in the Setup menu, tap **OK**.



# Appendices





# Appendix A: Specifications

This section lists the electrical, environmental, and physical specifications of the YBA250 Antenna and Transmission Line Analyzer. All specifications are guaranteed unless labeled “typical”. Typical specifications are provided for your convenience and are not guaranteed.

The specifications in this section apply to the YBA250 module, unless otherwise specified. For NetTek Analyzer Platform specifications, please refer to the NetTek Analyzer Platform User Manual.

**Table A-1: Measurement characteristics**

<b>Frequency Characteristic</b>	<b>Description</b>
Frequency Range	25 MHz - 2500 MHz
Frequency Accuracy	± 75 ppm Accuracy specifications guaranteed after 5 minute warm-up period.
Frequency Resolution	100 kHz
<b>Return Loss Characteristics</b>	<b>Description</b>
Return Loss Measurement	Return loss is defined as: $20 \log (   \text{Reflection Coefficient}   )$ Where: $\text{Reflection Coefficient} = \frac{(Z - Z_0)}{(Z + Z_0)}$ and: Z is the measured impedance Z <sub>0</sub> is the YBA250 characteristic impedance
Return Loss Display Range	0 to 54.00 dB
Return Loss Resolution	0.01 dB

**Table A-1: Measurement characteristics (Cont.)**

<b>Return Loss Characteristics</b>	<b>Description</b>
Return Loss Accuracy with Factory Calibration	≤ 1 dB typical (from 0 to 40 °C up to 2 GHz, measuring a 17 dB return loss).
Return Loss Accuracy with User Calibration	$< 0.05 +   20 \log ( 1 \pm 10^{\left( \frac{RL_{REL}}{20} \right)} )   \text{ dB}$ <p>Where <math>RL_{REL}</math> is defined as: (measured return loss value - calibration standard return loss value)</p> <p>Return loss is dependent on the quality of the calibration standards used. Tektronix recommends the use of the YBAC1 Calibration Kit for the most accurate results.</p>
<b>Voltage Standing Wave Ratio (VSWR) Characteristics</b>	<b>Description</b>
Voltage Standing Wave Ratio (VSWR) Measurement	<p>VSWR is defined as:</p> $\frac{1 +   \text{Reflection Coefficient}  }{1 -   \text{Reflection Coefficient}  }$
VSWR Display Range	1.00 to 65.00
VSWR Display Resolution	0.01
<b>Cable Insertion Loss (One Port) Characteristics</b>	<b>Description</b>
Cable Insertion Loss Measurement Method	An estimation of the cable's insertion loss is made by measuring its Return Loss with the cable's other terminals open or shorted. The estimated Cable Insertion Loss is one-half of the Return Loss at any given frequency.
Cable Insertion Loss Resolution	0.01 dB
Cable Insertion Loss Display Range	0.0 to 27.00 dB

**Table A- 1: Measurement characteristics (Cont.)**

<b>Distance to Fault (DTF) Characteristics</b>	<b>Description</b>
Distance to Fault Measurement	The YBA250 displays Return Loss versus distance or VSWR versus distance.
Distance to Fault Range	Coaxial lines up to $1486 \bullet V_{rel}$ meters in length can be tested. $V_{rel}$ is the relative signal velocity in the coaxial line with respect to the speed of light.
Distance to Fault Resolution	<p>Incremental distances of <math>\leq 6.1 \bullet V_{rel}</math> centimeters at a distance of <math>200 \bullet V_{rel}</math> meters can be resolved.</p> <p>This resolution is available only in situations where the instrument's entire frequency range can be used to make the measurement. If a device with a narrow bandwidth limits the system under test, the distance resolution is limited by physics to:</p> $1.5 (10^8) \left[ \frac{V_{REL}}{\Delta F} \right]$ <p>where <math>\Delta F</math> is the frequency range the measurements are made over. <math>V_{rel}</math> is the relative signal velocity in the coaxial line with respect to the speed of light.</p>
Distance to Fault Amplitude Correction	The measured value of a broad band discontinuity is corrected using information based on the known characteristics of the cable being tested.
<b>Insertion Loss Characteristics</b>	<b>Description</b>
Measurement	<p>The dBm power measured without the device in the signal path minus the dBm power measured with the device in the signal path. The Normalization measurement provides the power measurement without the device under test in the signal path.</p> <p>The test signal is generated by the YBA250. The test signal is measured by the YBT250 under control of the YBA250 application.</p>
Frequency Range	30 to 2500 MHz
Display Range	+100 dB to -100 dB

**Table A-1: Measurement characteristics (Cont.)**

<b>Insertion Loss Characteristics</b>	<b>Description</b>
Resolution	0.01 dB
Accuracy, Typical (Average Insertion Loss measurement)	<p>1.0 dB for components with VSWR &lt; 1.5:1                      0.5 dB for components with VSWR &lt; 1.15:1</p> <p>Reflections in the signal path create standing waves when operating at a fixed frequency. When frequency is swept, these reflections cause ripple in the measurement waveform.</p> <p>The average loss measurement indicates the average loss over the displayed frequency range.</p>
<b>Insertion Gain Characteristics</b>	<b>Description</b>
Measurement	<p>The dBm power measured with the device in the signal path minus the dBm power measured with the device removed from the signal path. The Normalization measurement provides the power measurement without the device under test in the signal path.</p> <p>The test signal is generated by the YBA250. The test signal is measured by the YBT250 under control of the YBA250 application.</p>
Frequency Range	30 to 2500 MHz
Display Range	+100 dB to -100 dB
Resolution	0.01 dB
Accuracy, Typical (Average Insertion Gain measurement)	<p>1.0 dB for components with VSWR &lt; 1.5:1</p> <p>When using a bias-T with voltage above 12 Volts, avoid exceeding the voltage rating of attenuators in the signal path. This risk is present when the bias-T is part of the normalization signal path without the amplifier.</p> <p>Reflections in the signal path create standing waves when operating at a fixed frequency. When frequency is swept, these reflections cause ripple in the measurement waveform. The average insertion gain reading indicates the average gain over the frequency range displayed.</p>

**Table A-2: Measurement port characteristics**

<b>Impedance Test Port</b>	<b>Description</b>
Connector	Type-N Female.
Nominal Impedance	50 $\Omega$
Impedance Port Match	$\geq$ 9.5 dB return loss
Output signal Amplitude	+3 dBm, -20 dBm
Maximum Applied Signal Amplitude	$\leq$ +20 dBm without damage
Maximum Interfering Signal Amplitude	+11 dBm
Working Voltage	40 V (DC + peak AC)

**Table A-3: Calibration characteristics**

<b>Characteristic</b>	<b>Description</b>
Maximum Cable Length for Calibration	10.0 feet (3.05 meters)
Calibration Temperature Range	User calibration is accurate within $\pm 10$ °C (18 °F) from the temperature at which the calibration was performed.
Warm-up time	All specifications are valid after a 5 minute warm-up period.

**Table A-4: Environmental characteristics**

Characteristic	Description
Temperature Range	
Operating	0 °C to +50 °C
Nonoperating	-40 °C to +60 °C Test method per Military Standard MIL-PRF-28800F (Class 2), excluding the +23 °C procedure in Test <c> and using the test limits indicated above.
Humidity	
Operating	5% to 95% Relative Humidity (RH), noncondensing: up to +30 °C  5% to 45% Relative Humidity (RH), noncondensing: +30 °C up to +50 °C
Nonoperating	5% to 95% Relative Humidity (RH), noncondensing: up to +30 °C  5% to 45% Relative Humidity (RH), noncondensing: +30 °C up to +50 °C  Test method per Military Standard MIL-PRF-28800F (Class 2), excluding Test Level <b>, dwelling for 11 hours minimum at Test Levels <a> and <c>, and using the test limits indicated above.
Altitude	
Operating	Up to 4,600 m (15,092 ft.)
Nonoperating	Up to 15,240 m (50,000 ft.)

**Table A-5: Physical characteristics**

<b>Characteristic</b>	<b>Description</b>
Dimensions	Height: 24.1 cm. (9.50 in) Width: 18.75 cm. (7.38 in) Depth: 3.18 cm. (1.25 in)
Weight	≤1 kg (2.2 lbs) YBA250 module only 4.1 kg (9 lbs), NetTek Analyzer Platform only, with one battery

**Table A-6: Miscellaneous characteristics**

<b>Characteristic</b>	<b>Description</b>
Battery Life	
One battery installed	2 hours with measurements active 4 hours in suspend mode
Two batteries installed	4 hours with measurements active 8 hours in suspend mode
Recommended Calibration Interval	1 year

**Table A-7: Safety compliance**

Category	Standards or description
Safety Compliance	<p>ISA S82.02.01 Safety Standard for Electrical and Electronic Test, Measuring, Controlling, and Related Equipment.</p> <p>CAN/CSA C22.2 No. 1010.1 Safety Requirements for Electrical Equipment for Measurement, Control, and Laboratory Use.</p> <p>EN 61010-1 Safety Requirements for Electrical Equipment for Measurement, Control, and Laboratory Use.</p> <p>IEC61010-1 Safety Requirements for Electrical Equipment for Measurement, Control, and Laboratory Use.</p> <p>UL3111-1 Standard for Electrical Measuring and Test Equipment.</p>



**Table A-8: Electromagnetic compatibility (EMC)**

Category	Standards or description
EC Declaration of Conformity - EMC	Meets the intent of Directive 89/336/EEC for Electromagnetic Compatibility. Compliances were demonstrated using EN 61326:1997 EMC Product Family Standard for Electrical Equipment for Measurement, Control and Laboratory use.
	<b>Emissions<sup>1</sup></b>
	EN 61326 Class A Radiated and Conducted Emissions
	EN 61000-3-2 (A14) Conducted Power Line Harmonic Current EN 61000-3-3 Voltage Fluctuations and Flicker
	<b>Immunity<sup>1, 2</sup></b>
	IEC 61000-4-2 Electrostatic Discharge Immunity, Performance Criterion "B"
	IEC 61000-4-3 <sup>3</sup> Radiated RF Electromagnetic Field Immunity, Performance Criterion "A"
	IEC 61000-4-4 Electrical Fast Transient/Burst Immunity Performance Criterion "B"
	IEC 61000-4-5 Power Line Surge Immunity, Performance Criterion "B"
	IEC 61000-4-6 <sup>4</sup> Conducted RF Immunity, Performance Criterion "A"
	IEC 61000-4-11 Voltage Dips and Short Interruptions Immunity, Performance Criterion "B"

**Table A-8: Electromagnetic compatibility (EMC) (cont.)**

Category	Standards or description
Australia/New Zealand Declaration of Conformity - EMC	Complies with EMC Framework and demonstrated per Emission standard:  AS/NZS 2064 Industrial, Scientific, and Medical Equipment

- 1 Compliance demonstrated using high quality, shielded interface cables.
- 2 Minimum immunity test requirement.
- 3 No degradation of a displayed return loss of 20 dB when exposed to a 3 V/m field over the frequency range of 80 MHz–1 GHz. Test port connected to a high quality 3 meter coaxial cable (Tektronix part number 012-1619-00) and a high quality 10–12 dB attenuator terminated in a microwave short.
- 4 No degradation of a displayed return loss of 20 dB when a 3 Vrms signal is injected into the AC power lines of the External Power Supply over the frequency range of 150 kHz–80 MHz. Test port connected to a high quality 10–12 dB attenuator terminated in a microwave short.

# Appendix B: Accessories

This section lists the YBA250 Antenna and Transmission Line Analyzer standard and optional accessories.

## Standard Accessories

Table B-1 lists the accessories that come standard with your YBA250 Antenna and Transmission Line Analyzer.

**Table B-1: Standard accessories**

Quantity	Part number	Description
1 each	016-1868-00	Accessory Pouch
1 each	200-4728-00	Connector Dust Cover
1 each	020-2428-XX	Documentation kit containing YBA250 Antenna and Transmission Line Analyzer User manual, English, with CD-ROM containing software and User Manual in PDF format.

## Optional Accessories

Table B-2 lists optional accessories you can purchase for your YBA250. Contact your Tektronix representative or distributor for ordering information. See page xv for further information on contacting Tektronix.

**Table B-2: Optional accessories**

Part number	Description
012-1619-00	Precision cable assembly, 120.0 inches (3.05 meters)
103-0429-00	Adapter: Type N Female to Type N Female, 50 ohms, DC-18 GHz
103-0430-00	Adapter: Type N Male to Type N Male, DC-18 GHz
103-0431-00	Adapter: Type 7-16 Female to Type N Female, DC-7.5 GHz
103-0432-00	Adapter: Type 7-16 Male to Type N Female, DC-7.5 GHz
119-6598-00	DC Blocks; Type N to Type N, 0.01 TO 12.4 GHz, Audio Interference Suppressors
436-0416-00	Shelf, Utility; Magnetic, 11.5 H X 15.0 W X 0.25 D, Safety Controlled
YBAC1	Calibration Kit
YBAC2	Two-Port Normalization Kit
015-0718-00	Bias Tee, broad band 2.5 to 6000 MHz, RF: Male N-Type, RF+DC: Female N-Type, DC: Female BNC
119-7017-00	Power Supply; External, Desktop; 50W, 12VDC 4.1A Out, 90-254 VAC 47-63 HZ In
012-1686-00	Adaptor, Molex 39-01-3029 to Male BNC

For the most current list of accessories, please see the Tektronix website: [www.tektronix.com](http://www.tektronix.com).

# Appendix C: Options

Table C-1 lists the configuration option available for the YBA250.

**Table C-1: Configuration option**

Option	Description
Option 88	Add NetTek Analyzer Platform



## Appendix D: Upgrading/Reinstalling Software

To upgrade or reinstall software for your YBA250, you will need a Windows PC. On-screen installation instructions will guide you through connecting to the NetTek Analyzer Platform and upgrading or reinstalling the YBA250 software.

To upgrade or reinstall software for your YBA250:

1. Insert the YBA250 Installation SW CD-ROM (Tektronix part number, 063-3554-XX) into your PC and follow the on-screen instructions that appear.
2. If no instructions appear after you insert the CD-ROM, use Windows Explorer to display the contents of the CD-ROM and double-click the setup.exe file to begin the installation. Follow the on-screen instructions.
3. If you received new software as part of an upgrade kit, place the label supplied in the kit on the bottom edge of your YBA250 module.





# Appendix E: Functional Verification Procedure

This appendix provides a functional verification procedure. The procedure verifies the basic functionality of the YBA250. The functional verification procedure can be used for incoming inspection purposes.

---

**NOTE.** *The functional verification procedure in this appendix does not confirm that the YBA250 meets or exceeds the performance requirements for the specifications listed in Appendix A.*

---

There are two parts to this procedure:

- Self Tests: provides instructions for performing the internal diagnostic self-tests.
- Functional Tests: provides instructions for verifying capabilities not completely covered by the diagnostic self-tests. Requires the use of a signal generator.

## Self Tests

### Equipment Required

- None.

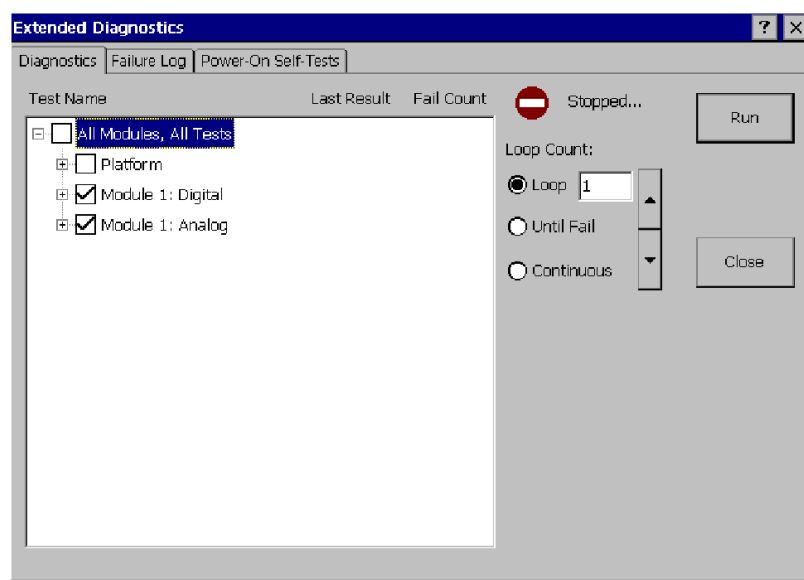
### Prerequisite

- None.

To run the internal diagnostics self-tests:

1. Power up the NetTek Analyzer Platform.
2. Press **File > Exit** to quit the YBA250 application, if it is running.
3. Press **Start > Programs > Tektronix Utilities>Diagnostics** in the taskbar.

4. Tap the + box next to **All Modules, All Tests** to expand the selection tree.
5. Tap the check box next to **Platform** to deselect the platform diagnostics.
6. Verify that **Module 1: Digital** and **Module 1: Analog** are selected. See Figure E-1.



**Figure E-1: Settings to run diagnostics**

7. Select **LOOP**, set the loop count to 1.
8. Tap **Run**.
9. Verify that each test executes and passes.

---

**NOTE.** If you encounter any errors, you can tap the *Failure Log* tab to display more information. If the YBA250 fails any of its diagnostic tests, contact your local Tektronix service representative.

---

10. Tap **Close** to exit the diagnostic system.

## Functional Tests

In the following test, you will perform a User calibration and then measure the return loss of a 50  $\Omega$  load from a calibration kit.

### Equipment Required

- Calibration Kit (Tektronix YBAC1 or equivalent)

### Prerequisite


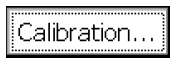
- None

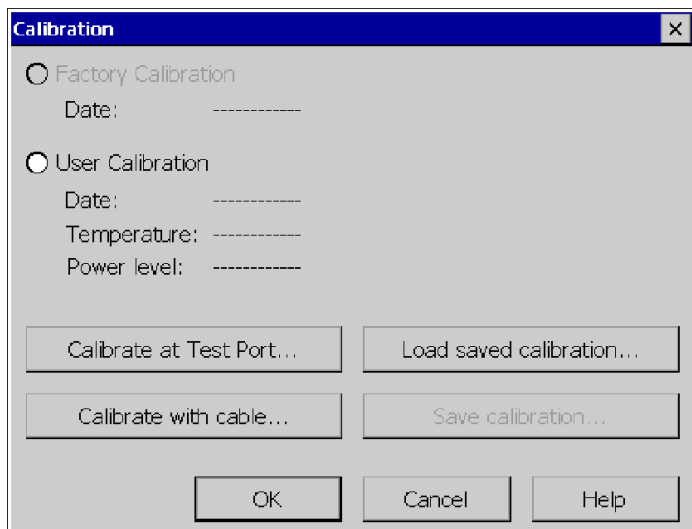
---

**NOTE.** *These procedures verify only that the YBA250 is operating correctly. They do not verify that the YBA250 meets warranted specifications.*

---

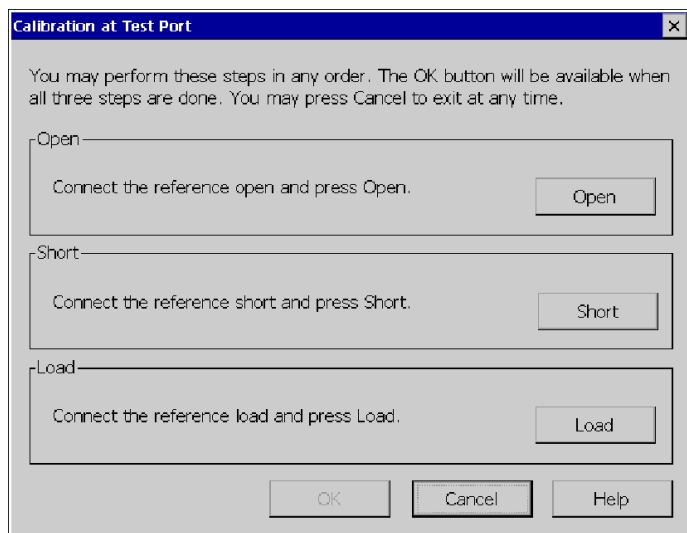
To perform the functional test:

1. Power up the NetTek Analyzer Platform.
2. If necessary, launch the YBA250 application by double-tapping the **YBA250** icon on the desktop or selecting **Start > Programs > NetTek > YBA250** from the Taskbar.
3. Select **Return Loss** from the **Measurement** drop-down list.
4. Tap the Continuous mode button .
5. Allow the NetTek Analyzer Platform to run for five to ten minutes to warm up.
6. In the main display, tap the **Calibration...** button . This displays the **Calibration** window. See Figure E-2.



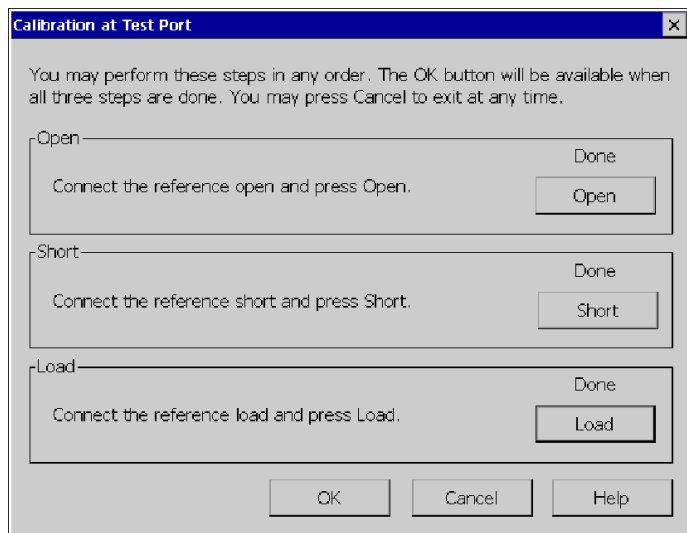
**Figure E-2: Calibration window prior to calibration**

7. Tap the **Calibrate at Test Port...** button . This displays the **Calibration at Test Port** window. See Figure E-3.



**Figure E-3: Ready to perform calibration**

8. Carefully attach the OPEN calibration standard to the **Test Port** connector using the procedure described on page 2-20.
9. Tap the **Open** button in the Calibration at Test Port window. When the calibration is completed, **Done** appears above the Open button.
10. Remove the OPEN calibration standard from the **Test Port** connector.
11. Carefully attach the SHORT calibration standard to the **Test Port** connector.
12. Tap the **Short** button in the New Calibration window. When the calibration is completed, **Done** appears above the Short button.
13. Remove the SHORT calibration standard from the **Test Port** connector.
14. Carefully attach the LOAD calibration standard to the **Test Port** connector.
15. Tap the **Load** button. When the calibration is completed, **Done** appears above the Load button.
16. Carefully remove the LOAD calibration standard from the **Test Port** connector.
17. Once calibration has been completed for all three standards, tap the **OK** button. The OK button is not selectable until all three calibration standards have been marked as done. See Figure E-4.



**Figure E-4: Calibration window after calibration is done**

18. Tap **OK** to accept the new calibration.
19. Attach the 50  $\Omega$  load from the calibration kit to the **TEST PORT** connector.
20. Tap the Impedance button to measure return loss.
21. If necessary, tap the Start frequency label and set the start frequency to 25 MHz.
22. If necessary, tap the Stop frequency label and set the stop frequency to 2500 MHz.
23. If necessary, select **View > Markers** to display the marker readout.
24. Verify that the **Min** marker readout is greater than 45 dB.

This completes the Incoming Inspection procedure. If your YBA250 did not complete the procedure without errors, contact your local Tektronix service representative.

# Appendix F: Supported Signal Standards

This appendix lists the signal standards on which measurements can be made by the YBA250.

**Table F-1: Cellular standards supported**

Standard	Channel numbers
US CDMA-Cellular	1-799
TIA/EIA-95	990-1023
TIA/EIA-97C	
US CDMA-PCS	1-1199
TIA/EIA-95	
TIA/EIA-97C	
CDMA Korea-PCS	1-598
CDMA Japan/ARIB	1-799
	801-1039
	1041-1199
CDMA China-1	0-1000
	1329-2047
CDMA China-2	0-1000
	1329-2047
CDMA2000 Class 0, Korea Cellular	1-799
	990-1023
CDMA2000 Class 0, N. A. Cellular	1-799
	990-1023
CDMA2000 Class 1, N. A. PCS	0-1199

**Table F-1: Cellular standards supported (Cont.)**

<b>Standard</b>	<b>Channel numbers</b>
CDMA2000 Class 2 (TACS Band)	0-1000
	1329-2047
CDMA2000 Class 3 (JTACS Band)	1-799
	801-1039
	1041-1199
	1201-1600
CDMA2000 Class 4, Korea PCS	0-599
CDMA2000 Class 5, (NMT-450W 25 kHz)	1-300
	539-871
CDMA2000 Class 5, (NMT-450N 20 kHz)	1039-1473
	1792-2016
CDMA2000 Class 6, IMT-2000	0-1199
CDMA2000 Class 7, N. A. 700 MHz Cell Band	0-359
CDMA2000 Class 8, GSM Band	0-1499
CDMA2000 Class 9, GSM Band	0-699
CDMA2000 Class 10, SMR 800 Band	0-719
	720-919
W-CDMA (UMTS)	9612-9888
	10562-10838
W-CDMA (NA-PCS)	9262-9538
	9662-9938
W-CDMA (NA-Addl. PCS)	12-287
	412-687



**Table F-1: Cellular standards supported (Cont.)**

<b>Standard</b>	<b>Channel numbers</b>
W-CDMA (DCS1800)	8562-8913
	9037-9388
NADC IS-136 Cellular	1-799
	990-1023
NADC-PCS / IS-136	1-1999
SMR 800 - 25kHz	1-600
SMR 800 - 12.5kHz	1-1199
SMR 1500	1-479
GSM 450	259-293
GSM 480	306-340
GSM 850	128-251
GSM-E 900	0-124
	975-1023
GSM-P 900	1-124
GSM-R 900	0-124
	955-1023
GSM 1800	512-885
GSM 1900	512-810
PDC1500 (JDC)	0-960
PHS	1-77
AMPS / EIA 553	1-799
	990-1023
N-AMPS / IS-88	1-799 ( $N_M$ , $N_L$ , and $N_U$ )
	990-1023 ( $N_M$ , $N_L$ , and $N_U$ )
TACS	1-1000

**Table F-1: Cellular standards supported (Cont.)**

<b>Standard</b>	<b>Channel numbers</b>
ETACS	0-1000
	1329-2047
NTACS	1-799
	800-1039
	1040-1199
JTACS	0-798 (even chan. only)
	800-1038 (even chan. only)
	1040-1198 (even chan. only)
PDC 800 Analog	0-1680
NMT-411-25 kHz	539-871
NMT-450-25 kHz	1-300
NMT-450-20 kHz	1039-1473
NMT-470-20 kHz	1792-2016
NMT-900	1-1000
NMT-900 (offset)	1025-2023
MATS-E	1-1000
C-450 (SA)	1-247
C-450 (P)	1-887
1xEVDO-10 SMR 800 Band	0-919
CDMA2000 1xEVDO Class 0 NA Cellular	1-799
	990-1023
CDMA2000 1xEVDO Class 0 Korea	1-799
	990-1023
CDMA2000 1xEVDO Class 1 N.A. PCS	0-1199

**Table F-1: Cellular standards supported (Cont.)**

<b>Standard</b>	<b>Channel numbers</b>
CDMA2000 1xEVDO Class 2 TACS Band	0-1000
	1329-2047
CDMA2000 1xEVDO Class 3 JTACS Band	1-799
	801-1039
	1041-1199
	1201-1600
CDMA2000 1xEVDO Class 4 Korea PCS	0-599
CDMA2000 1xEVDO Class 5 NMT-25k-450	1-300
	539-871
CDMA2000 1xEVDO Class 5 NMT-20k-450	1039-1473
	1792-2016
CDMA2000 1xEVDO Class 6 IMT-2000	0-1199
CDMA2000 1xEVDO Class 7 N.A. 700 MHz Cellular	0-359
CDMA2000 1xEVDO Class 8 GSM Band	0-1499
CDMA2000 1xEVDO Class 9 GSM Band	0-699
CDMA2000 1xEVDO Class 10 SMR 800 Band	0-719
	720-919



# Appendix G: Customizing the Channel Table

This appendix describes how to modify the Channel Table to meet your testing needs.

## Customizing the Channel Table

The Channel Table is a file used by the YBA250 to specify the characteristics of the channels assigned to a signal standard. You can customize the Channel Table to suit the specific needs of your system. For example, if you have set the bandwidth of your channels to be wider than the standard bandwidth, you can specify the wider bandwidth in a customized Channel Table. If your system's channel bandwidth is non-standard and the YBA250 is using the standard Channel Table, the test frequency range based on the standard channel bandwidth will not be accurate for your system.

The YBA250 looks for a file named `UserStandards.txt` in the `\BuiltInDisk` folder when it starts up. If it does not find the file, the YBT250 then looks for the standard channel table file, `SignalStandards.txt`, in the `NetTekApps\YBA250` folder. If that file is not found, a dialog box will be displayed informing you that no standards file was found, so a new channel table will be generated using internal default values.

### Creating a Custom Channel Table

To create a custom channel table:

1. Locate the existing **SignalStandards.txt** file in either the `\BuiltInDisk\NetTekApps\YBA250` folder or `\NetTekApps\YBA250` folder (only if the application software loaded into volatile memory instead of flash memory).
2. Copy the **SignalStandards.txt** file to the `\BuiltInDisk` folder.

The YBA250 will look only in the `\BuiltInDisk` folder for a custom channel table.

3. Rename **SignalStandards.txt** to **UserStandards.txt**.
4. Edit the contents of the file to suit your systems settings.

When editing your UserStandards.txt file, it is safer to copy a row and then edit the copied row to meet your requirements than to modify an existing row.

Table G-1 lists the elements of the Channel Table file.

**Table G-1: Channel table file contents**

Column heading	Description
Standard Text Name	<p>The text string used to identify the standard. This name is what appears in the Signal Standard list.</p> <p>Each line in the channel table should describe a single group of channels for a standard. If a standard is made up of multiple groups or blocks of channels then you should make an entry for each group. When multiple groups are required, they should be ordered in channel number sequence and contiguous. To tie the groups together, the Unique Standard ID must be the same for each group.</p>
Forward Base Frequency	<p>Forward base frequency for each signal standard. The actual frequency for each channel is calculated.</p> <p>For signal standards that specify a single frequency for each channel (for example, the UTRA/FDD scheme used by WCDM(UMTS)), each row in the file will describe a group of forward <i>or</i> reverse channels. The row that describes forward channels should specify zero for the reverse base frequency.</p>
Reverse Base Frequency	<p>Reverse base frequency for each signal standard. The actual frequency for each channel is calculated.</p> <p>For signal standards that specify a single frequency for each channel (for example, the UTRA/FDD scheme used by WCDM(UMTS)), each row in the file will describe a group of forward <i>or</i> reverse channels. The row that describes reverse channels should specify zero for the forward base frequency.</p>

**Table G- 1: Channel table file contents (Cont.)**

<b>Column heading</b>	<b>Description</b>
Signal Bandwidth	The signal bandwidth. If the signal to be measured is 100 kHz wide but the channels are spaced 200 kHz apart then this field should contain 100000.
Starting Channel Number	The starting channel number for a block of channels.
Ending Channel Number	The ending channel number for a block of channels.
Channel Increment Amount	If the channels increment by 1, then a 1 goes in here. If by 2, then a 2 goes in here. If by 5...
Channel Spacing	Sets the spacing between channels. For instance, if you have a standard that has signals that are 100 kHz wide but the channels in you system are spaced 200 kHz apart, then this field should contain 200000.
Channel Offset	Offset applied to channel number before calculating the channel frequency from the channel number.
Unique Standard ID	Must be between 0 and 400. It is used to tie multiple blocks of channels together into a single standard. A block of channels is a single row in the channel table file.
Signal Type	1 = CDMAOne 2 = AMPS 3 = TDMA IS136 4 = GSM 5 = W-CDMA (UMTS) 6 = CDMA 2000 10 = 1xEVDO 998 = NO_MEAS_ANALOG 999 = NO_MEAS_DIGITAL
Forward / Reverse frequency separation	For signal standards that specify a single frequency for each channel (for example, the UTRA/FDD scheme used by WCDM(UMTS)), this entry specifies the difference in frequency between a forward channel and its corresponding reverse channel. For signal standards that specify forward and reverse frequencies for each channel (most standards), this entry is left blank.

### How Channel Frequencies are Calculated

The frequency for a specific channel is calculated with a formula based on the current channel number, the base frequency, the channel spacing and the channel offset:

If (Channel Offset  $\geq$  0)

$$\text{Chan Freq} = (\text{Chan Num} - \text{Channel Offset}) \times \text{Channel Spacing} + \text{Base Frequency}$$

If (Channel Offset < 0)

$$\text{Chan Freq} = \text{Base Frequency} - ((-\text{Channel Offset} - \text{Chan Num}) \times \text{Channel Spacing})$$

Where:

**Base Frequency:** Either forward or reverse base frequency depending on current user selection, from the Channel Table file (UserStandards.txt when present or SignalStandards.txt).

**Chan Num:** The current user selected channel number.

**Chan Freq:** The frequency associated with the Chan Num.

**Channel Spacing:** The distance between channels, from the Channel Table file.

**Channel Offset:** From the Channel Table file.





# **Glossary**



# Glossary

**BMP - Graphics File Format.** BMP is one of the file formats available for saving screen captures. BMP is the standard Windows graphic image format. The filename extension is “bmp”.

**BTS.** Acronym for Base Transceiver Station.

**Cable Loss.** As a signal travels down a cable, some of its energy is lost due to losses in the conductors and dielectrics. This reduction in signal level is called cable loss. Cable loss is specified in decibels per distance at a specified frequency. For example, the cable loss for RG58 cable is 0.558 dB/1 m @ 1,000 MHz.

**Flash Memory.** Flash memory is a form of non-volatile memory. When the YBT250 software is stored in flash memory, the YBT250 loads more quickly at power on.

**Forward Frequency.** The frequency the base station uses to transmit to the mobile unit. Also called Downlink Frequency.

**JPEG - Graphics File Format.** JPEG, an acronym for Joint Photographic Experts Group, is one of the file formats available for saving screen captures. Files saved in JPEG format can be much smaller in size than files saved in BMP format. The filename extension is “jpg”.

**One-Port Measurement.** One-port measurements, also known as reflection measurements, use a single port on the YBA250 module to measure return loss, VSWR, cable loss, and distance to fault (DTF). One-port measurements connect one end of a signal path or device to the YBA250 module, with the other end of the signal path connected to the device under test (such as an antenna).

**PNG - Graphics File Format.** PNG, an acronym for Portable Network Graphics, is one of the file formats available for saving screen captures. PNG is a new format developed primarily for use on the World Wide Web. PNG files are usually much smaller than BMP files. The filename extension is “png”.

**Reference Level.** The power level at the top of the display.

**Return Loss.** Return Loss is a ratio of the power sent to the antenna versus the power reflected by the antenna. A larger Return Loss is better because less power is reflected.

**Reverse Frequency.** The frequency the mobile unit uses to transmit to the base station. Also called uplink frequency, reverse channel or uplink channel.

**Span.** The frequency range covered by the display graph.

**TMA.** Acronym for Tower-Mounted Amplifier.

**Two-Port Measurement.** Two-port measurements, also known as transmission measurements, provide insertion gain and loss measurements such as filter response (loss) versus frequency and tower-mounted amplifier (TMA) gain versus frequency. Both a YBA250 and YBT250 module must be installed on the NetTek Analyzer to perform two-port Insertion Gain/Loss measurements. The YBA250 module injects a signal into the device or system under test, and the YBT250 module receives and measures the resultant signal.

**Velocity of Propagation.** The Velocity of Propagation is the velocity at which a signal travels through the cable. Velocity of propagation is expressed as a fraction of the speed of light. A Velocity of Propagation equal to 1 means that the signal is traveling down the cable at the speed of light. A Velocity of Propagation equal to 0.5 means that the signal is traveling down the cable at half the speed of light.

**VSWR.** VSWR (Voltage Standing Wave Ratio) is a measure of the ratio of the maximum resultant voltage to the minimum resultant voltage along a transmission line. It represents the amount of impedance mismatch between the transmission line and the load. For VSWR, the lower the number, the better. The best possible VSWR is 1.0, which means the impedance of a transmission line and its load match perfectly.



# Index



# Index

## A

- a02 - a06 file extensions, 3-40
- Address, Tektronix, xv
- attaching precision connectors and cables, 2-20
- Average, trace type, 3-33

## B

- Band Edge Cursor, 3-49
  - View menu, 2-15
- BATTERIES indicator, 1-2
- battery, installing, 1-7
- battery life, A-7
- bias tee
  - connection notes, 3-29
  - connector and power supply, 3-29
- BMP, Glossary-1
- BTS, Glossary-1
- button, rotate traces, 3-38
- buttons
  - Chan, 3-4
  - command bar area, 2-8
  - help, 2-4
  - program, 2-2
  - shared control area, 2-10
  - tuning control area, 2-9, 2-12

## C

- cable loss, 3-11, Glossary-1
- cable standards table,
  - customizing, 3-20
- cable type, user defined, 3-19
- Cable Types tab, 3-17

- calibration, 2-25
- calibration guidelines, 2-38
- calibration interval, A-7
- cellular standards supported, F-1
- Center frequency setting, 3-16
- Chan button, 3-4
- changing vertical scale units, 3-16
- channel table, G-1
  - customizing, G-1
- Compare Save... command, File menu, 2-13
- Compare Saved command, 3-39
- comparing traces, 3-38
- connecting to an antenna, 2-21
- connecting to TMA, 3-28
- connector, input, 1-3
- Contacting Tektronix, xv
- Continuous button, 2-8
- controls, front panel, 1-1
- conventions, xiv
- Coordinates, saving
  - GPS data, 2-61
- Cover Distance setting, 3-23
- creating a default
  - normalization, 2-44
- creating a user normalization, 2-45
- customizing the cable standards table, 3-20
- CW signal mode, 3-31
- CW Signal Mode button, 2-11

## D

- DC power adapter, 1-6
- Default (normalization), 2-43
- default normalization,
  - creating, 2-44
- Define Mask, View Menu, 2-14
- Define Trace 2, View Menu, 2-14
- Define Trace 2 tab, 3-38
- Desktop
  - icons, 2-3
  - overview, 2-1
  - status area, 2-2
- desktop
  - icon, 2-2
  - program button, 2-2
  - Start menu, 2-2
  - taskbar, 2-2
- desktop AC power supply, 1-6
- dimensions, external, A-7
- display, preferences, 2-57
- displaying, saved traces, 3-37
- Distance button, 2-10
- distance to a fault, 3-13
- distance units, setting, 3-35

## E

- Edit command, Setup menu, 2-15
- enabling signal
  - standards, 2-53, 3-1
- Exit command, File menu, 2-14
- Export Results command, File menu, 2-13
- Export Screen As command, File menu, 2-14
- Export Screen command, File menu, 2-13

- exporting
  - results, 3-64
  - screens, 3-65
- external power supplies, 1-6

## F

- Factory calibration status, 2-28
- Factory Reset command, Tools menu, 2-16
- file extensions, results files, 3-40
- File menu, 2-13
- file options, setting, 2-58
- file prefix, setting, 2-59
- filename length, 2-60
- find information, start Help, 2-4
- flash memory, Glossary-1
- floppy disk button, 2-8
- Folder icon, 2-8
- forward frequency, Glossary-1
- Frequency button, 2-10
- front-panel controls, 1-1
- functional verification, E-1

## G

- GPS receiver set up, 2-61
- guidelines
  - calibration, 2-38
  - normalization, 2-50

## H

- Hardware Info command, Tools menu, 2-16
- Help
  - find information, 2-4
  - icon, 2-4
- help icon, 2-9
- hide program, 2-2



**I**

Icon, status, 2-3  
icons  
    ?, 2-4  
    command bar area, 2-8  
    desktop, 2-2, 2-3  
    shared control area, 2-10  
    tuning control area, 2-9, 2-12  
in-vehicle DC adapter, 1-6  
incoming inspection, E-1  
information, getting help, 2-4  
input connector, 1-3, 2-21  
Input panel, enter keyboard  
    characters, 2-17  
insertion gain, 3-26  
insertion gain or loss,  
    measuring, 3-27  
Insertion Gain/Loss button, 2-10  
insertion loss, 3-26  
Installing  
    shoulder strap, 1-18  
    strand hook, 1-18  
installing, YBA250 module, 1-4

**J**

JPG, Glossary-1

**K**

Keyboard, (soft) input panel, 2-17  
Keyboard command, Tools  
    menu, 2-16  
keypad button, 2-11  
knob, 2-11

**L**

length of filename, 2-60  
Limit Bandwidth setting, 3-16  
loading a user normalization, 2-48  
Location data, saving GPS  
    coordinates, 2-61  
Lock-up, recovering from, 1-2

**M**

M1 Trace 1, M2 Trace 2, 3-47  
Marker 1, View menu, 2-15  
Marker 2, View menu, 2-15  
Marker Max, View menu, 2-15  
Marker Min, View menu, 2-15  
Markers  
    M1 Trace 1, M2 Trace 2, 3-47  
    View menu, 2-15  
markers  
    measuring frequency and  
        level, 3-48  
    readouts, 3-45  
    viewing, 3-43  
Mask, View Menu, 2-14  
Mask Maker... command, Tools  
    menu, 2-16  
Max trace type, 3-34  
measurement overview, 2-23  
measurements  
    cable loss, 3-11  
    distance to fault, 3-13  
    insertion gain, 3-26  
    insertion loss, 3-26  
    return loss, 3-8  
    VSWR, 3-8  
Menus  
    File, 2-13  
    Help, 2-4  
    Setup, 2-15  
    Start, 2-2

- Tools, 2-16
- View, 2-14
- Method setting, 2-56
- Min trace type, 3-33
- Min/Max trace type, 3-34

## N

- Normal, trace type, 3-33
- normalization
  - creating a default
    - normalization, 2-44
  - creating a user
    - normalization, 2-45
  - default, 2-40
  - dialog elements, 2-40
  - dialog status labels, 2-42
  - displaying normalization
    - dialog, 2-40
  - guidelines, 2-50
  - loading a user
    - normalization, 2-48
  - overview, 2-40
  - saving a user normalization, 2-46
  - type status labels, 2-43
    - Default, 2-43
    - UnNormalized, 2-44
    - User, 2-43
    - User?, 2-43
  - user, 2-40
- Not Valid (normalization), 2-42
- notes, entering, 2-60
- numeric keypad button, 2-11

## O

- On-Off button, 1-2
- one-port measurement, 2-23,
  - Glossary-1

- Open button, 2-8
- Open command
  - File menu, 2-13
  - Setup menu, 2-15
- Options, C-1
- Options command, Tools
  - menu, 2-16
- output power, setting, 2-54

## P

- Pause button, 2-8
- Phone number, Tektronix, xv
- PNG, Glossary-1
- power supplies, external, 1-6
- power switch, 1-2, 1-14
- precision connectors and
  - cables, 2-19
- Preferences tab, 2-57
- Print command, File menu, 2-14
- Product support, contact
  - information, xv
- program button, 2-2

## Q

- question mark icon, 2-9

## R

- recalling results, 3-63
- recalling setups, 3-69
- reference level, Glossary-1
- removing precision connectors and
  - cables, 2-20
- Reset
  - hardware, 1-2
  - software, 1-13

- reset switch, 1-2
- Restart button, 2-8
- results
  - exporting, 3-64
  - recalling, 3-63
  - saving, 3-61
- Results Properties command, File menu, 2-14
- return loss, 3-8, Glossary-2
- reverse frequency, Glossary-2
- Rotate Trace Order, View menu, 2-14
- rotate traces button, 3-38
- Running indicator, 2-8
  
- S**
- Save & Export tab, 2-59
- Save command, Setup menu, 2-15
- Save Results command, File menu, 2-13
- Save Results As command, File menu, 2-13
- Save Results As command, File Menu, 3-36
- save results button, 2-8
- Save Results command, File menu, 3-36
- saved trace, displaying, 3-37
- Saving, GPS coordinates, 2-61
- saving a user normalization, 2-46
- saving results, 3-61
- screens
  - exporting, 3-65
  - file formats, 3-67
- Service support, contact information, xv
- setting
  - display colors, 2-57
  - distance units, 3-35
  - file options, 2-58
  - file prefix, 2-59
  - note text, 2-60
  - startup application, 2-6
  - technician name, 2-60
  - trace type, 3-33
- setting cable types, 3-17
- Setup Menu, customizing, 3-70
- Setup menu, 2-15
- setups
  - recalling, 3-69
  - saving, 3-68
- Shoulder strap, 1-18
- signal standards
  - enabling, 2-53, 3-1
  - supported, F-1
- Single measurement button, 2-8
- Smoothing, View Menu, 2-14
- smoothing, 2-58
- Software, load process, 1-11
- software
  - reinstalling, D-1
  - upgrading, D-1
- Software Info, Tools menu, 2-16
- software version, xiv
- span, Glossary-2
- specifications, A-1
- Start, menu, 2-2
- Start and Stop frequency, setting, 3-5
- startup application, setting, 2-6
- Status
  - area, desktop, 2-2
  - icons, 2-3
- STATUS indicator, 1-2
- Status indicator, 1-2
- Stop icon, 2-8
- Strand hook, 1-18
- suspend mode, 1-12

### T

- taskbar, desktop, 2-2
- Technical support, contact
  - information, xv
- technician name, setting, 2-60
- Tektronix, contacting, xv
- test frequency range, 3-3
- tilt stand, 1-16
- timestamp readout, 2-9
- TMA, Glossary-2
- Tools menu, 2-16
- touch-screen calibration, 1-11
- Touchscreen Calibration command,
  - Tools menu, 2-16
- tower mounted amplifier
  - (TMA), 3-28
- Trace 2, View Menu, 2-14
- trace display options, 3-39
- Trace2, 3-38
- Troubleshooting, GPS
  - receiver, 2-62
- two-port measurement, 2-23,
  - Glossary-2

### U

- UnNormalized
  - (normalization), 2-44
- Unusable (normalization), 2-42
- Upgrade Software command, Tools
  - menu, 2-16
- URL, Tektronix, xv
- User (normalization), 2-43

- User Cal? calibration status, 2-28
- User calibration status, 2-28
- user normalization
  - creating, 2-45
  - loading, 2-48
  - saving, 2-46
- User? (normalization), 2-43
- user-defined cable type, 3-19

### V

- Valid (normalization), 2-42
- velocity of propagation,
  - Glossary-2
- View menu, 2-14
- VSWR, 3-8, Glossary-2

### W

- Web site address, Tektronix, xv
- weight, A-7
- Windowing setting, 3-22