



Advanced Test Equipment Rentals
www.atecorp.com 800-404-ATEC (2832)

FLUKE®

Fluke 983

Particle Counter

Users Manual

PN 2414721
January 2005
© 2005 Fluke Corporation. All rights reserved. Printed in U.S.A.
All product names are trademarks of their respective companies.

Fluke 983 Particle Counter

Introduction

⚠ Warning

Read “Safety Information” before using the Fluke 983 Particle Counter.

The Fluke 983 Particle Counter (“The Particle Counter”) is a portable instrument that measures and reports air contamination. It holds 5,000 samples in memory and records the date, time, counts, sample volume, temperature, and relative humidity of each sample. The data can be easily downloaded to a personal computer using the interface cable adapter, cable, and Fluke 983 Utility Software provided with the unit.

Applications

The Particle Counter can be used for:

- Monitoring cleanrooms
- Indoor air quality investigations
- Monitoring gowning rooms
- Testing filter seals
- Locating particle contamination sources
- Monitoring particle size distributions

Safety Information

A **Warning** identifies a condition or action that pose hazard(s) to the user; a **Caution** identifies a condition or action that may damage the Particle Counter or the equipment under test.

Read the entire Users Manual before using the Particle Counter.

Safety symbols used in this manual and on the Particle Counter are displayed in Table 1.

Table 1. Symbols

Symbol	Meaning
	Risk of Danger. Important information. Refer to manual.
	Conforms to relevant European Union directives.

Warning

To avoid electric shock, injury, or damage to the Particle Counter, follow these safety guidelines:

- Use the Particle Counter only as described in the Users Manual, otherwise the protection provided by the instrument may be impaired.
- Do not use the Particle Counter in explosive atmospheres.
- The Particle Counter contains no user-serviceable parts. Do not open the instrument. For service and battery replacement, the instrument must be sent to Fluke. See “Contacting Fluke”.
- Have the Particle Counter serviced only by qualified service personnel.
- Inspect the Particle Counter before use. Do not use it if it appears damaged.
- Always use the ac adapter/charger and connector (supplied with the Particle Counter) appropriate for the voltage and outlet of the country or location in which you are working.

⚠ Caution

To avoid possible damage to the Particle Counter:

- **Avoid using the Particle Counter in an excessively dirty or dusty atmosphere. Excessive particle intake can damage the Particle Counter.**
- **Remove the Isokinetic-Probe Cover (the black cap) before use. Not doing so can damage the Particle Counter.**
- **Do not use a wrench to connect or disconnect the Isokinetic Probe or intake nozzle. The connection should be finger tight.**
- **If using the tilt stand, hold the instrument while using the keypad.**

Compliance

The Particle Counter complies with:

CE, JIS B9921: 1997, 89/336/EEC, 73/23/EEC, EN61326: 1997, EN60825-1:2001, Federal Standard 209E

Quick Start

The Particle Counter may be used directly out of the box. To immediately use the Particle Counter:

1. Read "Safety Information"
2. Remove the Isokinetic Probe Cover (the black cap)
3. Press the POWER keypad
4. Press **(F1)** to start sampling

Be sure to read the entire Users Manual for more detailed information.

Shipping Contents

The Particle Counter ships with the items shown in Figure 1.

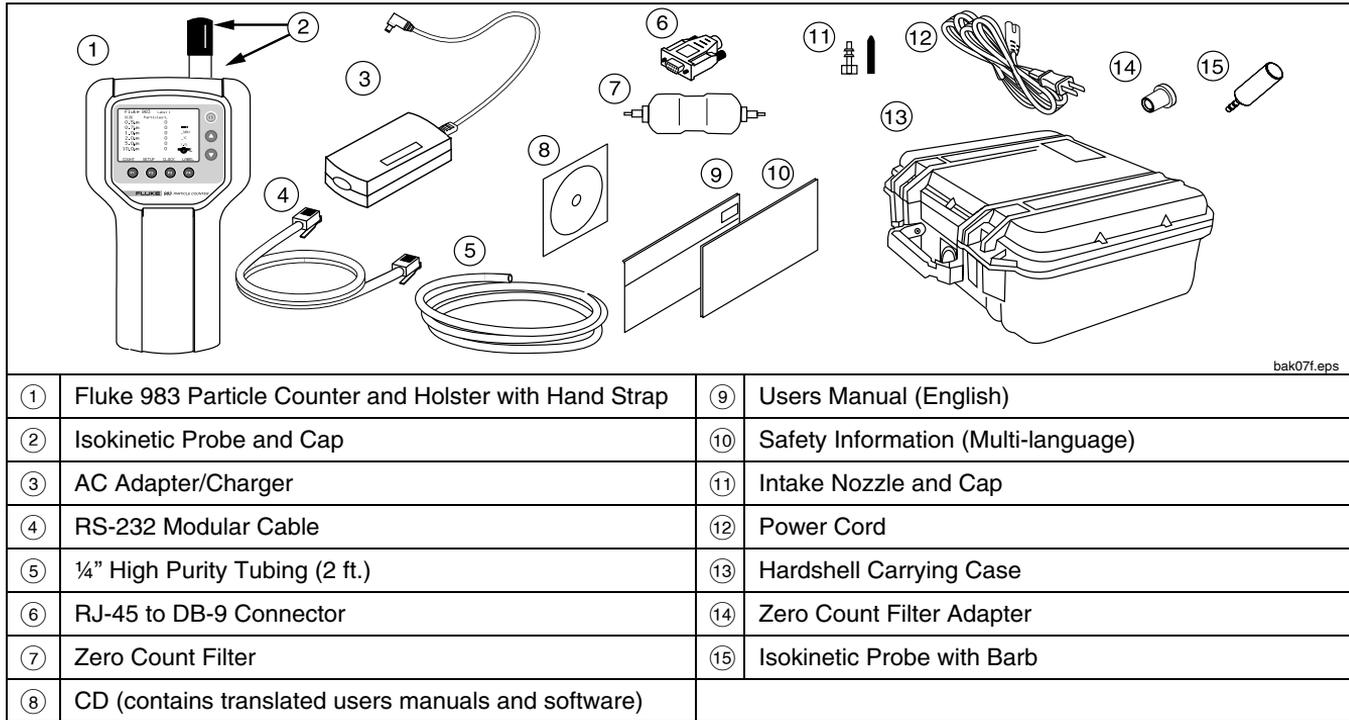

Figure 1. Fluke 983 Shipping Contents

The Keypad

Use the keypad to navigate among different screens on the display, refer to Figure 2.

The Backlight

The Particle Counter is equipped with an automatic backlight that stays on for two minutes when the unit is powered up. If within two minutes no keys are pressed, the backlight turns off to conserve battery power. If the backlight goes out, press any function or arrow key to turn it back on.

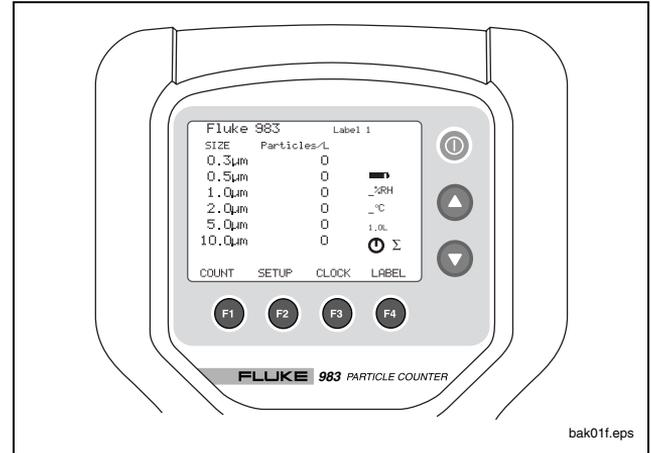

 Power Key	Turns the Particle Counter on and off.
 Arrow Keys	Press to navigate up and down through the different sections of the menus or to control the display contrast when on the Main Screen.
 Function Keys	Each function key corresponds to a name above each function key. Different menus have different labels above the keys.

Figure 2. Fluke 983 Keypad

The Base

On the base of the Particle Counter are the connection ports for the RS-232 Modular Cable (I/O Port) and the 12 V External Power Adapter. The Tripod Mount is also located on the base under the holster. See Figure 3.

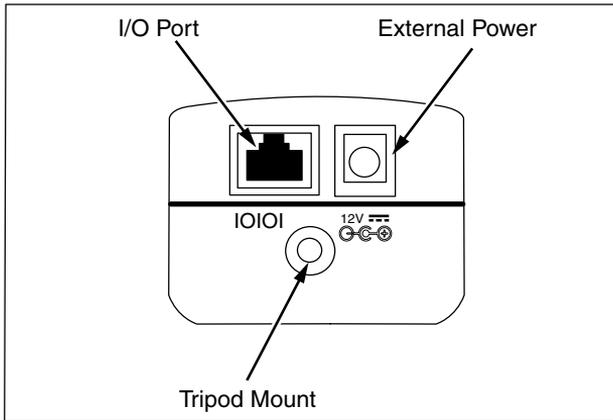

bak08f.eps

Figure 3. The Base of the Fluke 983

The Display

The LCD Display shows several different screens and menus. Navigate through each using the keypad. The following sections explain the different screens used by the Particle Counter.

The following screens appear on the display:

- Main Screen
- Setup Screen (pages 1 and 2)
- Clock Setup Menu
- Label Setup Menu

The bottom of the display includes information about the corresponding function keys.

The Main Screen

The Main Screen (see Figure 4) appears after the Particle Counter is turned on and after the opening screen appears.

The Main Screen includes:

- Six particle-size channels
- Particle counts
- Relative humidity (%RH)
- Air-sample temperature (°C or °F)
- Sample-location name
- Battery-charge indicator (charge remaining)
- Time indicator (represents time to complete)
- Sample volume
- Particle-count mode
- Total counts/volume

The parameters on the Main Screen are selected by using the Setup Screens, the Clock Setup Menu, and the Label Setup Menu.



Figure 4. Main Screen

bak03f.eps

The Setup Screens

To use the Setup Screens:

1. From the Main Screen, press **F2** (SETUP). The Setup Screen 1 appears, see Figure 5. To get to Setup Screen 2 while on Setup Screen 1, press **F1** (PAGE 2), see Figure 6.
2. Use **▲** and **▼** to move up and through each parameter. Use **F2** (left arrow) and **F3** (right arrow) to navigate within each screen entry that is highlighted. See Figures 5 and 6.
3. Press **F4** (RETURN) to store the setup changes and to return to the Main Screen.

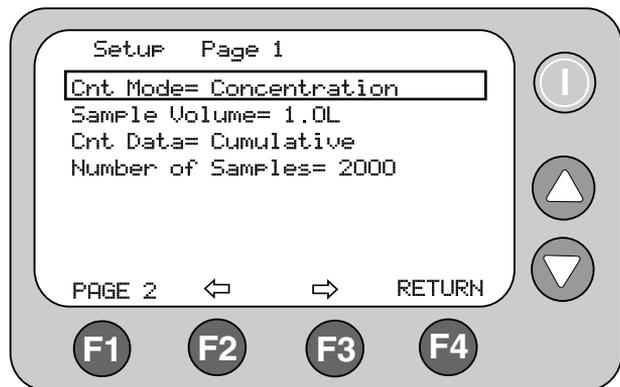

Figure 5. Setup Screen 1

bak02f.eps

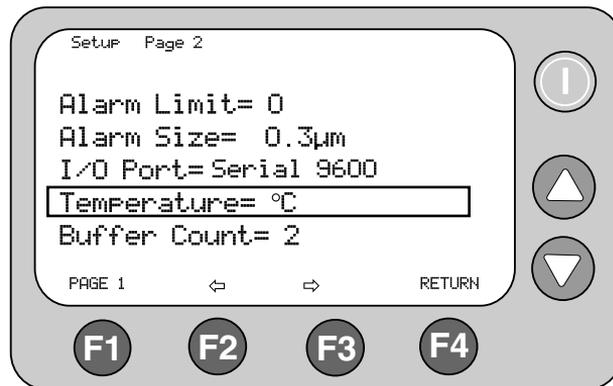

Figure 6. Setup Screen 2

bak06f.eps

The Clock Setup Menu

To use the Clock Setup Menu:

1. From the Main Screen, press **F3** (CLOCK). From the Clock Setup Menu, the user can change the Particle Counter's date, time, and delay, see Figure 7.
2. Use **▲** and **▼** to move the cursor up and down on this screen. Press **F1** (PROGRAM) to enter the edit mode. Once in this mode, **▲** and **▼** are used to increase or decrease the selected entry.
3. Use **F2** (left arrow) and **F3** (right arrow) to change the entry selected.
4. Once the correct data has been entered, press **F1** (ENTER) to store the data.

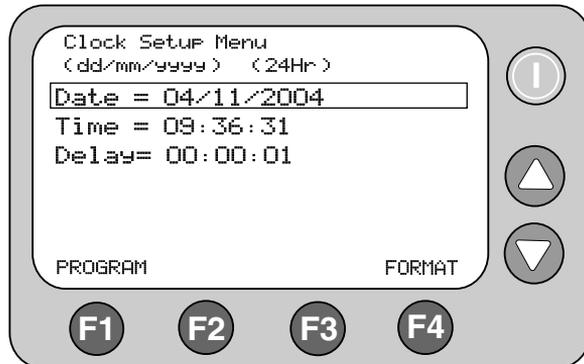

bak04f.eps

Figure 7. Clock Setup Menu

To change the format of the date from dd/mm/yyyy to mm/dd/yyyy:

1. Move the cursor down to Date.
2. Select **F1** (PROGRAM).
3. Select **F4** (FORMAT). The date will switch to the next version.
4. Press **F1** (ENTER) to store the choice.

To use a 24-hour clock or a 12-hour clock:

1. Move the cursor down to Time.
2. Select **F1** (PROGRAM)
3. Select **F4** (FORMAT). The clock will switch to a 24 or 12-hour version.
4. Press **F1** (ENTER) to store the choice.
5. Press **F4** (RETURN) to return to the Main Screen.

Label Menu

At times, it may be useful to assign labels to different samples. For example, to name samples taken from different areas or rooms. To select sample labels, use the Label Setup Menu, see Figure 8.

To use the Label Setup Screen:

1. From the Main Screen, press **F4** (LABEL).
2. Once at the Label Setup Menu, use **▲** and **▼** to select the name of the label.
3. Press **F4** (RETURN) to return to the Main Screen. Notice that the Main screen now has the sample label in the upper right hand corner.

Use these labels 1-75, or use the Fluke 983 Utility software provided to change the label names. Refer to “About the Fluke 983 Utility Software”.

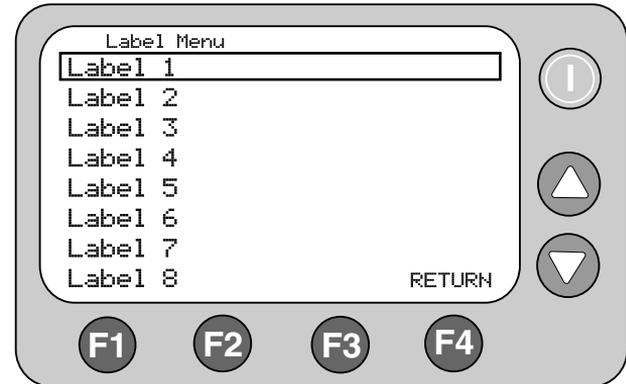

bak05f.eps

Figure 8. Label Menu

Using the Particle Counter

The following sections give detailed information about using the Particle Counter.

Purging the Particle Counter

Before taking particle samples, the Particle Counter should be purged using the Zero Count Filter.

Purging the Particle Counter will make sure the readings are accurate. To purge the Particle Counter:

1. Fit the Filter Adapter onto the end of the Zero Count Filter. Note the arrow on the filter denoting airflow direction.
2. Connect the adapter directly onto the end of the Isokinetic Probe.
3. Operate the unit for approximately 5 minutes.
4. Verify the data on the display:
 - On the average, not more than one particle greater than 0.3 μm in five minutes or not more than one particle per 0.5 cubic foot should be apparent.
 - Once the unit has been purged, resume normal use. Remove the zero count filter from the Isokinetic Probe.

In a clean-room application, the zero count filter verifies that the counter is not counting electrical noise signals from internal components and is not subject to external interference. In other applications, the zero count filter purges the sensor immediately after a high-concentration

sampling. If the unit fails, see “Purging the Particle Counter Sensor”.

Set Up

To set up the Particle Counter:

1. Go through the different screens and set the desired parameters for sampling. Refer to previous sections regarding the different screens and menus.
2. Select the desired intake device. There are two Isokinetic Probes that ship with the Particle counter:
 - The Isokinetic Probe is attached when the Particle Counter ships and is for general use.
 - The Barbed Isokinetic Probe connects to the High Purity Tubing. Use the intake nozzle, tubing, and Barbed Isokinetic Probe for areas where the Particle Counter would not normally fit. See Figure 9.

Caution

Remove the Isokinetic-Probe Cover (the black cap) before use. Not doing so can damage the Particle Counter.

To use the Particle Counter in hard to reach areas, do the following:

1. Unscrew the threaded Isokinetic Probe.
2. Replace it with the intake nozzle.
3. Connect the high purity tubing to the intake nozzle.
4. Connect the Barbed Isokinetic Probe to the open end of the tubing.

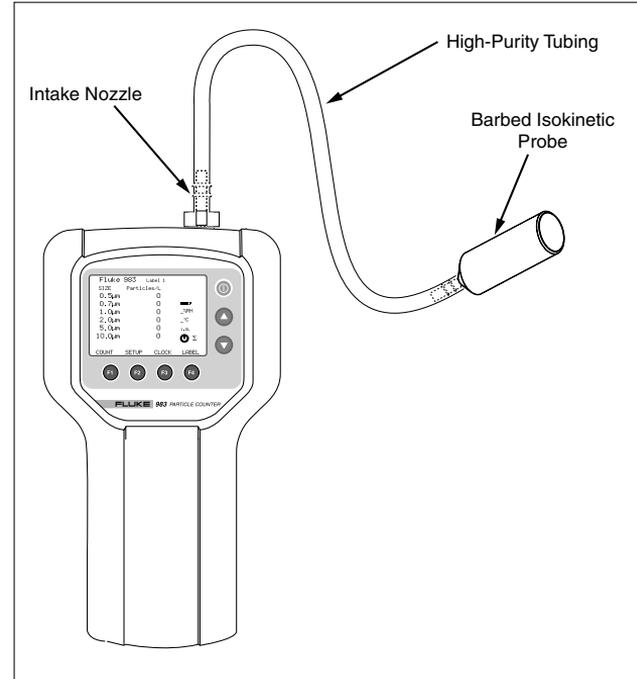

bak10f.eps

Figure 9. Using the High-Purity Tubing and Barbed Isokinetic Probe

Setting the Particle Counting Mode

The Particle Counting Mode choices are:

Concentration Mode

In Concentration Mode, the Particle Counter samples a small volume of air and calculates what the value would be for the volume setting on the Particle Counter (liter, cubic foot, etc.). This mode is useful for taking a quick glimpse of airborne particle contamination levels. For example, Concentration Mode might be used in areas where particulate levels are unknown and may exceed the operating levels of the Particle Counter. This mode should not be substituted for full sampling.

Totalize Mode

In Totalize mode, the counts are seen as they accumulate until the end of the sample. When the sample is complete, the record is stored and the value appears on the screen until the next sample is started.

Audio Mode

In Audio mode, the Particle Counter beeps once each time the alarm limit is exceeded, (see "Setting the Alarm"). For example, if the limit is set to 10, the counter beeps when the count first reaches 10 and beeps again for each multiple of 10. In Audio Mode, the display shows counts as in Totalize Mode.

1. On Page 1 of the Setup Screen, use ▲ and ▼ to highlight "Cnt. Mode". If coming from the Main Screen, Cnt Mode should already be highlighted.

2. Use F2 (left arrow) and F3 (right arrow) to select other modes.
3. When the desired mode shows on the screen, press F4 (RETURN) to select that mode and return to the Main Screen.

Setting the Air Sampling Volume or Sampling Time

The choices for the sample volume setting are:

- 1.0L (counts for 21 seconds)
 - 2.83L (60 seconds)
 - 10.0L (3.53 minutes)
 - 28.3L (10 minutes)
 - 0.01CF (6 seconds)
 - 0.1CF (60 seconds)
 - 1.0CF (10 minutes)
 - MANUAL - Select this option to continuously sample and display the counts until the unit is stopped manually. The display shows the total volume sampled in Liters.
1. On Page 1 of the Setup Screen, use ▲ and ▼ to highlight "Sample Volume" or "Sample Time".
 2. To select a sample volume, sample time, or to manually stop the Particle Counter, press F2 (left arrow) and F3 (right arrow).

If Sample Time CF or Sample Time L is selected:

3. Press **F1** (EDIT) to edit the sampling time.
4. Press **F2** (Min) to highlight the minutes digit.
5. Press **F3** (Sec.) to highlight the seconds digit.
6. Once the minutes or seconds digits are selected use **▲** and **▼** to change the values.
7. Press **F1** (SAVE) to save the settings and return to the previous screen.
8. Press **F4** (ESCAPE) to return to the previous screen without saving changes.
9. Press **F4** (RETURN) to select the desired volume/time and return to the Main Screen. The volume selected appears on the right of the Main Screen.

In Sample Time mode the display shows the calculated volume in either liters or cubic feet, based on the time selected.

Setting the Method of Counting Data

The choices for data counting are:

Cumulative

Cumulative counting mode includes all particles that are greater than or equal to the particle size selected in the Sample Volume field.

Differential

Differential counting mode includes all particles that are greater than or equal to the particle size selected in the Sample Volume field, but less than the next largest particle size.

1. On Page 1 of the Setup Screen, use **▲** and **▼** to highlight "Cnt. Data".
2. Use **F2** (left arrow) and **F3** (right arrow) to change the method of counting data.
3. Press **F4** (RETURN) to select the desired data counting method and to return to the Main Screen.

The method selected appears as a symbol on the display. The SUM symbol (Σ) denotes the Cumulative method and the DELTA symbol (Δ) denotes the Differential method.

Setting the Number of Samples

1. From the Main Screen, press **F2** (SETUP).
2. From page one of the Setup Screen, use **▲** or **▼** to highlight "Number of Samples".
3. Select the number of samples by pressing **F2** (left arrow) or **F3** (right arrow).
4. When the desired number appears, press **F4** (RETURN) to return to the Main Screen.

Note

When choosing the number of samples, "INF" denotes infinite and the unit will continue to take samples until the stop key is pressed.

Setting the Alarm

When the alarm is set, the Particle Counter will continuously beep when the selected number and particle size is reached. The display also shows "CNT Alarm".

1. From the Main Screen, press **F2** (SETUP) to access Setup Screen Page 1.
2. Press **F1** (PAGE 2) to access Setup Screen Page 2.
3. Alarm Limit is highlighted. Press **F2** (left arrow) or **F3** (right arrow) to move the alarm limits from zero (no alarm) to 100,000 in factors of 10.
4. Once the alarm limit is selected, press **▼** to select "Alarm Size".
5. Press **F2** (left arrow) and **F3** (right arrow) to display the various particle sizes.

6. Select the desired particle size and press **F4** (RETURN) to return to the Main Screen.

Note

*When the alarm sounds, pressing **F1** (STOP) once will mute the alarm. Pressing **F1** (STOP) again will stop the sample.*

Setting a Delay Between Samples

If continuous sampling is not necessary, a delay can be set. The delay timer allows a "time out" between automatic samplings. To set a delay:

1. Go to the Clock Setup Screen by pressing **F3** (CLOCK). See Figure 7.
2. Press **▼** and highlight Delay.
3. Press **F1** (PROGRAM).
4. Use **F2** (left arrow) and **F3** (right arrow) to move to the desired unit of time (hours, minutes, or seconds).
5. Press **▲** to increase the time; press **▼** to decrease the time.
6. Once the desired time has been selected, press **F1** (ENTER).
7. Press **F4** (RETURN) to return to the Main Screen.

Note

The maximum delay time is 23:59:59.

Setting Temperature Mode

To set the Temperature Mode to Fahrenheit or Celsius:

1. Go to setup screen 2 and press \blacktriangledown or \blacktriangle to move the cursor to "Temperature".
2. Use F2 (left arrow) and F3 (right arrow) to select "°F" or "°C".
3. Press F4 (RETURN) to save the choice and return to the Main Screen.

Restoring Default Settings

At some point, it may be necessary to restore the Particle Counter's default settings. Restore the default settings by pressing and holding F1 as the power is turned on. The default settings are as follows:

Setup Page 1

Cnt Mode = Concentration

Sample Volume = 1.0L

Cnt Data = Cumulative

Number of Samples = 1

Setup Page 2

Alarm Limit = 0

Alarm Size = 0.3 μ m

I/O port = Serial 9600

Temperature = °C

Buffer Count = 0

Transferring Data to a Personal Computer

Data that is collected and stored in the Particle Counter's buffer can be downloaded to a personal computer (PC) using the Fluke 983 Utility Software included on the CD. The records are saved in a comma-separated variable (CSV) file so they can then be viewed in any analysis program that uses CSV formatting. Use the Fluke 983 Utility Software to change labels, set the time, set delay time, and start and stop a sample that is from a remote location. When exiting the software, all settings are saved. All parameters required by the download utility are stored in the initialization file.

Installing the Fluke 983 Utility Software

The Fluke 983 Utility software must be loaded on a personal computer (PC) before use.

To install the software on a PC:

1. Load the CD into the PC CD-ROM drive.
2. From the CD interface, click the "Install 983 Utility Software" button.
3. The software-extract file launches. Although the software installs to "C:\fluke983", a user may, at this time, designate another install location. Use the "Browse" button to select the directory of choice. The user may also create and name an install folder.
4. Once a directory has been selected, select "Unzip". The software files (Fluke983Utility.exe, Fluke983.ini, and Readme.txt) are deposited into the directory on the PC and the program launches.

Note

To use the utility software, the Particle Counter must be connected to a PC.

Connecting the Particle Counter to a PC

To connect the Particle Counter to a PC:

1. Connect the RJ-45 converter to the serial-communications port of the PC.
2. Connect the modular RS-232 cable to the RJ-45 converter and to the Particle Counter. Make sure the Particle Counter is off when making the connection.
3. Turn the Particle Counter on.
4. Access the utility software on the PC and run the program by clicking Fluke983Utility.exe.

Note

If the desired Communication port is other than COM1, open the Fluke983.ini file in a text editor and change "Port=Com1" to the desired Com port. Close the Fluke983.ini file.

About the Software

The software allows the Particle Counter to be used via PC interface. The software screen (Figure 10) is separated into different sections: Control, Labels, Data, Download Format, Time, and Delay Time. The following explains the software sections in greater detail.

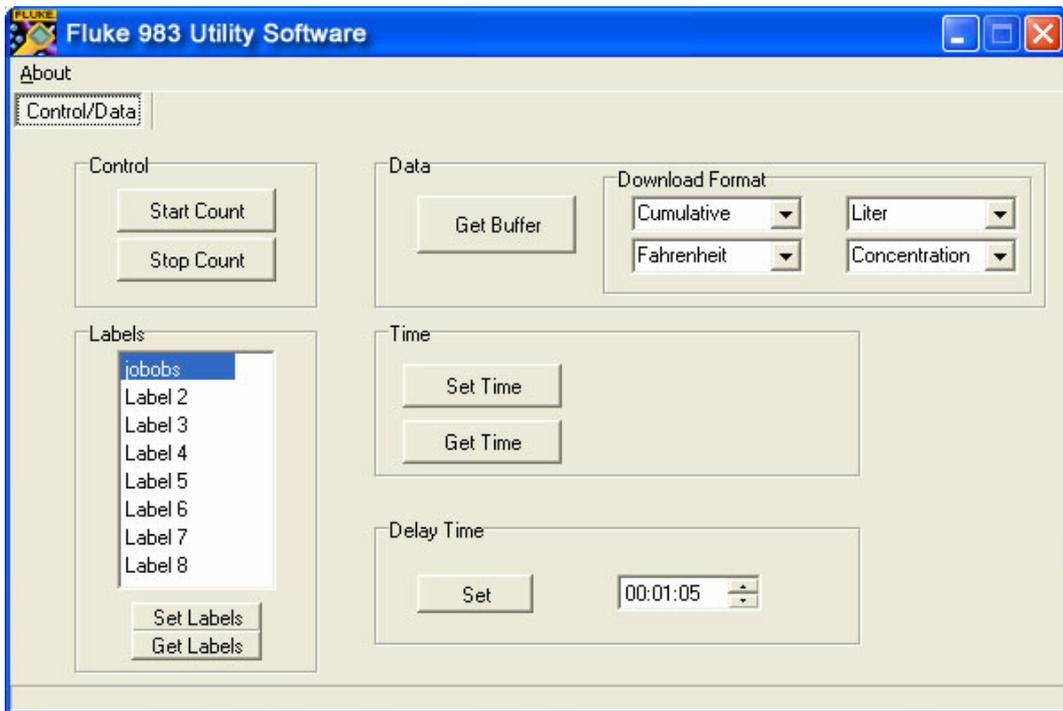

bak11s.bmp

Figure 10. Particle Counter Utility Software Screen

Control

Start Count

Press “Start Count” to start the Particle Counter counting.

Stop Count

Press “Stop Count” to stop the Particle Counter counting.

Labels

The sample label names can be changed by highlighting the name and typing in the desired name.

Set Labels

Press “Set Labels” to send labels in the edit window to the Particle Counter. Labels that are longer than 10 characters long are truncated on the Particle Counter when the “Set Labels” button is pressed.

Get Labels

Press “Get Labels” to read labels from the Particle Counter in the edit window.

Data

Get Buffer

If the Particle Counter is connected to the PC and there are samples stored in the unit’s buffer, the data can be downloaded and saved to any directory on the PC. The directory selected will be saved in the Fluke983.ini and will become the new default directory. See “The CSV File” for more information.

Note

If the Particle Counter is turned off while the software screen is active, or there are no samples stored in the memory buffer, the “Get Buffer” button will be non-active. The software will need to be restarted with the Particle Counter on and at least one sample needs to be stored.

Download Format

Use the four combo boxes under “Download Format” to select the desired download format:

- Cumulative or Differential
- Celsius or Fahrenheit
- Liter, Cubic Foot, or Cubic Meter
- Counts or Concentration

The utility software converts stored unit data to the preferences set in the software.

Note

Download format settings do not change the Particle Counter Settings.

Time

Set Time

Press “Set Time” to set the Particle Counter time and date to that on the PC.

Get Time

Press “Get Time” to read the date and time on the Particle Counter and display it to the right of the “Get Time” button on the software screen.

Note

Format is dd/mm/yyyy and 24-hour time only.

Delay Time

Set

The Particle Counter can be set to take measurements at predetermined intervals. To set the interval, press “Set” and specify the delay time in the box to the right of the “Set” button. The format of the time in the box must be HH:MM:SS with all fields entered. When “Start Count” is pressed, the Particle Counter begins taking samples. After it takes a sample, it stops for the delay time that has been entered. When the delay time expires, the Particle Counter will then begin to count again.

Note

The maximum delay is 23:59:59.

The CSV File

The data from the Particle Counter is stored in a comma-separated variable (CSV) file. The data saved is in the following columns:

- Location
- LocationNumber
- Date
- Time
- Size1
- Size2
- Size3
- Size4
- Size5
- Size6
- Temperature
- Humidity
- Flags
- Volume

The following codes can appear in the “Flags” column individually or in combination:

0 = Normal

1 = Sensor Error

Samples are invalid, indicates a calibration failure or sensor failure condition.

2 = Count Alarm

The user-settable alarm limit has been exceeded.

4 = Low Battery

The battery charge was low during the sample. Recharge the battery as soon as possible.

8 = Counter Error

Samples are invalid. This flag indicates a hardware problem.

Downloading the Samples

Using the software, RJ-45 adapter, and the RS-232 Modular Cable, samples can be downloaded to a PC.

To download samples:

1. Press “Get Buffer”. A file saving dialog appears.
2. Enter a file name and press “Save”. The data is saved to the software directory as a .CSV file. See “The CSV File” for more information.
3. View or print the .CSV file using any program that can view .CSV files and the PC’s normal print settings.

Storing Samples

The Particle Counter stores each measurement in a 5000-record buffer. Data is stored in a “first in, first out” order. When the 5001st record is saved, the first record is deleted, leaving 5000 records total.

Clearing the Buffer

At some point, the user may wish to clear the Particle Counter’s buffer. To do this:

1. Go to Setup Screen 2 and press  or  to move the cursor to “Buffer Count”. Buffer Count displays the number of samples stored in memory.
2. Use  (left arrow) and  (right arrow) to select “Clear Buffer”.
3. Press  (RETURN) to clear the buffer and return to the Main Screen.

Maintenance

Warning

The Particle Counter contains no user-serviceable parts. To avoid electric shock, injury, or damage to the Particle Counter, do not open the instrument. For service and battery replacement, the instrument must be sent to Fluke. See “Contacting Fluke”.

Use the Zero Count Filter to ensure that the Particle Counter filter is free of contamination. Refer to “Purging the Particle Counter”.

Cleaning the Case

Periodically wipe the case and holster with a damp cloth and mild detergent.

⚠ Caution

To avoid damaging the Particle Counter, do not use abrasives or solvents to clean the Particle Counter case.

Charging the Battery and Using the AC Adapter

Recharge the battery as soon as "LOW BATTERY" appears on the display.

The battery symbols on the display show the status of the battery:

-  ++ The battery is in "Fast Charge" mode.
The ac adapter/charger is connected and the battery is charging. When the battery is below 95% of its charge, the Particle Counter uses "Fast Charge" mode to bring the battery back up to 95%.
-  + The battery is in "Trickle Charge" mode. Once 95% of the charge is attained, the Particle Counter switches to "Trickle Charge" mode to charge the remaining 5% of the battery.
-  The battery is fully charged.
-  The battery is partially charged.

The ac adapter is used to recharge the battery as well as power the Particle Counter. This feature allows the counter to be used while the battery is charging.

To connect the ac adapter/charger:

1. Attach the power cord to the end of the charger.
2. Plug the charger into the 12V jack on the base of the Particle Counter.
3. Plug the ac adapter into an ac outlet. The Particle Counter will take two hours to fully charge.

Purging the Particle Counter Sensor

⚠ Caution

To avoid possible damage to the Particle Counter, avoid using the Particle Counter in an excessively dirty or dusty atmosphere. Excessive particle intake can damage the Particle Counter.

To purge the Particle Counter sensor:

1. Fit the adapter onto the end of the Zero Count Filter. Note the arrow on the filter denoting airflow direction.
2. Connect the adapter directly onto the end of the Isokinetic Probe.
3. Operate the unit for approximately 15 minutes.
4. On the average, not more than one particle greater than 0.3 μm in five minutes or not more than one particle per 0.5 cubic foot should be apparent. This purges the Particle Counter.

Once the unit is purged, resume normal use. Remove the Zero Count Filter and adapter from the Isokinetic Probe.

Troubleshooting

Use Table 2 to troubleshoot possible problems with the Particle Counter.

Table 2. Troubleshooting

Problem	Possible Reason and Recommended Actions
Particle Counter does not zero count	<ol style="list-style-type: none">1. Zero count filter or adapter is not properly attached. Reattach the filter or Filter Adapter.2. Internal air leak. Contact Fluke for repair.3. Cell contamination by excessive dust exposure. Return the Particle Counter to Fluke.
Particle Counter does not turn on when pressing the POWER key.	Battery voltage is low. Refer to “Charging the Battery and Using the AC Adapter”. Try turning the unit on again after the ac adapter/charger is connected. If the Particle Counter does not turn on, contact Fluke for assistance.
“LOW BATTERY” displays	Battery voltage is low. Refer to “Charging the Battery and Using the AC Adapter”.
Particle Counter battery does not charge	A problem with the battery is indicated. Disconnect the Particle Counter from the ac adapter/charger. Check the line cord. If the problem persists, contact Fluke.
Display is too dark or light	The display contrast is set too low or too high. Turn the unit on, press ▲ to darken the display or ▼ to lighten it.

Table 2. Troubleshooting (cont.)

Problem	Possible Reason and Recommended Actions
Unable to download data in the buffer	<ol style="list-style-type: none"><li data-bbox="568 248 1433 303">1. There is a problem with the connections from the PC to the Particle Counter. Check those connections.<li data-bbox="568 319 1433 374">2. There may be a problem with the software. Refer to the Readme.txt file on the software.
The display shows “CAL FAIL”	<ol style="list-style-type: none"><li data-bbox="568 397 1433 489">1. The sample exceeded the concentration limit (too many particles), which produced a temporary alarm. No corrective measure is required other than to stop sampling in that environment.<li data-bbox="568 505 1433 527">2. The sensor is contaminated. Refer to “Purging the Particle Counter Sensor”.<li data-bbox="568 543 1433 598">3. The laser has dropped below acceptable levels. If the problem persists, contact Fluke.
No temperature/humidity reading or an incorrect reading	Temperature and humidity appear after the sample is in progress. Allow the unit to acclimate to the sampling environment for greater accuracy.

Specifications

6 Particle-Size Channels:

0.3, 0.5, 1.0, 2.0, 5.0, 10.0 μm

Flow Rate

0.1 cfm (2.83 L/min)

Light Source

Laser diode; index guided (26,000 MTBF at 25 °C)

Calibration

PSL particles in air (NIST traceable)

Counting Efficiency

50 % @ 0.3 μm ; 100 % for particles > 0.45 μm
(per JIS B9921:1997)

Zero Count

1 count/5 minute (per JIS B9921:1997)

Coincidence Loss

5 % at 2,000,000 particles per cubic ft.

Relative Humidity

± 7 %, 20 % RH to 90 % RH, non-condensing

Temperature

± 3 °C, 10 °C to 40 °C (50 °F to 104 °F)

Data Storage

5000 sample records (rotating buffer)

Data Recorded

Date, time, counts, relative humidity, temperature, sample volumes, alarms, label

Display

Graphic liquid crystal with backlight

Count Modes

Concentration, totalize, audio

Delay Time

0 to 24 hours

Sample Inlet

Isokinetic probe

Interface

RS-232 and RS-485 via RJ-45

Vacuum Source

Internal pump flow controlled

Dimensions

4.5 " x 8.25 " x 2.25 " (11.43 x 20.96 x 5.72 cm)

Weight

2.2 pounds (1.0 kg)

Environmental

Operating:

10 °C to 40 °C (50 °F to 104 °F), 20 % to 90 % RH,
non-condensing

Storage:

-10 °C to 50 °C (14 °F to 122 °F), Up to 90 % RH,
non-condensing

Power

AC Adapter, 12 VDC at 2.5 A, 90 to 250 VAC, 50 to 60 Hz

Rechargeable Battery

NiMH, 4.8 V at 4.5 Ah; replaceable

Charge time: 2 hours

Continuous Operating Time

8 hours

Standards

Complies with CE, JIS B9921: 1997

Parts and Accessories

To order parts and accessories for the Particle Counter, refer to the following table and figure.

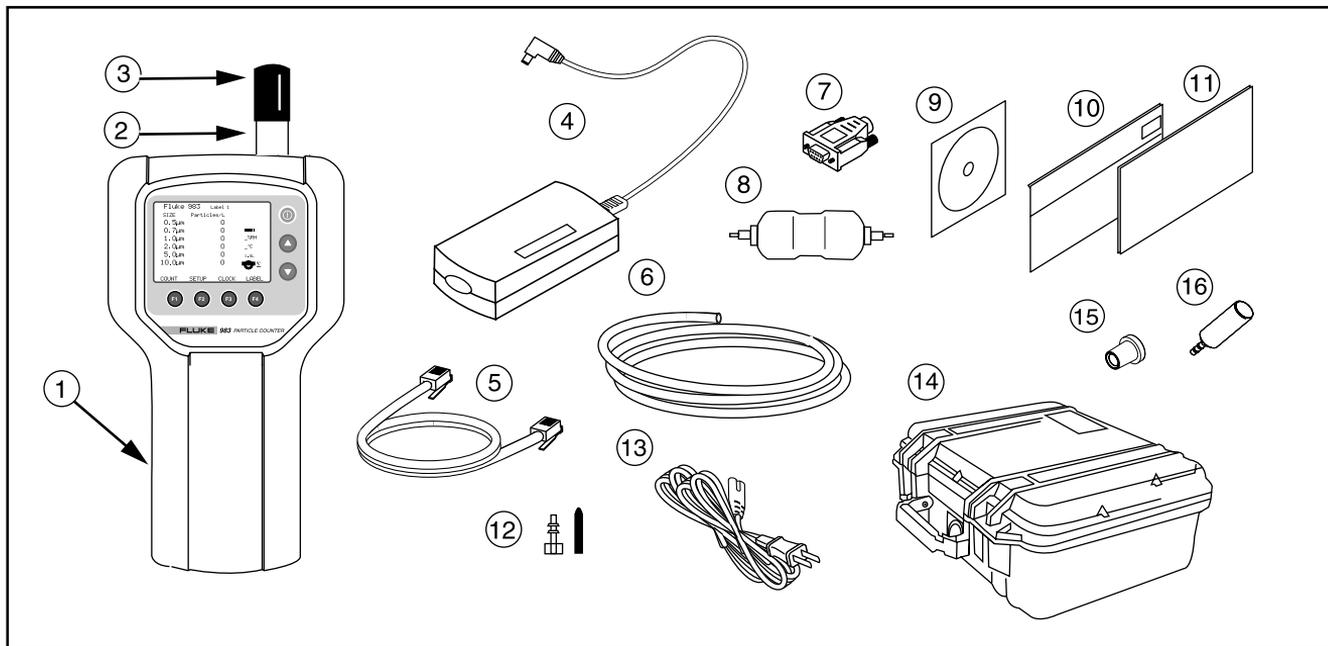

bak09f.eps

Figure 11. Fluke 983 Replaceable Parts

Table 3. Replaceable Parts and Accessories

Callout	Part Number	Description
①	2414654	Holster
②	2421437	Isokinetic Probe
③	2421481	Isokinetic Probe Cap
④	2421350	AC Adapter/Charger
⑤	2421377	RS-232 Modular Cable
⑥	2421455	¼" High Purity Tubing (2 ft.)
⑦	2421392	RJ-45 to DB-9 Connector
⑧	2421428	Zero Count Filter
⑨	2414717	CD (contains translated users manuals and software)
⑩	2414721	Users Manual (English)
⑪	2414700	Safety Information (Multi-language)
⑫	2421443	Intake Nozzle and Cap
⑬	2421361	US Power Cord
⑭	2414693	Hardshell Carrying Case
⑮	2414668	Zero Count Filter Adapter
⑯	2424376	Barbed Isokinetic Probe
Not Shown	669069	Hand Strap (located on the back of the holster)