



© Copyright Agilent Technologies, Inc. 1996, 2000

**Notice**

Information contained in this document is subject to change without notice.

All Rights Reserved. Reproduction, adaptation, or translation without prior written permission is prohibited, except as allowed under the copyright laws.

This material may be reproduced by or for the U.S. Government pursuant to the Copyright License under the clause at DFARS 52.227-7013 (APR 1988).

Agilent Technologies, Inc.  
Learning Products Department  
24001 E. Mission  
Liberty Lake, WA 99019-9599  
U.S.A.

## **Manufacturer's Declaration**

This statement is provided to comply with the requirements of the German Sound Emission Directive, from 18 January 1991.

This product has a sound pressure emission (at the operator position) < 70 dB(A).

- Sound Pressure  $L_p < 70$  dB(A).
- At Operator Position.
- Normal Operation.
- According to ISO 7779:1988/EN 27779:1991 (Type Test).

## **Herstellerbescheinigung**

Diese Information steht im Zusammenhang mit den Anforderungen der Maschinenlärminformationsverordnung vom 18 Januar 1991.

- Schalldruckpegel  $L_p < 70$  dB(A).
- Am Arbeitsplatz.
- Normaler Betrieb.
- Nach ISO 7779:1988/EN 27779:1991 (Typprüfung).

## Safety Considerations

### GENERAL

This product and related documentation must be reviewed for familiarization with safety markings and instructions before operation.

This product has been designed and tested in accordance with *IEC Publication 1010*, "Safety Requirements for Electronic Measuring Apparatus," and has been supplied in a safe condition. This instruction documentation contains information and warnings which must be followed by the user to ensure safe operation and to maintain the product in a safe condition.

### SAFETY EARTH GROUND

A uninterruptible safety earth ground must be provided from the main power source to the product input wiring terminals, power cord, or supplied power cord set.

### CHASSIS GROUND TERMINAL

To prevent a potential shock hazard, always connect the rear-panel chassis ground terminal to earth ground when operating this instrument from a dc power source.

### SAFETY SYMBOLS



Indicates instrument damage can occur if indicated operating limits are exceeded.



Indicates hazardous voltages.



Indicates earth (ground) terminal

---

### WARNING

**A WARNING note denotes a hazard. It calls attention to a procedure, practice, or the like, which, if not correctly performed or adhered to, could result in personal injury. Do not proceed beyond a WARNING sign until the indicated conditions are fully understood and met.**

---

### CAUTION

A CAUTION note denotes a hazard. It calls attention to an operation procedure, practice, or the like, which, if not correctly performed or adhered to, could result in damage to or destruction of part or all of the product. Do not proceed beyond an CAUTION note until the indicated conditions are fully understood and met.

## Safety Considerations for this Instrument

---

**WARNING**

This product is a Safety Class I instrument (provided with a protective earthing ground incorporated in the power cord). The mains plug shall only be inserted in a socket outlet provided with a protective earth contact. Any interruption of the protective conductor inside or outside of the product is likely to make the product dangerous. Intentional interruption is prohibited..

Whenever it is likely that the protection has been impaired, the instrument must be made inoperative and be secured against any unintended operation.

If this instrument is to be energized via an autotransformer (for voltage reduction), make sure the common terminal is connected to the earth terminal of the power source.

If this product is not used as specified, the protection provided by the equipment could be impaired. This product must be used in a normal condition (in which all means for protection are intact) only.

No operator serviceable parts in this product. Refer servicing to qualified personnel. To prevent electrical shock, do not remove covers.

Servicing instructions are for use by qualified personnel only. To avoid electrical shock, do not perform any servicing unless you are qualified to do so.

The opening of covers or removal of parts is likely to expose dangerous voltages. Disconnect the product from all voltage sources while it is being opened.

Adjustments described in the manual are performed with power supplied to the instrument while protective covers are removed. Energy available at many points may, if contacted, result in personal injury.

The power cord is connected to internal capacitors that may remain live for 5 seconds after disconnecting the plug from its power supply.

For Continued protection against fire hazard, replace the line fuse(s) only with 250 V fuse(s) or the same current rating and type (for example, normal blow or time delay). Do not use repaired fuses or short circuited fuseholders.

---

---

**CAUTION:**

Always use the three-prong ac power cord supplied with this product. Failure to ensure adequate earth grounding by not using this cord may cause product damage.

This product is designed for use in Installation Category II and Pollution Degree 2 per *IEC 1010* and *IEC 664* respectively.

This product has autoranging line voltage input, be sure the supply voltage is within the specified range.

Ventilation Requirements: When installing the product in a cabinet, the convection into and out of the product must not be restricted. The ambient temperature (outside the cabinet) must be less than the maximum operating temperature of the product by 4° C for every 100 watts dissipated in the cabinet. If the total power dissipated in the cabinet is greater than 800 watts, then forced convection must be used.

---

**Product Markings**

CE - the CE mark is a registered trademark of the European Community. A CE mark accompanied by a year indicated the year the design was proven.

CSA - the CSA mark is a registered trademark of the Canadian Standards Association.

**CERTIFICATION** *Agilent Technologies, Inc. certifies that this product met its published specifications at the time of shipment from the factory. Agilent Technologies further certifies that its calibration measurements are traceable to the United States National Institute of Standards and Technology, to the extent allowed by the Institute's calibration facility, and to the calibration facilities of other International Standards Organization members*

**WARRANTY** This Agilent Technologies instrument product is warranted against defects in material and workmanship for a period of one year from date of shipment. During the warranty period, Agilent Technologies, Inc. will at its option, either repair or replace products which prove to be defective.

For warranty service or repair, this product must be returned to a service facility designated by Agilent Technologies. Buyer shall prepay shipping charges to Agilent Technologies and Agilent Technologies shall pay shipping charges, duties, and taxes for products returned to Agilent Technologies from another country.

Agilent Technologies warrants that its software and firmware designated by Agilent Technologies for use with an instrument will execute its programming instructions when properly installed on that instrument. Agilent Technologies does not warrant that the operation of the instrument, or software, or firmware will be uninterrupted or error free.

**LIMITATION OF WARRANTY** The foregoing warranty shall not apply to defects resulting from improper or inadequate maintenance by Buyer, Buyer-supplied software or interfacing, unauthorized modification or misuse, operation outside of the environmental specifications for the product, or improper site preparation or maintenance.

NO OTHER WARRANTY IS EXPRESSED OR IMPLIED. AGILENT TECHNOLOGIES SPECIFICALLY DISCLAIMS THE IMPLIED WARRANTIES OF MERCHANTABILITY AND FITNESS FOR A PARTICULAR PURPOSE.

**EXCLUSIVE REMEDIES** THE REMEDIES PROVIDED HEREIN ARE BUYER'S SOLE AND EXCLUSIVE REMEDIES. AGILENT TECHNOLOGIES SHALL NOT BE LIABLE FOR ANY DIRECT, INDIRECT, SPECIAL, INCIDENTAL, OR CONSEQUENTIAL DAMAGES, WHETHER BASE ON CONTRACT, TORT, OR ANY OTHER LEGAL THEORY.

**ASSISTANCE** *Product maintenance agreements and other customer assistance agreements are available for Agilent Technologies products. For any assistance, contact your nearest Agilent Technologies Sales and Service Office.*

# DECLARATION OF CONFORMITY

according to ISO/IEC Guide 22 and EN 45014

Manufacturer's Name: **Agilent Technologies, Inc.**

Manufacturer's Address: **Spokane Division  
24001 E. Mission Avenue  
Liberty Lake, Washington 99019-9599  
USA**

declares that the product

Product Name: **CDMA Mobile Station Test Set**

Model Number: **Agilent 8924C**

Product Options: **This declaration covers all options of the above product.**

conforms to the following Product specifications:

Safety: **IEC 1010-1:1990+A1 / EN 61010-1:1993**

EMC: **CISPR 11:1990/EN 55011:1991- Group 1, Class A  
EN 50082-1 : 1992**

**IEC 801-2:1991 - 4kV CD,8kV AD**

**IEC 801-3:1984 3V/m**

**IEC 801-4:1988 0.5 kV Sig. Lines, 1 kV Power Lines**

## Supplementary Information:

This product herewith complies with the requirements of the Low Voltage Directive 73/23/EEC and the EMC Directive 89/336/EEC and carries the CE-marking accordingly.

Spokane, Washington USA    October 17, 1996



Vince Roland  
Reliability & Regulatory  
Engineering Manager

European Contact: Your local Agilent Technologies Sales and Service Office or Agilent Technologies GmbH  
Department ZQ/Standards Europe, Herrenberger Strasse 130, D-71034 Böblingen, Germany (FAX+49-7031-14-3143)

## **Agilent 8924C Support Contacts**

The documentation supplied with your test set is an excellent source of reference, applications, and service information. Please use these manuals if you are experiencing technical problems:

- Applications information is included in the Agilent 8924C CDMA Mobile Station Test Set Application Guide (Agilent P/N 08924-90021)
- Calibration and repair information are in the Agilent 8924C CDMA Mobile Station Test Set Assembly Level Repair Manual - this manual (Agilent P/N 08924-90001).

If you have used the manuals and still have *application* questions, contact your local Agilent Technologies Sales Representative.

*Repair* assistance is available for the Agilent 8924C CDMA Mobile Test Set from the factory by phone and e-mail. Internal Agilent Technologies users can contact the factory through cc:Mail© (Lotus Corporation). Parts information is also available from Agilent Technologies.

When calling or writing for repair assistance, please have the following information ready:

- Instrument model number (Agilent 8924C)
- Instrument Serial Number (tag located on the rear panel).
- Installed options - if any (tag located on the rear panel).
- Instrument firmware revision (displayed at the top of the screen when the Test Set is powered up, and is also displayed on the CONFIGURE screen).

Support Telephone Numbers:

- 1 800 827 3848 (Spokane Division Service Assistance, U.S. only)
- 1 509 921 3848 (Spokane Division Service Assistance, International)
- 1 800 227 8164 (Agilent Direct Parts Ordering, U.S. only)
- 1 916 783 0804 (Agilent Service Parts Identification, U.S. & Intl.)

Electronic mail (Internet): Spokane\_Service@spk.Agilent .com

cc:Mail: SERVICE, SPOKANE /Agilent -Spokane,desk1



**Table 1 Regional Sales and Service Offices**

|  |  |  |
|--|--|--|
| <p>United States of America:<br/> <b>Agilent Technologies</b><br/>         Test and Measurement Call Center<br/>         P.O. Box 4026<br/>         Englewood, CO 80155-4026</p> <p>(tel) 1 800 452 4844</p>   | <p>Canada:<br/> <b>Agilent Technologies Canada Inc.</b><br/>         5150 Spectrum Way<br/>         Mississauga, Ontario<br/>         L4W 5G1</p> <p>(tel) 1 877 894 4414</p>  | <p>Europe:<br/> <b>Agilent Technologies</b><br/>         European Marketing Organization<br/>         P.O. Box 999<br/>         1180 AZ Amstelveen<br/>         The Netherlands</p> <p>(tel) (3120) 547 9999</p>   |
| <p>Japan:<br/> <b>Agilent Technologies Japan Ltd.</b><br/>         Measurement Assistance Center<br/>         9-1 Takakura-Cho, Hachioji-Shi,<br/>         Tokyo 192-8510, Japan</p> <p>(tel) (81) 456-56-7832<br/>         (fax) (81) 426-56-7840</p> | <p>Latin America:<br/> <b>Agilent Technologies</b><br/>         Latin America Region<br/>         Headquarters<br/>         5200 Blue Lagoon Drive,<br/>         Suite #950<br/>         Miami, Florida 33126<br/>         U.S. A.</p> <p>(tel) (305) 267 4245<br/>         (fax) (305) 267 4286</p> | <p>Australia/New Zealand:<br/> <b>Agilent Technologies</b><br/>         Australia Pty Ltd.<br/>         347 Burwood Highway<br/>         Forest Hill, Victoria 3131</p> <p>(tel) 1 800 629 485<br/>         (Australia)<br/>         (fax) (61 3) 9272 0749<br/>         (tel) 0 800 738 378<br/>         (New Zealand)<br/>         (fax) (64 4) 802 6881</p> |
| <p>Asia Pacific:<br/> <b>Agilent Technologies</b><br/>         24/F, Cityplaza One,<br/>         111 Kings Road,<br/>         Taikoo Shing, Hong Kong</p> <p>(tel) (852) 3197 7777<br/>         (fax) (852) 2506 9233</p>                              |  |  |

## **In this Book**

Throughout this manual the term "Test Set" is used to denote the Agilent 8924C. Test Set screens shown in this manual may not match those displayed on the Test Set in every detail.

### **Chapter 1, Getting Started**

This chapter provides basic remote and front-panel operating procedures, a quick check for verifying operation, GP-IB programming procedures, and simple programming examples.

### **Chapter 2, Configuring Your Test Set**

This chapter provides information about setting screen intensity, setting RF voltage interpretation, setting time and date, and setting the beeper's volume.

### **Chapter 3, Operating Overview**

This chapter explains how to specify units of measure, how to use the analog meter, how to use measurement averaging, how to set a measurement reference, how to set measurement limits, how to enter and change values, how to save and recall instrument setups, how to use the USER keys, and how to set a frequency offset. It also describes some important interactions that occur between screen settings.

### **Chapter 4, Status Reporting**

This chapter provides information about the Test Set's status reporting structure and status register groups.

### **Chapter 5, Memory Cards, Mass Storage**

This chapter describes memory cards and mass storage devices used with the Test Set.

### **Chapter 6, IBASIC Controller**

This chapter is designed to provide the programmer with the information needed to develop IBASIC programs for use on the built-in IBASIC controller.

### **Error Messages**

This section discusses error and operating messages.



---

# Contents

## **1 Getting Started**

Before Connecting a Radio 22

Accessing the Test Set's Screens 23

Changing A Field's Setting 26

Obtaining Measurement Results 30

Control Annunciators 35

Addressing 36

GPIB Command Guidelines 37

Verifying that the Test Set is Operating Properly 42

---

# Contents

## 2 Configuring Your Test Set

General Operating Information 44

### **3 Operating Overview**

To Change the Measurement Display 49

To Enter and Change Values 58

Saving and Recalling Instrument Setups 61

Using USER Keys 65

Setting an RF Generator/Analyzer Frequency Offset 67

Setting an RF Generator/Analyzer Level Offset 68

Interaction Between Screens 69

Printing A Screen 71

Measurement Triggering Process 72

Triggering Analog Measurements In Local Mode (Front Panel Operation) 76

Triggering CDMA Measurements In Local Mode (Front Panel Operation) 79

Triggering Analog Measurements In Remote Mode (GPIB Operation) 82

Triggering CDMA Measurements In Remote Mode (GPIB Operation) 84

Increasing Measurement Throughput 86

Passing Instrument Control 94

---

# Contents

## **4 Status Reporting**

Status Reporting 106

---

## Contents

### **5 Memory Cards/Mass Storage**

|  |     |
|--|-----|
| Default File System                    | 206 |
| Mass Storage Device Overview           | 208 |
| Default Mass Storage Locations         | 215 |
| Mass Storage Access                    | 217 |
| DOS and LIF File System Considerations | 218 |
| Using the ROM Disk                     | 223 |
| Using Memory Cards                     | 224 |
| Backing Up Procedure and Library Files | 230 |
| Copying Files Using IBASIC Commands    | 231 |
| Using RAM Disk                         | 233 |
| Using External Disk Drives             | 235 |



### **6 IBASIC Controller**

Introduction 238

The IBASIC Controller Screen 239

Important Notes for Program Development 241

Program Development 242

Interfacing to the IBASIC Controller using Serial Ports 244

Choosing Your Development Method 257

Method #1. Program Development on an External BASIC Language Computer 259

Method #2. Developing Programs on the Test Set Using the IBASIC EDIT Mode 266

Method #3. Developing Programs Using Word Processor on a PC (Least Preferred) 270

Uploading Programs from the Test Set to a PC 277

Serial I/O from IBASIC Programs 278

PROGram Subsystem 281

The TESTS Subsystem 302

---

## Contents

**Index 337**

---

## Contents

---

# 1 Getting Started

This chapter will help familiarize you with fundamental Test Set operation, including:

- Accessing screens and fields
- Making a simple measurement
- Preparation for remote operation via GPIB

---

## Before Connecting a Radio

---

**NOTE:** The RF IN/OUT port should be used for all transmitter tests when the radio is connected directly to the Test Set. (All MSUT (Mobile Station Under Test) transmitter power measurements are made through this port). Off-the-air measurements can be made using the highly-sensitive ANT IN port.

---

---

**CAUTION:** *Overpower Damage* — Refer to the Test Set's front panel for maximum input power level. Exceeding this level can cause permanent instrument damage.

*Overpower Damage* — Blocking the fans's rotation or operating the Test Set in an environment that causes excessive heat may cause damage.

**Important:** If excessive temperatures are sensed on the power supply regulator assembly, the Test Set's power supply will shut off. After temperature has lowered to within normal operating range, use the POWER switch to cycle power on. Remove RF power from the RF IN/OUT connector whenever the Test Set is off.

---

## Accessing the Test Set's Screens

### CDMA and Analog Modes

The Test Set has two operating modes, analog and CDMA. In CDMA mode, the Test Set configures itself as a calibrated CDMA base station. In Analog mode, the Test Set has AMPS, NAMPS and TACS analog cellular phone test capability.

CDMA is the default power-up mode. To enter analog mode from CDMA mode:

- press one of the ANLG SCRNS keys, or
- select a screen from the Analog **To Screen** menu, or
- programmatically select an analog screen using the display (DISP) GPIB subsystem, or
- execute a CDMA to Analog handoff.

To enter CDMA mode from analog mode:

- press one of the CDMA SCRNS keys, or
- select a screen from the CDMA **To Screen** menu, or
- programmatically select a CDMA screen using the display (DISP) GPIB subsystem.

Accessing the Test Set's Screens

Functions Screens

Screens that control various instrument functions such as configuration, access to the Tests subsystem, and the PREV (previous screen) key are found under the front-panel "Functions" bracket.

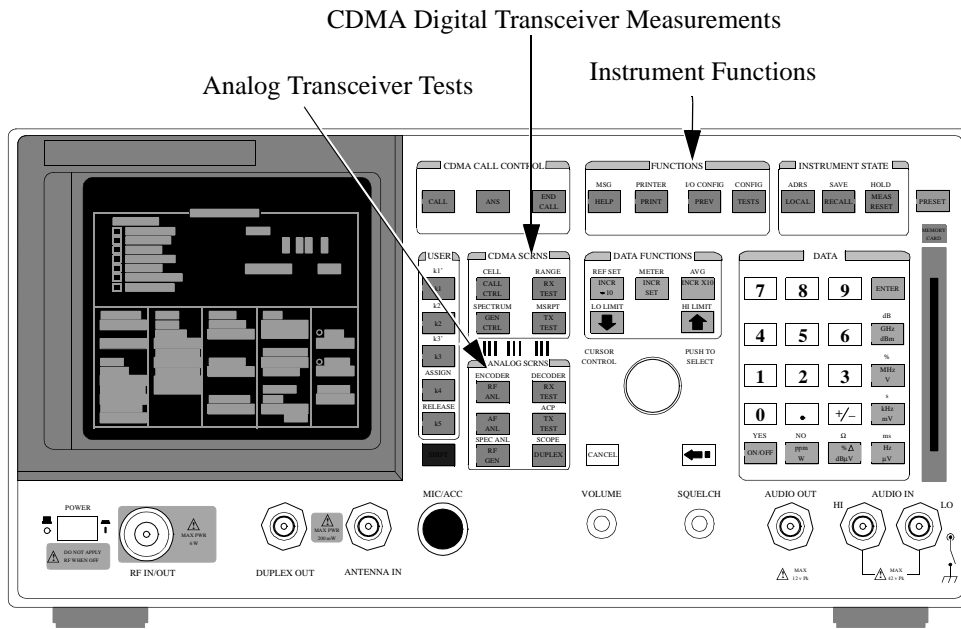
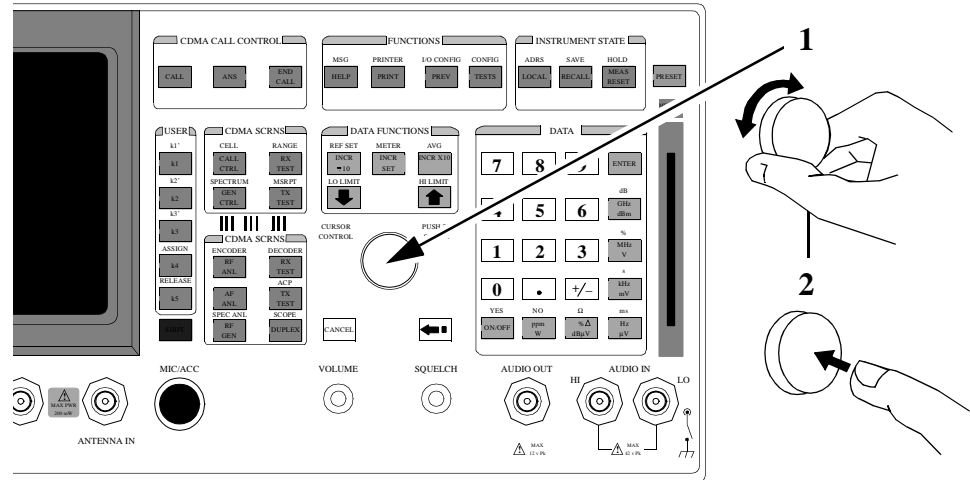

Figure 1 Accessing Test Set Screens

## Accessing the Test Set's Screens

## Cursor Control

**1. Position**

To position the cursor, rotate the Cursor Control knob, which moves the cursor from field to field or from menu item to menu item. Normally the cursor appears as a small highlighted rectangular box.

**2. Select**

To select an item, push the Cursor Control knob. After selection, the background of the item selected becomes highlighted or the item selected appears in an associated field.



## Changing A Field's Setting

There are several types of CRT display fields in the Test Set. This section describes some of the different types of fields, and how they are used.

### Units-of-Measure Field

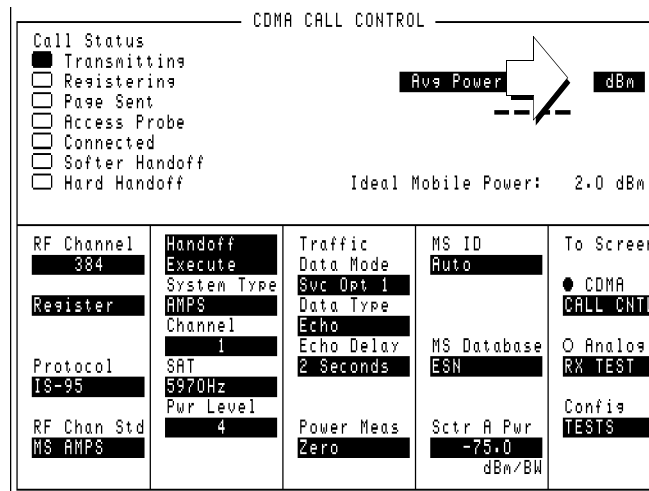

**Figure 2** Units-of-Measure Field

Units-of-measure fields allow selection of valid units for given measurement. See  in figure 2 to see an example of a units-of-measure field.

#### To change a unit-of-measure

1. Position the cursor at the unit field on the display.
2. Press a key labeled with a different unit-of-measure (such as W).
3. If the new units are valid, the measurement value will be displayed in the new unit-of-measure.

To change the units-of-measure for data transfer via GPIB, see "To Specify Units-of-Measure for GPIB Data Transfer" in chapter 3.

## Changing A Field's Setting

**Underlined Immediate-Action Field**

| CDMA CELL         |                            | SITE CONFIGURATION |   |
|-------------------|----------------------------|--------------------|---|
| Protocol<br>IS-95 | Non Power<br>0<br>dB       | Page R<br>Half     | Answer Mode<br>Auto/Manual                                      |
|                   |                            | Num Pages<br>1     | Call Limit<br>None/Page   |
|                   | Init Power<br>0<br>dB      |                    |   |
| Network ID<br>1   | Power Step<br>1<br>dB      |                    |   |
| System ID<br>7    |                            |                    |   |
| Base ID<br>39     | Pan Size<br>10<br>dB       | Srch Win A<br>8    | To Screen<br><input checked="" type="radio"/> CDMA<br>CALL CNTL |
|                   | Num Step<br>4              | Srch Win N<br>8    | <input type="radio"/> Analog<br>RX TEST                         |
| Pilot Inc<br>12   | Max Rea Seq<br>Max Rsp Seq | Srch Win R<br>8    | Config<br>TESTS   |
| Restr NID<br>12   |                            |                    |   |
| Restr SID<br>12   |                            |                    |   |

**Figure 3 Underlined Immediate-Action Field**

Underlined immediate action fields provide a choice of two settings. See  in **figure 3** to see an example of an underlined immediate-action field.

**To change an underlined entry**

1. Position the cursor at the field.
2. Push the CURSOR CONTROL knob or the ENTER key to underline the desired choice.

## Changing A Field's Setting

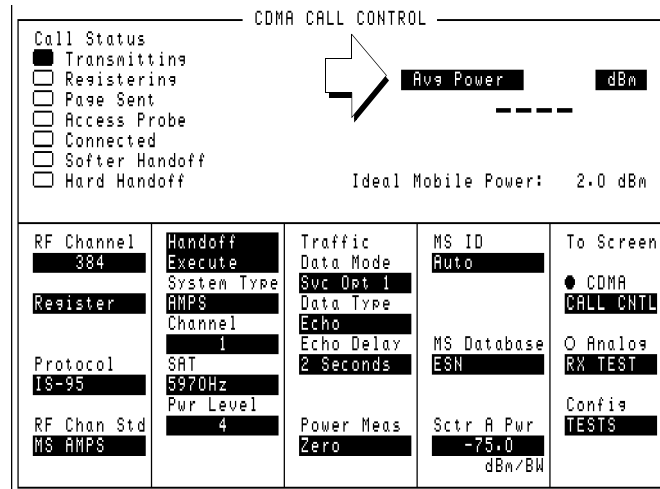
**One-of-Many Field****Figure 4** One-of-Many Field

One-of-many fields display a list of choices when selected. See  in **figure 4** to see an example of a one-of many field.

**To make a one-of-many choice**

1. Position the cursor at the field.
2. Push the CURSOR CONTROL knob or the ENTER key to display the choices.
3. Move the cursor through the choices by turning the knob.
4. Push the CURSOR CONTROL knob or the ENTER key to make the choice.

## Changing A Field's Setting

## Numeric-Entry Field

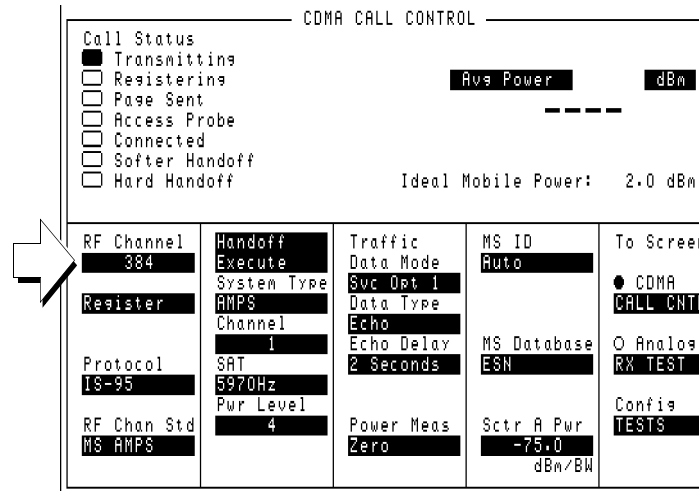



Figure 5

## Numeric-Entry Field

Numeric-entry fields contain numeric values. See  in figure 5 to see an example of a numeric-entry field.

**To change a value**

1. Position the cursor at the field.
2. Key in the desired number using the DATA keys.
3. Press ENTER to select the choice.

OR

1. Position the cursor at the field.
2. Push the CURSOR CONTROL knob to highlight the desired choice.
3. Turn the knob to increment or decrement the value.
4. Push the CURSOR CONTROL knob or the ENTER key to select the choice.

---

## Obtaining Measurement Results

### Setting Up a Call

To obtain CDMA measurements, the Test Set must have the MSUT (Mobile Station Under Test) on a call (the **Connected** annunciator on the CDMA CALL CONTROL screen is lit when the MSUT is on a call).

The procedure for setting up a call is provided in "Setting Up a Call", found in the *Agilent 8924C Application Guide*. In the *Agilent 8924C Application Guide*, there are also procedures for performing CDMA tests.

### Triggering and Displaying Measurements

When operated over the front panel (local control), Test Set measurement results are obtained by selecting a screen that displays the desired measurement, arming the measurement if necessary, and observing the displayed value.

When operated remotely, measurement results are obtained via GPIB by triggering a measurement if necessary and querying the desired measurement field.

---

**NOTE:**

In CDMA mode, transmitter (TX) measurements and receiver (RX) measurements can run concurrently. For example, an Average Power or Channel Power measurement can be queried while the RX TEST screen is selected and an FER measurement is running.

---

For a detailed description of triggering measurements, see "**Triggering and Displaying Measurements**" on page 30.

## Preparing the Test Set for GPIB Control

1. If other GPIB devices are in the system, attach an GPIB cable from the Test Set's rear-panel GPIB connector to any one of the other devices in the test system.
2. Access the I/O CONFIGURE screen and perform the following steps:
  - a. Set the Test Set's GPIB address using the **GPIB Adrs** field (see "Addressing" on page 36).
  - b. Set the Test Set's GPIB Controller capability using the **Mode** field.
    - **Talk&Listen** configures the Test Set to be controlled through GPIB with an external controller. The Test Set has Active Controller capability (take control/pass control) in this mode.
    - **Control** configures the Test Set to be the system controller. Use this setting if the Test Set will be the only controller on the GPIB. Selecting **Control** automatically makes the Test Set the active controller.

---

**NOTE:** Only one active controller is allowed on the GPIB at one time!

3. If an GPIB printer is or will be connected to the Test Set's rear-panel GPIB connector, perform the following steps:
  - a. Access the PRINT CONFIGURE screen.
  - b. Select one of the supported GPIB printer models using the **Model** field.
  - c. Set the **Printer Port** field to GPIB.
  - d. Set the printer address using the **Printer Address** field.

## General Programming Procedure

1. For each measurement you want to perform programmatically, make the measurement manually using the front-panel controls of the Test Set. You will find procedures for making measurements in the *Agilent 8924C Application Guide*. Record, in sequential order, the screens selected and the settings made within each screen.
2. Record the measurement result(s).
3. Develop the program using the measurement procedure generated in step 2. For CDMA measurements, the *Agilent 8924C Application Guide* provides step-by-step GPIB command examples.
4. Make sure the desired measurement is selected and in the ON state. This is the PRESET state for most measurements. However, if a previous program has set the state to OFF, no measurement result will be available. Attempting to read from a measurement field that is not in the ON state will cause **GPIB Error:-420 Query UNTERMINATED**.
5. Trigger the desired measurement if the RETRigger MODE is SINGLE. You will find that the Test Set automatically enters REPetitive trigger MODE for CDMA measurements when an GPIB command is sent to it.
6. Send the appropriate MEASure query command to initiate a reading. This will place the measured value into the Test Set's Output Queue.
7. Use the ENTER statement to transfer the measured value to a variable within the context of the program.

## Obtaining Measurement Results

**Basic Programming Examples**

The following examples illustrate the basic approach to controlling the Test Set through the GPIB. The punctuation and command syntax used for these examples is given in "Command Punctuation" on page 38.

The bus address 714 used in the following BASIC language examples uses an GPIB interface at select code 7, and a Test Set GPIB address of 14. All examples use an external controller.

**To Change a Field's Setting**

1. Access the screen containing the field whose setting is to be changed by using the DISP command.
2. Make the desired setting using the proper command syntax (refer to "GPIB Command Syntax" chapter in the *Agilent 8924C Condensed Programming Reference Guide* for proper syntax).

The following example makes several instrument setting changes:

```
OUTPUT 714;"DISP CCNT"!Displays the CDMA CALL CONTROL screen.
OUTPUT 714;"CDMA:CELL:ASEC -100"!Sets Sector A Power to -100 dBm/BW.
OUTPUT 714;"RFG:OUTP 'DUPL'"!Sets the Output Port to Duplex.
```

**To Read a Field's Setting**

1. Access the screen containing the field whose setting is to be read using the DISPLAY command.
2. Use the query form of the syntax for that field to place the setting's value into the Test Set's output buffer.
3. Enter the value into the correct variable type within the program's context.

The following example reads the current power measurement selection (Average Power or Channel Power).

```
10 OUTPUT 714;"DISP CTXT" !Displays the CDMA CELLULAR MOBILE TRANSMITTER TEST screen.
20 OUTPUT 714;"CDMA:TX:POW:MEAS?" !Queries the Average Power/Channel Power field.
30 ENTER 714;Pow$ !Enters the returned value into a string variable
40 PRINT "The power measurement currently selected is ",Pow$
50 END
```



## Obtaining Measurement Results

**To Make a Simple Measurement**

1. Access the screen containing the desired measurement by using the DISP command.
2. Use the MEAS form of the syntax for that measurement to place the measured value into the Test Set's output buffer.
3. Enter the value into the correct variable type within the program's context (refer to the "Number Measurement Syntax" in GPIB Command Syntax chapter of the *Agilent 8924C Condensed Programming Reference Guide* for the proper variable type).

---

**NOTE:** Whenever a numeric value is queried, the returned value is always in *GPIB Units*. Refer to "**To Specify Units-of-Measure for GPIB Data Transfer**" on page 56.

---

The following example program illustrates how to make settings and then take a reading from the Test Set. This setup takes a reading from the analog spectrum analyzer's marker after tuning it to the RF generator output frequency.

```

10 Addr=714
20 OUTPUT Addr;"*RST"! Preset to known state
25 OUPUT Addr;"CONF:OFR 0" !Set the RF frequency offset to 0 MHz.
30 OUTPUT Addr;"TRIG:MODE:RETR SING"! Sets single trigger
40 OUTPUT Addr;"DISP RFG"! Selects the RF GENERATOR screen
50 OUTPUT Addr;"AFG1:FM:STAT OFF"! Turns FM OFF
60 OUTPUT Addr;"RFG:AMPL -66 DBM"! Sets RF Gen amplitude to -66 dBm
70 OUTPUT Addr;"RFG:FREQ 500 MHZ"! Sets RF Gen frequency to 500 MHz
80 OUTPUT Addr;"RFG:AMPL:STAT ON"! Turns RF Gen output ON
90 OUTPUT Addr;"DISP SAN"! Selects SPECTRUM ANALYZER screen
100 OUTPUT Addr;"SAN:CRF 500 MHZ"! Center Frequency 500 MHz
110 ! -----MEASUREMENT SEQUENCE-----
120 OUTPUT Addr;"TRIG"! Triggers reading
130 OUTPUT Addr;"MEAS:SAN:MARK:LEV?"! Query of Spec Anl marker level
140 ENTER Addr;Lvl! Places measured value in variable Lvl
150 DISP Lvl! Displays value of Lvl
160 END

```

The above example is very simple and is designed to demonstrate the fundamental procedure for obtaining a measurement result. Many other factors must be considered when designing a measurement procedure, such as instrument settings, signal routing, settling time, filtering, triggering and measurement speed.

---

## Control Annunciators

The letters and symbols at the top right corner of the display indicate these conditions:

**R** indicates the Test Set is in remote mode. The Test Set can be put into the remote mode by an external controller or by an IBASIC program running on the built-in IBASIC controller.

- **L** indicates the Test Set has been addressed to listen.
- **T** indicates the Test Set has been addressed to talk.
- **S** indicates the Test Set has sent the require service message by setting the service request (SRQ) bus line true. (See "**Status Reporting**" on page 106).
- **C** indicates the Test Set is currently the active controller on the bus.
- **\*** indicates an IBASIC program is running.
- **?** indicates an IBASIC program is waiting for a user response.
- **-** indicates an IBASIC program is paused.

## Addressing

### Setting the Test Set Bus Address

The Test Set's GPIB bus address is set using the **GPIB Adrs** field which is located on the I/O CONFIGURE screen. The Test Set's GPIB address is set to decimal 14 at the factory. To set a different GPIB bus address; select the I/O CONFIGURE screen and position the cursor next to the **GPIB Adrs** field. The address can be set from decimal 0 to 30 using the numeric DATA keys, or by pushing and then rotating the CURSOR CONTROL knob. There are no switches for setting the GPIB bus address in the Test Set. The new setting is retained when the Test Set is turned off.

### Displaying the Bus Address

The Test Set's GPIB bus address can be displayed by pressing and releasing the SHIFT key, then the LOCAL key. The address is displayed in the upper-left corner of the display.

## GPIB Command Guidelines

### Command Names

GPIB commands are not case sensitive. Upper and lower case characters can be used for all commands.

For example, to set the destination of AF Generator 1 to Audio Out, any of the following command strings are valid:

```
"AFGENERATOR1:DESTINATION 'AUDIO OUT'"  
    or  
"afgenerator1:destination 'audio out'"  
    or  
"afgl:dest 'audio out'"  
    or  
"AFG1:DEST 'AUDIO OUT'"  
    or  
"Afg1:Dest 'Audio oUT'"
```

All command names of more than four characters have an alternate abbreviated form. The abbreviated form is presented in uppercase letters in the syntax diagrams.

## Command Punctuation

---

### NOTE:

**Programming Language Considerations:** The punctuation rules for the Test Set's GPIB commands conform to the IEEE 488.2 standard. It is possible that some programming languages used on external controllers may not accept some of the punctuation requirements. It is therefore necessary that the equivalent form of the correct punctuation, as defined by the language, be used for GPIB operation. Improper punctuation will result in **GPIB Error: -102 Syntax Error**.

---

### Using Quotes for String Entries

Quotation marks are used to select non-numeric field settings. The value is entered into the command line as a quoted alphanumeric string.

Quotes are used with all underlined (toggling) and one-of-many (menu choice) fields. (See "To Change a Field's Setting" on page 33.)

For example: to set the RF Generator's **Output Port** field to duplex, the menu choice **Dup1** would be entered into the command string.

```
"RFG:OUTP 'Dup1'"
```

### Using Spaces

When changing a field's setting, a space must always precede the setting value in the command string, regardless of the field type.

```
RFG:FREQ space 850MHZ
```

```
RFG:ATT space 'OFF'
```

### Using Colons to Separate Commands

The GPIB command syntax is structured using a control hierarchy that is analogous to manual operation.

The control hierarchy for making a manual instrument setting using the front-panel controls is as follows: first the screen is accessed, then the desired field is selected, then the appropriate setting is made. GPIB commands use the same hierarchy. The colon (:) is used to separate the different levels of the command hierarchy.

For example: To set the AF Analyzer's input gain to 40 dB, the following command syntax would be used:

```
"DISP AFAN"  
"AFAN:INP:GAIN '40 dB'"
```

### Using the Semicolon to Output Multiple Commands

Multiple commands can be output from one program line by separating the commands with a semicolon (;). The semicolon tells the Test Set's GPIB command parser to back up one level of hierarchy and accept the next command at the same level as the previous command.

For example, on one command line, it is possible to:

1. access the AF ANALYZER screen,
2. set the AF analyzer's input to **AM Demod**
3. set Filter 1 to **300 Hz GPF**
4. set Filter 2 to **3kHz LPF**

```
"DISP AFAN;AFAN:INP 'AM DEMOD';FILT1 '300Hz HPF';FILT2 '3kHz LPF'"
```

The semicolon after the "DISP AFAN" command tells the Test Set's GPIB command parser that the next command is at the same level in the command hierarchy as the display command. Similarly, the semicolon after the INP 'AM DEMOD' command tells the command parser that the next command (FILT1 '300Hz HPF') is at the same command level as the INP 'AM DEMOD' command.

### Using the Semicolon Colon (;:) to Separate Commands

A semicolon followed by a colon (;:) tells the GPIB command parser that the next command is at the top level of the command hierarchy. This allows commands for different instruments to be output on one command line. The following example sets the RF Analyzer's tune frequency to 850 MHz, and then sets the AF Analyzer's input to FM Demod.

```
"RFAN:FREQ 850 MHZ;:AFAN:INP 'FM DEMOD'"
```

## GPIB Command Guidelines

### Using Question Marks to Query Setting or Measurement Fields

The question mark (?) is used to query (read-back) an instrument setting or measurement value. To generate the query form of a command, place the question mark immediately after the command. Queried information must be read into the proper variable type within the program context before it can be displayed, printed, or used as a numeric value in the program.

Queried information is returned in the same format used to set the value (a queried numeric field returns numeric data; quoted string fields return quoted string information).

For example, the following BASIC language program statements query the current setting of the **AFGen 1 To** field:

```
OUTPUT 714;"AFG1:DEST?"!Query the AFGen1 To field.  
ENTER 714;Afg1_to$!Enter queried value into a string variable
```

### Sample GPIB Program

The following program was written on an HP 9000 Series 300 controller using Hewlett-Packard Rocky Mountain BASIC (RMB). To run this program directly in the Test Set's IBASIC Controller:

1. use exclamation marks (!) to comment-out lines 440, 450, and 460 (these commands not supported in IBASIC).
2. change line 70 to Bus = 8 (internal GPIB select code = 8).

## GPIB Command Guidelines

```

10 ! This program generates an FM carrier, measures and displays the
20 ! deviation, and draws the modulation waveform from the oscilloscope
30 ! to the CRT display. For demonstration purposes the
40 ! carrier is generated and analyzed through the uncalibrated input
50 ! path so that no external cables are required.
60 GCLEAR! Clear graphics display.
70 Bus=7! Interface select code of GPIB interface
80 Dut=100*Bus+14! Default Test Set GPIB address is 14
90 CLEAR Bus ! Good practice to clear the bus
100 CLEAR SCREEN ! Clear the CRT
110 OUTPUT Dut;"*RST" ! Preset the Test Set
120 OUTPUT Dut;"DISP DUPL" ! Display the DUPLEX TEST screen
130 OUTPUT Dut;"RFG:AMPL -14 DBM"! Set RF Gen Amplitude to -14 dBm
140 OUTPUT Dut;"AFAN:INP 'FM Demod'" ! Set AF Analyzer input to FM Demod
150 OUTPUT Dut;"AFAN:DET 'Pk+-Max'" ! Set AF Analyzer detector to Peak +/-Max
160 !
170 ! The following trigger guarantees that the instrument will auto-tune and
180 ! auto-range to the input signal before measuring.
190 !
200 OUTPUT Dut;"TRIG" ! Trigger all active measurements
210 OUTPUT Dut;"MEAS:AFR:FM?" ! Request an FM deviation measurement
220 ENTER Dut;Dev ! Read measured value into variable Dev
230 PRINT USING "K,D.DDD,K";"Measured FM = ",Dev/1000," kHz peak."
240 DISP "'Continue' when ready..." ! Set up user prompt
250 ON KEY 1 LABEL "Continue",15 GOTO Proceed ! Set up interrupt on softkey 1
260 LOOP ! Loop until the key is pressed
270 END LOOP
280 Proceed: OFF KEY ! Turn off interrupt from softkey 1
290 DISP "" ! Clear the user prompt
300 !
310 ! Measure and plot an oscilloscope trace to see the waveform shape.
320 DIM Trace(0:416) ! Oscilloscope has 417 trace points
330 OUTPUT Dut;"DISP OSC" ! Display the OSCILLOSCOPE screen
340 OUTPUT Dut;"TRIG" ! Trigger all active measurements
350 OUTPUT Dut;"MEAS:OSC:TRAC?" ! Request the oscilloscope trace
360 ENTER Dut;Trace(*) ! Read the oscilloscope trace into array Trace(*)
370 !
380 ! CRT is (X,Y)=(0,0) in lower left corner to (399,179) upper right.
390 ! (Each pixel is about 0.02 mm wide by 0.03 mm tall, not square.)
400 ! Scale vertically for 0 kHz dev center-screen and +4 kHz dev top
410 ! of screen. Leave the next three lines for external control, or
420 ! comment them out for IBASIC (Test Set stand-alone) control.
430 !
440 PLOTTER IS CRT,"98627A" !Your display may have a different specifier.
450 GRAPHICS ON!Enable graphics to plot the waveform.
460 WINDOW 0,399,0,179
470 !
480 PEN 1 !Turn on drawing pen
490 MOVE 0,89.5+Trace(0)/4000*89.5
500 FOR I=1 TO 416
510 DRAW I/416*399,89.5+Trace(I)/4000*89.5
520 NEXT I
530 END

```



---

## Verifying that the Test Set is Operating Properly

If your Test Set powers-up and displays the CDMA CALL CONTROL screen, but you suspect an instrument problem, the CDMA Mode Quick Check will verify operation of the instrument's basic functions.

### CDMA Mode Quick Check

**NOTE:** This procedure assumes that the Test Set is configured for cellular mobile station testing. If necessary, access the CONFIGURE screen and turn **PCS Intrfc Control Off**. It will then be necessary to cycle power.

1. Remove any cabling from the front-panel connectors.
2. Turn instrument power on (if it is not already on).
3. Press the PRESET key.
4. Press and release the SHIFT key then the TESTS key to access the CONFIGURE screen.
5. Position the cursor in the **RF Display** field, and press the knob to select **Freq**. The **RF Offset** and **(Gen)-(An1)** fields will appear below **RF Display**.
6. Change the **(Gen)-(An1)** value to 0 MHz.
7. Position the cursor in the **Output Port** field and Select **Dupl**.
8. Press GEN CTRL, +/-, 5, 0 ENTER to adjust Sector A Power to -50 dBm/BW.
9. Press and release the SHIFT key then the GEN CTRL key to access the CDMA REVERSE CHANNEL SPECTRUM analyzer screen.
10. Position the cursor in the **Ref Level** field, and press +/-, 1, 0, ENTER to enter a reference level of -10 dBm.
11. The display should show a CDMA signal, approximately 1.23 MHz wide.

If no failure is indicated by this test, but you still suspect a problem, refer to the performance tests information in the *Agilent 8924C Assembly Level Repair Manual*.

---

## 2 Configuring Your Test Set

This chapter will help you prepare the Test Set for operation in your environment. This includes:

- Setting screen intensity
- Setting time and date
- Setting beeper volume

## General Operating Information

The following configuration information discusses general operating information for some of the fields in the CONFIGURE screen.

### To Set Screen Intensity

1. Access the CONFIGURE screen.
2. Select the **Intensity** field.
3. Rotate the knob to change the setting (1=dim, 8=bright).

### To Set RF Voltage Interpretation (50 ohm/emf)

1. Access the CONFIGURE screen.
2. Position the cursor in front of the **RFGen Volts** field.
3. Press the CURSOR CONTROL knob or press the ENTER key to select 50 ohm or emf.

Voltage settings can control either:

- the voltage across a 50-ohm load, or
- the open circuit voltage (emf).

This setting affects the RF Generator and Tracking Generator amplitudes.

## General Operating Information

**To Set the Date and Time**

1. Access the CONFIGURE screen.
2. Select the **Date** field and use the DATA keys to enter the date in the format shown below the field.
3. Select the **Time** field and use the DATA keys to enter the time in the format shown below the field.

The Test Set has a built-in clock that keeps track of the date and time. It is powered by an internal battery to keep it operating when the instrument is off.

**To Change the Beeper's Volume**

1. Access the CONFIGURE screen.
2. Select the **Beeper** field to display the volume choices.
3. Select the desired choice.

The beeper alerts you to important operating and measurement conditions. It beeps any time a message is displayed at the top of the screen. These messages warn you of conditions such as exceeding the RF input level or trying to set a field to an unacceptable value. Therefore, it is recommended that you do not disable the beeper.

General Operating Information

---

## **3 Operating Overview**

The information in this chapter describes how to use many of the operating features of the Test Set, including:

- **"To Change the Measurement Display" on page 49**
- **"To Enter and Change Values" on page 58**
- **"Saving and Recalling Instrument Setups" on page 61**
- **"Using USER Keys" on page 65**
- **"Setting an RF Generator/Analyzer Frequency Offset" on page 67**
- **"Setting an RF Generator/Analyzer Level Offset" on page 68**
- **"Interaction Between Screens" on page 69**
- **"Printing A Screen" on page 71**
- **"Measurement Triggering Process" on page 72**
- **"Triggering Analog Measurements In Local Mode (Front Panel Operation)" on page 76**
- **"Triggering CDMA Measurements In Local Mode (Front Panel Operation)" on page 79**
- **"Triggering Analog Measurements In Remote Mode (GPIB Operation)" on page 82**
- **"Triggering CDMA Measurements In Remote Mode (GPIB Operation)" on page 84**
- **"Increasing Measurement Throughput" on page 86**
- **"Passing Instrument Control" on page 94**

To Change the Measurement Display

---

## To Change the Measurement Display

### Using the On/Off Function

The on/off function is used for the following operations.

- Measurements that are displayed as numbers, or as meters using the METER function, can be turned on and off.
- The data functions REFERENCE, METER, HLIMIT and LLIMIT can be turned on and off.
- Any instrument function that generates a signal can be turned on and off. This includes the CDMA Sector A Power, Sector B Power, and AWGN.
- Trace displays, such as the CDMA Reverse Channel Spectrum Analyzer, cannot be turned off.

The front-panel ON/OFF key is used to turn measurements, instrument functions and data functions on or off.

#### Front-Panel Example

The following front-panel operation turns **Avg Power** off.

1. Move the cursor in front of the unit-of-measure for the **Avg Power** measurement.
2. Press the ON/OFF key. The **Avg Power** measurement field displays the word **OFF** in place of units

The GPIB STATE command corresponds to the front-panel ON/OFF key. You can use 1 in place of on, or 0 in place of off.

#### GPIB Example

The following GPIB command turns off the **Avg Power** measurement.

```
"DISP CCNT;MEAS:CDM:AVGP:STAT OFF"
```



### To Change the Measurement Display

#### To Use the METER Format

The METER function displays measurements graphically. The METER format is available for most measurements. To determine if the METER format is provided for a measurement, position the cursor in front of the measurement's units field and press the knob. If the message "Press ON/OFF, LIMITS, REF, AVG, METER, or units" is displayed, the METER format is provided.

As a measurement is displayed on the meter, the value is also displayed in small digits below the meter. You can specify the high and low end points and number of intervals, or you can use the default meter settings.

1. Position the cursor in front of the measurement's unit-of-measure.
2. Press and release the SHIFT key, then the INCR SET key to select the METER function. The default number of average samples is displayed below the measurement.
3. Select **On/Off** from the **Meters:** field on the CRT display
4. Repeat steps 1 and 2 then select **LoEnd**, **Hi End**, or **Intervals** to enter each meter end point and the meter intervals.
5. Repeat steps 1, 2, and 3 to cancel the meter function.

#### Front-Panel Example

The following front panel operation turns on the **Avg Power** measurement meter.

1. Move the cursor in front of the unit-of-measure for the **Avg Power** measurement).
2. Press and release the SHIFT key, then the INCR SET key to select the METER function, then press the ENTER key. The meter will appear below the measurement units field with default low/high ends and number of intervals. To turn off the measurement meter, repeat this process.

#### GPIB Example

The following GPIB command turns on the **Avg Power** measurement's meter.

```
"DISP CCNT;MEAS:CDM:AVGP:MET ON"
```

To Change the Measurement Display

## To Set a Measurement Reference

The REF SET function establishes a measurement reference point. This allows you to make a direct comparison between two measurement results, or between a measurement standard and the actual measurement results.

Referenced measurements are displayed as either a ratio (dB) or difference between the measured value and the reference.

1. Position the cursor in front of the unit-of-measure for the measurement you want to set the reference for.
2. Press and release the SHIFT key, then the INCR +10 key to select the REF SET function.
3. Enter the reference value.
4. **Ref** appears below the measurement value to indicate that a reference has been set. The measurement field may display a different unit-of-measure, and limit choices for units.

### Front-Panel Example

The following front-panel operation sets a 10 dBm reference for **Avg Power** measurements.

1. Move the cursor in front of the unit-of-measure for the **Avg Power** measurement).
2. Press and release the SHIFT key, then the INCR +10 key.
3. Enter 10 dBm using the DATA keys.

The abbreviation **Ref** will appear below the **Avg Power** measurement field and **Avg Power** measurements will be expressed in dB. Absolute power (mW, W) will not be selectable.

### GPIB Example

The following GPIB command also sets a 10 dBm reference for **Avg Power** measurements.

```
"DISP CCNT;MEAS:CDM:AVGP:REF 10 DBM"
```

### To Change the Measurement Display

## To Use Measurement Averaging

The AVG (average) function allows you to reduce the effects of a rapidly changing measurement by displaying the average value of a number of measurements.

1. Position the cursor in front of the measurement's unit-of-measure.
2. Press and release the SHIFT key, then the INCR  $\times$  10 key to select the AVG function. The default number of average samples is displayed below the measurement.
  - Enter the desired number of measurement samples to be used for calculating the average, or
  - Press the ON/OFF key to use the currently-displayed number of samples.
3. To turn averaging off, position the cursor in front of the unit-of-measure and press release the SHIFT key, then the INCR  $\times$  10 key, then the ON/OFF key to turn averaging off.

### Front-Panel Example

The following front-panel operation averages **Avg Power** measurements over 10 samples.

1. Move the cursor in front of the unit-of-measure for the **Avg Power** measurement.
2. Press and release the SHIFT key, then the INCR  $\times$  10 key to select the AVG function.
3. Enter 10 using the DATA keys and press the ENTER key. The abbreviation **Avg** will appear below the **Avg Power** measurement field.

### GPIB Example

The following GPIB command also averages **Avg Power** measurements over 10 samples.

```
"DISP CCNT;MEAS:CDM:AVGP:AVER 10;AVER:STAT ON"
```

When Averaging is used, the displayed value will ramp (as opposed to step) in response to changes in the measured values.

Pressing the MEAS RESET key clears the measurement history for all measurements and restarts the averaging process.

To Change the Measurement Display

## Setting Measurement Limits

The LO LIMIT and HI LIMIT functions are used to define a measurement “window” to alert you to measurements that are outside these limits. When limits are assigned, **Lo** and/or **Hi** appear by the measurement.

A measurement that goes above or below the defined limits causes three things to happen:

1. A message appears at the top of the screen indicating a limit was exceeded.
2. The **Lo** or **Hi** indicator by the measurement flashes.
3. The Beeper beeps if it is has not been turned off in the CONFIGURATION screen.

Limits are helpful when you can't watch the Test Set display while you are making an adjustment on the equipment you are testing or repairing. They are also a convenient way of alerting you to long-term measurement drift without having to observe the screen.

1. Position the cursor in front of the unit-of-measure for the measurement you are setting limits for.
2. Press and release the SHIFT key, then the down-arrow key to select the LO LIMIT function.
3. Enter the measurement's low limit value and unit-of-measure.<sup>1</sup>
4. Press and release the SHIFT key, then the up-arrow key to select the LO LIMIT function.
5. Enter the measurement's high limit value and unit-of-measure.<sup>1</sup>

To *reset* a limit that has been exceeded:

1. Position the cursor in front of the unit-of-measure for the measurement you assigned the limit to.
2. Press and release the SHIFT key, then the down-arrow (LO LIMIT) or up-arrow (HI LIMIT) key, or press the MEAS RESET key.

To *remove* a limit you have set:

1. Position the cursor in front of the unit-of-measure for the measurement you assigned the limit to.
2. Press and release the SHIFT key, then the down-arrow (LO LIMIT) or up-arrow (HI LIMIT) key, then press the ON/OFF key.

1. The fundamental unit for the LIMITs does not have to be the same as the measurement's units. For instance, when measuring AC Level in Volts, you can set HI and LO LIMITs in units of dBm if desired.

To Change the Measurement Display

### Front-Panel Example

This example sets limits for the **Avg Power** measurement. These limits will indicate if the power level is between  $-5$  dBm and  $+5$  dBm.

1. Position the cursor in front of the unit-of-measure for the **Avg Power** measurement (the default is **dBm**).
2. Press and release the SHIFT key, then the down-arrow key to select the LO LIMIT function.
3. Enter  $-5$  using the DATA keys and press the ENTER key.
4. Press and release the SHIFT key, then the up-arrow key to select the HI LIMIT function.
5. Enter  $5$  using the DATA keys and press the ENTER key.

The **Hi** limit and **Lo** limit annunciators will appear below the **Avg Power** measurement field.

### GPIB Example

The following GPIB command also sets limits for the average power measurement. These limits will indicate if the power level is between  $-5$  dBm and  $5$  dBm.

```
"DISP CTXT:MEAS:CDM:AVGP:LLIM -5;LLIM:STAT ON;;MEAS:CDM:AVGP:HLIM 5;HLIM:STAT ON"
```

The **Hi** limit and **Lo** limit annunciators will appear below the **Avg Power** measurement field.

To Change the Measurement Display

## To Specify Units-of-Measure for CRT Display

Most measurements, data functions, and instrument functions allow you to specify which unit-of-measurement should appear on the CRT display.

1. Position the cursor in front of the present unit-of-measurement.
2. Press the key labeled with the desired unit.

### Front-Panel Example

The following front-panel operation causes the Test Set to display **Avg Power** in units of Watts instead of dBm.

1. Press the PRESET key.
2. Press the CALL CTRL key to access the CDMA CALL CONTROL screen.
3. Move the cursor in front of the unit-of-measure for the **Avg Power** measurement (**dBm**).
4. Press the RATIO W key. The measurement value is changed immediately to display in Watts.

### GPIB Example (DUNits Command)

The following GPIB command causes the Test Set to display **Avg Power** in units of Watts instead of dBm. The DUNits command will only change the Test Set's displayed units, *not the units used for data transfer through GPIB*.

```
"DISP CCNT;MEAS:CDM:AVGP:DUN W"
```

### Displayed Units DUNits Command Mnemonic

|               |                |
|---------------|----------------|
| <b>GHz</b>    | <b>GHZ</b>     |
| <b>MHz</b>    | <b>MHZ</b>     |
| <b>kHz</b>    | <b>KHZ</b>     |
| <b>Hz</b>     | <b>HZ</b>      |
| <b>% Δ</b>    | <b>PCTDIFF</b> |
| <b>V</b>      | <b>V</b>       |
| <b>mV</b>     | <b>MV</b>      |
| <b>μV</b>     | <b>UV</b>      |
| <b>dBμV</b>   | <b>DBUV</b>    |
| <b>W</b>      | <b>W</b>       |
| <b>mW</b>     | <b>MW</b>      |
| <b>dBm</b>    | <b>DBM</b>     |
| <b>dBm/BW</b> | <b>DBM</b>     |
| <b>db</b>     | <b>DB</b>      |
| <b>%</b>      | <b>PCT</b>     |
| <b>s</b>      | <b>S</b>       |
| <b>ms</b>     | <b>MS</b>      |

To Change the Measurement Display

### To Specify Units-of-Measure for GPIB Data Transfer

GPIB Units (UNITs command) are used by the Test Set when sending or receiving numeric values for most field settings and measurement results through GPIB. Some measurements allow a choice of GPIB Units, but changing GPIB Units has no effect on the Display Units or Attribute Units settings.

Attribute Units (AUNits command) are used by the Test Set when sending or receiving numeric values for data functions (Hi and Lo Limits, Reference, Meter, and Averaging) through GPIB. Some measurements allow a choice of Attribute Units, but changing Attribute Units has no effect on the Display Units or GPIB Units settings.

#### GPIB Example (UNITs command)

The following command changes the GPIB Units for the **Avg Power** measurement to **W** (**dBm** is the power-up default setting).

```
"DISP CTXT;MEAS:CDM:AVGP:UNIT W"
```

#### GPIB Example (AUNits command)

The following command changes the Attribute Units for the **Avg Power** measurement to **W** (**dBm** is the power-up default setting).

```
"DISP CTXT;MEAS:CDM:AVGP:AUN W"
```

After receiving this command, the Test Set will use units of Watts for data functions (such as High and Low Limits).

To Change the Measurement Display

**Table 2** Functions with GPIB and Attribute Units That Can Be Changed

| Function                  | Available GPIB Units | Applies to UNITs Command | Applies to AUNits Command |
|---------------------------|----------------------|--------------------------|---------------------------|
| TX Power measurement      | W or DBM             | x                        | x                         |
| Average Power measurement | W or DBM             | x                        | x                         |
| Channel Power measurement | W or DBM             | x                        | x                         |
| Adjacent Channel Power:   |                      | x                        | x                         |
| Lower Ratio, Upper Ratio  | DB or PCT            | x                        | x                         |
| Lower Level, Upper Level  | W or DBM             | x                        | x                         |
| SINAD measurement         | DB or PCT            | x                        | x                         |
| Distortion measurement    | DB or PCT            | x                        | x                         |
| SNR measurement           | DB or PCT            | x                        | x                         |
| RF Generator Amplitude    | W or DBM             | x                        |                           |
| Frequency Error           | Hz                   | x                        | x                         |



## To Enter and Change Values

### To Enter Decimal Values

Values can be entered and changed using various methods, depending on your testing needs. The unit-of-measure for some of these fields can also be changed (see "To Specify Units-of-Measure for GPIB Data Transfer" on page 56).

1. Position the cursor in front of the numeric entry field to be changed.
2. Either:
  - Enter the number and unit-of-measure directly using the keypad, or
  - Press the CURSOR CONTROL knob or the ENTER key to highlight the field, and use the knob, or
  - Use the down-arrow and up-arrow keys to increment or decrement the present value.

#### Front-Panel Example

The following front panel operation changes **Sector A Power** to -73 dBm/BW.

1. Move the cursor in front of the **Sector A Power** field.
2. Enter -73 dBm using the DATA keys.

#### GPIB Example

The following GPIB command also changes **Sector A Power** to -73 dBm/BW.

```
"DISP CCNT;CDMA:CELL:ASEC -73 DBM;ASEC:STAT ON"
```

## To Enter and Change Values

**To Enter Hexadecimal Values**

Hexadecimal (Hex) values are used for entering some signaling parameters, such as MIN (Mobile Identification Number). No unit-of-measure is associated with these values.

Hexadecimal values are either entered from the keypad (using the A-F shifted functions), or by using the **Choices** menu.

**Front-Panel Example**

The following front-panel operation enters the Hexadecimal number #H0D2565F15 into the MIN field.

1. Move the cursor to the field below **MS ID**.
2. If the field currently says **Phone Num** press the ENTER key, use the CURSOR CONTROL knob to select MIN, and press the ENTER key again. (If MIN is already selected, proceed to step 3.)
3. Use the CURSOR CONTROL knob to select the numeric entry field below MIN.
4. Enter 0, then press and release the SHIFT key, then the 3 key (to select D), enter 2565, press and release the SHIFT key, then the 5 key (to select F), enter 15, and then press the ENTER key. This is the hexadecimal code derived from the phone number 321-456-7890.

**GPIB Example**

The following GPIB command also enters the Hexadecimal number 0D2565F15 into the MIN field.

```
"DISP CCNT;CDMA:MOB:MIN `0D2565F15`"
```

## To Enter and Change Values

### To Enter Values With Exponents

#### Front-Panel Example

The following front-panel operation changes **Confidence** (limit) to 95.

1. Press the CALL CTRL key.
2. Move the cursor in front of the **Confidence** field.
3. Enter 9 EEX 1.

The EEX key can be used to enter values in exponential notation. Exponential notation is only allowed on floating-point entry fields.

### To Increment/Decrement Values

Incrementing and decrementing values on the Test Set can be performed from the front panel with the CURSOR CONTROL knob or the up/down arrow keys., or the INCR  $\div 10$  and INCR  $\times 10$  keys.

The INCR  $\div 10$ , INCR  $\times 10$ , and INCR SET keys are used to assign a specific increment value. To change an increment/decrement setting:

1. Move the cursor to the numeric entry field to be changed.
2. To change the current increment/decrement setting by a factor of 10, use the INCR  $\div 10$  or INCR  $\times 10$  keys.
3. To set a specific increment/decrement value, press INCR SET, and enter the desired value.

#### Front-Panel Example

The following front panel operation sets the increment value on the **Sector A Power** field to 3 dB.

1. Press the CDMA SCRNS, CALL CTRL key.
2. Move the cursor in front of the **Sector A Power** field.
3. Press INCR SET, 3, ENTER.
4. Turn the knob or press the up/down arrow keys.

#### GPIB Example

The following GPIB command also sets the increment value on the **Sector A Power** field to 3 dBm/BW, and increments the present value up by 3 dBm/BW.

```
"DISP CCNT;CDMA:CELL:ASEC:INCR 3;INCR UP"
```

---

## Saving and Recalling Instrument Setups

The save and recall functions allow you to store different instrument setups and retrieve them later, eliminating the task of re-configuring the Test Set.

The number of available save registers depends on how many changes were made to the *BASE* instrument setup for each save. (See "**Specifying BASE Settings**" on page 64.) The smaller the number of changes, the greater the number of SAVE registers that can be used (typically over 200).

SAVE/RECALL register settings can be saved to several types of mass storage. This allows you to “back up” the settings in case you need to clear them from memory (see "**Memory Considerations**" on page 64) for running large programs, or when a firmware upgrade is performed.

### To Save an Instrument Setup

1. Press and release the SHIFT key, then the PREV key to access the I/O CONFIGURE screen. Select the storage media using the **Save/Recall** field. (The default storage media is internal memory.)
2. Make any changes to the instrument that you want to save in a register.
3. Press and release the SHIFT key, then the RECALL key to select the SAVE function.
4. Use the DATA keys or the **Save :** menu at the bottom right of the screen to enter the save register name.

#### Front-Panel Example

This example saves the current instrument settings.

1. Press and release the SHIFT key, then the RECALL key to select the SAVE function. A prompt appears at the top of the screen asking you to enter a name.
2. Using the DATA keys, enter 123, then press the ENTER key to assign a name.

#### GPIB Example

The following GPIB command also SAVES the current instrument settings.

```
"REG:SAVE 123"
```

## Saving and Recalling Instrument Setups

### To Recall an Instrument Setup

1. Press and release the **SHIFT** key, then the **PREV** key to access the **I/O CONFIGURE** screen and select the media to recall settings from using the **Save/Recall** field. (The default is internal memory.)
2. Press the **RECALL** key.
3. Use the knob to select the desired setup to be recalled from the **Recall** menu at the bottom right of the screen.

#### Front-Panel Example

This example recalls the current instrument settings.

Press **RECALL**, 1, 2, 3, **ENTER**. The saved instrument settings are recalled.

#### GPIB Example

The following GPIB command also recalls register 123.

```
"REG:REC 123"
```

### To Clear All SAVE Registers

1. Press the **RECALL** key.
2. Use the knob to position the cursor in front of the entry in the **Recall** menu at the bottom right of the screen.
3. Press the knob or the **ENTER** key. A prompt appears at the top of the screen to verify that you want to clear all registers.
4. Press the **ON/OFF** key to select **YES**.

#### GPIB Example

The following GPIB command clears all registers

```
"REG:CLE:ALL"
```

## Saving and Recalling Instrument Setups

**To Remove (Clear) an Individual SAVE Register**

1. Specify where the register is stored using the **Save/Recall** field on the I/O CON-FIGURE screen.
2. Press the RECALL key.
3. Use the knob to position the cursor in front of the register to be removed from the **Re-call** menu at the bottom right of the screen. The register name and percentage of SAVE memory occupied by that register are indicated at the very top of the screen.
4. Press the ON/OFF key. A prompt appears, asking if you want to delete the save register.
5. Press the ON/OFF key to select YES. (Press the RATIO W key to select NO.)

**GPIB Example**

The following GPIB command clears a register

```
"REG:CLE '<quoted string>'"
```

**Choosing Register Names**

You can use any number, letter, or combination of numbers and letters as a name for storing instrument settings. For instance; if you want to save a setup for testing a "Vulcan7" radio, you can save the setting as "VULCAN7".

Two register names are reserved for special purposes: POWERON and BASE.

**Specifying POWERON Settings**

You can specify the instrument setting at power-on by following the procedure described in "To Save an Instrument Setup" on page 61, and choosing the register name POWERON. If a SAVE Register named POWERON is detected by the Test Set during its power-on routine, the Test Set will configure itself using the settings stored in the POWERON register.

**NOTE:**

If the Test Set does not successfully complete its power-on routine because of the POWERON settings (e.g., the Test Set displays a message that requires you to cycle power to recover) you must:

1. Turn off the Test Set.
2. Hold down the PRESET and the Hz/uV keys simultaneously.
3. Turn on power while holding the PRESET and the Hz/uV keys down *until the CALL CONTROL screen appears.*

This procedure will clear all SAVE registers, including POWERON.

## Specifying BASE Settings

The *BASE* register contains any field settings the user has *SAVED* that are different from the instrument *PRESET* state. It establishes a reference point for all future *SAVEs*. (The *PRESET* state is stored in the *BASE* register until you *SAVE* another instrument setup.)

When you *SAVE* an instrument setup, the new setup is compared to the *BASE* settings, and any *differences* are stored under the register name you supply. Because only differences are stored, a much larger number of instrument setups can be saved than if the contents of every field was saved.

When you *RECALL* an instrument setting, every field is reset to the *BASE* settings. The *SAVED* settings are then used to re-establish the desired instrument setup.

You can define your own *BASE* setting. If your desired settings are very different from the *PRESET* values, you may want to change the *BASE* register. This will decrease the amount of memory used to *SAVE* each setup, and allow you to *SAVE* many more setups.

---

### **CAUTION:**

Since each *SAVE/RECALL* register only contains the differences between the setup being saved and the present *BASE* register settings, changing the *BASE* results in all other saved setups being *ERASED* from memory (including the *POWERON* setting if one has been saved).

Unless you consistently change the same fields to the same value each time you use the instrument, you should probably not create your own *BASE* settings.

---

## Memory Considerations

When the *Save/Recall* field of the *I/O CONFIGURE* screen is set to **Internal**, instrument setups are saved to the same non-volatile RAM used to create RAM Disk(s) and run *IBASIC* programs. By saving a large number of instrument setups, you reduce the amount of RAM available to run programs. If you get a “memory overflow” message while trying to load a program, you must clear one or more *SAVE/RECALL* registers to free RAM space).

## Using USER Keys

User keys instantly access instrument settings without using the knob. You can use USER keys to move quickly between fields on the same screen, and to access field settings that are not normally available on the screen you are using.

*Local* USER keys are used to move between settings on the screen that is displayed. When the USER key is pressed, the cursor instantly moves to, and selects, the assigned field; eliminating the need to turn and push the knob. Five local USER keys are available for each screen: K1, K2, K3, K4, and K5.

*Global* USER keys are used to access settings that are not available on the current screen. Three global USER keys are available: K1', K2', and K3'. (These are shifted functions of the local USER keys.)

When defining USER keys, the *ASSIGN* function is used to create key definitions; the *RELEASE* function removes the definitions. Re-assigning a USER key to a different field setting automatically Releases it from the setting it was previously associated with.

### To Assign Local USER Keys

1. Move the cursor to the field you want to assign a local USER key to.
2. Press and release the SHIFT key, then the K4 key to select the ASSIGN function. Press a local USER key (K1-K5). The USER key number appears in front of the field you assigned it to.

#### Example of Assigning a Local USER Key

Use this example to assign local USER key K1 to the **Filter 1** field in the RX TEST screen.

1. Access the RX TEST screen and position the cursor in front of the **Filter 1** field.
2. Press and release the SHIFT key, then the K4 key to select the ASSIGN function.
3. Press K1. A small **1** appears next to the field indicating that USER key K1 has been assigned to it.
4. Move the cursor to any other field on the screen and press K1. The cursor immediately returns to the **Filter 1** field. The field is also highlighted to change the entry using the CURSOR CONTROL knob or arrow keys.



## Using USER Keys

### To Release Local USER Keys

1. Display the screen containing the USER key assignment to be removed.
2. Press and release the SHIFT key, then the K5 key to select the RELEASE function.
3. Press the USER key (K1-K5) that you want to release.

### To Assign Global USER Keys

1. Move the cursor to the field you want to assign a global USER key to.
2. Press and release the SHIFT key, then the k4 key to select the ASSIGN function.
3. Press a global USER key (K1' -K3'). Unlike a local USER key, the USER key number *does not* appear in front of the field you assigned a global USER key to. A prompt appears at the top of the screen confirming the key assignment.

#### Example of Assigning a Global USER Key

Use this example to assign global USER key K1' to the **AF An1 In** field, and then access this field in the OSCILLOSCOPE screen.

1. Access the AF ANALYZER screen and position the cursor in front of the **AF An1 In** field.
2. Press and release the SHIFT key, then the K4 key to select the ASSIGN function.
3. Press and release the SHIFT key, then the K1' key. Notice the prompt **Global User key 1 assigned.** at the top of the screen.
4. Access the OSCILLOSCOPE screen.
5. Press SHIFT, K1'.

**AF An1 Input, FM Demod** is displayed at the top of the screen (assuming the present input is set to FM Demod). To change the input, use the arrow keys, or press the ENTER key to access the **Choices** menu.

A field that is accessed using a global USER key is only displayed at the top of the screen while it is being accessed. Moving the cursor to any other field in the screen causes the USER key field to disappear until it is accessed again.

### To Release Global USER Keys

1. Move the cursor to the field with the global USER key assigned to it.
2. Press SHIFT, K5, SHIFT, and the USER key to be released (K1' -K3').

## Setting an RF Generator/Analyzer Frequency Offset

---

## Setting an RF Generator/Analyzer Frequency Offset

You can set a fixed frequency offset between the RF Generator and the RF Analyzer. At power-up and instrument preset this feature is ON with a transmit/receive frequency offset of 45 MHz.

**NOTE:** A 45 MHz offset is required for making a call or making measurements in CDMA mode.

### To Turn Off RF Frequency Offset

1. Access the CONFIGURE screen.
2. Position the cursor below the **RF Display** field and select **Freq.**
3. Set the **RF Offset** to off.

#### GPIB Example

```
"CONF:OMOD `OFF`"
```

*turns the RF frequency offset off*

### To Change the RF Frequency Offset

1. Access the CONFIGURE screen.
2. Position the cursor below the **RF Display** field and select **Freq.**
3. Set the **RF Offset** to On.
4. Enter an offset frequency ((**Gen**) - (**An1**)).

---

## Setting an RF Generator/Analyzer Level Offset

You can correct for path loss by setting up an RF Level Offset on the front-panel RF connector(s) used in your application. At power-up and instrument preset this feature is OFF with 0.0 dB loss in all connector fields.

An RF Level Offset is required to ensure proper power levels to the analyzer when testing CDMA mobile stations.

Refer to “Determining and Correcting for RF Path Loss” in Calibrating the Test Set chapter of the *Agilent 8924C Application Guide*.

## Interaction Between Screens

Most fields operate *globally*; changing the setting in any screen automatically changes that setting in *all* screens where it is available. **AFGen1 Freq** is an example of this field type.

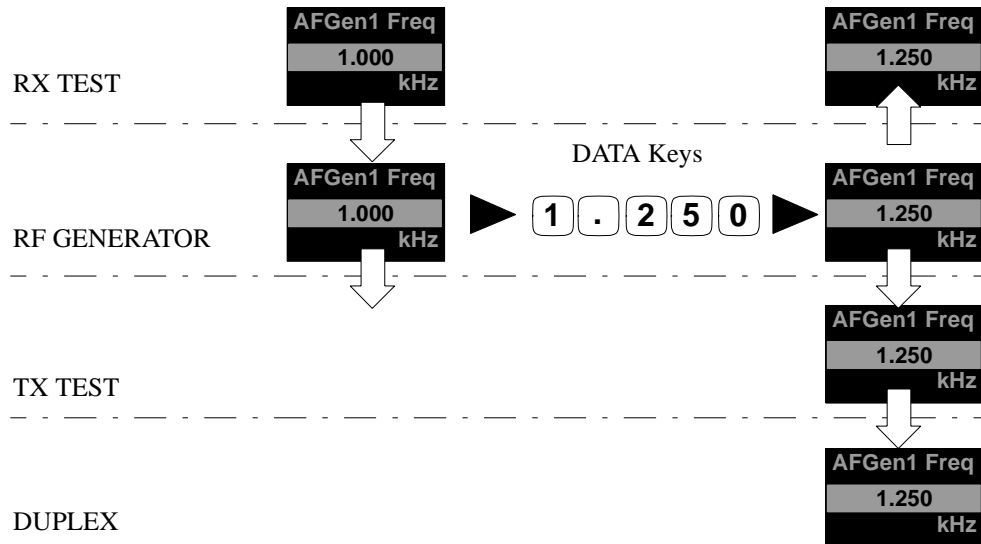

**Figure 6** Example of How Global Fields Work

*Priority* fields give the RX TEST and TX TEST screens priority control of their settings. No matter what these fields were set to in other screens, if the RX TEST or TX TEST screen is accessed, the field changes to whatever it was last set to in these screens. The RF Generator **Amplitude** is an example of this field type. These fields and their preset values are listed in **table 3 on page 70**.

**Table 3** Priority RX TEST and TX TEST Fields

| Priority Field     | RX TEST                         | TX TEST                            |
|--------------------|---------------------------------|------------------------------------|
| RF Gen Amplitude   | Presets to -80 dBm (changeable) | Always Off                         |
| AFGen1 To          | Presets to FM (changeable)      | Always Audio Out                   |
| AF Anl In          | Always Audio In                 | Presets to FM Demod (changeable)   |
| Detector           | Always RMS                      | Presets to Pk +- Max(changeable)   |
| De-emphasis        | Always Off                      | Presets to 750µs (changeable)      |
| AF Anl Measurement | Presets to SINAD (changeable)   | Presets to Audio Freq (changeable) |

Using your Test Set, duplicate the steps in **figure 7** to demonstrate how the priority fields operate.

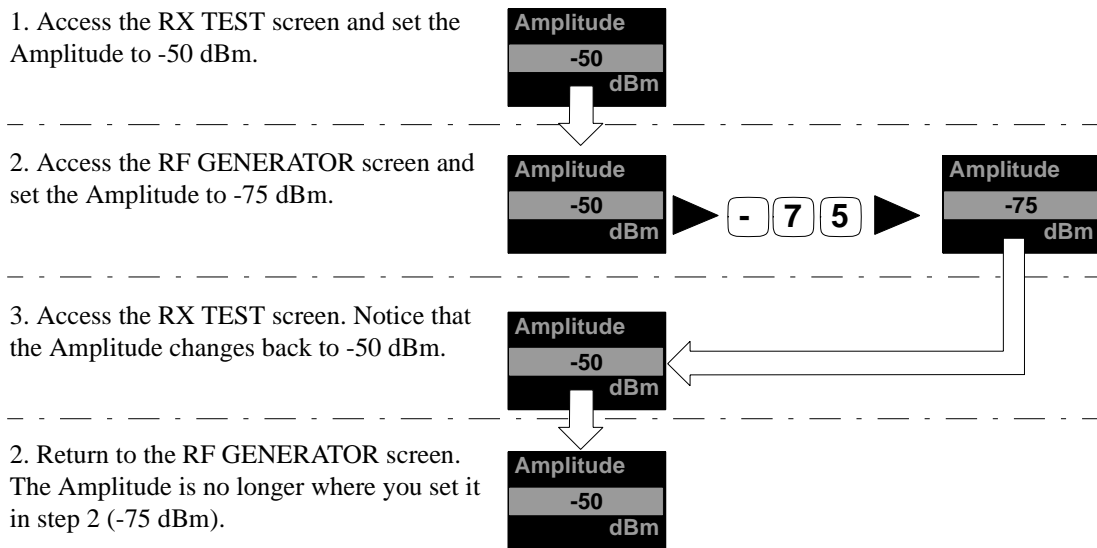

Since the RX TEST screen has priority control over this field, the RF GENERATOR screen's Amplitude setting changed when RX TEST was accessed.

**Figure 7** Example of How Priority Fields Work

## Printing A Screen

### To Print A Screen's Contents

1. Connect a printer to the appropriate rear-panel connector.
2. Press and release the **SHIFT** key, then the **PRINT** key to access the **PRINT CONFIGURE** screen and set the **Printer Port** field to the appropriate type of printer connection.
  - If **GPIB** is selected, enter the **GPIB Printer Address** of the printer.
3. Select the type of printer you are using in the **Model** field. If your printer is not listed, configure your printer to emulate one that is listed.
4. Enter a **Print Title** using the knob (optional). The title will appear at the top of your printout.
5. Display the screen you want to print and press the **PRINT** key.

To interrupt printing, select the **Abort Print** field on the **PRINT CONFIGURE** screen.

---

## Measurement Triggering Process

### Active Measurements

Only active measurements can be triggered and then queried for a measurement result. Within the Test Set, measurements are differentiated between those that are "active" and those that are "not active". The definition of an active measurement is different for analog measurements than for CDMA measurements.

#### Definition of Active CDMA Measurement

All CDMA measurements are "active" if:

- either of the following screens is displayed on the CRT of the Test Set

CDMA CELLULAR MOBILE RECEIVER TEST  
CDMA CELLULAR MOBILE TRANSMITTER TEST

AND

- the measurement is in the ON state

---

**NOTE:** Only the Avg/Chan Power measurement is active on the CDMA CALL CONTROL screen.

#### Definition of Active Analog Measurement

An analog measurement is "active" if:

- the field used to display the measurement result is located on the screen which is currently displayed on the CRT of the Test Set

AND

- the measurement is in the ON state

## Measurement Triggering Process

**Triggering A Measurement Cycle**

The Test Set starts a measurement cycle when a valid trigger is received. The measurement cycle is the process used by the Test Set to obtain measurement results.

The measurement cycle is a firmware process which, for all active measurements, obtains raw data from the hardware and then processes/formats the raw data into a measurement result. The result is then displayed on the screen, and - if operating in remote mode - sent to the GPIB bus.

The measurement cycle completes when a valid measurement result is obtained for *all* active measurements.

**Trigger Modes**

The trigger mode used to start the measurement cycle can be selected by the user. The trigger mode is defined by two parameters: retriggering and settling.

**Retriggering**

Retriggering refers to what the measurement cycle does once it has completed (obtained a valid measurement result for all active measurements). There are two options:

1. **Single** retriggering causes the measurement cycle to stop once a valid measurement result has been obtained for all active measurements. A valid trigger must be received to start the measurement cycle again. When a measurement cycle is completed, the values for all active measurements are held until another trigger is received.
2. **Repetitive** retriggering causes the measurement cycle to automatically start over once a valid measurement result has been obtained for all active measurements. No trigger must be received to start the measurement cycle again. Repetitive retriggering will cause measurements that rely on external signals or hardware generated events (such as Traffic Rho) to be automatically re-armed upon completion of a measurement cycle.

---

**NOTE:** The **Cont** selection in the **Meas Cnt1** field is equal to repetitive retriggering.



## Measurement Triggering Process

### Settling

Settling refers to the amount of time delay introduced into the measurement cycle to allow signal transients to propagate through the analysis chain and settle out.

There are two options:

1. **Full** settling introduces the appropriate delay for all signal transients which might have occurred at the front panel coincident with the trigger command, to pass through the analysis chain and settle out. Delays are also inserted to allow for internal hardware transients to settle.
2. **Fast** settling introduces no delay for internal or external signal transients to settle.

There will still be delays introduced by the couplings between autotuning and autoranging. If the operator wishes to remove these delays as well, all autoranging and autotuning functions must be turned OFF and the operator must explicitly set the ranging amplifiers and the frequency tuning. Delays introduced by the measurement processes themselves cannot be eliminated.

---

**NOTE:**

CDMA measurements are not affected by the trigger mode settling parameter. CDMA measurements are made with a digital signal processor (DSP) which does not require the settling times associated with analog hardware circuitry.

---

### Rho Suite of Measurements

The following group of CDMA measurements is referred to as the "Rho Suite of Measurements" because a result for each of the following measurements is available each time the Rho Suite of measurements is triggered:

- Traffic Rho or TM Rho (only one can be selected)
- Frequency Error
- Amplitude Error
- Time Offset
- Phase Error
- Carrier Feedthrough

## Default Trigger Modes

### Default Trigger Mode for Remote Operation: CDMA and Analog Measurements

Upon powerup, or upon receiving a \*RST command, or upon pressing the front panel PRESET key, the Test Set's default trigger mode for remote operation of both CDMA and analog measurements is **Repetitive** retriggering with **Full** settling.

If a local-to-remote transition occurs, the trigger mode will be set to the last trigger mode command received while in remote mode. If no trigger mode command has been received since powerup, the default state is set.

### Default Trigger Mode for Local Operation: CDMA Measurements

Upon powerup, or upon receiving a \*RST command, or upon pressing the front panel PRESET key, the Test Set's default trigger mode for front panel operation of the FER and Rho Suite of Measurements is **Single** retriggering.

If a remote-to-local transition occurs, the trigger mode will be determined by:

- FER - the state of the **Meas Cnt1** field on the CDMA CELLULAR MOBILE RECEIVER TEST screen
- Rho Suite of Measurements - the state of the **Meas Cnt1** field on the CDMA CELLULAR MOBILE TRANSMITTER TEST screen

---

**NOTE:** Setting the **Meas Cnt1** field to **Cont** (Continuous) sets the trigger mode to repetitive retriggering.

---

Upon powerup, or upon receiving a \*RST command, or upon pressing the front panel PRESET key, or upon a remote-to-local transition the Test Set's default trigger mode for front panel operation of the Avg/Chan Power measurement is **Repetitive** retriggering.

### Default Trigger Mode for Local Operation: Analog Measurements

Upon powerup, or upon receiving a \*RST command, or upon pressing the front panel PRESET key, the Test Set's default trigger mode for front panel operation of analog measurements is **Repetitive** retriggering with **Full** settling.

---

## Triggering Analog Measurements In Local Mode (Front Panel Operation)

### 1. Select the desired trigger mode.

#### For Signaling Decoder

- **Continuous** - Once a measurement has completed, the Test Set is internally re-triggered and another measurement cycle begins.
- **Single** - Requires selection of the Arm Meas field to be begin a measurement cycle.

#### Manual Operation:

1. Position the cursor at the Single/Cont field.
2. Press the knob to underline the desired mode.

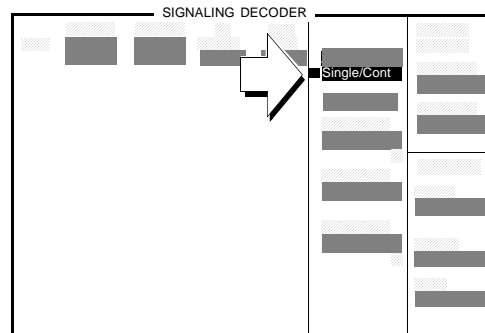

Triggering Analog Measurements In Local Mode (Front Panel Operation)

**For Analog Measurements (other than Signaling Decoder)**

- **Repetitive** retriggering is the only trigger mode available from the front panel for analog measurements (other than the Signaling Decoder). Single trigger mode can be simulated using the Test Set's measurement hold feature. Selecting the HOLD key causes *all* currently displayed measurement results to be held on the screen and stops the measurement cycle. To resume making measurements press the HOLD key again.

**Manual Operation:**

1. Press then release the SHIFT key, then press the MEAS RESET key to HOLD measurement results.
2. Select HOLD again to return to Repetitive mode.

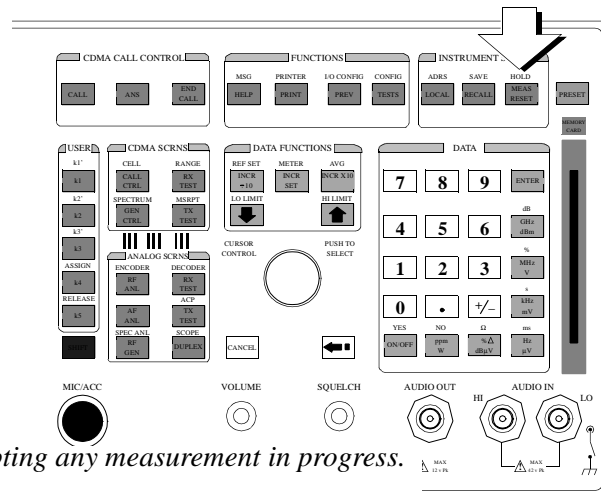

*Meas Reset begins a measurement cycle, interrupting any measurement in progress.*

## 2. Trigger the Signaling Decoder (applies if trigger mode is "Single")

### Manual Operation:

1. Position the cursor at the Arm Meas field.
2. Press the knob.

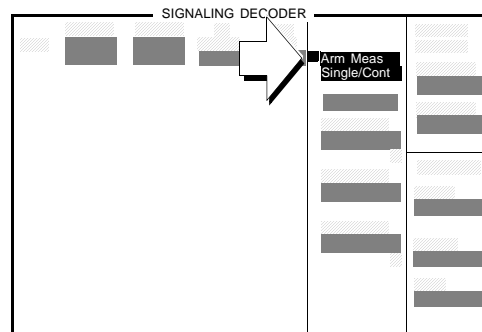

*Arming the Signaling Decoder as shown in this example will cause the measurement to be automatically triggered by an internal trigger command.*

*Selecting the Stop Meas field will stop the currently executing measurement cycle for the Signaling Decoder.*

## Triggering CDMA Measurements In Local Mode (Front Panel Operation)

## Triggering CDMA Measurements In Local Mode (Front Panel Operation)

### 1. Select the desired trigger mode.

#### For FER and Rho Suite of Measurements

- **Continuous** - Once a measurement has completed, the Test Set is internally re-triggered and another measurement cycle begins.
- **Single** - Requires selection of the Arm field to be begin a measurement cycle.

#### Manual Operation:

1. Position the cursor at the Single/Cont field.
2. Press the knob to underline the desired mode.

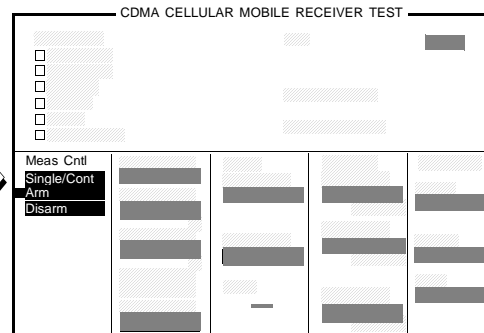

*When Single is selected, the Arm and Disarm fields are displayed. When Continuous is selected the Arm and Disarm fields will not appear.*

Triggering CDMA Measurements In Local Mode (Front Panel Operation)

**For Avg Power and Chan Power measurements**

- **Repetitive** retriggering is the only trigger mode available from the front panel for the Avg Power and Chan Power measurements. Single trigger mode can be simulated using the Test Set's measurement hold feature. Selecting the HOLD key causes *all* currently displayed measurement results to be held on the screen and stops the measurement cycle. To resume making measurements press the HOLD key again.

**Manual Operation:**

1. Press then release the SHIFT key, then press the MEAS RESET key to HOLD measurement results.
2. Select HOLD again to return to Repetitive mode.

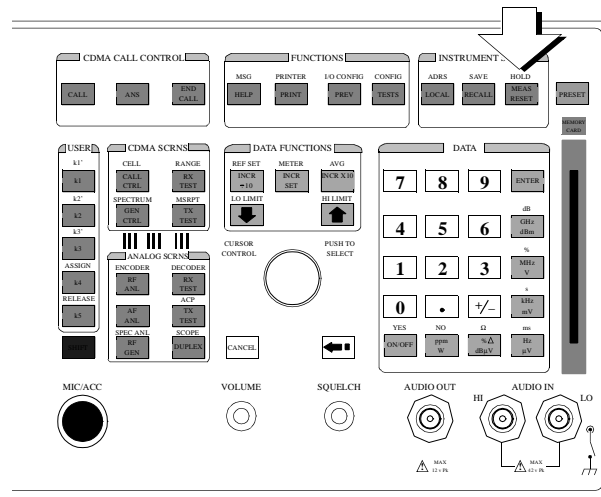

*Meas Reset begins a measurement cycle, interrupting any measurement in progress.*

## Triggering CDMA Measurements In Local Mode (Front Panel Operation)

**2. Trigger the FER and Rho Suite Measurements (applies if trigger mode is "Single")****Manual Operation:**

1. Position the cursor at the Arm field.
2. Press the knob.

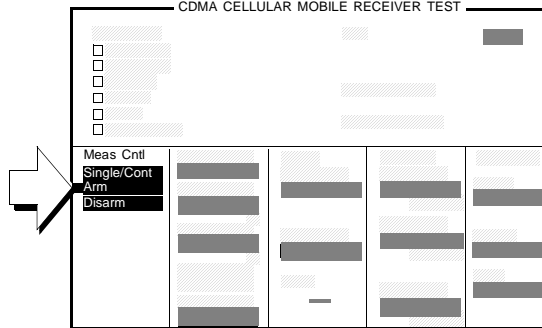

*Arming the FER measurement as shown in this example will cause the measurement to be triggered by an internal trigger event. The Rho suite of measurements operate similarly.*

*Selecting the Disarm field will stop the currently executing measurement cycle for the FER or Rho Suite of Measurements.*



---

## Triggering Analog Measurements In Remote Mode (GPIB Operation)

### 1. Select the desired trigger mode.

- **Retriggering**

- **Repetitive** - Once a measurement cycle has completed the Test Set is automatically re-triggered and another measurement cycle begins.

When the trigger mode is set to repetitive retriggering, consecutive queries of the same measurement return new measured values.

- **Single** - Once a measurement cycle has completed the Test Set requires an GPIB trigger command be received to begin a new measurement cycle.

When the trigger mode is set to single retriggering, consecutive queries of the same measurement (with no intervening trigger) will return the same value. Measurements that rely on external signals or hardware-generated events (such as Traffic Rho) must be re-armed with a new trigger before another measurement can be made.

- **Settling**

- **Full** - Appropriate time delays introduced into measurement cycle to allow internal or external signal transients to settle.
- **Fast** - No time delay introduced into measurement cycle to allow internal or external signal transients to settle.

The programmer must account for transient settling before issuing a trigger command.

There will still be delays introduced by the couplings between autotuning and autoranging. If the programmer wishes to remove these delays as well, all autoranging and autotuning functions must be turned OFF and the program must explicitly set the ranging amplifiers and the frequency tuning. Delays introduced by the measurement processes themselves cannot be eliminated.

#### **GPIB Syntax|**

```
"TRIG:MODE:RETR REP" !selects Repetitive retriggering mode.
```

```
"TRIG:MODE:RETR SING" !selects Single retriggering mode.
```

```
TRIG:MODE:SETT FULL" !selects Full settling mode.
```

```
"TRIG:MODE:SETT FAST" !selects Fast settling mode.
```

## Triggering Analog Measurements In Remote Mode (GPIB Operation)

**2. Trigger all active analog measurements (applies if trigger mode is "Single")****GPIB Syntax**

```
"TRIG" !triggers all active analog measurements.
```

**GPIB Example Program**

```
10 OUTPUT 714;"DISP RFAN"
20 OUTPUT 714;"TRIG:MODE:RETR SING;SETT FULL"
30 OUTPUT 714;"TRIG"
40 END
```

**GPIB Example Program Comments By Line**

```
10 !Selects RF Analyzer screen
20 !Sets the Test Set's remote trigger mode to Single retriggering and Full settling
30 !Triggers all active analog measurements
```

**Preventing GPIB Bus Lockup**

GPIB bus lockup is a condition where the GPIB bus and the Active Controller handshake are in a temporary holdoff state while the Active Controller waits to read the measurement result from the Test Set. If a measurement cycle does not successfully obtain a valid measurement result, it will continue to try until it does or until the measurement trigger is aborted. This is true for both retriggering modes. This has the consequence of putting the GPIB in the lockup state.

The control program should include measurement time-out routines that CLEAR the bus and ABORt the trigger if a measurement does not complete within a specified amount of time. This provides a method of preventing the bus from remaining in the temporary holdoff state indefinitely.

---

## Triggering CDMA Measurements In Remote Mode (GPIB Operation)

### 1. Select the desired trigger mode.

- **Retriggering**

- **Repetitive** - Once a measurement cycle has completed the Test Set is automatically re-triggered and another measurement cycle begins.

When the trigger mode is set to repetitive retriggering, consecutive queries of the same measurement return new measured values.

---

**NOTE:**

Since the default trigger mode for remote operation is Repetitive, as soon as the Test Set is put into remote mode (a local-to-remote transition) the Test Set will begin to make measurements whether a signal is present or not. If no signal is present, then signal processing error messages will be displayed on the CRT of the Test Set.

- **Single** - Once a measurement cycle has completed the Test Set requires an GPIB trigger command be received to begin a new measurement cycle.

When the trigger mode is set to single retriggering, consecutive queries of the same measurement (with no intervening trigger) will return the same value. Measurements that rely on external signals or hardware-generated events (such as Traffic Rho) must be re-armed with a new trigger before another measurement can be made.

---

**NOTE:**

CDMA measurements are not affected by the trigger mode settling parameter. CDMA measurements are made with a digital signal processor (DSP) which does not require the settling times associated with analog hardware circuitry.

### GPIB Syntax

```
"TRIG:MODE:RETR REP" !selects Repetitive retriggering mode.
```

```
"TRIG:MODE:RETR SING" !selects Single retriggering mode.
```

## Triggering CDMA Measurements In Remote Mode (GPIB Operation)

**2. Trigger all active CDMA measurements****GPIB Syntax**

```
"TRIG" !triggers all active CDMA measurements.
```

**GPIB Example Program**

```
10 OUTPUT 714;"DISP CRXT"
20 OUTPUT 714;"TRIG:MODE:RETR SING"
30 OUTPUT 714;"TRIG"
40 END
```

**GPIB Example Program Comments By Line**

```
10 !Selects CMDA CELLULAR MOBILE RECEIVER TEST screen
20 !Sets the Test Set's remote trigger mode to Single retriggering
30 !Triggers all active CDMA measurements
```

**Preventing GPIB Bus Lockup**

GPIB bus lockup is a condition where the GPIB bus and the Active Controller handshake are in a temporary holdoff state while the Active Controller waits to read the measurement result from the Test Set. If a measurement cycle does not successfully obtain a valid measurement result, it will continue to try until it does or until the measurement trigger is aborted. This is true for both retriggering modes. This has the consequence of putting the GPIB in the lockup state.

The control program should include measurement time-out routines that CLEAR the bus and ABORt the trigger if a measurement does not complete within a specified amount of time. This provides a method of preventing the bus from remaining in the temporary holdoff state indefinitely.

## Increasing Measurement Throughput

This section contains a number of techniques for increasing measurement throughput. These techniques include:

**"Performing Transmitter and Receiver testing concurrently" on page 86**

**"Minimizing bus configuration time" on page 90**

**"Reducing delays caused by screen changes" on page 93**

**"Reducing delays caused by unused measurements" on page 92**

**"Reducing measurement setup time" on page 93**

### Performing Transmitter and Receiver testing concurrently

During an FER test, the Test Set is capable of executing GPIB commands and returning measurement results from other measurement functions, such as Rho.

#### Programming Example

The following example assumes a Service Option 2 call is Connected. The program begins an FER measurement and allows an operator to query rho while the FER frame count continues.

## Increasing Measurement Throughput

```

10  ! re-save "i:\dept\cdma\ex_progs\simultan"
20  ! REV A.01.00
30  !
40  ! This program demonstrates simultaneous FER (receiver sensitivity)
50  ! and rho (transmitter modulation quality) testing. After an FER
60  ! test is started, a softkey interrupt branches program execution
70  ! to a subprogram that queries rho and prints a test result without
80  ! interrupting the FER test.
90  !
100 Loss=-3
110 CLEAR SCREEN
120 ! Set up a timeout to regain control of the bus in the event an error
130 ! such as "Query unterminated" occurs.
140 ON TIMEOUT 7,5 GOTO End_of_prog
150 Initialize_ts(Loss) !Preset the Test Set
160 Page_phone      !Attempt a call (the mobile must be registered)
170 ! Set triggering mode to continuous. THIS IS REQUIRED FOR
180 ! SIMULTANEOUS MEASUREMENTS.
190 OUTPUT 714;"TRIG:MODE:RETR REPETITIVE"
200 Start_fer      !Start an FER test
210 ! Set up a softkey to query rho measurement
220 USER 1 KEYS    !Selects User 1 softkey definitions on ITF keyboard, normal mode
230 ON KEY 1 LABEL "rho",15 CALL Measure_tx_qual
240 PRINT ""
250 PRINT "Press softkey F1 to make a rho measurement"
260 PRINT ""
270 LOOP
280   DISABLE !Disables interrupt while output/enter
290   OUTPUT 714;"meas:cdm:fer:fram?;err?"
300   ENTER 714;Frames_counted,Errors_counted
310   ENABLE !Enables keyboard interrupt allowing branch to rho meas
320   DISP "Frames Counted =";Frames_counted;"Errors Counted =";Errors_counted
330 END LOOP
340 OUTPUT 714;"CDMA:CALL:END"
350 OUTPUT 714;"TRIG:MODE:RETR SINGLE"
360 Clear_bus:     ! Clears the bus in case of query unterminated or query interrupted
370 CLEAR 714
380 ERROR RETURN

```

Increasing Measurement Throughput

```
390  DISP "PROGRAM DONE"
400  End_of_prog:  !Branch here if timeout occurs
410  END
420  !
430  Page_phone: SUB Page_phone
440      OUTPUT 714;"CDMA:CELL:ASEC:BWP -50 dBm;STAT ON"
450      OUTPUT 714;"CDMA:RFCH 384" !
460      PRINT "WHEN THE MOBILE FINDS SERVICE AND HAS REGISTERED, PRESS THE
CONTINUE SOFTKEY (F2)"
470      DISP "Waiting..."
480      PAUSE
490      OUTPUT 714;"CDMA:CALL:TRAF:DATA:MODE 'SVC OPT 2'"
530      OUTPUT 714;"CDMA:CALL:MAKE"
540      DISP "Mobile is being paged..."
550      ! The following loop will continue until the CDMA Event register
560      ! indicates that the phone has 'Connected'
590      REPEAT
600          WAIT .1 !100 mS wait to allow Test Set to handle other tasks
610          OUTPUT 714;"STAT:CDMA:EVENT?"
620          ENTER 714;Event_reg
690          UNTIL BIT(Event_reg,3)! Monitoring "Connected" annunciator bit
700          CLEAR SCREEN
710          PRINT "Page successful, mobile is connected"
720  SUBEND
73      0          Initialize_ts: SUB Initialize_ts(Loss)
740  CLEAR 714
750  CLEAR SCREEN
760  DISP "Initializing..."
770  OUTPUT 714;"*RST"! Reset
780  WAIT 5
790  OUTPUT 714;"CONF:OFL:MODE 'ON';RFIN ";Loss! External Path Loss
800  SUBEND
810  Measure_tx_qual: SUB Measure_tx_qual
820      ! This routine measures transmitter rho while FER is running
830      PRINT ""
840      PRINT "Measuring rho..."
850      OUTPUT 714;"MEAS:CDM:RHO?"
860      ENTER 714;Rho
```

## Increasing Measurement Throughput

```
870     PRINT "Rho is ";Rho
880     ! At this point, program execution will return to the loop
890     ! in the main program that displays FER results.
900     SUBEND-
910 Start_fer: SUB Start_fer ! Frame Error Rate Test
920     ! This sets up the parameters and arms the FER test.
950     OUTPUT 714;"DISP CRXTEST"
960     OUTPUT 714;"MEAS:CDM:FER:STAT ON"
980     OUTPUT 714;"DISPLAY:FER:INTERIM:RESULTS 'Yes'"
990     SUBEND
```



## Increasing Measurement Throughput

**Minimizing bus configuration time**

Every time a BASIC or IBASIC OUTPUT or ENTER statement is executed, the bus (GPIB) has to be configured for data transfer. Using compound GPIB statements minimizes bus configuration time by combining several operations into one GPIB OUTPUT or ENTER statement.

To combine multiple GPIB commands into one OUTPUT statement, use the ; (semicolon) separator and/or the ;; (semicolon colon) separator.

**NOTE:**

It may be helpful to add the common command \*OPC following a compound GPIB command. The \*OPC command is used to synchronize the control program with the Test Sets' operating state. For a description of the \*OPC command, refer to the GPIB Common Commands chapter of the *Agilent 8924C Condensed Programming Reference Guide*.

**"Using the semicolon in compound OUTPUT statements" on page 90**

**"Using the semicolon-colon in compound OUTPUT statements" on page 90**

**"Reading multiple values using one ENTER statement" on page 91**

**Using the semicolon in compound OUTPUT statements**

*The following example sets the Traffic Data Mode to Service Option 2 and the Data Rate to Full. The semicolon separator causes the GPIB command parser to back up one level in the command hierarchy.*

The following example...

- 10 OUTPUT 714;"CDMA:CALL:TRAFFIC:DATA:MODE 'Svc Opt 2'", and
- 20 OUTPUT 714;"CDMA:CALL:TRAFFIC:DATA:RATE 'Full' "

could be replaced with:

```
OUTPUT 714;"CDMA:CALL:TRAFFIC:DATA:MODE 'Svc Opt 2';RATE 'Full' "
```

**Using the semicolon-colon in compound OUTPUT statements**

*The following example sets the Sector A Power level to -70 dBm, then attempts to make a call. The semicolon-colon separator causes the GPIB command parser to back up to the top level in the command hierarchy.*

```
OUTPUT 714;"CDMA:CELL:ASECTOR:BWPOWER -70 DBM;;CDMA:CALL:MAKE "
```

## Increasing Measurement Throughput

The following example...

- 10 OUTPUT 714;"CDMA:CELL:ASECTOR:BWPOWER -70 DBM", and
- 20 OUTPUT 714;"CDMA:CALL:MAKE"

could be replaced with:

```
OUTPUT 714;"CDMA:CELL:ASECTOR:BWPOWER -70 DBM; :CDMA:CALL:MAKE"
```

#### Reading multiple values using one ENTER statement

*The following two lines of code query the Test Set for an Average Power measurement and the Average Power GPIB units, then read both of these values into the two variables Average\_power and Units\$.*

The following example...

- 10 OUTPUT 714;"MEAS:CDMANALYZER:AVGPOWER?",
- 20 ENTER 714;Average\_power
- 30 OUTPUT 714;"MEAS:CDMANALYZER:AVGPOWER:UNITS?",
- 40 ENTER 714;Units\$

could be replaced by:

```
10 OUTPUT 714;"MEAS:CDMANALYZER:AVGPOWER?;AVGPOWER:UNITS?"
20 ENTER 714;Average_power,Units$
```

### **Reducing delays caused by unused measurements**

When a measurement cycle is triggered, the Test Set will attempt to obtain a value for all active measurements. For instance, in CDMA mode (invoked when any CDMA screen is selected) the power measurement that is currently selected (Average Power or Channel Power) is active by default. However, let's assume you are currently measuring rho and do not need the power measurement. You can greatly speed up the rho measurement by turning off the power measurement.

#### **Turning off Average Power and Channel Power measurements**

The following example turns off both Average and Channel power using a compound GPIB statement:

```
OUTPUT 714:"MEAS:CDM:AVGP:STATE OFF;:MEAS:CDM:CHAN:STAT OFF"
```

Conversely, let's assume you are making a power measurement and do not need rho or any of the rho suite of measurements.

#### **Turning off the Rho suite of measurements**

The following example turns off all rho measurements:

```
OUTPUT 714:"MEAS:CDM:RHO:STATE OFF"
```

## Increasing Measurement Throughput

**Reducing delays caused by screen changes**

Each time the screen being displayed on the Test Set (active screen) is changed, it takes approximately 250 ms to access and draw the new screen. Additionally, each time a field on the active screen is changed it takes a finite amount of time to update the field. This update time depends on the length and type of field.

When the Test Set is operated remotely, it is possible to display a special “remote screen.” When the remote screen is displayed, the active screen is never changed.

When the remote screen is being displayed, the Test Set’s display is in the “locked” state. When the control program on the external controller unlocks the display, the screen is returned to the last remote screen requested. The \*RST Common Command will place the Test Set’s display screen in the “unlocked” state. Pressing the [LOCAL] key causes a locked Test Set display session to end and causes the Test Set’s display screen to return to the unlocked state.

**To Lock the Test Set’s Display Screen.**

Use the :SPECial:DISPlay 'LOCKED'|'UNLOCKED' commands to lock and unlock the Test Set’s display screen.

**Syntax**

```
:SPECial:DISPlay 'LOCKED'
:SPECial:DISPlay 'UNLOCKED'
```

**Example**

```
OUTPUT 714;"SPEC:DISP 'LOCKED' "
locks the Test Set’s display screen.
```

---

**NOTE:** SPECial:DISPlay 'LOCKED'|'UNLOCKED' must not be invoked from the Test Set’s built-in IBASIC Controller. Executing these commands from an IBASIC program can produce unexpected results and is not supported.

---

**Reducing measurement setup time**

Measurement setup time can be minimized by specifying an instrument operating state in the BASE register. This approach works in conjunction with SAVE/RECALL registers to minimize the number of instrument settings that have to change when recalling an instrument state. Refer to "**Specifying BASE Settings**" on page 64 for a description.

---

## Passing Instrument Control

Communications on the GPIB bus are accomplished according to a precisely defined set of rules (IEEE 488.1 and 488.2 Standards). Communication (data transfer) is accomplished by designating one device to be a talker (source of data or commands) and designating one or more devices to be listeners (receivers of data or commands). The device on the bus responsible for designating talkers and listeners is the Controller.

The structure of the GPIB bus allows for more than one Controller to be connected to the bus at the same time. As a means of ensuring that orderly communications can be established on power-up or when communications have failed, the rules state that only one Controller can unconditionally demand control of the bus (through the IFC line). This controller is referred to as the System Controller. There can be only one System Controller connected to the bus at any time.

As a means of ensuring orderly communications in environments where more than one controller is connected to the bus, the rules state that only one Controller can be actively addressing talkers and listeners at any given time. This device is referred to as the Active Controller. The System Controller is the default Active Controller on power-up or after a bus reset. Controllers which are not the Active Controller are referred to as Non-Active Controllers. The Active Controller can pass control of device addressing to one of the Non-Active Controllers. Additionally, Non-Active Controllers can request control from the Active Controller.

The process by which the Active Controller passes device addressing responsibility to a Non-Active Controller is referred to as Passing Control. The Active Controller must first address the prospective new Active Controller to Talk, after which it sends the Take Control Talker (TCT) message across the bus. If the other Controller accepts the message it assumes the role of Active Controller and the previous Active Controller becomes a Non-Active Controller.

## Passing Instrument Control

The Test Set has bus control capability (Active/Non-Active Controller). Additionally the Test Set can be also be configured as the System Controller. By definition then, the Test Set has the capability to demand control, pass control, accept control, and request control of the bus depending upon its configuration, its current operating mode, and the system configuration. Many possibilities for passing control among several controllers on the same bus exist. Attempting to identify all the possible techniques of passing control in such a system is beyond the scope of this document (refer to the IEEE 488.1 and 488.2 Standards for additional information).

### Configuring the Test Set as the System Controller

To configure the Test Set as a System Controller, select the I/O CONFIGURE screen, position the cursor to the **Mode** field using the Cursor Control knob, highlight the **Mode** field by pushing the Rotary Knob, select **Control** from the **Choices** menu. As a consequence of setting the Test Set to be the System Controller it will also become the Active Controller. The letter C appears in the upper-right corner of the display to indicate that the Test Set is now the Active Controller.

If the Test Set is the only controller on the bus it must be configured as the System Controller. If the Test Set is not the only controller on the bus, then whether or not it is configured as the System Controller would depend upon three issues:

1. whether or not other controllers have System Controller capability
2. which controller will be the Active Controller upon power-up
3. which Controller will be monitoring the bus to determine if communications have failed (only the System Controller can unconditionally demand control of the bus and reset it to a known state using the IFC line)

Ensure that only one Controller connected to the bus is configured as the System Controller or bus conflicts will occur.

### **When Active Controller Capability is Required**

The Test Set must be the Active Controller on the bus under the following conditions:

1. whenever the Test Set needs to control any device connected to the GPIB bus, such as an external disk drive, an external printer, or an external instrument
2. whenever a screen image is printed to an external GPIB printer
3. whenever an instrument configuration is saved or recalled from an external GPIB disk drive
4. whenever running any Agilent 11807 Radio Test Software package which uses an external GPIB device such as a disk drive, a printer, or an instrument
5. whenever running any IBASIC program which uses an external GPIB device such as a disk drive, a printer, or an instrument

### **Passing Control Back to Another Controller**

The Test Set has two methods of passing control back to another controller: 1) automatically and 2) using the IBASIC PASS CONTROL command from an IBASIC program. The two methods are described in the following sections.

#### **Passing Control Back Automatically**

The Test Set will automatically pass control back to the controller whose address was specified in the \*PCB Common Command or to a default address of 0 (decimal) if no \*PCB command was received. Control will automatically be passed under the following conditions:

##### **Test Set is the Active Controller and an IBASIC Program is Running**

- The IBASIC program running in the Test Set is PAUSED.
- The IBASIC program running in the Test Set finishes executing.
- An IBASIC RESET occurs while the IBASIC program is running.
- Control is passed back immediately if the System Controller executes a bus reset (IFC).

## Passing Instrument Control

### **Test Set is the Active Controller and no IBASIC Program is Running**

- Control will be passed back within 10 seconds of receiving bus control if no controller commands are executed (such as printing a screen image to an GPIB printer or saving/recalling an instrument configuration from an GPIB disk drive).
- Control is passed back immediately if the System Controller executes a bus reset (IFC).
- Control is passed back at the completion of a controller command (such as printing a screen image to an GPIB printer or saving/recalling an instrument configuration from an GPIB disk drive).

### **Passing Control Back Using IBASIC PASS CONTROL Command**

The Test Set will pass control back to another Controller when the IBASIC PASS CONTROL command is issued while an IBASIC program is running on the built-in IBASIC Controller. Refer to the *HP Instrument BASIC User's Handbook* for a complete description of the IBASIC PASS CONTROL command.

## **Passing Control to the Test Set**

Control is passed to the Test Set when it is addressed to TALK and then receives the Take Control Talker (TCT) command. The programming or controller command which implements the pass control protocol as outlined in the IEEE 488.1 and 488.2 Standards is language/controller specific. Refer to the appropriate language/controller documentation for specific implementations.

Before passing control to the Test Set the Active Controller should send the Test Set the address to use when passing control back. This is accomplished using the \*PCB Common Command. The \*PCB command tells the Test Set which address should be used when passing control back to another bus controller. Before passing bus control to the Test Set, the currently active controller can use the \*PCB command to tell the Test Set where to send the Take Control (TCT) command when the Test Set is ready to give up active control of the bus. The command is followed by a number which contains the bus address of the device that should become the next active controller. The number must round to an integer in the range 0 to 30 decimal. The command may be followed by two numbers. The first will be used as the primary address, the second as the secondary address of the next active controller.



### **Requesting Control using IBASIC**

The Test Set has the capability to request control of the bus from the Active Controller from a running IBASIC program using the IBASIC command EXECUTE ("REQUEST\_CONTROL"). When the EXECUTE ("REQUEST\_CONTROL") command is executed from a running IBASIC program, the Request Control bit, bit 1, of the Test Set's Standard Event Status Register is set to the TRUE, logic 1, condition. The Active Controller detects the request in the Test Set's Standard Event Status Register either as a result of an SRQ indication by the Test Set or by some polling routine which periodically checks bit 1 of the Standard Event Status Register of all potential controllers on the bus. The Active Controller would then send the Test Set the address to which the Test Set is to later pass control using the \*PCB Common Command. The Active Controller would then pass control to the Test Set.

## Pass Control Examples

The following examples illustrate how pass control could be implemented in two of the common Test Set operating configurations:

1. Test Set controlled by an external controller, and
2. Test Set running an IBASIC program with an external Controller connected to GPIB bus.

### Passing Control While the Test Set is Controlled by an External Controller

This example illustrates passing control between the Test Set and an external controller while the Test Set is being controlled by the external controller. In this mode the Test Set is NOT configured as the System Controller. Generally speaking, in this mode of operation the Test Set is considered just another device on the GPIB bus and its Controller capabilities are not used. However, it may be desirable, under certain conditions, to print a Test Set screen to the GPIB printer for documentation or program debugging purposes. With manual intervention it is possible to have the Active Controller pass control to the Test Set, have the operator select and print the desired screen, and then pass control back to the formerly Active Controller. The following steps outline a procedure for accomplishing this task.

This example is based upon having an HP 9000 Series 300 Workstation as the external controller connected to the Test Set through the GPIB bus. Further, it assumes that the GPIB interface in the HP 9000 Controller is set to the default select code of 7 and address of 21.

1. If a program is running on the HP 9000 Workstation, PAUSE the program.
2. Put the Test Set in local mode (press the LOCAL key on the front panel).
3. Configure the Test Set to print to the GPIB printer using the PRINT CONFIGURE screen.
4. Configure the Test Set to display the screen to be printed.
5. From the keyboard of the HP 9000 Workstation type in and execute the following command:

```
OUTPUT 714: "*PCB 21"
```

This command tells the Test Set the address of the Controller to pass control back to.

6. From the keyboard of the HP 9000 Workstation type in and execute the following command:

```
PASS CONTROL 714
```

This command passes control to the Test Set.

7. Put the Test Set in local mode (press the LOCAL key on the front panel).
8. Press SHIFT, then TESTS on the front panel of the Test Set to print the screen.
9. After the Test Set finishes printing the screen it will automatically pass control back to the HP 9000 Workstation.

Passing Instrument Control

**Passing Control Between an External Controller and the Test Set with an IBASIC Program Running**

The following example program illustrates the passing of control between an external Controller and the Test Set while an IBASIC program is running in the Test Set. The example is based upon having an HP 9000 Series 300 Workstation as the external controller connected to the Test Set through the GPIB bus. Further, it is based on the assumption that the GPIB interface in the HP 9000 Controller is set to the default select code of 7 and address of 21. In this example, the Test Set is NOT configured as the System Controller. This example illustrates the situation where the External Controller would perform the functions listed below.

1. Sends commands to the Test Set to cause a program to be loaded off of a Memory Card which is in the Test Set's front panel Memory Card slot.
2. Sends commands to the Test Set to run the program just loaded.
3. Passes control to the Test Set and then does other work while the Test Set is making measurements.

When the Test Set is finished making measurements and has data available for the External Controller, it passes control back to the External Controller.

4. The External Controller then requests the data from the Test Set.

## Passing Instrument Control

The following program would run in the External Controller:

```

10   COM /gpib_names/  INTEGER Internal_gpib,Inst_address,Cntrl_state
20   COM /Cntrl_names/ Ext_cntrl_addrs,Int_cntrl_addrs
30   COM /Io_names/    INTEGER Printer_addrs,Pwr_suply_addrs
40   COM /Io_values/   REAL Meas_power,Prog_state${80},Prog_name${50}
50   COM /Reg_vals/    INTEGER Status_byte,Stdevnt_reg_val
60   !
70   Internal_GPib=7
80   Ext_cntrl_addrs=14
90   Int_cntrl_addrs=21
100  Printer_addrs=1
110  Pwr_suply_addrs=26
120  Inst_address=(Internal_gpib*100)+Ext_cntrl_addrs
130  Prog_name$="PASCSTLEX:INTERNAL,4"
140  !
150  PRINTER IS CRT
160  !
170  ! Set the Controller up to respond to an SRQ from Test Set
180  ! The interrupt is generated by the Request Control bit in the Test Set
190  ON INTR Internal_GPib CALL Pass_control
200  ENABLE INTR Internal_gpib;2
210  !
220  ! Bring Test Set to known state.
230  OUTPUT Inst_address;"*RST"
240  !
250  ! Set the Test Set to cause SRQ interrupt on Request Control
260  OUTPUT Inst_address;"*CLS"
270  OUTPUT Inst_address;"*ESE 2"
280  OUTPUT Inst_address;"*SRE 32"
290  !
300  ! Load the desired program into the Test Set from Memory Card
305  OUTPUT Inst_address;"DISP TIB" ! Display the IBASIC screen
310  OUTPUT Inst_address;"PROG:EXEC 'DISP "" ""&"Loading program."&""""'"
320  OUTPUT Inst_address;"PROG:EXEC 'GET "" ""&Prog_name$&""""'"
330  OUTPUT Inst_address;"PROG:EXEC 'DISP "" ""&""&""""'"
340  !
350  ! Run the program in the Test Set
360  OUTPUT Inst_address;"PROG:EXEC 'RUN'"
370  !
380  REPEAT
390     STATUS Internal_gpib,3;Cntrl_state
400     DISP "WAITING TO PASS CONTROL TO THE Test Set."
410  UNTIL NOT BIT(Cntrl_state,6)
420  !
430  REPEAT
440     STATUS Internal_gpib,3;Cntrl_state
450     DISP "WAITING FOR CONTROL BACK FROM THE Test Set"
460  UNTIL BIT(Cntrl_state,6)
470  !
480  ! Data is ready in the Test Set
490  OUTPUT Inst_address;"PROG:NUMB? Meas_power"
500  ENTER Inst_address;Meas_power
510  PRINT "Measured power = ";Meas_power
520  !
530  DISP "Program finished."
540  END
550  !
560  SUB Pass_control
570  !
580  COM /Gpib_names/  INTEGER Internal_gpib,Inst_address,Cntrl_state
590  COM /Cntrl_names/ Ext_cntrl_addrs,Int_cntrl_addrs
600  COM /Io_names/    INTEGER Printer_addrs,Pwr_suply_addrs

```

Passing Instrument Control

```
610     COM /Io_values/ REAL Meas_power,Prog_state$[80],Prog_name$[50]
620     COM /Reg_vals/ INTEGER Status_byte,Stdevnt_reg_val
630     !
640     OFF INTR Internal_gpib
650     Status_byte=SPOLL(Inst_address)
660     IF NOT BIT(Status_byte,5) THEN
670         PRINT "SRQ for unknown reason. Status Byte = ";Status_byte
680         STOP
690     END IF
700     !
710     ! Tell Test Set where to pass control back to
720     OUTPUT Inst_address;"*PCB";Int_cntrl_addr
730     !
740     ! Put Test Set in LOCAL mode so front panel keys function
750     LOCAL Inst_address
760     !
770     PASS CONTROL Inst_address
780     !
790     ENABLE INTR Internal_gpib;2
800     !
810     SUBEND
```

## Passing Instrument Control

The following IBASIC program would be loaded off the Memory Card and run in the Test Set:

```

10     COM /Gpib_names/ INTEGER Internal_gpib,External_gpib
20     COM /Cntrl_names/ Ext_cntrl_addrs,Int_cntrl_addrs
30     COM /Io_names/ INTEGER Printer_addrs,Pwr_suply_addrs
40     COM /Io_values/ REAL Meas_power
50     !
60     Internal_gpib=800
70     External_gpib=700
80     Ext_cntrl_addrs=21
90     Int_cntrl_addrs=14
100    Printer_addrs=1
110    Pwr_suply_addrs=26
120    !
130    OUTPUT Internal_gpib;"*RST"
140    CLEAR SCREEN
150    PRINTER IS CRT
160    !
170    EXECUTE ("REQUEST_CONTROL")
180    !
190    Try_again:    !
200    ON ERROR GOTO Not_active_cntrl
210    DISP "WAITING TO GET CONTROL"
220    OUTPUT External_gpib;" " !If OUTPUT successful then Active Controller
230    !If OUTPUT not successful then not Active Controller
240    DISP "TEST SET NOW ACTIVE CONTROLLER."
250    CALL Start_program
260    !
270    Pass_back:    !
280    DISP "PASSING CONTROL BACK"
290    !Control is passed back automatically when the program stops
300    !Control is passed back to address specified by *PCB command
310    DISP "PROGRAM FINISHED"
320    STOP
330    !
340    Not_active_cntrl:    !
350    OFF ERROR
360    DISP "CHECKING FOR ERROR"
370    IF ERRN=173 THEN
380        GOTO Try_again
390    ELSE
400        PRINT "ERROR =" ;ERRN
410        STOP
420    END IF
430    !
440    END
450    !
460    SUB Start_program
470    !
480    COM /gpib_names/ INTEGER Internal_gpib,External_gpib
490    COM /Cntrl_names/ Ext_cntrl_addrs,Int_cntrl_addrs
500    COM /Io_names/ INTEGER Printer_addrs,Pwr_suply_addrs
510    COM /Io_values/ REAL Meas_power
520    !
530    PRINT "SETTING POWER SUPPLY"
540    OUTPUT External_gpib+Pwr_suply_addrs;"IMAX 8;ISET 5"
550    OUTPUT External_gpib+Pwr_suply_addrs;"VMAX 15;VSET 13.2"
560    !
570    PRINT "SETTING UP INTERNAL INSTRUMENTS"
580    OUTPUT Internal_gpib;"RFG:FREQ 850.030 MHZ;AMPL -40 dBm"
590    OUTPUT Internal_gpib;"AFG1:FREQ 3 KHZ;DEST 'FM';FM 3 KHZ"
600    OUTPUT Internal_gpib;"DISP TX;MEAS:RFR:POW?"
610    ENTER Internal_gpib;Meas_power

```

Passing Instrument Control

```
620  !
630  OUTPUT External_gpib+Printer_addr; "Measured power = "; Meas_power
640  !
650  OUTPUT External_gpib+Pwr_suply_addr; "VSET 0"
660  !
670  SUBEND
```

---

## **4 Status Reporting**

This chapter provides an overview of the status reporting structure used in the Test Set. Methods for using status register bits and bit definitions are also found here.



## Status Reporting

This section describes the status reporting structure used in the Test Set. The structure is based on the IEEE 488.1-1987 and 488.2-1987 Standards and the Standard Commands for Programmable Instruments (SCPI) Version 1994.0.

For a full listing of command mnemonics, refer to the “Status” syntax, in GPIB Command Syntax chapter of the *Agilent 8924C Condensed Programming Reference Guide*.

### Status Register Structure Overview

The structure of the register groups used in the Test Set is based upon the status data structures outlined in the IEEE 488 and SCPI 1994.0 Standards. There are two types of status data structures used in the Test Set: status registers and status queues. The general models, components, and operation of each type of status data structure are explained in the following sections.

### Status Register Model

This section explains how the status registers are structured in the Test Set. The generalized status register group model shown on the previous page consists of a Condition Register, Transition Filters, an Event Register, an Enable Register, and a Summary Message Bit.

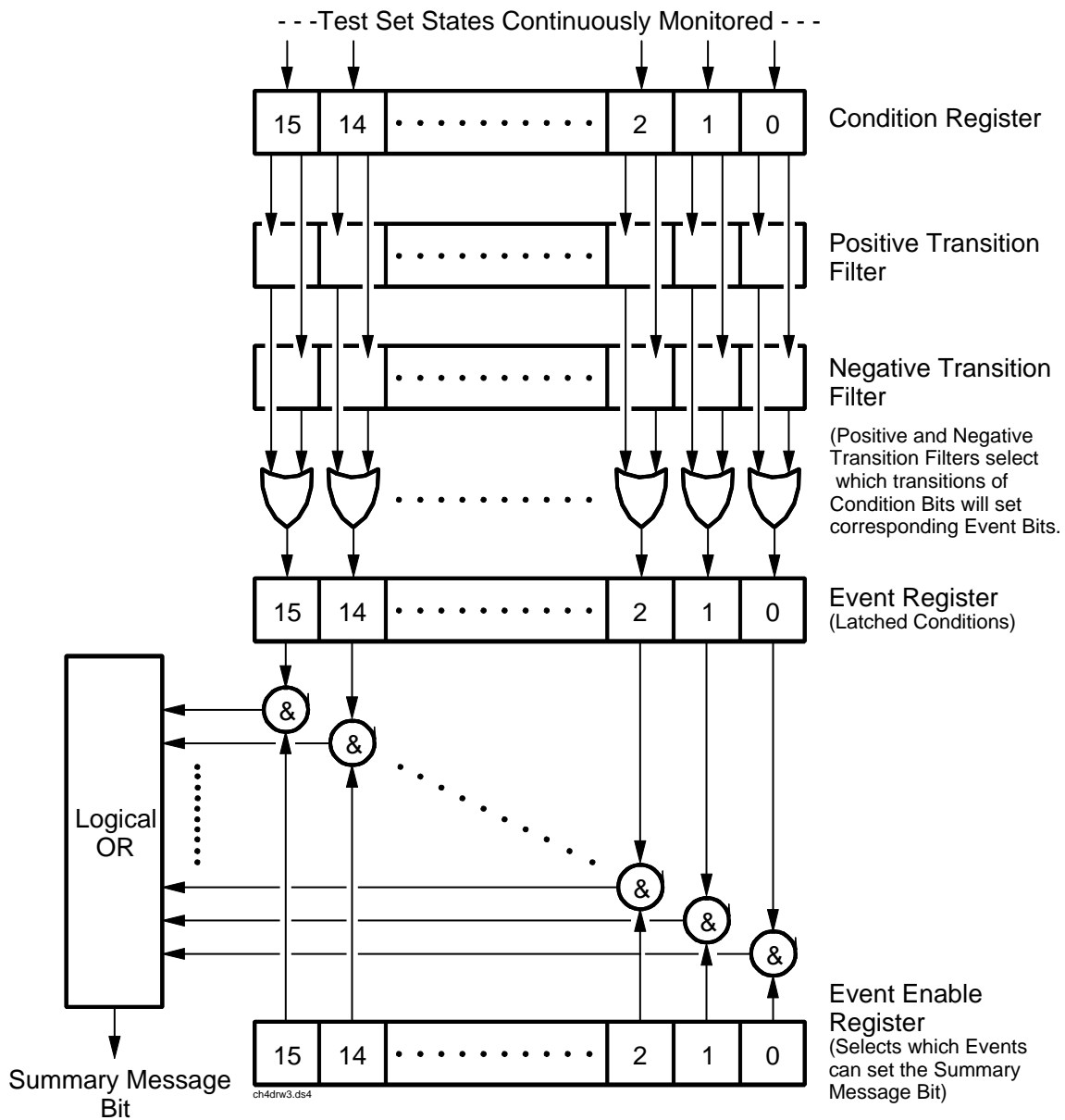

Figure 8 Status Data Structure - Register Group Model

## Status Reporting

### Condition Register /Transition Filters

A condition is a Test Set state that is either true or false.

Monitored Test Set states that are capable of remaining in each state for a time period long enough to provide a realistic chance of being queried are assigned one of the bits in the appropriate condition register. An example of this type of bit would be FER Test Running, located in the Measuring status register group. When an FER (Frame Error Rate) test is not running, this condition bit is false. When an FER test is running, this bit will transition to a true state and remain there for the duration of the FER test, which at a minimum will take several seconds. During this time an external controller may periodically query the Measuring status register and find that the bit is still true, indicating the test is still running.

Monitored Test Set states that are transient, such as FER Test Passed in the CDMA status register group, do not have a condition register bit assigned to them. The reason for this is evident in the following description of the FER Test Passed states. When an FER test passes, the condition bit toggles from false to true, then is returned false so that it is in a state to signal the next occurrence of this condition. The chances are very slight that an GPIB query of the FER Test Passed condition bit would ever return a true state indication.

In the following pages, each status register group description includes a table of bit definitions. As part of each bit definition there is a column entitled "Is Condition Register Implemented", with a YES or NO identifier.

There is no latching or buffering of any bits in a Condition Register; it is updated in real time. Condition Registers are read-only. Condition Registers in the Test Set are 16 bits long and may contain unused bits. All unused bits return a zero value when read.

For each bit that has a condition register implemented, the Transition Filters determine which of two bit-state transitions will set the corresponding bit in the Event Register. See "**Event Register**" on page 109. Transition Filters may be set to pass positive transitions (PTR), negative transitions (NTR) or either (PTR or NTR). A positive transition means a condition bit changed from 0 to 1. A negative transition means a condition bit changed from 1 to 0.

In the Test Set, the Transition Filters are implemented as two registers: a 16-bit positive transition (PTR) register and a 16-bit negative transition (NTR) register. A positive transition of a bit in the Condition register will be latched in the Event Register if the corresponding bit in the positive transition filter is set to 1. A positive transition of a bit in the Condition register will *not* be latched in the Event Register if the corresponding bit in the positive transition filter is set to 0. A negative transition of a bit in the Condition register will be latched in the Event Register if the corresponding bit in the negative transition filter is set to 1. A negative transition of a bit in the Condition register will *not* be latched in the Event Register if the corresponding bit in the negative transition filter is set to 0. Either transition (PTR or NTR) of a bit in the Condition Register will be latched in the Event Register if the corresponding bit in both transition filters is set to 1. No transitions (PTR or NTR) of a bit in the Condition Register will be latched in the Event Register if the corresponding bit in both transition filters is set to 0.

Transition Filters are read-write. Transition Filters are unaffected by a \*CLS (clear status) command or queries. The Transitions Filters are set to pass positive transitions (PTR) at power on and after receiving the \*RST (reset) command (all 16 bits of the PTR register set to 1 and all 16 bits of the NTR register set to 0).

### **Event Register**

The Event Register captures bit-state transitions in the Condition Register as defined by the Transition Filters. Each bit in the Event Register corresponds to a bit in the Condition Register, or if there is no Condition Register/Transition Filter combination, each bit corresponds to a specific condition in the Test Set. Bits in the Event Register are latched, and, once set, they remain set until cleared by a query of the Event Register or a \*CLS (clear status) command. This guarantees that the application can't miss a bit-state transition in the Condition Register. There is no buffering; so while an event bit is set, subsequent transitions in the Condition Register corresponding to that bit are ignored. Event Registers are read-only. Event Registers in the Test Set are either 8 or 16 bits long and may contain unused bits. All unused bits return a zero value when read.

## Status Reporting

### **Event Enable Register**

The Event Enable Register defines which bits in the Event Register will be used to generate the Summary Message. Each bit in the Enable Register has a corresponding bit in the Event Register. The Test Set logically ANDs corresponding bits in the Event and Enable registers and then performs an inclusive OR on all the resulting bits to generate the Summary Message. By using the enable bits the application program can direct the Test Set to set the Summary Message to the 1 or TRUE state for a single event or an inclusive OR of any group of events. Enable Registers are read-write. Enable Registers in the Test Set are either 8 or 16 bits long and may contain unused bits which correspond to unused bits in the associated Event Register. All unused bits return a zero value when read and are ignored when written to. Enable Registers are unaffected by a \*CLS (clear status) command or queries.

### **Summary Message Bit**

The Summary Message is a single-bit message which indicates whether or not one or more of the enabled events have occurred since the last reading or clearing of the Event Register. The Test Set logically ANDs corresponding bits in the Event and Enable registers and then performs an inclusive OR on all the resulting bits to generate the Summary Message. By use of the enable bits, the application program can direct the Test Set to set the Summary Message to the 1, or TRUE, state for a single event or an inclusive OR of any group of events. The Summary Message is TRUE when an enabled event in the Event Register is set TRUE. Conversely, the Summary Message is FALSE when no enabled events are TRUE. Summary Messages are always seen as bits in another register.

## Status Queue Model

This section explains how status queues are structured in the Test Set. The generalized status queue model shown in **figure 9** is the basis upon which all the status queues in the Test Set are built. A queue is a data structure containing a sequential list of information. The queue is empty when all information has been read from the list. The associated Summary Message is TRUE, logic 1, if the queue contains some information and FALSE, logic 0, if the queue is empty. Queues can be cleared by reading all the information from the queue. Queues, except the Output Queue, can also be cleared using the \*CLS (clear status) command. A status queue can also be referred to as a Status Register Group.

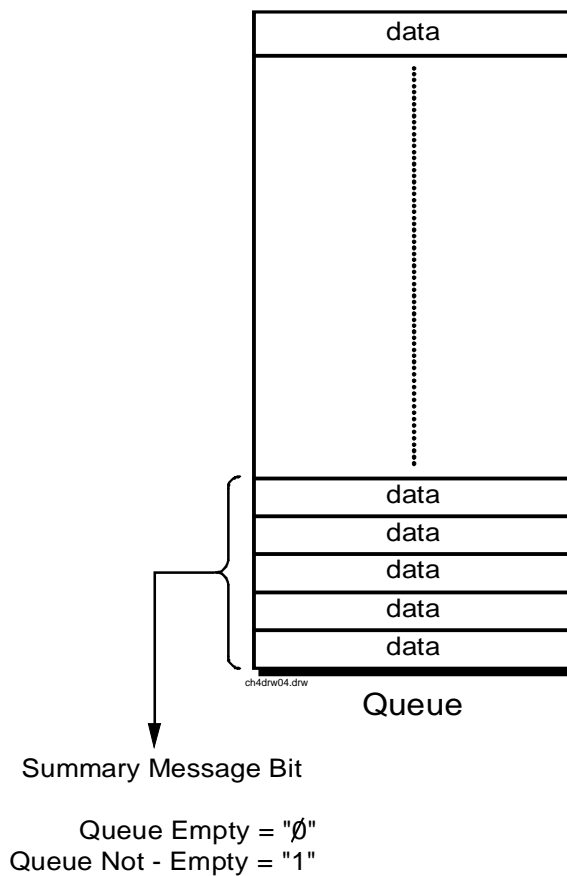

**Figure 9** Status Data Structure - Queue Mode

## Status Register Programming Considerations

When performing certain tasks, such as making a call, program flow can be controlled by the status register group bits. Generally, there are two approaches to using status register group bits, Polling, and Service Requests. The choice of which technique to use, polling or service request, will depend upon the needs of the particular application.

### Advantages/Disadvantages of Polling

Polling has the advantage that the control program can react quicker to the change in state since it (the control program) does not have to execute the code necessary to determine what condition caused the service request line to be asserted.

Polling has the disadvantage that, if improperly implemented, it can prevent the Call Processing Subsystem from properly interfacing with the mobile station.

The Test Set has a multi-tasking architecture wherein multiple processes execute on a priority driven and an event driven basis. One of the highest priority processes is the process that services the GPIB.

If a control program constantly polls the status registers to determine when a particular state is true, that state may never go to the true state because the Test Set is constantly being interrupted by the GPIB service process.

Therefore, care must be exercised when using the polling technique to allow enough time between polls for processes to execute within the Test Set.

Some computer systems and/or programming languages may not support the service request feature of the GPIB and consequently polling would be the only technique available to the programmer. When using a polling technique be sure to include a delay in the polling loop. Refer to line 60 in the example below.

## Status Reporting

**GP BASIC Example of Polling**

```

10 PRINT "PRESS CONTINUE WHEN THE MOBILE STATION IS IN IDLE STATE"
15 OUTPUT 714;"*CLS" !Clears contents of event registers
20 PAUSE
30 OUTPUT 714;"CDMA:MOB:REG" !Attempts to register mobile station
40 DISP "Registering mobile station"
50 REPEAT
60 WAIT .1 !Allows the Test Set to perform processes other than processing
    ! GPIB commands
70 OUTPUT 714;"STAT:CDMA:EVEN?" !Queries the CDMA Event register
80 ENTER 714;Cdma_event_reg
90 UNTIL BIT(Cdma_event_reg,11) !Exits loop when Mobile Station Registered
    !bit goes true
100 PRINT "MOBILE STATION HAS REGISTERED"
110 END

```

**Advantages/Disadvantages of Using Service Request**

The service request feature of the GPIB has the advantage that it allows the Call Processing Subsystem to execute at its maximum speed since processes within the subsystem are not being constantly interrupted by the need to service the GPIB.

The service request feature of the GPIB has the disadvantage that it takes more code to implement within the control program. The consequence of which is a slight reduction in the overall throughput of the control program since more code must be executed to accomplish the same task. For an example of using the service request feature, refer to “Controlling Program Flow” chapter in the *Agilent 8924C Application Guide*.



Status Reporting

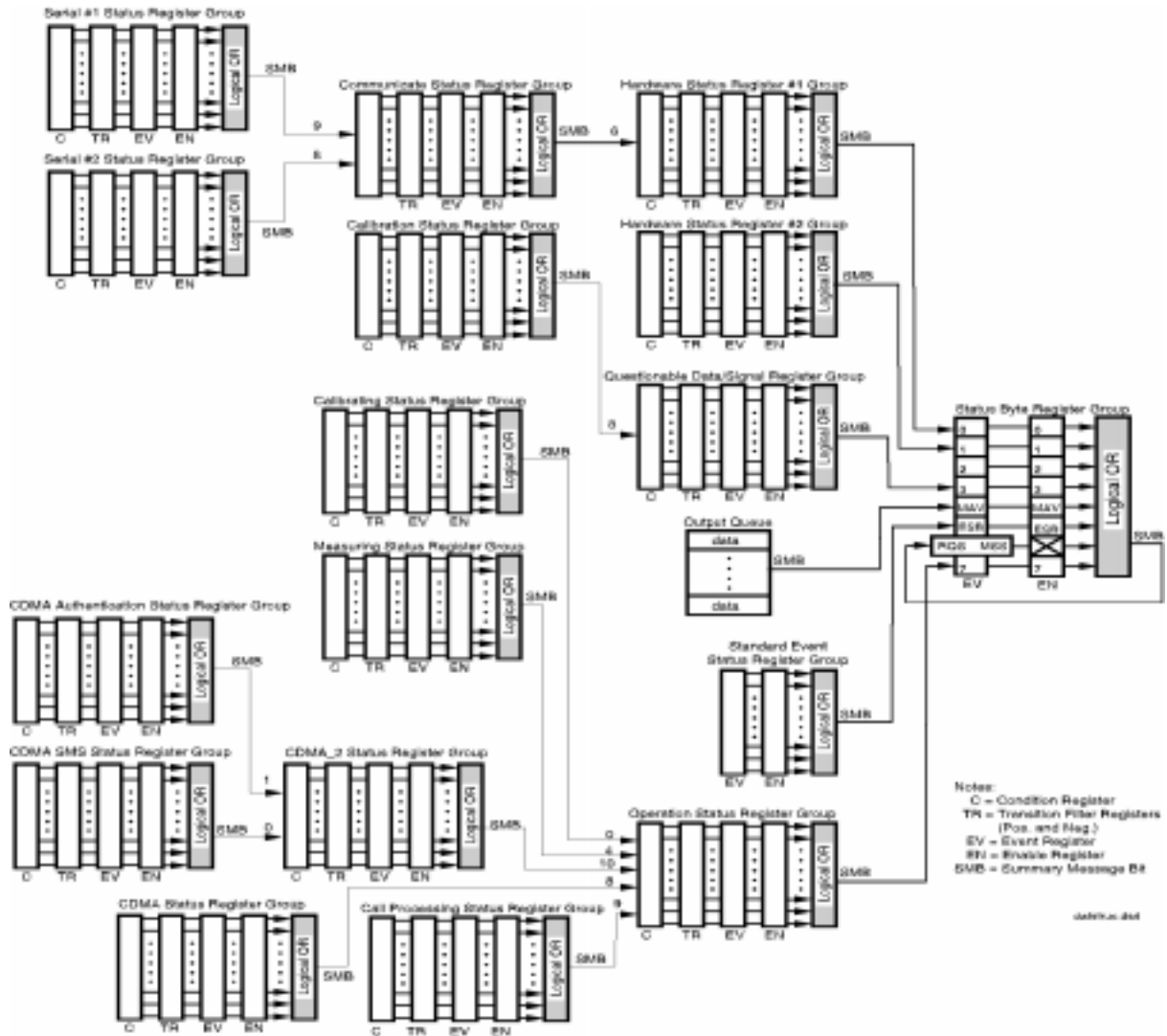

Figure 10 Test Set Data Structure Block Diagram

## Calibrating Status Register Group

The Calibrating Status Register Group contains information about events associated with calibrating CDMA measurements. This register group uses 16-bit registers and includes a Condition Register, Transition Filters, an Event Register, an Enable Register, and a Summary Message. p.

The Calibrating Register Group SMB must be enabled in the Operation Status Register Group before any of the following events or conditions can be reported through the Status Byte Register.

**Figure 11 on page 116** shows the structure and STATus commands for the Calibrating Status Register Group.

**Table 5 on page 122** details the Calibrating Status Register Group Condition Register bit assignments.

Status Reporting

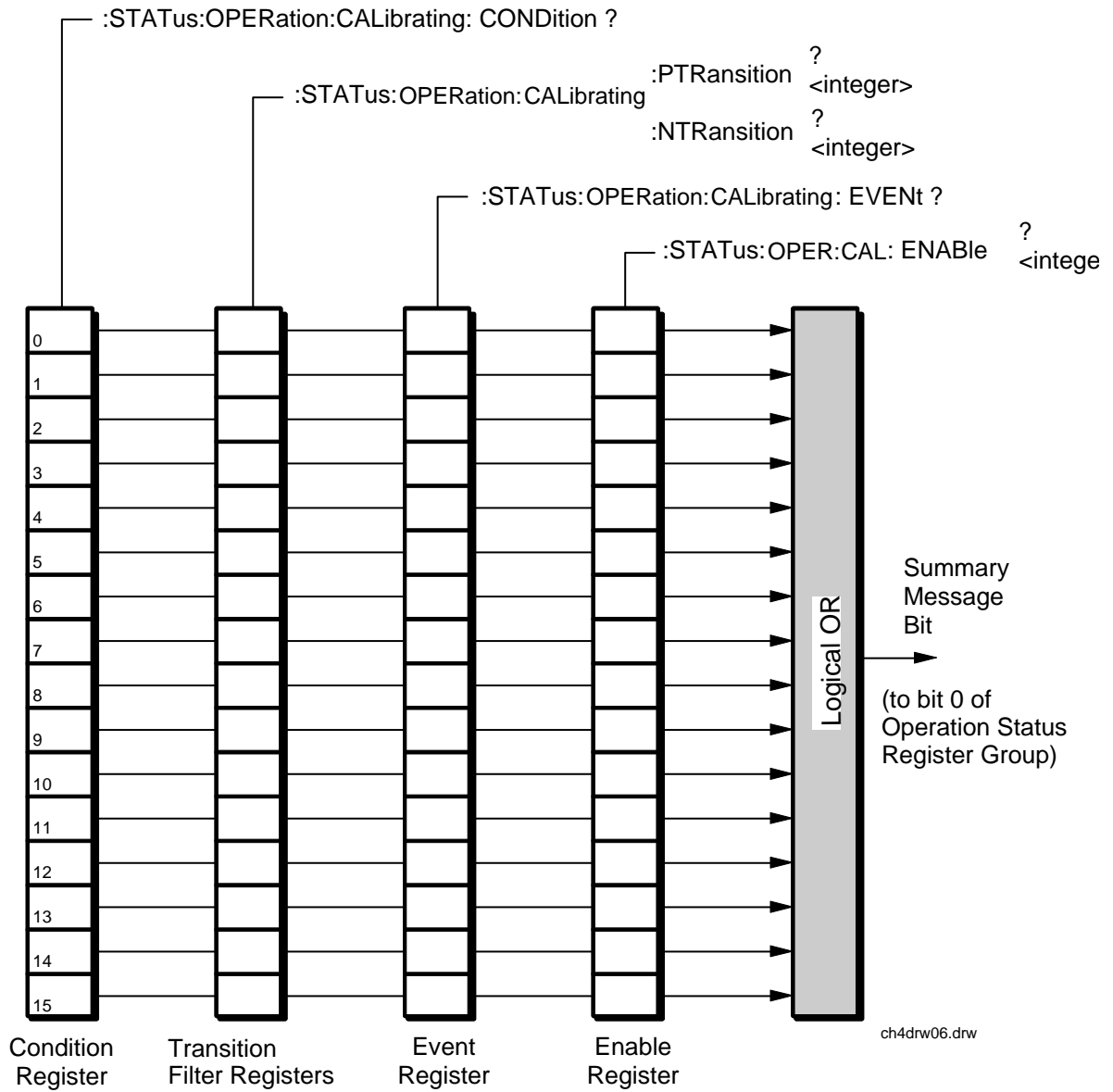

**Figure 11** Calibrating Status Register Group

**Table 4**                    **Calibrating Status Register Group Condition Register Bit Assignments**

| <b>Bit Number</b> | <b>Is Condition Register Implemented?</b> | <b>Condition</b>          | <b>Comment</b>                                       |
|-------------------|---|---------------------------|--|
| 15                |   | Unused in the Test Set    |  |
| 14                |   | Unused in the Test Set    |  |
| 13                |   | Unused in the Test Set    |  |
| 12                |   | Unused in the Test Set    |  |
| 11                |   | Unused in the Test Set    |  |
| 10                |   | Unused in the Test Set    |  |
| 9                 |   | Unused in the Test Set    |  |
| 8                 |   | Unused in the Test Set    |  |
| 7                 |   | Unused in the Test Set    |  |
| 6                 |   | Unused in the Test Set    |  |
| 5                 |   | Unused in the Test Set    |  |
| 4                 |   | Unused in the Test Set    |  |
| 3                 | YES <sup>a</sup>                          | RF Gen Level calibration  | Calibrating the PCS Interface generator power levels |
| 2                 | YES <sup>a</sup>                          | CDMA Baseband calibration | Calibrating CDMA Baseband Physical Channels          |
| 1                 | YES <sup>a</sup>                          | Channel power calibration | Calibrating Channel Power measurement.               |
| 0                 | YES <sup>a</sup>                          | Digital power zeroing     | Average power measurements zeroed                    |

- a. Although a Condition register is implemented, the Test Set will not parse out or execute GPIB commands while this operation is taking place. Consequently, a query of the Condition register will not be executed until after the calibration attempt has completed, and will never indicate a “true” condition. Always query the Event register, and when the calibration attempt has completed an Event register query result will be returned and will show which bit was latched by the initiation of a calibration attempt.

## Status Reporting

### Accessing the Calibrating Status Register Group's Registers

The following sections show the syntax and give programming examples, using the HP BASIC programming language, for the STATus commands used to access the Calibrating Status Register Group's registers.

#### Reading the Condition Register

##### Syntax

```
STATus:OPERation:CALibrating:CONDition?
```

##### Example

```
OUTPUT 714;"STAT:OPERation:CALibrating:COND?"  
ENTER 714;Register_value
```

#### Reading the Transition Filters

##### Syntax

```
STATus:OPERation:CALibrating:PTRansition?  
STATus:OPERation:CALibrating:NTRansition?
```

##### Example

```
OUTPUT 714;"STAT:OPERation:CALibrating:PTR?"  
ENTER 714;Register_value
```

#### Writing the Transition Filters

##### Syntax

```
STATus:OPERation:CALibrating:PTRansition <integer>  
STATus:OPERation:CALibrating:NTRansition <integer>
```

##### Example

```
OUTPUT 714;"STAT:OPERation:CALibrating:PTR 256"
```

**Reading the Event Register****Syntax**

```
STATus:OPERation:CALibrating:EVENT?
```

**Example**

```
OUTPUT 714;"STAT:OPERation:CALibrating:EVENT?"
ENTER 714;Register_value
```

**Clearing the Event Register**

The EVENT register is cleared whenever it is queried or whenever the Common Command \*CLS is sent to the Test Set.

**Reading the Enable Register****Syntax**

```
STATus:OPERation:CALibrating:ENABLE?
```

**Example**

```
OUTPUT 714;"STAT:OPERation:CALibrating:ENAB?"
ENTER 714;Register_value
```

**Writing the Enable Register****Syntax**

```
STATus:OPERation:CALibrating:ENABLE <integer>
```

**Example**

```
OUTPUT 714;"STAT:OPERation:CALibrating:ENAB 256"
```

**Clearing the Enable Register**

The ENABLE register is cleared by writing to it with an integer value of zero.

## Calibration Status Register Group

The Calibration Status Register Group contains information about the Test Set's hardware.

The Status Byte Register summary message associated with the Calibration Status Register Group is bit three. The Calibration Register Group SMB must be enabled in the Questionable Data/Signal Status Register Group before any of the following events or conditions can be reported through the Status Byte Register.

**Figure 12 on page 121** shows the structure and STATUS commands for the Calibration Status Register Group.

**Table 5 on page 122** details the Calibration Status Register Group Condition Register bit assignments.

Status Reporting

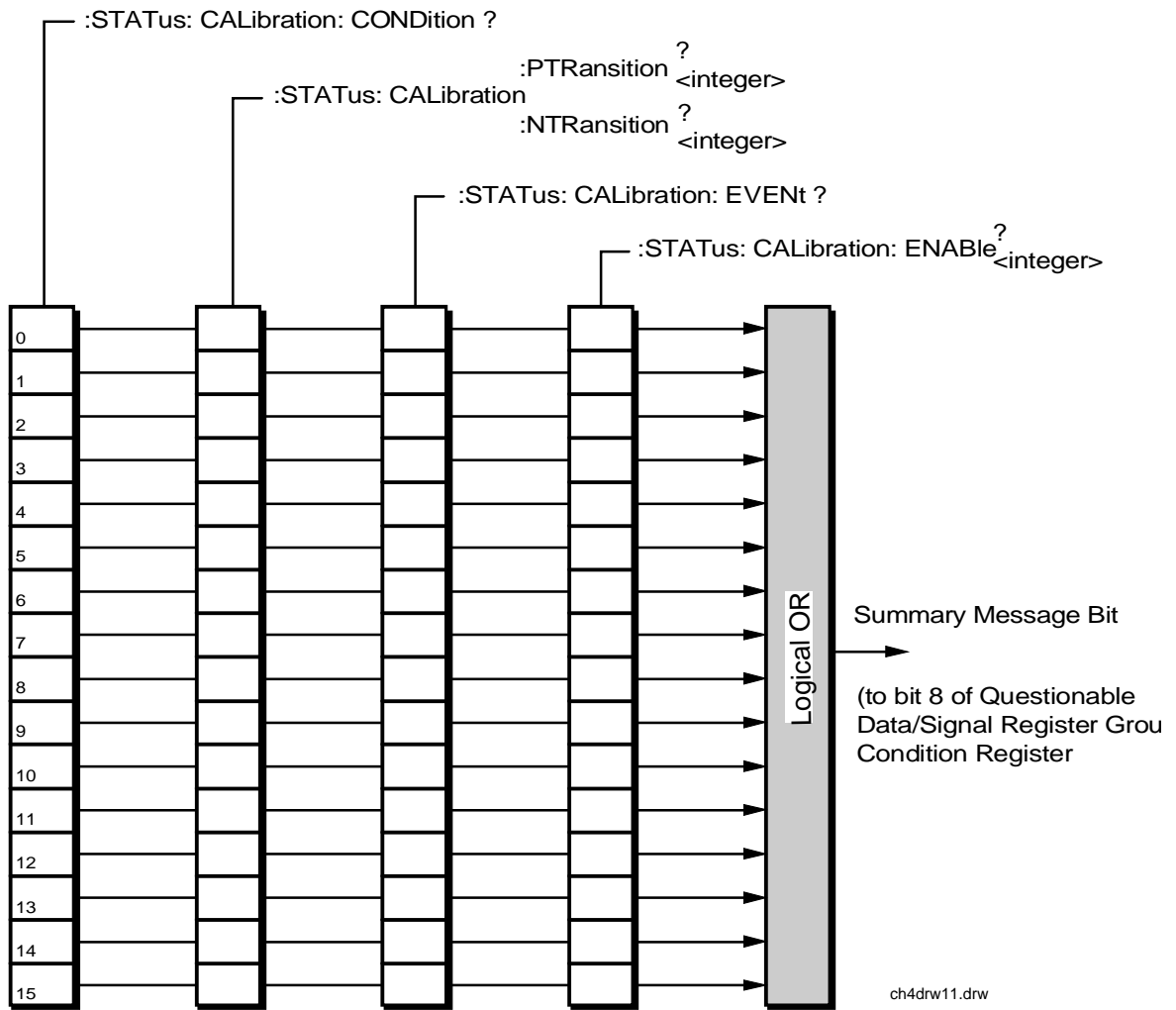

Figure 12 Calibration Status Register Group



## Status Reporting

**Table 5 Calibration Status Register Group Bit Assignments**

| <b>Bit Number</b> | <b>Is Condition Register Implemented?</b> | <b>Condition/Event</b>                           | <b>Comment</b>   |
|-------------------|---|--|--|
| 15                |   | Not Used (Always 0)                              | Defined by SCPI Version 1994.0   |
| 14                |   | Unused in Test Set                               |  |
| 13                |   | Unused in Test Set                               |  |
| 12                |   | Unused in Test Set                               |  |
| 11                |   | Unused in Test Set                               |  |
| 10                |   | Unused in Test Set                               |  |
| 9                 |   | Unused in Test Set                               |  |
| 8                 | NO  | CDMA Baseband Physical Channel Calibration Error |  |
| 7                 |   | Unused in Test Set                               |  |
| 6                 | NO  | Channel Power Calibration Failed                 | Make sure cables are connected between DUPLEX OUT or RF Out Only (PCS Interface) and RF IN/OUT connectors. |
| 5                 | NO  | Digital Power Zeroing Failed                     | CDMA Average Power measurement zero attempt failed.  |
| 4                 | NO  | TX Power Auto-Zero Failed                        |  |
| 3                 | YES                                       | Voltmeter Self-Calibration Failed                |  |
| 2                 | YES                                       | Counter Self-Calibration Failed                  |  |
| 1                 | YES                                       | Sampler Self-Calibration Failed                  |  |
| 0                 | YES                                       | Spectrum Analyzer Self-Calibration Failed        |  |

### Accessing the Calibration Status Register Group Registers

The following sections show the syntax and give programming examples, using the HP BASIC programming language, for the STATus commands used to access the Calibration Status Register Group registers.

#### Reading the Condition Register

##### Syntax

```
STATus:CALibration:CONDition?
```

##### Example

```
OUTPUT 714;"STAT:CAL:COND?"
ENTER 714;Register_value
```

#### Reading the Transition Filters

##### Syntax

```
STATus:CALibration:PTRansition?
STATus:CALibration:NTRansition?
```

##### Example

```
OUTPUT 714;"STAT:CAL:PTR?"
ENTER 714;Register_value
```

#### Writing the Transition Filters

##### Syntax

```
STATus:CALibration:PTRansition <integer>
STATus:CALibration:NTRansition <integer>
```

##### Example

```
OUTPUT 714;"STAT:CAL:PTR 256"
```

## Status Reporting

### Reading the Event Register

#### Syntax

```
STATus:CALibration:EVENT?
```

#### Example

```
OUTPUT 714;"STAT:CAL:EVENT?"  
ENTER 714;Register_value
```

### Clearing the Event Register

The EVENT register is cleared whenever it is queried or whenever the Common Command \*CLS is sent to the Test Set.

### Reading the Enable Register

#### Syntax

```
STATus:CALibration:ENABLE?
```

#### Example

```
OUTPUT 714;"STAT:CAL:ENAB?"  
ENTER 714;Register_value
```

### Writing the Enable Register

#### Syntax

```
STATus:CALibration:ENABLE <integer>
```

#### Example

```
OUTPUT 714;"STAT:CAL:ENAB 256"
```

### Clearing the Enable Register

The ENABLE register is cleared by writing to it with an integer value of zero.

## Call Processing Status Register Group

The Call Processing Status Register Group contains information about the Test Set's analog Call Processing Subsystem. This status group is accessed using the STATUS commands. The Call Processing Status Register Group uses 16-bit registers and includes a Condition Register, Transition Filters, an Event Register, an Enable Register, and a Summary Message Bit.

**Figure 12** shows the structure and STATUS commands for the Call Processing Status Register Group.

Refer to the "**Status Register Structure Overview**" on page 106 for a discussion of status register operation.

**Table 5** details the Call Processing Status Register Group's Condition Register bit assignments.

Status Reporting

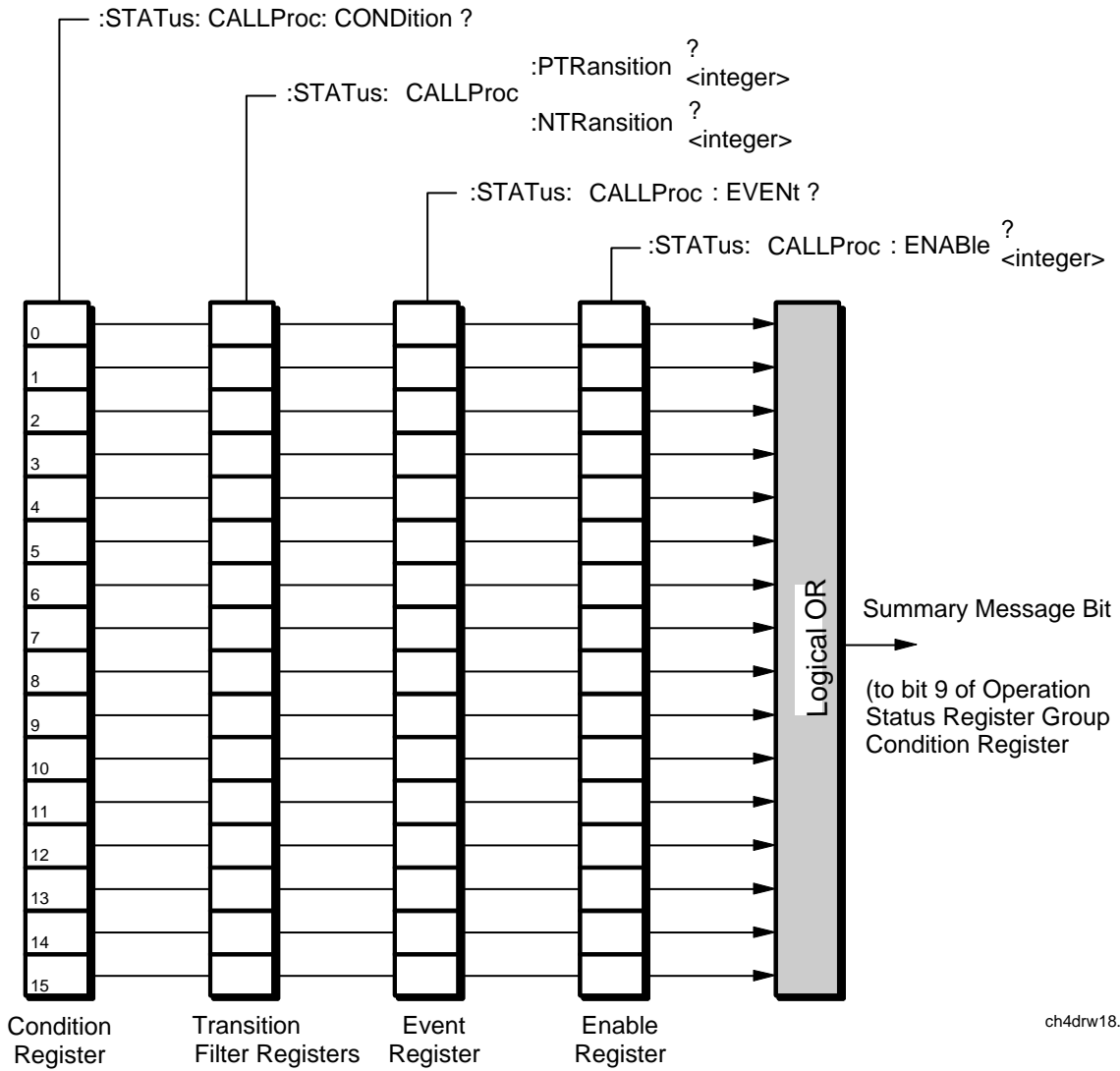

**Figure 13** Calibration Status Register Group

**Table 6 Call Processing Status Register Group, Condition Register Bit Assignments**

| <b>Bit Number</b> | <b>Is Condition Register Implemented?</b> | <b>Condition</b>  | <b>Comment</b>   |
|-------------------|---|---|--|
| 15                |   | Not Used (Always 0)                                       | Defined by SCPI Version 1994.0   |
| 14                |   | Unused in Test Set  |  |
| 13                |   | Unused in Test Set  |  |
| 12                |   | Unused in Test Set  |  |
| 11                |   | Unused in Test Set  |  |
| 10                |   | Unused in Test Set  |  |
| 9                 |   | Unused in Test Set  |  |
| 8                 |   | Unused in Test Set  |  |
| 7                 |   | Unused in Test Set  |  |
| 6                 | Yes                                       | Mobile station ringing.                                   | Bit state goes true (1) after a base station originated call is attempted and the call processing state has progressed past Access. Answering the call from the mobile station causes the bit state to go false (0). |
| 5                 | Yes                                       | Call Processing subsystem in the <b>Connect</b> state     | Bit state mirrors the condition of the Connect pseudo-LED on the CRT display (1=ON, 0=OFF)   |
| 4                 | Yes                                       | Call Processing subsystem is in the <b>Access</b> state   | Bit state mirrors the condition of the Access pseudo-LED on the CRT display (1=ON, 0=OFF)  |
| 3                 | Yes                                       | Call Processing subsystem is in the <b>Page</b> state     | Bit state mirrors the condition of the Page pseudo-LED on the CRT display (1=ON, 0=OFF)  |
| 2                 | Yes                                       | Authenticating  | Call processing is authenticating  |
| 1                 | Yes                                       | Call Processing subsystem is in the <b>Register</b> state | bit state mirrors the condition of the Register pseudo-LED on the CRT display (1=ON, 0=OFF)  |
| 0                 | Yes                                       | Call Processing subsystem is in the <b>Active</b> state   | bit state mirrors the condition of the Active pseudo-LED on the CRT display (1=ON, 0=OFF)  |

## Status Reporting

### Accessing the Call Processing Status Register Group's Registers

The following sections show the syntax and give programming examples (using the HP BASIC programming language) for the STATus commands used to access the Call Processing Status Register Group's registers.

#### Reading the Condition Register

##### Syntax

```
STATus:CALLProc:CONDition?
```

##### Example

```
OUTPUT 714;"STAT:CALLP:COND?"  
ENTER 714;Register_value
```

#### Reading the Transition Filters

##### Syntax

```
STATus:CALLProc:PTRansition?  
STATus:CALLProc:NTRansition?
```

##### Example

```
OUTPUT 714;"STAT:CALLP:PTR?"  
ENTER 714;Register_value
```

#### Writing the Transition Filters

##### Syntax

```
STATus:CALLProc:PTRansition <integer>  
STATus:CALLProc:NTRansition <integer>
```

##### Example

```
OUTPUT 714;"STAT:CALLP:PTR 256"
```

### Reading the Event Register

#### Syntax

```
STATus:CALLProc:EVENT?
```

#### Example

```
OUTPUT 714;"STAT:CALLP:EVENT?"  
ENTER 714;Register_value
```

### Clearing the Event Register

The EVENT register is cleared whenever it is queried or whenever the Common Command \*CLS is sent to the Test Set.

### Reading the Enable Register

#### Syntax

```
STATus:CALLProc:ENABle?
```

#### Example

```
OUTPUT 714;"STAT:CALLP:ENAB?"  
ENTER 714;Register_value
```

### Writing the Enable Register

#### Syntax

```
STATus:CALLProc:ENABle <integer>
```

#### Example

```
OUTPUT 714;"STAT:CALLP:ENAB 256"
```

### Clearing the Enable Register

The ENABLE register is cleared by writing to it with an integer value of zero.



### **CDMA Authentication Status Register Group**

The CDMA Authentication Status Register Group contains information about the status of authentication tests.

**Figure 14** shows the structure and STATUS commands for the CDMA Authentication Status Register Group.

**Table 7** shows the CDMA Authentication Status Register Group bit assignments.

Status Reporting

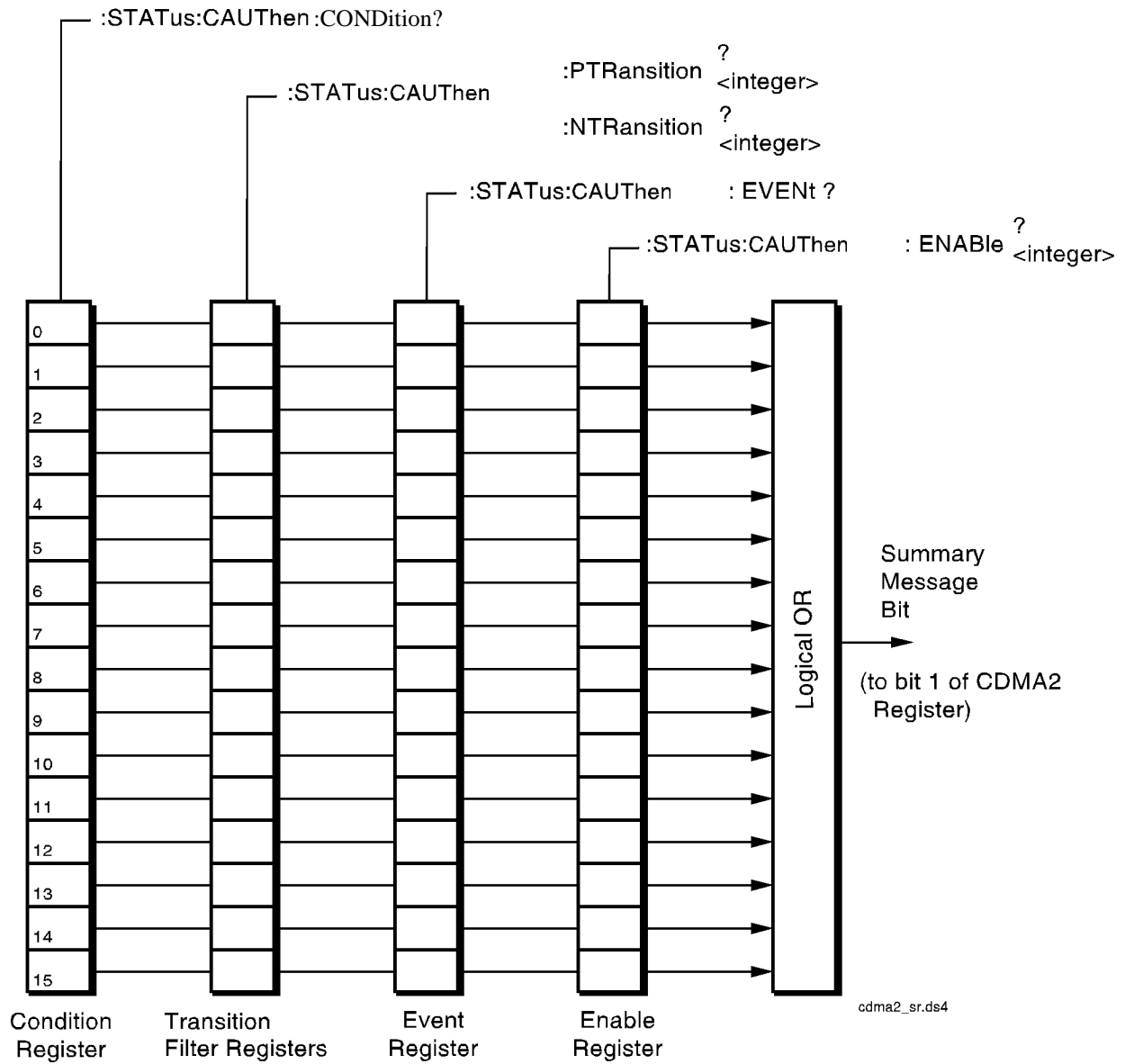

Figure 14 CDMA Authentication Status Register Group

## Status Reporting

**Table 7** CDMA Authentication Status Register Group Bit Assignments

| <b>Bit Number</b> | <b>Is Condition Register Implemented?</b> | <b>Condition/Event</b>                  | <b>Comment</b> |
|-------------------|---|---|----------------|
| 15                |   |   | Not used       |
| 14                |   |   |                |
| 13                |   |   |                |
| 12                | NO  | Data Burst Message Result               |                |
| 11                | NO  | SSD Update passed                       |                |
| 10                | NO  | Unique Challenge passed                 |                |
| 9                 | NO  | Origination with authentication passed  |                |
| 8                 | NO  | Page with authentication passed         |                |
| 7                 | NO  | Registration with authentication passed |                |
| 6                 |   |   | Not used       |
| 5                 |   |   |                |
| 4                 |   |   |                |
| 3                 | YES                                       | SSD_A=0                                 |                |
| 2                 | YES                                       | Unique Challenge in Progress            |                |
| 1                 | YES                                       | SSD Update in Progress                  |                |
| 0                 | YES                                       | Authentication in Progress              |                |

### Accessing the CDMA Authentication Status Register Group Registers

The following sections show the syntax and give programming examples, using the HP BASIC programming language, for the STATus commands used to access the CDMA Authentication Status Register Group registers.

#### Reading the Condition Register

##### Syntax

```
STATus:CAUT:CONDition?
```

##### Example

```
OUTPUT 714;"STAT:CAUT:COND?"  
ENTER 714;Register_value
```

#### Reading the Transition Filters

##### Syntax

```
STATus:CAUT:PTRansition?  
STATus:CAUT:NTRansition?
```

##### Example

```
OUTPUT 714;"STAT:CAUT:PTR?"  
ENTER 714;Register_value
```

#### Writing the Transition Filters

##### Syntax

```
STATus:CAUT:PTRansition <integer>  
STATus:CAUT:NTRansition <integer>
```

##### Example

```
OUTPUT 714;"STAT:CAUT:PTR 1"
```

## Status Reporting

### Reading the Event Register

#### Syntax

```
STATus:CAUT:EVENT?
```

#### Example

```
OUTPUT 714;"STAT:CAUT:EVENT?"  
ENTER 714;Register_value
```

### Clearing the Event Register

The EVENT register is cleared whenever it is queried or whenever the Common Command \*CLS is sent to the Test Set.

### Reading the Enable Register

#### Syntax

```
STATus:CAUT:ENABle?
```

#### Example

```
OUTPUT 714;"STAT:CAUT:ENAB?"  
ENTER 714;Register_value
```

### Writing the Enable Register

#### Syntax

```
STATus:CAUT:ENABle <integer>
```

#### Example

```
OUTPUT 714;"STAT:CAUT:ENAB 256"
```

### Clearing the Enable Register

The ENABLE register is cleared by writing to it with an integer value of zero.

**CDMA SMS Status Register Group**

The CDMA Status Register Group reports the status of SMS (Short Message Service) operations.

**Figure 15** shows the structure and STATUS commands for the CDMA SMS Status Register Group.

**Table 8** shows the CDMA Status Register Group bit assignments.

Status Reporting

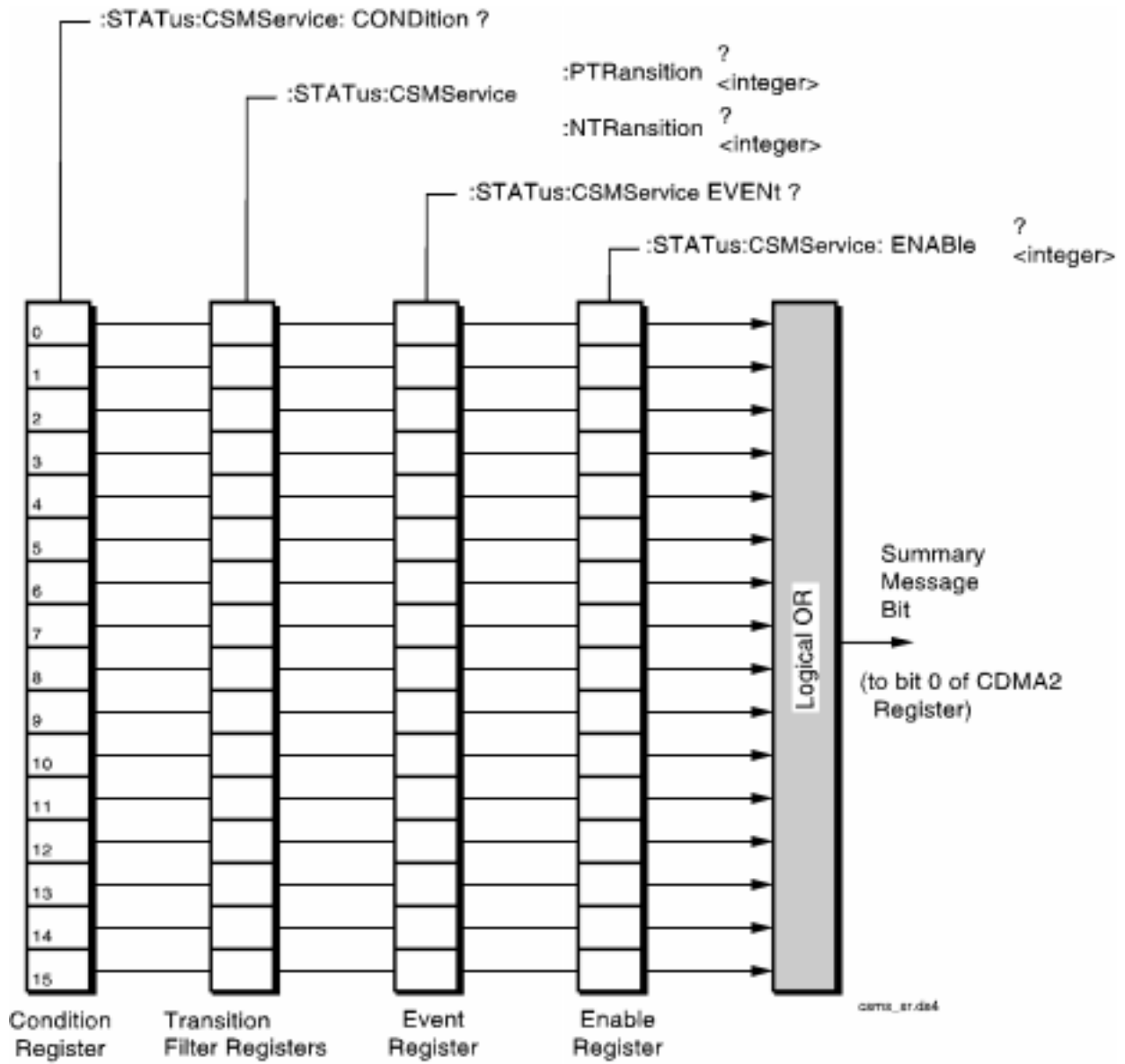

Figure 15 CDMA SMS Status Register Group

## Status Reporting

**Table 8** CDMA SMS Status Register Group Bit Assignments

| <b>Bit Number</b> | <b>Is Condition Register Implemented?</b> | <b>Condition/Event</b>  | <b>Comment</b>  |
|-------------------|---|-------------------------|---|
| 15                |   |                         |   |
| 14                |   |                         |   |
| 13                |   |                         |   |
| 12                |   |                         |   |
| 11                |   |                         |   |
| 10                |   |                         |   |
| 9                 |   |                         |   |
| 8                 |   |                         |   |
| 7                 |   |                         |   |
| 6                 |   |                         |   |
| 5                 |   |                         |   |
| 4                 |   |                         |   |
| 3                 |   |                         |   |
| 2                 |   |                         |   |
| 1                 | No  | MS Acknowledge Received | The mobile station acknowledged receiving an SMS message                            |
| 0                 | Yes                                       | SMS In Progress         | A SMS message was sent and the Test Set is waiting for SMS message acknowledgement. |



## Status Reporting

### Accessing the CDMA SMS Status Register Group Registers

The following sections show the syntax and give programming examples, using the HP BASIC programming language, for the STATus commands used to access the CDMA SMS Status Register Group registers.

#### Reading the Condition Register

##### Syntax

```
STATus:CSMS:CONDition?
```

##### Example

```
OUTPUT 714;"STAT:CSMS:COND?"  
ENTER 714;Register_value
```

#### Reading the Transition Filters

##### Syntax

```
STATus:CSMS:PTRansition?  
STATus:CSMS:NTRansition?
```

##### Example

```
OUTPUT 714;"STAT:CSMS:PTR?"  
ENTER 714;Register_value
```

#### Writing the Transition Filters

##### Syntax

```
STATus:CSMS:PTRansition <integer>  
STATus:CSMS:NTRansition <integer>
```

##### Example

```
OUTPUT 714;"STAT:CSMS:PTR 1"
```

### Reading the Event Register

#### Syntax

```
STATus:CSMS:EVENT?
```

#### Example

```
OUTPUT 714;"STAT:CSMS:EVENT?"  
ENTER 714;Register_value
```

### Clearing the Event Register

The EVENT register is cleared whenever it is queried or whenever the Common Command \*CLS is sent to the Test Set.

### Reading the Enable Register

#### Syntax

```
STATus:CSMS:ENABle?
```

#### Example

```
OUTPUT 714;"STAT:CSMS:ENAB?"  
ENTER 714;Register_value
```

### Writing the Enable Register

#### Syntax

```
STATus:CSMS:ENABle <integer>
```

#### Example

```
OUTPUT 714;"STAT:CSMS:ENAB 256"
```

### Clearing the Enable Register

The ENABLE register is cleared by writing to it with an integer value of zero.

## CDMA Status Register Group

The CDMA Status Register Group contains information about various signaling events.

The CDMA Status Register SMB must be enabled in the Operation Status Register Group before any of the following events or conditions can be reported through the Status Byte Register.

**Figure 15** shows the structure and STATUS commands for the CDMA Status Register Group.

**Table 8** shows the CDMA Status Register Group bit assignments.

Status Reporting

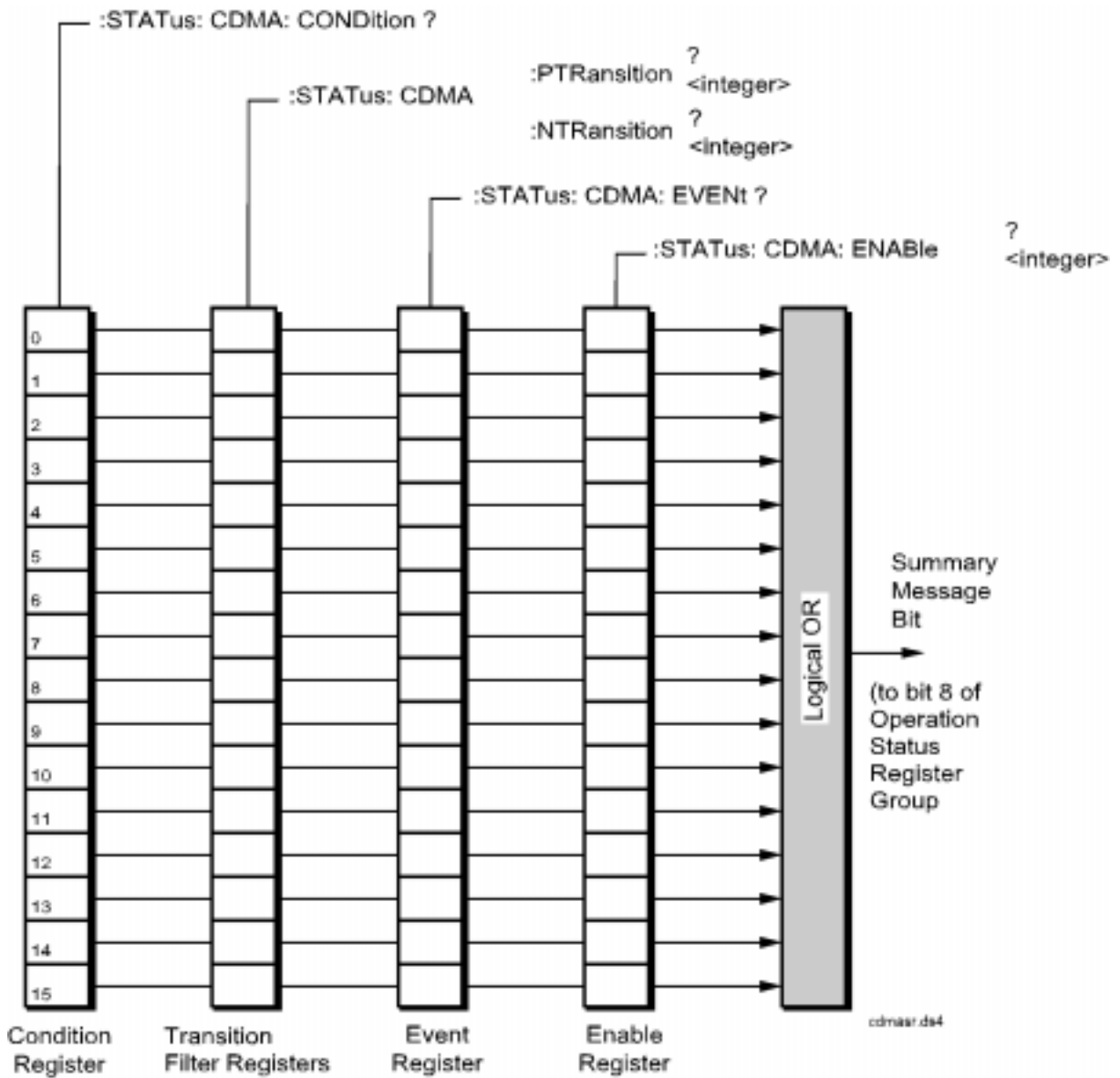

Figure 16 CDMA Status Register Group

## Status Reporting

**Table 9** CDMA Status Register Group Bit Assignments

| Bit Number | Is Condition Register Implemented? | Condition/Event                 | Comment   |
|------------|------------------------------------|---------------------------------|---|
| 15         |                                    |                                 |   |
| 14         |                                    |                                 | Not used.   |
| 13         | NO                                 | MS reported FER received        | This event register bit will be set to a logic 1 when the MSUT reports FER. MS reported FER is influenced by the MS FER Report Interval fields.   |
| 12         | NO                                 | Pilot Strength message received | This event register bit will be set to a logic 1 when the Test Set receives a Pilot Strength message from the MSUT. Each Pilot Strength message will update the CDMA Mobile Reporting table, which displays the Status, PN Offset, Strength, and Keep bit for CDMA pilot signals. |
| 11         | NO                                 | Registered                      | This event register bit will be set to a logic 1 when the front panel display annunciator "Registering" goes out, indicating the mobile station has registered.   |
| 10         | NO                                 | FER Test Passed                 |   |
| 9          | NO                                 | FER Test Failed                 |   |
| 8          | NO                                 | FER Test reached Max Frames     |   |
| 7          | YES                                | Service Option 2                |   |
| 6          | YES                                | Hard Handoff                    |   |
| 5          | YES                                | Softer Handoff                  |   |
| 4          | YES                                | Alerting                        | The Alerting Condition Register bit will be set to logic 1 while the MSUT is ringing. This only occurs during a Service Option 1 call from the Test SET (MSUT terminated).  |

**Table 9** CDMA Status Register Group Bit Assignments (Continued)

| Bit Number | Is Condition Register Implemented? | Condition/Event | Comment   |
|------------|------------------------------------|-----------------|---|
| 3          | YES                                | Connected       | The “Connected” Condition Register bit will be set to a logic 1 when a call is connected. See the Connected (annunciator) field description in the <i>Agilent 8924C Reference Guide</i> .   |
| 2          | YES                                | Transmitting    | The “Transmitting” Condition Register bit will be set to a logic 1 when the Test Set is in CDMA mode. See <b>"CDMA and Analog Modes" on page 23</b> .   |
| 1          | YES                                | Page Sent       | The “Page Sent” Condition Register bit will be set to a logic 1 when the the CALL key is pressed or the corresponding GPIB command is sent. This Condition bit will remain 1 until the current call or call attempt has ended. See the Page Sent (annunciator) field description in the <i>Agilent 8924C Reference Guide</i> .  |
| 0          | YES                                | Access Probe    | The “Access Probe” Condition Register bit will be set to a logic 1 when a mobile station sends an access probe sequence to the Test Set.. This Condition bit will remain 1 until the current call or call attempt has ended. See the Access Probe (annunciator) field description in the <i>Agilent 8924C Reference Guide</i> . |

## Status Reporting

### Accessing the CDMA Status Register Group Registers

The following sections show the syntax and give programming examples, using the HP BASIC programming language, for the STATus commands used to access the CDMA Status Register Group registers.

#### Reading the Condition Register

##### Syntax

```
STATus:CDMA:CONDition?
```

##### Example

```
OUTPUT 714;"STAT:CDMA:COND?"  
ENTER 714;Register_value
```

#### Reading the Transition Filters

##### Syntax

```
STATus:CDMA:PTRansition?  
STATus:CDMA:NTRansition?
```

##### Example

```
OUTPUT 714;"STAT:CDMA:PTR?"  
ENTER 714;Register_value
```

#### Writing the Transition Filters

##### Syntax

```
STATus:CDMA:PTRansition <integer>  
STATus:CDMA:NTRansition <integer>
```

##### Example

```
OUTPUT 714;"STAT:CDMA:PTR 256"
```

### Reading the Event Register

#### Syntax

```
STATus:CDMA:EVENT?
```

#### Example

```
OUTPUT 714;"STAT:CDMA:EVENT?"  
ENTER 714;Register_value
```

### Clearing the Event Register

The EVENT register is cleared whenever it is queried or whenever the Common Command \*CLS is sent to the Test Set.

### Reading the Enable Register

#### Syntax

```
STATus:CDMA:ENABle?
```

#### Example

```
OUTPUT 714;"STAT:CDMA:ENAB?"  
ENTER 714;Register_value
```

### Writing the Enable Register

#### Syntax

```
STATus:CDMA:ENABle <integer>
```

#### Example

```
OUTPUT 714;"STAT:CDMA:ENAB 256"
```

### Clearing the Enable Register

The ENABLE register is cleared by writing to it with an integer value of zero.



### **CDMA\_2 Status Register Group**

The CDMA\_2 Status Register Group provides a path for summary messages to the Operation Status Register for status registers that were added to the Agilent 8924C after Firmware A.06.00.

**Figure 17** shows the structure and STATUS commands for the CDMA\_2 Status Register Group.

**Table 10** shows the CDMA\_2 Status Register Group bit assignments.

Status Reporting

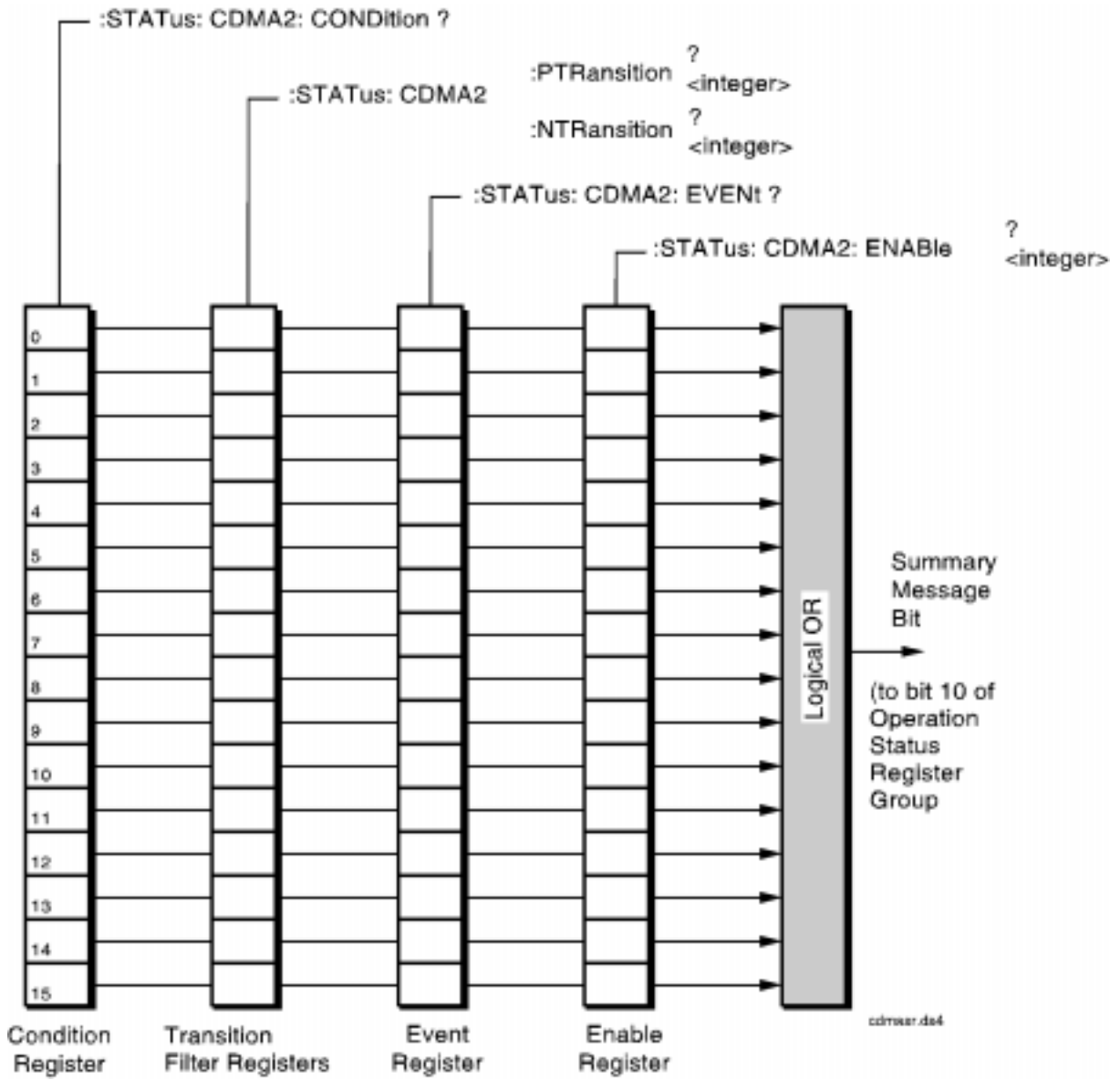

Figure 17 CDMA\_2 Status Register Group

## Status Reporting

**Table 10** CDMA\_2 Status Register Group Bit Assignments

| Bit Number | Is Condition Register Implemented? | Condition/Event                                    | Comment  |
|------------|------------------------------------|--|--|
| 15         |                                    |  | Reserved   |
| 14         |                                    |  |  |
| 13         |                                    |  |  |
| 12         |                                    |  |  |
| 11         |                                    |  |  |
| 10         |                                    |  |  |
| 9          |                                    |  |  |
| 8          |                                    |  |  |
| 7          | NO                                 | Even Second Clock                                  | Event bit is set each even (2) second clock tick.  |
| 6          |                                    |  |  |
| 5          |                                    |  |  |
| 4          |                                    |  |  |
| 3          |                                    |  |  |
| 2          | YES                                | Closed Loop Power Control Step Size Change Pending | A change was made to the Power Cntl Step Size field, and a response to the Power Control Message is pending. |
| 1          | YES                                | CDMA Authentication Status Register SMB            |  |
| 0          | YES                                | CDMA SMS Status Register SMB                       |  |

**Accessing the CDMA\_2 Status Register Group Registers**

The following sections show the syntax and give programming examples, using the HP BASIC programming language, for the STATus commands used to access the CDMA\_2 Status Register Group registers.

**Reading the Condition Register****Syntax**

```
STATus:CDMA2:CONDition?
```

**Example**

```
OUTPUT 714;"STAT:CDMA2:COND?"
ENTER 714;Register_value
```

**Reading the Transition Filters****Syntax**

```
STATus:CDMA2:PTRansition?
STATus:CDMA2:NTRansition?
```

**Example**

```
OUTPUT 714;"STAT:CDMA2:PTR?"
ENTER 714;Register_value
```

**Writing the Transition Filters****Syntax**

```
STATus:CDMA2:PTRansition <integer>
STATus:CDMA2:NTRansition <integer>
```

**Example**

```
OUTPUT 714;"STAT:CDMA2:PTR 1"
```

## Status Reporting

### Reading the Event Register

#### Syntax

```
STATus:CDMA2:EVENT?
```

#### Example

```
OUTPUT 714;"STAT:CDMA2:EVENT?"  
ENTER 714;Register_value
```

### Clearing the Event Register

The EVENT register is cleared whenever it is queried or whenever the Common Command \*CLS is sent to the Test Set.

### Reading the Enable Register

#### Syntax

```
STATus:CDMA2:ENABLE?
```

#### Example

```
OUTPUT 714;"STAT:CDMA2:ENAB?"  
ENTER 714;Register_value
```

### Writing the Enable Register

#### Syntax

```
STATus:CDMA2:ENABLE <integer>
```

#### Example

```
OUTPUT 714;"STAT:CDMA2:ENAB 256"
```

### Clearing the Enable Register

The ENABLE register is cleared by writing to it with an integer value of zero.

## Communication Status Register Group

The Communication Status Register Group contains information about the Test Set's hardware, and the summary message bits for the Serial 1 and Serial 2 Status Register Groups.

The Status Byte Register summary message associated with the Communication Status Register Group is bit zero. The Communication Status Register Group SMB must be enabled in the Hardware1 Status Register Group before any of the following events or conditions can be reported through the Status Byte Register.

**Figure 18** shows the structure and STATUS commands for the Communication Status Register Group.

**Table 11** shows the Communication Status Register Group Condition Register bit assignments.

Status Reporting

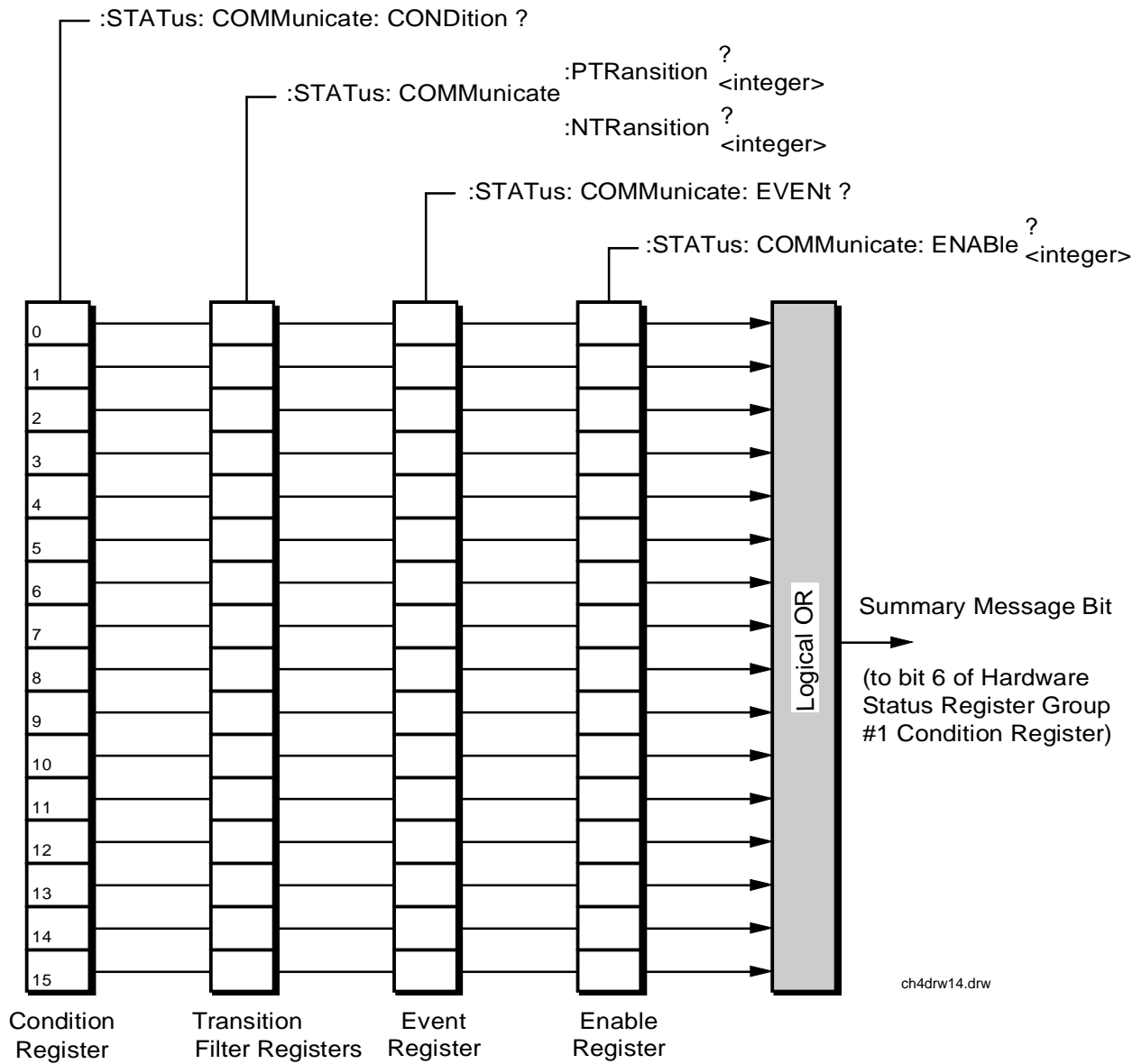

**Figure 18** Communication Status Register Group

**Table 11**      **Communication Status Register Group Bit Assignments**

| <b>Bit Number</b> | <b>Is Condition Register Implemented?</b> | <b>Condition/Event</b>                                 | <b>Comment</b>                 |
|-------------------|---|--|--------------------------------|
| 15                |   | Not Used (Always 0)                                    | Defined by SCPI Version 1994.0 |
| 14                |   | Unused in Test Set                                     |                                |
| 13                |   | Unused in Test Set                                     |                                |
| 12                |   | Unused in Test Set                                     |                                |
| 11                |   | Unused in Test Set                                     |                                |
| 10                |   | Unused in Test Set                                     |                                |
| 9                 | YES                                       | Serial 1 Status Register Group SMB                     |                                |
| 8                 | YES                                       | Serial 2 Status Register Group SMB                     |                                |
| 7                 |   | Unused in Test Set                                     |                                |
| 6                 |   | Unused in Test Set                                     |                                |
| 5                 |   | Unused in Test Set                                     |                                |
| 4                 |   | Unused in Test Set                                     |                                |
| 3                 |   | Unused in Test Set                                     |                                |
| 2                 |   | Unused in Test Set                                     |                                |
| 1                 |   | Receiver DSP Communication Failure                     |                                |
| 0                 | YES                                       | Transmitter DSP Analyzer Communication Channel Failure |                                |



## Status Reporting

### Accessing the Communication Status Register Group Registers

The following sections show the syntax and give programming examples, using the HP BASIC programming language, for the STATus commands used to access the Communication Status Register Group registers.

#### Reading the Condition Register

##### Syntax

```
STATus:COMMunication:CONDition?
```

##### Example

```
OUTPUT 714;"STAT:COMM:COND?"  
ENTER 714;Register_value
```

#### Reading the Transition Filters

##### Syntax

```
STATus:COMMunication:PTRansition?  
STATus:COMMunication:NTRansition?
```

##### Example

```
OUTPUT 714;"STAT:COMM:PTR?"  
ENTER 714;Register_value
```

#### Writing the Transition Filters

##### Syntax

```
STATus:COMMunication:PTRansition <integer>  
STATus:COMMunication:NTRansition <integer>
```

##### Example

```
OUTPUT 714;"STAT:COMM:PTR 256"
```

### Reading the Event Register

#### Syntax

```
STATus:COMMunication:EVENT?
```

#### Example

```
OUTPUT 714;"STAT:COMM:EVENT?"  
ENTER 714;Register_value
```

### Clearing the Event Register

The EVENT register is cleared whenever it is queried or whenever the Common Command \*CLS is sent to the Test Set.

### Reading the Enable Register

#### Syntax

```
STATus:COMMunication:ENABLE?
```

#### Example

```
OUTPUT 714;"STAT:COMM:ENAB?"  
ENTER 714;Register_value
```

### Writing the Enable Register

#### Syntax

```
STATus:COMMunication:ENABLE <integer>
```

#### Example

```
OUTPUT 714;"STAT:COMM:ENAB 256"
```

### Clearing the Enable Register

The ENABLE register is cleared by writing to it with an integer value of zero.

### Error Message Queue Group

The Error Message Queue Group is an implementation of the status queue model described in "Status Queue Model" on page 111. The Error Message Queue Group is a first-in, first-out (FIFO) queue that holds up to 20 messages. The Error Message Queue Group includes a FIFO queue but no Message Available (MAV) Summary Message.

Figure 19 shows the structure of the Error Message Queue Group.

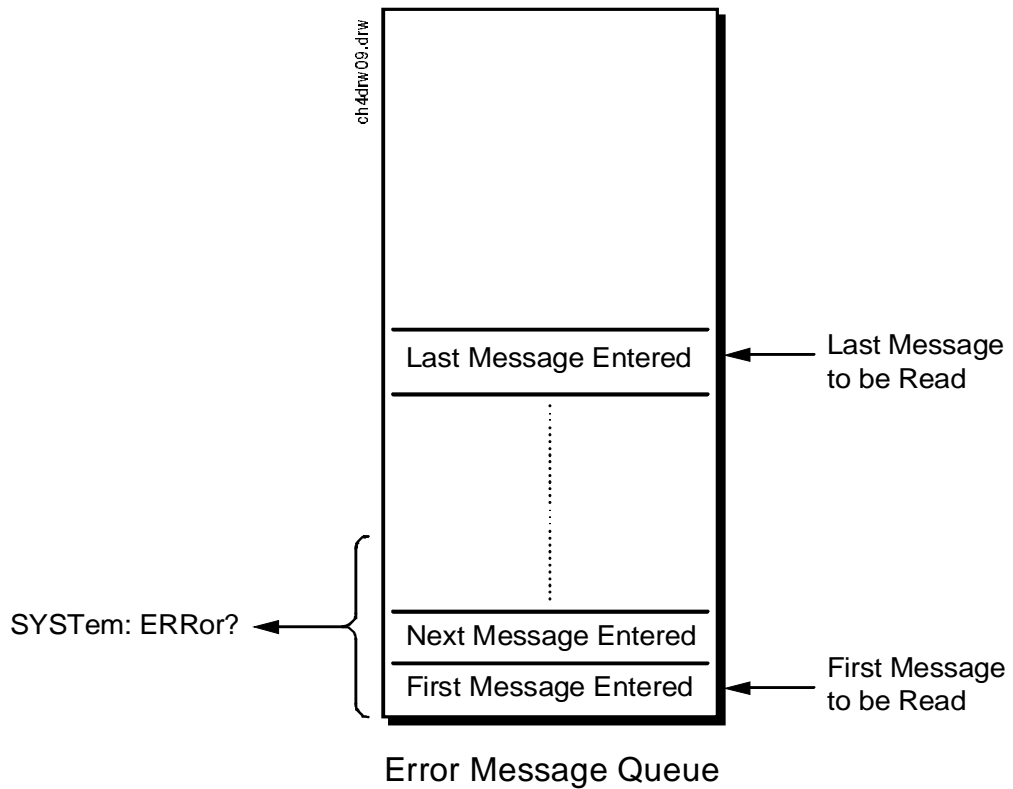

Figure 19 Error Message Queue Group

**Accessing the Error Message Queue**

A message appears in the Error Message Queue any time bit 2, 3, 4, or 5 of the Standard Event Status register is asserted. Each message consists of a signed error number, followed by a comma separator, followed by an error description string in double quotes. The maximum length of the error description string is 255 characters. If more than 20 messages are in the queue and another error occurs, the last message is replaced with the message, **-350, "Queue overflow"**. If no messages are in the queue the message, **+0, "No error"** is returned. Reading a message removes it from the queue. The Error Message Queue is accessed using the SYSTem command. Returned information is read into a numeric variable followed by a string variable.

**Reading the Error Message Queue****Syntax**

```
SYSTem:ERRor?
```

**Example**

```
OUTPUT 714;"SYST:ERR?"
ENTER 714;Error_num,Error_msg$
```

**Example IBASIC program**

```
10 INTEGER Error_num
20 DIM Error_msg$ [255]
30 OUTPUT 714;"SYST:ERR?"
40 ENTER 714;Error_num,Error_msg$
50 PRINT Error_num;Error_msg$
60 END
```

Example response

```
-113 "Undefined header"
```

## Hardware 1 Status Register Group

The Hardware 1 Status Register Group contains information about the Test Set's hardware, and the SMB for the Communicate Status Register Group.

The Status Byte Register summary message associated with the Hardware 1 Status Register Group is bit zero.

**Figure 20** shows the structure and STATUS commands for the Hardware 1 Status Register Group.

**Table 12** shows the Hardware 1 Status Register Group Condition Register bit assignments.

Status Reporting

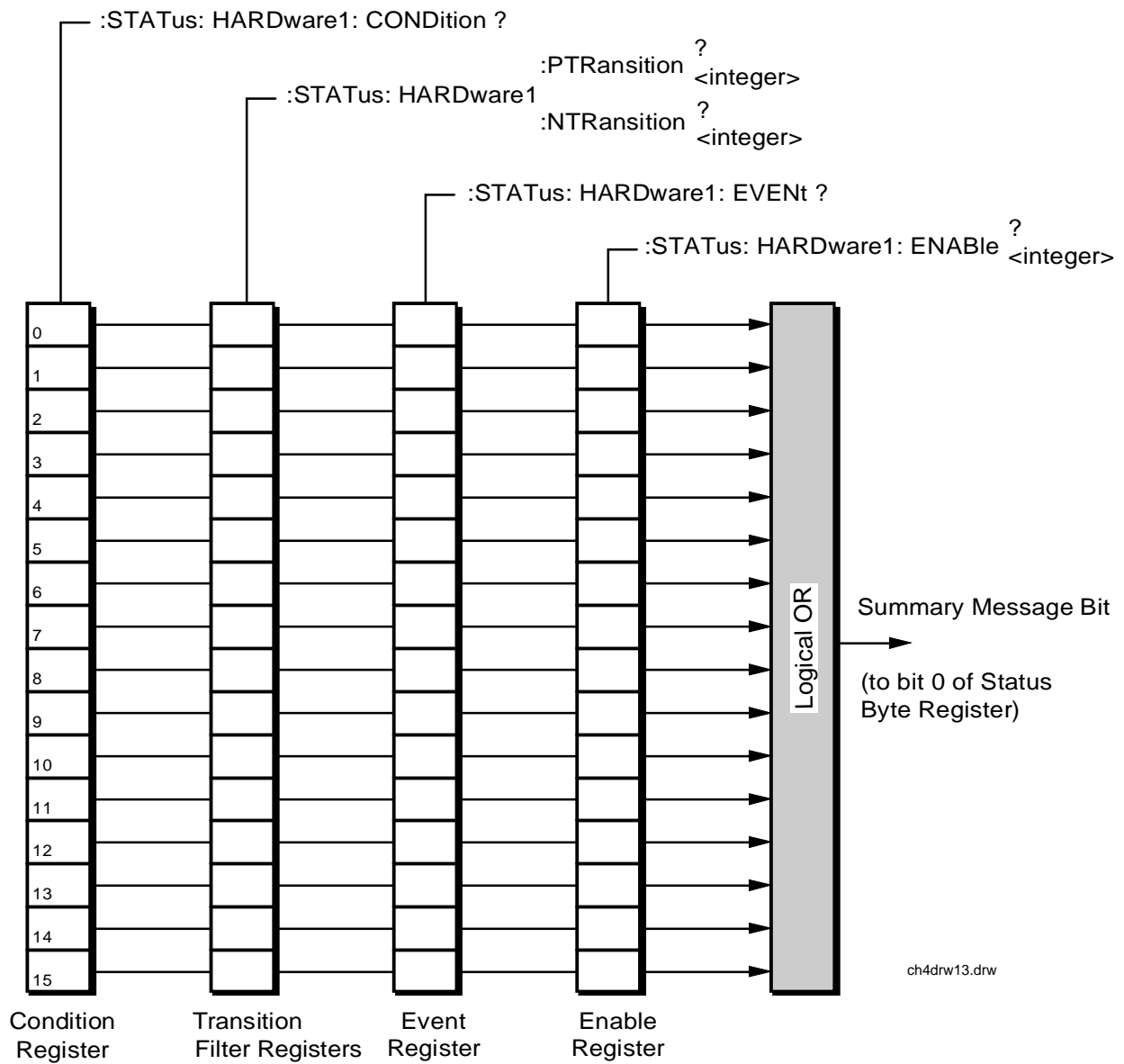

**Figure 20** Hardware 1 Status Register Group

## Status Reporting

**Table 12**      **Hardware 1 Status Register Group Bit Assignments**

| <b>Bit Number</b> | <b>Is Condition Register Implemented?</b> | <b>Condition/Event</b>                          | <b>Comment</b>  |
|-------------------|---|---|---|
| 15                |   | Not used in Test Set                            | Defined by SCPI Version 1994.0  |
| 14                | YES                                       | Radio Interface Board interrupt 2 tripped       |   |
| 13                | YES                                       | Radio Interface Board interrupt 1 tripped       |   |
| 12                | YES                                       | Signaling Decoder Measurement Results Available |   |
| 11                | YES                                       | Signaling Decoder Input Level Too Low           |   |
| 10                | YES                                       | Signaling Decoder is Measuring                  |   |
| 9                 | YES                                       | Signaling Decoder is Armed                      |   |
| 8                 | YES                                       | Signaling Encoder Sending Auxiliary Information | If the Signaling Mode selected has two information fields, such as the AMPS Filler and Message fields, and both fields are being sent, this bit will be set.  |
| 7                 | YES                                       | Signaling Encoder Sending Information           | If the Signaling Mode selected has only one information field and the field is being sent, this bit will be set high. If the Signaling Mode selected has two information fields, such as the AMPS Filler and Message fields, and only one field is being sent, this bit will be set high. This bit is not active if the Signaling Encoder Mode is set to Function Generator |
| 6                 | YES                                       | Communication Status Register Group SMB         |   |
| 5                 | NO  | Measurement Limit(s) exceeded                   | This bit is set high if the Measurement High Limit or Low Limit is exceeded   |
| 4                 | YES                                       | Power-up Self Test(s) Failed                    |   |
| 3                 | YES                                       | Overpower Protection Tripped                    |   |

## Status Reporting

**Table 12**                    **Hardware 1 Status Register Group Bit Assignments (Continued)**

| <b>Bit Number</b> | <b>Is Condition Register Implemented?</b> | <b>Condition/Event</b> | <b>Comment</b> |
|-------------------|---|------------------------|----------------|
| 2                 |   | Unused in Test Set     |                |
| 1                 | YES                                       | External Mike Keyed    |                |
| 0                 | YES                                       | Battery Voltage Low    |                |



## Status Reporting

### Accessing the Hardware Status Register #1 Group Registers

The following sections show the syntax and give programming examples, using the HP BASIC programming language, for the STATus commands used to access the Hardware Status Register #1 Group registers.

#### Reading the Condition Register

##### Syntax

```
STATus:HARDware1:CONDition?
```

##### Example

```
OUTPUT 714;"STAT:HARD1:COND?"  
ENTER 714;Register_value
```

#### Reading the Transition Filters

##### Syntax

```
STATus:HARDware1:PTRansition?  
STATus:HARDware1:NTRansition?
```

##### Example

```
OUTPUT 714;"STAT:HARD1:PTR?"  
ENTER 714;Register_value
```

#### Writing the Transition Filters

##### Syntax

```
STATus:HARDware1:PTRansition <integer>  
STATus:HARDware1:NTRansition <integer>
```

##### Example

```
OUTPUT 714;"STAT:HARD1:PTR 256"
```

### Reading the Event Register

#### Syntax

```
STATus:HardWare1:EVENT?
```

#### Example

```
OUTPUT 714;"STAT:Hard1:EVENT?"  
ENTER 714;Register_value
```

### Clearing the Event Register

The EVENT register is cleared whenever it is queried or whenever the Common Command \*CLS is sent to the Test Set.

### Reading the Enable Register

#### Syntax

```
STATus:HardWare1:ENABLE?
```

#### Example

```
OUTPUT 714;"STAT:Hard1:ENAB?"  
ENTER 714;Register_value
```

### Writing the Enable Register

#### Syntax

```
STATus:HardWare1:ENABLE <integer>
```

#### Example

```
OUTPUT 714;"STAT:Hard1:ENAB 256"
```

### Clearing the Enable Register

The ENABLE register is cleared by writing to it with an integer value of zero.

## Hardware 2 Status Register Group

The Hardware Status Register #2 Group contains information about the Test Set's hardware.

The Status Byte Register summary message associated with the Hardware 2 Status Register Group is bit one.

**Figure 21** shows the structure and STATUS commands for the Hardware 2 Status Register Group.

**Table 13** shows the Hardware 2 Status Register Group Condition Register bit assignments.

Status Reporting

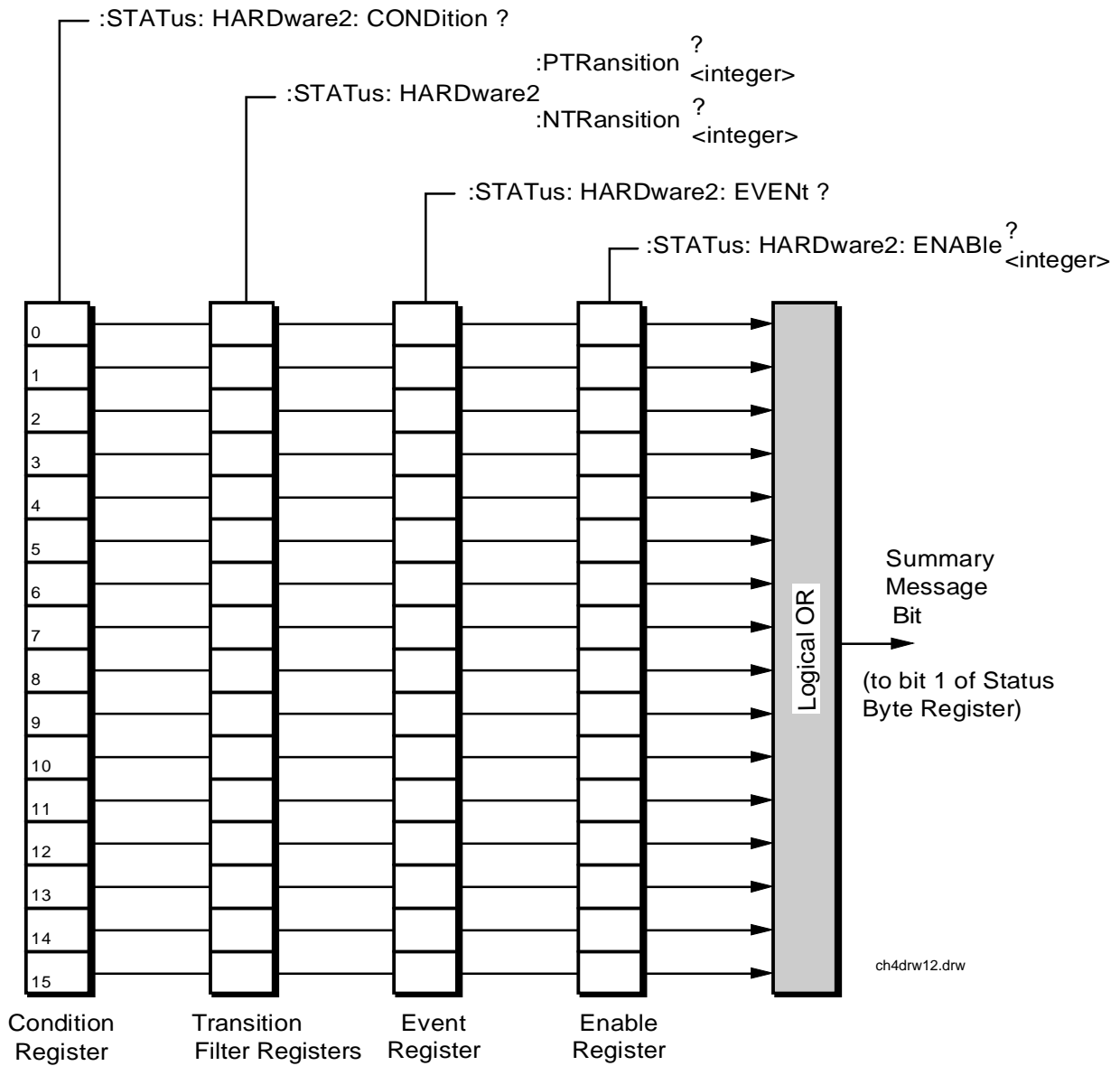

**Figure 21** Hardware 2 Status Register Group

## Status Reporting

**Table 13**      **Hardware 2 Status Register Group Bit Assignments**

| Bit Number | Is Condition Register Implemented? | Condition/Event  | Comment   |
|------------|------------------------------------|--|---|
| 15         |                                    | Not Used (Always 0)  | Defined by SCPI Version 1994.0  |
| 14         |                                    | Unused in Test Set   |   |
| 13         |                                    | Unused in Test Set   |   |
| 12         |                                    | Unused in Test Set   |   |
| 11         | YES                                | Inconsistent ACP Channel Bandwidth and Resolution Bandwidth            |   |
| 10         | YES                                | ACP Channel Bandwidth or Channel Offset too wide                       |   |
| 9          | YES                                | AFGen1 Frequency Exceeds Variable Frequency Notch Filter Range         |   |
| 8          | YES                                | Requested Audio Voltage Too Large for AFGen2                           |   |
| 7          | YES                                | Requested FM Deviation Too Large for RF Generator Frequency            |   |
| 6          | YES                                | Requested Simultaneous AM and FM Modulation                            | Simultaneous AM and FM Modulation not allowed.                        |
| 5          | YES                                | Audio Input Level Auto Ranging Error                                   |   |
| 4          | YES                                | RF Input Level Auto Ranging Error                                      |   |
| 3          | YES                                | RF Input Frequency Auto Tuning Error                                   |   |
| 2          | YES                                | RF Gen/RF Anal/RF Offset Frequency Combination Not Possible            | (RF GenTune Freq) - (RF Anal Tune Freq) not equal to (RF Offset Freq) |
| 1          | YES                                | RF Generator Amplitude Level Too High For Selected Output Port         |   |
| 0          | YES                                | Spectrum Analyzer Reference Level Too High/Low For Selected Input Port |   |

**Accessing the Hardware Status Register #2 Group Registers**

The following sections show the syntax and give programming examples, using the HP BASIC programming language, for the STATus commands used to access the Hardware 2 Status Register Group registers.

**Reading the Condition Register****Syntax**

```
STATus:HARDware2:CONDition?
```

**Example**

```
OUTPUT 714;"STAT:HARD2:COND?"
ENTER 714;Register_value
```

**Reading the Transition Filters****Syntax**

```
STATus:HARDware2:PTRansition?
STATus:HARDware2:NTRansition?
```

**Example**

```
OUTPUT 714;"STAT:HARD2:PTR?"
ENTER 714;Register_value
```

**Writing the Transition Filters****Syntax**

```
STATus:HARDware2:PTRansition <integer>
STATus:HARDware2:NTRansition <integer>
```

**Example**

```
OUTPUT 714;"STAT:HARD2:PTR 256"
```

## Status Reporting

### Reading the Event Register

#### Syntax

```
STATus: HARDware2: EVENT?
```

#### Example

```
OUTPUT 714; "STAT: HARD2: EVEN?"  
ENTER 714; Register_value
```

### Clearing the Event Register

The EVENT register is cleared whenever it is queried or whenever the Common Command \*CLS is sent to the Test Set.

### Reading the Enable Register

#### Syntax

```
STATus: HARDware2: ENABle?
```

#### Example

```
OUTPUT 714; "STAT: HARD2: ENAB?"  
ENTER 714; Register_value
```

### Writing the Enable Register

#### Syntax

```
STATus: HARDware2: ENABle <integer>
```

#### Example

```
OUTPUT 714; "STAT: HARD2: ENAB 256"
```

### Clearing the Enable Register

The ENABLE register is cleared by writing to it with an integer value of zero.

## Measuring Status Register Group

The Measuring Status Register Group contains information about measurements performed by the Test Set.

The Status Byte Register summary message associated with the Measuring Status Register Group is bit seven. The Measuring Status Register SMB must be enabled in the Operation Status Register Group before any of the

events or conditions can be reported through the Status Byte Register.

**Figure 22** shows the structure and STATUS commands for the Measuring Status Register Group.

**Table 14** shows the Measuring Status Register Group bit assignments.



Status Reporting

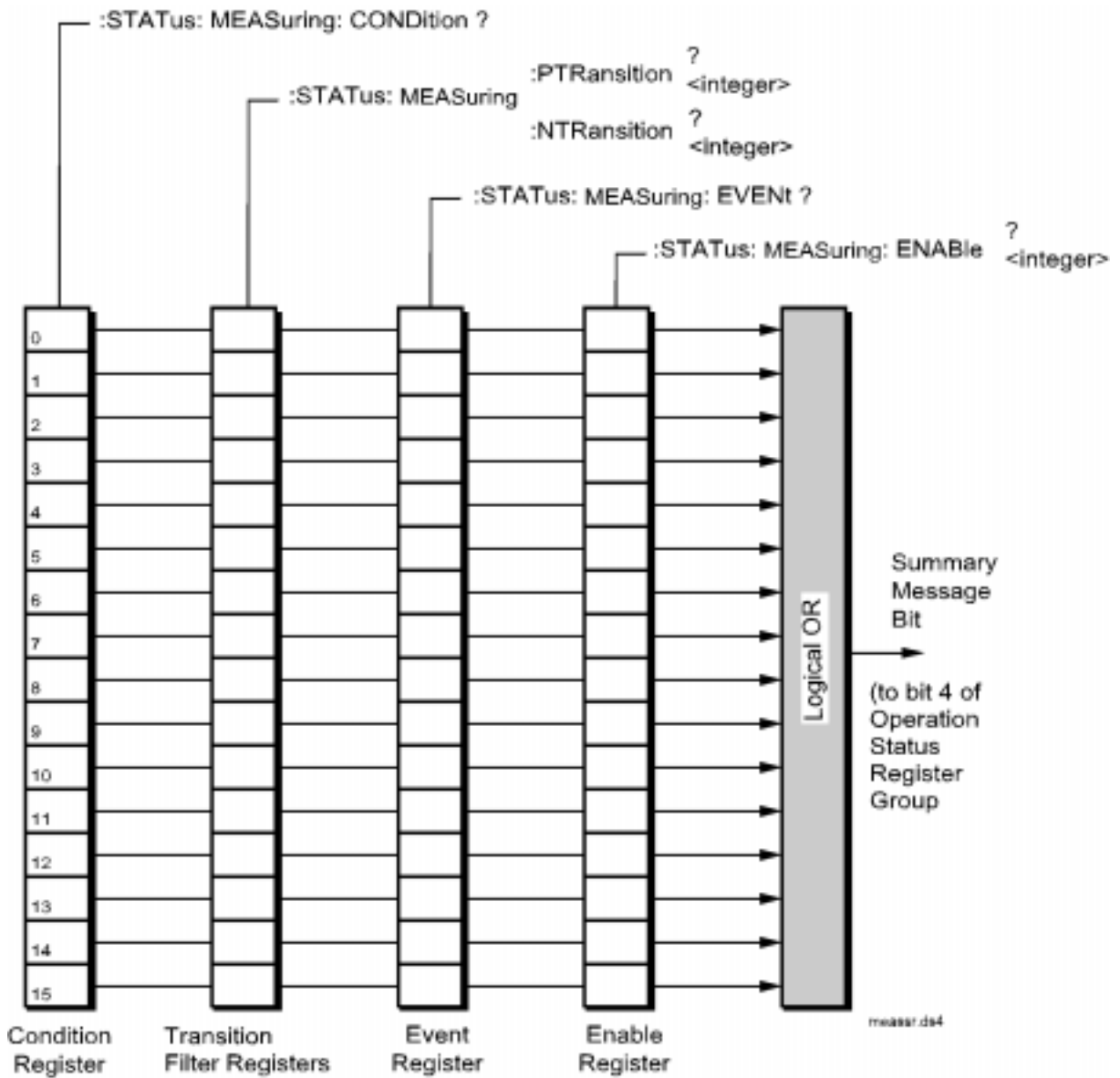

Figure 22 Measuring Status Register Group

## Status Reporting

**Table 14** Measuring Status Register Group Bit Assignments

| <b>Bit Number</b> | <b>Is Condition Register Implemented?</b> | <b>Condition/Event</b> | <b>Comment</b> |
|-------------------|---|------------------------|----------------|
| 15                |   | Unused in the Test Set |                |
| 14                |   | Unused in the Test Set |                |
| 13                |   | Unused in the Test Set |                |
| 12                |   | Unused in the Test Set |                |
| 11                |   | Unused in the Test Set |                |
| 10                |   | Unused in the Test Set |                |
| 9                 |   | Unused in the Test Set |                |
| 8                 |   | Unused in the Test Set |                |
| 7                 |   | Unused in the Test Set |                |
| 6                 |   | Unused in the Test Set |                |
| 5                 |   | Unused in the Test Set |                |
| 4                 |   | Unused in the Test Set |                |
| 3                 |   | Unused in the Test Set |                |
| 2                 |   | Unused in the Test Set |                |
| 1                 |   | Unused in the Test Set |                |
| 0                 | YES                                       | CDMA FER Test Running  |                |

## Status Reporting

### Accessing the Measuring Status Register Group Registers

The following sections show the syntax and give programming examples, using the HP BASIC programming language, for the STATus commands used to access the Measuring Status Register Group registers.

#### Reading the Condition Register

##### Syntax

```
STATus:MEASuring:CONDition?
```

##### Example

```
OUTPUT 714;"STAT:MEAS:COND?"  
ENTER 714;Register_value
```

#### Reading the Transition Filters

##### Syntax

```
STATus:MEASuring:PTRansition?  
STATus:MEASuring:NTRansition?
```

##### Example

```
OUTPUT 714;"STAT:MEAS:PTR?"  
ENTER 714;Register_value
```

#### Writing the Transition Filters

##### Syntax

```
STATus:MEASuring:PTRansition <integer>  
STATus:MEASuring:NTRansition <integer>
```

##### Example

```
OUTPUT 714;"STAT:MEAS:PTR 256"
```

**Reading the Event Register Syntax**

```
STATus:MEASuring:EVENT?
```

**Example**

```
OUTPUT 714;"STAT:MEAS:EVENT?"
ENTER 714;Register_value
```

**Clearing the Event Register**

The EVENT register is cleared whenever it is queried or whenever the Common Command \*CLS is sent to the Test Set.

**Reading the Enable Register****Syntax**

```
STATus:MEASuring:ENABle?
```

**Example**

```
OUTPUT 714;"STAT:MEAS:ENAB?"
ENTER 714;Register_value
```

**Writing the Enable Register****Syntax**

```
STATus:MEASuring:ENABle <integer>
```

**Example**

```
OUTPUT 714;"STAT:MEAS:ENAB 256"
```

**Clearing the Enable Register**

The ENABLE register is cleared by writing to it with an integer value of zero.

## Operation Status Register Group

The Operation Status Register Group contains information about the state of the measurement systems in the Test Set, and summary message bits (SMB's) for the CDMA and Measuring Status Register Groups

The Status Byte Register summary message associated with the Operation Status Register Group is bit seven.

**Figure 23** shows the structure and STATUS commands for the Operation Status Register Group.

**Table 14** shows the Operation Status Register Group bit assignments.

Status Reporting

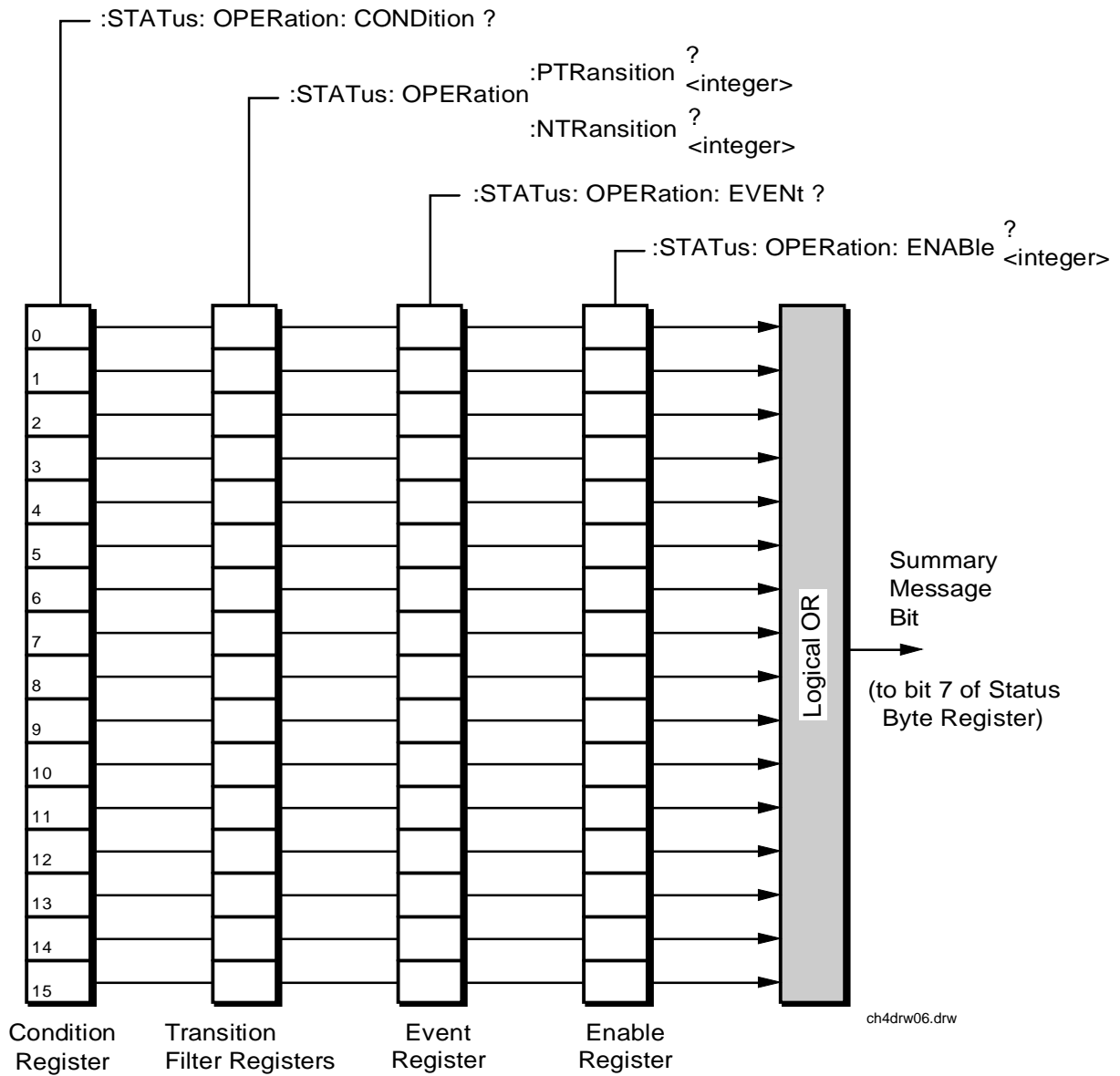

**Figure 23** Operation Status Register Group

## Status Reporting

**Table 15**      **Operation Status Register Group Bit Assignments**

| <b>Bit Number</b> | <b>Is Condition Register Implemented?</b> | <b>Condition/Event</b>                    | <b>Comment</b>  |
|-------------------|---|---|---|
| 15                |   | Not Used (Always 0)                       | Defined by SCPI Version 1994.0  |
| 14                | YES                                       | IBASIC Program Running                    | 1 = an IBASIC program is running on the built-in IBASIC controller  |
| 13                |   | Unused in the Test Set                    |   |
| 12                |   | Unused in the Test Set                    |   |
| 11                |   | Unused in the Test Set                    |   |
| 10                | YES                                       | CDMA_2 Status Register SMB                |   |
| 9                 | YES                                       | Call Processing Status Register Group SMB | 1 = one or more of the enabled events have occurred since the last reading or clearing of the Event Register. |
| 8                 | YES                                       | CDMA Status Register SMB                  |   |
| 7                 |   | Unused in the Test Set                    |   |
| 6                 |   | Unused in the Test Set                    |   |
| 5                 |   | Unused in the Test Set                    |   |
| 4                 | YES                                       | Measuring Status Register SMB             |   |
| 3                 |   | Unused in the Test Set                    |   |
| 2                 | NO  | Ranging error                             |   |
| 1                 |   | Unused in the Test Set                    |   |
| 0                 | YES                                       | Calibrating Status Register Group SMB     |   |

**Accessing the Operation Status Register Group Registers**

The following sections show the syntax and give programming examples, using the HP BASIC programming language, for the STATus commands used to access the Operation Status Register Group registers.

**Reading the Condition Register****Syntax**

```
STATus:OPERation:CONDition?
```

**Example**

```
OUTPUT 714;"STAT:OPER:COND?"
ENTER 714;Register_value
```

**Reading the Transition Filters****Syntax**

```
STATus:OPERation:PTRansition?
STATus:OPERation:NTRansition?
```

**Example**

```
OUTPUT 714;"STAT:OPER:PTR?"
ENTER 714;Register_value
```

**Writing the Transition Filters****Syntax**

```
STATus:OPERation:PTRansition <integer>
STATus:OPERation:NTRansition <integer>
```

**Example**

```
OUTPUT 714;"STAT:OPER:PTR 256"
```



## Status Reporting

### Reading the Event Register

#### Syntax

```
STATus:OPERation:EVENT?
```

#### Example

```
OUTPUT 714;"STAT:OPER:EVENT?"  
ENTER 714;Register_value
```

### Clearing the Event Register

The EVENT register is cleared whenever it is queried or whenever the Common Command \*CLS is sent to the Test Set.

### Reading the Enable Register

#### Syntax

```
STATus:OPERation:ENABle?
```

#### Example

```
OUTPUT 714;"STAT:OPER:ENAB?"  
ENTER 714;Register_value
```

### Writing the Enable Register

#### Syntax

```
STATus:OPERation:ENABle <integer>
```

#### Example

```
OUTPUT 714;"STAT:OPER:ENAB 256"
```

### Clearing the Enable Register

The ENABLE register is cleared by writing to it with an integer value of zero.

### Output Queue Group

The Output Queue Group is a specific implementation of the status queue model described in "Status Queue Model" on page 111. When a command is sent to the Test Set that causes the Test Set to generate data, this data is buffered in the Output Queue until it is read by the controller or the Output Queue Group is cleared. The Output Queue Group includes a FIFO queue and a Message Available (MAV) Summary Message.

Figure 24 shows the structure of the Output Queue Group.

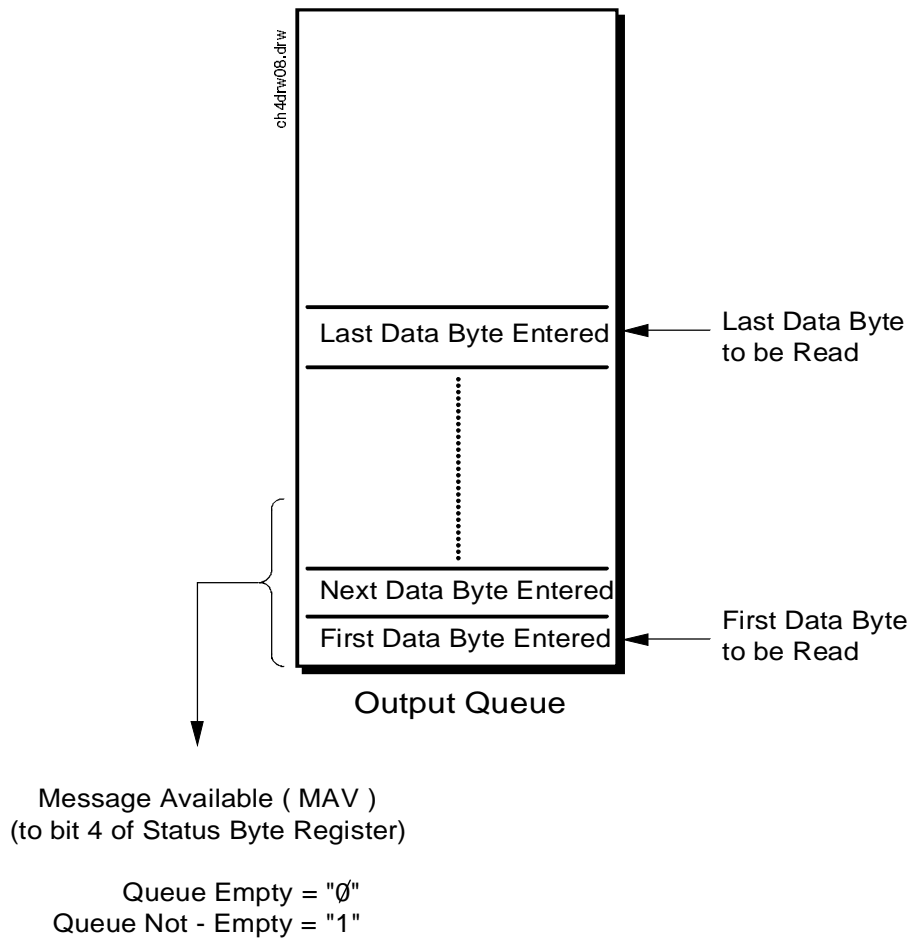

Figure 24      Output Queue Group

## Status Reporting

### Accessing the Output Queue

The availability of data from the Test Set is summarized in the MAV bit of the Status Byte Register. The MAV message is TRUE, logic 1, when there is data in the Output Queue and FALSE, logic 0, when it is empty. The Output Queue is read by sending a command, such as the HP Basic command ENTER, and waiting (if necessary) for data to become available. After data is read, subsequent bus messages will be processed.

### Reading the Output Queue

#### Example

```
Enter 714;Output_data
```

## Questionable Data/Signal Register Group

The Questionable Data/Signal Register Group contains information about the quality of the Test Set's output and measurement data, and the SMB from the Calibration Status Register Group.

The Status Byte Register summary message associated with the Questionable Data/Signal Register Group is bit three.

**Figure 25** shows the structure and STATUS commands for the Questionable Data/Signal Register Group.

**Table 16** shows the Questionable Data/Signal Register Group Condition Register bit assignments.

Status Reporting

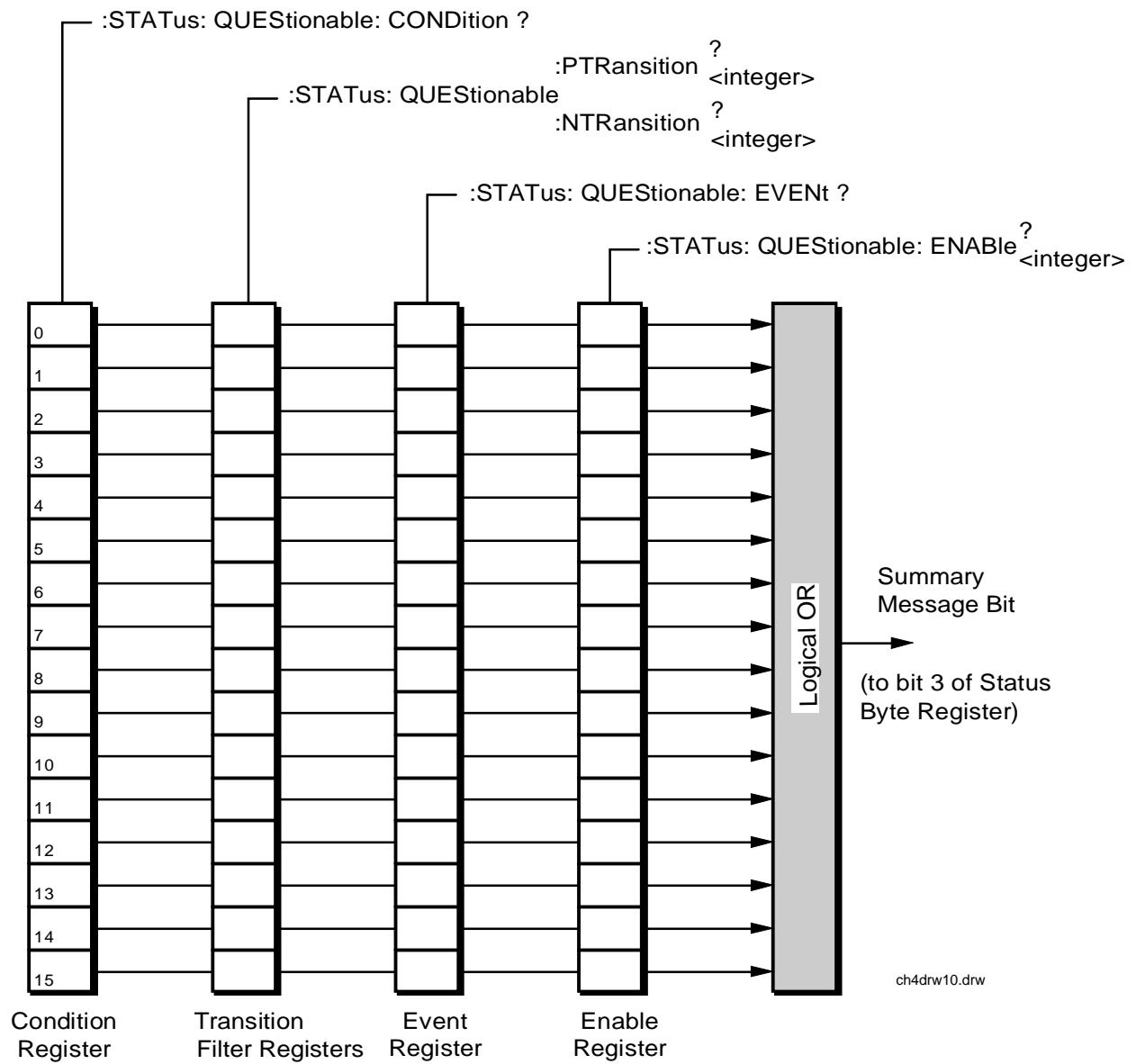

**Figure 25** Questionable Data/Signal Register Group

## Status Reporting

**Table 16**                      **Questionable Data/Signal Register Group Bit Assignments**

| <b>Bit Number</b> | <b>Is Condition Register Implemented?</b> | <b>Condition/Event</b>                     | <b>Comment</b>   |
|-------------------|---|--|--|
| 15                |   | Not Used (Always 0)                        | Defined by SCPI Version 1994.0   |
| 14                | YES                                       | Command Warning                            | 1 = A command has ignored a parameter during execution.  |
| 13                |   | Unused in Test Set                         |  |
| 12                |   | Unused in Test Set                         |  |
| 11                |   | Unused in Test Set                         |  |
| 10                |   | Unused in Test Set                         |  |
| 9                 |   | Unused in Test Set                         |  |
| 8                 | YES                                       | Calibration Register Group Summary Message | 1 = one or more of the enabled events have occurred since the last reading or clearing of the Event Register |
| 7                 |   | Unused in Test Set                         |  |
| 6                 |   | Unused in Test Set                         |  |
| 5                 |   | Unused in Test Set                         |  |
| 4                 |   | Unused in Test Set                         |  |
| 3                 |   | Unused in Test Set                         |  |
| 2                 |   | Unused in Test Set                         |  |
| 1                 |   | Unused in Test Set                         |  |
| 0                 |   | Unused in Test Set                         |  |

### Accessing the Questionable Data/Signal Register Group Registers

The following sections show the syntax and give programming examples, using the HP BASIC programming language, for the STATus commands used to access the Questionable Data/Signal Register Group registers.

#### Reading the Condition Register

##### Syntax

```
STATus:QUESTionable:CONDition?
```

##### Example

```
OUTPUT 714;"STAT:QUES:COND?"
ENTER 714;Register_value
```

#### Reading the Transition Filters

##### Syntax

```
STATus:QUESTionable:PTRansition?
STATus:QUESTionable:NTRansition?
```

##### Example

```
OUTPUT 714;"STAT:QUES:PTR?"
ENTER 714;Register_value
```

#### Writing the Transition Filters

##### Syntax

```
STATus:QUESTionable:PTRansition <integer>
STATus:QUESTionable:NTRansition <integer>
```

##### Example

```
OUTPUT 714;"STAT:QUES:PTR 256"
```

## Status Reporting

### Reading the Event Register

#### Syntax

```
STATus:QUESTionable:EVENT?
```

#### Example

```
OUTPUT 714;"STAT:QUES:EVEN?"  
ENTER 714;Register_value
```

**Clearing the Event Register** The EVENT register is cleared whenever it is queried or whenever the Common Command \*CLS is sent to the Test Set.

### Reading the Enable Register Syntax

```
STATus:QUESTionable:ENABle?
```

#### Example

```
OUTPUT 714;"STAT:QUES:ENAB?"  
ENTER 714;Register_value
```

### Writing the Enable Register

#### Syntax

```
STATus:QUESTionable:ENABle <integer>
```

#### Example

```
OUTPUT 714;"STAT:QUES:ENAB 256"
```

### Clearing the Enable Register

The ENABLE register is cleared by writing to it with an integer value of zero.

### Serial 1 Status Register Group

The Serial 1 Status Register Group contains information about SBRC (Serial Bus Receiver Chip) communication errors which occur either at power up or when an GPIB \*TST? command is issued.

The Status Byte Register summary message associated with the Serial 1 Status Register Group is bit zero. The Serial 1 Status Register Group SMB in the Communication Status Register Group and the Communication Status Register Group SMB in the Hardware 1 Status Register Group must be enabled before any of the following events or conditions can be reported through the Status Byte Register.

**Figure 26 on page 186** shows the structure and STATus commands for the Serial 1 Status Register Group.

**Table 14** shows the Serial 1 Status Register Group Condition Register bit assignments.



Status Reporting

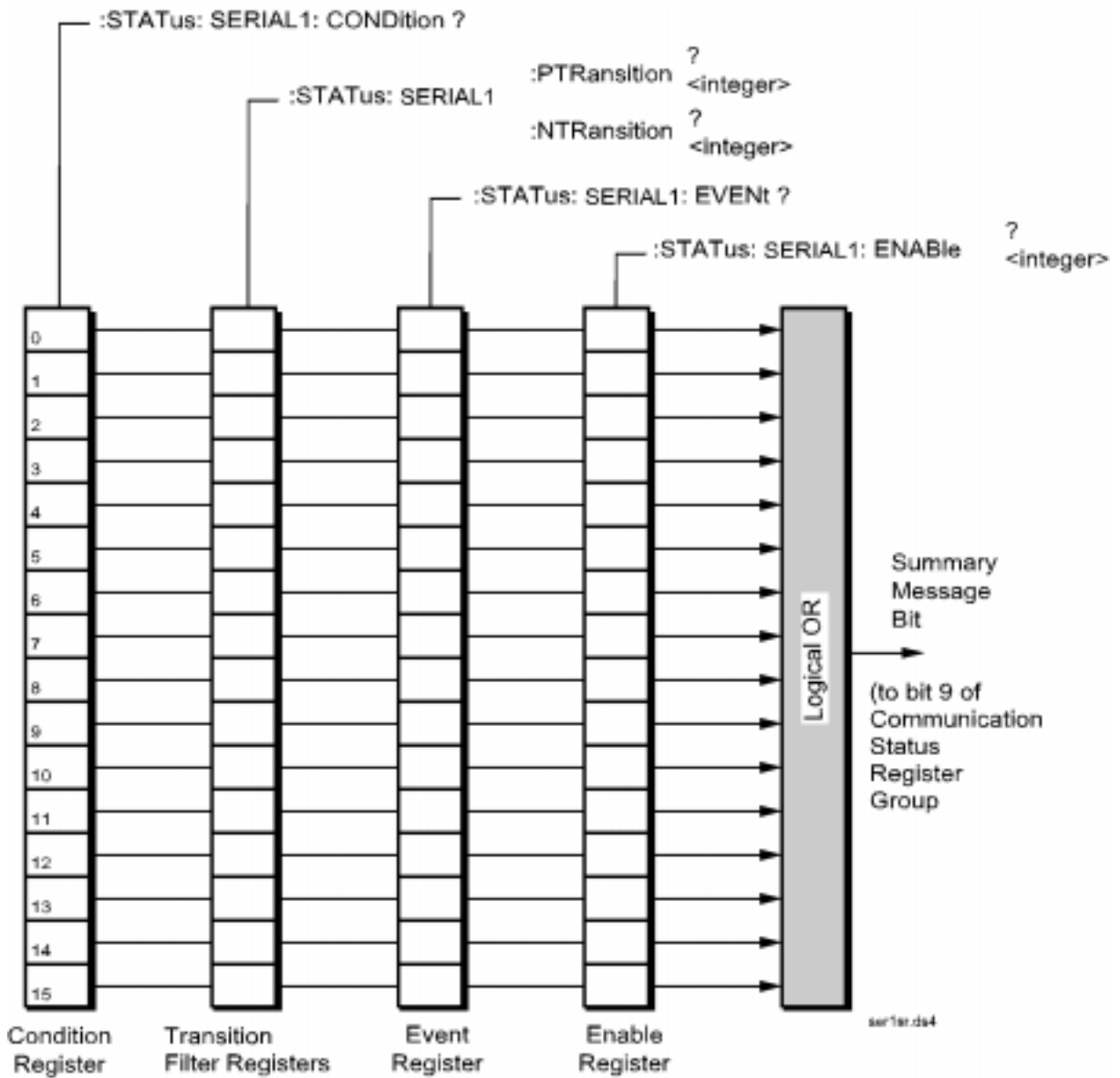

Figure 26 Serial 1 Status Register Group

**Table 17** Serial 1 Status Register Group Bit Assignments

| Bit Number | Is Condition Register Implemented? | Condition/Event                                 | Comment |
|------------|------------------------------------|---|---------|
| 15         |                                    | Unused in the Test Set                          |         |
| 14         |                                    | Unused in the Test Set                          |         |
| 13         |                                    | Unused in the Test Set                          |         |
| 12         |                                    | Unused in the Test Set                          |         |
| 11         |                                    | Unused in the Test Set                          |         |
| 10         |                                    | Unused in the Test Set                          |         |
| 9          |                                    | RESERVED  |         |
| 8          | NO                                 | LO/IF Demod Board SBRC Communication Error      |         |
| 7          | NO                                 | CDMA Reference Board SBRC Communication Error   |         |
| 6          | NO                                 | Mod Distribution Board SBRC Communication Error |         |
| 5          | NO                                 | Audio 2 SBRC Communication Error                |         |
| 4          | NO                                 | Audio1 SBRC Communication Error                 |         |
| 3          | NO                                 | Receiver Board SBRC Communication Error         |         |
| 2          | NO                                 | Spectrum Analyzer SBRC Communication Error      |         |
| 1          | NO                                 | Receiver Synthesizer SBRC Communication Error   |         |
| 0          | NO                                 | Host Interface Board SBRC Communication Error   |         |

## Status Reporting

### Accessing the Serial 1 Status Register Group Registers

The following sections show the syntax and give programming examples, using the HP BASIC programming language, for the STATus commands used to access the Serial 1 Status Register Group registers.

#### Reading the Condition Register

##### Syntax

```
STATus:SER1:CONDition?
```

##### Example

```
OUTPUT 714;"STAT:OPER:COND?"  
ENTER 714;Register_value
```

#### Reading the Transition Filters

##### Syntax

```
STATus:SER1:PTRansition?  
STATus:SER1:NTRansition?
```

##### Example

```
OUTPUT 714;"STAT:OPER:PTR?"  
ENTER 714;Register_value
```

#### Writing the Transition Filters

##### Syntax

```
STATus:SER1:PTRansition <integer>  
STATus:SER1:NTRansition <integer>
```

##### Example

```
OUTPUT 714;"STAT:OPER:PTR 256"
```

### Reading the Event Register

#### Syntax

```
STATus:SER1:EVENT?
```

#### Example

```
OUTPUT 714;"STAT:OPER:EVENT?"  
ENTER 714;Register_value
```

### Clearing the Event Register

The EVENT register is cleared whenever it is queried or whenever the Common Command \*CLS is sent to the Test Set.

### Reading the Enable Register

#### Syntax

```
STATus:SER1:ENABle?
```

#### Example

```
OUTPUT 714;"STAT:OPER:ENAB?"  
ENTER 714;Register_value
```

### Writing the Enable Register

#### Syntax

```
STATus:SER1:ENABle <integer>
```

#### Example

```
OUTPUT 714;"STAT:OPER:ENAB 256"
```

### Clearing the Enable Register

The ENABLE register is cleared by writing to it with an integer value of zero.

## Serial 2 Status Register Group

The Serial 2 Status Register Group contains information about SBRC (Serial Bus Receiver Chip) communication errors which occur either at power up or when an GPIB \*TST? command is issued.

The Status Byte Register summary message associated with the Serial 2 Status Register Group is bit zero. The Serial 2 Status Register Group SMB in the Communication Status Register Group and the Communication Status Register Group SMB in the Hardware 1 Status Register Group must be enabled before any of the following events or conditions can be reported through the Status Byte Register.

**Figure 27 on page 191** shows the structure and STATus commands for the Serial 2 Status Register Group.

**Table 14** shows the Serial 2 Status Register Group Condition Register bit assignments.

Status Reporting

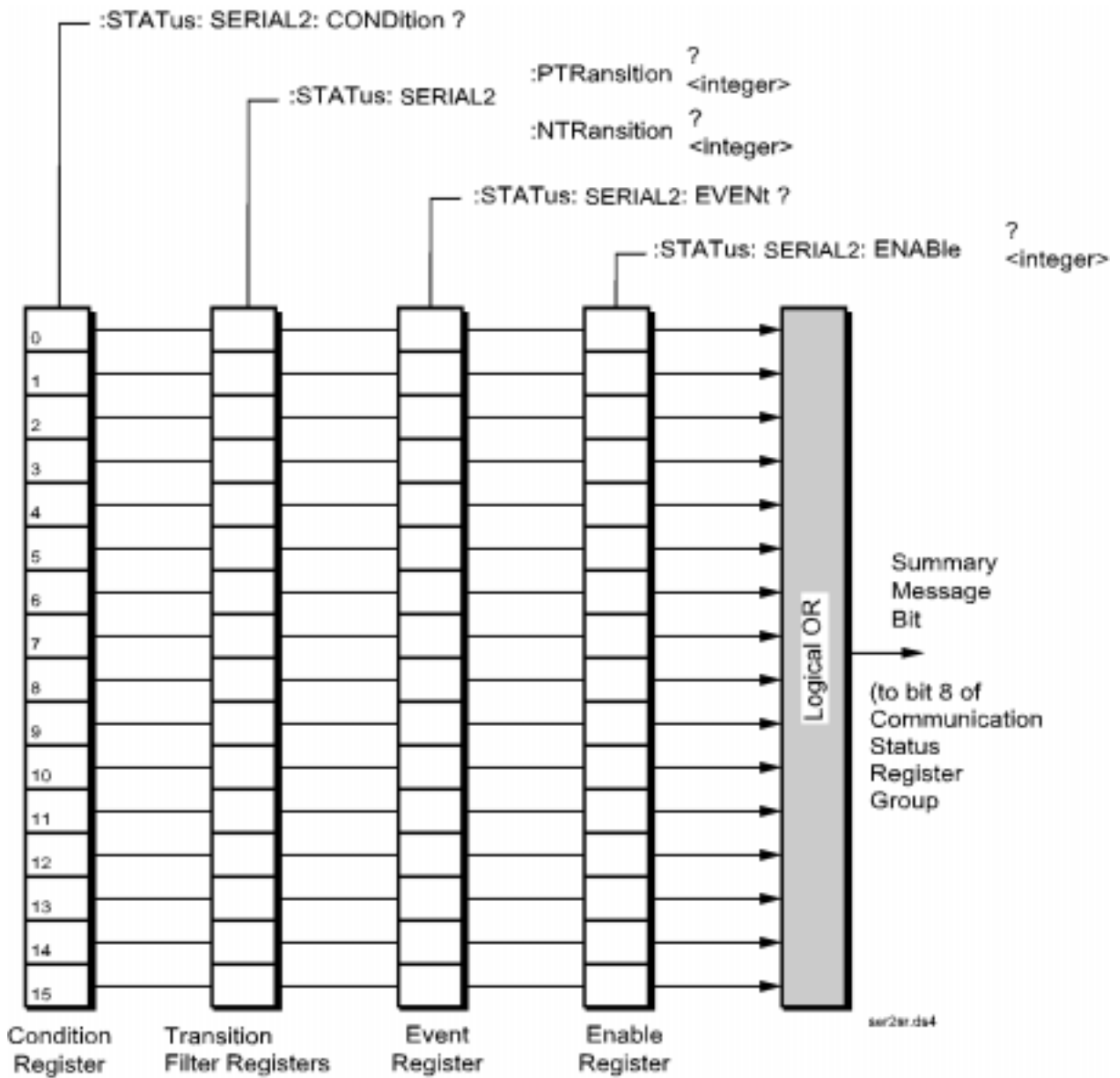

Figure 27 Serial 2 Status Register Group

## Status Reporting

**Table 18** Serial 2 Status Register Group Bit Assignments

| <b>Bit Number</b> | <b>Is Condition Register Implemented?</b> | <b>Condition/Event</b>                          | <b>Comment</b> |
|-------------------|---|---|----------------|
| 15                |   | Unused in the Test Set                          |                |
| 14                |   | Unused in the Test Set                          |                |
| 13                |   | Unused in the Test Set                          |                |
| 12                |   | Unused in the Test Set                          |                |
| 11                |   | Unused in the Test Set                          |                |
| 10                |   | Unused in the Test Set                          |                |
| 9                 |   | Unused in the Test Set                          |                |
| 8                 |   | Reserved  |                |
| 7                 |   | Reserved  |                |
| 6                 | NO  | Cell Site Analog Board SBRC Communication Error |                |
| 5                 | NO  | I/Q Modulator Board SBRC Communication Error    |                |
| 4                 | NO  | RF Input Board second SBRC Communication Error  |                |
| 3                 | NO  | RF Input Board first SBRC Communication Error   |                |
| 2                 | NO  | Output Board SBRC Communication Error           |                |
| 1                 | NO  | Source Synthesizer SBRC Communication Error     |                |
| 0                 | NO  | Reference board SBRC Communication Error        |                |

### Accessing the Serial 2 Status Register Group Registers

The following sections show the syntax and give programming examples, using the HP BASIC programming language, for the STATus commands used to access the Serial 2 Status Register Group registers.

#### Reading the Condition Register

##### Syntax

```
STATus:SER2:CONDition?
```

##### Example

```
OUTPUT 714;"STAT:OPER:COND?"  
ENTER 714;Register_value
```

#### Reading the Transition Filters

##### Syntax

```
STATus:SER2:PTRansition?  
STATus:SER2:NTRansition?
```

##### Example

```
OUTPUT 714;"STAT:OPER:PTR?"  
ENTER 714;Register_value
```

#### Writing the Transition Filters

##### Syntax

```
STATus:SER2:PTRansition <integer>  
STATus:SER2:NTRansition <integer>
```

##### Example

```
OUTPUT 714;"STAT:OPER:PTR 256"
```



## Status Reporting

### Reading the Event Register

#### Syntax

```
STATus:SER2:EVENT?
```

#### Example

```
OUTPUT 714;"STAT:OPER:EVENT?"  
ENTER 714;Register_value
```

### Clearing the Event Register

The EVENT register is cleared whenever it is queried or whenever the Common Command \*CLS is sent to the Test Set.

### Reading the Enable Register

#### Syntax

```
STATus:SER2:ENABle?
```

#### Example

```
OUTPUT 714;"STAT:OPER:ENAB?"  
ENTER 714;Register_value
```

### Writing the Enable Register

#### Syntax

```
STATus:SER2:ENABle <integer>
```

#### Example

```
OUTPUT 714;"STAT:OPER:ENAB 256"
```

### Clearing the Enable Register

The ENABLE register is cleared by writing to it with an integer value of zero.

## Standard Event Status Register Group

The Standard Event Status Register Group is a specific implementation of the status register model described in the Status Register Structure Overview section. The conditions monitored by the Standard Event Status Register Group are defined by the IEEE 488.2-1987 Standard.

Figure 28 shows the structure and IEEE 488.2 Common Commands used to access the Standard Event Status Register Group.

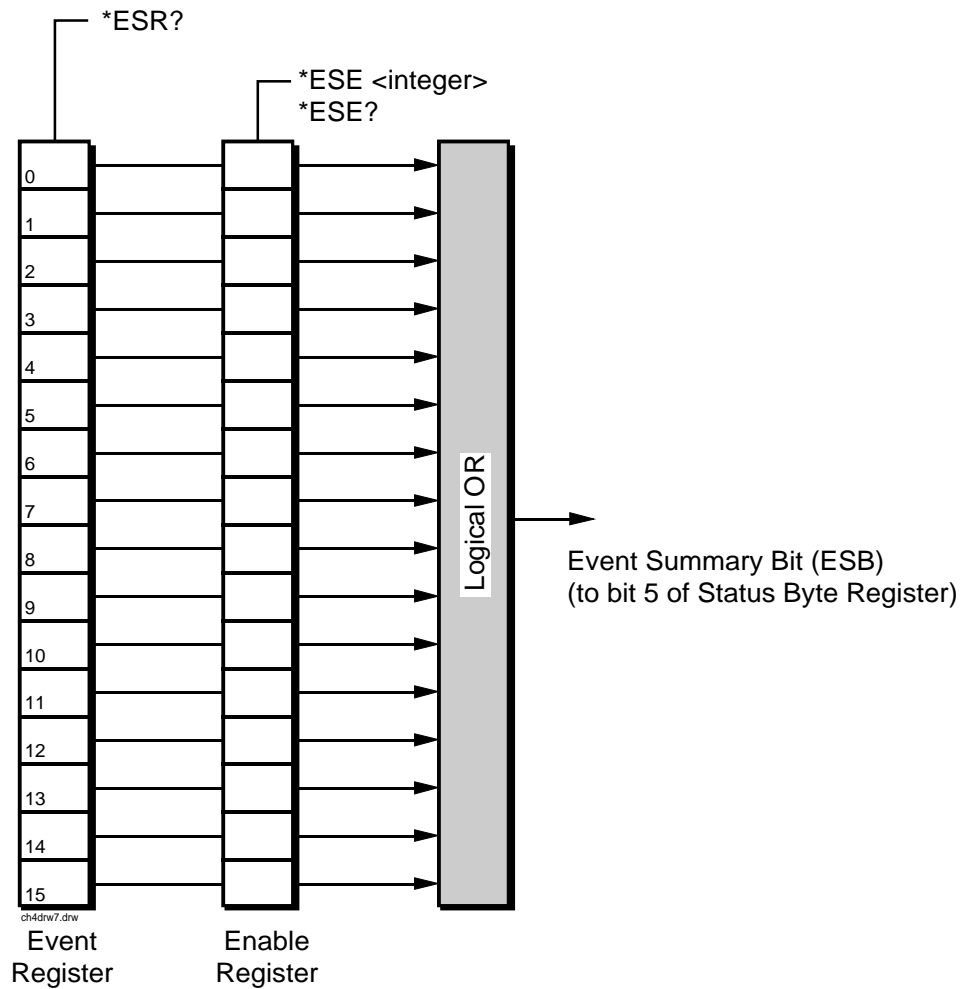

Figure 28 Standard Event Status Register Group

## Status Reporting

**Table 19** Standard Event Status Register Group Bit Assignments

| Bit Number | Event                                | Comment   |
|------------|--------------------------------------|---|
| 15         | Reserved by IEEE 488.2<br>(Always 0) |   |
| 14         | Reserved by IEEE 488.2<br>(Always 0) |   |
| 13         | Reserved by IEEE 488.2<br>(Always 0) |   |
| 12         | Reserved by IEEE 488.2<br>(Always 0) |   |
| 11         | Reserved by IEEE 488.2<br>(Always 0) |   |
| 10         | Reserved by IEEE 488.2<br>(Always 0) |   |
| 9          | Reserved by IEEE 488.2<br>(Always 0) |   |
| 8          | Reserved by IEEE 488.2<br>(Always 0) |   |
| 7          | Power On                             | 1 = Test Set's power supply has been turned off and then on since the last time this register was read.   |
| 6          | User Request                         | Not implemented in Test Set.  |
| 5          | Command Error                        | 1 = The Test Set detected an error while trying to process a command. The following events cause a command error: <ul style="list-style-type: none"> <li><b>a</b> An IEEE 488.2 syntax error. This means that the Test Set received a message that did not follow the syntax defined by the Standard.</li> <li><b>b</b> A semantic error. For example, the Test Set received an incorrectly spelled command.</li> <li><b>c</b> The Test Set received a Group Execute Trigger (GET) inside a program message.</li> </ul> |
| 4          | Execution Error                      | 1 = The Test Set detected an error while trying to execute a command. The following events cause an execution error: <ul style="list-style-type: none"> <li><b>a</b> A &lt;PROGRAM DATA&gt; element received in a command is outside the legal range for the Test Set or is inconsistent with the operation of the Test Set.</li> <li><b>b</b> The Test Set could not execute a valid command due to some Test Set hardware/firmware condition.</li> </ul>  |
| 3          | Device Dependent Error               | 1 = A Test Set dependent error has occurred. This means that some Test Set operation did not execute properly due to some internal condition, such as over range. This bit indicates that the error was not a command, query or execution error.  |

**Table 19** Standard Event Status Register Group Bit Assignments (Continued)

| <b>Bit Number</b> | <b>Event</b>       | <b>Comment</b>   |
|-------------------|--------------------|--|
| 2                 | Query Error        | <p>1 = An error has occurred while trying to read the Test Set's Output Queue. The following events cause a query error:</p> <ul style="list-style-type: none"> <li><b>a</b> An attempt is being made to read data from the Output Queue when no data is present or pending.</li> <li><b>b</b> Data in the Output Queue has been lost. An example of this would be Output Queue overflow.</li> </ul> |
| 1                 | Request Control    | 1 = The Test Set is requesting permission to become the active controller on the GPIB bus.   |
| 0                 | Operation Complete | 1 = The Test Set has completed all selected pending operations and is ready to accept new commands. This bit is only generated in response to the *OPC IEEE 488.2 Common Command.  |

## Status Reporting

### Accessing the Standard Event Status Register Group Registers

The following sections show the syntax and give programming examples, using the HP BASIC programming language, for the Common Commands used to access the Standard Event Status Register Group registers.

#### Reading the Event Register

##### Syntax

```
*ESR?
```

##### Example

```
OUTPUT 714;"*ESR?"  
ENTER 714;Register_value
```

#### Clearing the Event Register

The EVENT register is cleared whenever it is queried or whenever the \*CLS Common Command is sent to the Test Set.

#### Reading the Enable Register

##### Syntax

```
*ESE?
```

##### Example

```
OUTPUT 714;"*ESE?"  
ENTER 714;Register_value  
  
10 INTEGER Std_evn_enab_rg  
20 OUTPUT 714;"*ESE?"  
30 ENTER 714;Std_evn_enab_rg  
40 PRINT Std_evn_enab_rg  
50 END
```

#### Writing the Enable Register

##### Syntax

```
*ESE <integer>
```

##### Example

```
OUTPUT 714;"*ESE 255"
```

#### Clearing the Enable Register

The ENABLE register is cleared by writing to it with an integer value of zero.

### Status Byte/Service Request Enable Register

The Status Byte Register is an 8-bit register that summarizes the Summary Message Bits from the status register groups and the Output Queue. The Status Byte Register can be used to send a Service Request (SRQ) to the controller.

Service request enabling allows the application programmer to select which Summary Messages in the Status Byte Register may cause a service request.

The Service Request Enable Register, illustrated in **figure 29**, is an 8-bit register that enables corresponding Summary Messages in the Status Byte Register.

**Table 20** details the Status Byte Register bit assignments.

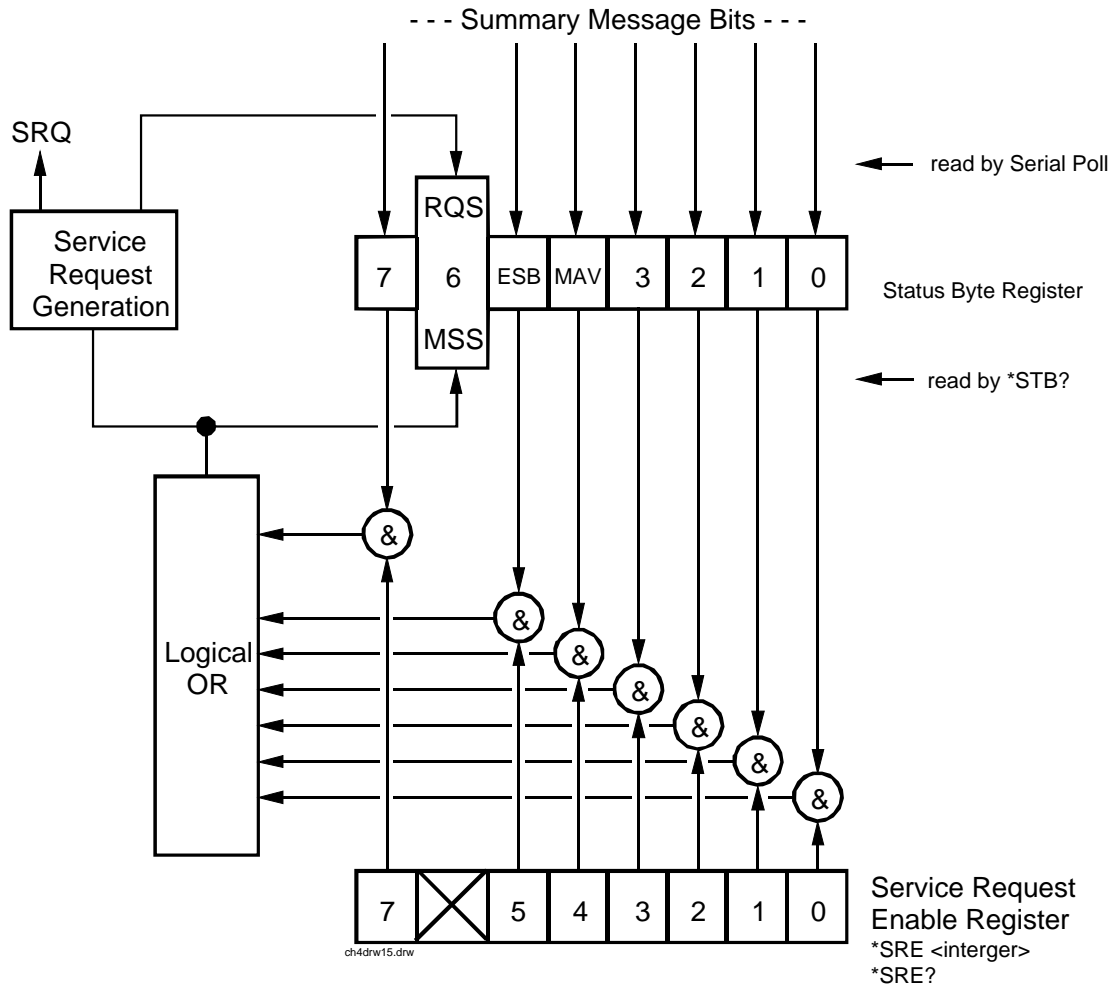

**Figure 29** Status Byte/Service Request Enable Register

## Status Reporting

**Table 20** Status Byte Register Bit Assignments

| Bit Number | Defined by | Data Structures Summarized through this Status Byte Bit  | Comments  |
|------------|------------|--|---|
| 7          | SCPI       | *Operation Status Register Group<br>*CDMA Status Register Group<br>*Measuring Status Register Group  | TRUE = One or more enabled event bits in the associated status registers is TRUE.   |
| 6          | IEEE 488.2 | None   | Request Service (RQS) when read by serial poll OR Master Summary Status message when read by *STB? command. This bit cannot be masked |
| 5          | IEEE 488.2 | *Standard Event Status Register Group  | TRUE = One or more enabled event bits in the associated status registers is TRUE.   |
| 4          | IEEE 488.2 | *Output Queue Group Message Available (MAV) Summary Message  | TRUE = One or more enabled event bits in the associated status registers is TRUE.   |
| 3          | SCPI       | *Questionable Data/Signal Register Group<br>*Calibration Status Register group   | TRUE = One or more enabled event bits in the associated status registers is TRUE.   |
| 2          |            | Unused in Test Set   |   |
| 1          | Test Set   | *Hardware #2 Status Register Group Summary Message   | TRUE = One or more enabled event bits in the associated status registers is TRUE.   |
| 0          | Test Set   | *Hardware #1 Status Register Group<br>*Communication Status Register Group<br>*Serial 1 Status Register Group<br>*Serial 2 Status Register Group | TRUE = One or more enabled event bits in the associated status registers is TRUE.   |

### Reading the Status Byte Register

**Reading with a Serial Poll.** The contents of the Status Byte Register can be read by a serial poll from the Active Controller in response to some device on the bus sending the Service Request (SRQ) message. When read with a serial poll, bit 6 in the Status Byte Register represents the Request Service (RQS) condition. Bit 6 is TRUE, logic 1, if the Test Set is sending the Service Request (SRQ) message and FALSE, logic 0, if it is not. Bits 0-5 and bit 7 are defined as shown in **table 20 on page 200**. When read by a serial poll the RQS bit is cleared (set to 0) so that the RQS message will be FALSE if the Test Set is polled again before a new reason for requesting service has occurred. Bits 0-5 and bit 7 are unaffected by a serial poll.

When read with the Serial Poll (SPOLL) command, bit 6 represents the RQS condition.

**Reading with the \*STB? Common Command.** The contents of the Status Byte Register can be read by the application program using the \*STB? Common Command. When read with the \*STB? Common Command, bit 6 represents the Master Summary Status (MSS) message. The MSS message is the inclusive OR of the bitwise combination (excluding bit 6) of the Status Byte Register and the Service Request Enable Register. For a discussion of Summary Messages, see "**Status Register Structure Overview**" on **page 106**. Bit 6 is TRUE, logic 1, if the Test Set has at least one reason for requesting service and FALSE, logic 0, if it does not. Bits 0-5 and bit 7 are defined as shown in **table 20 on page 200**. When read by the \*STB? Common Command, bits 0-5, bit 6, and bit 7 are unaffected

The \*STB? Status Byte Query allows the programmer to determine the current contents (bit pattern) of the Status Byte Register and the Master Summary Status (MSS) message as a single element. The Test Set responds to the \*STB? query by placing the binary-weighted decimal value of the Status Byte Register and the MSS message into the Output Queue. The response represents the sum of the binary-weighted values of the Status Byte Register's bits 0-5 and 7 (weights 1,2,4,8,16,32 and 128 respectively) and the MSS summary message (weight 64). Thus, the response to \*STB?, when considered as a binary value, is identical to the response to a serial poll except that the MSS message of 1 indicates that the Test Set has at least one reason for requesting service (Refer to the IEEE 488.2-1987 Standard for a complete description of the MSS message). The decimal value of the bit pattern will be a positive integer in the range of 0 to 255. The response data is obtained by reading the Output Queue into a numeric variable, integer or real.

When read with the \*STB? Common Command, bit 6 represents the Master Summary Status (MSS) message.



## Status Reporting

An example of reading the Status Byte register using \*STB? is shown below.

### Example BASIC program

```
10 INTEGER Stat_byte_reg,Stat_byte,Mstr_sum_msg
20 OUTPUT 714;"*STB?"
30 ENTER 714;Stat_byte_reg
40 Stat_byte=BINAND(Stat_byte_reg,191)
50 PRINT Stat_byte
60 Mstr_sum_msg=BINAND(Stat_byte_reg,64)
70 PRINT Mstr_sum_msg
80 END
```

### Example response

```
32
0
```

### Writing the Status Byte Register

The Status Byte Register is a read only register and is altered only when the state of the Summary Messages from the overlaying data structures are altered.

### Clearing the Status Byte Register

The \*CLS Common Command clears all Event Registers and Queues so that their corresponding Summary Messages are cleared. The Output Queue and its MAV Summary Message are an exception and are unaffected by the \*CLS Common Command.

### Reading the Service Request Enable Register

The Service Request Enable Register is read with the \*SRE? Common Command. The \*SRE? query allows the programmer to determine the current contents (bit pattern) of the Service Request Enable Register. The Test Set responds to the \*SRE? query by placing the binary-weighted decimal value of the Service Request Enable Register bit pattern into the Output Queue. The decimal value of the bit pattern will be a positive integer in the range 0 to 255. The response data is obtained by reading the Output Queue into a numeric variable, integer or real.

### Example BASIC program

```
10 INTEGER Srv_rqs_enab_rg
20 OUTPUT 714;"*SRE?"
30 ENTER 714;Srv_rqs_enab_rg
40 PRINT Srv_rqs_enab_rg
50 END
```

### Example response

```
18
```

**Writing the Service Request Enable Register**

The Service Request Enable Register is written with the \*SRE Common Command. The \*SRE command sets the bit pattern (bits 0-5 and 7) of the Service Request Enable Register. The Service Request Enable Register allows the programmer to select which condition(s), as defined by bits 0-5 and 7 of the Status Byte Register, will generate a Service Request on the GPIB bus. The Test Set always ignores bit 6 (binary weight 64) of the bit pattern set by the \*SRE command.

The bit pattern set by the \*SRE command is determined by selecting the desired condition(s) from the Status Byte Register, setting the value of the bit position(s) to a logical one, setting the value of all non-selected bit positions to a logical zero, and sending the binary-weighted decimal equivalent of bits 0-5 and 7 after the \*SRE command. For example, if the programmer wished to have the occurrence of a message available in the Output Queue (bit position 4 in the Status Byte Register) and the occurrence of a condition in the Hardware# 2 Status Register (bit position 1 in the Status Byte Register) to generate a Service Request on the GPIB bus, the binary-weighted decimal value of the bit pattern for the Service Request Enable Register would be determined as shown in **table 21**.

## Status Reporting

**Table 21**      **Determining the Service Request Enable Register Bit Pattern**

|                         |     |    |    |     |    |    |    |   |                             |
|-------------------------|-----|----|----|-----|----|----|----|---|-----------------------------|
| <b>Bit Position</b>     | 7   | 6  | 5  | 4   | 3  | 2  | 1  | 0 |                             |
| <b>Logical Value</b>    | 0   | X  | 0  | 1   | 0  | 0  | 1  | 0 | X = ignored by the Test Set |
| <b>Binary Weighting</b> | 128 | X  | 32 | 16  | 8  | 4  | 2  | 1 | X = ignored by the Test Set |
| <b>Decimal Value</b>    | 0+  | 0+ | 0+ | 16+ | 0+ | 0+ | 2+ | 0 | = 18                        |

**Example**

```
OUTPUT 714; "*SRE 18"
```

**NOTE:**

The decimal value of the bit pattern must be a positive integer in the range of 0 to 255. Sending a negative number or a number greater than 255 causes an **GPiB Error: -222 Data out of range.**

**Clearing the Service Request Enable Register**

The Service Request Enable Register is cleared by sending the \*SRE Common Command with a decimal value of zero. Clearing the Service Request Enable Register turns off service requests.

---

## **5 Memory Cards/Mass Storage**

This chapter contains information about using the mass storage devices available in the Test Set for storing and retrieving program and data files.

---

## Default File System

The Test Set's default file system is the Microsoft®<sup>1</sup> Disk Operating System (MS-DOS®). The DOS file system is used on IBM-compatible personal computers. (See "**DOS File Naming Conventions**" on page 218 for further information on the DOS file system.) This implies that the Test Set expects a DOS formatted media for operations as shown in table 22 on page 207. If a LIF formatted media is used for the activities outlined in table 22 (with the exception of IBASIC mass storage operations), erroneous operation will result.

The IBASIC file system supports both LIF (Hewlett-Packard's Logical Interchange Format) and DOS. The media format (DOS or LIF) is determined automatically by the IBASIC file system when the mass storage device is first accessed, and the appropriate format is used from then on for IBASIC mass storage operations. File system operation defaults to DOS upon exiting from IBASIC.

---

**NOTE:**

The IBASIC INITIALIZE command defaults to LIF format. Any media (RAM Disk, SRAM Cards, External Hard Disk Drive, or 3.5-inch floppy) formatted using the default conditions of the INITIALIZE command will be the LIF format and will be unusable except for IBASIC mass storage operations. Refer to "**Initializing Media for DOS or LIF File System**" on page 221 for information on formatting media for the DOS file system.

The IBASIC WILDCARDS command defaults to WILDCARDS OFF. To use DOS wildcards while in IBASIC execute the WILDCARDS DOS command upon entering the IBASIC environment.

---

1. Microsoft® and MS-DOS ® are U.S. registered trademarks of Microsoft Corp.

## Default File System

**Table 22**      **Test Set Default File System**

| <b>Activity</b>  | <b>Default File System</b> |
|--|----------------------------|
| Manual front-panel operations<br><b>a.</b> SAVE/RECALL register access<br><b>b.</b> TESTS Subsystem file access<br><b>c.</b> Signaling Decoder NMT file access | DOS                        |
| IBASIC mass storage operations LIF is default, DOS is also supported   | LIF                        |
| GPIB commands for<br><b>a.</b> SAVE/RECALL register access<br><b>b.</b> TESTS Subsystem file access<br><b>c.</b> Signaling Decoder NMT file access             | DOS                        |
| TESTS Subsystem<br><b>a.</b> Procedure files<br><b>b.</b> Library files<br><b>c.</b> Code files  | DOS                        |

---

## Mass Storage Device Overview

As shown in **figure 30 on page 209**, the Test Set has both internal and external mass storage devices. There are five types of mass storage devices in the Test Set:

- On-board random-access memory disk (RAM disk) located on the Test Set's internal memory board
- On-board read-only memory disk (ROM disk) located on the Test Set's internal memory board
- External disk drives connected to the Test Set's external GPIB
- Internal static random access memory (SRAM) cards which are inserted into the Test Set's front-panel Memory Card slot

---

**NOTE:**

The hardware for reading-from and writing-to memory cards is located internal to the Test Set. Therefore, the static random access memory (SRAM) cards and the read only memory (ROM) cards are considered internal to the Test Set even though the physical media must be inserted into the Test Set's front-panel Memory Card slot.

---

Programs and data can be retrieved from any of these mass storage devices. Programs and data can only be stored to RAM disk, external disk, or SRAM card mass storage devices. The IBASIC file system supports both the LIF file system and the MS-DOS file system.

Mass Storage Device Overview

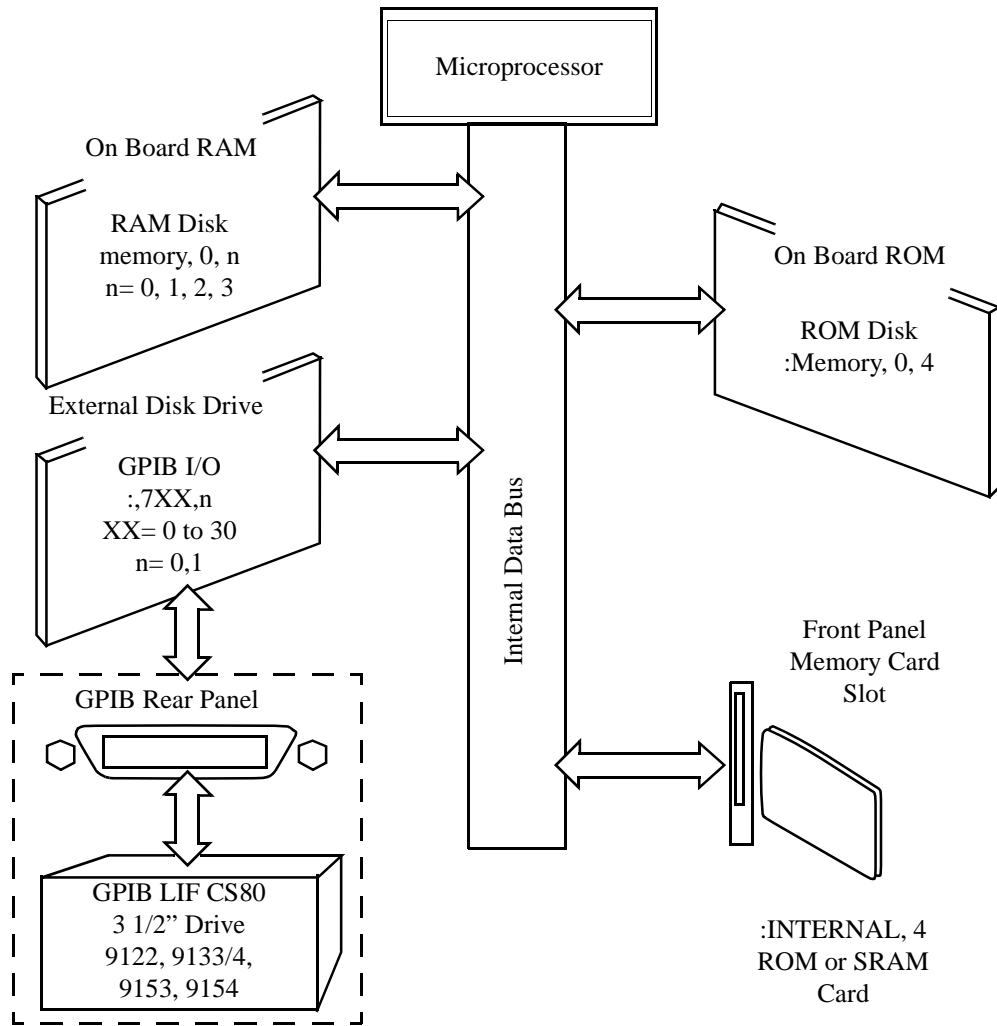

Figure 30 Internal and External Mass Storage Devices



## Mass Storage Device Overview

**Mass Storage Device Types**

The following paragraphs provide an overview of the five types of mass storage devices.

**Table 23 RAM Disk Mass Storage Overview**

| <b>Mass Storage Name</b> | <b>Mass Storage Type</b>          | <b>Physical Location</b>         | <b>Mass Storage Volume Specifier</b>                                  | <b>Media Type</b> | <b>Supported File System(s)</b> |
|--------------------------|-----------------------------------|----------------------------------|---|-------------------|---------------------------------|
| RAM Disk                 | Non-volatile random access memory | Test Set's internal memory board | ":MEMORY,0,unit number"<br>unit number = 0, 1, 2, or 3<br>default = 0 | N/A               | LIF, DOS                        |

**Typical Uses**

- Temporary program and data storage
- Temporary Save/Recall register storage

**Comments**

- Easily overwritten or erased
- Not recommended for permanent program or data storage
- Unit 0 can be overwritten by the RAM\_MANAGER utility program (ROM Disk)
- Unit 1 can be overwritten by the COPY\_PL utility program (ROM Disk)
- Units 2 and 3 are not overwritten by any ROM Disk utility program

## Mass Storage Device Overview

**Table 24 ROM Disk Mass Storage Overview**

| <b>Mass Storage Name</b> | <b>Mass Storage Type</b> | <b>Physical Location</b>       | <b>Mass Storage Volume Specifier</b> | <b>Media Type</b> | <b>Supported File System(s)</b> |
|--------------------------|--------------------------|--------------------------------|--------------------------------------|-------------------|---------------------------------|
| ROM Disk                 | Read-only memory         | Test Set internal memory board | ":MEMORY,0,4"                        | N/A               | DOS                             |

**Typical Uses**

- Permanent storage of factory supplied utility programs
- Permanent storage of factory supplied diagnostic programs

**Comments**

- Non-erasable
- Not available for user program or data storage
- Not available for Save/Recall register storage

## Mass Storage Device Overview

**Table 25 External Disk Mass Storage Overview**

| <b>Mass Storage Name</b> | <b>Mass Storage Type</b>                       | <b>Physical Location</b>              | <b>Mass Storage Volume Specifier</b>  | <b>Media Type</b>                               | <b>Supported File System(s)</b> |
|--------------------------|--|---------------------------------------|---|---|---------------------------------|
| External Disk            | GPIB Hard disk drive<br>GPIB Floppy disk drive | Connected to Test Set's external GPIB | ":,7xx,n"<br>xx = device address (0-30)<br>n = unit number (range device dependent) | Hard disk = NA<br>Floppy disk<br>3.5-in DS Disk | LIF, DOS                        |

**Typical Uses**

- Permanent program and data storage
- Permanent Save/Recall register storage

**Comments**

- High capacity (device dependent)
- Slowest access time of Test Set's mass storage devices

## Mass Storage Device Overview

**Table 26** SRAM Card Mass Storage Overview

| <b>Mass Storage Name</b> | <b>Mass Storage Type</b>         | <b>Physical Location</b>                               | <b>Mass Storage Volume Specifier</b> | <b>Media Type</b>                        | <b>Supported File System(s)</b> |
|--------------------------|----------------------------------|--|--------------------------------------|--|---------------------------------|
| SRAM Memory Card         | Static Random-Access Memory Card | Plugs into Memory Card slot on front panel of Test Set | ":INTERNAL,4"                        | PCMCIA Type 1 or Type 2 SRAM Memory Card | LIF, DOS                        |

**Typical Uses**

- Semi-permanent program and data storage
- Semi-permanent Save/Recall register storage

**Comments**

- Low capacity
- Contents retained by on-card lithium battery
- Contents lost if on-card battery removed while card not in Test Set Memory Card slot
- Recommended as primary mass storage device for program and data storage

## Mass Storage Device Overview

**Table 27 ROM Card Mass Storage Overview**

| <b>Mass Storage Name</b> | <b>Mass Storage Type</b> | <b>Physical Location</b>                               | <b>Mass Storage Volume Specifier</b> | <b>Media Type</b>                         | <b>Supported File System(s)</b> |
|--------------------------|--------------------------|--|--------------------------------------|---|---------------------------------|
| ROM or OTP Memory Card   | Read-only Memory Card    | Plugs into Memory Card slot on front panel of Test Set | ":INTERNAL,4"                        | PCMCIA Type 1 or Type 2 EPROM Memory Card | DOS                             |

**Typical Uses**

- Permanent storage of factory supplied application programs
- Permanent storage of factory supplied utility programs
- Permanent storage of factory supplied diagnostic programs

**Comments**

- Non-erasable
- Not available for user program or data storage
- Not available for Save/Recall register storage

---

## Default Mass Storage Locations

### Built-in IBASIC Controller

The default mass storage location for the built-in IBASIC Controller is the front-panel memory card slot (mass storage volume specifier ":INTERNAL,4") after any of the following conditions:

- power-up
- initializing RAM with the SERVICE screen's **RAM Initialize** function

The mass storage location for the built-in IBASIC Controller can be changed using the MASS STORAGE IS command. Refer to the *HP Instrument BASIC Users Handbook* for further information on the MASS STORAGE IS command.

### Save/Recall Registers

The default mass storage location for the Save/Recall registers is the Test Set's internal RAM (no mass storage volume specifier) after any of the following conditions:

- Power-up
- Initializing RAM with the SERVICE screen's **RAM Initialize** function
- Resetting the Test Set using the front-panel PRESET key
- Resetting the Test Set using the \*RST GPIB Common Command

The mass storage location for Save/Recall registers can be changed using the **Save/Recall** field in the I/O CONFIGURE screen. The default mass storage volume specifiers for the Save/Recall register mass storage locations are as follows:

- Internal selection - (no mass storage volume specifier, registers are saved to allocated RAM space)
- Card selection (not changeable) - ":INTERNAL,4"
- RAM selection (not changeable) - ":MEMORY,0,0"
- Disk selection - the **External Disk Specification** field in the TESTS (External Devices) screen.

## Default Mass Storage Locations

### External Disk Drive

The default mass storage volume specifier for the external disk drive is set using the **External Disk Specification** field in the TESTS (External Devices) screen.

### TESTS Subsystem

The default mass storage location for the TESTS Subsystem is set using the **Select Procedure Location:** field on the TESTS (Main Menu) screen. The default mass storage volume specifiers for the TESTS Subsystem mass storage locations are as follows:

- Card selection (not changeable) - ":INTERNAL,4"
- ROM selection (not changeable) - ":MEMORY,0,4"
- RAM selection (not changeable) - ":MEMORY,0,0"
- Disk selection - the **External Disk Specification** field in the TESTS (External Devices) screen.

### Selecting the Mass Storage Location

The IBASIC mass storage location is selected using the IBASIC Mass Storage Is command. The mass storage volume specifier for the desired mass storage location is appended to the Mass Storage Is command. Refer to the *HP Instrument BASIC User's Handbook* for further information regarding the Mass Storage Is command.

For example, to change the default mass storage location to RAM Disk unit 2, execute the following command:

```
Mass Storage Is ":MEMORY,0,2"
```

The Mass Storage Is command is keyboard and program executable; however, any changes made are lost when the Test Set is turned off or when the SERVICE screen's **RAM Initialize** function is executed.

---

## Mass Storage Access

Program and data files stored on the Test Set's various mass storage locations can be selectively accessed from the following screens:

- The TESTS (IBASIC Controller) screen.

Any type of file can be accessed from this screen, either through an IBASIC program or the IBASIC command line.

- The TESTS (Main Menu) screen using the **Select Procedure Location:** and **Select Procedure Filename:** fields.

Only *procedure* files shipped with Agilent 83217 software or procedure files created using the TESTS (Save/Delete Procedure) screen of the TESTS Subsystem can be accessed using these fields. When created, procedure file names are prefixed with a lower case *.PRC* file extension (FM\_TEST.PRC).

A corresponding *code* file - prefixed with *.PGM* (FM\_TEST.PGM) must reside on the same media for the procedure to work. Refer to the TESTS Screen chapter in the *Agilent 8924C Reference Guide* for further information.

- The TESTS (Save/Delete Procedure) screen using the **Select Procedure Location:** and **Enter Procedure Filename:** fields.

This screen is used to create "procedure" files. When created, procedure file names are prefixed with a *.PRC* file extension (FM\_TEST.PRC).

- The Signaling Decoder screen in NMT mode.

Only user-written NMT tests can be accessed from this screen. NMT test files must be saved with a *.NMT* file extension (NMT\_1.NMT).

Save/Recall register files, stored on the Test Set's various mass storage locations, can be accessed using the front-panel SAVE and RECALL keys.



---

## DOS and LIF File System Considerations

Program and data files can be stored and retrieved from IBASIC using either the DOS or LIF file system. The media format (DOS or LIF) is determined automatically by the IBASIC file system when the mass storage device is first accessed, and the appropriate format is used from then on. DOS and LIF use different file naming conventions. In addition, the Test Set uses certain file naming conventions which are unique to the Test Set. Unexpected file operation can occur if proper consideration is not given to the file naming conventions.

### File Naming Conventions

#### LIF File Naming Conventions

The LIF file system is used by Hewlett-Packard BASIC on the HP 9000 Series 200/300 Workstations. It is a flat file system, which means that it has no subdirectories. The LIF file system allows up to 10-character file names which are case sensitive. The LIF file system preserves the use of uppercase and lowercase characters for file storage and retrieval. For example, the file names File1, FILE1, file1 and FiLe1 could represent different files. LIF files cannot start with a space, and any file name longer than 10 characters is considered an error.

---

**NOTE:** The Test Set's file system does not support the HFS (hierarchical file system) used with HP BASIC. Therefore, no directory path information can be used during mass storage operations with LIF files.

---

#### DOS File Naming Conventions

The DOS file system is used on IBM compatible personal computers. The DOS file system is hierarchical, which means it supports subdirectories. The DOS file system allows up to 8-character file names with an optional extension of up to 3 characters. The file name is separated from the extension (if it exists) with a period (.). DOS file names are case independent. The characters are stored as upper case ASCII in the DOS directory but the files may be referenced without regard to case. The DOS file system always converts any lowercase characters to uppercase when files are stored. For example, the file names File1, FILE 1 , file1 and FiLe1 all represent the single DOS file FILE1 .

The period (.) may appear in the name but only to separate the file name from the extension. The period is not considered part of the file name itself. If the name portion of a DOS file name is longer than 8 characters, it is truncated to 8 characters and no error is generated. Similarly, if the extension is longer than 3 characters, it is truncated to 3 characters and no error is given.

## DOS and LIF File System Considerations

**Test Set File Naming Conventions**

The TESTS Subsystem uses the following file naming conventions:

- The *.PGM* extension is used to indicate a code file and is automatically appended onto the file name when the program code file is stored for use by the TESTS Subsystem.
- The *.PRC* extension is used to indicate a procedure file and is appended onto the file name when the file is stored by the TESTS Subsystem
- The *.LIB* extension is used to indicate a library file and is appended onto the file name when the file is created for use with the TESTS Subsystem

The Save/Recall register subsystem uses the following file naming convention:

- The *.SAV* extension is used to indicate a stored Save/Recall register file and is appended onto the file name when the file is created

The Signaling Decoder in NMT mode uses the following file naming convention:

- The *.NMT* extension is used to indicate a stored NMT file and is appended onto the file name when the file is created

**Test Set File Entry Field Width**

The TESTS Subsystem and the Save/Recall register subsystem have fields into which the operator enters a file name. These fields are used by the operator to enter the name of a file to be stored or loaded. The width of these fields is 8 characters and was chosen to support the DOS file naming convention of 8 characters. Consequently these fields will *not* hold a 10-character file name which is allowed in the LIF file system.

## Potential File Name Conflicts

Unexpected file operation can occur if proper consideration is not given to the different file system naming conventions and the file entry field width.

- A full DOS file name is 12 characters (8-character file name + . + 3 character extension).  
A full DOS file name will not fit in the Test Set's file entry field.
- On a DOS formatted disk, any file with the *.PGM* extension is considered a TESTS Subsystem code file. If the TESTS Subsystem attempts to retrieve a file which is not a code file, the following error will be generated: **Error reading code file. Check file and media.**
- On a DOS formatted disk, any file with the *.PRC* extension is considered a TESTS Subsystem procedure file. If the TESTS Subsystem attempts to retrieve a file which is not a procedure file, the following error will be generated: **Error reading procedure file. Check file and media.**
- On a DOS formatted disk, any file with the *.LIB* extension is considered a TESTS Subsystem library file. If the TESTS Subsystem attempts to retrieve a file which is not a library file, the following error will be generated: **Error reading library file. Check file and media.**
- When copying LIF named files to a DOS formatted media, the file name is silently truncated to 8 characters since DOS only allows 8-character file names. This could result in **ERROR 54 Duplicate File Name.**
- When storing or deleting files to a DOS formatted media, the file name is silently truncated to 8 characters since DOS only allows 8-character file names. This could result in **ERROR 54 Duplicate File Name.**

## File Naming Recommendations

If switching between media types (DOS and LIF) or operating exclusively in DOS the following naming conventions are recommended.

- Ensure that only TESTS Subsystem procedure files use the *.PRC* file extension.
- Ensure that only TESTS Subsystem library files use the *.LIB* file extension.
- Ensure that only TESTS Subsystem code files use the *.PGM* file extension.
- Ensure that only user-written NMT test files use the *.NMT* file extension.
- Ensure that only Save/Recall register files use the *.SAV* file extension.

## DOS and LIF File System Considerations

**Initializing Media for DOS or LIF File System**

The INITIALIZE command is used to initialize a media (external hard disk, external 3.5-inch floppy disk, Epson SRAM Card, PCMCIA SRAM Card and RAM Disk) for use with the DOS or LIF file system. The DOS or LIF file system is specified with the parameter. LIF is the default.

For example, to initialize a PCMCIA SRAM card for the DOS file system, perform the following steps:

1. Put the PCMCIA SRAM card into the Test Set's front-panel Memory Card slot.
2. Display the TESTS (IBASIC Controller) screen.
3. Using the rotary knob or an external terminal, execute the following command from the IBASIC Controller command line:

```
INITIALIZE "DOS:INTERNAL,4"
```

Refer to the *HP Instrument BASIC User's Handbook* for further information regarding the INITIALIZE command.

**Test Set File Types**

The Test Set file system supports the following file types:

- ASCII - files containing ASCII characters
- BDAT - files containing binary data
- DIR - DOS subdirectory
- DOS - SAVED code file
- IBPRG - STORED code file

## DOS and LIF File System Considerations

**Storing Code Files**

Two IBASIC commands are available for storing program code to a mass storage location: SAVE and STORE. The type of file created by the Test Set's file system when the program code is stored, is dependent upon the format of the media being used. The type of file created versus the media format is outlined in **table 28**. The IBASIC 2.0 file system can distinguish between DOS files that have been "saved" and those that were "stored."

**Table 28**                      **Sorted Program Code File Types**

|              | <b>DOS<br/>Formatted<br/>Media</b> | <b>LIF<br/>Formatted<br/>Media</b> |
|--------------|------------------------------------|------------------------------------|
| <b>SAVE</b>  | DOS                                | ASCII                              |
| <b>STORE</b> | IBPRG                              | IBPRG                              |

Files that have been stored using the SAVE command must be retrieved using the GET command:

```
SAVE "FM_TEST: ,704,1"
GET "FM_TEST: ,704,1"
```

Files that have been stored using the STORE command must be retrieved using the LOAD command:

```
STORE "FM_TEST: ,704,1"
LOAD "FM_TESTS: ,704,1"
```

---

## Using the ROM Disk

The Test Set comes with several Test Procedures stored on the internal ROM disk. These Test procedures provide instrument diagnostic utilities, periodic calibration utilities, memory management utilities, a variety of general purpose utilities, and several IBASIC demonstration programs.

To see a brief description of what each procedure does perform the following steps:

1. Display the TESTS (Main Menu) screen by selecting the front-panel TESTS key.
2. Using the rotary knob, select the **Select Procedure Location:** field and choose ROM from the choices.
3. Using the rotary knob, select the **Select Procedure Filename** field. A list of Test Procedures stored on the ROM disk is displayed in the **Choices:** field. Using the rotary knob, select the Test Procedure of interest.
4. A brief description of the Test Procedure will be displayed in the **Description** field.

ROM DISK cannot be written to for user storage.

The ROM Disk's mass storage volume specifier is ":MEMORY,0,4"

For example, to catalogue the contents of the ROM Disk from the TESTS (IBASIC Controller) screen enter:

```
CAT " :MEMORY , 0 , 4 "
```

---

## Using Memory Cards

OTP (One Time Programmable) cards provide removable read-only storage. File editing and erasure are not possible. These cards cannot be programmed by the Test Set; they require a special memory card programmer to save files.

SRAM cards provide removable read/write memory for your files, similar to a flexible disk. Data can be stored, re-stored, read, or erased as needed.

SRAM memory cards require a battery to maintain stored information.

**Table 29**                      **Memory Card Part Numbers**

| <b>Memory</b> | <b>Type</b> | <b>Part Number</b> |
|---------------|-------------|--------------------|
| 64 kilobytes  | SRAM        | Agilent 83230A     |
| 1 Mbyte       | SRAM        | Agilent 83231A     |

## Using Memory Cards

**Inserting and Removing Memory Cards**

**Figure 31** illustrates how to insert a memory card into the Test Set's front panel. To remove a memory card, simply pull it out.

Memory cards may be inserted and removed with the Test Set powered on or off.

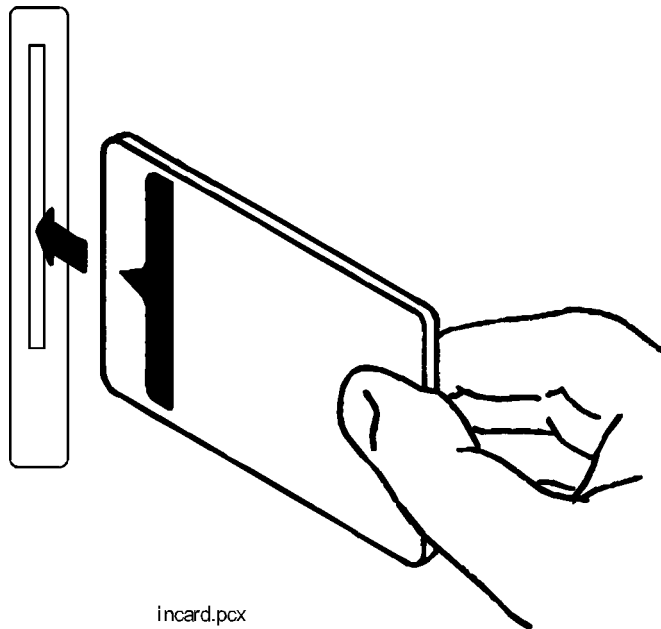

**Figure 31**      **Inserting a Memory Card**



## The Memory Card Battery

SRAM memory cards use a lithium battery to power the card. SRAM cards typically retain data for over 1 year at 25° C. To retain data, the battery should be replaced annually. The part number for the SRAM Card Battery is CR2025 or HP part number 1420-0509.

### Replacing the Battery

1. Turn the Test Set on and insert the memory card. An inserted memory card takes power from the Test Set, preventing the card's contents from being lost.
2. Hold the memory card in the slot with one hand and pull the battery holder out with your other hand. (See **figure 32** .)

---

**NOTE:** The HP SRAM cards have a Battery Holder Lock switch immediately above the Write-Protect switch. If the switch is in the locked position the battery cannot be removed. Ensure that the Battery Holder Lock switch is in the unlocked position before trying to remove the battery.

---

3. Install the battery with the side marked "+" on the same side marked "+" on the battery holder. Avoid touching the flat sides of the battery, finger oils may contaminate battery contacts in the memory-card.

4. Re-insert the battery holder into the memory card.

---

**NOTE:** The HP SRAM cards have a Battery Holder Lock switch immediately above the Write-Protect switch. Ensure that the Battery Holder Lock switch is in the locked position after installing the new battery.

---

5. Remove the memory card from the Test Set.

Using Memory Cards

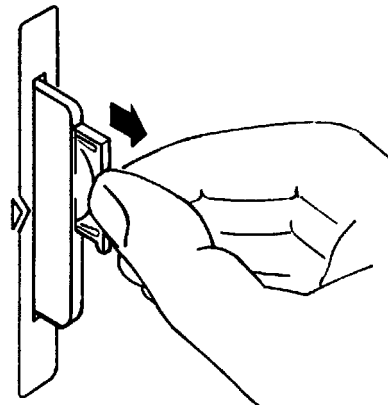
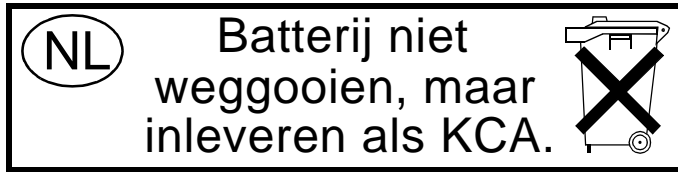

Figure 32 Replacing the Memory Card's Battery

---

**WARNING:** Do not mutilate, puncture, or dispose of batteries in fire. The batteries can burst or explode, releasing hazardous chemicals. Discard unused batteries according to the manufacturer's instructions.

---

### Setting the Write-Protect Switch

The SRAM memory card's write-protect switch lets the user secure its contents from being overwritten or erased. The switch has two positions (see **figure 33**):

- *Read-write* – The memory-card contents can be changed or erased, and new files may be written on the card.
- *Read-only* – The memory-card contents can be read by the Test Set, but cannot be changed or erased.

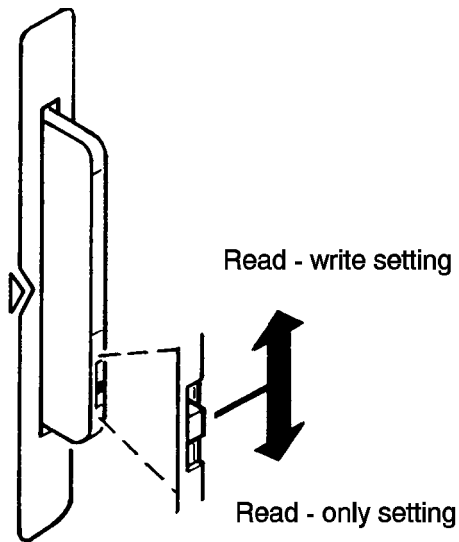

**Figure 33**      **Setting the SRAM Write-Protect Switch**

## Using Memory Cards

**Memory Card Mass Storage Volume Specifier**

The front-panel memory card slot's mass storage volume specifier is ":INTERNAL,4" and is the default mass storage device for the Test Set. For example, to catalogue the contents of a memory card from the TESTS (IBASIC Controller) screen, execute the following IBASIC command:

```
CAT " : INTERNAL , 4 "
```

or, if the mass storage location has not been changed,

```
CAT
```

If the MSI (Mass Storage Is) command has been used to change the mass storage location to a different device, the ":INTERNAL,4" designation must be used to access the memory card slot. Any changes to the mass storage location made with the MSI (Mass Storage Is) command are lost when the Test Set is turned off.

**Memory Card Initialization**

All new SRAM cards must be initialized before they can be used to store information. The RAM\_MNG procedure stored on the internal ROM Disk can be used to quickly initialize any SRAM memory card.

SRAM Memory Cards can also be initialized from the TESTS (IBASIC Controller) screen by inserting the memory card into the front-panel slot and executing the following IBASIC command:

```
INITIALIZE "<volume type>:INTERNAL,4"
```

where the <volume type> can be LIF or DOS. To verify that the memory card has been properly initialized, execute the IBASIC command:

```
CAT " : INTERNAL , 4 "
```

If the error message **ERROR 85 Medium uninitialized** appears on the screen the memory card has not been properly initialized. Check the SRAM battery to ensure that it's charged and inserted correctly in the battery holder.

---

## Backing Up Procedure and Library Files

Making a backup copy of procedure and library files helps guard against file loss due to memory card (or battery) failure.

### Using the COPY\_PL ROM Program

The COPY\_PL procedure on the internal ROM Disk will make backup copies of TESTS Subsystem's Procedure and Library files onto a second SRAM memory card, and can also initialize an uninitialized SRAM memory card. This program does not make backup copies of TESTS Subsystem's code files, or copy any type of file to OTP memory cards.

The COPY\_PL procedure is designed for use with Agilent 83217 software to make backup copies of Hewlett-Packard supplied or user-generated Procedure and Library files.

To Run COPY\_PL

1. Access the TESTS (Main Menu) screen.
2. Select the **Select Procedure Location:** field and choose **ROM**.
3. Select the **Select Procedure Filename:** field and select **IB\_UTIL**.
4. Select the **Run Test** softkey to start the procedure.
5. Follow the displayed instructions.

---

## Copying Files Using IBASIC Commands

Files can be copied from one mass storage device to another using the IBASIC COPY command. For example, to copy a file from a memory card to the left drive of an external dual-disk drive with a mass storage volume specifier of ":",702,0", execute the following IBASIC command from the TESTS (IBASIC Controller) command line:

```
COPY "FM_TEST:INTERNAL,4" TO "FM_TEST:,704,0"
```

“Stored” or “saved” files on one memory card can be copied to another memory card as follows:

- Insert the memory card containing the file to be copied.
- LOAD or GET<sup>1</sup> the desired file from the memory card into the Test Set.
- Remove the original memory card.
- Insert the destination memory card in the Test Set.
- STORE or SAVE<sup>1</sup> the file to the destination memory card.

1. See "Storing Code Files" on page 222 for information about the LOAD, GET, STORE, and SAVE commands.

## Copying an Entire Volume

An entire volume can be copied from one mass storage device to the same type of mass storage device using the volume copy form of the COPY command. The destination volume must be as large as, or larger than, the source volume. The directory and any files on the destination volume are destroyed. The directory size on the destination volume becomes the same size as the source media. Disc-to-disc copy time is dependent on the mass storage device type. The volume copy form of the COPY command was designed to copy like-media to like-media and like-file-systems to like-file-systems. For example, to copy the entire contents of one internal RAM disk to another internal RAM disk, execute the following IBASIC command from the TESTS (IBASIC Controller) command line:

```
COPY ":MEMORY,0,0" TO ":MEMORY,0,1"
```

---

### NOTE:

Using the volume copy form of the COPY command can produce unexpected results. For example, using the volume copy form to copy the contents of a 64-KB SRAM card to an external GPIB 630-KB floppy disk will result in the external floppy disk having a capacity of only 64 KB when the volume copy is finished. Furthermore all files on the floppy disk before the volume copy was executed will be lost and *are not recoverable*. Additionally, the file system type on the source media (LIF or DOS) is forced onto the destination media. Caution should be exercised when using the volume copy form of the COPY command.

---

The Test Set only supports the following types of volume copy using the volume copy form of the COPY command:

1. Like- media to like-media (RAM disk to RAM disk, external floppy to external floppy, and so forth)
2. Like-file-system to like-file-system (DOS to DOS, LIF to LIF)

All other types of volume copy are unsupported and will produce unexpected results or system errors.

---

Using wildcards in the COPY command can eliminate the need to use the volume form of the COPY command. Refer to the *HP Instrument BASIC User's Handbook* for further information on wildcards and their use in the COPY command.

---

## Using RAM Disk

RAM Disk is a section of the Test Set's internal RAM memory that has been set aside for use as a mass storage device. RAM Disk acts much the same as an external disk drive; that is, program and data files can be stored, re-stored, erased, and retrieved from the RAM Disk.

The RAM Disk is partitioned into four separate units: 0-3. Each unit is treated as a separate "disk." The size of each disk can be specified in 256-byte increments.

The four RAM Disk units are designated ":MEMORY,0,0" to ":MEMORY,0,3". For example, to catalog the contents of RAM Disk unit "0" from the TESTS (IBASIC Controller) screen, execute the following command:

```
CAT " :MEMORY , 0 , 0 "
```

Volume 0's contents can be viewed and loaded from the TESTS (IBASIC Controller) screen, the TESTS (Main Menu) screen, the TESTS (Save/Delete Procedure) screen and the Signaling Decoder screen in NMT mode. Volumes 1, 2, and 3 can *only* be accessed from the TESTS (IBASIC Controller) screen.

---

### **NOTE:**

**RAM Disk Erasure.** The contents of RAM Disk are easily lost. Unit 0 can be overwritten by the RAM\_MNG utility program (ROM Disk). Unit 1 can be overwritten by the COPY\_PL utility program (ROM Disk). The contents of all units are lost when the SERVICE screen's **RAM Initialize** function is executed. Therefore, RAM Disk should only be used for non-permanent, short-term storage of program or data files.

---



Using RAM Disk

### Initializing RAM Disks

Each RAM Disk unit must be initialized before it can be used. Unit 0 can be initialized using the RAM\_MNG procedure stored on internal ROM Disk. Volumes 1, 2, and 3 must be initialized from the TESTS (IBASIC Controller) screen.

The optional "unit size" parameter in the following procedure specifies the memory area, in 256 byte blocks, set aside for each disk unit.

Follow these steps to initialize volumes 1, 2, or 3:

1. Access the TESTS (IBASIC Controller) screen.
2. Using the rotary knob or an external terminal, enter and execute the IBASIC command:

```
INITIALIZE ":MEMORY,0,<unit number 1-3>",<unit size>
```

For example:

```
INITIALIZE ":MEMORY,0,1",50
```

---

**NOTE:**

The IBASIC INITIALIZE command defaults to LIF format. Any media (RAM Disk, SRAM Cards, External Hard Disk Drive, or 3.5-inch floppy) formatted using the default conditions of the INITIALIZE command will be the LIF format and will be unusable in the Test Set, except for IBASIC mass storage operations. Refer to "**Initializing Media for DOS or LIF File System**" on page 221 for information on formatting media for the DOS file system.

---

---

## Using External Disk Drives

The Test Set supports only GPIB external disk drives. Certain configuration information is required by the Test Set to access external disk drives.

The I/O CONFIGURE screen's GPIB **mode** field must be set to Control any time an external disk drive is used by the Test Set.

To load files from the TESTS screens or NMT Signaling Decoder screen, the disk's mass storage volume specifier must be entered in the **External Disk Specification** field on the TESTS (External Devices) screen (for example, **: ,702,1**).

### Initializing External Disks

All new external disk media must be initialized before it can be used to store information. External disk media can be initialized for either LIF (Logical Interchange Format) or DOS (Disk Operating System) format using the Test Set. (See "**DOS and LIF File System Considerations**" on page 218.)

External disk media can be initialized from the TESTS (IBASIC Controller) screen by inserting the new media into the external disk drive and executing the following IBASIC command:

```
INITIALIZE "<volume type>:<external disk mass storage volume specifier>"
```

where the <volume type> can be LIF or DOS

For example:

```
INITIALIZE "DOS: ,702,1" ) .
```

To verify that disk media has been properly initialized, execute the IBASIC command:

```
CAT "<external disk mass storage volume specifier>"
```

For example:

```
CAT " : ,702,1 "
```

---

#### **NOTE:**

The IBASIC INITIALIZE command defaults to LIF format. Any media (RAM Disk, SRAM Cards, External Hard Disk Drive or 3.5-inch floppy) formatted using the default conditions of the INITIALIZE command will be the LIF format and will be unusable in the Test Set, except for IBASIC mass storage operations. Refer to "**Initializing Media for DOS or LIF File System**" on page 221 for information on formatting media for the DOS file system.

---

Using External Disk Drives

---

## **6 IBASIC Controller**

---

## Introduction

The Test Set contains an instrument controller that can run programs to control the various instruments in the Test Set and instruments/devices connected to the Test Set's external I/O ports (GPIB, serial and parallel).

The instrument controller runs a subset of the Hewlett-Packard Rocky Mountain BASIC programming language called Instrument BASIC or IBASIC. Using this programming language it is possible to develop programs which use the Test Set's instruments to automatically test a variety of radios. Software is available from Hewlett-Packard, the Agilent 83217 series, for testing the major radio systems currently in use today. Users can also develop their own IBASIC programs for automated radio testing.

This chapter is designed to provide the programmer with the information needed to develop IBASIC programs for use on the built-in IBASIC controller. Refer to the individual Agilent 83217 software manuals for information on using the IBASIC controller with Agilent Technologies supplied software.

---

## The IBASIC Controller Screen

The Test Set has a dedicated screen for interfacing with the built-in IBASIC controller. This is the TESTS (IBASIC Controller) screen as shown in **figure 34** . This screen is accessed as follows:

- Select the front panel TESTS key. The TESTS (Main Menu) screen will be displayed.
- Using the rotary knob, position the cursor on the **IBASIC** field in the lower center of the screen.
- Push the rotary knob and the TESTS (IBASIC Controller) screen will be displayed.

## The IBASIC Controller Screen

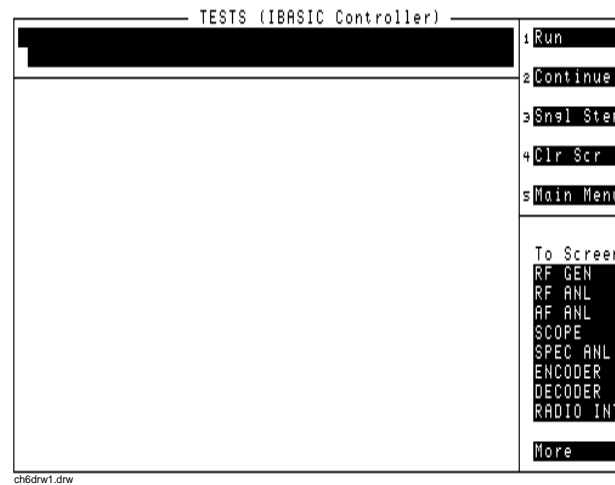

**Figure 34**      **The IBASIC Screen**

The TESTS (IBASIC Controller) screen can be accessed programmatically by sending the following command:

```
OUTPUT 714;"DISP TIBasic"
```

The TESTS (IBASIC Controller) screen is divided into several areas which are used by the IBASIC controller for different purposes.

The small horizontal rectangle at the top left is the IBASIC command line. As the name implies IBASIC commands can be executed from this line. Commands can be entered locally using the rotary knob or remotely using serial port 9. A maximum of 100 characters may be entered into the command line.

The vertical rectangle at the top right side is the softkey label area. The five highlighted areas within the softkey label area correspond to the five special function keys on the front panel of the Test Set. IBASIC programs can assign tables to these keys and control program execution by using ON KEY interrupts.

The vertical rectangle at the bottom right side is the **To Screen** area and is the same as the **To Screen** area displayed on any other Test Set screen. The user may switch to some other Test Set screen by using the rotary knob to position the cursor onto the desired screen and then pushing the knob.

The large rectangle in the center of the screen is the CRT (display screen) for the IBASIC controller. The IBASIC controller uses this area for, displaying alpha, numeric, and graphic information, program editing, program listing and so forth. This area operates as would the CRT on an external Hewlett-Packard 9000 Series 200/300 Workstation.

## Important Notes for Program Development

The Test Set is designed to operate the same way under automatic control as it does under manual control. This has several implications when designing and writing programs for the Test Set:

- To automate a particular task, determine how to do the task manually and then duplicate the steps in the program.
- In Manual Control mode, a Test Set function must be displayed and “active” to make a measurement or receive DUT data. Therefore, to make a measurement using an IBASIC program, follow these basic steps:
  1. Use the DISPlay command to select the screen for the instrument whose front panel contains the desired measurement result or data field (such as AF ANALYZER).
  2. Set the measurement field (such as SINAD) to the ON state.
  3. Trigger a reading.
  4. Read the result.

---

**NOTE:** The following sections discuss developing IBASIC programs which do not use the TESTS Subsystem. Programs written for the TESTS Subsystem require the creation of supporting Library, Procedure, and Code files, and must be written using a specific program structure. The Agilent 83217A Software packages are examples of this type of program.

---



---

## Program Development

There are three recommended approaches for developing IBASIC programs. They are outlined in **figure 35** and discussed in more detail later in this chapter. Since the Test Set only has the rotary knob and numeric keypad for data/character entry, developing programs on the Test Set alone is not recommended. All three development methods employ an external computer or terminal. The choice of development method will typically be driven by available equipment and extent of development task. If the development task is large, it is strongly recommended that a BASIC language computer be used as outlined in development Method #1.

Method #2 is recommended for large program modification or smaller program development. Method #2 uses an external PC or terminal as the CRT and keyboard for the built-in IBASIC controller.

Method #3 is least preferred for program development or modification because no syntax checking occurs until the program is first run making it difficult to debug long programs. Details of each development method are given later in this chapter.

Program Development

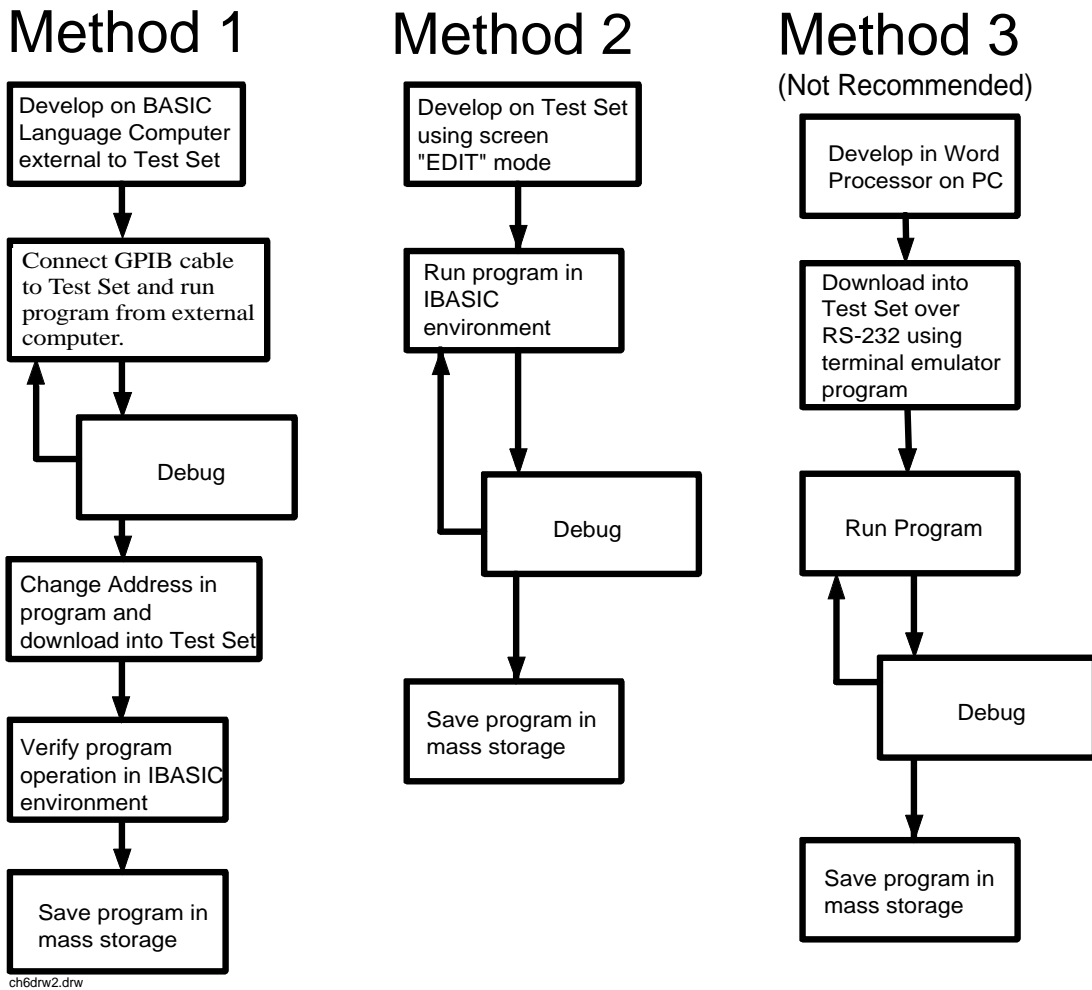

Figure 35 Program Development Methods

## Interfacing to the IBASIC Controller using Serial Ports

This section describes how to interconnect the Test Set to an external PC or terminal using the Test Set's serial I/O ports. Program development methods #2 and #3 use PC's or terminals connected to the Test Set through the Test Set's serial I/O ports. To determine which programming environment best fits your application, refer to "**Choosing Your Development Method**" on page 257.

### Test Set Serial Port Configuration

To prepare for IBASIC program development, the Test Set must first be configured to operate with a PC or terminal.

This includes,

- Hardware
- Cables
- Screens - I/O CONFIGURE and TESTS (IBASIC Controller)

There are two independently controllable serial interfaces in the Test Set, each using a 3-wire transmit / receive / ground implementation of the RS232 standard. The IBASIC Controller can send and receive data from either port by using its assigned select code.

## Interfacing to the IBASIC Controller using Serial Ports

**Serial Port Information**

The Test Set's rear-panel RJ-11 connector has 6 conductors. (Note that this jack appears the same as a common 4-conductor RJ-11 telephone jack, but the Test Set jack uses 6 conductors). Three of the wires are designated as Serial I/O Port address 9, and the other three wires are designated Serial I/O Port address 10 (also referred to as Serial Port B). These select codes cannot be changed.

**Serial Port 9.** Serial Port 9 is used for developing and editing IBASIC programs since it can be connected directly to the **IBASIC Command Line** field. It can also be used for data I/O from an IBASIC program. Settings can be changed from the I/O CONFIGURE screen, using IBASIC commands executed from the **IBASIC Command Line** field, or using IBASIC commands executed from an IBASIC program.

**Serial Port 10.** Serial Port 10 is primarily used for data I/O from an IBASIC program to a device-under-test- (DUT). Settings can be changed using IBASIC commands executed from the **IBASIC Command Line** field, or using IBASIC commands executed from an IBASIC program but not from the I/O CONFIGURE screen.

**Reason for Two Serial Ports**

A typical application uses serial port 10 to send and receive data to and from a DUT and uses serial port 9 to print or log test results to a serial printer or PC.

In the program development environment, serial port 9 can be used to communicate with the external PC or terminal, and serial port 10 can be connected to a serial printer for generating program listings or as the destination printer for the program itself. This is schematically shown in **figure 37 on page 248**. If simultaneous multiple serial I/O is not a requirement then only use serial port 9 as it can directly access the **IBASIC Command Line** field.

For your convenience, **figure 36 on page 247** and **table 30** on this page, show the cables and adapters that are available from Hewlett-Packard for connecting external devices to the Test Set's serial I/O ports. See **figure 37 on page 248** for a wiring diagram to construct your own cables. RJ-11 cables and adapters can be wired several ways. If you buy a cable or adapter other than the HP parts listed in **table 30**, verify the connections for the pins indicated, before connecting the cables to the Test Set.

## Interfacing to the IBASIC Controller using Serial Ports

**Table 30 Available HP RS232 Serial Cables and Adapters**

| <b>Device<br/>(for RS232 Serial<br/>connections)</b> | <b>Typical Uses</b>   | <b>Description</b>   | <b>HP Part<br/>Number</b> |
|--|---|--|---------------------------|
| Single to Dual RJ-11<br>Adapter Cable                | To connect to Serial<br>Ports 9 and 10<br>simultaneously                  | Single 6-pin RJ-11 (male) to Dual 6-pin<br>RJ-11 (female); 0.6-meter cable | 08921-61031               |
| Cable with Connectors                                | Test Set to PC  | 6-pin RJ-11 (male) to 9-pin DB-9 (female);<br>2-meter cable                | 08921-61038               |
| Cable with Connectors                                | Test Set to printer<br>or terminal  | 6-pin RJ-11 (male) to 25-pin DB-25<br>(male); 3-meter cable                | 08921-61039               |
| RJ-11 to DB-25 Adapter                               | Use with long cable<br>98642-66508.                                       | 6-pin RJ-11 (female) to 25-pin DB-25<br>(male) Adapter                     | 98642-66508               |
| Cable with Connectors                                | Long Cable from<br>Test Set to PC or<br>printer (use with<br>98642-66508) | 6-pin RJ-11 (male) to 6-pin RJ-11 (male);<br>15-meter cable                | 98642-66505               |

Interfacing to the IBASIC Controller using Serial Ports

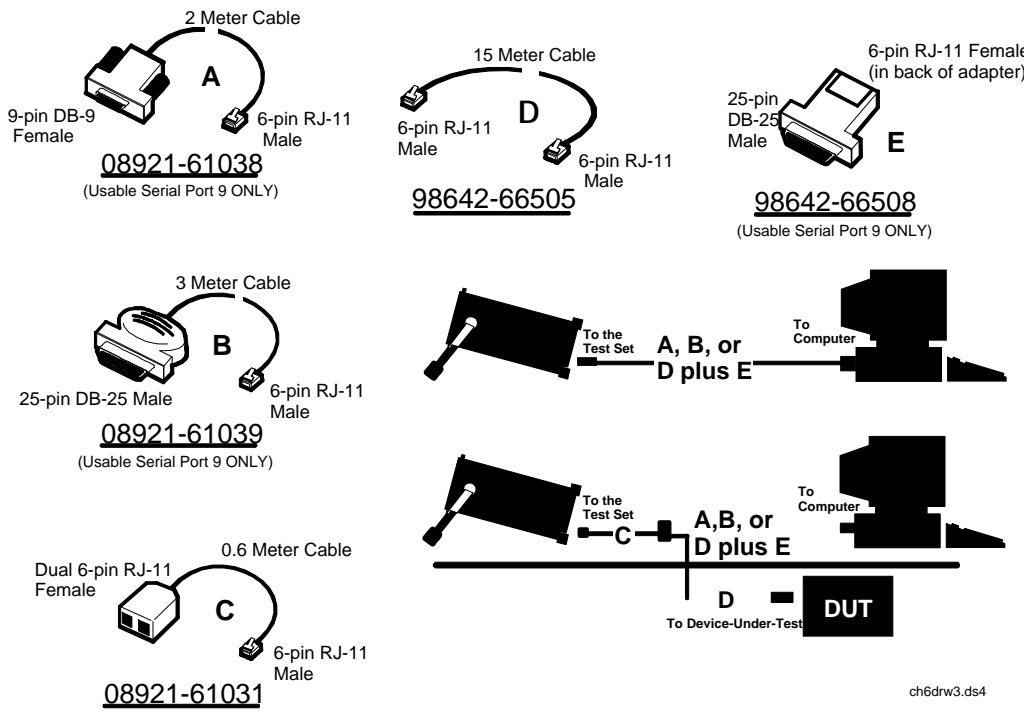

**Figure 36** Available HP RS-232 Serial Cables and Adapters

Interfacing to the IBASIC Controller using Serial Ports

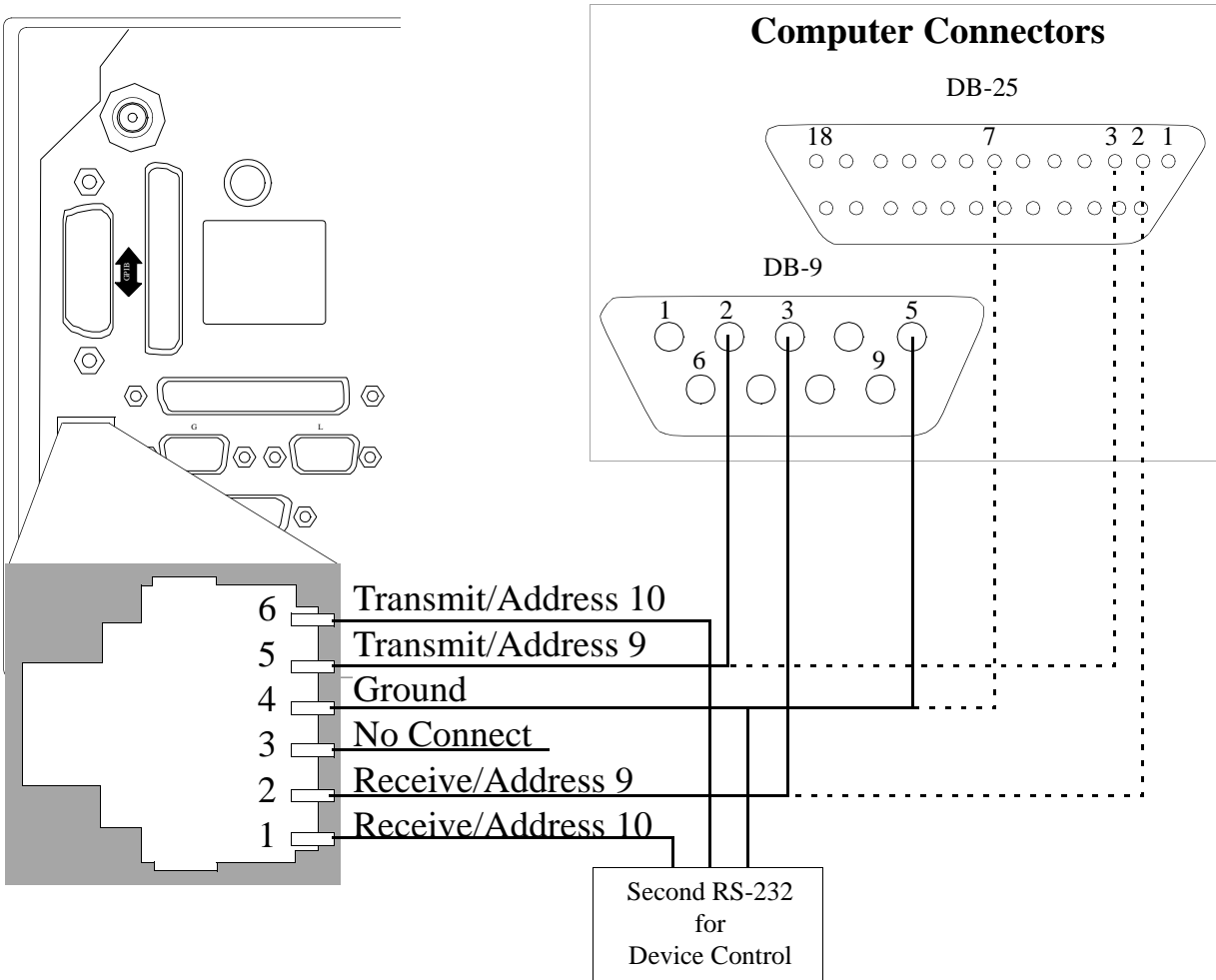

Figure 37 Connecting the Test Set Serial Port to a PC or Terminal

## Interfacing to the IBASIC Controller using Serial Ports

**Serial Port 9 Configuration**

**Table 31 on page 250** and the following paragraphs describe how to configure Serial Port 9 for communications with an external PC or terminal. Implications of the various choices are discussed.

1. Under the **To Screen** menu, select **More**, then select IO CONFIG.
2. The I/O CONFIGURE screen will be displayed.
3. Set the **Serial Baud Rate, Parity, Data Length, Stop Length, Rcv Pace** and **Xmt Pace** fields to match your PC or terminal settings. The recommended settings are shown in **table 31 on page 250**. These settings will be retained by the Test Set. They will not change if the PRESET key is pressed, if the Test Set receives a \*RST Common Command, or the power is turned on and off.
4. Set the **Serial In** field to **Inst**. This routes Serial Port 9 to the **IBASIC Command Line** field. Characters typed on the external PC or terminal will now appear in the **IBASIC Command Line**.
5. Set the **IBASIC Echo** field to **ON**. This will cause IBASIC character output from commands (such as LIST, PRINT or DISPLAY) or error messages to echo characters to Serial Port 9 (the characters will in turn show up on the external PC or terminal screen). This will allow program listings and syntax error messages to be seen on the external PC or terminal.
6. Another method which can be used to output characters to the external PC or terminal is to execute the IBASIC command, PRINTER IS 9. This causes IBASIC to direct all print output to Select Code 9. Select Code 9 is the Test Set's Serial Port 9. Select Code 1 is the Test Set's CRT. Select Code 1 is also the default address for the PRINTER IS command, so all program printer output defaults to the Test Set's CRT (unless changed with the PRINTER IS command).
7. Set the **Inst Echo** field to **ON**. This will cause characters to be echoed back to the external PC or terminal as they are received at Serial Port 9. If the echo feature of the external PC or terminal is also enabled all the characters sent to the Test Set will be displayed twice on the external PC or terminal. Enable echo on only one device, either the Test Set or the external PC or terminal.



## Interfacing to the IBASIC Controller using Serial Ports

**Receive and Transmit Pacing**

When receiving characters into the **IBASIC Command Line** field, the Test Set's microprocessor responds to each entry and no buffering is required. Therefore, when using your PC or terminal to send characters to the **IBASIC Command Line** field, it is permissible to set **Rcv Pace** and **Xmt Pace** to **None**.

When sending data through the Test Set's Serial Port to external devices like printers which may have small input buffers, it is important to set **Rcv Pace** and **Xmt Pace** to **Xon/Xoff**. This allows the printer to stop data transmission from the Test Set when the printer's buffer is full and then start it again when the printer is ready.

The Test Set has a Serial Port input buffer length of 2000 characters. Buffer size becomes important when IBASIC programs expect to receive large amounts of data through the Serial Port with a single ENTER statement.

**Table 31 Test Set Serial Port 9 Configuration**

| <b>Field</b>               | <b>Available Settings</b>                    | <b>Recommended Setting</b> |
|----------------------------|--|----------------------------|
| Serial In                  | Inst/IBASIC                                  | Inst                       |
| IBASIC Echo                | On/Off                                       | On                         |
| Inst Echo                  | On/Off                                       | On                         |
| Serial Baud Rate           | 150, 300, 600, 1200, 2400, 4800, 9600, 19200 | 9,600                      |
| Parity                     | None, Odd, Even, Always 1, Always 0          | None                       |
| Data Length                | 7 bits, 8 bits                               | 8 bits                     |
| Stop Length                | 1 bit, 2 bits                                | 1 bit                      |
| Rcv Pace (receive pacing)  | None, Xon/Xoff                               | Xon/Xoff                   |
| Xmt Pace (transmit pacing) | None, Xon/Xoff                               | Xon/Xoff                   |

## Interfacing to the IBASIC Controller using Serial Ports

**PC Configuration**

To prepare for IBASIC program development, the external PC or terminal must be configured to operate with the Test Set. This configuration includes

- hardware
- terminal Emulator Software

**PC Serial Port Configuration**

Refer to **figure 37 on page 248** for connection details. Connect the Test Set's Serial Port 9 to a serial I/O (input/output) port on the PC. On many PCs, a serial port is available as either a 25-pin DB-25 (female) connector or a 9-pin DB-9 (male) connector. This port can be configured as COM1, COM2, COM3, or COM4 (communications port 1, 2, 3, or 4) depending on the installed PC hardware and user-defined setup. Refer to the instructions shipped with the PC for hardware and software configuration information.

**Terminal Emulator Configuration Information**

A “terminal emulator” is an application program running on the PC that communicates with one of the serial communication ports installed in the PC. It provides a bi-directional means of sending and receiving ASCII characters to the Test Set's serial port.

In general, a “terminal emulator” enables the PC to act like a dedicated computer terminal. This type of terminal was used before PCs to allow remote users to communicate through RS232 with central mainframe computers. An ANSI-compatible terminal like the Digital Equipment Corporation VT-100 can be used to directly communicate with the Test Set. PC terminal emulation application programs have been designed to have setup fields much like these older technology terminals.

Interfacing to the IBASIC Controller using Serial Ports

**Setting Up Microsoft Windows Terminal on your PC (Windows Version 3.1)**

1. From the Program Manager, select the Accessories Group.
2. Select the Terminal icon.
3. From the Settings menu, make the following choices:
  - a. Select Terminal Emulator.
    1. DEC VT-100 (ANSI).
  - b. Select Terminal Preferences.
    1. Terminal Modes
      - Line Wrap: **Off**
      - Local Echo: **Off**
      - Sound: **Off**
    2. Columns: **132**
    3. CR->CR/LF
      - Inbound: **Off**
      - Outbound: **Off**
    4. Cursor
      - Block**
      - Blink: **On**
    5. Terminal Font: **Fixedsys**
    6. Translations: **None**
    7. Show Scroll Bars: **On**
    8. Buffer Lines: **100**
    9. Use Function, Arrow, and Ctrl Keys for Windows: **OFF**
  - c. Select **Test Transfer**.
    1. Flow Control: **Standard Flow Control**
    2. Word wrap Outgoing Text at Column: **Off**

## Interfacing to the IBASIC Controller using Serial Ports

- d. Select **Communications** (the first five of the following Communications choices for your PC Serial Port should match your Test Set settings).
  1. Baud Rate: **9600**
  2. Data Bits: **8**
  3. Stop Bits: **1**
  4. Parity: **None**
  5. Flow Control: **Xon/Xoff**
  6. Connector: **COM1, COM2, COM3, or COM4 depending on your PC setup**
  7. Parity Check: **Off**
  8. Carrier Detect: **Off**

**Setting Up ProComm Revision 2.4.3 on your PC**

ProComm is a general purpose telecommunications software package for PC's with MS-DOS . One of its functions is to provide an RS-232 terminal function on a typical PC.

**Running ProComm in MSDOS** (You can use ProComm's built-in help function to learn more about setting it up).

1. To access the help and command functions, press the Alt and F10 keys simultaneously (abbreviated as Alt+F10).
2. Press the space bar to move among the choices for a particular field.
3. Press ENTER to accept the displayed choice.

**Setting up the ProComm Software**

1. Press Alt+ P to access the LINE SETTINGS window.
2. Enter the number **11**. This will automatically set the following:
  - Baud rate: **9600**
  - Parity: **None**
  - Data Bits: **8**
  - Stop Bits: **1**
  - Selected communications port: **COM1** (This may be different on your PC)
3. To select a different communications port, enter the following numbers:
  - 20: **COM1**
  - 21: **COM2**
  - 22: **COM3**
  - 23: **COM4**
4. Enter the number 24 to save changes, to make the new configuration your default, and to exit LINE SETTINGS.

Interfacing to the IBASIC Controller using Serial Ports

5. Press Alt+S for the SETUP MENU.
6. Enter the number 1 for MODEM SETUP .
7. Enter the number 1 for the Modem init string .
8. Press Enter to set a null string.
9. Press Esc to exit MODEM SETUP back to the SETUP MENU.
10. Enter the number 2 for TERMINAL SETUP.
11. Terminal emulation: **VT-100**
  - Duplex: **FULL**
  - Flow Control: **XON/XOFF**
  - CR translation (in): **CR**
  - CR translation (out): **CR**
  - BS translation: **NON-DEST**
  - BS key definition: **BS**
  - Line wrap: **ON**
  - Scroll: **ON**
  - Break length (ms): **350**
  - Enquiry (CNTL-E): **OFF**
12. Press Esc to exit Terminal Setup back to the Setup Menu.
13. Enter the number 4 for General Setup.
  - Translate Table: **OFF**
  - Alarm sound: **OFF**
  - Alarm time (secs): **1**
  - Aborted downloads: **KEEP**
14. Press Esc to exit General Setup back to the Setup Menu.
15. On the Setup Menu, press S to save your entries.
16. Press Esc to exit the Setup Menu.
17. Press Alt+X to exit ProComm back to MS-DOS.

## Interfacing to the IBASIC Controller using Serial Ports

**Setting Up HP AdvanceLink (HP 68333F Version B.02.00) on your PC** HP

AdvanceLink is a software program which allows PCs to be used as an alphanumeric or graphics terminal. It can also automate terminal and file-transfer functions. The version described will work with PCs with the MS-DOS or PC-DOS operating systems. (AdvanceLink for Windows is also available, and configuration is very similar).

**Running AdvanceLink in MSDOS**

1. Press the Tab key to move from one field to the next, which also accepts the displayed choice.
2. Press the NEXT CHOICE and PREVIOUS CHOICE keys to move among the choices for a particular field.

**Setting up the AdvanceLink Software**

1. Press the TERMINAL function key.
2. Press CONFIG KEYS.
3. Press GLOBAL CONFIG.

Keyboard: **USASCII**  
 Personality: **ANSI**  
 Language: **ENGLISH**  
 Terminal Mode: **Alphanumeric**  
 Remote To: enter your PC's selected serial port number, often, **Serial 1**  
 Printer I/F: **None**  
 Memory Size: **32K**  
 Plotter I/F: **None**  
 Video Type: **select your display type**  
 Forms Path: **no entry**  
 Screen Size: **select your size – 23 or 24**

4. Press DONE to return to the Config screen.
5. Press REMOTE CONFIG (to set up the Serial port you selected above in Remote To).

Baud Rate: **9600**  
 Parity/DataBits: **None/8**  
 Enq Ack: **NO**  
 Asterisk: **OFF**  
 Chk Parity: **NO**  
 SR(CH): **LO**  
 Recv Pace: **Xon/Xoff**  
 CS(CB)Xmit: **NO**  
 XmitPace: **Xon/Xoff**

6. Press DONE to return to the Config screen.

Interfacing to the IBASIC Controller using Serial Ports

7. Press **TERMINAL CONFIG**.

Terminal Id: **2392A**  
LocalEcho: **OFF**  
CapsLock: **OFF**  
Start Col: **01**  
Bell: **ON**  
XmitFnctn(A): **NO**  
SPOW(B): **NO**  
InhEolWrp(C): **NO**  
Line/Page(D): **LINE**  
InhHndShk(G): **NO**  
Inh DC2(H): **NO**  
Esc Xfer(N): **YES**  
ASCII 8 Bits: **YES**  
Fld Separator: **down arrow or US**  
BlkTerminator: **up arrow or RS**  
ReturnDef: **musical note or CR**  
Copy: **Fields**  
Type Ahead: **NO**  
Row Size: **160**  
Host Prompt Character: **left arrow or D1**  
Horiz. Scrolling Increment: **08**

8. Press **DONE** to return to the Config screen.

9. Press **DONE** to return to the Terminal screen.

10. Press **MAIN** to return to the Main screen.

11. Press **EXIT ADVLINK** to exit.

## Terminal Configuration

Use the cable information in **table 30 on page 246** and **figure 36 on page 247** for connecting to an external terminal. Terminals typically have a DB-25 (male) connector. Set the terminal for DEC VT-100 ANSI emulation. Many ASCII terminals will also function properly.

To set up the terminal, use the field settings found in the HP AdvanceLink terminal emulator section found earlier in this chapter. As a minimum, make sure the terminal's basic setup information matches the fields on the Test Set's I/O CONFIGURE screen (refer to **table 31 on page 250** for recommended settings).

## Choosing Your Development Method

There are three fundamental methods for developing IBASIC programs for the Test Set. See **figure 38** below.

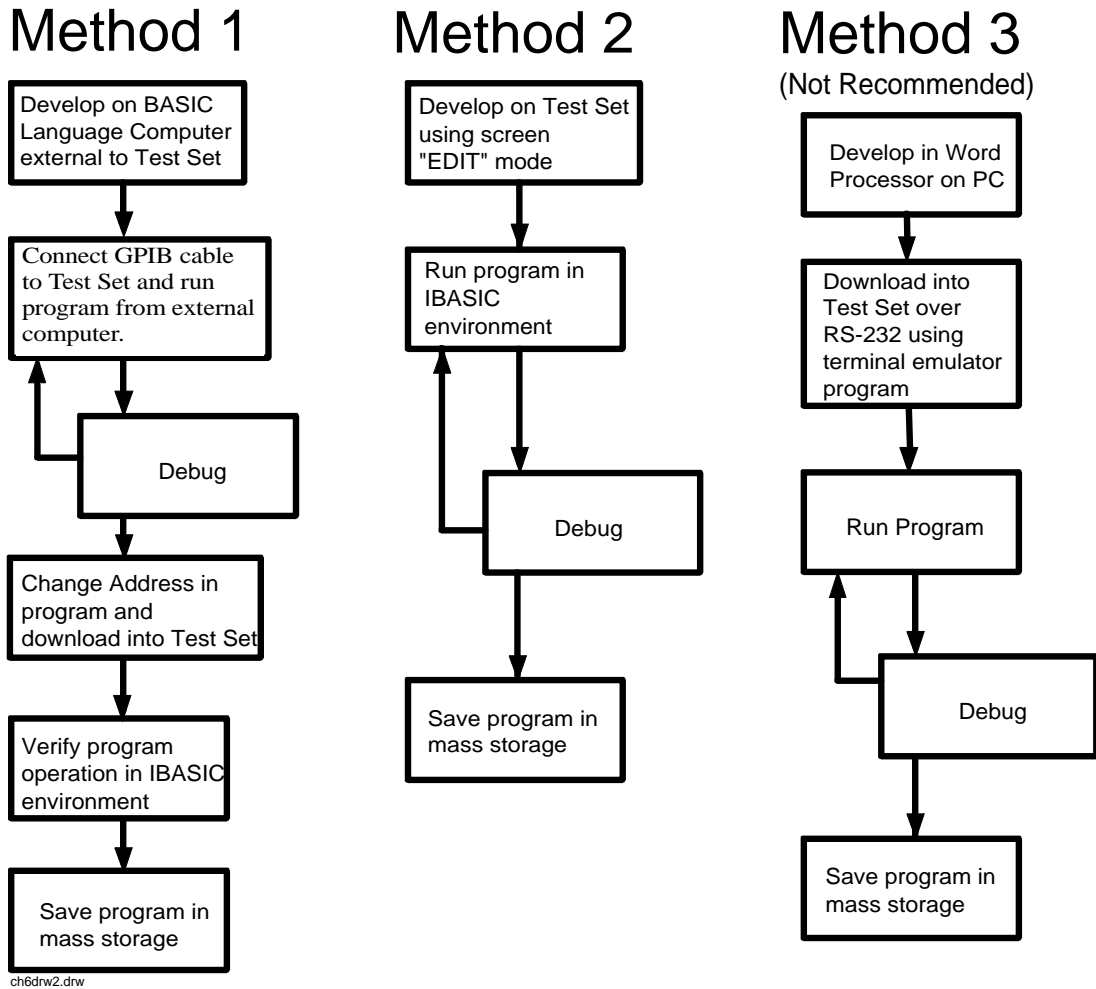

**Figure 38** Three Possible Development Methods



### **Method 1**

Using a BASIC language computer (either an HP technical computer or a PC running BASIC with GPIB) is the best method for developing any size program. This is because the program can be debugged directly on the external computer before downloading the program into the Test Set. Using this approach the programmer can observe the Test Set's display to see changes in state and easily verify the correct measurements.

### **Method 2**

If a BASIC language computer is not available, program development can be done directly on the Test Set using the IBASIC EDIT mode. A PC connected to the Test Set through RS-232, as described earlier in this chapter, is used as the CRT and keyboard for the internal controller. In this method, the program always resides in the Test Set and can be run at any time. Mass storage is usually an SRAM card. When running IBASIC programs on the Test Set's internal controller, the Test Set displays only the IBASIC screen, not the individual instrument screens as the program executes. This makes troubleshooting larger programs more difficult.

### **Method 3**

The third method of program development is to use a word processor on a PC with RS-232, and then download the program into the Test Set for execution. This is the least favorable choice for development because downloading code into the Test Set over RS-232 requires a loader utility program running in the Test Set and a RAM memory card present as an intermediate storage location before running the program. (For shorter programs, the intermediate storage location is not necessary.) No IBASIC command syntax is checked until the program is run after downloading. Also, when running IBASIC programs on the Test Set's internal controller, the Test Set displays only the IBASIC screen, not the individual instrument screens as the program executes. This makes troubleshooting larger programs more difficult.

Method #1. Program Development on an External BASIC Language Computer

---

## Method #1. Program Development on an External BASIC Language Computer

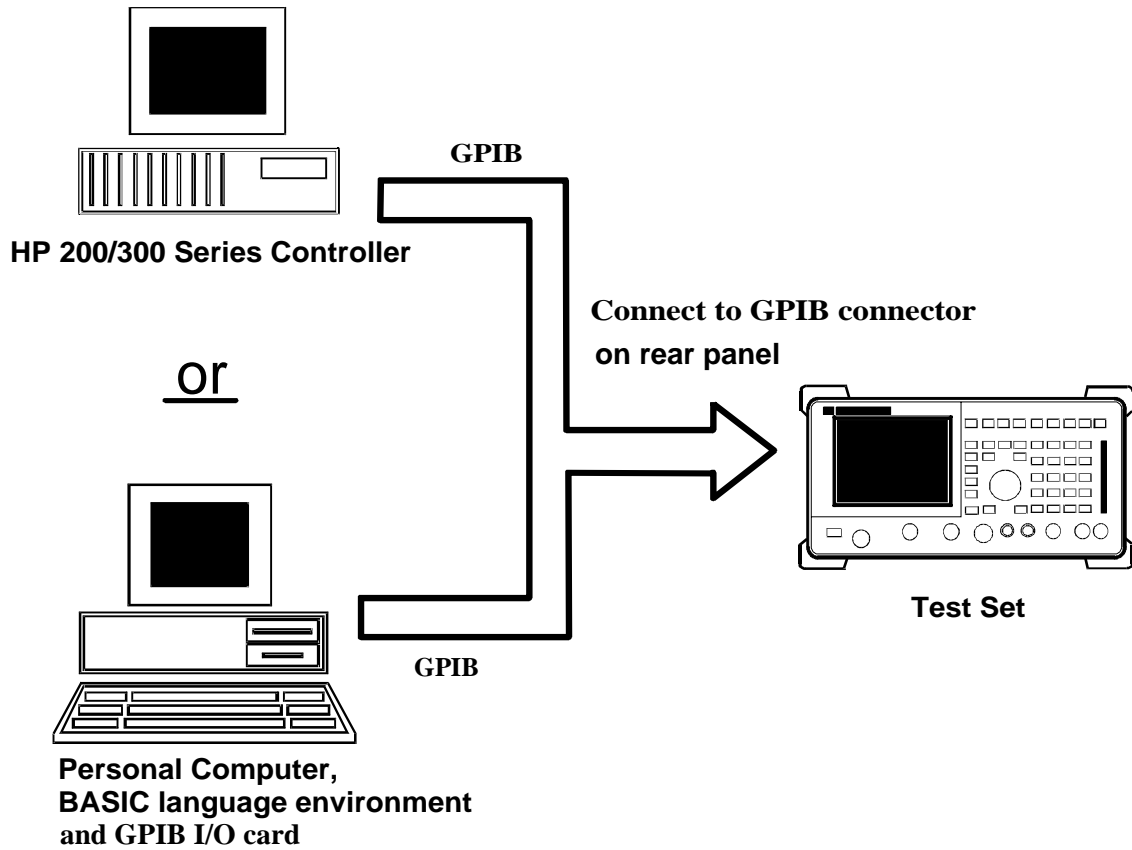

ch6drw5.drw

Figure 39 Connecting IBASIC Language Computers to the Test Set

Method #1. Program Development on an External BASIC Language Computer

### Configuring the Test Set's GPIB Interface

To use GPIB (the IEEE 488 interface bus) as a means of communicating with the Test Set, connect a standard GPIB cable (such as the Agilent 10833B) between the Test Set's rear-panel GPIB connector and the GPIB connector on the external BASIC language computer.

#### On the Test Set

1. Select the I/O CONFIGURE screen.
2. Set the **Mode** field to **Talk&Lstn**.

---

**NOTE:**

If the **Mode** field is set to **Control**, there could possibly be a System Controller conflict between the external BASIC language computer and the Test Set, resulting in either an Interface Status Error or "lock up" of the GPIB. Refer to "Passing Instrument Control" in the Operating Overview chapter of the *Agilent 8924C User's Guide*.

---

3. Set the **GPIB Adrs** field to the desired address for the Test Set. The default value is 14.

### Compatible BASIC Language Computers

As shown in **figure 39 on page 259**, there are two types of computers that can be used in this development method. The preferred computer is an HP 9000 Series 200/300 Workstation running HP Rocky Mountain BASIC 6.2 or later. IBASIC is a subset of HP Rocky Mountain BASIC (RMB). All IBASIC commands are compatible with RMB and thus will execute from a HP 9000 Series 200/300 Workstation.

If this is not available, a PC running a BASIC language environment, such as TransEra HT BASIC 4.0 and an GPIB card can be used. If this approach is used ensure that no BASIC language commands are used in the program which are not compatible with IBASIC.

## Method #1. Program Development on an External BASIC Language Computer

**Program Development Procedure**

The Test Set has two GPIB buses, an internal GPIB at select code 8 and an external GPIB at select code 7. The Test Set's built-in IBASIC controller uses the internal GPIB to communicate with the Test Set's various instruments and devices. The process of developing a program on an external BASIC language computer utilizes this hardware feature to an advantage. First, develop the program directly on the external BASIC language computer treating the Test Set as a device on the external BASIC language computer's GPIB. For example, to setup the Test Set's RF Generator use the OUTPUT command with the Test Set's GPIB address. If the select code of the GPIB card in the external BASIC language computer is 7 and the address of the Test Set is 14 the address following the OUTPUT command would be 714. When the command executes on the external BASIC language computer the information on how the Test Set's RF Generator is to be configured is sent to the Test Set through its external GPIB bus. After the program is fully developed, making it run on the Test Set is simply a matter of changing the address of all the GPIB commands to 8XX (Test Set internal GPIB bus) and downloading the program into the Test Set's IBASIC controller and executing it.

Method #1. Program Development on an External BASIC Language Computer

There are two ways of allowing easy conversion of all GPIB commands to a different address. The first way is to establish a variable to which the 3-digit address number is assigned.

**For example**

```
10 Addr = 714           ! Sets the value of variable Addr to be 714.
20 OUTPUT Addr;"*RST"  ! Commands the Test Set to reset at address 714.
```

To change the address, simply change the value of variable Addr to 814.

**For example**

```
10 Addr = 814           ! Sets the value of variable Addr to be 814.
20 OUTPUT Addr;"*RST"  ! Commands the Test Set to reset at address 814.
```

A second method is to assign an I/O path to the desired I/O port.

**For example**

To control device #14 on the port with select code 7.

```
10 ASSIGN @Device TO 714! Establishes I/O path to select code 7 address 14.
20 OUTPUT @Device;"*RST"! Commands Test Set to reset at address 714.
```

To change the address, simply change line 10 to

```
10 ASSIGN @Device TO 800.
```

---

**NOTE:**

The dedicated GPIB interface at select code 8 conforms to the IEEE 488.2 Standard in all respects but one. The difference being that each instrument on the bus does not have a unique address. The Instrument Control Hardware determines which instrument is being addressed with the command syntax. As such an explicit device address does not have to be specified. The address 800 and 814 are equally correct.

---

## Method #1. Program Development on an External BASIC Language Computer

**Downloading Programs to the Test Set through GPIB**

An IBASIC PROGRAM subsystem has been developed to allow the external BASIC language controller to download programs to the Test Set through GPIB (refer to the "**PROGRAM Subsystem Commands**" on page 283 for more information on the PROGRAM Subsystem). Four commands from the external BASIC language controller to the Test Set are necessary to transfer the program. The commands are executed serially allowing enough time for each command to finish executing. (The Test Set's GPIB **Mode** field must be set to **Talk&Lstn**, and the TESTS (IBASIC CONTROLLER) screen must be displayed).

1. OUTPUT 714; "PROG:DEL:ALL"

Deletes any programs that reside in Test Set RAM.

2. OUTPUT 714; "PROG:DEF #0"

Defines the address in Test Set RAM where the downloaded program will be stored.

3. LIST #714

Causes all program lines to transfer over GPIB to the Test Set which is at address 714.

4. OUTPUT 714; "END"

Defines end of download process by generating an EOI command.

After the above commands complete the program code will be in the Test Set ready to run. If any bugs are detected when the program is run, the program can be uploaded back into the external BASIC language controller to correct the error. Alternately the full screen IBASIC EDIT function through RS-232 can be used to correct the error (refer to "**Method #2. Developing Programs on the Test Set Using the IBASIC EDIT Mode**" on page 266 for details).

After the program is working properly in the Test Set IBASIC environment, it should be stored for backup purposes.

## **Uploading Programs from the Test Set to an External BASIC Controller through GPIB**

To upload a program from the Test Set to an external BASIC language controller through GPIB the following program, which uses a command from the PROGram subsystem to initiate the upload, must be running on the external BASIC language controller. The uploaded program is stored to a file specified by the user.

In the following program the external BASIC language controller is a PC running TransEra HT BASIC. The file is stored to the C:\HTB386 directory. If the external BASIC language controller is an HP 9000 Series 200/300 Workstation, modify the mass storage volume specifier appropriately. After running the program, the uploaded program code will be in the designated file. Use the GET command to retrieve the file for editing.

## Method #1. Program Development on an External BASIC Language Computer

```

10 ! PROGRAM TO UPLOAD IBASIC CODE FROM TEST SET TO BASIC CONTROLLER THROUGH GPIB.
20 !#####
30 !
40 ! The file for uploaded code will be "C:\htb386\code".
50 ! If you want to use a different file or directory, modify the two lines
60 ! with the labels "File_name_1" and "File_name_2".
70 !
80 !#####
90 Addr=714 !Test Set GPIB address
100 ALLOCATE Line$(200)
110 PRINTER IS 1
120 CLEAR SCREEN
130 DISP "It may be several minutes before code begins transferring if the program is long"
140 OUTPUT Addr;"*RST" !Reset the Test Set
150 OUTPUT Addr;"DISP TIB" !Displays the IBASIC screen
160 OUTPUT Addr;"PROG:EXEC 'CLS'" !Clears the Test Set display
170 OUTPUT 714;"PROG:DEF?" !Initiates the upload of whole program
180 ENTER Addr USING "X,D,#";Count_len !Number of lines in program
190 ENTER Addr USING VAL$(Count_len)&"D,#";Char_count !Number of characters
200 !
210 File_name_1: CREATE ASCII "C:\htb386\code", (1.05*Char_count/256)+5
220 ! Number of records reserved for upload.
230 File_name_2: ASSIGN @File TO "C:\htb386\code"
240 !
250 DISP "Transferring code from Test Set"
260 LOOP !Program transfer loop.
270 ENTER Addr;Line$ !CR/LF terminates each line.
280 PRINT Line$ !Displays new lines on Test Set display.
290 OUTPUT @File;Line$ !Transfer new line to file.
300 Char_count=Char_count-LEN(Line$)-2 !Reduces Char_count by the number of
310 ! characters in current line.
320 EXIT IF Char_count<=0
330 END LOOP
340 !
350 ASSIGN @File TO * !Cleans out file buffer.
360 ENTER Addr;Line$ !Close off reading
370 CLEAR SCREEN
380 DISP "Transfer complete."
390 LOCAL Addr
400 END

```



---

## Method #2. Developing Programs on the Test Set Using the IBASIC EDIT Mode

If a BASIC language computer is not available, program development can be done directly on the Test Set using the IBASIC EDIT mode. A terminal or PC connected to the Test Set through RS-232 is used as the CRT and keyboard for the Test Set's built-in IBASIC controller. In this method, the program always resides in the Test Set and can be run at any time. Mass storage is usually an SRAM memory card. When running IBASIC programs on the Test Set's internal controller, the Test Set displays only the IBASIC screen.

The Test Set's IBASIC controller has an editor that is interactive with a terminal or PC over the RS-232 serial port. (The editor does not work unless a terminal or PC with terminal emulator is connected to Serial Port 9.) The editor, hereafter referred to as the "IBASIC EDIT Mode", allows the programmer to develop code directly in the Test Set with no uploading or downloading. The IBASIC EDIT Mode can be used to develop programs from scratch or to modify existing programs. Refer to "Interfacing to the IBASIC Controller using Serial Ports" on page 244 for information on connecting a terminal or PC to the Test Set.

### Selecting the IBASIC Command Line Field

To use the IBASIC EDIT Mode for program development, the **IBASIC Command Line** field must be displayed on the Test Set and Serial Port 9 must be connected to the **IBASIC Command Line** field. An IBASIC command, sent as a series of ASCII characters through Serial Port 9, will appear on the **IBASIC Command Line** field. When a carriage return/line feed is encountered, the Test Set will attempt to execute the command. To display the **IBASIC Command Line** field on the Test Set execute the following steps:

1. Press the TESTS key.
2. The TESTS (Main Menu) screen will be displayed.
3. Using the rotary knob, position the cursor on the **IBASIC Cntrl** field and select it.
4. The TESTS (IBASIC CONTROLLER) screen will be displayed.
5. The small horizontal rectangle at the top-left is the **IBASIC Command Line**

## Method #2. Developing Programs on the Test Set Using the IBASIC EDIT Mode

**To Access the IBASIC Command Line Field**

1. Position the cursor on the screen's upper left. This is the **IBASIC Command Line** field.
2. The **IBASIC Command Line** field does not have a title like other fields in the Test Set; it is the highlighted, horizontal 2-line "bar" just below the screen title, TESTS (IBASIC Controller).

**To Use the IBASIC Command Line Field with the Test Set's Rotary Knob**

1. Position the cursor at the **IBASIC Command Line** field and push the knob.
2. A **Choices:** field will be displayed in the lower, right corner of the display.
3. By rotating the knob, a list of ASCII characters and cursor positioning commands can be displayed on the right side of the screen.
4. When the cursor is next to the desired character or command, push the knob to select that character.
5. No external hardware is required for this entry method, but it is tedious and is recommended only for short commands. Use this method when doing simple tasks such as initializing memory cards or CATaloging a memory card.
6. Program development using the rotary knob alone is not recommended.

## Entering and Exiting the IBASIC EDIT Mode

To enter the IBASIC EDIT Mode first position the cursor on the **IBASIC Command Line** field, type the word EDIT on the terminal or PC connected to the Test Set and then press the ENTER key on the terminal or PC. At this point the Test Set will fill the PC screen with 22 lines of IBASIC code from the program currently in the Test Set's RAM memory. No program lines will be displayed on the Test Set screen. If no program is currently in the Test Set's memory, the number 10 will be displayed on the terminal or PC screen. This represents program line number 10 and is displayed to allow you to begin writing an IBASIC program beginning at line number 10. The "\*" annunciator will be displayed in the upper, right corner of the Test Set indicating that the IBASIC controller is running to support the full screen edit mode.

After editing is complete, exit the IBASIC EDIT Mode by pressing the terminal or PC's ESCAPE key twice or pressing the SHIFT CANCEL keys on the Test Set.

A variety of editing commands are supported by the IBASIC EDIT Mode. These commands are activated in the Test Set as escape code sequences. Most terminals and PC terminal emulator programs allow function keys to be configured with user defined escape code sequences and user defined labels for the keys. An escape command (when received by a peripheral device like a printer or the Test Set) causes the peripheral to recognize subsequent ASCII characters differently. In the case of the Test Set, escape sequences are used for executing IBASIC EDIT Mode editing commands.

For example, ESCAPE [L causes the Test Set to insert a new line number where the cursor is positioned. **Table 32 on page 269** lists the editing escape codes for the Test Set. There is no escape code for DELETE CHARACTER. Use the Backspace key for deleting. Use the arrow keys to position the cursor.

## Setting Up Function Keys In Microsoft Windows Terminal

When in the TERMINAL mode, click on Settings, then Function Keys. ^[ is ESCAPE in Windows Terminal. See **table 32 on page 269** for the escape codes.

---

**NOTE:** Windows Terminal seems to work best when a mouse is used to access the function keys, not the keyboard. Also, scrolling a program works best when the Terminal window display is maximized).

---

## Method #2. Developing Programs on the Test Set Using the IBASIC EDIT Mode

**Setting Up Function Keys in HP AdvanceLink**

- From the **Main** (highest level) screen, set up the 8 softkeys as follows:
  1. Display User Definition screens by pressing Ctrl F9.
  2. Enter all the LABEL titles for K1 through K8.
  3. Activate the “Display Function” feature by pressing softkey **F7**.
  4. Now you can enter the escape codes for each edit command aligned with the soft key definitions you just entered. With the Display Functions key pressed, when you press the escape key, a left arrow will be displayed.
- Once you have set up all 8 keys, you activate them by pressing Shift F12. To deactivate your user defined softkeys, press F12.
- (- is ESCAPE in HP AdvanceLink. See **table 32 on page 269** for the escape codes.

**Setting Up Function Keys in ProComm**

ProComm does not have function keys. However, escape sequences can be assigned to number keys 0 through 9 by using the Keyboard Macro function. This function is accessed by keying Alt+M. There is no method of displaying key labels so they will have to be recorded elsewhere. See the ProComm manual for further information.

**Table 32** Edit Mode Escape Code Commands

| Function Key Names | Windows Terminal Escape Codes | HP AdvanceLink Escape Codes |
|--------------------|-------------------------------|-----------------------------|
| INSERT LINE        | ^[[L                          | (-[L                        |
| DELETE LINE        | ^[[M                          | (-[M                        |
| GO TO LINE         | ^[g                           | (-g                         |
| CLEAR LINE         | ^[[K                          | (-[K                        |
| PAGE UP            | ^[OQ                          | (-OQ                        |
| PAGE DOWN          | ^[OR                          | (-OR                        |
| RECALL LINE        | ^[r                           | (-r                         |
| BEGIN LINE         | ^[OP                          | (-OP                        |
| END LINE           | ^[OS                          | (-OS                        |

---

### **Method #3. Developing Programs Using Word Processor on a PC (Least Preferred)**

The third method of IBASIC program development is to write the program using a word processor on a PC, save it as an ASCII file, and then download it into the Test Set through the serial port. The benefit of this method is that it can be done on the PC without connecting to a Test Set until download and no BASIC language compiler/interpreter is needed. The primary drawback is that no syntax checking occurs until the downloaded program is run on the Test Set. A second drawback is that, especially for longer programs (>100 lines), it is very time-consuming to transfer the code into the Test Set.

#### **Configuring a Word Processor**

The word processor on which the IBASIC code is developed must be able to save the file in ASCII format and have an ASCII file transfer utility. This is necessary because word processors use a variety of escape codes to mark all the special display formats such as bold face, font size, indented text, and the like. When a word processor file is stored in ASCII format, all escape codes are stripped off. The ASCII file transfer utility is used to transfer the file to the Test Set.

---

**NOTE:** The GET command can be used on external BASIC language controllers to load ASCII files containing IBASIC programs developed on word processors. Once loaded, the steps for downloading described in "**Method #1. Program Development on an External BASIC Language Computer**" on page 259 can be used to transfer the program to the Test Set.

---

## Method #3. Developing Programs Using Word Processor on a PC (Least Preferred)

**Writing Lines of IBASIC Code on a Word Processor**

When writing IBASIC programs, follow these steps to ensure that the Test Set will accept the code when it is downloaded.

1. Always begin new lines at the far left margin. Never use a leading space or tab.
2. Number each consecutive line just like an IBASIC language program.
3. Typically begin with 10 and increment by ten for each consecutive line.
4. Do not leave any space or double space between lines.
5. Make sure to use hard carriage return / line feeds at the end of each line.
6. When saving the completed program, save it as an ASCII file. Some word processors have ASCII options which require that the user specify CR/LF at the end of each line. It is important that each line end with a carriage return / line feed.
7. Experiment with a short program first to make sure everything is working correctly.

**Transferring Programs from the Word Processor to the Test Set**

For short (less than 100 lines) programs, use an ASCII file transfer utility on the PC to send the program, one line at a time, down to the Test Set over RS-232 directly into the IBASIC Command Line field. The Test Set must be configured to receive serial ASCII characters by positioning the Test Set cursor at the IBASIC Command Line field as explained under "**Method #2. Developing Programs on the Test Set Using the IBASIC EDIT Mode**" on page 266. With this setup, when ASCII characters are received they are sent to the IBASIC Command Line field. When a carriage return / line feed is received, the Test Set will parse the line into the IBASIC program memory. Each line takes about two seconds to scroll in and be parsed. This becomes very time consuming for long programs. An alternative for longer programs is discussed later in this section.

To start the transfer process make sure there is no program in the Test Set's IBASIC RAM memory by executing a SCRATCH command from the IBASIC Command Line.

Method #3. Developing Programs Using Word Processor on a PC (Least Preferred)

The following example shows how to transfer a short program (<100 lines) using Microsoft Windows Terminal.

1. Make sure the Test Set cursor is in the upper left of the IBASIC Command Line field.
2. Select the **Terminal application** in the Accessories Group. Set it up as described in earlier in this chapter.
3. Select the following:
  - Settings
  - Text Transfers
  - Flow Control: Line at a Time
  - Delay Between Lines: 25/10 Sec
  - Word Wrap
  - Outgoing Text at Column: Off.
4. Select the following:
  - Transfers
  - Send Text File
  - Following CR:
    - Strip LF selected
    - Append LF not selected.
5. Select the text file to be transferred and begin the transfer by selecting (OK).

As the transfer starts the **IBASIC Command Line** field will intensify and characters will scroll in left to right. As each line is finished the “\*” annunciator will be displayed, for about 0.5 seconds, in the upper, right corner of the Test Set indicating that the IBASIC controller is running as the line is parsed. If another line is sent before this parsing is complete, the Test Set will beep indicating an error, and the next line of the transfer will be rejected.

If the transfer is rejected, the transfer must be halted and the delay between lines increased to a slightly higher number. Start the transfer again from the beginning. When all lines have transferred, list the program to verify it was completely received. At this time, the program is ready to run. The RUN command can be keyed in from the PC or the K1 Run key in the TESTS (IBASIC Controller) screen can be pressed.

---

**NOTE:** Do not press the Run Test key in the TESTS (Main Menu) screen as this will scratch the program you just loaded and look to the memory card for a procedure file.

---

## Method #3. Developing Programs Using Word Processor on a PC (Least Preferred)

For longer programs (greater than 100 lines), transferring the ASCII text file directly into the IBASIC program memory through the RS-232 serial port is too time consuming. To speed the process up, it is necessary to transfer the program using a two step process.

1. Transfer the ASCII text file directly to a Test Set mass storage location (typically an SRAM card).
2. Perform a GET command to bring the program from mass storage into the IBASIC program memory.

To perform the ASCII text file transfer for long programs, an IBASIC program, running in the Test Set, is required to manage the transfer. A suitable program titled "ASCII\_DN" (for ASCII downloader) is shown on the following page.

The ASCII\_DN program runs on the Test Set and directs ASCII characters coming in Serial Port 9 directly to a file named TEMP\_CODE on an SRAM card. The program creates the TEMP\_CODE file on the SRAM card with a size of 650 records (166 Kbytes or enough for about 6600 lines of ASCII text). When the program is run, it displays **Ready to receive ASCII file data**. When this prompt is displayed, initiate the transfer of the ASCII text file representing the program from the PC to the Test Set. Shown below are two methods of sending an ASCII file from the PC to the Test Set. Both methods require that the ASCII\_DN program be running in the Test Set when the transfer begins. The ASCII\_DN program can be transferred into the Test Set either by typing it in using the IBASIC EDIT Mode described earlier, or downloading it from an ASCII text file one line at a time as explained earlier.



## Method #3. Developing Programs Using Word Processor on a PC (Least Preferred)

```

10 ! ASCII_DN
20 ! Program to download ASCII program file from PC to the Test Set through RS-232
30 ! #####
40 !
50 ! This program must be loaded into the Test Set and run on the Test Set.
60 ! It directs ASCII characters that come in the Serial Port 9 to a file
70 ! named "TEMP_CODE" on an SRAM card. After the transfer is complete,
80 ! you must SCRATCH this program and GET the transferred program from
90 ! the "TEMP_CODE" file.
100 !
110 ! #####
120 COM /File_name/ File_name${10}
130 DIM In${200}
140 File_name$="TEMP_CODE" !File name on RAM card
150 CLEAR SCREEN
160 CLEAR 9 !Clears serial bus
170 OUTPUT 800;"*RST"
180 ! Set up Test Set Serial Port 9 to receive ASCII text file
190 OUTPUT 800;"CONF:SPORT:BAUD '9600';PAR 'None';DATA '8 Bits'"
200 OUTPUT 800;"CONF:SPORT:STOP '1 Bit';RPAC 'Xon/Xoff';XPAC 'Xon/Xoff'"
210 OUTPUT 800;"CONF:SPORT:SIN 'IBASIC';IBECHO 'OFF'"
220 CALL Code(File_name$,In$)
230 END
240 Purge_it:SUB Purge_it!Purges File_name on card
250 COM /File_name/ File_name$
260 OFF ERROR
270 PURGE File_name$&":INTERNAL"
280 SUBEND
290 Code:SUB Code(File_name$,In$)
300 ON ERROR CALL Purge_it !Branches if CREATE statement returns error
310 CREATE ASCII File_name$&":INTERNAL",650!Creates file on card
320 OFF ERROR
330 ASSIGN @File TO File_name$&":INTERNAL"
340 PRINT TABXY(1,5);"Ready to receive ASCII file data."
350 PRINT
360 Begin:ON TIMEOUT 9,1 GOTO Begin !Loops until data begins coming
370 ENTER 9;In$
380 OUTPUT @File;In$
390 PRINT In$
400 Transfer:LOOP !Loops to bring in ASCII file one line at a time
410 ON TIMEOUT 9,5 GOTO Done !Exit loop if data stops for >5 sec.
420 ENTER 9;In$
430 PRINT In$
440 OUTPUT @File;In$
450 END LOOP
460 Done:ASSIGN @File TO *
470 CLEAR SCREEN
480 ! Returns Test Set Serial Port 9 input to "instrument" allowing serial
490 ! communication to the IBASIC Command line field.
500 OUTPUT 800;"CONF:SPORT:SIN 'Inst';IECHO 'ON';IBECHO 'ON'"
510 PRINT TABXY(1,5);"Down load of ASCII file is complete."
520 SUBEND

```

Method #3. Developing Programs Using Word Processor on a PC (Least Preferred)

### **Sending ASCII Text Files Over RS-232 With Windows Terminal**

Set up the Windows Terminal emulator software on the PC as covered in "**Setting Up Microsoft Windows Terminal on your PC (Windows Version 3.1)**" on page 252. Load and run the ASCII\_DN download program in the Test Set's IBASIC controller. When the prompt `Ready to receive ASCII file data` is displayed on the Test Set, make the following settings in Windows Terminal on the PC:

1. Select **Settings**.
2. Select **Text Transfers**.
3. Select **Flow Control: Standard Flow Control**.
4. Select **Word Wrap Outgoing Text at Column: unselected**.  
This will use **Xon/Xoff** flow control by default.
5. Select **OK**.
6. Select **Transfers**.
7. Select **Send Text File**.
8. Set **Strip LF** off and **Append LF** off. (It is important that the line feeds that are in the ASCII file not be stripped or the file transfer will not work).
9. Select or enter the file name to transfer.
10. Begin the transfer by selecting **OK**.

At this point, each line of the program will rapidly scroll across the screen of the Test Set. When the transfer is finished, the prompt `Down load of ASCII file complete` will be displayed on the Test Set.

Before running the downloaded program, execute a **SCRATCH** command on the **IBASIC Command Line** to remove the ASCII\_DN download program from Test Set memory.

Next, execute a **GET TEMP\_CODE** command on the **IBASIC Command Line**. This will load the ASCII text into the IBASIC program memory.

Finally, execute a **RUN** command on the **IBASIC Command Line**. This will run the program. If any syntax errors are present in the program IBASIC will generate the appropriate error messages.

## Sending ASCII Text Files over RS-232 with ProComm Communications Software

Set up the ProComm terminal emulator software on the PC as covered in "**Setting Up ProComm Revision 2.4.3 on your PC**" on page 253. On the Test Set, enter and run the ASCII\_DN download program in the IBASIC controller. When the prompt **Ready to receive ASCII file data** is displayed on the Test Set, make the following settings in the ProComm terminal emulator on the PC:

---

### NOTE:

The ProComm terminal emulator views the file transfer as sending the file from the PC "up" to the Test Set. This is opposite to the direction used by the previous Windows Terminal example. Therefore, with ProComm an ASCII "upload" transfer is used.

---

1. Press Alt+F10 to display the ProComm help screen.
2. Press Alt+P to display the **SETUP MENU**.
3. Select item 6: **ASCII TRANSFER SETUP**.
4. Set Echo locally: **NO**.
5. Expand blank lines: **YES**.
6. Pace character: **0**.
7. Character pacing: **15**.
8. Line pacing: **10**.
9. CR translation: **NONE, LF**.
10. Translation: **NONE** (This is important since the default setting will strip line feeds and this will cause the transfer to never begin).
11. Select the Escape key to exit setup mode and return to the main screen.
12. Press Alt F10 to access the help menu.
13. To begin sending the file, select **PgUp**.
14. In the **UPLOAD** screen, select **7 ASCII** protocol.
15. Run the **ASCII\_DN** download program on the Test Set.
16. When the Test Set displays **Ready to receive ASCII file data**, press Enter on the PC to begin the transfer. At this point, each line of the program will rapidly scroll across the screen of the Test Set. When the transfer is finished, the download program will display **Down load of ASCII file complete.**, and the program file will be stored on the SRAM card in the **TEMP-CODE** file.
17. Before running the transferred program, execute a **SCRATCH** command on the IBASIC Command Line line to remove the ASCII\_DN download program from Test Set memory.
18. Next, execute a **GET TEMP\_CODE** command on the IBASIC Command Line. This will load the ASCII text into the IBASIC program memory.
19. Finally, execute a **RUN** command on the IBASIC Command Line. This will run the program. If any syntax errors are present in the program IBASIC will generate the appropriate error messages.

---

## Uploading Programs from the Test Set to a PC

As an overview, the following steps must be performed:

1. The Test Set must output the program over Serial Port 9.
2. The PC must receive the data through its serial port and direct the data to a file on disk. This can be done by a terminal emulator program such as Windows Terminal, ProComm, or HP AdvanceLink. This requires having the serial port connection established as outlined in "**Interfacing to the IBASIC Controller using Serial Ports**" on page 244.

To configure the Test Set to output the program to Serial Port 9 position the cursor on the IBASIC Command Line field. Execute the command `PRINTER IS 9`. This command sets Serial Port 9 as the default printer port. When `PRINT` commands are executed, ASCII characters will be sent to Serial Port 9.

On the PC, select **Receive Text File** in Windows Terminal or **Receive Files** (PgDn which is called Download) in ProComm. Enter a file name, then initiate the file transfer. The PC is now looking for ASCII text to come in the serial port.

Load the program to be transferred into the Test Set. Execute the `IBASIC LIST` command on the IBASIC Command Line. The program listing will be sent to Serial Port 9 and be received by the terminal emulator software on the PC. When the listing is finished, terminate the file transfer by selecting Stop on Windows or Escape on ProComm.

---

## Serial I/O from IBASIC Programs

There are two serial ports available for I/O (input / output) to peripherals external to the Test Set. To bring data in to the Test Set through the serial port(s) use the IBASIC ENTER command. To send data out, use the OUTPUT command.

### Serial Ports 9 and 10

The Test Set uses a small RJ-11 female connector on the rear panel for connecting to the two serial ports. This connector has six wires, 3 for Serial Port Address 9 and 3 for Serial Port Address 10. For information about serial port configuration, refer to the "**Test Set Serial Port Configuration**" on page 244. For connection information, refer to **figure 37 on page 248**.

Before using either port, the RS-232 protocol must be established by setting baud rate, pacing, and the other settings as explained in "**Test Set Serial Port Configuration**" on page 244. Functionally, from an I/O perspective, the two serial ports are identical. However, operationally there is one major difference. The Serial Port Address 9 settings are adjustable on the I/O CONFIGURE screen or with IBASIC commands, while the Serial Port 10 settings are adjustable only with IBASIC commands. There is no screen for Serial Port 10 settings. For more information, see the "CONFigure:SPORT" and "CONFigure:SPB" subsystems in the GPIB Command Syntax chapter of the *Agilent 8924C Condensed Programming Reference Guide* which gives the command syntax for Serial Port 9 and 10.

## Serial I/O from IBASIC Programs

**Example IBASIC Program Using Serial Port 10**

The following program illustrates I/O to both serial ports. The program sends a prompt message to a terminal connected to Serial Port 9 and waits for a response from the user at the terminal. When the response is received from the terminal connected to Serial Port 9, a series of ASCII characters are sent out Serial Port 10.

```

10 !.....ASCII CHARACTER CYCLER.....
20 !.....Prompts user over Serial Port 9. To see this prompt, you need to
30 !.....be connected to a terminal at 9600 baud.
40 !.....Outputs ASCII characters on Serial Port 10 beginning with ASCII
50 !.....character 32 (space) and ending with ASCII character 126 (~).
60 !.....Characters are output with no CR/LF.
70 OUTPUT 9;"When you are ready for data to be sent on port 10, press ENTER"
80 OUTPUT 800;"CONF:SPOR:SIN 'IBASIC';BAUD '9600'" !Allows IBASIC to read port 9.
90 DIM A$(10)
100 ENTER 9;A$      !Program waits here until CR/LF is received.
110 !.....
120 I=32
130 WHILE I<=126
140 OUTPUT 10 USING "K,#";CHR$(I)      !Outputs characters all on one line.
150 I=I+1
160 END WHILE
170 OUTPUT 800;"CONF:SPOR:SIN 'Inst'"   !Sets port 9 to IBASIC entry field.
180 EXECUTE ("CURSOR HOME")           !Places cursor at left of IBASIC entry field.
190 END

```

## Serial I/O from IBASIC Programs

**Serial Port 10 Information**

Serial Port 10 is sometimes called Serial Port B in Test Set documentation and programs.

The default Serial Port 10 settings are the same as Serial Port 9. They are

1. Serial Baud rate: **9600**
2. Parity: **None**
3. Data Length: **8 Bits**
4. Stop Length: **1 Bit**
5. Receive and Transmit Pacing: **Xon/Xoff**
6. Serial in: **Not available for Port 10**
7. IBASIC and Instrument Echo: **Not available for Port 10**

There is no Test Set screen that shows Serial Port 10's settings. Therefore, to know Serial Port 10 settings, they must either be set or queried using IBASIC commands.

For example, the following IBASIC program queries the baud rate setting of Serial Port 10:

```
10 DIM Setting$[20]
20 OUTPUT 800;"CONF:SPB:BAUD?"      !Initiates a query.
30 ENTER 800;Setting$
40 DISP Setting$
50 END
```

This program returns a quoted string. If the baud rate is set to 9600, the returned ASCII character string is **9600**. Serial Port 10 settings are held in non-volatile memory. They remain unchanged until modified using an IBASIC command.

## PROGram Subsystem

### Introduction

The PROGram Subsystem provides a set of commands which allow an external controller to generate and control an IBASIC program within the Test Set. The PROGram Subsystem in the Test Set is a limited implementation of the PROGram Subsystem defined in the Standard Commands for Programmable Instruments (SCPI) Standard. The PROGram Subsystem commands, as implemented in the Test Set, can be used to

- download an IBASIC program from an external controller into the Test Set
- upload an IBASIC program from the Test Set into an external controller
- control an IBASIC program resident in the Test Set from an external controller
- set or query program variables within an IBASIC program which is resident in the Test Set
- execute IBASIC commands in the Test Set's IBASIC Controller from an external controller

### SCPI PROGram Subsystem

The SCPI PROGram Subsystem was designed to support instruments which can store multiple programs in RAM memory at the same time. The SCPI PROGram Subsystem provides commands which allow multiple programs to be named, defined and resident in the instrument at the same time. The Test Set does not support this capability.

For complete information on the SCPI PROGram Subsystem refer to the Standard Commands for Programmable Instruments (SCPI) Standard. If you are not familiar with SCPI, it is recommended that you obtain a copy of the book: *A Beginner's Guide to SCPI* (ISBN 0-201-56350, Addison-Wesley Publishing Company).



## PROGram Subsystem

**Test Set PROGram Subsystem**

The Test Set was designed to store only one IBASIC program in RAM memory at any given time. The PROGram Subsystem commands, as implemented in the Test Set, operate differently than described in the SCPI Standard. In addition, the SCPI PROGram Subsystem commands which were designed to support multiple programs are not supported in the Test Set.

**Supported SCPI Commands**

The Test Set supports the following subset of the :SElected SCPI commands.

- :SElected:DEFine
- :SElected:DEFine?
- :SElected:DELeTe:ALL
- :SElected:EXECute
- :SElected:NUMBer
- :SElected:NUMBer?
- :SElected:STATe
- :SElected:STATe?
- :SElected:STRing
- :SElected:STRing?
- :SElected:WAIT

**Unsupported SCPI Commands**

The Test Set does not support the following SCPI commands.

- :CATalog?
- :SElected:DELeTe:SElected
- :SElected:MALLocate
- :SElected:MALLocate?
- :SElected:NAME
- :SElected:NAME?
- :EXPLicit:DEFine
- :EXPLicit:DEFine?
- :EXPLicit:DELeTe
- :EXPLicit:EXECute
- :EXPLicit:MALLocate
- :EXPLicit:MALLocate?
- :EXPLicit:NUMBer
- :EXPLicit:NUMBer?
- :EXPLicit:STATe
- :EXPLicit:STATe?
- :EXPLicit:STRing
- :EXPLicit:STRing?
- :EXPLicit:WAIT

## PROGram Subsystem

---

**NOTE:** Sending the Test Set any of the unsupported SCPI PROGram Subsystem commands can result in unexpected and/or erroneous operation of IBASIC. This may require the Test Set's RAM to be initialized from the SERVICE screen to regain proper IBASIC operation.

---

## PROGram Subsystem Commands

### Command Notation

The following notation is used in the command descriptions:

Letter case (uppercase or lowercase) is used to differentiate between the short form (the uppercase characters) and long form (the whole keyword) of the command.

The lower case letters in the keyword are optional; they can be deleted and the command will still be understood by the Test Set.

[] = Optional keyword; this is the default state, the Test Set will process the command to have the same effect whether the optional keyword is included by the programmer or not.

<> = Specific SCPI-defined parameter types. Refer to the SCPI Standard for definitions of the SCPI-defined parameter types.

{ } = One or more parameters that must be included one or more times.

| = Separator for choices for a parameter. Can be read the same as "or."

### Command Descriptions

---

**NOTE:** When a PROGram Subsystem command is sent to the Test Set through GPIB from an external controller the Test Set is put into REMOTE mode. The Test Set must be put in LOCAL mode to use the front-panel keys or to use the serial ports to input data into the IBASIC Command line.

---

**[ :SElected ]** All the commands under this keyword access the IBASIC program currently resident in the Test Set. Note that this keyword is optional in the command syntax.

### Syntax

PROGram[ :SElected ]

**:DEFine <program>** The DEFine command is used to create and download an IBASIC program into the Test Set from an external controller.

To download an IBASIC program, any currently resident IBASIC program must first be deleted using the :DELeTe:ALL command. Attempting to download a new IBASIC program while an IBASIC program is currently resident causes

**IBASIC Error: -282 Illegal program name.**

## PROGram Subsystem

**NOTE:**

It is possible for the PROGram Subsystem to think that there is an IBASIC program resident in the Test Set when, in actuality, there is not. This situation would exist for example, if an IBASIC program had been created and downloaded using the :DEFine command and then deleted, from the front panel, using the SCRATCH ALL command from the IBASIC Command line. Under this circumstance IBASIC Error -282 would be generated when another attempt is made to download a program with the PROGram Subsystem. It is recommended that the :DELete:ALL command always be sent immediately before the :DEFine command.

The IBASIC program downloaded into the Test Set must be transferred as IEEE 488.2 Arbitrary Block Program Data. Refer to the IEEE Standard 488.2-1987 for detailed information on this data type. Two syntax forms are provided with the Arbitrary Block Program Data data type: one form if the length of the program is known and another one if it is not.

**Syntax (length of program not known)**

```
PROGram[:SElected]:DEFine <#0><program><NL><END>
```

The following notation is used in the command description:

<#0> = IEEE 488.2 Arbitrary Block Program Data header.

<program> = the IBASIC program sent as 8 bit data bytes.

<NL> = new line = ASCII line-feed character.

<END> = IEEE 488.1 END message. This terminates the block transfer and is only sent once with the last byte of the indefinite block data.

**Example BASIC program to download an IBASIC program to Test Set**

```
10 OUTPUT 714;"PROG:DEL:ALL"!Delete current program
20 OUTPUT 714;"PROG:DEF #0"!Create program, send header
30 OUTPUT 714;"10 FOR J = 1 TO 10"!1st prog line
40 OUTPUT 714;"20 DISP J"!2nd prog line
50 OUTPUT 714;"30 BEEP"!3rd prog line
60 OUTPUT 714;"40 NEXT J"!4th prog line
70 OUTPUT 714;"50 END"END!Send END message at end of last line
80 END
```

## PROGram Subsystem

**Syntax (length of program known)**

```
PROGram[:SElected]:DEFine <#><number of digits in count field>
<count field: number of data bytes in program><program data bytes>
```

The following notation is used in the command description:

The data starts with a header which begins with a “#”, followed by a single non-zero digit in the range 1-9 which specifies the number of digits in the following count field, followed by a series of digits in the range of 0-9 which gives the number of data bytes being sent, followed by the number of data bytes specified by the count field.

**Example**

```
#16<data byte><data byte><data byte><data byte><data byte><data byte>
```

**Example BASIC program to download an IBASIC program to Test Set**

```
10 OUTPUT 714;"PROG:DEL:ALL"!Delete current program
20 OUTPUT 714;"PROG:DEF #257" !Create program, send header
30 OUTPUT 714;"10 FOR J = 1 TO 10"!18 characters + CR + LF
40 OUTPUT 714;"20 DISP J"!9 characters + CR + LF
50 OUTPUT 714;"30 BEEP"!7 characters + CR + LF
60 OUTPUT 714;"40 NEXT J"!9 characters + CR + LF
70 OUTPUT 714;"50 END"!6 characters
80 END
```

**:DEFine?** The :DEFine? query command is used to upload an IBASIC program from the Test Set to an external controller.

The IBASIC program uploaded to the external controller is transferred as IEEE 488.2 Definite Length Arbitrary Block Response Data. The following information describes some of the characteristics of the IEEE 488.2 Definite Length Arbitrary Block Response Data type. Refer to the IEEE Standard 488.2-1987 for detailed information on this data type.

The data starts with a header which begins with a “#”, followed by a single non-zero digit in the range 1-9 which specifies the number of digits in the following count field, followed by a series of digits in the range of 0-9 which gives the number of data bytes being sent, followed by the number of data bytes specified by the count field.

**Example**

```
#16<data byte><data byte><data byte><data byte><data byte><data byte>
```

The transfer is terminated by the transmission, from the Test Set to the external controller, of the response message terminator (NL & END message).

<NL> = new line = ASCII linefeed character.

<END> = IEEE 488.1 END message.

**Syntax**

```
PROGram[:SElected]:DEFine?
```

## PROGram Subsystem

**Example BASIC program to upload an IBASIC program from Test Set**

```

10 DIM Prog_line$(200)!Holds longest program line in Test Set
20 DIM File_name$(10)!Holds the name of file to store IBASIC program
30 LINPUT "Enter name of file to store IBASIC program in:",File_name$
40 OUTPUT 714;"PROG:DEF?"
50 ENTER 714 USING "X,D,#";Count_length !Get length of count field
60 !Get number of characters in program, includes CR/LF on each line
70 ENTER 714 USING VAL$(Count_length)&"D,#";Chars_total
80 !Create ASCII file to hold program, add 5 records for buffer
90 CREATE ASCII File_name$, (Chars_total/256)+5
100 ASSIGN @File TO File_name$
110 LOOP
120   ENTER 714;Prog_line$ !Read in one program line
130   OUTPUT @File;Prog_line$ !Store in file
140   Chars_xferd=Chars_xferd+LEN(Prog_line$)+2 !CR/LF not read
150 EXIT IF Chars_xferd>=Chars_total
160 END LOOP
170 ENTER 714;Msg_terminator$ !Terminate the block data transfer
180 ASSIGN @File TO *
190 END

```

**:DELEte:ALL** The :DELEte:ALL command is used to delete an IBASIC program in the Test Set. If the IBASIC program in the Test Set is in the RUN state, an **IBASIC Error: -284 Program currently running** error is generated and the program is not deleted.

**Syntax**

```
PROGRAM[:SElected]:DELEte:ALL
```

**Example**

```

OUTPUT 714;"PROGRAM:SElected:DELEte:ALL"
or
OUTPUT 714;"PROG:DEL:ALL"

```

**:EXECute <program\_command>** The :EXECute command is used to execute, from an external controller, an IBASIC program command in the Test Set's built-in IBASIC Controller .

<program\_command> is string data representing any legal IBASIC command. If the string data does not represent a legal IBASIC command, an **IBASIC Error: -285 Program syntax error** is generated.

Any IBASIC program in the Test Set must be in either the PAUSEd or STOPped state before the external controller issues the :EXECute <program\_command> command. If the IBASIC program is in the RUN state, an **IBASIC Error: -284 Program currently running** is generated.

## PROGram Subsystem

**Syntax**

```
PROGRAM[:SElected]:EXECute <delimiter><program_command><delimiter>
```

The following notation is used in the command description:

<delimiter> = IEEE 488.2 <string data> delimiter, single quote or double quote, must be the same.

**Example**

```
OUTPUT 714;"PROGram:SElected:EXECute 'CLEAR SCREEN' "
      or
OUTPUT 714;"PROG:EXEC 'CLEAR SCREEN' "
```

**:NUMBER <varname>{,<nvalues>}** The :NUMBER command is used to set, from an external controller, the value of numeric variables or arrays in an IBASIC program in the Test Set. <varname> is the name of an existing numeric variable or array, and can be sent as either character data (<varname> not enclosed in quotes) or string data (<varname> enclosed in quotes). <nvalues> is a list of comma-separated <numeric\_values> which are used to set the value of <varname>.

**NOTE:**

If the variable name <var\_name> is longer than 12 characters it must be sent as string data (<var\_name> enclosed in quotes). For example, OUTPUT 714;"PROG:NUMB 'Var\_name',10".

Attempting to send a <var\_name> longer than 12 characters as character data (<var\_name> *not* enclosed in quotes) will generate the following error:

**GPIB Error: -112 Program mnemonic too long.**

If an attempt is made to set the value of a numeric variable or array and no IBASIC program is in the Test Set an **IBASIC Error: -282 Illegal program name** is generated. If an attempt is made to set the value of a numeric variable or array and the numeric variable specified in <varname> does not exist in the program an **IBASIC Error: -283 Illegal variable name** is generated. If the specified numeric variable cannot hold all of the specified <numeric\_values> an **IBASIC Error: -108 Parameter not allowed** is generated.

**Syntax**

```
PROGRAM[:SElected]:NUMBER <varname>{,<nvalues>}
```

## PROGram Subsystem

**Example setting the value of a simple variable**

```
OUTPUT 714;"PROG:SElected:NUMBer Variable,15"
      or
OUTPUT 714;"PROG:NUMB Variable,15"
```

**Example setting the value of a one dimensional array [Array(5)] with 6 elements**

```
OUTPUT 714;"PROG:SElected:NUMBer Array,0,1,2,3,4,5"
      or
OUTPUT 714;"PROG:NUMB Array,0,1,2,3,4,5"
```

---

**NOTE:** Individual array elements cannot be set with the :NUMBER command.

---

**Example setting the value of a two dimensional array [Array(1,2)] with 6 elements**

```
OUTPUT 714;"PROG:SElected:NUMBer Array,0,1,2,3,4,5"
      or
OUTPUT 714;"PROG:NUMB Array,0,1,2,3,4,5"
```

*Arrays are filled by varying the right-most dimension the fastest. After executing the above statement the array values would be, Array(0,0)=0, Array(0,1)=1, Array(0,2)=2, Array(1,0)=3, Array(1,1)=4, Array(1,2)=5.*

---

**NOTE:** Individual array elements cannot be set with the :NUMBER command.

---

**:NUMBER? <varname>** The :NUMBER? query command is used to return, to an external controller, the current value of numeric variables or arrays in an IBASIC program in the Test Set. <varname> is the name of an existing numeric variable or array in the IBASIC program, and can be sent as either character data (name not enclosed in quotes) or string data (name enclosed in quotes).

---

**NOTE:** If the variable name <var\_name> is longer than 12 characters it must be sent as string data (<var\_name> enclosed in quotes). For example, OUTPUT 714;"PROG:NUMB 'Var\_name'".

Attempting to send a <var\_name> longer than 12 characters as character data (<var\_name> *not* enclosed in quotes) will generate the following error:

**GPiB Error: -112 Program mnemonic too long**

---

For simple variables the value is returned as a series of ASCII characters representing a numeric value in scientific notation (+3.000000000000E+000). For arrays the values are returned as a comma separated list of ASCII characters representing a numeric value in scientific notation. For example, +3.000000000000E+000,+3.000000000000E+000,+3.000000000000E+000, etc. Array values are sent by varying the rightmost dimension of the array the fastest.

## PROGram Subsystem

If an attempt is made to query the value of a numeric variable or array and no IBASIC program is in the Test Set an **IBASIC Error: -283 Illegal variable name** is generated. If an attempt is made to query the value of a numeric variable or array and the variable specified in <varname> does not exist in the program an **IBASIC Error: -283 Illegal variable name** is generated.

**Syntax**

```
PROGram[:SElected]:NUMBer? <varname>
```

**NOTE:**

The program commands and syntax used to enter data from the Test Set into the external controller will depend upon the programming language used in the external controller. Considerations such as type conversion (integer to real, real to complex, etc.), the sequence in which values are entered into arrays, the capability to fill an entire array with a single enter statement, etc. will depend upon the capabilities of the programming language used in the external controller. The examples which follow represent the capabilities of HP Rocky Mountain BASIC programming language running on an HP 9000/300 Series Controller.

**Example querying the value of a simple variable**

```
OUTPUT 714;"PROGram:SElected:NUMBer? Variable"
ENTER 714;Value
or
OUTPUT 714;"PROG:NUMB? Variable"
ENTER 714;Value
```

*This example assumes that the variable named Value in the ENTER statement is the same type as the variable named Variable in the IBASIC program.*

**Example querying the value of a one dimensional array [Array(5)] with 6 elements**

```
OUTPUT 714;"PROGram:SElected:NUMBer? Array"
ENTER 714;Result_array(*)
or
OUTPUT 714;"PROG:NUMB? Array"
ENTER 714;Result_array(*)
```

*This example assumes that the array named Result\_array(\*) in the ENTER statement is dimensioned exactly the same as the array named Array in the IBASIC program.*

**NOTE:**

Individual array elements cannot be queried with the :NUMBer? command.



## PROGram Subsystem

**Example querying the value of a one dimensional array whose name is known but whose current size is unknown**

```

10 DIM Temp$(5000) !This will hold 250 numbers @ 20 characters each
20 DIM Result_array(500) !This array will hold up to 501 values
30 OUTPUT 714;"PROG:NUMB? Array" !Query the desired array
40 ENTER 714;Temp$ !Enter the values into a temporary string variable
50 N=-1 !Initialize array pointer, assume option base 0
60 REPEAT !Start loop to take values from string and put in array
70 N=N+1 !Increment array pointer
80 Pos_comma=POS(Temp$,",") !Find comma separator
90 Result_array(N)=VAL(Temp$[1,Pos_comma-1]) !Put value into array
100 Temp$=Temp$[Pos_comma+1] !Remove value from temporary string
110 UNTIL POS(Temp$,",")=0 !Check for last value in temporary string
120 Result_array(N+1)=VAL(Temp$) !Put last value into array
130 END

```

*The above example assumes that the dimensioned size of the IBASIC array is smaller than the dimensioned size of the array named Result\_array.*

**NOTE:** Individual array elements cannot be queried with the :NUMBer? command.

**:STATe RUN|PAUSE|STOP|CONTINUE** The STATe command is used to set, from an external controller, the execution state of the IBASIC program in the Test Set. **Table 33** defines the effect of setting the execution state of the IBASIC program to a desired state from each of the possible current states.

**Table 33** Effect of STATe Commands

| Desired State of<br>IBASIC Program<br>(STATe command sent<br>to Test Set) | Current State of IBASIC Program       |         |                                       |
|---|---------------------------------------|---------|---------------------------------------|
|   | RUNNING                               | PAUSED  | STOPPED                               |
| RUN   | GPIB Error: -221<br>Settings conflict | RUNNING | RUNNING                               |
| CONT  | GPIB Error: -221<br>Settings conflict | RUNNING | GPIB Error: -221<br>Settings conflict |
| PAUSE   | PAUSED                                | PAUSED  | STOPPED                               |
| STOP  | STOPPED                               | STOPPED | STOPPED                               |

## PROGram Subsystem

The program execution states are defined as follows:

- **RUNNING**, the program is currently executing.
- **PAUSED**, the program has reached a break in execution but can be continued.
- **STOPPED**, program execution has been terminated.

**Syntax**

```
PROGram[:SElected]:STATe RUN|PAUSE|STOP|CONTINUE
```

**Example**

```
OUTPUT 714;"PROGram:SElected:STATe RUN"
      or
OUTPUT 714;"PROG:STAT RUN"
```

**:STATe?** The **STATe?** query command is used to query, from an external controller, the current execution state of the IBASIC program in the Test Set. The return data (RUN, STOP, or PAUS) is sent as a series of ASCII characters.

The program execution states are defined as follows:

- **RUN**, the program is currently executing.
- **PAUS**, the program has reached a break in execution but can be continued.
- **STOP**, program execution has been terminated.

**Syntax**

```
PROGram[:SElected]:STATe?
```

**Example**

```
OUTPUT 714;"PROGram:SElected:STATe?"
ENTER 714;State$
      or
OUTPUT 714;"PROG:STAT?"
ENTER 714;State$
```

**:STRING <varname>{,<svalues>}** The **:STRING** command is used to set, from an external controller, the value of string variables or string arrays in an IBASIC program in the Test Set. <varname> is the name of an existing string variable or string array in the IBASIC program. <svalues> is a list of comma-separated quoted strings which are used to set the value of <varname>.

## PROGram Subsystem

---

**NOTE:** If the variable name <var\_name> is longer than 12 characters it must be sent as string data (<var\_name> enclosed in quotes). For example, OUTPUT 714;"PROG:STR 'Var\_name','data'".

Attempting to send a <var\_name> longer than 12 characters as character data (<var\_name> *not* enclosed in quotes) will generate the following error:

---

**NOTE:**  **GPIB Error: -112 Program mnemonic too long.**

If the programmer wishes to append the IBASIC "\$" string identifier onto the string variable name, the string variable name must be sent as string data, that is enclosed in quotes. For example,

OUTPUT 714;"PROG:STR 'Var\_name\$','data'"

Appending the IBASIC "\$" string identifier onto the string variable name without enclosing the string variable name in quotes will generate

**GPIB Error: -101 Invalid character.**

---

If an attempt is made to set the value of a string variable or array and no IBASIC program is in the Test Set an **IBASIC Error: -282 illegal program name** is generated. If an attempt is made to set the value of a string variable or array and the string variable specified in <varname> does not exist in the program an **IBASIC Error: -283 Illegal variable name** is generated. If a quoted string value is too long to fit into the string variable then it is silently truncated when stored into the IBASIC string variable. If the specified string variable cannot hold all of the quoted strings an **IBASIC Error: -108 Parameter not allowed** is generated.

**Syntax**

```
PROGRAM[:SElected]:STRing <varname>{,<svalues>}
```

**Example setting the value of a simple string variable**

```
OUTPUT 714;"PROG:SElected:STRing Variable,'data' "
      or
OUTPUT 714;"PROG:STR Variable,'data' "
```

**Example of setting the value of a string array with 3 elements of 5 characters each, such as Array\$(2)[5]**

```
OUTPUT 714;"PROG:SElected:STRing Array,'12345','12345','12345' "
      or
OUTPUT 714;"PROG:STR Array,'12345','12345','12345' "
```

*Note: With Option Base 0 set in IBASIC, array indexing starts at 0.*

## PROGram Subsystem

**:STRing? <varname>** The :STRing? query command is used to return, to an external controller, the current value of string variables or arrays in an IBASIC program in the Test Set. <varname> is the name of an existing string variable or string array in the IBASIC program.

---

**NOTE:** If the variable name <var\_name> is longer than 12 characters it must be sent as string data (<var\_name> enclosed in quotes). For example, OUTPUT 714;"PROG:STR? 'Var\_name'".

Attempting to send a <var\_name> longer than 12 characters as character data (<var\_name> *not* enclosed in quotes) will generate the following error:

**GPiB Error: -112 Program mnemonic too long**

If the programmer wishes to append the IBASIC '\$' string identifier onto the string variable name, the string variable name must be sent as string data, that is enclosed in quotes. For example,

OUTPUT 714;"PROG:STR? 'Var\_name\$'"

Appending the IBASIC '\$' string identifier onto the string variable name without enclosing the string variable name in quotes will generate the following error

**GPiB Error: -101 Invalid character**

---

For simple string variables the value is returned as a quoted string ("This is an example."). For string arrays the values are returned as a comma separated list of quoted strings ("This is an example.," "This is an example."). The string array elements are returned in ascending order (Array\$(0), Array\$(1), Array\$(2), etc.).

If an attempt is made to query the value of a string variable or array and no IBASIC program is in the Test Set an **IBASIC Error: -283 Illegal variable name** is generated. If an attempt is made to query the value of a string variable or array and the string variable specified in <varname> does not exist in the program an **IBASIC Error: -283 Illegal variable name** is generated.

### Syntax

PROGram[:SElected]:STRing? <varname>

---

**NOTE:** The program commands and syntax used to enter string data from the Test Set into the external controller will depend upon the programming language used in the external controller. The examples which follow represent the capabilities of HP Rocky Mountain BASIC programming language running on an HP 9000/300 Series Controller.

---

## PROGram Subsystem

**Example of querying the value of a simple string variable**

```

OUTPUT 714;"PROG:SElected:STRing? Variable"
ENTER 714;Value$
or
OUTPUT 714;"PROG:STR? Variable"
ENTER 714;Value$

```

**Example of querying the value of a string array with 3 elements of 5 characters each, such as Array\$(2)[5]**

```

OUTPUT 714;"PROG:SElected:STRing? Array"
ENTER 714 USING "3(X,5A,2X)";Result_array$(*)
or
OUTPUT 714;"PROG:STR? Array"
ENTER 714 USING "3(X,5A,2X)";Result_array$(*)

```

*This example assumes that the string array named Result\_array\$(\*) is dimensioned exactly the same as the array named Array in the IBASIC program and that each element in the string array Array has five characters in it.*

**Example of querying the value of a string array whose name is known but whose current size is unknown**

```

05 OPTION BASE 1
10 DIM Temp$(5000) !This will hold 5000 characters
20 DIM Temp_array$(50)[200]!Temp array: 50 elements of 200 character
30 OUTPUT 714;"PROG:STR? Array" !Query the desired array
40 ENTER 714;Temp$ !Enter the values into a temporary string variable
50 N=0 !Initialize array pointer
60 REPEAT !Start loop to take values from string and put in array
70 N=N+1 !Increment array pointer
80 Pos_comma=POS(Temp$,",") !Find comma separator
90 Temp_array$(N)=Temp$[2,Pos_comma-2] !Put value into array
100 Temp$=Temp$[Pos_comma+1] !Remove value from temporary string
110 UNTIL POS(Temp$,",")=0 !Check for last value in temporary string
120 Temp_array$(N+1)=Temp$[2,LEN(Temp$)-1]!Put last value in array
130 END

```

*The above example assumes that the total number of characters in the dimensioned size of the IBASIC string array named Array is smaller than the dimensioned size of the string variable named Temp\$. Also, the maximum length of any element in the IBASIC string array Array must be less than or equal to 200 characters.*

**:WAIT** The :WAIT command stops the Test Set from executing any commands or queries received through GPIB until after the IBASIC program exits the RUN state; that is, the program is either PAUSED or STOPPED.

## PROGram Subsystem

---

**CAUTION:** The Test Set will continue to process GPIB commands into the GPIB input buffer up to the point that the buffer is full. If the external controller attempts to send more commands than can fit into the GPIB input buffer before the IBASIC program is PAUSED or STOPPED, the GPIB bus will appear to be locked up. This is due to the fact that the GPIB bus and the external controller will be in a temporary holdoff state while waiting for the GPIB input buffer to empty.

If a query command is sent to the Test Set while the IBASIC program is under the influence of a :WAIT command, no data will be put into the Test Set's Output Queue until the IBASIC program is either PAUSED or STOPPED. If the external controller attempts to enter the queried data before the IBASIC program is PAUSED or STOPPED, the GPIB bus will appear to be locked up. This is due to the fact that the GPIB bus and the external controller will be in a temporary holdoff state while waiting for the data to be put into the Output queue to satisfy the enter command.

---

**Syntax**

```
PROGram[ :SElected ]:WAIT
```

**Example**

```
OUTPUT 714; "PROG:SElected:WAIT"
      or
OUTPUT 714; "PROG:WAIT"
```

**:WAIT?** The :WAIT? query command stops the Test Set from executing any commands or queries received through GPIB until after the IBASIC program exits the RUN state, that is - the program is either PAUSED or STOPPED. A 1 is returned in response to the :WAIT? query command when the IBASIC program is either stopped or paused.

---

**CAUTION:** When the :WAIT? query command is sent to the Test Set the program running on the external controller will hang on the enter or input statement until the IBASIC program is either STOPPED or PAUSED. This is due to the fact that the GPIB bus and the external controller will be in a temporary holdoff state while waiting for the Test Set to put a 1 into the Output queue to satisfy the :WAIT? query command.

---

## PROGram Subsystem

**Syntax**

```
PROGram[:SElected]:WAIT?
```

**Example**

```
OUTPUT 714;"PROGram:SElected:WAIT?"
ENTER 714;Dummy
      or
OUTPUT 714;"PROG:WAIT?"
ENTER 714;Dummy
```

Consider the following example where the user wishes to determine, from an external controller, if the IBASIC program running on the Test Set has finished executing. The example programs show how this might be accomplished with and without using the :WAIT? query command.

**Example BASIC program without using the :WAIT? query command**

```
10 OUTPUT 714;"PROG:STAT RUN"
20 LOOP
30 OUTPUT 714;"PROG:STAT?"
40 ENTER 714;State$
50 EXIT IF State$="STOP" OR State$="PAUS"
60 END LOOP
70 DISP "IBASIC program not running."
80 END
```

**Example BASIC program using the :WAIT? query command**

```
10 OUTPUT 714;"PROG:STAT RUN"
20 OUTPUT 714;"PROG:WAIT?"
30 ENTER 714;Dummy !Program will hang here until IBASIC program stops
40 DISP "IBASIC program not running."
50 END
```

## PROGram Subsystem

**Using the EXECute Command**

The PROGram:EXECute command can be used to list, edit and control IBASIC programs in the Test Set from an external controller. This eliminates having to use the cursor control knob and provides a more efficient way of making small changes to programs. The full range of IBASIC program commands can be executed from an external controller using the PROGram:EXECute command.

The following operations are given as typical examples of using the PROGram:EXECute command.

**NOTE:**

The program commands and syntax used to send data from the external controller to the Test Set will depend upon the programming language used in the external controller. The examples which follow represent the capabilities of HP Rocky Mountain BASIC programming language running on an HP 9000/300 Series Controller.

When a PROGram Subsystem command is sent to the Test Set through GPIB from an external controller the Test Set is put into REMOTE mode. The Test Set must be put in LOCAL mode to use the front panel keys or to use the serial ports to input data into the IBASIC Command line.

**Entering a new IBASIC program line**

IBASIC program lines can be entered directly into the Test Set's RAM memory, one line at a time, from an external controller using the PROGram:EXECute command as follows:

```
PROG:EXEC '<new program line number/program line>'
```

where <new program line number/program line> represents a valid IBASIC program line.

For example, to enter the following new program line into the Test Set,

```
20 A=3.14
```

execute the following command from the external controller:

```
OUTPUT 714;"PROG:EXEC '20 A=3.14' "
```

Quoted strings, such as those used in PRINT commands, must use double quotes. For example,

```
OUTPUT 714;"PROG:EXEC '30 PRINT ""TEST""' "
```



## PROGram Subsystem

### Editing an existing IBASIC program line

Existing IBASIC program lines which are resident in the Test Set's RAM memory can be edited, one line at a time, from an external controller using the PROG:EXECute command as follows:

```
PROG:EXEC '<existing program line number/modified program line>'
```

where <existing program line number/modified program line> represents an existing IBASIC program line.

For example, to edit the following existing program line in the Test Set.

```
30 OUTPUT 814;"AFAN:DEMP:GAIN 20 dB"
```

*to*

```
30 OUTPUT 814;"AFAN:DEMP:GAIN 10 dB"
```

execute the following command from the external controller:

```
OUTPUT 714;"PROG:EXEC '30 OUTPUT 814;"AFAN:DEMP:GAIN 10 dB"'"
```

Quoted strings, such as those used in OUTPUT commands, must use double quotes.

### Listing A Program

Execute the following command on the external controller to list an IBASIC program which is resident in the Test Set to the currently specified IBASIC Controller LIST device.

```
OUTPUT 714;"PROG:EXEC 'LIST'"
```

## PROGram Subsystem

**Downloading An IBASIC Program Into the Test Set**

The following procedure uses the PROGram Subsystem commands to transfer an IBASIC program, which is resident in the memory of the external controller, from the external controller to the Test Set. This procedure assumes the Test Set's GPIB address is set to 14. The example also assumes the external controller is an HP 9000 Series 300 Controller.

1. Access the Test Set's TESTS (IBASIC Controller) screen.
2. Enter a program into the external controller. Use the sample program below if no program is available. When run, the sample program clears the Test Set's IBASIC Controller display area, and prints a message indicating that the download procedure worked.

```
10  !THIS IS A SAMPLE PROGRAM
20  CLEAR SCREEN
30  PRINT "DOWNLOADING COMPLETED"
40  END
```

3. Execute the following commands on the external controller:

```
OUTPUT 714;"PROG:DEL:ALL"
OUTPUT 714;"PROG:DEF #0"
LIST #714
OUTPUT 714;" "END
```

4. To verify that the program was downloaded, execute the following commands from the external controller:

```
OUTPUT 714;"PROG:EXEC 'LIST' "
```

The program should be listed on the Test Set's TESTS (IBASIC Controller) screen.

5. Run the program on the Test Set by first selecting the LOCAL key on the front panel of the Test Set and then selecting the **Run** key on the Test Set's TESTS (IBASIC Controller) screen.

## PROGram Subsystem

**Uploading a Program From the Test Set**

The following BASIC program copies an IBASIC program from the Test Set's IBASIC Controller RAM to the external controller and then stores it to a file on the external controller's currently assigned mass storage device.

When the upload program is entered and run on the external controller, the operator is prompted for the name of the file to store the IBASIC program in. As the upload program is running, the total number of characters in the program, and the number of characters transferred, are displayed.

```

10 !Upload an IBASIC program in Test Set to an external controller.
20 DIM Prog_line$(200) !Holds longest program line in Test Set
30 DIM File_name$(10) !Holds the name of file to store IBASIC program
40 Addr=714 !Test Set GPIB address
50 LINPUT "Enter name of file to store IBASIC program in:",File_name$
60 OUTPUT Addr;"PROG:DEF?"
70 ENTER Addr USING "X,D,#";Count_length !Get length of count field
80 !Get number of characters in program, includes CR/LF on each line
90 ENTER Addr USING VAL$(Count_length)&"D,#";Chars_total
100 !Create ASCII file to hold program, add 5 records for buffer
110 CREATE ASCII File_name$, (Chars_total/256)+5
120 ASSIGN @File TO File_name$
130 LOOP
140     ENTER Addr;Prog_line$ !Read in one program line
150     OUTPUT @File;Prog_line$ !Store in file
160     Chars_xferd=Chars_xferd+LEN(Prog_line$)+2 !CR/LF not read
170     DISP Chars_xferd;"of";Chars_total;"characters transferred."
180 EXIT IF Chars_xferd>=Chars_total
190 END LOOP
200 ENTER Addr;Msg_terminator$ !Terminate the block data transfer
210 ASSIGN @File TO * !Close the file
220 END

```

### Saving an IBASIC Program To A Memory Card

The following procedure can be used to save an IBASIC program from the IBASIC Controller's RAM memory to a memory card inserted into the front panel of the Test Set.

1. Press LOCAL, SHIFT, CANCEL on the Test Set to perform an IBASIC reset.
2. If the memory card has not been initialized, insert it into the Test Set and execute the following command on the external controller:

```
OUTPUT 714;"PROG:EXEC 'INITIALIZE" "DOS:INTERNAL,4" "' "
```

3. Insert the initialized memory card into the Test Set.
4. Define the memory card as the Mass Storage device by executing the following command on the external controller:

```
OUTPUT 714;"PROG:EXEC 'MSI " ":INTERNAL,4" "' "
```

5. Save the program to the memory card by executing the following command on the external controller:

```
OUTPUT 714;"PROG:EXEC 'SAVE " "<filename>" "' "
```

---

## The TESTS Subsystem

The Test Set makes available to the user an automated user-interface which has been specifically designed for radio test. One of the primary problems associated with automated radio testing is the need to rapidly configure the software with the information needed to test a specific type of radio. Information such as, test frequencies/channels, test specifications, test parameters, test conditions and pass/fail limits. Most often the test(s) and test procedure(s) used to test a class of radio (AM, FM, AMPS, TACS, TDMA, CDMA, etc.) are defined by an industry standard and are used to test all radio types within that class. However, for a specific radio type, the test(s) may remain the same but the information needed to test the radio changes. For example, a portable hand-held may have different transmit power levels than a mobile - the RF power test is the same but the power levels, supply voltages, pass/fail limits etc. can be different.

There are two approaches which can be used to provide the software with the information needed to test a radio: a) hardcode the information directly into the software, or b) store the information outside the program code itself and make it available to the software as needed. Hardcoding the information into the software has several serious drawbacks: changing the information is difficult and the software becomes specific to that radio type. Storing the information outside the program code and making it available to the software as needed overcomes both of these problems, that is - the information is easy to change and the software is not specific to a particular type of radio.

The Test Set's automated user-interface was designed using this approach. Hewlett-Packard has developed software specifically designed to run on the Test Set. The Agilent 83217 Software provides the user with a library of industry standard tests. All radio specific information has been removed from the software. The information needed to test a specific type of radio is available to the user through the TESTS Subsystem. To generate, change and maintain this radio specific information the TESTS Subsystem provides menu driven input screens to define specifications, parameters, test sequencing and system configuration for a particular radio type.

## TESTS Subsystem File Descriptions

Three types of files are used in the TESTS Subsystem to store different types of information.

### Code Files

The first aspect of an automated definition is the code itself. This is just a standard IBASIC Code file that can reside either on the Memory card, on an external disk drive connected to the GPIB port of the Test Set, or in an internal RAM disk. The name of this file is appended with .PGM file extension. This tells the TESTS Subsystem that this particular file contains program code.

### Library Files

A Library indicates all of the available test subroutines in the code, the set of all parameters that might be entered using the user-interface screens, and all specifications that might be used by the subroutines in the code to decide if a test point passes or fails.

Only one Library is defined for each Code file. The name of this file is appended with a .LIB file extension, telling the TESTS system that this is a Library file. Also, both the Library and Code file should have the same base name to indicate the relationship between them.

A Library is required to use the user-interface screen functions of the TESTS Subsystem. If the program is simple enough that there is no need for user-input, or if all the user-input is simple enough to be accomplished with INPUT statements, a [NO LIB] option is available.

### Procedure Files

A Procedure allows the user to define which of the test subroutines, parameters, and specifications defined in the Library will be used to test a specific Radio. There may be many Procedures defined that use the same IBASIC Code and Library, each using a different subset of the choices available in the Library. These files are appended with a .PRC file extension, but are *not* required to have the same base name as either the Library or the Code. The name of the corresponding Library (if any) is stored in each Procedure file.

The TESTS Subsystem

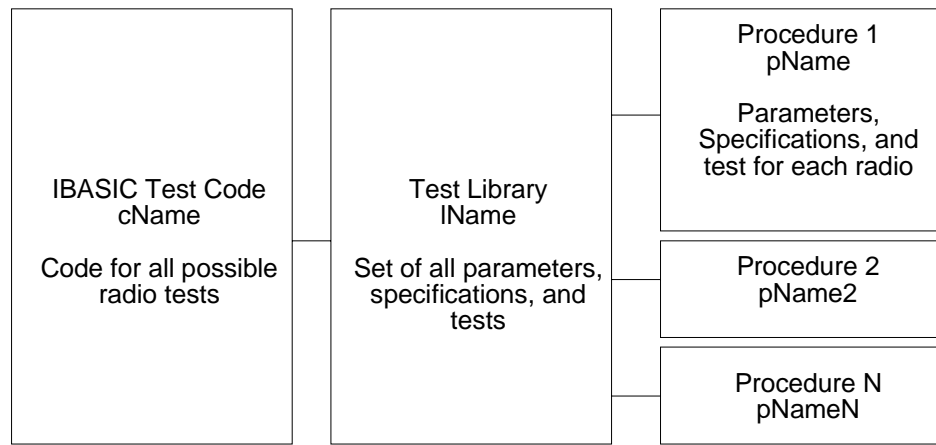

ch6drw06.drw

**Figure 40** TESTS Subsystem File Relationship

## The TESTS Subsystem

## TESTS Subsystem Screens

The TESTS Subsystem uses several screens to create, select, and copy files, and to run tests.

## The TESTS (Main Menu) Subsystem Screen

The TESTS (Main Menu) screen is accessed by pressing the front panel TESTS key. Test procedures are selected and run from this screen. Additionally, access to all other TESTS Subsystem screens is accomplished from this screen.

| TESTS (Main Menu)  |                       |
|--|-----------------------|
| Please select a procedure to load.                       |                       |
|  | 1 Run Test            |
|  | 2 Continue            |
| <u>LOAD TEST PROCEDURE:</u>                              |                       |
| Select Procedure Location:                               | 4 Help                |
| Card   |                       |
| Select Procedure Filename:    Library:    Program:       |                       |
| ██████████   |                       |
| Description:   |                       |
| <u>CUSTOMIZE TEST PROCEDURE:</u> <u>SET UP TEST SET:</u> |                       |
| Freq Channel Information                                 | Exec Execution Cond   |
| Parm Test Parameters                                     | Cnfg External Devices |
| Seqn Order of Tests                                      | Print Printer Setup   |
| Spec Pass/Fail Limits                                    | IBASIC IBASIC Cntrl   |
| Proc Save/Delete Procedure                               |                       |
|  | To Screen             |
|  | RF GEN                |
|  | RF ANL                |
|  | AF ANL                |
|  | SCOPE                 |
|  | SPEC ANL              |
|  | ENCODER               |
|  | DECODER               |
|  | RADIO INT             |
|  | More                  |

ch6dhw7.drw

Figure 41 The TESTS (Main Menu) Subsystem Screen

The **Select Procedure Location:** field is used to select the mass storage location for the procedure to be loaded. The **Select Procedure Filename:** field is used to select the name of the procedure to be loaded. The **Description:** field gives the user a brief description of the procedure currently selected in the **Select Procedure Filename:** field.

To view all the Procedures available on the mass storage location currently selected in the **Select Procedure Location:** field, position the cursor on the **Select Procedure Filename:** field and push the rotary knob. A menu will appear in the lower right corner of the screen, displaying all the procedure files which are available. This is not a listing of the full contents of the selected mass storage location, it is only a list of the procedures files that are stored on that media.



## The TESTS Subsystem

### TESTS Subsystem User-Interface Screens

The TESTS Subsystem allows the user to easily modify the test subroutines, parameters, specifications and configuration to correspond to the requirements of a specific radio. There are several user-interface screens provided to allow the user to make modifications.

To access any of these screens, position the cursor on the desired field and push the rotary knob.

- The *Order of Tests* screen lets the user select the desired test(s) from the full set of available tests in the loaded procedure file.
- The *Channel Information* screen defines the transmit and receive frequencies used for the selected tests.
- The *Pass/Fail Limits* screen defines the specifications used to generate pass/fail messages during testing.
- The *Test Parameters* screen is used to define instrument settings and characteristics to match those of the radio being tested (audio load impedance, audio power, power supply voltage, etc.).
- The *External Devices* screen identifies all connected GPIB equipped instruments and their GPIB addresses.
- The *Save/Delete Procedure* screen is used to save or delete Procedures.
- The *Printer Setup* screen is used to select the printer used for IBASIC PRINT commands and to configure the format of the printer page.
- The *Execution Cond* screen is used to configure the IBASIC program execution conditions.
- The *IBASIC Cntrl* screen is the IBASIC Controllers display screen.

Refer to the TESTS Screen chapter for descriptions in the *Agilent 8924C Reference Guide* for information concerning how the different TESTS Subsystem screens are used.

The use of the *IBASIC Controller* screen is described in the beginning of this chapter.

---

**A**

## **Error Messages**

This chapter will familiarize you with the different types of error messages the Test Set provided, and will explain the meaning of error messages that require explanation.

## General Information About Error Messages

Information concerning error messages displayed by the Test Set may be found in one of the following manuals:

- This section
- The *HP Instrument BASIC Users Handbook Version 2.0* (HP P/N E2083-90005)

The format of the displayed message determines which manual contains information about the error message. There are four basic error message formats:

- Positive numbered error messages
- IBASIC error messages
- GPIB error messages
- Text only error messages

---

## Positive Numbered Error Messages

Positive numbered error messages are generally associated with IBASIC. Refer to the *HP Instrument BASIC User's Handbook* for information on IBASIC error messages.

Positive numbered error messages take the form: **ERROR XX Message Text**

For example:

- **Error 54 Duplicate file name**
- or
- **Error 80 in 632 Medium changed or not in drive**

## IBASIC Error Messages

IBASIC Error Messages are associated with IBASIC operation. IBASIC error messages can have both positive and negative numbers. Refer to the *HP Instrument BASIC User's Handbook* for information on positive numbered error messages. Refer to "**GPIB Error Messages**" on page 311 for information on negative numbered error messages (the error message associated with a negative number is the same for GPIB errors and IBASIC errors).

IBASIC error messages take the form: **IBASIC Error: -XX Message Text**

For example:

- **IBASIC Error: -286 Program runtime error**

---

## GPIB Error Messages

Most GPIB errors occur when the control program attempts to query a measurement that is not currently available, or tries to access an instrument connected to the external GPIB without configuring the Test Set as the System Controller. When diagnosing the cause of an error condition check for these conditions first.

Refer to "**Text Only GPIB Error Descriptions**" on page 316 or "**Numbered GPIB Error Descriptions**" on page 318 for a list of some of the common error messages.

GPIB error messages take the form:**GPIB Error: -XX Message Text** or  
**GPIB Error: Message Text**

For example:

**GPIB Error: -410 Query INTERRUPTED.**

or

**GPIB Error: Input value out of range.**

## Text Only Error Messages

Text only error messages are generally associated with manual operation of the Test Set. See "**The Message Display**" on page 313 for more information about messages displayed on the Test Set's display.

Un-numbered (text only) GPIB error messages are generally self-explanatory. For example, trying to retrieve a saved register that does not exist generates the following error message:

**GPIB Error: Register does not exist.**

Text only error messages can also be displayed while running the Test Set's built-in diagnostic or calibration utility programs.

Text only error messages take the form: **This is an error message.**

For example:

- **Input value out of range.**

---

## The Message Display

During instrument operation, various messages may appear on the Test Set's display. Prompt-type messages generally appear on the first line of the Test Set's display. General operating and error messages usually appear on the second line of the display. Some messages are persistent; they remain displayed, pending correction of the error condition, or until another persistent message with greater priority occurs. Other messages are only displayed when the error first occurs; they are removed when a key is pressed or the knob is turned, or when an GPIB command is received. Many of the messages are displayed on the MESSAGE screen until the instrument is turned off.

Messages that are about error conditions may tell you what to do to correct the error (turn something off, reduce a field's value, press a certain key, and so forth). Messages and prompts are sometimes accompanied by a beep or warble.

---

**NOTE:****Warbles and Beeps**

A warble sound indicates that an instrument-damaging event is occurring. Beeps often occur only with the first occurrence of the message. Prompts are generally silent.

---



---

## Non-Recoverable Firmware Error

This error, also referred to as an “assert” occurs when the Test Set encounters a condition that the firmware cannot proceed from - causing the Test Set to halt operation until power is cycled. The message appears in the center of the Test Set’s display and (except for the two lines in the second paragraph) has the form:

```
Non-recoverable firmware error. Please record the 2 lines of
text below and contact Hewlett Packard through your local
service center. In the U.S., you may call the factory at
(800) 827-3848.
```

```
'Address error exception'
at line number 0
```

To continue operation, turn POWER off and back on.

Unfortunately, you will not be able to recover from this condition without turning the Test Set off. If the failure reoccurs when you attempt to repeat the operation that caused the failure in the first place, you should record exactly what the configuration of the instrument was when the error appeared, and contact Agilent. This information will help us determine the proper course of action for your repair.

### If The Non-Recoverable Firmware Error Occurs at Power-up

If the Test Set displays this error when first powered up, disabling Test Set operation, it could be related to the **Autostart** field on the main TESTS screen, or a POWERON Save/Recall register. This field causes the Test Set to automatically run the last program loaded in memory when the Test Set is powered up. If the program is corrupted, the Test Set will automatically “lock up”.

The only way to recover from this condition is to clear the Test Set’s operating RAM. This will clear any IBASIC program, Save/Recall registers, and RAM disks that have been saved, as well as three calibration factors. The calibration factors are easily re-entered; the IBASIC programs, Save/Recall registers, and RAM disks must be re-loaded or re-initialized after clearing memory.

#### To Clear the Test Set’s RAM:

1. Turn the Test Set off.
2. Hold the PRESET and HZ/uV buttons down.
3. Turn the power on (with the buttons still held down) and wait until the CDMA CALL CONTROL screen is displayed.

## Re-enter the Calibration Factors Erased when RAM is Cleared

Use this procedure to re-enter the three calibration factors that were erased when RAM is cleared. Use the ANLG SCRNS keys (to the left of the cursor control knob) to access the required screens.

1. Access the RF GENERATOR screen and select the **DC FM Zero** field (under **FM Coupling**).
2. Disconnect any cables to the ANT IN or RF IN/OUT connectors.
3. Access the TX TEST screen and select **Zero** under the **TX Pwr Zero** field.
4. Access the AF ANALYZER screen and select **Zero** under the **DC Current** field.

---

## Text Only GPIB Error Descriptions

The following list contains a subset of the Test Set's text only GPIB error messages. These messages represent error conditions which may require explanation in addition to the error message text.

### **GPIB Error during Procedure catalog. Check Config.**

This error occurs when the Test Set fails to access an external GPIB disk drive when trying to obtain a catalog of procedure files. This would occur when the **Select Procedure Location:** field on the TESTS (Main Menu) screen is set to **Disk** and the operator then tries to select a procedure filename using the **Select Procedure Filename:** field. Ensure that the **Mode** field on the I/O CONFIGURE screen is set to **Control** and that the **External Disk Specification** field on the TESTS (External Devices) screen has the correct mass storage volume specifier for the external disk drive.

### **GPIB Query Error. Check instrument state.**

This message usually appears when the control program queries a measurement that is not currently available (on the currently displayed screen and in the ON state), such as querying the TX Frequency measurement when **TX Freq Error** is displayed. This message may also be immediately followed by the message,  
**GPIB Error: -420: Query UNTERMINATED.**

### **GPIB Error: Not Enough Memory Available for Save.**

This message will be generated when the control program tries to save the current Test Set state into a Save/Recall register using the REG:SAVE commands, but there is insufficient memory available in the Test Set. The Test Set's non-volatile RAM is shared by the following resources:

- IBASIC programs
- Save/Recall registers
- RAM Disk

In order to save the current Test Set state into a Save/Recall register more non-volatile RAM will have to be made available. This can be done by,

- reducing the size of the IBASIC program
- deleting one or more existing Save/Recall registers
- recovering RAM Disk space

The ROM Disk utility RAM\_USAGE will display the total amount of non-volatile RAM installed in the Test Set, the RAM Disk allocation, the Save/Recall register allocation and the amount of non-volatile RAM available to IBASIC.

**GPIB Error: Unknown Save/Recall error.**

This error can occur when you are trying to SAVE the instrument state to a mass storage device with a LIF formatted media. The default file system is DOS. Refer to **chapter 5, "Memory Cards/Mass Storage"** for more information.

**GPIB Error: GPIB Units cause invalid conversion of attr.**

This error is generated when trying to change Attribute Units and one of the Data Function values is set to zero. If this error is encountered the programmer must change the Data Function settings to values that can be converted to the new units\_of\_measure. Refer to **"To Specify Units-of-Measure for GPIB Data Transfer" on page 56** for more details.

---

## Numbered GPIB Error Descriptions

The following GPIB errors can be generated under any of the following conditions:

- controlling the Test Set with an IBASIC program running on the built-in IBASIC controller
- controlling GPIB devices/instruments, connected to the Test Set's external GPIB bus, with an IBASIC program running on the built-in IBASIC controller
- controlling the Test Set with a program running on an external controller
- using the Test Set manually to print to an external GPIB printer
- using the Test Set manually to access procedure/library/code files stored on an external GPIB disk

The negative numbers which precede the error message text correspond to the error conditions outlined in the Standard Commands for Programmable Instruments (SCPI). For more information on SCPI, order the following book,

*A Beginner's Guide to SCPI* Addison-Wesley Publishing Company ISBN 0-201-56350-9  
HP P/N 5010-7166

---

**NOTE:**

---

**GPIB Parser.** The term "Parser" is used in the following error message descriptions. It refers to the Test Set's GPIB command parser.

Error -100

**Command error**

This code indicates only that a Command Error as defined in *IEEE 488.2, 11.5.1.1.4* has occurred.

Error -101

**Invalid character**

A syntactic element contains a character which is invalid for that type.

Error -102

**Syntax error**

An unrecognized command or data type was encountered; for example, a string value was received when the *device* does not accept strings.

|            |   |
|------------|---|
| Error –103 | <b>Invalid separator</b> <p>The parser was expecting a separator and encountered an illegal character. For example, the colon used to separate the <code>FREQ</code> and <code>AMPL</code> commands should be omitted in the following command:</p> <pre>RFG:FREQ 850 MHZ;;AMPL -35</pre> |
| Error –104 | <b>Data type error</b> <p>The parser recognized a data element different than one allowed. For example, numeric or string data was expected but block data was encountered.</p>   |
| Error –105 | <b>GET not allowed</b> <p>A Group Execute Trigger was received within a program message (see <i>IEEE 488.2, 7.7</i>).</p>   |
| Error –108 | <b>Parameter not allowed</b> <p>More parameters were received than expected for the header. For example, the <code>*ESE</code> common command only accepts one parameter; receiving <code>*ESE 36,1</code> is not allowed.</p>  |
| Error –109 | <b>Missing parameter</b> <p>Fewer parameters were received than required for the header. For example, the <code>*ESE</code> common command requires one parameter; receiving <code>*ESE</code> is not allowed.</p>  |
| Error –110 | <b>Command header error</b> <p>An error was detected in the header.</p>   |
| Error –111 | <b>Header separator error</b> <p>A character which is not a legal header separator was encountered while parsing the header.</p>  |
| Error –112 | <b>Program mnemonic too long</b> <p>The header contains more than twelve characters (see <i>IEEE 488.2,7.6.1.4</i>).</p>  |
| Error –113 | <b>Undefined header</b> <p>The header is syntactically correct, but it is undefined for this specific <i>device</i>. For example, <code>*XYZ</code> is not defined for any <i>device</i>.</p>   |

|            |  |
|------------|--|
| Error –114 | <b>Header suffix out of range</b><br><br>Indicates that a nonheader character has been encountered in what the parser expects is a header element.   |
| Error –120 | <b>Numeric data error</b><br><br>This error, as well as errors –121 through –128, are generated when parsing a data element which appears to be numeric, including the nondecimal numeric types. |
| Error –121 | <b>Invalid character in number</b><br><br>An invalid character for the data type being parsed was encountered. For example, an alpha in a decimal numeric or a “9” in octal data.                |
| Error –123 | <b>Exponent too large</b><br><br>The magnitude of the exponent was larger than 32000 (see <i>IEEE 488.2, 7.7.2.4.1</i> ).  |
| Error –124 | <b>Too many digits</b><br><br>The mantissa of a decimal numeric data element contained more than 255 digits excluding leading zeros (see <i>IEEE 488.2, 7.7.2.4.1</i> ).                         |
| Error –128 | <b>Numeric data not allowed</b><br><br>A legal numeric data element was received, but the <i>device</i> does not accept one in this position for the header.                                     |
| Error –130 | <b>Suffix error</b><br><br>This error, as well as errors –131 through –138, are generated when parsing a suffix.   |
| Error –131 | <b>Invalid suffix</b><br><br>The suffix does not follow the syntax described in <i>IEEE 488.2 7.7.3.2</i> , or the suffix is inappropriate for this <i>device</i> .                              |
| Error –134 | <b>Suffix too long</b><br><br>The suffix contained more than 12 characters (see <i>IEEE 488.2, 7.7.3.4</i> ).  |

|            |  |
|------------|--|
| Error –138 | <b>Suffix not allowed</b><br><br>A suffix was encountered after a numeric element which does not allow suffixes.   |
| Error –140 | <b>Character data error</b><br><br>This error, as well as errors –141 through –148, are generated when parsing a character data element.   |
| Error –141 | <b>Invalid character data</b><br><br>Either the character data element contains an invalid character or the particular element received is not valid for the header.   |
| Error –144 | <b>Character data too long</b><br><br>The character data element contains more than twelve characters (see <i>IEEE 488.2, 7.7.1.4</i> ).   |
| Error –148 | <b>Character data not allowed</b><br><br>A legal character data element was encountered where prohibited by the <i>device</i> .  |
| Error –150 | <b>String data error</b><br><br>This error, as well as errors –151 through –158, are generated when parsing a string element.  |
| Error –151 | <b>Invalid string data</b><br><br>A string data element was expected, but was invalid for some reason (see <i>IEEE 488.2, 7.7.5.2</i> ). For example, an END message was received before the terminal quote character. |
| Error –158 | <b>String data not allowed</b><br><br>A string data element was encountered but was not allowed by the <i>device</i> at this point in parsing.   |
| Error –160 | <b>Block data error</b><br><br>This error, as well as errors -161 through -168, are generated when parsing a block data element.   |



|            |   |
|------------|---|
| Error –161 | <b>Invalid block data</b><br><br>A block data element was expected, but was invalid for some reason (see <i>IEEE 488.2 7.7.6.2</i> ). For example, an END message was received before the length was satisfied. |
| Error –168 | <b>Block data not allowed</b><br><br>A legal block data element was encountered but was not allowed by the <i>device</i> at this point in parsing.  |
| Error –170 | <b>Expression error</b><br><br>This error, as well as errors -171 through -178, are generated when parsing an expression data element.  |
| Error –171 | <b>Invalid expression</b><br><br>The expression data element was invalid (see <i>IEEE 488.2, 7.7.7.2</i> ); for example, unmatched parentheses or an illegal character.   |
| Error –178 | <b>Expression data not allowed</b><br><br>A legal expression data was encountered but was not allowed by the <i>device</i> at this point in parsing.  |
| Error –180 | <b>Macro error</b><br><br>This error, as well as errors -181 through -184, are generated when defining a macro or executing a macro.  |
| Error –181 | <b>Invalid outside macro definition</b><br><br>Indicates that a macro parameter placeholder was encountered outside of a macro definition.  |
| Error –183 | <b>Invalid inside macro definition</b><br><br>Indicates that the program message unit sequence, sent with a *DDT or *DMC command, is syntactically invalid (see <i>10.7.6.3</i> ).                              |
| Error –184 | <b>Macro parameter error</b><br><br>Indicates that a command inside the macro definition had the wrong number or type of parameters.  |

|            |  |
|------------|--|
| Error –200 | <b>Execution error</b><br><br>This code indicates only that an Execution Error as defined in <i>IEEE 488.2, 11.5.1.1.5</i> has occurred.   |
| Error –201 | <b>Invalid while in local</b><br><br>Indicates that a command is not executable while the <i>device</i> is in local due to a hard local control (see <i>IEEE 488.2, 5.6.1.5</i> ). For example, a <i>device</i> with a rotary switch receives a message which would change the switches state, but the <i>device</i> is in local so the message can not be executed. |
| Error –202 | <b>Settings lost due to rtl</b><br><br>Indicates that a setting associated with a hard local control (see <i>IEEE 488.2, 5.6.1.5</i> ) was lost when the <i>device</i> changed to LOCS from REMS or to LWLS from RWLS.   |
| Error –210 | <b>Trigger error</b>   |
| Error –211 | <b>Trigger ignored</b><br><br>Indicates that a GET, *TRG, or triggering signal was received and recognized by the device but was ignored because of device timing considerations. For example, the device was not ready to respond.  |
| Error –212 | <b>Arm ignored</b><br><br>Indicates that an arming signal was received and recognized by the <i>device</i> but was ignored.  |
| Error –213 | <b>Init ignored</b><br><br>Indicates that a request for a measurement initiation was ignored as another measurement was already in progress.   |
| Error –214 | <b>Trigger deadlock</b><br><br>Indicates that the trigger source for the initiation of a measurement is set to GET and subsequent measurement query is received. The measurement cannot be started until a GET is received, but the GET would cause an INTERRUPTED error.  |

|            |   |
|------------|---|
| Error -215 | <b>Arm deadlock</b><br><br>Indicates that the arm source for the initiation of a measurement is set to GET and subsequent measurement query is received. The measurement cannot be started until a GET is received, but the GET would cause an INTERRUPTED error. |
| Error -220 | <b>Parameter error</b><br><br>Indicates that a program data element related error occurred.   |
| Error -221 | <b>Settings conflict</b><br><br>Indicates that a legal program data element was parsed but could not be executed due to the current device state (see <i>IEEE 488.2, 6.4.5.3 and 11.5.1.1.5</i> ).  |
| Error -222 | <b>Data out of range</b><br><br>Indicates that a legal program data element was parsed but could not be executed because the interpreted value was outside the legal range as defined by the <i>device</i> (see <i>IEEE 488.2, 11.5.1.1.5</i> ).                  |
| Error -223 | <b>Too much data</b><br><br>Indicates that a legal program data element of block, expression, or string type was received that contained more data than the device could handle due to memory or related device- specific requirements.                           |
| Error -224 | <b>Illegal parameter value</b><br><br>Used where exact value, from a list of possibles, was expected.   |
| Error -230 | <b>Data corrupt or stale</b><br><br>Possibly invalid data; new reading started but not completed since last access.   |
| Error -231 | <b>Data questionable</b><br><br>Indicates that measurement accuracy is suspect.   |
| Error -240 | <b>Hardware error</b><br><br>Indicates that a legal program command or query could not be executed because of a hardware problem in the <i>device</i> .   |

|            |   |
|------------|---|
| Error -241 | <b>Hardware missing</b><br><br>Indicates that a legal program command or query could not be executed because of missing <i>device</i> hardware. For example, an option was not installed.   |
| Error -250 | <b>Mass storage error</b><br><br>Indicates that a mass storage error occurred.  |
| Error -251 | <b>Missing mass storage</b><br><br>Indicates that a legal program command or query could not be executed because of missing mass storage. For example, an option that was not installed.  |
| Error -252 | <b>Missing media</b><br><br>Indicates that a legal program command or query could not be executed because of a missing media. For example, no disk.   |
| Error -253 | <b>Corrupt media</b><br><br>Indicates that a legal program command or query could not be executed because of corrupt media. For example, bad disk or wrong format.  |
| Error -254 | <b>Media full</b><br><br>Indicates that a legal program command or query could not be executed because the media was full. For example, there is no room on the disk.   |
| Error -255 | <b>Directory full</b><br><br>Indicates that a legal program command or query could not be executed because the media directory was full.  |
| Error -256 | <b>File name not found</b><br><br>Indicates that a legal program command or query could not be executed because the file name on the device media was not found. For example, an attempt was made to read or copy a nonexistent file. |

|            |  |
|------------|--|
| Error –257 | <b>File name error</b><br><br>Indicates that a legal program command or query could not be executed because the file name on the device media was in error. For example, an attempt was made to copy to a duplicate file name.   |
| Error –258 | <b>Media protected</b><br><br>Indicates that a legal program command or query could not be executed because the media was protected. For example, the write-protect switch on a memory card was set.   |
| Error –260 | <b>Expression error</b><br><br>Indicates that an expression program data element related error occurred.   |
| Error –261 | <b>Math error in expression</b><br><br>Indicates that a syntactically legal expression program data element could not be executed due to a math error. For example, a divide-by-zero was attempted.  |
| Error –270 | <b>Macro error</b><br><br>Indicates that a macro-related execution error occurred.   |
| Error –271 | <b>Macro syntax error</b><br><br>Indicates that a syntactically legal macro program data sequence, according to <i>IEEE 488.2, 10.7.2</i> , could not be executed due to a syntax error within the macro definition (see <i>IEEE 488.2, 10.7.6.3</i> ).  |
| Error –272 | <b>Macro execution error</b><br><br>Indicates that a syntactically legal macro program data sequence could not be executed due to some error in the macro definition (see <i>IEEE 488.2, 10.7.6.3</i> ).   |
| Error –273 | <b>Illegal macro label</b><br><br>Indicates that the macro label defined in the <i>*DMC</i> command was a legal string syntax, but could not be accepted by the <i>device</i> (see <i>IEEE 488.2, 10.7.3 and 10.7.6.2</i> ). For example, the label was too long, the same as a common command header, or contained invalid header syntax. |

|            |  |
|------------|--|
| Error -274 | <b>Macro parameter error</b><br><br>Indicates that the macro definition improperly used a macro parameter placeholder (see <i>IEEE 488.2, 10.7.3</i> ).  |
| Error -275 | <b>Macro definition too long</b><br><br>Indicates that a syntactically legal macro program data sequence could not be executed because the string of block contents were too long for the device to handle (see <i>IEEE 488.2, 10.7.6.1</i> ). |
| Error -276 | <b>Macro recursion error</b><br><br>Indicates that a syntactically legal macro program data sequence could not be executed because the device found it to be recursive (see <i>IEEE 488.2 10.7.6.6</i> ).                                      |
| Error -277 | <b>Macro redefinition not allowed</b><br><br>Indicates that syntactically legal macro label in the *DMC command could not be executed because the macro label was already defined (see <i>IEEE 488.2, 10.7.6.4</i> ).                          |
| Error -278 | <b>Macro header not found</b><br><br>Indicates that a syntactically legal macro label in the *GMC? query could not be executed because the header was not previously defined.  |
| Error -280 | <b>Program error</b><br><br>Indicates that a downloaded program-related execution error occurred.  |
| Error -281 | <b>Cannot create program</b><br><br>Indicates that an attempt to create a program was unsuccessful. A reason for the failure might include not enough memory.  |
| Error -282 | <b>Illegal program name</b><br><br>The name used to reference a program was invalid. For example, redefining an existing program, deleting a nonexistent program, or in general, referencing a nonexistent program.                            |
| Error -283 | <b>Illegal variable name</b><br><br>An attempt was made to reference a nonexistent variable in a program.  |

|            |   |
|------------|---|
| Error –284 | <b>Program currently running</b><br><br>Certain operations dealing with programs are illegal while the program is running. For example, deleting a running program is not possible. |
| Error –285 | <b>Program syntax error</b><br><br>Indicates that syntax error appears in a downloaded program.   |
| Error –286 | <b>Program runtime error</b>  |
| Error –300 | <b>Device-specific error</b><br><br>This code indicates only that a Device-Dependent Error as defined in <i>IEEE 488.2, 11.5.1.1.6</i> has occurred.                                |
| Error –310 | <b>System error</b><br><br>Indicates that some error, termed “system error” by the device, has occurred.  |
| Error –311 | <b>Memory error</b><br><br>Indicates that an error was detected in the <i>device’s</i> memory.  |
| Error –312 | <b>PUD memory lost</b><br><br>Indicates that the protected user data saved by the *PUD command has been lost.   |
| Error –313 | <b>Calibration memory lost</b><br><br>Indicates that nonvolatile calibration data used by the *CAL? command has been lost.  |
| Error –314 | <b>Save/recall memory lost</b><br><br>Indicates that the nonvolatile data saved by the *SAV command has been lost.  |
| Error –315 | <b>Configuration memory lost</b><br><br>Indicates that nonvolatile configuration data saved by the <i>device</i> has been lost.   |

|            |  |
|------------|--|
| Error –330 | <b>Self-test failed</b>  |
| Error –350 | <p><b>Queue overflow</b></p> <p>This code indicates that there is no room in the queue and an error occurred but was not recorded. This code is entered into the queue in lieu of the code that caused the error.</p>  |
| Error –400 | <p><b>Query error</b></p> <p>This code indicates only that a Query Error as defined in <i>IEEE 488.2 11.5.1.1.7 and 6.3</i> has occurred.</p>  |
| Error –410 | <p><b>Query INTERRUPTED</b></p> <p>Indicates that a condition causing an INTERRUPTED Query error occurred (see <i>IEEE 488.2, 6.3.2.3</i>). For example, a query followed by DAB or GET before a response was completely sent.</p> <p>This message appears when you query a measurement without immediately entering the returned value into a variable. For example, the following program lines query the TX Frequency measurement and enter its value into a variable (Rf_freq):</p> <pre>OUTPUT 714;"MEAS:RFR:FREQ:ABS?" ENTER 714;Rf_freq</pre> |
| Error –420 | <p><b>Query UNTERMINATED</b></p> <p>Indicates that a condition causing an UNTERMINATED Query error occurred (see <i>IEEE 488.2, 6.3.2.2</i>). For example, the <i>device</i> was addressed to talk and an incomplete program message was received.</p> <p>This message usually appears when trying to access a measurement that is not active. For example, you cannot query the DTMF Decoder measurements from the DUPLEX TEST screen, or query the TX Frequency measurement when the <b>TX Freq Error</b> measurement is displayed.</p>            |
| Error –430 | <p><b>Query DEADLOCKED</b></p> <p>Indicates that a condition causing a DEADLOCKED Query error occurred (see <i>IEEE 488.2, 6.3.1.7</i>). For example, both input buffer and output buffer are full and the device cannot continue.</p>   |



- Error –440                    Query UNTERMINATED after indefinite response**
- Indicates that a query was received in the same program message after a query requesting an indefinite response was executed (see *IEEE 488.2, 6.5.7.5.7*).
- Error –606                    Update of Input Module Relay Switch Count file failed.**
- Indicates that the Test Set was not able to update the Input Module Relay Switch Count EEPROM file with the current switch count data from the non-volatile RAM switch count array. This error is most probably generated as a result of a hardware error or failure. Refer to the *Agilent 8924C Assembly Level Repair Manual* for diagnostic information.
- Error –607                    Checksum of Non-Volatile RAM Relay Count data bad.**
- Indicates that the Test Set was not able to generate the proper checksum for the Input Module Relay Switch Count data from the non-volatile RAM switch count array. This error is most probably generated as a result of a hardware error or failure. Refer to the *Agilent 8924C Assembly Level Repair Manual* for diagnostic information.
- Error –608                    Initialization of Input Module Relay Count file failed.**
- Indicates that the Test Set was not able to initialize the Input Module Relay Switch Count EEPROM file during installation of a new input module. This error is most probably generated as a result of a hardware error or failure. Refer to the *Agilent 8924C Assembly Level Repair Manual* for diagnostic information.
- Error –1300                   Order attempted while not in Connect state.**
- Indicates that an attempt was made to send an order type Mobile Station Control Message (that is - order a change in power level, put the mobile station in maintenance mode, or send an alert message to the mobile station) when the Call Processing Subsystem was not in the Connect state.
- Error –1301                   Handoff attempted while not in Connect state.**
- Indicates that an attempt was made to handoff a mobile station to a new voice channel when the Call Processing Subsystem was not in the Connect state.
- Error –1302                   Release attempted while not in Connect state.**
- Indicates that an attempt was made to send a Release message to a mobile station when the Call Processing Subsystem was not in the Connect state.

- Error –1303                    Page attempted while not in Active state.**
- Indicates that an attempt was made to Page a mobile station when the Call Processing Subsystem was not in the Active state.
- Error –1304                    Origination attempted while not in Active state.**
- Indicates that a mobile station attempted to originate a call to the simulated Base Station when the Call Processing Subsystem was not in the Active state.
- Error –1305                    Registration attempted while not in Active state.**
- Indicates that an attempt was made to send a Registration message to a mobile station when the Call Processing Subsystem was not in the Active state.
- Error –1306                    Origination in progress.**
- Indicates that an attempt was made to; register, page, handoff, release, order a change in power level, put the mobile station in maintenance mode, or send an alert message to the mobile station while an origination was in progress.
- Error –1307                    Timeout occurred while attempting to register Mobile.**
- Indicates that the simulated Base Station's internal timer expired before receiving a response from the mobile station during a registration attempt. The internal timer is set to 20 seconds when the **Register** state is entered.
- Error –1308                    Timeout occurred while attempting to page Mobile.**
- Indicates that the simulated Base Station's internal timer expired before receiving a response from the mobile station during a page attempt. The internal timer is set to 20 seconds when the **Page** state is entered.
- Error –1309                    Timeout occurred while attempting to access Mobile.**
- Indicates that the simulated Base Station's internal timer expired before receiving a response from the mobile station during an access attempt. The internal timer is set to 20 seconds when the **Access** state is entered.

Error –1310                   **Timeout occurred while attempting to alert Mobile.**

Indicates that the simulated Base Station’s internal timer expired before receiving a response from the mobile station during an alert attempt. The internal timer is set to 20 seconds when the alert order is sent to the mobile station.

Error –1311                   **RF power loss indicates loss of Voice Channel.**

When the **CALL CONTROL** screen is displayed and the Call Processing Subsystem is in the **Connect** state, the host firmware constantly monitors the mobile station’s transmitted carrier power. If the power falls below 0.0005Watts the simulated Base Station will terminate the call and return to the **Active** state. This error message is displayed if the host firmware has detected that the mobile station’s carrier power has fallen below the 0.0005Watts threshold. The call is dropped and the Call Processing Subsystem returns to the **Active** state.

---

**NOTE:**

In order to ensure that the host firmware makes the correct decisions regarding the presence of the mobile stations’s RF carrier, the Test Set’s RF power meter should be zeroed when first entering the Call Processing Subsystem (that is - the first time the **CALL CONTROL** screen is selected during a measurement session). Failure to zero the power meter can result in erroneous RF power measurements. See “Using the Analog Call Processing Subsystem” chapter in the *Agilent 8924C Application Guide* for information on zeroing the RF Power meter.

---

Error –1312                   **Data from RVC contains invalid bits in word [1,2,3].**

Indicates that the decoded data received on the reverse voice channel contains invalid bits in word 1 and/or word 2 and/or word 3. The raw decoded data is displayed in hexadecimal format in the top right-hand portion of the **CALL CONTROL** screen. Raw decoded data is only displayed when the **CALL CONTROL** screen **Display** field is set to **Data**.

Error –1313                   **Timeout occurred while in Maintenance state.**

Indicates that the simulated Base Station’s internal timer expired before the mobile station was taken out of the maintenance state. The internal timer is set to 20 seconds when the maintenance order is sent to the mobile station.

Error –1314                   **Alert attempted while not in Maintenance or Connect state.**

Indicates that an attempt was made to send an Alert order to the mobile station when the Call Processing Subsystem was not in the Maintenance state or Active state.

Error –1315

**Data from RECC contains invalid bits in word [1,2,3].**

Indicates that the decoded data received on the reverse control channel contains invalid bits in word 1 and/or word 2 and/or word 3. The raw decoded data is displayed in hexadecimal format in the top right-hand portion of the **CALL CONTROL** screen. Raw decoded data is only displayed when the **CALL CONTROL** screen **Display** field is set to **Data**.

Error –1316

**Incomplete data received on RECC for word [1,2,3].**

Indicates that the decoded data received on the reverse control channel did not contain the proper number of bits in word 1 and/or word 2 and/or word 3. The raw decoded data is displayed in hexadecimal format in the top right-hand portion of the **CALL CONTROL** screen. Raw decoded data is only displayed when the **CALL CONTROL** screen **Display** field is set to **Data**.

Error –1317

**Incomplete data received on RVC for word [1,2,3].**

Indicates that the decoded data received on the reverse voice channel did not contain the proper number of bits in word 1 and/or word 2 and/or word 3. The raw decoded data is displayed in hexadecimal format in the top right-hand portion of the **CALL CONTROL** screen. Raw decoded data is only displayed when the **CALL CONTROL** screen **Display** field is set to **Data**.

---

## List of Text Only Error Messages

Operation errors generally occur when you try to do something the Test Set was not designed to do. Most messages tell you what to do to correct the problem, (turn something off, reduce a field's value, press a certain key, and so forth).

Some common messages are listed here:

### **All self tests passed.**

The Test Set did not detect any hardware or firmware failures during its initial self-diagnostics. This message should always be displayed immediately after instrument turn on.

### **Cal file checksum incorrect - initializing file.**

This error usually occurs after changing the Test Set's firmware ROM's. It is not a problem in that instance, but should not re-appear during subsequent operation of the Test Set.

### **Cannot make call at this time.**

This error message appears when a call is attempted while the Test Set is performing another call processing function, such as registration. Press the END CALL key and attempt the call again.

### **Change Ref Level, Input Port or Attenuator (if using "Hold").**

The RF signal level is either too great or too small for the current input port, attenuator setting, or both. This error often occurs when trying to make a low-level measurement using the RF IN/OUT port with the Spectrum Analyzer. Make the indicated changes until this message is no longer displayed.

### **Change RF Gen Amplitude, Output Port or Atten Hold (if on).**

This message appears when the RF Generator's **Amplitude** field is set too high when using the RF IN/OUT port or when adjusting the amplitude with the **Atten Hold** field set to On.

The RF IN/OUT port has a lower maximum output level than the DUPLEX OUT port. Use the DUPLEX OUT port, or reduce the RF Generator's level.

If **Atten Hold** is On, you may be adjusting the amplitude outside of the allowed range. Change the amplitude

**Decoder buffer full. Decrease gate time.**

Too many decoder samples were sent to the decoder's buffer during a measurement gate time causing a data overflow. Reducing the gate time decreases the amount of data sent during each measurement.

**Delta between RF Power and a channel level greater than 30 dB**

A code channel level (pilot, sync, paging, or traffic) is set to a value outside of the 30 dB range relative to the RF Power level.

To find out which code channel is causing this error message, calculate the delta between RF Power and Sector A power. Add to this value the delta between Sector A power and the code channel that is set to the lowest value. If this total exceeds 30 dB, decrease the delta by adjusting the code channel level or the Sector A Power level closer to the displayed RF Power. Repeat for Sector B if necessary.

**Direct latch write occurred. Cycle power when done servicing.**

The SERVICE screen was accessed and one or more internal latch settings were changed. Turn the instrument off and back on to reset the latches. (This condition can occur during periodic calibration.)

**Input value out of range.**

A number was entered that was too large or small for the selected field, for example, trying to set **AFG1 Freq** to 125 kHz.

**Invalid channel setting with paging rate set to 'half'.**

It is invalid to set the Sector A **Paging** field or the Sector B **Pilot** field to a level between -3.01 and 0 dB with the **Page Rate** field (on the CELL SITE CONFIGURATION screen) set to **Half**.

Readjust the Sector A **Paging** field and/or the Sector B **Pilot** field (on the CDMA GENERATOR CONTROL screen) so that neither is at a value between -3.01 and 0 dB. Or, set the **Page Rate** field to **Full** to allow levels up to 0 dB.

**Invalid keystroke.**

You used a key that has no function relating to the selected field, for example, pressing the [ON/OFF] key while the **Filter 1** field is selected.

**One or more self tests failed. Error code: XXXX**

An instrument failure was detected when the Test Set was turned on. (For example, having a stuck front-panel key during turn on.) The numbered error message corresponds to a binary-weighted group of errors listed in the \*TST Common Command description in GPIB Common Commands chapter of the *Agilent 8924C Condensed Programming Reference Guide*.

**Option not installed.**

You selected a function that requires optional hardware that is not present.

**Squelch interrupt overflow. Press MEAS RESET.**

The Test Set temporarily interrupts audio measurements when squelch is first broken to prevent internal switching transients from influencing measurements (except when using the OSCILLOSCOPE, SPECTRUM ANALYZER, DECODER, or SERVICE screens). If squelch is repetitively broken in a period of a few seconds, the duration of measurement interruption becomes too great, and the Test Set stops interrupting the signal. Following measurements may be influenced by transient signals.

Pressing [MEAS RESET] clears the data buffer used to generate interrupts, resetting the normal squelch operation to eliminate transients.

This condition may occur when monitoring low-level off-the-air signals.

**Turn off either AM or FM settings.**

You tried to create simultaneous AM and FM (using any combination of AFGen1, AFGen2, and the **Mod In To** field). The Test Set does not provide simultaneous AM and FM.

---

**Symbols**

‘.LIB’ files, 219  
‘.NMT’ files, 217, 219  
‘.PGM’ files, 219  
‘.PRC’ files, 219  
‘.SAV’ files, 219  
‘n’ files, 217

**A**

abort printing, 71  
Active Controller  
  when capability required, 96  
AdvanceLink (HP 68333F Version  
  B.02.00) terminal emulator, 255,  
  269  
Agilent, 9  
ANT IN connector  
  connecting to, 22  
ASCII text files  
  sending with ProComm Communica-  
  tions Software, 276  
  sending with Windows Terminal, 275  
ASSIGN, 65, 66  
averaging  
  example how to use, 52  
  measurement results, 52  
  restart averaging, 52

**B**

base settings  
  changing, 64  
  default, 64  
Battery  
  memory card, 226  
  part numbers, 226  
  replacing, 226  
Beeper  
  Configure screen, 45  
beeper  
  volume control, 45  
brightness  
  setting, 44



## C

Calibrating Status Register Group, 115  
 Calibration Status Register Group, 120  
     accessing registers contained in, 123, 128  
     condition register bit assignments, 122, 125  
 Calibration Status Register Group (see Calibration Status Register Group), 120  
 Call Processing Status Register Group, 125  
 Call Processing Subsystem  
     polling, 112  
     service request, 113  
 CDMA Authentication Status Register Group, 130  
 CDMA SMS Status Register Group, 135  
 CDMA Status Register Group, 135, 140  
 CDMA\_2 Status Register Group, 146  
 clear  
     global user key assignment, 66  
     local user key assignment, 66  
     register contents, 63  
 Code files, 217  
 code files, 303  
 Communicate Status Register Group, 151  
     condition register bit assignments, 155  
 Communicate Status Register Group (see Communicate Status Register Group), 151  
 concurrent measurements  
     cdma transmitter and receiver, 86  
 configuration  
     test set, 43  
 Configure screen  
     Beeper, 45  
     Date, 45  
     Intensity, 44  
     RFGen Volts, 44  
     Time, 45  
 connect  
     DUT to test set, 22  
     radio to test set, 22  
 COPY\_PL, 230  
 Copying a volume, 232  
 Copying files, 231

## D

data functions  
     turning ON and OFF, 49  
 Date  
     Configure screen, 45  
 date and time, 45  
 dBm  
     displaying results in, 55  
 dBuV  
     displaying results in, 55  
 decimal format, 58  
 decrement  
     changing setting, 60  
 Default file system, 206  
 default settings  
     base, 64  
     changing, 63, 64  
     power-on, 63  
 delete  
     global user key assignment, 66  
     local user key assignment, 66  
     register contents, 63  
 device-under-test  
     connecting, 22  
 Disk drives  
     external, 212, 235  
     external - default mass storage volume specifier, 216  
     external - initializing media for, 235  
 DOS file names, 218  
 DOS file system, 218  
     initializing media for, 221  
 downloading programs  
     to Test Set, 263, 299  
 dump graphics, 71  
 DUT  
     connecting, 22

## E

EPSON card (see Memory card), 213, 214, 224  
 Error Message Queue, 156  
 Error Message Queue Group  
     accessing the error message queue, 157  
 Error Messages  
     non-recoverable firmware error, 314  
 error messages, 307  
     operation, 334  
     pending correction of error condition, 313  
 External disk drives, 208, 212, 235  
     initializing media for, 221, 235

---

**F**

## fields

- changing settings, 26
- interactions, 69
- priority settings, 69
- types of, 26

## File names

- conflicts, 220
- recommendations, 220

## File system

- backing up files, 230
- copying volume, 232
- DOS, 218
- DOS file names, 218
- file name conflicts, 220
- file naming recommendations, 220
- file types, 221
- initializing media, 221, 229, 234, 235
- LIF, 218
- LIF file names, 218
- naming files, 218
- storing code files, 222

## File types, 221

## Files

- backing up, 230
- copying, 231
- storing, 222

## frequency offset, 67, 68

## Front panel

- ON/OFF key, 49

## functional test

- for verifying operation, 42

**G**

## GPIB

- Active Controller, 31, 94, 96
  - address - displaying, 36
  - address - setting, 36
  - changing a field setting, 33
  - configuration, 31
  - display units - changing, 55
  - downloading programs to Test Set, 263
  - GPIB units - changing, 56
  - making a simple measurement, 34
  - passing control (see Passing Control), 94
  - programming examples, 33, 34, 40
  - programming guidelines, 32
  - reading a field setting, 33
  - STAtE command - definition, 49
  - Status reporting (see Status reporting), 106
  - System Controller, 31, 94, 95
- GPIB command syntax
- DUNits, 55
  - guidelines, 37
  - STAtE, 49
  - UNITs, 56
  - use of spaces, 38
  - using colons to separate commands, 38
  - using question mark to query setting/field, 40
  - using quotes for strings, 38
  - using semicolon colon command separator, 39
  - using semicolon to output multiple commands, 39
  - using upper/lower case letters, 37

**H**

- Hardware Status Register #1 Group, 158
  - accessing registers contained in, 162
  - condition register bit assignments, 161
- Hardware Status Register #1 Group (see Hardware Status Register #1 Group), 158
- Hardware Status Register #2 Group, 164
  - accessing registers contained in, 167
  - condition register bit assignments, 167
- Hardware Status Register #2 Group (see Hardware Status Register #2 Group), 164
- HFS (Hierarchical File System), 218
- hi limits
  - setting measurement limits, 53
- Hierarchical File System (HFS), 218
- HP-IB
  - PROGram commands. *See* PROGram Subsystem
  - uploading programs to Test Set, 264

---

**I****IBASIC**

- Controller - default mass storage location, 215
- COPY command, 231, 232
- copying files, 231
- default file system, 206
- GET command, 222
- INITIALIZE command, 221, 229, 234, 235
- initializing media, 221
- LOAD command, 222
- making a simple measurement, 34
- Mass Storage Volume Specifier (MSI), 229
- MSI, 229
- passing control back using PASS CONTROL, 97
- requesting GPIB active control, 98
- running programs, 32
- SAVE command, 222
- selecting mass storage devices, 216
- STORE command, 222
- storing files, 222

IBASIC command line, 240

IBASIC controller

- interfacing to serial ports, 244
- screen, 239

IBASIC EDIT mode

- entering/exiting, 268

IBASIC program development

- See* See program development.

IEEE 488.1

- Passing Control (see Passing Control), 94

IEEE 488.2

- Common Commands ESE, 198
- Common Commands ESE?, 198
- Common Commands ESR?, 198
- Common Commands PCB, 97
- Common Commands SRE, 203
- Common Commands SRE?, 202
- Common Commands STB?, 201
- Output Queue, 179
- Standard Event Status Register, 195
- Status Byte Register, 199

Increasing measurement speed

- screen display time, 93

increasing measurement throughput, 86

instrument function

- turning ON and OFF, 49

Intensity

- Configure screen, 44

intensity

- setting, 44

interactions

- between fields, 69

- between screens, 69

**K**

k1 through k5, 65

k1' through k3', 65

**L**

- .LIB files, 303
- Library files
  - backing up, 230
  - library files, 303
- LIF file names, 218
- LIF file system, 218
  - initializing media for, 221
- limits
  - setting measurement limits, 53
- lo limits
  - setting measurement limits, 53

**M**

- Manual Control Mode, 30
- Mass Storage Devices
  - accessing, 217
  - default locations, 215
  - EPSON cards, 213, 214, 224
  - external disk drives, 212, 235
  - initializing media for, 221, 229, 234
  - OTP card, 214, 224
  - overview, 208
  - PCMCIA cards, 213, 214, 224
  - RAM Disk, 210, 233
  - ROM card, 214, 224
  - ROM Disk, 211, 223
  - selecting, 216
  - SRAM card, 213, 224
  - write protecting, 228
- Mass storage locations
  - default values, 215
  - selecting, 216
- Mass Storage Volume Specifier, 229
- measurement
  - averaging, 52
  - querying value, 40
  - reference, 51
  - saving and recalling setups, 61
  - turning ON and OFF, 49
  - units, 55, 56
- measurement limits
  - setting measurement limits, 53
- measurement triggering
  - measurement triggering process, 72
- Measuring Status Register Group, 169
- memory
  - considerations, 64
- Memory Card Part Numbers, 224
- Memory Cards
  - address, 229
  - battery (see Battery), 226
  - initializing, 221, 229
  - inserting, 225
  - Mass Storage Volume Specifier, 229
  - OTP cards, 214
  - part numbers, 224
  - removing, 225
  - ROM cards, 214
  - SRAM cards, 213
  - using, 224

- write-protect switch, 228
- memory overflow error, 64
- message
  - error, 307
  - operation, 334
  - types of, 307
- meter
  - analog, displaying, 50
  - example how to use, 50
  - measurements used for, 50
- Microsoft® Windows Terminal terminal
  - emulator, 252, 268
- Model
  - Print Configure screen, 71

## N

names  
  registers, 63  
newlink memcard2, 225  
Non-Recoverable Firmware Error, 314  
numbers  
  changing, 58  
  decimal format, 58  
  entering, 58  
  system, 58  
numeric entries, 58

## O

offset  
  example, 67  
  setting, frequency, 67  
On/Off  
  example how to use, 49  
Operating Modes  
  external automatic control, 23  
  internal automatic control, 23  
  manual control, 23, 30  
operation messages, 334  
Operation Status Register Group, 174  
  accessing registers contained in, 118,  
  172, 177, 189, 193  
  Condition Register bit assignments,  
  118, 172, 176, 189, 193  
Operation Status Register Group (see Op-  
eration Status Register Group), 174  
OTP Memory card, 208, 214  
Output Queue Group, 179  
  accessing the output queue, 180  
Output Queue Group (see Output Queue  
Group), 179  
overpower  
  damage, 22

## P

Passing Control, 94  
  example programs, 99  
  passing control back automatically, 96  
  passing control back to another control-  
  ler, 96  
  passing control back using PASS CON-  
  TROL, 97  
  passing control to Test Set, 97  
  requesting control from IBASIC, 98  
PC  
  AdvanceLink (HP 68333F Version  
  B.02.00) terminal emulator, 255,  
  269  
  Microsoft® Windows Terminal termi-  
  nal emulator, 268  
  ProCommr® Revision 2.4.3 terminal  
  emulator, 269  
  serial port configuration, 251  
  terminal emulator, 251  
PCMCIA card (see Memory card), 213,  
  214, 224  
pending  
  error messages, 313  
  .PGM files, 303  
Phone numbers  
  customer support, 9  
power-on settings  
  changing, 63  
  .PRC files, 303  
preset state  
  changing, 64  
  default, 64  
Print Configure screen  
  Model, 71  
  Print Title, 71  
  Printer Address, 71  
  Printer Port, 71  
  settings, 71  
Print Title  
  Print Configure screen, 71  
printer  
  connecting to GPIB, 31  
Printer Address  
  Print Configure screen, 71  
Printer Port  
  Print Configure screen, 71  
printing

screens, 71  
 priority fields, 70  
 Procedure files, 217  
   backing up, 230  
 procedure files, 303  
 ProCommr® Revision 2.4.3 terminal em-  
   ulator, 269  
 program development  
   choosing development method, 257  
   IBASIC, 242  
   methods of, 242  
   using external computer, 259  
   using IBASIC EDIT mode, 266  
   using word processor on PC, 270  
 PROGram Subsystem, 281  
   commands, 283  
   executing commands, 297

## Q

Questionable Data/Signal Register  
   Group, 180  
   accessing registers contained in, 183  
   condition register bit assignments, 182

## R

radio  
   connecting, 22  
 RAM Disk, 208, 210  
   initializing, 234  
   using, 233  
 RAM\_MNG, 233  
 recall  
   instrument setups, 62  
   settings, 62  
 RECALL key  
   using, 62  
 Ref indicator, 51  
 reference  
   setting a measurement, 51  
 registers  
   clearing, 63  
   naming, 63  
 RELEASE, 66  
 release  
   global user key assignment, 66  
   local user key assignment, 66  
 remove  
   register contents, 63  
 RF frequency offset  
   setting, 67  
 RF IN/OUT connector  
   connecting to, 22  
 RF offset  
   example, 67  
 RF voltage  
   setting, 44  
 RFGen Volts  
   Configure Screen, 44  
 RJ-11 jack, 245  
 ROM Disk, 208, 211  
   using, 223  
 ROM Memory card, 208, 214  
 RX Test screen  
   priority settings, 69

- 
- S**
- save
    - instrument setups, 61
    - settings, 61
  - SAVE key
    - using, 61
  - Save/Recall Registers
    - default mass storage locations, 215
  - saving instrument setups, 61
  - saving settings, 61
  - screen dump, 71
  - screens
    - interactions, 69
    - printing, 71
    - setting intensity, 44
  - Serial 1 Status Register Group, 185
  - Serial 2 Status Register Group, 190
  - serial port
    - configuration, 244, 249, 278
    - input buffer length, 250
    - interface to IBASIC controller, 244
    - receive/transmit pacing, 250
    - select code 10, 245, 278, 280
    - select code 9, 245, 249, 278
    - serial I/O from IBASIC program, 278
  - Service Request Enable Register, 199
    - clearing, 204
    - reading, 202
    - writing, 203
  - Service Requests
    - Service Request Enable Register (see Service Request EnableRegister), 199
  - settings
    - base, 64
    - beeper volume, 45
    - changing, field, 26
    - date, 45
    - default, 63, 64
    - power-on, 63
    - recalling, 61
    - RF voltage, 44
    - saving, 61
    - time, 45
  - setups
    - recalling, 61
    - saving, 61
  - SRAM Memory card, 208, 213
  - Standard Event Status Register Group, 195
    - accessing registers contained in, 198
    - bit assignments, 197
  - Status Byte Register, 199
    - clearing, 202
    - reading with serial poll, 201
    - reading with STB Common Command, 201
    - writing, 202
  - Status reporting, 106
    - clearing the Status Byte Register, 202
    - Condition register definition, 108
    - Enable register definition, 110
    - Event register definition, 109
    - Questionable Data/Signal Register Group (see QuestionableData/Signal Register Group), 180
    - reading Status Byte Register with serial poll, 201
    - reading Status Byte Register with STB CommonCommand, 201
  - Standard Event Status Register Group (see Standard EventStatus Register Group), 195
  - Status Byte Register, 199
    - status queue model, 111
    - status register model, 107
    - status register structure overview, 106
    - status registers in Test Set, 114
    - Summary Message definition, 110
    - Transition filter definition, 108
    - writing the Status Byte Register, 202
  - Storing code files, 222
  - Support Contacts
    - electronic mail, 9
    - telephone, 9
  - System Controller, 95
- T**
- terminal configuration, 256
  - Test Set
    - default file system, 206
    - display units - changing, 55
    - file name conflicts, 220
    - file system, 218
    - file types, 221
    - GPIB units - changing, 56
    - operating modes, 23
    - overview, 30
    - STATe command - definition, 49
    - status registers, 114
  - test set
    - configuring, 43
  - TESTS Subsystem, 302
    - default mass storage locations, 216
    - file descriptions, 303
    - file relationships, 304
    - screens, 305
  - TestSet
    - file name entry field width, 219
    - file names (see also DOS & LIF file names), 219
  - Time
    - Configure screen, 45
  - time and date, 45
  - triggering
    - measurement triggering process, 72
    - triggering analog measurements in local mode, 76
    - triggering analog measurements in remote mode, 82
    - triggering cdma measurements in local mode, 79
    - triggering cdma measurements in remote mode, 84
  - TX Test screen
    - priority settings, 69
-

---

**U**

unit-of-measure  
  changing, 55, 56  
  converting, 55, 56  
uploading programs  
  from Test Set to external controller,  
    300  
  from Test Set to PC, 277  
  to Test Set, 264  
user keys  
  assigning global, 66  
  assigning, local, 65  
  clearing, global assignment, 66  
  clearing, local assignment, 66  
  deleting, global assignment, 66  
  deleting, local assignment, 66  
  example, 65  
  explanation, 65  
  global, assignment, 66  
  global, defined, 65  
  local, assignment, 65  
  local, defined, 65  
  releasing, global assignment, 66  
  releasing, local assignment, 66  
  setting, global, 66  
  setting, local, 65

**V**

V (volts)  
  displaying results in, 55  
voltage  
  setting, 44  
volume  
  beeper, 45  
Volume copy, 232

**W**

W (watts)  
  displaying results in, 55  
Wildcards, 206, 232  
word processor  
  configuring for program development,  
    270  
  transferring programs to Test Set, 271  
  writing lines of IBASIC code, 271  
Write-protect switch, 228



---

X  
Xon/Xoff, 250