



Advanced Test Equipment Corp.

www.atecorp.com 800-404-ATEC (2832)



ADT850 Laboratory Thermocouple Calibration Furnace

 **850 Laboratory Thermocouple Calibration Furnace**

-----User Manual
[Version: 2104V03]

STATEMENT

This user's manual provides operating and safety instructions for the ADT850 Laboratory Thermocouple Calibration Furnaces. To ensure correct operation and safety, please follow the instructions in this manual. Additel Corporation reserves the right to change the contents and other information contained in this manual without notice. For the most up-to-date manual, please visit www.additel.com.

CONTENT

Safety Instructions	1
1. Introduction	3
1.1 Overview.....	3
1.2 Model Information.....	4
1.3 Basic Structure	5
1.4 Features	7
1.5 Working Environment	8
1.6 General Specifications.....	8
1.7 Temperature Specifications	10
2. Operation	13
2.1 Main Display	13
2.2 Rotation Knob Button Operations	14
2.3 Step Function	16
2.4 Temperature unit settings	17
2.5 Real-time temperature curve	18
2.6 Temperature control	22
2.7 Intelligent diagnostic center	36
3. Setup	37
3.1 Control settings.....	38
3.2 Sensor Library	39

3.3 Communication Settings.....	40
3.4 ACloud Services	42
3.5 System Services.....	43
3.6 Personalization	44
3.7 Product information.....	46
4. Copyright	46

Tables

Table 1.2.1 Model Information	4
Table 1.3.1 Basic Structure	7
Table 1.6.1 General Specifications	8
Table 1.7.1 ADT850 Long Furnace Mode Temperature field specifications	10
Table 1.7.2 ADT850 Short Furnace Mode Temperature field specifications	11
Table 1.8.1 ADT850 Standard Accessories	12
Table 2.6.1 Controlling Parameters	32
Table 2.6.2 Reference Parameters	35
Table 3.2.1 Reference TC Parameters	40
Table 3.3.1 Ethernet IP address acquisition method selection	41
Table 3.3.2 Ethernet IP address manual settings	41
Table 3.3.3 Wireless communication settings	42
Table 3.3.4 Wireless communication manual settings	42
Table 3.6.1 Date and time	45
Table 3.6.2 Sound list	46

Figures

Figure 1-1 Basic Structure.....	5
Figure 1-2 Basic Structure – left side	6
Figure 1-3 Basic Structure – right side	6
Figure 2-1 Main Display	14
Figure 2-2 Knob button Temperature Setting Display.....	15
Figure 2-3 Step Settings Display	17
Figure 2-4 Standby Measurement Curve	19
Figure 2-5 Temperature Control Process Curve.....	20
Figure 2-6 Temperature fluctuation curve after stabilization	21
Figure 2-7 Base metal long furnace + empty chamber mode.....	23
Figure 2-8 Base metal long furnace + long empty cup insert mode	24
Figure 2-9 Base metal long furnace + long multi-hole insert mode	25
Figure 2-10 Noble metal long furnace + ϕ 20mm aluminium tube mode	26
Figure 2-11 Base metal short furnace + empty chamber mode	27
Figure 2-12 Base metal short furnace + short empty cup insert mode	28
Figure 2-13 Base metal short furnace + short multi-hole insert mode	29
Figure 2-14 Noble metal short furnace + ϕ 16mm aluminium tube mode.....	30
Figure 2-15 Annealing furnace mode	31
Figure 2-16 N Type TC correctness diagnostic page	37

Figure 3-1 Main Menu Display	38
Figure 3-2 System Settings Display	39

Safety Instructions

Warnings - identify any action or condition that may be hazards to the user.

Cautions - identify any action or condition that may damage the calibrator or the equipment under test.

Warnings:

To prevent personal injury, please follow this user manual.

To prevent possible electrical shock, fire, or personal injury, please:

1. General:

- ◆ Before using the product, please read the manual, especially the "Safety Instructions" section;
- ◆ Do not use the device outside of the specified environmental conditions;
- ◆ Before using the product, please check the appearance of the product for any damage;
- ◆ Please follow the operation steps in the manual when using the product;
- ◆ If the product is damaged or malfunctions, please do not use it, and contact Additel;
- ◆ Do not use this product in an explosive gas, steam or dust environment;
- ◆ This product should be used by trained personal only, to prevent injury or damage to the operator or the product.

2. High Temperature:

- ◆ Inserted probes may be hot, please pull them out only when the furnace temperature below 50°C;
- ◆ Before using, please power on the unit to check the temperature of the furnace to prevent burns from the residual temperature of the last operation;

- ◆ Do not put your hands or other parts of your body into the protective cover of the furnace;
- ◆ To avoid damaging the furnace or units under test, do not cut off the power when the temperature of the furnace is above 100°C;
- ◆ If you are unsure of the temperature of the furnace or any probes under test, do not touch any components of with the exception of the display screen, power switch until ample time has passed to ensure components are not hot to the touch.

3. **Electrical:**

- ◆ Double check the power connection, fuse model and installation before use;
- ◆ Do not apply more than 30V AC or DC to TC jacks, to prevent damage to the electrical protection components caused by overvoltage;
- ◆ Always use the correct fuse size and type if replacements are required;
- ◆ Do not disassemble the furnace without obtaining permission from Additel.

4. **Cautions:**

- ◆ To prevent possible electrical shock, fire, or instrument damage, please follow this user manual;
- ◆ Do not use any power cord other than the one provided with the furnace;
- ◆ Do not unplug the power cord while in use;
- ◆ Do not use the furnace under a strong mechanical vibration environment;
- ◆ Do not clean the furnace with liquid, please contact Additel for cleaning process;
- ◆ To avoid damaging the unit, do not drop anything into the calibrator;
- ◆ Do not use the furnace if it appears to have any issues, and contact Additel immediately;
- ◆ Do not modify the default configuration of the furnace, correct setting of such parameters is very important for the safety and normal operation of this furnace;

1. Introduction

1.1 Overview

The ADT850 Laboratory Thermocouple Calibration Furnace is the latest generation of intelligent constant temperature equipment launched by Additel. It is equipped with a safe and efficient heating apparatus, which provides the furnace with excellent temperature field stability. At the same time, it uses a high-performance intelligent temperature controller to greatly improve the accuracy and resolution of temperature control. The furnace can easily support the calibration of noble metal thermocouples and base metal thermocouples.

The ADT850 Laboratory Thermocouple Calibration Furnace relies on Additel's long-term accumulated experience and innovative technology to achieve excellent product performance, which in turn, provides a variety of professional solutions for users. Industries served include power, petrochemical, metering, metallurgy, pharmaceutical, biotechnology, food, machinery, shipbuilding, aerospace, transportation and other industries, the smart standard furnace is an ideal choice for laboratory temperature calibration.

Contact us:

Additel Corporation

Tel: +1-714-998-6899

www.additel.com

1.2 Model Information

Table 1.2.1 Model Information

Temperature Range	(300~1200) °C
Operating Modes	9 unique modes
Intelligent Calibration	•
Data Logging	•
Intelligent Diagnosis	•
Intelligent remote control	•
Weight	45 kg

1.3 Basic Structure

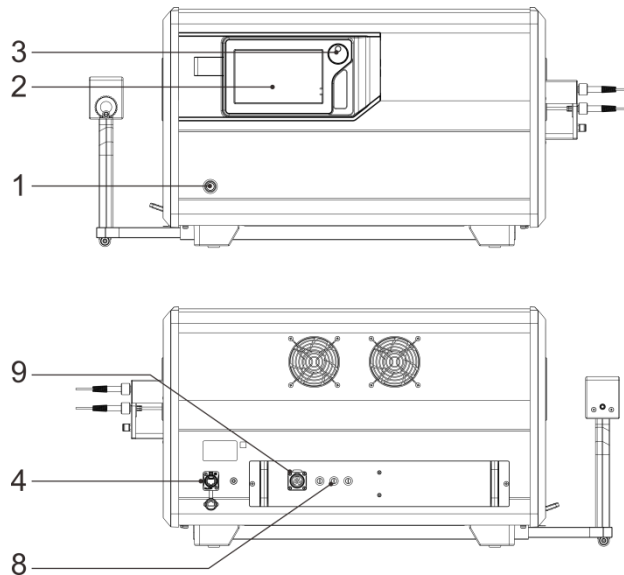

Figure 1-1 Basic Structure

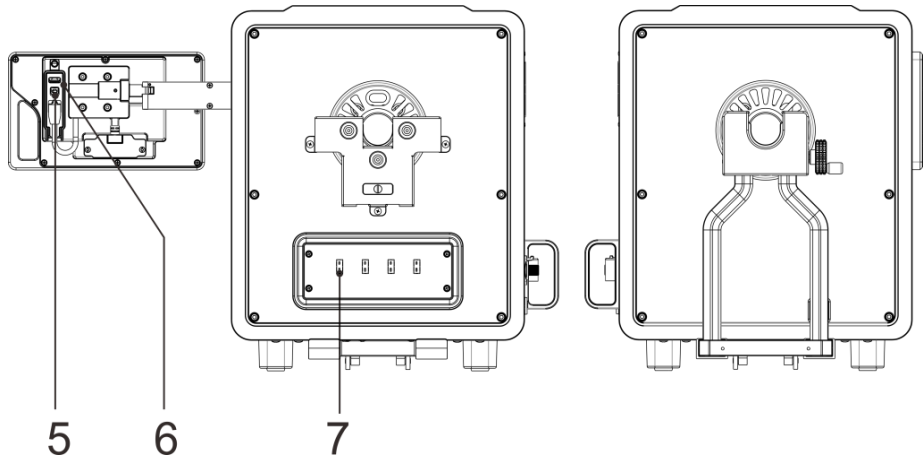

Figure 1-2 Basic Structure - Right Side

Figure1-3 Basic Structure - Left Side

Table 1.3.1 Basic Structure

No.	Part Name	Description
1	Power Switch	Controls power supply to the unit
2	LCD Display	User interface and controls
3	Knob Button	Articulated thumb wheel for an optional navigation method
4	Network Cable Port	LAN port, to connect to the host computer
5	USB Port (Device)	To connect to the host computer
6	USB Port (Host)	To connect U disk for system upgrades
7	Mini TC Measurement ports	To connect temperature controlling TC's
8	Fuse holder	To install the fuses
9	Power supply Lemo port	To supply power to the unit

1.4 Features

- ◆ Independent three temperature zone, fast temperature control and high temperature performance.
- ◆ Support temperature self-calibration to ensure optimal performance and accuracy.
- ◆ Unique technology reduces high temperature leakage and high performance for base and noble metal TC calibrations.

- ◆ The temperature control sensor can be easily replaced, that is convenient for the maintenance.
- ◆ Carefully selected high temperature alloy materials increase thermal transfer of heat and provide good thermal transfer.
- ◆ The advanced adaptive control algorithm makes the furnace have excellent temperature stability and temperature uniformity.
- ◆ Independent hardware over-temperature protection, completely separate from the main control system to immediately cut off the heating power supply when an over temperature condition occurs.
- ◆ Remote communication available via ACloud service or mobile device and not limited by distance.
- ◆ Displays the current temperature and curve in real time, the digital jog dial can quickly set the temperature, and it supports USB, LAN, WIFI and other communication methods.

1.5 Working Environment

- ◆ Working temperature range: (5~45) °C
- ◆ Storage temperature range: (-20~70) °C
- ◆ Relative humidity: < 80% @ 35°C and below; Decrease linearly from 80% to 50% @ (35~45)°C
- ◆ Atmospheric pressure: Below 2000 meters above sea level
- ◆ IP protection level: IP20

1.6 General Specifications

Table 1.6.1 General Specifications

Specification	ADT850
---------------	--------

Temperature range	(300~1200) °C
Stability	≤0.1°C/min; ≤0.4°C/30min
Display accuracy	±5°C
Heating Time	(23~1200)°C: 40 mins
Cooling Time	(1200~300)°C: 90 mins
Resolution	0.01°C / 0.01°F / 0.01K
Inner diameter of heating pipe	39mm ±1mm
Working temperature	(5~45)°C
Storage temperature	(-20~70)°C
Relative humidity	0~90% RH @ (0°C~50°C) , Non-condensing
Atmospheric pressure	<2000m
Installed power	4000W (AC220V)
Power Supply	AC220V ±10%, 50/60Hz, 16A
Screen	7in TFT industrial touchscreen
Fuse	T12A, 250V

Dimensions (W x H x L)	342mm x 424mm x 680mm
Weight	45kg (without insert)

1.7 Temperature Specifications

1.7.1 ADT850 Long (Deep) Immersion

Table 1.7.1 ADT850 Long (Deep) Immersion

Specifications	Base Metal (Empty chamber)	Base Metal (Cup Insert)	Base Metal (Multi-hole insert)	Noble Metal (ϕ 20 alumina tube)
Axial Uniformity	$\leq 0.4^{\circ}\text{C}$ (from geometrical center $\pm 30\text{mm}$) [1]	$\leq 0.5^{\circ}\text{C}$ (from bottom of the insert -30mm) [2]	$\leq 0.5^{\circ}\text{C}$ (from bottom of the insert -30mm)	$\leq 0.4^{\circ}\text{C}/10\text{mm}$ (from geometrical center $\pm 20\text{mm}$)
Radial Uniformity	$\leq 0.2^{\circ}\text{C}$ (from geometrical center $\pm 14\text{mm}$)	$\leq 0.2^{\circ}\text{C}$ (from geometrical center $\pm 14\text{mm}$)	$\leq 0.2^{\circ}\text{C}$ (from geometrical center $\pm 14\text{mm}$)	---

[1] From the geometrical center to surface: 220mm;

[2] From the bottom of insert to surface: 240mm;

Note: Factory calibration is limited to empty chamber mode, and all modes guarantee specifications

1.7.2 ADT850 Short Immersion

Table1.7.2 ADT850 Short Immersion

Specifications	Base Metal (Empty chamber)	Base Metal (Cup Insert)	Base Metal (Multi-hole insert)	Noble Metal (ϕ 16alumina tube)
Axial Uniformity	$\leq 1.0^{\circ}\text{C}$ (from geometrical center $\pm 20\text{mm}$) [1]	$\leq 1.0^{\circ}\text{C}$ (from bottom of the insert -30mm) [2]	$\leq 1.0^{\circ}\text{C}$ (from bottom of the insert -30mm)	$\leq 0.4^{\circ}\text{C}/10\text{mm}$ (from geometrical center $\pm 20\text{mm}$)
Radial Uniformity	$\leq 0.5^{\circ}\text{C}$ (from geometrical center $\pm 14\text{mm}$)	$\leq 0.5^{\circ}\text{C}$ (from geometrical center $\pm 14\text{mm}$)	$\leq 0.5^{\circ}\text{C}$ (from geometrical center $\pm 14\text{mm}$)	---

[1] From the geometrical center to surface: 220mm;

[2] From the bottom of insert to surface: 240mm;

Note: Factory calibration is limited to empty chamber mode, and all modes guarantee specifications

1.7.3 ADT850 Annealing furnace

Axial Temperature Field: $1100^{\circ}\text{C}\pm 20^{\circ}\text{C}$;

Annealing Temperature Field: From one end of the temperature field to the working end surface is less than 100mm, Temperature field width 400mm.

1.8 Standard Accessories

Table 1.8.1 ADT850 Standard Accessories

No.	Item/Model	Quantity
1	Main Unit	1
2	Power Code	1
3	Network cable	1
4	Type N Control TC-Left	1
5	Type N Control TC-Middle	1
6	Type N Control TC-Right	1
7	Alumina tube (8 mm OD)	4
8	Fuse, T12A 250V	3
9	Nickle wire (Expt ADT850-1200-ALUM)	1
10	ADT110-850-ALUM (Only for ADT850-1200-ALUM)	1

11	ADT110-850-CUP-LONG (Only for ADT850-1200-CUPL)	1
12	Insulator Set	2
13	Alumina tube 6 mm OD x 4 mm ID x 700 mm L	2
14	Alumina tube 6 mm OD x 4 mm ID x 400 mm L	2
15	Report of test with data	1

2. Operation

2.1 Main Display

Main Display including 2 parts: Status bar and Temperature Controlling interface; as shown in picture 2-1.

1. Status bar: Including time, WIFI, USB status, ACloud, Step setting, Fast cooling, Intelligent Diagnostic Center, Main menu icon;

Note: Except for the time, WIFI, USB, and ACloud, the rest of the icons in the status bar can be clicked for follow-up operations.

2. Temperature Controlling: Including target temperature setting, real-time temperature data, and heating switch.

3. Lock Screen: Click the main menu icon  and select the screen lock, entering the lock screen state, and the rest of the screen is unavailable except for the unlock key .

Unlock Screen: When the screen is locked, click the unlock button  in the upper right corner.

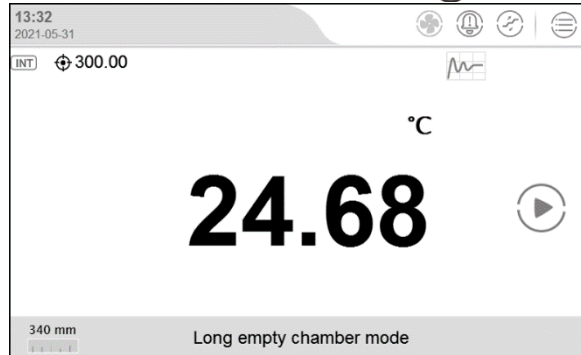

Figure 2-1 Main Display

2.2 Rotation Knob Button Operations

There is a rotation knob button on the right side of the touch screen, which has the following functions:

1. Set Step Points

Turn on the step function and turn the knob button to automatically display the step setting interface, and the step value will be changed with the knob selection in the top left of the screen.

2. Set Target Temperature Value

When the step point function is off, turn the knob button to automatically display the target temperature set point and change the integer value of the target temperature with the rotation. Press and hold the knob for one second to select the decimal value of the target temperature.

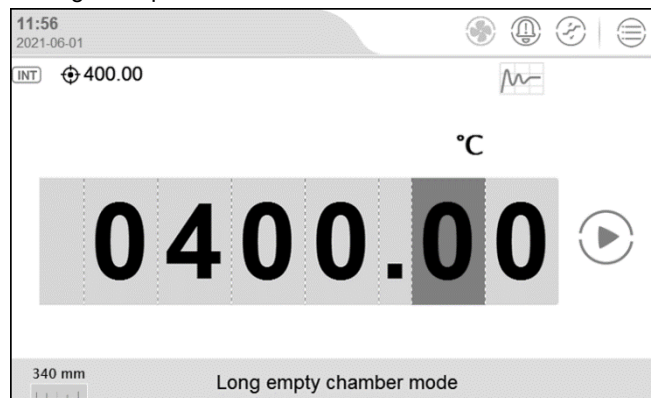

Figure 2-2 Knob button setting temperature point display

3. Start/stop temperature control

Press and hold the rotary button for two seconds and then release it to start the temperature control;
Press and hold the rotary button for two seconds and then release it to pause the temperature control.

4. Menu selection

For example, in the system settings interface, after rotating the button, a yellow check box will appear in the menu. Continue to rotate the button to adjust the position of the yellow check box. When the position of the yellow check box is adjusted to the option you want to click, click the rotate button to select it.

2.3 Step Function

2.3.1 Step Function Settings

Press the step function button  to enter the step function setting interface, see figure 2-3.

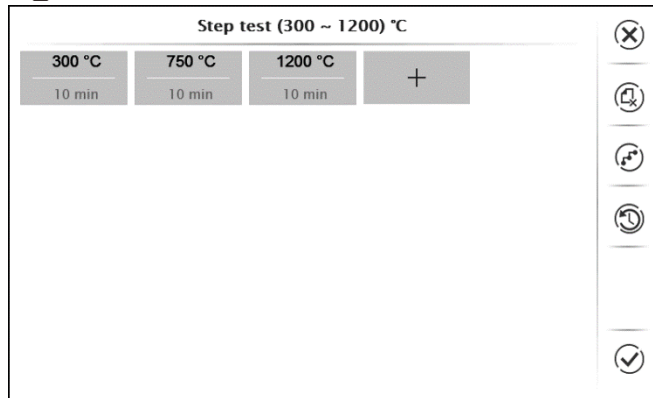







Figure 2-3 Step function setting interface

1. Click the value of each step point to enter the step point editing interface, and edit the stability time and temperature of the step point.



2. Click  to delete the edited step point. Click  to add a step point.
3. Click  to quickly edit the automatic step point.
4. Click  to view the historical data of the edited calibration point.
5. Click the confirm button in the lower right corner to save the edited step point list. The name of the set of step points is required.

2.3.2 Step temperature control:

Click  in the status bar to turn on the step temperature control function. Then the temperature control buttons on the main interface are displayed as the followings:

1. Click  to switch to the previous step point.

*When the step is not running, click to start running the first step point. When the first step is under process, then nothing changes.

2. Click  to start step temperature control.
3. Click  to pause step temperature control.
4. Click  to switch to the next step point.

*When the step is not running, click to start running the second step point. When the last step point is under process, then click  will finish the step process.

2.4 Temperature unit setting:

Users can set the temperature unit through the main menu or the main interface, and the furnace system will automatically switch all relevant temperature units in the system.

1. Main interface: Click the temperature unit displayed on the main interface and select the desired temperature unit.

2. Main menu: Tap the upper right corner of the main interface screen to enter the main menu, and then select System Settings – Personalization - Temperature Unit, then select the desired temperature unit.

2.5 Real-time temperature curve

By clicking the control temperature interface switch button , the user can switch between the temperature value display interface and the temperature curve display interface. The temperature interface displays the temperature value, and the temperature curve interface has three curve display modes, which are automatically switched according to the following states:

1. When in the standby state, the measurement curve is displayed; the horizontal axis is time (hours: minutes), the vertical axis is percentage, 0% represents the lower limit of the current device range, and 100% represents the upper limit of the current device range. The curve indicates the proportion of the current temperature value within the range. Click on the curve area to display the current temperature and the temperature values corresponding to 0% and 100% (expressed in degrees Celsius)

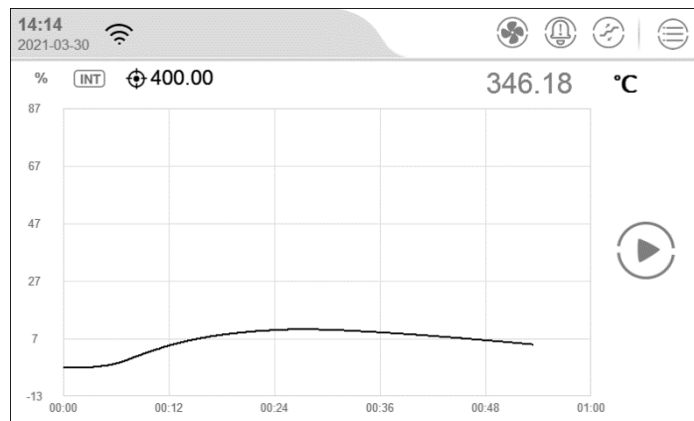

Figure 2-4 Measurement curve in standby state

2. When the temperature of the furnace is under control, the temperature control curve is displayed; the horizontal axis is time (hours: minutes), the vertical axis is percentage, 0% represents the temperature of the equipment during temperature control, and 100% represents the target value of temperature control. The curve indicates the proportion of the temperature range from the beginning of temperature control to the steady state of the current temperature value. Click on the curve area to display the current temperature and the temperature values corresponding to 0% and 100% (in degrees Celsius).

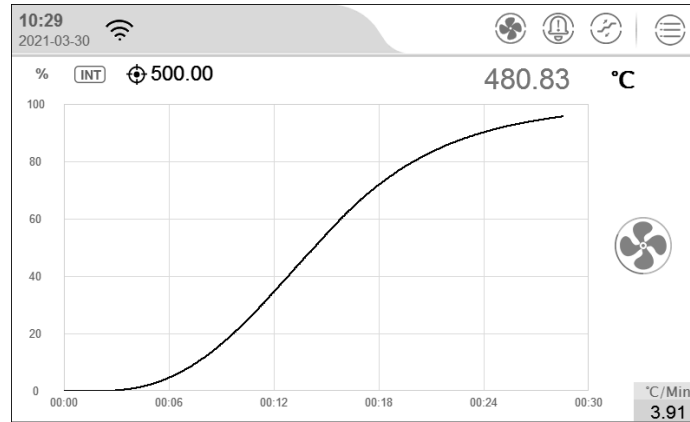

Figure 2-5 Temperature control process curve

3. When the temperature of the furnace is under control and stable, the volatility curve is displayed; the horizontal axis is time (hours: minutes), and the vertical axis is the temperature control volatility (unit: mk). The curve shows that the current temperature fluctuates around the target value. Click on the curve area to display the current temperature value (in degrees Celsius).

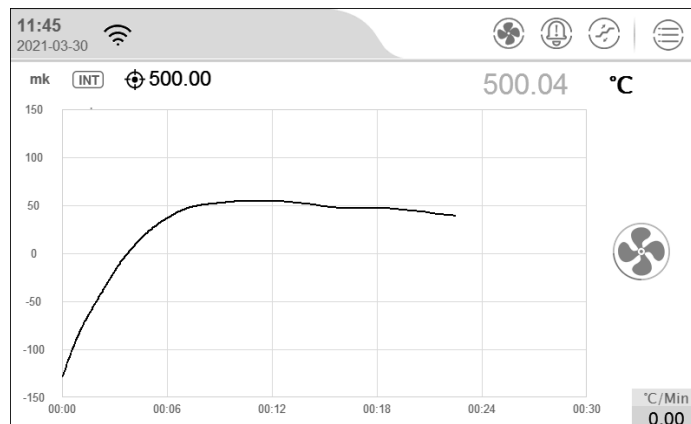

Figure 2-6 Temperature fluctuation curve after stabilization

- 1) Unit setting: indicates the current temperature unit, click on the unit to change the unit nomenclature.
- 2) Temperature value: indicates the current measured temperature value, click this value to set the target temperature value.
- 3) Temperature control button: this toggle is used to start/stop the temperature control operation; when the temperature control is started, the real-time temperature control rate will be displayed below the button. As shown in Figure 2-4.

2.6 Temperature control

2.6.1 Temperature control mode selection:

The ADT850 furnace has 9 working modes. Each working mode corresponds to a different display mode.

The functions of the 9 modes are as follows:

1. Base metal + long furnace + empty chamber

Use the bracket and ruler to install the thermocouples so that the distance between the measuring end and the working end surface is 340mm.

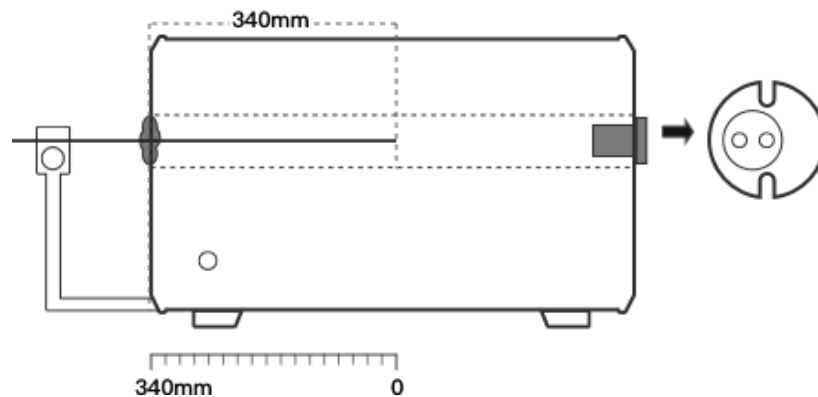

Figure 2-7 Base metal TC + long furnace + empty chamber mode

2. Base metal + long furnace + cup

Install the long cup on the bracket, insert the thermocouples into the bottom of the cup, and push the bracket so that the 340mm scale on the guide rail is aligned with the position of the pointer.

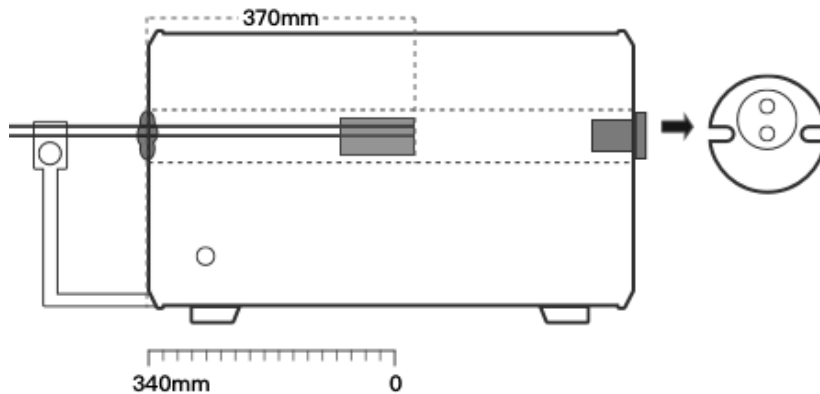

Figure 2-8 Base metal + long furnace + cup insert

3. Base metal + long furnace + multi-hole insert

Install the long multi-hole insert on the bracket, insert the thermocouples into the bottom of the insert, and push the bracket so that the 340mm scale on the guide rail is aligned with the position of the pointer.

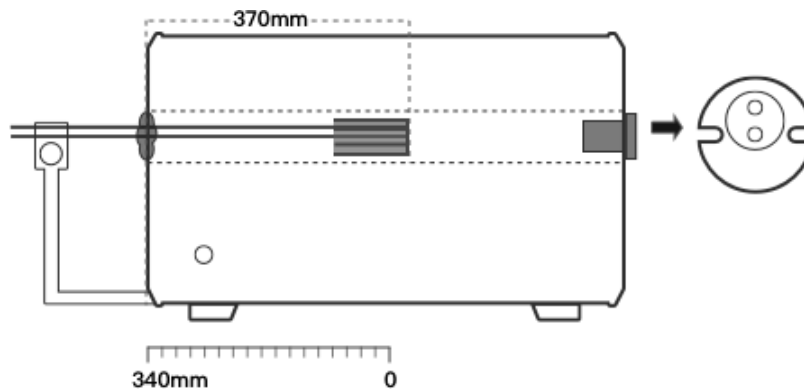

Figure 2-9 Base metal + long furnace + multi-hole insert

4. Noble metal + long furnace + $\phi 20\text{mm}$ alumina tube

Install the $\phi 20\text{mm}$ alumina tube into the furnace so that the distance between the measured end and the working end is 340mm.

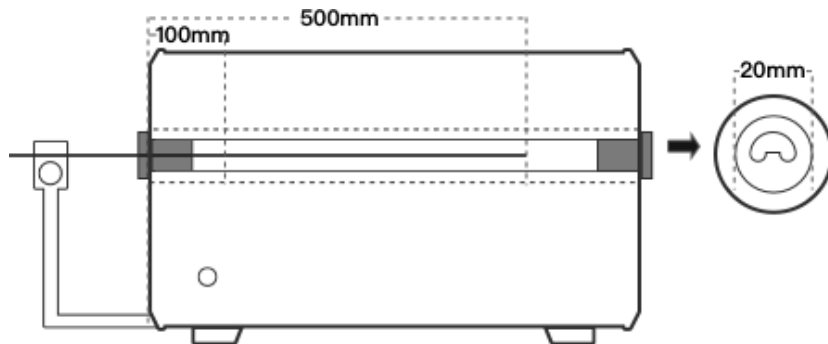

Figure 2-10 Noble metal + long furnace + \varnothing 20mm alumina tube

5. Base metal + short furnace + empty chamber

Use the bracket and ruler to install the thermocouples so that the distance between the measuring end and the working end surface is 220mm.

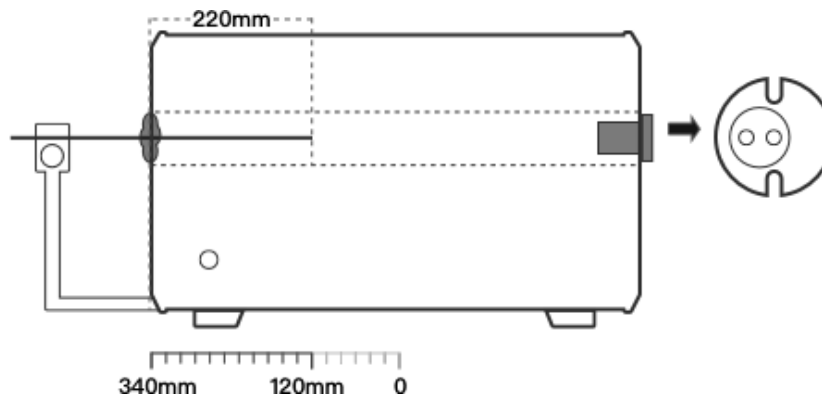

Figure 2-11 Base metal + short furnace + empty chamber

6. Base metal + short furnace + cup

Install the short cup on the bracket, insert the thermocouples into the bottom of the cup, and push the bracket so that the 340mm scale on the rail is aligned with the pointer.

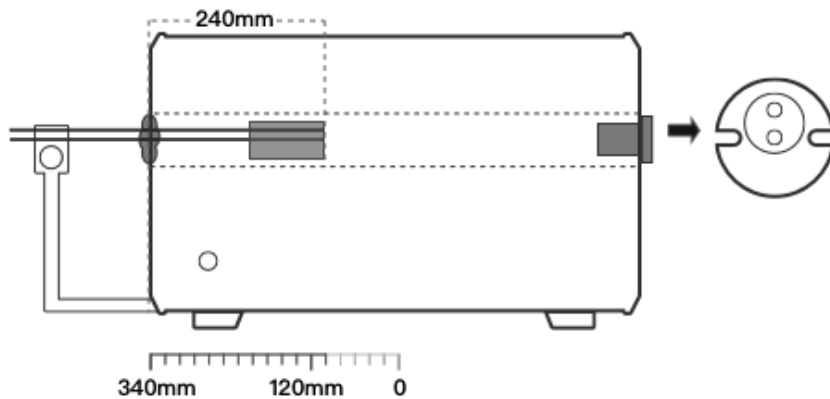

Figure 2-12 Base metal + short furnace + cup design insert

7. Base metal + short furnace + multi-hole insert

Install the short multi-hole insert on the bracket, insert the thermocouples into the bottom of the insert, push the support so that the 340mm scale on the guide rail is aligned with the position of the pointer.

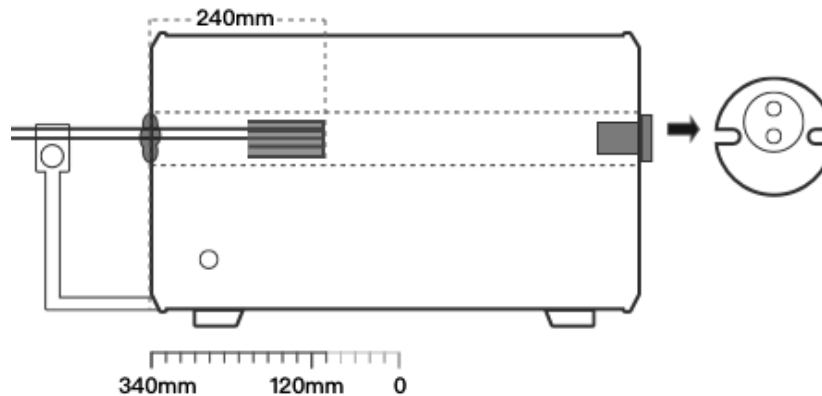

Figure 2-13 Base metal + short furnace + multi-hole design insert

8. Noble metal + $\phi 16\text{mm}$ alumina tube

Install $\phi 16\text{mm}$ alumina tube into the furnace so that the distance between the measured end and the working end is 220mm.

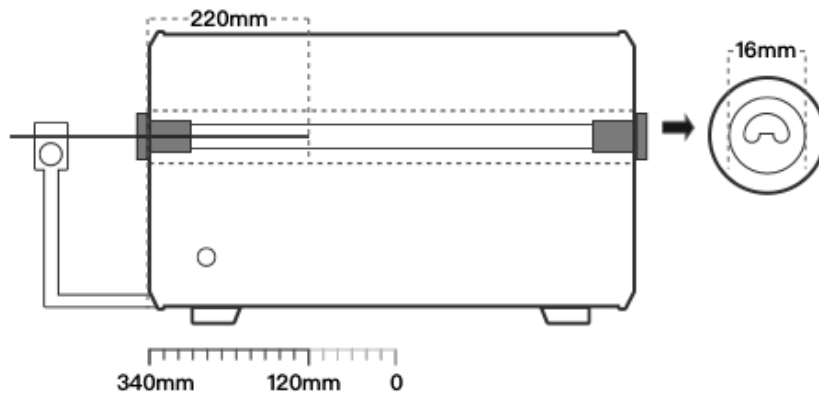

Figure 2-14 Noble metal + $\phi 16\text{mm}$ alumina tube

9. Annealing

Install $\phi 20\text{mm}$ alumina tube into the furnace so that the distance between the measuring end and the working end surface is 500mm.

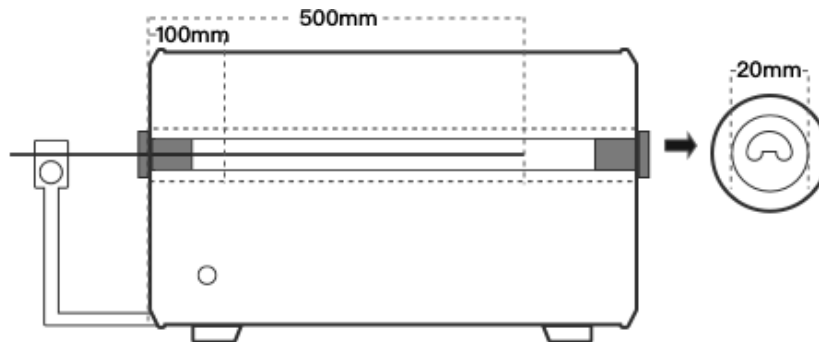

Figure 2-15 Annealing

2.6.2 Temperature control settings

Temperature control parameters will affect the temperature control performance of the device. Users can adjust related parameters according to actual needs. The description of each parameter is shown in the following table:

1. Control parameters

Table 2.6.1 Control Parameter

Subject	Valid Value	Comment
---------	-------------	---------

Stability	0.01-10	One of the conditions for determining the stability of temperature control, and the temperature fluctuation within this range is deemed to meet this condition
Stability Time	(1~120) min	One of the conditions for determining the stability of temperature control, the temperature control stability duration exceeding the set value is deemed to meet this condition.
Set Point Tolerance	Depends on temperature unit	One of the conditions for determining the stability of temperature control. If the difference between the measured temperature and the set point is within this range, this condition is deemed to be satisfied.
Control Rate	Fastest, custom (depends on temperature unit)	The temperature control rate, select the maximum or custom rate, the custom rate can be adjusted by the progress bar or input through the keyboard by clicking the number below.
Control Mode	9 modes	<ol style="list-style-type: none"> 1. Long empty chamber: typically used for base metal calibrations 2. Long cup: typically used for base metal calibrations 3. Long insert: typically used for base metal calibrations

		<p>4. Long alumina tube: + ϕ20mm alumina tube: typically used for noble metal calibrations</p> <p>5. Short empty chamber: typically used for base metal calibrations</p> <p>6. Short cup: typically used for base metal calibrations</p> <p>7. Short insert: typically used for base metal calibrations</p> <p>8. Short alumina tub: + ϕ16mm alumina tube: typically used for noble metal calibrations</p> <p>9. Annealing</p>
Power Frequency	50Hz, 60Hz	The Frequency of power supply
Set Point Limit	Enable/Disable	Limit temperature control range
<p>Set Point Limit Restriction Range (When set point limit is enabled)</p>	Depends on model and unit	After a set point limit is selected, the temperature control target value cannot exceed this range.

Set point soft shutdown	Enable/disable	Set whether to enable the set point soft shutdown. When it is enabled and during the temperature control process, when the temperature is greater than the sum of the set point and the set point soft shutdown difference, it will automatically switch to the standby state.
Set point soft shutdown value (when set point soft shutdown is enabled)	Enable/disable	After setting this value, during the temperature control process, the indicated value cannot exceed the sum of the set point and the soft shutdown difference of the set point.

2. Temperature control reference

Table 2.6.2 Reference parameters

Subject	Valid Value	Comment
Select Reference	INT/EXT	Select the internal (INT) or external (EXT) reference control.
Temperature control resolution	1, 0.1, 0.01	Temperature display resolution
Filter coefficient	0.010-1.000	First-order filter coefficient of temperature value

Sensor signal	Read Only	Display the original signal and temperature value of the sensor
---------------	-----------	---

2.6.3 Target temperature input

Click on the zone of target temperature or real-time temperature data, input the target temperature in the presenting keypad. The set point of target temperature should comply with the displayed temperature range, this range is limited by target model and user-defined set point. After finishing the temperature set point, click on Enter or $\sqrt{\quad}$ to confirm, then the furnace will start control the temperature automatically.



2.6.4 Start/Pause Temperature Control

During the process, temperature control can be started or paused by pressing START or PAUSE on the right of the furnace temperature display screen.

2.6.5 Temperature Control Stabilization

Temperature control will stabilize when the conditions of fluctuation degree, stabilization time and target deviation are met. The display value will turn green accompanied by a beep when the unit is stable. When the value turns red, it means the temperature is beyond the upper limit. In this case, there will be continuous alarm sound.

2.6.6 Fast cooling

When the temperature is higher than 50C, the button  will be available for fast cooling. Click on it to start the fan for fast cooling. When the temperature is lower than 50C, the fan will be disabled automatically and the button  will be unavailable.

2.7 Intelligent diagnose center

It can be used for checking the status of all the modules.

Click on the icon  to see the history log.

2.7.1 N type TC diagnose

Click on the icon  to enter the page of N coupler diagnose. As below:

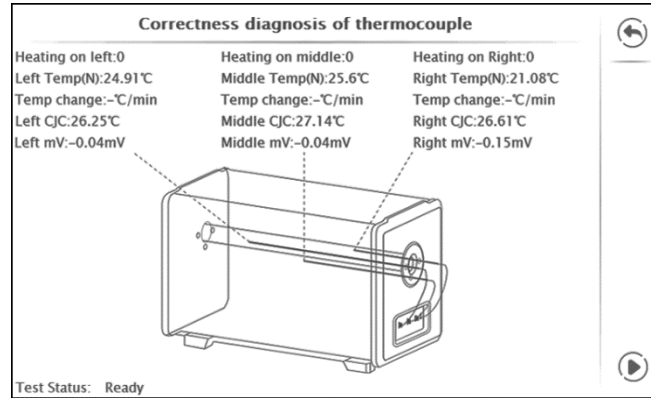

Figure 2-16 N Type TC correctness diagnose page

The N type TC correctness diagnose page shows the corresponding power, temperature value, as well as the temperature change rate during calibrating, cold junction value and mV signal of LEFT TC、MID.TC、RIGHT TC. Click on the icon in right bottom to start the test. Procedures are as below:

1. Set the left side power at 0.5, middle and right side at 0, keep for two minutes. Check the left thermocouple, when the temperature changes more than 5C/min on left side, the N coupler can be seen as correct, then the N coupler on right side will be checked. Otherwise, the connection of left N coupler is wrong, then there will be a window which notice the user to check the position of coupler and plug. After checking, click on the start key at right bottom to restart the check on left N coupler.

2. Set the right side power at 0.5, middle and left side at 0, keep for two minutes. Check the right thermocouple, when the temperature changes more than 5C/min on right side, the N coupler can be seen as correct, then the diagnose is finished. Otherwise, the connection of right N coupler is wrong, then there will be a window which notice the user to check the position of coupler and plug. After checking, click on the start key at right bottom to restart the check on right N coupler.

3. Setup

In the main page, click on the menu as shown in Fig.3-1. Select system setting to enter, as shown in Fig.3-2. This page contains control settings, sensor library, Acloud services, system services, personalization and product information.

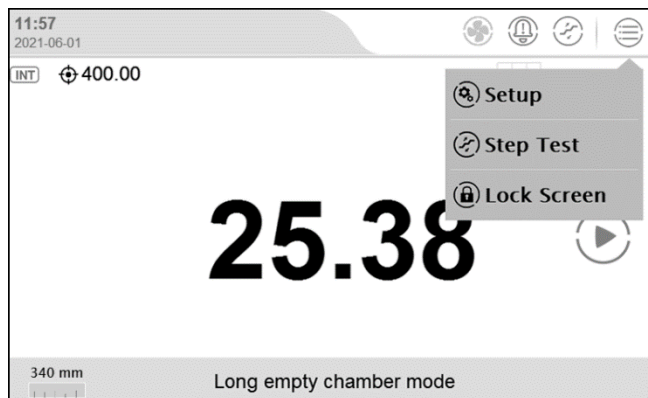

Figure 3-1 Main Menu Display

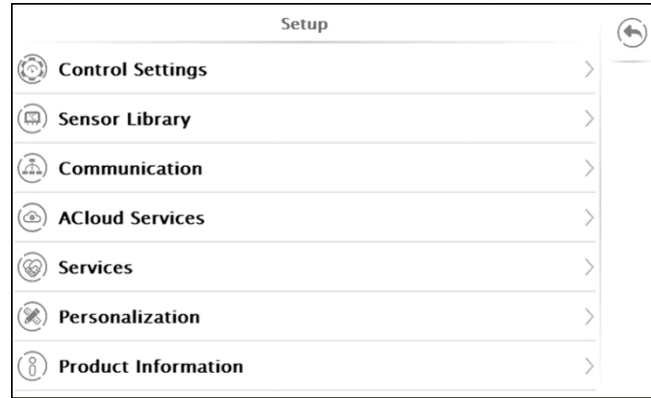

Figure 3-2 System Setup Display

3.1 Control settings

Refer to section.2.5.1.

3.2 Sensor Library

The intelligent furnace provides the function of sensor library. Sensor information can be stored in the library for future management. Only thermocouple can be supported.

3.2.1 Management Functions

In the page of sensor library, click on (+) to add a new sensor. Click on (-) to remove one.

3.2.2 Standard thermocouple specifications

Table 3.2.1 Standard thermocouple specifications

Subject	Valid Value	Explanation
Type/Name	Alphanumeric content (14 max length)	TC type and name information
Serial Number	Alphanumeric content (14 max length)	TC serial number
Temperature range	Depends on the temperature units	TC measurement range, click to switch between units.
Base TC Sensor	S/B	Reference TC type, it determines different type of parameter.
Parameter type(only for S coupler)	a_b_c/Zn_Al_Cu/Zn_Sb_Cu	Standard S coupler's parameter type, correspond to different certifications.
mV (xxxx°C)	Number	mV value of standard TC for the correspond temperature, depends on the calibration certification.
Calibration date	2000/1/1~2099/12/31	TC calibration date

Date for next calibration	2000/1/1~2099/12/31	TC calibration expiration time
Note	Alphanumeric content (14 max length).	TC note information

3.3 Communication Settings

3.3.1 Ethernet

Connect the furnace to a computer through the Network cable.

Table 3.3.1 Ethernet Address Acquisition Ways

Subject	Valid Value	Explanation
Address Acquisition	DHCP/ Manual	Choose Furnace address for acquisition way

◆When the DHCP mode is selected, the contents in the table below are automatically assigned by the system and become read-only items.

◆When the manual method is selected, the following table needs to be filled in manually.

Table 3.3.2 Ethernet Address Manually Settings

Subject	Valid Value	Explanation
IP Address	0.0.0.0 ~ 255.255.255.255	Furnace IP address
Subnet Mask	0.0.0.0 ~ 255.255.255.255	Furnace subnet mask

Gateway	0.0.0.0 ~ 255.255.255.255	Furnace gateway
---------	---------------------------	-----------------

The port number and physical address are factory set and cannot be changed.

Click on the  at lower right corner of the screen to confirm the settings.

3.3.2 Wireless communication

Connect the furnace to a computer through Wi-Fi.

Table 3.3.3 Wireless Settings

Subject	Valid Value	Explanation
WLAN	On / Off	Enable or disable Wi-Fi communication function
WI-FI	Depends on network environment	Select WI-FI access point
Advanced Option	DHCP/ Manual	Select furnace address acquisition way

The port number and physical address are factory set and cannot be changed.

(1) When the DHCP option is selected as the advanced option, the following table is automatically assigned by the system and becomes a read-only item.

(2) When selecting the manual method for advanced options, the following table needs to be filled in manually.

Table 3.3.4 Wi-Fi Communication Manually Settings

Subject	Valid Value	Explanation
IP Address	0.0.0.0 ~ 255.255.255.255	Furnace IP address

Subnet Mask	0.0.0.0 ~ 255.255.255.255	Furnace subnet mask
Gateway	0.0.0.0 ~ 255.255.255.255	Furnace gateway



Click on the  at lower right corner of the screen to confirm the settings.

The wireless communication settings take effect directly, without confirming the operation, click on  at the upper right corner of the screen to return to the previous menu.







3.4 ACloud Services

The furnace can access to the ACloud service through Ethernet and Wi-Fi communication. Additel Link (offers clients on mobile APP and PC) makes it possible for users to monitor the real-time status and data at anytime and anywhere, as well as to remotely access to the device and improve the efficiency.

3.4.1 Start

When the service is not started, the ACloud status is empty. When service started and runs normally, the status is shown as . When the service is started but without a connection with the ACloud service, the status is shown as .

3.4.2 Additel Link

The page of Additel Link is used for presenting the organization of current device and basic user information, including organization name, authorized user name which can monitor the device, registered email account and whether it is being monitored or not.  indicates that this user is monitoring the current device.  indicates a non-monitored status. Button  on the right is used for going back to upper page. Button  is used for unbind the device with the organization. Button  for manually refresh the information of the organization and user. Button  for showing the QR code and bind with the organization. (the QR code will disappear after scanning by APP, it can also be closed by clicking on the code. it needs to open the QR code when binding)

3.5 System Services

3.5.1 System Calibration

The Calibration Furnace includes the feature/procedure of self-calibration, electric calibration, controlled coupler setting, reading calibration, temperature field calibration and data log. Users need to enter a password to enter the system calibration page, and the factory default password is 123456. For the detailed operation, please refer to Calibration manual of The Calibration Furnace.

3.5.2 Repair and maintenance

Enter password to open this function, default password is 123456.

- ◆ Repair log: view and edit the repair information.
- ◆ Calibration log: view the calibration log.
- ◆ Export data log: insert a USB disc and click on export data log,
- ◆ Edit control mode: set the TC default insert depth for nine modes, For the range, refer to the page information.

3.5.3 Restore Factory Settings

The furnace calibrator provides the function of restoring the factory settings. A password is required to enable this function. The factory default password is 123456.

◆ In order to ensure data safety, restoring to factory setting will not erase the calibration data. There is a specific operation for providing maintenance to the calibration data in the system.

◆ After restoring the factory settings, the user needs to set the time after powering on again. For details, please refer to Para.3.6.2 Date and Time.

3.5.4 System Updates

The furnace calibrator provides a firmware upgrade function.

◆USB disk needs to be used for local USB disk upgrade operation, the USB disk format needs to be FAT16 or FAT32 Format.

Operation:

1. Copy the upgrade file to the root directory of the USB disk.
2. Insert the USB disk into the USB socket on the rear side of the furnace calibrator.
3. Choose to upgrade via USB in the furnace calibrator upgrade interface.
4. Click until the system starts to upgrade automatically.
5. After waiting a few minutes for the upgrade process to complete, the system will automatically display the

upgrade completion message.

3.6 Personalization

3.6.1 Temperature Units

Three units are available: °C, °F, and K.

◆Once this unit is changed, all related temperature units for other menus will be changed automatically,

3.6.2 Date and Time

Table 3.6.1 Date and Time

Subject	Valid Value	Explanation
Time	00:00 ~ 23:59	Time setting
Date	2000-1-1 ~ 2099-12-31	Date setting
Date format	Y-M-D / M-D-Y / D-M-Y	Date format setting
Date separator	-, /, .	Date separator setting

24hours	Open /close	24-hour or 12-hour format
Time zones	UTC-12:00~UTC+12:00	Set device time zone

3.6.3 Language

The Calibration Furnace is equipped with a multi-language user interface. Use this menu to change from the offered languages.

◆ After the language interface is selected, the furnace calibrator needs to be restarted for the changes to take effect.

3.6.4 Sound

Table 3.6.2 Sound list

Subject	Valid Value	Explanation
Touch Beep	On / Off	Touch Beep setting
Prompt Beep	On / Off	Prompt Beep setting
Over range beep	On / Off	Over range beep setting
Stable beep	On / Off	Stable beep

3.6.5 Preset management

The device provides the preset management operations.

◆ Preset standby:

1. Set to open or close the Preset standby function
2. Set the start time of standby mode.

◆Preset temperature control:

1. Set to open or close the Preset temperature control function.
2. Set the set point of preset temperature control.
3. Set the start time of temperature control.

3.7 Product information

Furnace information is read only: basic information, version and information and operation information.

1. Basic information: Including model, serial number and range information.
2. Version information: Including main host, system version, control board, DTM information and Wi-Fi information.

◆The firmware version number normally means the main board version number, please provide it to the customer service if necessary.

4. Copyright

Additel owns all copyrights to this system and reserves all rights. Please respect the rights of our company.

Additel Corporation

2900 Saturn Street #B

Brea, CA 92821 USA

Attn: Jenny Pu

Phone: 714-998-6899

Email: service@additel.com