

Test&Measurement

YOKOGAWA 

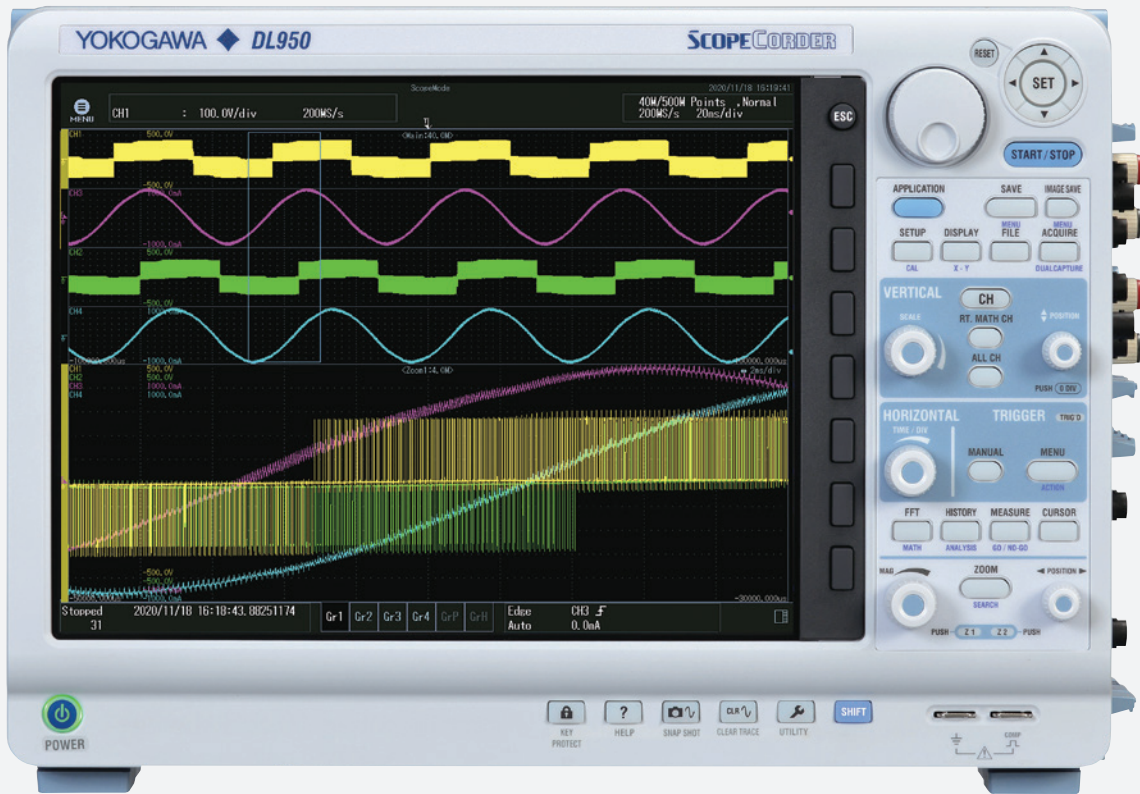

SCOPECORDER

Versatility to discover more

DL950 ScopeCorder

Precision Making

Bulletin DL950-01EN

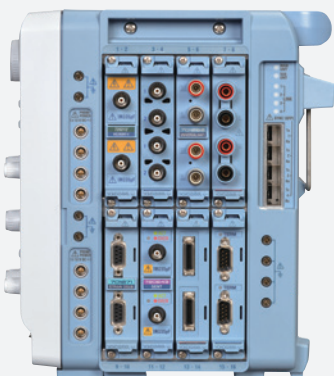

Efforts to protect the global environment, as represented by the United Nations Sustainable Development Goals (SDGs), are spreading on a global scale. In order to achieve a decarbonized society and eliminate the need for fossil fuels, new renewable energy sources and energy efficient technologies for transportation, home, and industrial appliances are being developed.

To minimize energy losses and to optimize efficiency of designs, engineers require a detailed understanding of their application's electrical and mechanical behavior. The DL950 ScopeCorder captures and analyzes a wide variety of electrical, physical sensor signals and serial buses. It offers a unique combination of high sampling rates, for a detailed view and long recording times to monitor trends over time.

The DL950 will quickly become the most valued instrument in your lab.

Insight – Analyze the finest waveform details while observing multi-channel measurements over longer periods of time. The DL950 offers a unique combination of high-speed sampling and signal fidelity of an oscilloscope and the long-term data recording capabilities of a recorder. The DL950 measures signals at a high bit resolution and secures data in the harshest environments with superior noise-immunity and isolation technology.

Versatility – The eight available slots can be equipped with a selection of over 20 types of input modules, to combine measurements of electrical signals, mechanical performance parameters indicated by sensors, and decoded vehicle serial bus signals. For even more channels, up to five DL950s can be synchronized.

Usability – A new application menu simplifies the pre-measurement setup of various applications. A large touch screen is also provided for ease of use and visibility.



Insight, Versatility, Usability

Engineers across the world work with a goal of leaving behind a green planet for the next generation. What can be done to support them from a data collection perspective?

Yokogawa has the answer.

- ✓ 200 MS/s high-speed sample rate
- ✓ 8 G points large memory
- ✓ Long recording to internal flash memory at 20 MS/s
- ✓ 10 Gbps Ethernet high-speed data transfer
- ✓ Up to 160-CH of multi-unit synchronized operation

SCOPECORDER

DL950

200 MS/s high-speed sampling 10 GE high-speed data transfer

The DL950 captures any abnormal signal at a sample rate of up to 200 MS/s. Even large data can be transferred to a PC quickly with 10 Gbps Ethernet's ultra high-speed communication.



Isolated plug-in modules, multiunit synchronization

A variety of plug-in modules are available for isolated voltage, temperature, acceleration, strain measurement, and more. Up to 160 channels of synchronized measurements are supported.



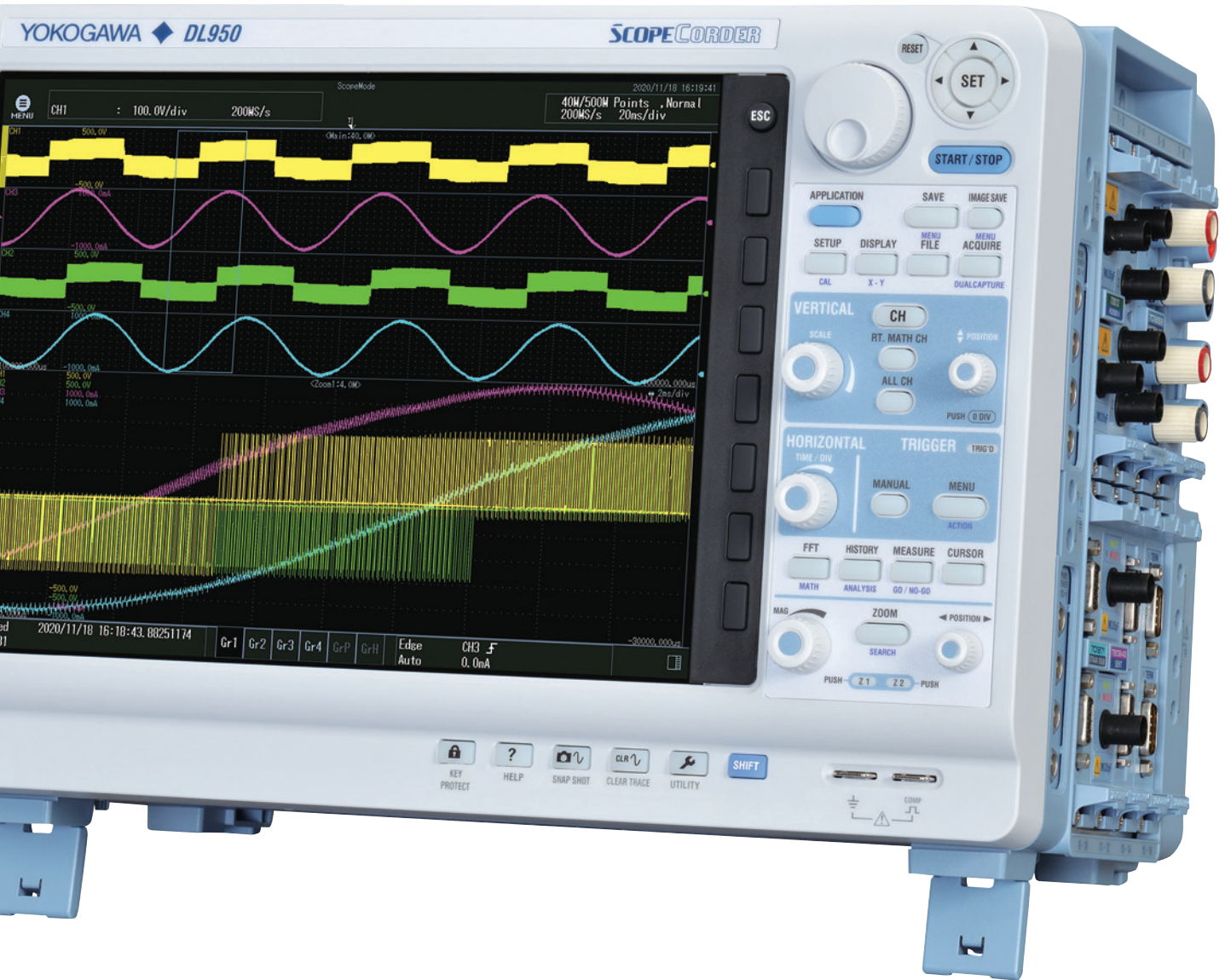

Touch screen application menu

The 12.1-inch large touch screen enables an intuitive operation. The newly designed application menu makes it easy to set up frequently-used applications.



In-vehicle serial bus analysis

Trend waveforms of data from major automotive serial buses such as CAN FD, CAN, LIN, and SENT are displayed with voltage, temperature, and other parameters.



Like a high speed DAQ or long memory oscilloscope



New high-speed module and 10 Gbps Ethernet

200 MS/s 14 Bit Isolation Module

Accurately captures switching waveforms of inverters and fast-moving noises around the power supply.

- Isolated input of up to 1000 V
- ADC resolution 14 bit
- Wide band of 40 MHz
- Up to 20 seconds of continuous acquisition



10 GE data transfer (/C60 option)

Using 10 Gbps Ethernet, up to 10 MS/s of data can be stored in real time on a PC. An SFP+ module, a fiber optic cord, and the PC software IS8000 are used for data transfer.

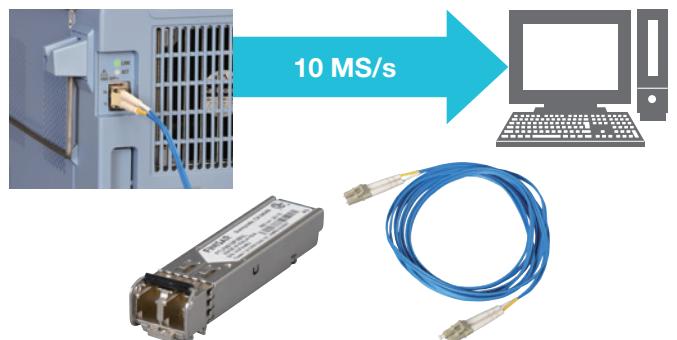

*Please use a commercially available SFP+ module and a 10 GE fiber optic cord.

8 G points large memory (/M2 option)

With up to 8 G points of memory and 20 seconds of continuous capturing, even at 200 MS/s, no signal changes are missed.

*Up to 4 G points of memory is allocated per channel.

Maximum capturable time to memory (with /M2 option)

Sample Rate	For 1 CH	For 2 CH	For 4 CH	For 8 CH	For 16 CH	For 32 CH
200 MS/s	20 s	20 s	10 s	5 s	2 s	1 s
100 MS/s	40 s	40 s	20 s	10 s	5 s	2 s
50 MS/s	1 m	1 m	40 s	20 s	10 s	5 s
20 MS/s	3 m 20 s	3 m 20 s	1 m 40 s	50 s	20 s	10 s
10 MS/s	5 m	5 m	3 m 20 s	1 m 40 s	50 s	20 s
1 MS/s	1 h	1 h	30 m	10 m	5 m	3 m 20 s

SSD recording (/ST1 option)

The 512 GB internal SSD can record for long periods of time at up to 2 MS/s. Waveforms from dual capture can also be recorded, which is useful for in-vehicle endurance testing and capturing rare spontaneous events.

Maximum capturable time to SSD (with /M2 option)

Sample Rate	For 1 CH	For 2 CH	For 4 CH	For 8 CH	For 16 CH	For 32 CH
2 MS/s	5 h	—	—	—	—	—
1 MS/s	10 h	10 h	—	—	—	—
200 kS/s	60 h	60 h	60 h	40 h	20 h	—
100 kS/s	5 days	5 days	5 days	3 days	40 h	20 h
10 kS/s	50 days	50 days	50 days	30 days	10 days	5 days
1 kS/s	50 days	50 days	50 days	50 days	50 days	50 days

Flash acquisition (coming soon)

Long time recording at up to 20 MS/s, which is 100 times faster than the previous model, is available. You can capture data anywhere you cannot bring a PC such as on-vehicle or field testing. The flash memory is non-volatile, so the captured data stays in the instrument even after turning off the power. Data can later be transferred to a PC.

Multi-sample rates

Sample rates can be set by channel. Reducing the sample rate reduces the amount of data even when modules with high and low sample rates are mixed together. This allows for less memory space to be used and improves the transfer speed.

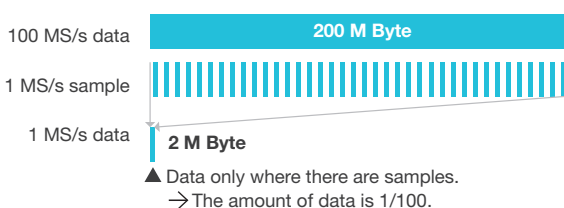

Summary of each recording mode

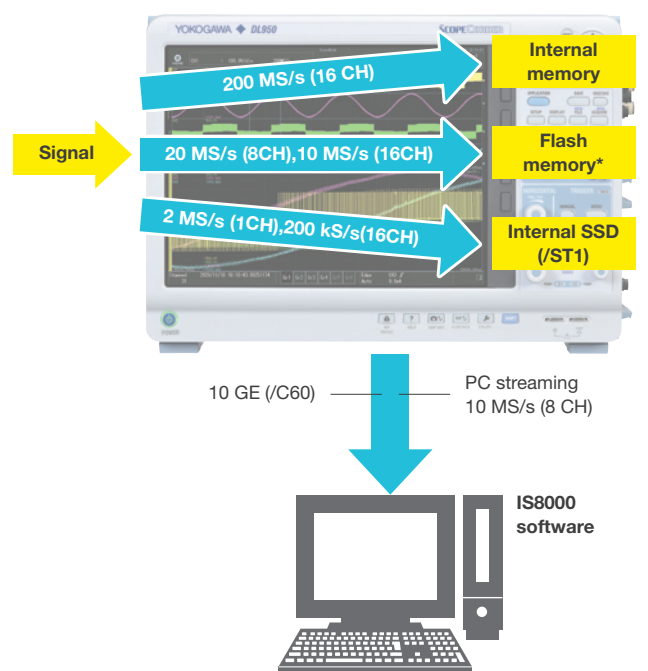

*Recording to flash memory will be coming soon.

Versatile and integrated measurements



Multi-unit and instrument synchronous measurement



**200 MS/s 14 Bit Isolation Module
720212**

- Isolated input of up to 1000 V
- ADC resolution 14-bit
- Wide band of 40 MHz
- Up to 20 seconds of continuous acquisition



**4-CH 10 MS/s 16 Bit Isolation Module
720256**

- ADC resolution 16-bit
- Multipoint measurement of up to 32-CH by using eight slots
- Up to 160-CH by synchronizing multiple DL950s

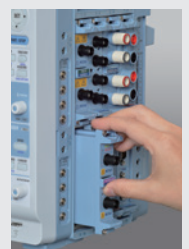

Voltage
100 MS/s
720211

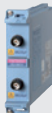

Voltage
10 MS/s
720250



Voltage
1 MS/s
701251



Voltage
1 MS/s,
4-CH input
720254



Voltage
10 MS/s,
Non-isolated
701255



Voltage
1 MS/s,
High voltage
720268



Voltage,
Temperature
100 kS/s
701261



Voltage,
Temperature
100 kS/s, with AAF
701262



Voltage,
Temperature
High sensitivity
701265



Voltage, Temperature
High sensitivity,
Low noise
720266



Voltage,
Temperature
(scan method)
720221



Strain
NDIS
701270



Strain
DSUB
701271



Acceleration,
Voltage
701275



Frequency
720281



Logic
720230



CAN/CAN FD
720242



CAN, LIN
720241



SENT
720243

Multi-unit synchronization of up to 160-CH (/C50 option)

The number of channels can be extended up to 160 by connecting up to four sub units to a single main unit with optical fiber cords. Synchronize measure start/stop, trigger, and sample clock of the sub units from the main unit.

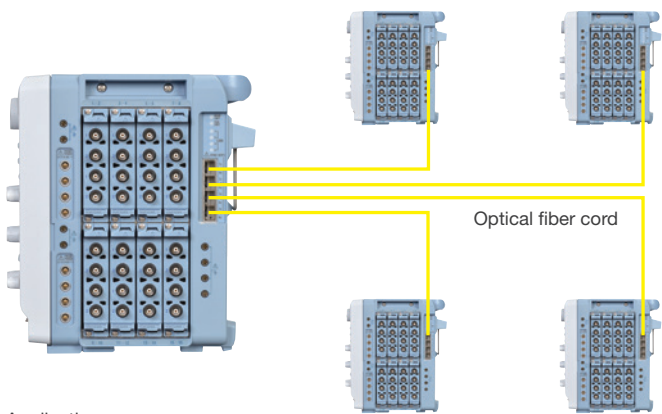

Applications

- Battery cell evaluation
- Multi-point vibration analysis
- Multi-point strain test

*Please use the Optical Transceiver Module 720941 and the Optical Fiber Cord 720942.

IEEE1588*/IRIG and GPS time synchronization (/C35, /C40 option)

Time synchronization with IEEE1588 signals is available. With the /C40 option, the DL950 can output IEEE1588 master signals. Time synchronization using IRIG and GPIB is also available (/C35 option).

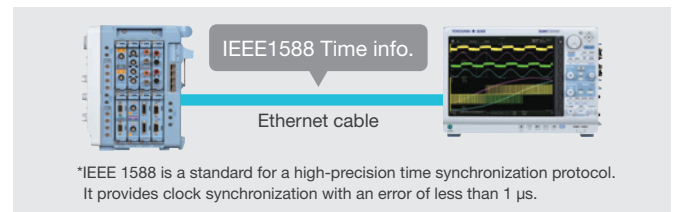

*IEEE 1588 is a standard for a high-precision time synchronization protocol. It provides clock synchronization with an error of less than 1 μ s.

IEEE1588

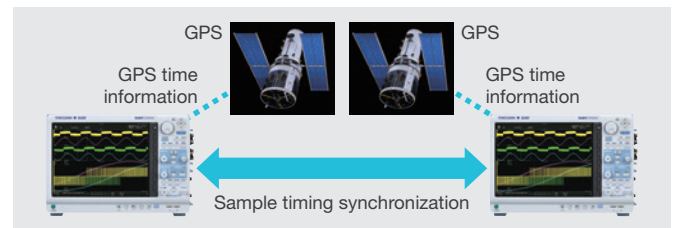

GPS

Integrated measurement with multiple instruments

Integrated measurement software platform IS8000

The IS8000 enables synchronized measurements with DL950s, Yokogawa power meters, other manufacturers' high-speed cameras, and other equipment. It supports measurement setting, remote monitoring, comparative analysis, and MDF file saving to reduce test system development time.



See BU IS8000-01EN for more detail about IS8000.

High-precision synchronized measurement of power values and waveform data

The WT5000 high-precision power analyzer and DL950 support the IEEE1588 standards. This allows measured power values and transient physical quantities to be synchronized with an error of less than 500 μ s and displayed on the IS8000. It is effective for efficiency evaluation and ECU design, which are essential for designing more efficient motor inverters.

PC streaming

By combining the DL950 and IS8000, data can be recorded directly into a PC's storage in real time. Using 10 Gbps Ethernet enables recording at up to 10 MS/s per channel.

Application-Driven Menu

Easy access to frequently-used applications

Touch any application icon and the graphical setup screen appears. Intuitively change the settings prior to measurement by following the wizard screen.

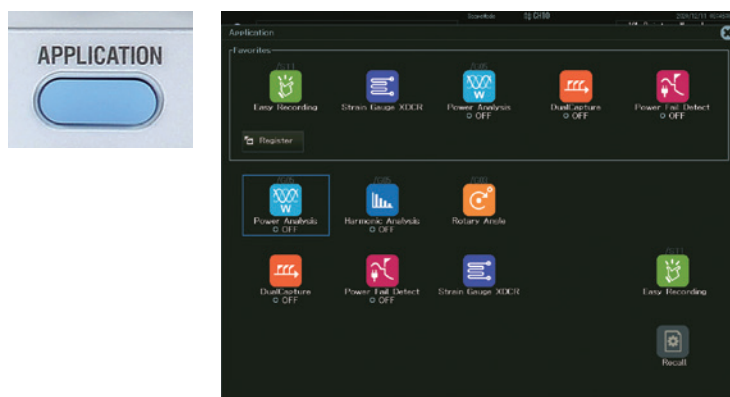

Provided applications

Motor and inverter test

- Power analysis*1
- Harmonics analysis*1
- Encoder rotary angle*2

Long term data recording

- Dual Capture function (low sample monitoring, high sample trigger capturing)
- Simple setting for memory recorder mode

Physical phenomena analysis

- Strain gauge transducer measurement*2

Power line analysis

- Wave Window Trigger

*1 /G05 option is required. *2 /G03 or /G05 option is required.

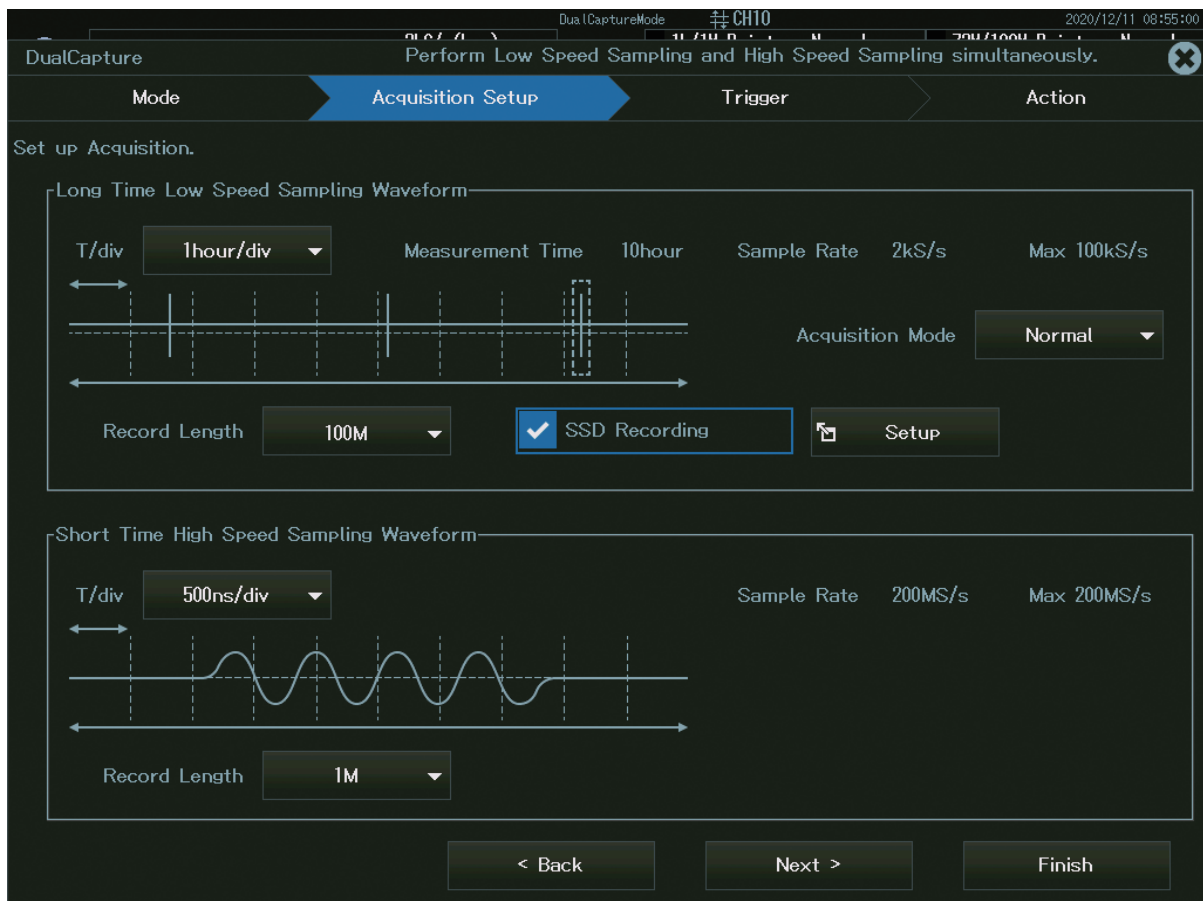



Power and harmonics analysis (/G05 option)

A single DL950 is all you need to evaluate a system with battery-driven motors, such as an EV. The DL950 calculates the conversion efficiency from the input and output power of the inverter and analyzes the effects of harmonics caused by external disturbances while capturing mechanical variations in motor speed and torque.

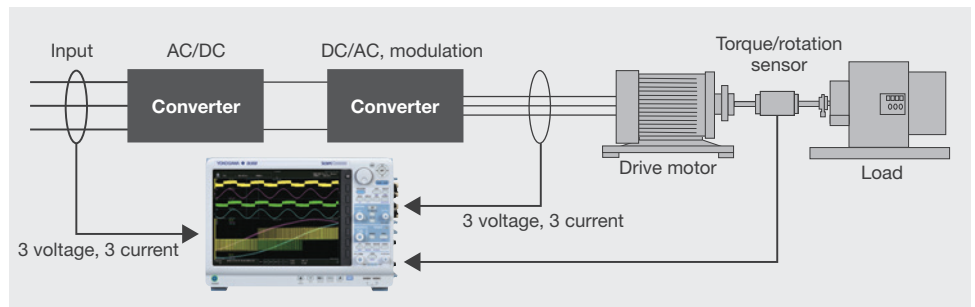

Encoder rotary angle (/G03 or /G05 option)

The DL950 can calculate the rotation angle from the pulses output from an encoder and display the trend of the rotation angle as a waveform. The rotation angle and its control signal can be simultaneously observed and inspected for abnormalities.



Dual capture function

For durability testing, it is necessary to capture transient phenomena with a high-speed sample rate, even when monitoring low-speed data to visualize long-term trends. The dual capture function uniquely resolves these conflicting requirements by simultaneously recording at two different sample rates.

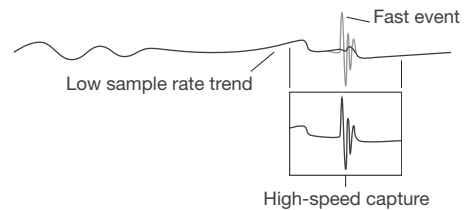

Strain gauge transducer measurement (/G03 or /G05 option)

Load, pressure, and acceleration can be measured by connecting a strain gauge-type transducer such as a load cell or torque sensor. This feature automatically calculates conversions from cumbersome calibration values and enables easy setting.



Power line abnormality detection (Wave Window Trigger)

Special triggers are used to detect frequency fluctuations, voltage drops, and other phenomena that are difficult to detect with ordinary triggers. These triggers can also be used to detect typical power supply problems such as momentary power loss, sags, and surges.

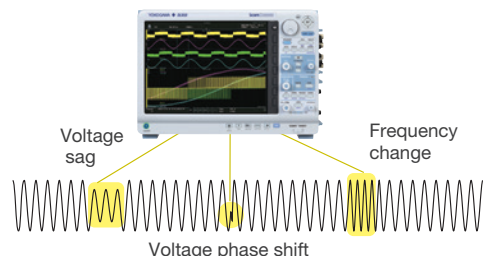

DL950 functions

Real-time mathematical computation (/G03 or /G05 option)

Various calculations are performed on captured signals and the results are displayed on the screen in real time. Perform triggers, automatic waveform parameter measurements, and cursor measurements. Independent input channels, real-time calculation results of 32 input channels plus 16 real time math channels can be displayed and analyzed simultaneously.

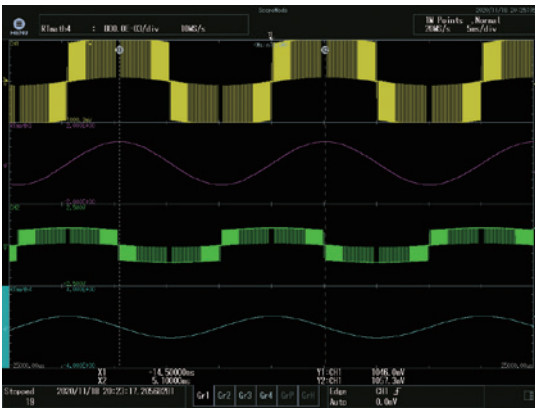

Example: Demodulation of PWM signal

History function

Any abnormalities occurring during repeated waveform measurement will have disappeared by the time they are noticed. Since the DL950 stores up to 5000 waveforms (history waveforms) in the acquisition memory, it is possible to go back and display the abnormal waveforms.

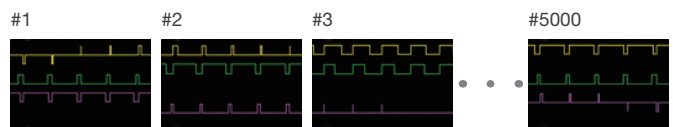

Search for and easily find waveforms from the stored history waveforms and display only those that match specified conditions. Search conditions such as amplitude, frequency, or a zone that a waveform passes through or does not pass through can be specified.

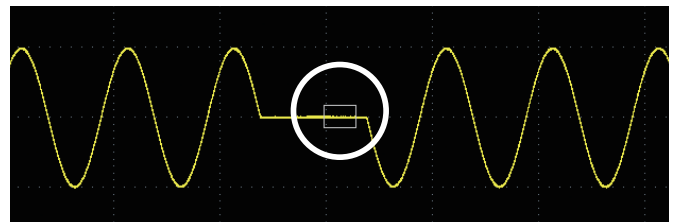

Action on trigger and GO/NO-GO judgement

This performs multiple actions specified in advance when a trigger occurs, such as saving data file, buzzer and email transmission. Also, pass or fail (GO/NO-GO) determination can be performed based on waveform parameters, such as waveform shape or amplitude, and an action can be executed according to the determination results.

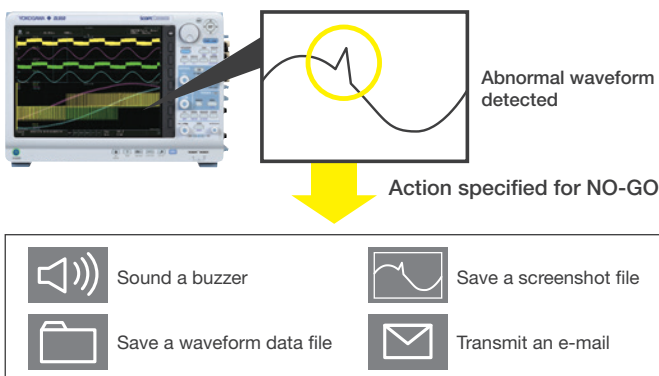

High noise resistance

The DL950 is designed to be resistant to noise and can measure waveforms correctly even when installed close to an inverter. If the touch panel malfunctions, simply turn off the touch panel and use the keys and jog dial to operate it.

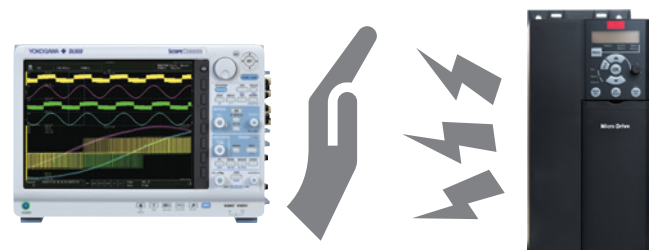

Other functions

- Recorder mode (set the record time and sample interval)
- Up to eight power supplies for current probes (/P8 option)
- Operation with a USB mouse, keyboard, and external printer

Example Applications

Other application examples are on the Yokogawa Web site.

2-motor/4-motor system test for EV

In the development of Hybrid Electric Vehicles (HEVs), a 2-motor or 4-motor system in which a motor is directly connected to each driving wheel is applied. This eliminates powertrains, which enhances the design and removes anxiety when driving a 4WD on a snowy road. The multi-channel/high-speed isolated DL950 can capture signals and analyze them at the same time in the multiple motor systems.

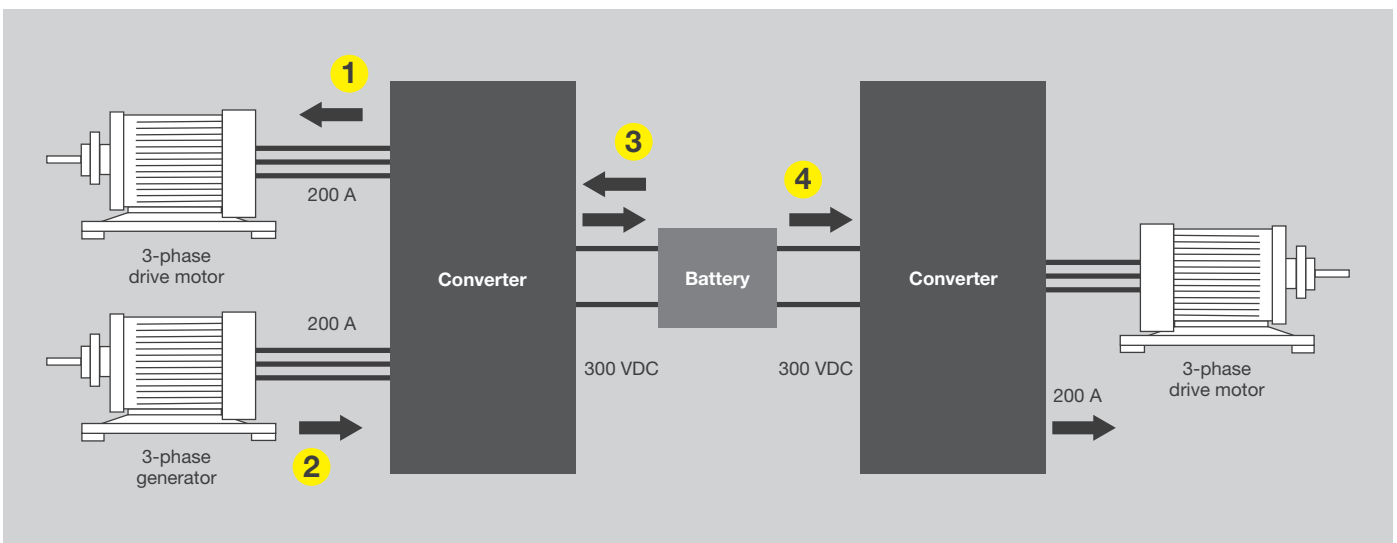

High noise immunity

The DL950 measures the DC power on the battery side and the AC power on the 3-phase motor side at the same time. It simultaneously measures all inverters, including the power generation motor, and evaluates the conversion efficiency. With its high noise immunity, the DL950 minimizes the effect of switching noise generated by the inverters. CAN, CAN FD, LIN, and SENT signals from the ECU and the temperature rise in each part can be captured at the same time. Data can be saved in a MATLAB format as well. When an isolated module is used, there is isolation between the body and channels and isolation between channels, so that different points of common potential can be safely measured.

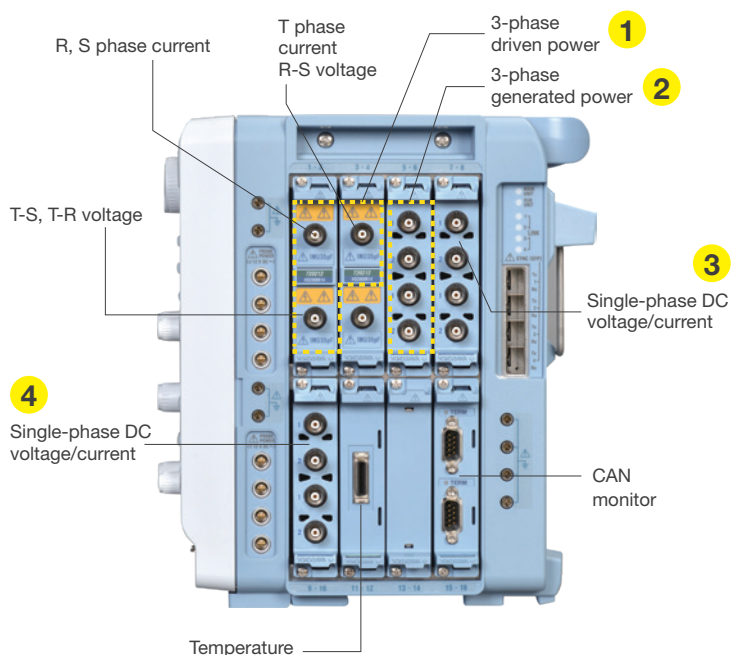

Modules, accessories, and functions needed

200 MS/s module, 4-CH 10 MS/s module, CAN FD module, current probe, power analysis (/G05)

Distributed energy resource test (renewable energy)

The DL950 supports renewable energy sources which contribute to a sustainable society. For wind turbines, the efficiency of power generation at multiple locations needs to be monitored in a time-synchronized manner. This can be done by GPS and IRIG. In addition, the DC/AC conversion efficiency for loading the DC power onto the grid can be accurately measured by the WT5000 high-precision power analyzer via IS8000. The power values and their trends can be analyzed.

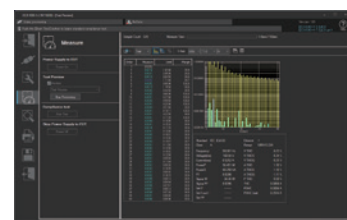
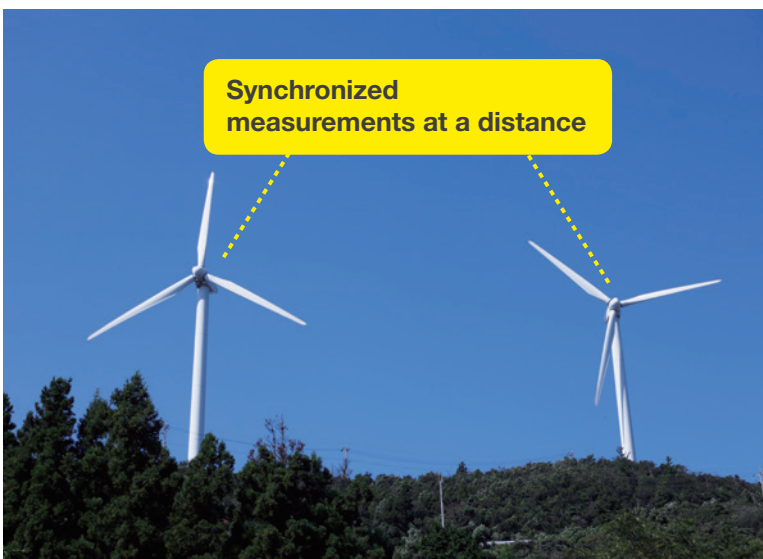

Modules, accessories, and functions needed

200 MS/s module, power analysis (/G05), GPS time synchronization (/C35)

Vibration analysis solution

All moving things are bound to have vibration. The DL950's acceleration module allows for simultaneous capture of multiple vibration frequencies. Use the FFT function to analyze the frequencies and find abnormalities.

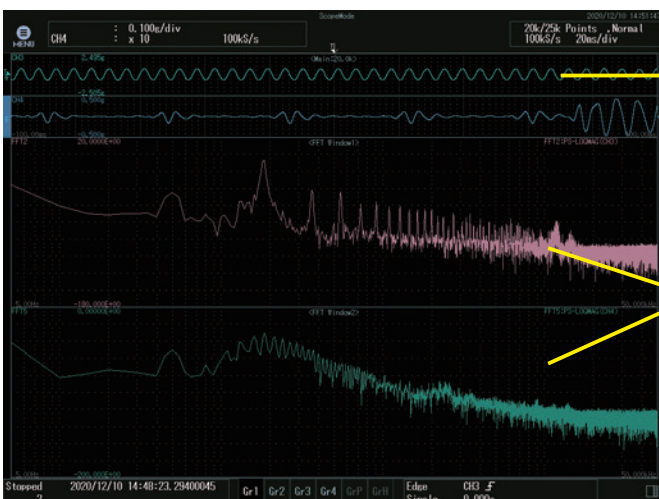

Vibration detection with acceleration pickup

FFT power spectrum analysis

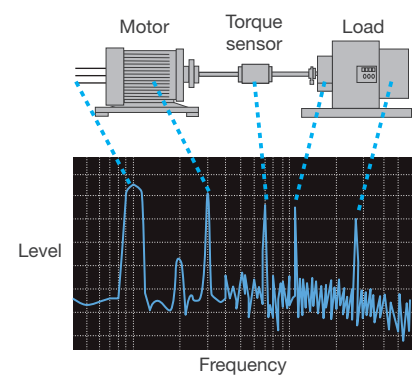

Modules, accessories, and functions needed

4 CH 10 MS/s module, acceleration module, FFT analysis

In-vehicle data measurement solution

The DL950/VCE option provides enhanced features and functions mainly for vehicle development and evaluation. Supporting CAN/CAN FD Monitor Module (720242), CAN & LIN Bus Monitor Module (720241), and SENT Monitor Module (720243), the DL950 can display each protocol communication data of in-vehicle networks as trend waveforms on the monitor. It can also trigger on decoded waveforms.

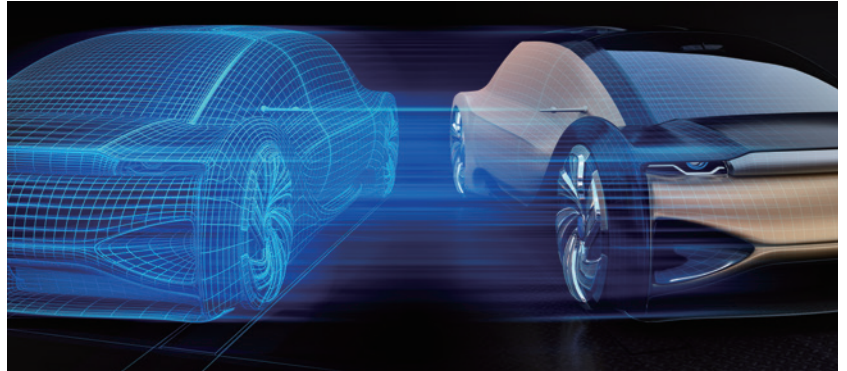

Comparative verification between measured signals and CAN/CAN FD bus signals

The CAN/CAN FD bus data and related waveforms can be viewed on the same screen. For example, an ignition switch ON/OFF signal, a CAN FD signal corresponding to that command, and pressure signals can be checked on the same screen to verify the correlation between them.



Location and time information inclusion

By connecting an accessory GPS unit, information such as location* and time can be included in measurement data. Correlation between the location of a vehicle and power data, CAN data, or other types of data can be viewed during a vehicle drive test.

*Location information acquisition will be available soon.



Utilization of vehicle-installed network definition files

The Symbol Editor is a software tool that makes it possible to define which physical values from the CAN/CAN FD or LIN bus data frame have to be trended as waveform data on the display of the ScopeCorder. The Symbol Editor can accept vehicle-installed network definition files (CAN DBC, LIN LDF).

Modules, accessories, and functions needed

CAN/CAN FD module, GPS unit, serial bus analysis function

Intuitive control panel and connectivity

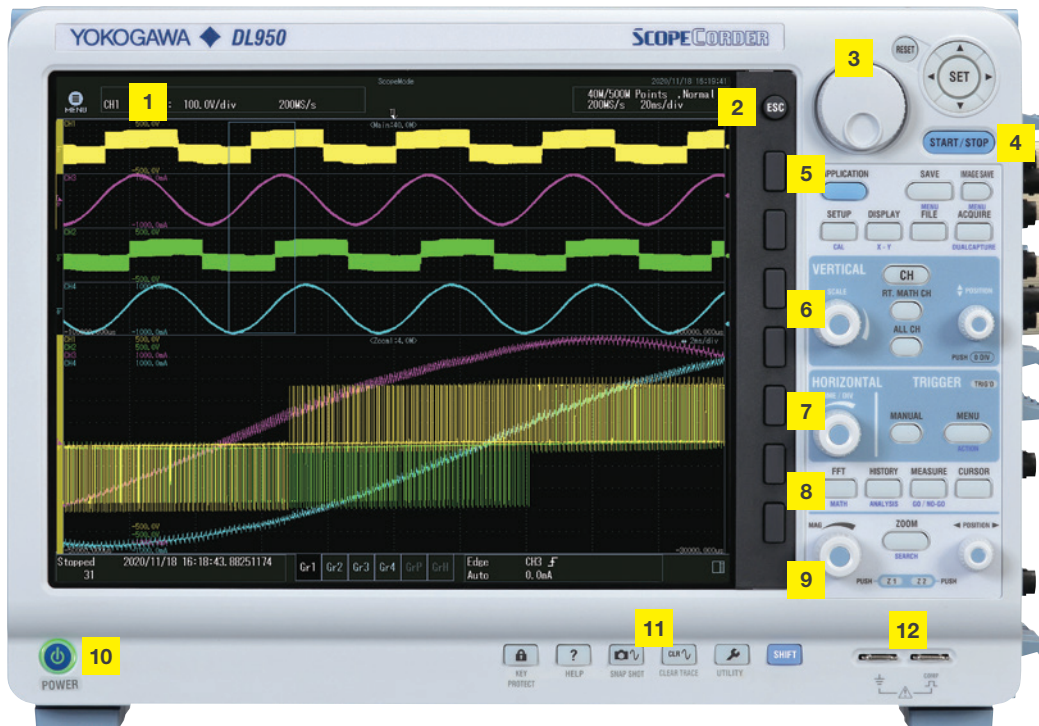

1 High resolution 12.1-inch touch screen

2 ESC key and soft keys

For moving in the menu and operating the soft menu

3 Jog dial

4 Capture start/stop key

5 Application key

6 Vertical axis setting keys/knobs

For input channel, real time math, and vertical axis resolution setting

7 Horizontal axis control keys/knobs

For setting the time axis and trigger

8 Analysis keys

For setting the FFT, cursor measurement, and so on

9 Zoom control keys/knobs

For setting the zoom display and zoom magnitude

10 Power switch

11 Other keys

Key protect, waveform screenshot, and utility menus

12 Probe compensation signal output terminal

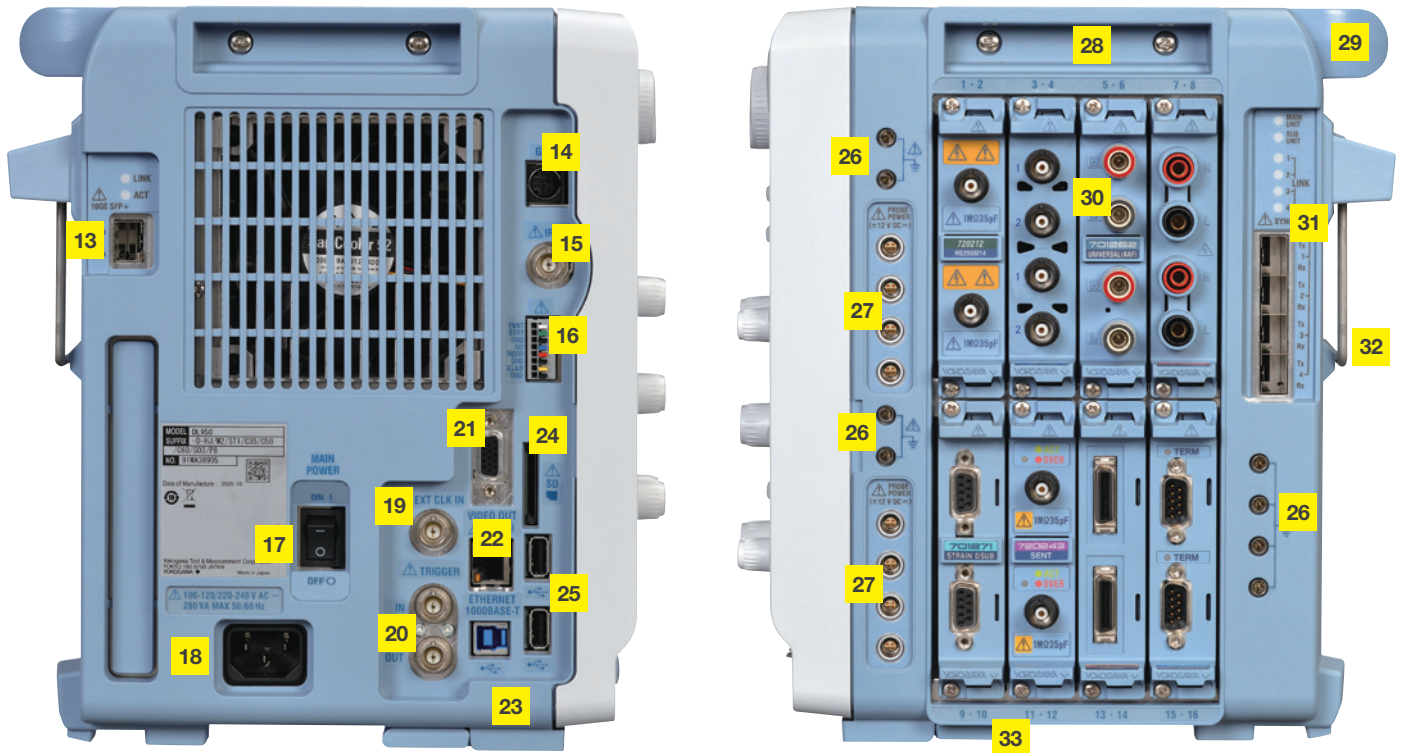

- 13** 10 Gbps Ethernet terminal (/C60)
- 14** GPS interface (/C35)
- 15** IRIG interface (/C35)
- 16** External I/O terminals
For outputting Go/No-Go result and control measurement start/stop signals
- 17** Main power switch
- 18** Power cord connector
- 19** External clock input terminal
For sampling based on an external signal
- 20** External trigger I/O terminals
- 21** Video signal output terminal (D-sub 9-pin)
- 22** 1000BASE-T Ethernet terminal
- 23** USB-PC connection terminal (USB3.0)
- 24** SD card slot
- 25** USB ports for peripherals
- 26** Functional ground terminals
- 27** Probe power supply terminals (/P4 or /P8)
- 28** Side grips
- 29** Bar handle
- 30** Input module slots
- 31** Multi-unit synchronization interface (/C50)
- 32** Rear stand
- 33** Tilt legs

Plug-in modules

Input	Model No. ^{*1}	Sample rate	Resolution	Bandwidth	Number of channels	Isolation	Maximum measurement voltage ^{*10} (DC + ACpeak)	DC accuracy	Note
Analog Voltage	720212 ^{*9}	200 MS/s	14 bit	40 MHz	2	Isolated	1000 V ² , 200 V ⁵	±0.5%	High speed · High voltage · Isolated
	720211 ^{*9}	100 MS/s	12 bit	20 MHz	2	Isolated	1000 V ² , 200 V ⁵	±0.5%	High speed · High voltage · Isolated
	720250	10 MS/s	12 bit	3 MHz	2	Isolated	800 V ² , 200 V ⁵	±0.5%	high noise immunity
	701251	1 MS/s	16 bit	300 kHz	2	Isolated	600 V ² , 140 V ⁵	±0.25%	High sensitivity range (1 mV/div), low noise (±100 μVtyp.), and high noise immunity
	720256	10 MS/s	16 bit	3 MHz	4	Isolated	600V ² , 200V ⁵	±0.25%	4 CH BNC input low noise, high noise immunity
	720254	1 MS/s	16 bit	300 kHz	4	Isolated	600 V ² , 200 V ⁵	±0.25%	4 CH BNC input low noise, high noise immunity
	701255	10 MS/s	12 bit	3 MHz	2	Non-Isolated	600 V ⁴ , 200 V ³	±0.5%	High speed · Non isolated
	720268	1 MS/s	16 bit	300 kHz	2	Isolated	1000 V ¹¹	±0.25%	With AAF, RMS, and high noise immunity
Analog Voltage & Temperature	701261	100 kS/s (Voltage), 500 S/s (Temperature)	16 bit (Voltage), 0.1°C (Temperature)	40 kHz (Voltage), 100 Hz (Temperature)	2	Isolated	42 V	±0.25% (Voltage)	Thermocouple (K, E, J, T, L, U, N, R, S, B, W, iron-doped gold/chromel)
	701262	100 kS/s (Voltage), 500 S/s (Temperature)	16 bit (Voltage), 0.1°C (Temperature)	40 kHz (Voltage), 100 Hz (Temperature)	2	Isolated	42 V	±0.25% (Voltage)	Thermocouple (K, E, J, T, L, U, N, R, S, B, W, iron-doped gold/chromel), with AAF
	701265	500 S/s (Voltage), 500 S/s (Temperature)	16 bit (Voltage), 0.1°C (Temperature)	100 Hz	2	Isolated	42 V	±0.08 (Voltage)	Thermocouple (K, E, J, T, L, U, N, R, S, B, W, iron-doped gold/chromel), high sensitivity range (0.1 mV/div)
	720266	125 S/s (Voltage), 125 S/s (Temperature)	16 bit (Voltage), 0.1°C (Temperature)	15 Hz	2	Isolated	42 V	±0.08 (Voltage)	Thermocouple (K, E, J, T, L, U, N, R, S, B, W, iron-doped gold/chromel), high sensitivity range (0.1 mV/div), Low noise
	720221 ^{*8}	10 S/s	16 bit	600 Hz	16	Isolated	20 V	±0.15% (Voltage)	16 CH voltage or temperature measurement (scan method) Thermocouple (K, E, J, T, L, U, N, R, S, B, W, Au-Fe-chromel)
Strain	701270	100 kS/s	16 bit	20 kHz	2	Isolated	10 V	±0.5% (Strain)	Supports strain NDIS, 2, 5, 10 V built-in bridge power supply
	701271	100 kS/s	16 bit	20 kHz	2	Isolated	10 V	±0.5% (Strain)	Supports strain DSUB, 2, 5, 10 V built-in bridge power supply, and shunt CAL
Analog Voltage, Acceleration	701275	100 kS/s	16 bit	40 kHz	2	Isolated	42 V	±0.25% (Voltage) ±0.5% (Acceleration)	Built-in anti-aliasing filter, Supports built-in amp type acceleration sensors (4 mA/22 V)
Frequency	720281	1 MS/s	16 bit	resolution 625 ps	2	Isolated	420 V ² , 42 V ³	±0.1% (Frequency)	Measurement frequency of 0.01 Hz to 500 kHz, Measured parameters (frequency, RPMs, RPSs, period, duty cycle, power supply frequency, pulse width, pulse integration, and velocity)
Logic	720230	10 MS/s	—	—	8 bit × 2 ports	Non-Isolated	depend on logic probe used.	—	(8 bit/port) × 2, compatible with four-type of logic probe (sold separately)
CAN, LIN	720241	100 kS/s	—	—	(60 signals × 2) port	Isolated	10 V (CAN port) 18 V (LIN port)	—	CAN port × 1, LIN port × 1 ^{6,7}
CAN, CAN FD	720242	100 kS/s	—	—	(60 signals × 2) port	Isolated	10 V	—	CAN/CAN FD Data of maximum 32 bit allowable ^{6,7}
SENT	720243	100 kS/s	—	—	11 data × 2 ports	Isolated	42 V	—	Supported protocol: SAE J2716 ^{6,7}

*1: Probes are not included with any modules. *2: In combination with 700929, 702902 or 701947 probe. *3: Direct input *4: In combination with 10:1 probe model 701940 *5: In combination with 701901 + 701954. *6: Any other modules can be installed in the remaining slots. *7: When using these modules with DL950/VCE, up to four CAN/CAN FD Monitor Modules (720242), CAN & LIN Bus Monitor Modules (720241) or SENT Monitor Module (720243) in total can be used on a single main unit. For the CAN/CAN FD Monitor Module (720242) and CAN & LIN Bus Monitor Module (720241), up to two in total can be used on a single main unit. *8: The 16 CH Scanner Box (701953) is required for measurement. *9: Class 1 Laser Product, IEC / EN60825-1, GB7247-1-2012 *10: See the main specifications for voltage-axis sensitivity setting and measurement range. *11: In combination with 758933 and 701954. 1000 Vrms (1000 VDC or 1414 Vpeak maximum) See Bulletin DL950-02EN for more details about the modules.

Accessories



Optical Transceiver Module
1000BASE-SX SFP module
850 nm
720941



Optical Fiber Cord
Multi mode optical fiber
(LC-LC/3 m)
720942



Soft carrying case
701972



Current probe
0.5, 5, 30 Arms,
702915 (DC to 50 MHz),
702916 (DC to 120 MHz)



Differential probe
±7000 V, 50 MHz
701977

Differential probe
±1500 V, 150 MHz
701978

Combination of modules and probes/accessories

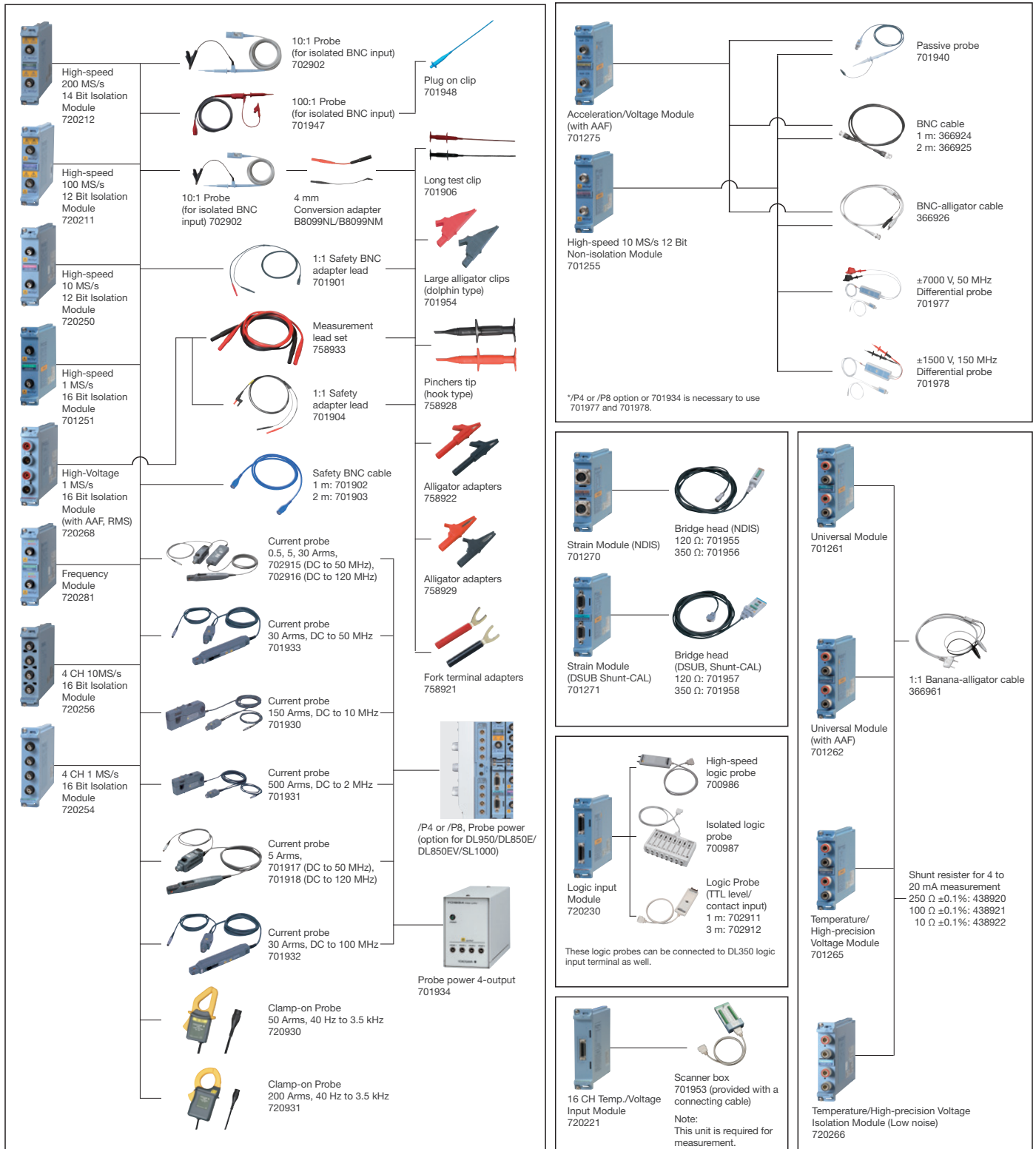

Specifications (Main unit)

For the plug-in modules specifications, see the “Bulletin DL950E-02EN”.

Signal Input Section	
Type	Plug-in input unit
Number of slots	8
Maximum number of input channels	
	32 channels (when 4-CH modules are used in all slots) 128 channels (when 16 CH temperature/voltage modules are used in all slots)
Memory size	
	Standard: 1 Gpoint (up to 500 Mpoints per channel) /M1 option: 4 Gpoints (up to 2 Gpoints per channel) /M2 option: 8 Gpoints (up to 4 Gpoints per channel)
Scope Mode Features	
Waveform Acquisition and Display	
Acquisition mode	Normal Normal waveform acquisition
Envelope	Holds peak values at the maximum sample rate, regardless of the time axis setting
Averaging	Average count: 2 to 65536 (2 ⁿ steps), Infinite (attenuation constant: 2 to 256, 2 ⁿ steps)
Record length	Standard model 10 k, 25 k, 50 k, 100 k, 250 k, 500 k, 1 M, 2.5 M, 5 M, 10 M, 25 M (32 CH), 50 M (16 CH), 100 M (8 CH), 250 M (4 CH), 500 M (2 CH) /M1 10 k, 25 k, 50 k, 100 k, 250 k, 500 k, 1 M, 2.5 M, 5 M, 10 M, 25 M, 50 M, 100 M (32 CH), 250 M (16 CH), 500 M (8 CH), 1 G (4 CH), 2 G (2 CH) /M2 10 k, 25 k, 50 k, 100 k, 250 k, 500 k, 1 M, 2.5 M, 5 M, 10 M, 25 M, 50 M, 100 M, 250 M (32 CH), 500 M (16 CH), 1 G (8 CH), 2 G (4 CH), 4 G (2 CH)
Sample rate	Can be set up to the module's maximum sample rate for each channel (there are limitations based on the record length)
Selectable time scale range	100 ns/div to 1 s/div (1-2-5 steps), 2 s/div, 3 s/div, 4 s/div, 5 s/div, 6 s/div, 10 s/div, 20 s/div, 30 s/div, 1 min/div to 6 min/div (1 min steps), 10 min/div, 12 min/div, 30 min/div, 1 h/div to 6 h/div (1 h steps), 8 h/div, 10 h/div, 12 h/div, 1 day/div to 5 day/div (1 day steps)
Action performed at the end of acquisition	Waveform data saving (simultaneous saving in binary, ASCII, and MATLAB formats) Image saving, measurement result saving, mail transmission, buzzer notification
Event recording	Records up to 100 events using the event input terminal
Zoom	Two windows
Display format	1, 2, 3, 4, 5, 6, 8, 12, 16 split displays (set for each display group)
Maximum number of displayed traces	Up to 64 traces for each display group
Display interpolation	Off, sign interpolation, linear interpolation, pulse interpolation
X-Y display	Select X and Y axes from analog input waveforms and Math waveforms, up to four traces in two windows
Accumulation	Waveform accumulation: Infinite, 2, 4, 8, 16, 32, 64, 128
History function	Maximum number of histories: 5000 Display mode: Single waveform display, all waveform display, average display
Dual capture	Data acquisition of the same waveform is possible at two different sample rates
Low-speed sampling	Maximum sample rate: 100 kS/s Selectable time scale range: 1 s/div to 5 day/div
High-speed sampling	Maximum sample rate: Module's maximum sample rate Selectable time scale range: 100 ns/div to 1 min/div Maximum record length: 50 M (/M2)
SSD recording (/ST1)	
Maximum sample rate	Depends on the number of used channels. 2 MS/s (when 1 CH is used), 200 kS/s (when 16 CH is used) maximum
Maximum record length	50 G (/M2)
Vertical and Horizontal Control	
Channel on/off	CHn, CHn_m, RTMATHn, and MATHn can be turned on and off separately
Vertical axis zooming	×0.1 to ×100 (varies depending on the module type) By setting the scale using upper and lower limits
Vertical position setting	Waveforms can be moved in the range of ±5 div (not possible when top and bottom scale values are set).
Linear scaling	Can be set to Ax+B mode or P1-P2 mode (only for voltage, stress, and frequency)
Roll mode display	When the trigger mode is set to auto, single, or on-start, and the time axis setting is greater than or equal to 100 ms/div
Deskewing	±1 μs (modules with sample rates at 10 MS/s or faster)
Triggering Section	
Trigger mode	Auto, Auto Level, Normal, Single, Single (N), On-start

Selectable trigger level range	0 ± 10 div
Manual trigger	Input through dedicated keys or communication commands
Simple trigger	
Trigger source	CHn, CHn_m (specified input channel, specified bit for logic), RTMATHn, external, time, line
Trigger slope	Rising, falling, both edges (rising, falling only for logic)
Clock trigger	Date (year/month/day), time (hour/minute/second), time interval (10 seconds to 24 hours)
Enhanced trigger	
Trigger source	CHn, CHn_m (specified input channel, specified bit for logic), RTMATHn, external
Trigger type	A→B (N), A Delay B, Edge on A, AND, OR, Period, Pulse Width, WaveWindow
Analysis	
Cursors	T-Y waveforms: Horizontal / Vertical / H&V / Marker / Degree X-Y waveforms: Horizontal / Vertical / H&V / Marker FFT waveforms: Marker / Peak
Automated measurement of waveform parameters	
Measured parameters	Analog waveform, Math PP, Amp, Max, Min, High, Low, Avg, Mid, Rms, Sdev, +Over, -Over Rise, Fall, Freq, Period, +Width, -Width, Duty, Pulse, Burst1, Burst2, Avg.Freq, AvgPeriod, Int1TY, Int2TY, Int1XY, Int2XY, Delay
	Logic waveform Freq, Period, Pulse, Duty, Avg.Freq, Delay
Statistical processing	Statistical items Max, Min, Avg, Sdv, Cnt Maximum number of cycles 64000 Maximum measurement range 4 Gpoints (memory recording), 100 Mpoints (internal storage) Continuous statistical processing Statistical processing is performed while waveforms are acquired Cyclic statistical processing Automatically measures the waveform parameters once per cycle and performs statistical processing on the parameters History statistical processing Automatically measures the waveform parameters on the data of each history waveform and performs statistical processing on the parameters
Waveform computation	
Operators	Basic arithmetic with coefficients, binarization, shift
Number of computations	Up to 8
Computation length	Up to 2 Mpoints (when one waveform is used), 250 kpoints (when eight waveforms are used)
User-defined math function (/G02 option)	
Operators	Equations can be created using the following operators. ABS, SQRT, LOG, EXP, NEG, SIN, COS, TAN, ATAN, PH, DIF, DDIF, INTG, IINTG, BIN, P2, P3, F1, F2, FV, PWHH, PWHL, PWLH, PWLL, PWXX, DUTYH, DUTYL, FLT1, FLT2, HLBT, MEAN
Set the average	Simple average, exponential average, cycle average, peak computation
FFT	
Waveform to be computed	CHn, CHNm, RTMATHn, MATHn
Number of windows	2
Number of FFT waveforms	Up to eight waveforms (up to four waveforms/window)
Computation range	From the specified computation time start point until the specified number of points have been computed
Math points	1 k / 2 k / 5 k / 10 k / 20 k / 50 k / 100 k
Time window	Hanning, Hamming, FlatTop, Rectangle Exponential (/G02 option)
Average setting (/G02 option)	Domain: Time axis, frequency axis Type: Simple average, exponential average, peak computation
GO/NO-GO determination	A selected operation can be performed according to the determination condition on the acquired waveform.
Zone determination	Number of determination zones: Up to 6 Number of source waveforms: Up to 16 Combinations: AND, OR
Parameter determination	Number of determination parameters: Up to 16 Combinations: AND, OR
Operation after determination	Screen capture data saving, waveform data saving, buzzer notification, mail transmission
Zooming and searching	You can search for and then expand and display a portion of the displayed waveform.
Type	Edge: Searches by counting the number of rising and falling edges Logic pattern: Searches by counting the logic pattern Event: Searches for an event number Time: Searches for a date and time

History search	Searches through history waveforms for specified conditions
Zone search	Number of determination zones: Up to 4 Combinations: AND, OR
Parameter search	Number of determination parameters: Up to 4 Combinations: AND, OR

Recorder Mode Features

Waveform Acquisition and Display

Record conditions	
Preset time recording	Records data for the specified time period from the start point
Continuous recording	Records data for the specified time period before stopping
Trigger recording	Records data based on trigger position setting
Acquisition mode	
Memory recording	Records waveforms to internal memory
Saving during and at the end of memory recording	Records to internal memory and then saves waveform data or screen capture data to files
SSD recording (/ST1)	Records waveforms to internal SSD storage
Acquisition mode	
Normal	Normal waveform acquisition
Envelope	Holds peak values at the maximum sample rate, regardless of the time axis setting
Recording time	1 s to 50 days
Sampling interval	100 ns to 200 ms (1-2-5 series)
Action performed at the end of recording	
Waveform data saving (binary, ASCII, and MATLAB formats)	
Screen capture data saving, measurement results saving, buzzer notification, mail transmission	

SSD recording (/ST1)	
Minimum sampling interval	Depends on the number of used channels. 500 ns (when 1 CH is used), 5 μ s (when 16 CH is used) minimum
Maximum number of recorded points	20 Gpoints, 50 Gpoints (/M1, /M2) (there are limitations based on the number of used channels)
Event recording	Records up to 100 events using the event input terminal
Display time range	10 μ s to 10 s (1-2-5 steps), 20 s, 30 s, 40 s, 50 s, 60 s, 100 s, 200 s, 300 s, 10 min to 60 min (10 min steps), 100 min, 2 hour, 5 hour, 10 hour to 60 hour (10 hour steps), 80 hour, 100 hour, 5 day, 10 day, 20 day, 30 day, 40 day, 50 day
Zoom	One window
Display format	1, 2, 3, 4, 5, 6, 8, 12, 16 split displays (set for each display group) of TY display
Maximum number of displayed traces	Up to 64 traces for each display group
X-Y display	Number of windows: 2 Number of X-Y traces: Up to eight traces (up to four traces/window) Select the X and Y axes from CHn, CHn_m, RTMATHn, MATHn.

Vertical and Horizontal Control

Channel on/off	CHn, CHn_m, RTMATHn, and MATHn can be turned on and off separately.
Vertical axis zooming	By setting the scale using upper and lower limits
Linear scaling	Can be set to Ax+B mode or P1-P2 mode (only for voltage, stress, and frequency)
Deskewing	$\pm 1 \mu$ s (modules with sample rates at 10 MS/s or faster)

Triggering Section

Selectable trigger level range	0 \pm measurement range
Manual trigger	Using a dedicated key
Trigger source	CHn, CHn_m (specified input channel, specified bit for logic), RTMATHn, external trigger, time
Trigger type	Edge, Time, OR, AND

Analysis

Cursors	T-Y waveforms: Horizontal / Vertical / H&V / Marker / Degree X-Y waveforms: Horizontal / Vertical / H&V / Marker FFT waveforms: Marker / Peak
Automated measurement of waveform parameters	
Measured parameters	<p>Analogue waveform, Math</p> <p>PP, Amp, Max, Min, High, Low, Avg, Mid, Rms, Sdev, +Over, -Over Rise, Fall, Freq, Period, +Width, -Width, Duty, Pulse, Burst1, Burst2, Avg.Freq, AvgPeriod, Int1TY, Int2TY, Int1XY, Int2XY, Delay</p> <p>Logic waveform Freq, Period, Pulse, Duty, Avg.Freq, Delay</p>
Statistical processing	<p>Statistical items Max, Min, Avg, Sdv, Cnt</p> <p>Maximum number of cycles 64000</p> <p>Maximum measurement range 4 Gpoints (memory recording), 100 Mpoints (SSD recording)</p> <p>Cyclic statistical processing Automatically measures the waveform parameters once per cycle and performs statistical processing on the parameters</p>

Waveform computation	
Operators	Basic arithmetic with coefficients, binarization, shift
Number of computations	Up to 8
Computation length	Up to 2 Mpoints (when one waveform is used), 250 kpoints (when eight waveforms are used)
User-defined math function (/G02 option)	
Operators	
Equations can be created using the following operators	
ABS, SQRT, LOG, EXP, NEG, SIN, COS, TAN, ATAN, PH, DIF, DDIF, INTG, IINTG, BIN, P2, P3, F1, F2, FV, PWHH, PWHL, PWLL, PWXX, DUTYH, DUTYL, FILT1, FILT2, HLBT, MEAN	
Set the average	None
FFT	
Waveform to be computed	CHn, MATHn
Number of windows	2
Number of FFT waveforms	Up to eight waveforms (up to four waveforms/window)
Computation range	From the specified computation time start point until the specified number of points have been computed
Math points	1 k / 2 k / 5 k / 10 k / 20 k / 50 k / 100 k
Time window	Hanning, Hamming, FlatTop, Rectangle Exponential (/G02 option)
Set the average	None
Zooming and searching	You can search for and then expand and display a portion of the displayed waveform
Type	Edge: Searches by counting the number of rising and falling edges Logic pattern: Searches by counting the logic pattern Event: The instrument searches for an event number Time: The instrument searches for a date and time

Real Time Math (/G03, /G05)

Math expression	Real time math using hardware
Max. number of math channels	16 (separate from the input channels)
Computation result storage format	Single-precision floating-point (32 bit)
Real time math function	
Math rate	Max. math rate: 10 MS/s or 1 MS/s for polynomials
Math type	Basic arithmetic with coefficients, Quartic polynomial, Coefficient multiplied by addition or subtraction of sources, Logic signal/analogue waveform conversion, Differentiation, Integration, Common logarithm, Square root, Frequency, Period, Edge count, Demodulation of PWM signal, Torque, Rms value, Effective power, Effective power integration, Cosine, Sine, Arc tangent, Angle of rotation, Electrical angle, Knocking filter (only when the /VCE option is installed), Resolver, 3 phase resolver
Math source waveforms	All input channels including sub channels. (there are limitations based on the operator) Math results can be specified as sources of another channel. However, you can only specify math results of channels whose numbers are smaller than the channel that you are specifying sources for.
Math delay	A uniform delay for each math operation, regardless of the number of math channels
Filter on math results	IIR low-pass filter all math results Full, cutoff frequencies 128 kHz, 64 kHz, 32 kHz, 16 kHz, 8 kHz, 4 kHz, 2 kHz, 1 kHz, 500 Hz, 250 Hz, 125 Hz, 62.5 Hz
Vertical scale	Set based on the specified top and bottom scale values, simultaneous use of zooming using the scale knob and moving using the position knob
Digital filter	Digital filter for input channels. Math can be performed on up to 16 channels at the same time
Target input modules	720212, 720211, 701250, 701255, 720250, 701251, 720268, 701261, 701262, 701265, 720266, 701275, 701270, 701271
Filter types	Mean (moving average), Gauss, Sharp, IIR, IIR-Lowpass
Power Math (/G05)	
Math expression	Real time math using hardware
Math source channels	Voltage input channels excluding the 720221
Max. math rate	10 MS/s (100 kS/s for power math)
Math result output channels	Power analysis math: Real time math RTMATH13, RTMATH14; harmonic analysis math RTMATH15, RTMATH16; fixed
Computed result	Single-precision floating-point (32 bit)
Power analysis	
Max. number of analyzable systems	Up to two three-phase systems can be computed simultaneously
Max. number of simultaneous math parameters	126 when one system is measured 54 \times 2 systems when two systems are measured
Supported wiring systems	Single-phase two-wire (1P2W); single-phase three-wire (1P3W); or three-phase three-wire (3P3W), Three-phase three-wire system that uses a three-voltage three-current method (3P3W; 3V3A); three-phase four-wire system (3P4W)

Delta math function	Three-phase three-wire (3P3W) → three-phase three-wire system that uses a three-voltage three-current method (3P3W; 3V3A) Three-phase three-wire (3V3A) → three-phase four-wire system (3P4W) (delta → star) Three-phase four-wire system (3P4W) → three-phase three-wire (3V3A) (star → delta)	
Math items	Rms voltage and current of each phase, Voltage and current simple average of each phase (DC), AC voltage and current components of each phase (AC), Active power, Apparent power, Reactive power, Power factor, Current phase difference, Voltage and current frequencies, Maximum voltage and current, minimum voltage and current, Maximum power, minimum power, Integrated watt-hour, integrated watt-hour of each polarity (positive and negative), Integrated ampere-hour, integrated ampere-hour of each polarity (positive and negative), Apparent energy, Reactive energy, Impedance of the load circuit, Series resistance of the load circuit, Series reactance of the load circuit, Parallel resistance of the load circuit, Parallel reactance of the load circuit, Three-phase voltage unbalanced factor, Three-phase current unbalanced factor, Motor output math, Power efficiency	
Rms math system	Select true rms value or rectified mean value calibrated to the rms value	
Math sync mode	Edge: Select a signal. Computed using zero-crossings. Auto Timer: Specify the time. Computed at specified time intervals. AC: Select a signal. Computed using zero-crossings. Signal stop determined by a stop prediction function. AC+DC: Select a signal. Computed using zero-crossings. Signal stop determined by a stop prediction function. Switches to Auto Timer after stopping.	
Channel selection for edge	Select a single channel from own phase voltage, own phase current, or other voltage/current	
Sync channel filter	If sync mode is set to Edge, low-pass filter can be selected. Cutoff frequency: Select from 128 kHz, 64 kHz, 32 kHz, 16 kHz, 8 kHz, 4 kHz, 2 kHz, 1 kHz, 500 Hz, 250 Hz, 125 Hz, and 62.5 Hz.	
Harmonic analysis	Max. number of analyzable systems 1	
	Max. number of analyzable frequencies Fundamental wave 1 kHz	
	FFT points 512	
Supported wiring systems	Single-phase two-wire (1P2W); single-phase three-wire (1P3W); or three-phase three-wire (3P3W), Three-phase three-wire system that uses a three-voltage three-current method (3P3W; 3V3A); three-phase four-wire system (3P4W)	
Delta math function	Three-phase three-wire (3P3W) → three-phase three-wire system that uses a three-voltage three-current method (3P3W; 3V3A) Three-phase three-wire (3V3A) → three-phase four-wire system (3P4W) (delta → star) Three-phase four-wire system (3P4W) → three-phase three-wire (3V3A) (star → delta)	
Math mode	Rms analysis mode, power analysis mode	
Math items	Rms analysis mode	Rms percentage content of the 1st to 40th harmonic, Phase angles of the 1st to 40th harmonic, Total rms value, Distortion factor (IEC), Distortion factor (CSA)
	Power analysis mode	Active powers from the 1st to the 35th harmonic, Active power percentage content from the 1st to the 35th harmonic, Phase angles of the 1st to 35th harmonic, Total active powers, Total reactive powers, Total apparent powers, Power factor, 1st harmonic rms voltage, 1st harmonic rms current, 1st harmonic voltage phase angle, 1st harmonic current phase angle
Sync channel	Rms analysis mode: Analysis source channel Power analysis mode: Select one channel from voltage and current.	
Sync channel filter	Low-pass filter can be selected Cutoff frequency: Select from 128 kHz, 64 kHz, 32 kHz, 16 kHz, 8 kHz, 4 kHz, 2 kHz, 1 kHz, 500 Hz, 250 Hz, 125 Hz, and 62.5 Hz.	
Time Axis		
Time axis accuracy	±4.6 ppm	
External clock input	Clock input through the external clock input terminal	
Display		
Display	12.1-inch color TFT LCD (capacitive touch panel)	
Display format	T-Y, X-Y, FFT, harmonics (/G05)	
Display resolution	1024×768 (XGA)	
Resolution of the waveform display	801×656 (normal), 1001×656 (wide)	
Defective pixels	3 ppm or less of the total number of pixels including RGB	

Saving Data		
Saving Data	Types of saved data	Measured data, analysis results, settings, screen capture
	Measured data format	Binary (.WDF), MATLAB (.MAT), text (.CSV) Maximum file size (MAT, CSV format): 2 GByte
	Data storage device	Internal storage, SD memory card, USB storage, network drive
Saving Screen Captures		
	Screen capture data format	PNG, JPEG, BMP
	Screen capture data color	Monochrome, color, color (reverse), grayscale
	Data storage device	Internal storage, SD memory card, USB storage, network drive

PC Data Streaming	
Connection type	USB, Ethernet, 10G Ethernet (/C60)
Maximum sample rate	Depends on the number of used channels. 2 MS/s (when 1 CH is used), 200 kS/s (when 16 channels are used) maximum (USB, Ethernet) 10 MS/s (when 8 channels are used) (10G Ethernet)

Multi-Unit Synchronization (/C50)	
Connector type	SFP
Ports	4 (up to four sub units can be connected to a main unit)
Synchronization accuracy	± (30 ns + 1 sample) (typical value)
Function	Start and stop from the main unit, combination trigger across units
Maximum cable length	20 m

Storage	
Internal storage (/ST1 option)	
Number of drives	1
Media type	SSD
Available space	512 GB
SD memory card	
Number of slots	1
Maximum capacity	128 GB
Compatible cards	SD, SDHC, and SDXC memory cards
USB storage	
Compatible USB storage devices Mass storage devices that comply with USB Mass Storage Class Ver. 1.1	
Available space	8 TB max. Partition format: MBR, GPT; format type: FAT16/FAT32/exFAT

USB Ports for Peripherals		
Connector type	USB type A (receptacle)	
Electrical and mechanical	USB Rev. 2.0 compliant	
Supported transfer modes	HS (High Speed; 480 Mbps), FS (Full Speed; 12 Mbps), LS (Low Speed; 1.5 Mbps)	
Compatible devices	Mass storage devices that comply with USB Mass Storage Class Ver. 1.1 104 or 109 keyboards that comply with USB HID Class Ver. 1.1 Mouse devices that comply with USB HID Class Ver. 1.1 HP Inkjet printers compatible with USB Printer Class Ver. 1.0, Brother/PocketJET printers	
Number of ports	2	
Power supply	5 V, 500 mA (for each port)	
External Printer Output		
Supported models	Brother Pocket JET printers, 300 dpi models HP inkjet printers, single function models For details on models, see the catalog or website	
Output format	Screen hard copy, monochrome or color (color available only with HP printers)	

Auxiliary I/O Section		
External Trigger Input Terminal		
Connector type	BNC	
Input level	TTL (0 to 5 V)	
Minimum pulse width	100 ns	
Detected edge	Rising or falling	
Trigger Output Terminal		
Connector type	BNC	
Output level	5 V CMOS	
Output delay time	(1.8 μs to 4.5 μs) + 1 sample (typical value) Applies to 1 MS/s or faster modules. Depends on the installed module	
Output format		
Normal format	Logic: Falls when a trigger occurs and rises when a signal acquisition is completed Output hold time: 100 ns or more	
Pulse format	Logic: Transmits a pulse when a trigger occurs Pulse width: 1 ms, 50 ms, 100 ms, 500 ms	

External Clock Input Terminal	
Connector type	BNC
Input level	TTL (0 to 5 V)
Maximum input frequency	9.5 MHz, 100 kHz (for envelope)
Minimum pulse width	50 ns
Detected edge	Rising
Video signal output	
Connector type	D-sub 15 pin, receptacle
Output format	Analog RGB
Output resolution	XGA-compliant output, 1024 × 768 dots Approx. 60-Hz Vsync (66 MHz dot clock frequency)
GO/NOGO Output	
Connector type	Screwless terminal block
Output level	5 V CMOS
External Start/Stop Input	
Connector type	Screwless terminal block
Input level	TTL (0 to 5 V) or contact input
Event Input	
Connector type	Screwless terminal block
Input level	TTL (0 to 5 V) or contact input
Sample clock output	
Connector type	Screwless terminal block
Output level	5 V CMOS
Output operation	Outputs a clock signal at the specify frequency
Frequency range	5 Hz to 200 kHz (1-2-5 steps)
COMP Output (Probe Compensation Signal Output Terminal)	
Output signal frequency	1 kHz±1%
Output amplitude	1 V _p -p±10%
Probe power (/P4 or /P8 option)	
Output terminals	4 (/P4), 8 (/P8)
Output power	±12 V
Output current	Up to a total of 2.4 A (/P4), up to a total of 4.8 A (/P8)
GPS Interface (/C35 option)	
Input connector	9-pin Mini DIN
Compatible GPS unit	720940 (optional accessory)
Function	Instrument clock synchronization Sample clock synchronization
Synchronization accuracy*	± 200 ns (typical value when locked to GPS signal)*
*The figure is based on results obtained when the GPS unit is installed in a location with good line of sight to GPS satellites. The accuracy may not be attained depending on the measurement location, the location of satellites when the measurement is taken, the weather, and influence caused by obstruction.	
IRIG Interface (/C35 option)	
Input connector	BNC
Number of input connectors	1
Compatible IRIG signals	A006, B006, A136, B126
Input impedance	50 Ω/5 kΩ switchable
Maximum input voltage	±8 V
Used for	Instrument clock synchronization Sample clock synchronization
Clock sync range	±60 ppm
Synchronization accuracy	No drift from the input signal
Computer Interface	
USB-PC Connection	
Connector type	USB type B (receptacle)
Electrical and mechanical specifications	USB Rev. 3.0 compliant
Supported transfer modes	FS (Full Speed) mode (12 Mbps), HS (High Speed) mode (480 Mbps), SS (Super Speed) mode (5 Gbps)
Number of ports	1
Supported protocols	Functions as a device that conforms to one of the following two protocols. USBTMC-USB488 (USB Test and Measurement Class Ver. 1.0)* Communication commands can be used through USB. *A separate driver is required Mass Storage Class Ver. 1.1 Only reading is possible from the instrument's internal storage through PC access. (Operations, such as formatting, are not possible.)
PC system requirements	Windows8.1, Windows10

Ethernet	
Connector type	RJ-45 modular jack
Ports	1
Electrical and mechanical specifications	IEEE802.3 compliant
Transmission system	Ethernet (1000BASE-T/100BASE-TX/10BASE-T)
Communication protocol	TCP/IP
Supported services	DHCP, DNS, SNMP client, SMTP client, FTP client, FTP server, Web server, LPR, VXI-11, HiSLIP, Socket PTP slave, PTP master (/C40 option)
Time synchronization feature	
Sync source	Supports IEEE1588-2008 (PTP v2) Supports PTP packets of Layer3 (UDP/IPv4) and Layer2 (Ethernet) Slave feature only (without the /C40 option) Slave and master features (with the /C40 option) Supports Ordinary Clock Supports E2E delay correction Supports 2-step Sync messages
Sync targets	Instrument clock, sample clock
Synchronization accuracy	±150 ns (typical value) when 1000BASE-T is used and an Ethernet switch is not used
Master sync clock (/C40 option)	Internal clock, GPS (/C35 option)
10 G Ethernet (/C60)	
Connector type	SFP+
Ports	1
Electrical and mechanical specifications	IEEE802.3 compliant
Transmission system	Ethernet (10GBASE-R)
Communication protocol	TCP/IP
Supported services	DHCP, DNS, SNMP client, SMTP client, FTP client, FTP server, Web server, Socket, VXI-11, HiSLIP

General Specifications**Standard operating conditions**

Ambient temperature: 23±5°C
Ambient humidity: 20 to 80%RH
Supply voltage and frequency errors Within ±1% of rating
After a 30 minute warm-up and after calibration

Recommended calibration period

1 year

Warm-up time

At least 30 minutes

Operating environment

Temperature: 5°C to 40°C
Humidity: 20 to 85%RH (no condensation)
Altitude: 2000 m or less

Storage environment

Temperature: -20°C to 60°C
Humidity: 20 to 85%RH (no condensation)

Power supply

Rated supply voltage: 100 to 120 VAC, 220 to 240 VAC (auto switching)
Permitted supply voltage range: 90 to 132 VAC, 198 to 264 VAC
Rated supply frequency range: 48 Hz to 63 Hz
Maximum power consumption: 280 VA
Withstand voltage:
1500 VAC for 1 minute between the power supply and case
Insulation resistance:
10 MΩ or higher at 500 VDC between the power supply and case

Installation orientation

Vertical, horizontal, tilted

External dimensions

Approx. 375 mm (W) × 259 mm (H) × 202 mm (D), excluding the handle and protrusions

Weight

Approx. 7.5 kg (main unit only, no options)

Measurement Range and Display Range

The measurement range of the ScopeCorder is ±10 divisions (20 divisions of absolute width (span)) around 0 V. The display range of the screen is ±5 divisions (10 divisions of span). The following functions can be used to move the displayed waveform and display the waveform outside the display range by expanding/reducing the displayed waveform.

- Move the vertical position.
- Set an offset voltage.
- Zoom in or out of the vertical axis (expand/reduce).

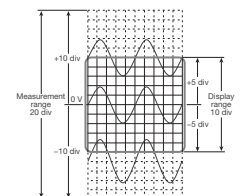
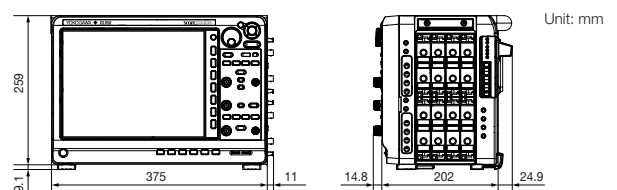
**Outline Drawing**

Model and suffix code

Model	Suffix codes	Description
DL950		ScopeCorder, 1 G Points memory ¹
Power cord	-D	UL/CSA standard and PSE compliant
	-F	VDE/Korean standard
	-R	Australian standard
	-Q	British standard
	-H	Chinese standard
	-N	Brazilian standard
	-T	Taiwanese standard
	-B	Indian standard
	-U	IEC Plug Type B
	Language	-HJ
-HE		English menu and panel
-HC		Chinese menu and panel
-HK		Korean menu and panel
-HG		German menu and panel
-HF		French menu and panel
-HL		Italian menu and panel
-HS		Spanish menu and panel
-HR		Russian menu and panel
Option		/M1 ²
	/M2 ²	Memory expansion to 8 G Points ⁷
	/ST1	Internal storage (512 GB)
	/C35	IRIG and GPS interface
	/C40	IEEE1588 Master function
	/C50	Multi-unit synchronization interface
	/C60	10 Gbps Ethernet interface
	/G02	User-defined math function
	/G03 ³	Real time math function
	/G05 ³	Power math function (including Real time math function)
/P4 ⁴	Four probe power outputs	
/P8 ⁴	Eight probe power outputs	
/VCE	Vehicle edition	

Standard Main Unit Accessories

Power cord, front cover, panel sheet, 8 slot cover panels, user's manuals⁵

*1: The main unit requires plug-in module (s). Max. 500 M Points/CH. *2,*3,*4: Only one of these can be selected. *5: The Start Guide is provided as a printed document and other manuals on a CD-ROM. *6: Max. 2 G Points/CH *7: Max. 4 G Points/CH

Binary files saved by DL950 cannot be opened by Xviewer. Please use IS8000.

Additional option license for DL950*

Model	Suffix code	Description
709831	-C40	IEEE1588 Master function
	-G02	User-defined math function
	-G05	Power math function (including Real time math function) /G03 is necessary to add /G05
	-VCE	Vehicle edition

*Separately sold license product (customer-installable).

ScopeCorder, is registered trademarks of Yokogawa Electric Corporation.

*Any company's names and product names mentioned in this document are trade names, trademarks or registered trademarks of their respective companies. The User's Manuals of this product are provided by CD-ROM.

Plug-in module model numbers

See page 18 for details.

NOTICE

- Before operating the product, read the user's manual thoroughly for proper and safe operation.

Yokogawa's Approach to Preserving the Global Environment

- Yokogawa's electrical products are developed and produced in facilities that have received ISO14001 approval.
- In order to protect the global environment, Yokogawa's electrical products are designed in accordance with Yokogawa's Environmentally Friendly Product Design Guidelines and Product Design Assessment Criteria.

Probes, cables, and converters*⁸

Model	Product	Description ¹
701947	100:1 Probe	1000 V (DC+ACpeak) CAT II, 1.5 m
702902	10:1 Probe	Operating temp. range: -40 to 85°C, 2.5 m
700929	10:1 Probe	1000 V (DC+ACpeak) CAT II, 1.5 m
701901	1:1 Safety BNC adapter lead	1000 Vrms CAT II
701904	1:1 Safety Adapter Lead	1000 Vrms CAT II, 600 Vrms CAT III
(in combination with the following)		
758928	Pinchers tip (Hook type)	1000 Vrms CAT III, 1 set each of red and black
701954	Large alligator-clip (Dolphin type)	1000 Vrms CAT III, 1 set each of red and black
758929	Alligator clip adaptor set	1000 Vrms CAT II, 1 set each of red and black
758922	Alligator clip adaptor set	300 Vrms CAT II, 1 set each of red and black
758921	Fork terminal adapter set	1000 Vrms CAT II, 1 set each of red and black
701940	Passive probe ²	Non-isolated 600 Vpk (701255) (10:1)
366926	1:1 BNC-alligator cable	Non-isolated 42 V or less, 1 m
366961	1:1 Banana-alligator cable	Non-isolated 42 V or less, 1.2 m
702915	Current probe ^{3,4}	0.5, 5, 30 Arms, DC to 50 MHz
702916	Current probe ^{3,4}	0.5, 5, 30 Arms, DC to 120 MHz
701917	Current probe ^{3,4}	5 Arms, DC to 50 MHz
701918	Current probe ^{3,4}	5 Arms, DC to 120 MHz
701932	Current probe ^{3,4}	30 Arms, DC to 100 MHz
701933	Current probe ^{3,4}	30 Arms, DC to 50 MHz
701930	Current probe ^{3,4}	150 Arms, DC to 10 MHz
701931	Current probe ^{3,4}	500 Arms, DC to 2 MHz
720930	Clamp-on probe	AC 50 Arms, 40 Hz to 3.5 kHz
720931	Clamp-on probe	AC 200 Arms, 40 Hz to 3.5 kHz
701934	Probe power supply	External probe power supply (4 outputs)
701977	Differential probe ^{3,4}	7000 Vpeak, 5000 Vrms (For 701255)
701978	Differential probe ^{3,4}	1500 Vpeak, 1000 Vrms (For 701255)
701955	Bridge head (NDIS, 120 Ω)	With 5 m cable
701956	Bridge head (NDIS, 350 Ω)	With 5 m cable
701957	Bridge head (DSUB, 120 Ω)	Shunt-CAL with 5 m cable
701958	Bridge head (DSUB, 350 Ω)	Shunt-CAL with 5 m cable
758924	Safety BNC-banana adapter	500 Vrms CAT II
702911	Logic probe ⁵	8 bit, 1 m, non-isolated, TTL level/Contact Input
702912	Logic probe ⁵	8 bit, 3 m, non-isolated, TTL level/Contact Input
700986	High-speed logic probe ⁵	8 bit, non-isolated, response speed: 1 μs (typ.)
700987	Isolation logic probe ⁵	8 bit, each channel isolated
758917	Measurement lead set ⁷	0.75 m, Stackable type (2 per set) Separate alligator clips are required.
758933	Measurement lead set ⁷	1000 V/19 A/1 m length Separate alligator clips are required.
701902	Safety BNC-BNC cable (1 m)	1000 Vrms CAT II (BNC-BNC)
701903	Safety BNC-BNC cable (2 m)	1000 Vrms CAT II (BNC-BNC)
701948	Plug-on clip	For 700929 and 701947
701906	Long test clip	For 701977, 701978 and 701901
720941	Optical Transceiver Module	For multi-unit connection
720942	Optical Fiber Cord	For multi-unit connection, 3 m
701972	Soft carrying case	For DL950
720940	GPS unit	For DL950 and DL350

*1: Actual allowable voltage is the lower of the voltages specified for the main unit and cable. *2: 30 Vrms is safe when using the 701940 with an isolated type BNC input. *3: The number of current probes that can be powered from the main unit's power supply is limited. *4: Either the probe power option of the main unit or the probe power supply (701934) is required. *5: Includes one of each of the B9879PX and B9879KX connection leads. *6: Additionally, 758917 and either the 758922 or 758929 are required for measurement. *7: Alligator clips are required. *8: Refer to the bulletin and user's manual of each product to confirm the compatibility with the main unit.

This is a Class A instrument based on Emission standards EN61326-1 and EN55011, and is designed for an industrial environment.

Operation of this equipment in a residential area may cause radio interference, in which case users will be responsible for any interference which they cause.

The DL950, 720212, and 720211 use an Internal laser light source.



Complies with 21 CFR 1040.10 and 1040.11 except for deviations pursuant to Laser Notice No.50, dated June 24, 2007
4-9-8 Myojin-cho, Hachioji-shi, Tokyo 192-8566, Japan

YOKOGAWA

YOKOGAWA TEST & MEASUREMENT CORPORATION

Global Sales Dept. /Phone: +81-42-690-8810 E-mail: tm@cs.jp.yokogawa.com
Facsimile: +81-42-690-8826

YOKOGAWA CORPORATION OF AMERICA

YOKOGAWA EUROPE B.V.

YOKOGAWA TEST & MEASUREMENT (SHANGHAI) CO., LTD.

YOKOGAWA ELECTRIC KOREA CO., LTD.

YOKOGAWA ENGINEERING ASIA PTE. LTD.

YOKOGAWA INDIA LTD.

YOKOGAWA ELECTRIC CIS LTD.

YOKOGAWA AMERICA DO SUL LTDA.

YOKOGAWA MIDDLE EAST & AFRICA B.S.C(eg)

Phone: +1-800-888-6400

Phone: +31-88-4641429

Phone: +86-21-6239-6363

Phone: +82-2-2628-3810

Phone: +65-6241-9933

Phone: +91-80-4158-6396

Phone: +7-495-737-7868

Phone: +55-11-3513-1300

Phone: +973-17-358100

E-mail: tmi@us.yokogawa.com

E-mail: tmi@nl.yokogawa.com

E-mail: tmi@cs.cn.yokogawa.com

E-mail: TMI@kr.yokogawa.com

E-mail: TMI@sg.yokogawa.com

E-mail: tmi@in.yokogawa.com

E-mail: info@ru.yokogawa.com

E-mail: eproc@br.yokogawa.com

E-mail: help.ymatmi@bh.yokogawa.com

YMI-KS-MI-SE08

The contents are as of February, 2021. Subject to change without notice.
Copyright © 2021, Yokogawa Test & Measurement Corporation

[Ed: 01/b]

Printed in Japan, 102(KP)

Facsimile: +86-21-6880-4987

Facsimile: +82-2-2628-3899

Facsimile: +65-6241-9919

Facsimile: +91-80-2852-1442

Facsimile: +7-495-737-7869

Facsimile: +973-17-336100