

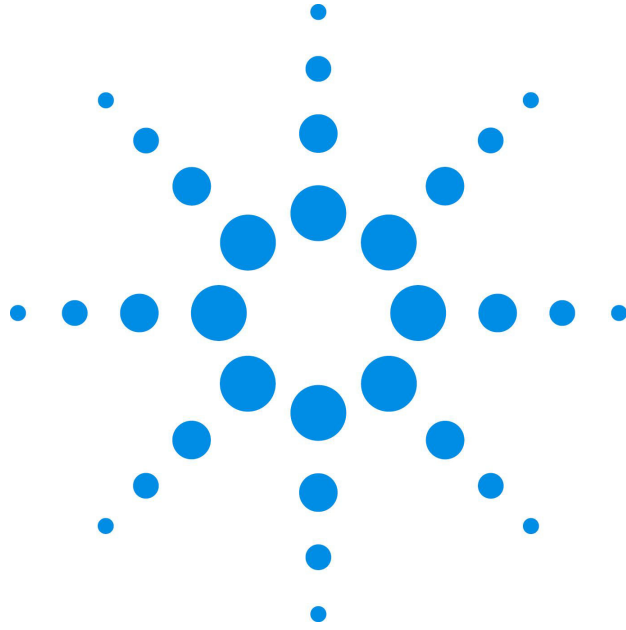

Advanced Test Equipment Rentals
www.atecorp.com 800-404-ATEC (2832)



Agilent 53131A/132A
225 MHz Universal Counter

Operating Guide

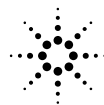

Agilent Technologies

Manual Part Number 53131-90055
Printed in Malaysia

NOTES

Agilent 53131A/132A 225 MHz Universal Counter Operating Guide

This guide describes how to use the Agilent 53131A/132A 225 MHz Universal Counter.

Agilent 53131A/132A 225 MHz
Universal Counter

©Copyright Agilent Technologies Inc., 1993, 1996, 1998, 1999, 2006

All Rights Reserved. Reproduction, adaptation, or translations without prior written permission is prohibited, except as allowed under the copyright laws.

Printed: October 2006

Printed in Malaysia

**Manual part number
53131-90055**

Certification and Warranty

Certification

Agilent Technologies certifies that this product met its published specification at the time of shipment from the factory. Agilent Technologies further certifies that its calibration measurements are traceable to the United States National Institute of Standards and Technology (formerly National Bureau of Standards), to the extent allowed by the Institute's calibration facility, and to the calibration facilities of other International Standards Organization members.

Warranty

Agilent warrants Agilent hardware, accessories and supplies against defects in materials and workmanship for a period of one year from date of shipment. If Agilent receives notice of such defects during the warranty period, Agilent will, at its option, either repair or replace products which prove to be defective. Replacement products may be either new or like-new.

Agilent warrants that Agilent software will not fail to execute its programming instructions, for the period specified above, due to defects in material and workmanship when properly installed and used. If Agilent receives notice of such defects during the warranty period, Agilent will replace software media which does not execute its programming instructions due to such defects.

For detailed warranty information, see back matter.

Safety Considerations

General

This product and related documentation must be reviewed for familiarization with this safety markings and instructions before operation.

Before Cleaning

Disconnect the product from operating power before cleaning.

Warning Symbols That May Be Used In This Book



Instruction manual symbol; the product will be marked with this symbol when it is necessary for the user to refer to the instruction manual.



Indicates hazardous voltages.



Indicates earth (ground) terminal.



or



Indicates terminal is connected to chassis when such connection is not apparent.



Indicates Alternating current.



Indicates Direct current.

Safety Considerations (contd)

WARNING
BODILY INJURY OR DEATH MAY RESULT FROM FAILURE TO HEED A WARNING. DO NOT PROCEED BEYOND A WARNING UNTIL THE INDICATED CONDITIONS ARE FULLY UNDERSTOOD AND MET.

CAUTION
Damage to equipment, or incorrect measurement data, may result from failure to heed a caution. Do not proceed beyond a *CAUTION* until the indicated conditions are fully understood and met.

Safety Earth Ground

An uninterruptible safety earth ground must be maintained from the mains power source to the product's ground circuitry.

WARNING
WHEN MEASURING POWER LINE SIGNALS, BE EXTREMELY CAREFUL AND ALWAYS USE A STEP-DOWN ISOLATION TRANSFORMER WHICH OUTPUT IS COMPATIBLE WITH THE INPUT MEASUREMENT CAPABILITIES OF THIS PRODUCT. THIS PRODUCT'S FRONT AND REAR PANELS ARE TYPICALLY AT EARTH GROUND. *THUS, NEVER TRY TO MEASURE AC POWER LINE SIGNALS WITHOUT AN ISOLATION TRANSFORMER.*

Warranty (contd)

Agilent does not warrant that the operation of Agilent products will be uninterrupted or error free. If Agilent is unable, within a reasonable time, to repair or replace any product to a condition as warranted, customer will be entitled to a refund of the purchase price upon prompt return of the product.

Agilent products may contain remanufactured parts equivalent to new in performance or may have been subjected to incidental use.

The warranty period begins on the date of delivery or on the date of installation if installed by Agilent. If customer schedules or delays Agilent installation more than 30 days after delivery, warranty begins on the 31st day from delivery.

Warranty does not apply to defects resulting from (a) improper or inadequate maintenance or calibration, (b) software, interfacing, parts or supplies not supplied by Agilent, (c) unauthorized modification or misuse, (d) operation outside of the published environmental specifications for the product, or (e) improper site preparation or maintenance.

TO THE EXTENT ALLOWED BY LOCAL LAW, THE ABOVE WARRANTIES ARE EXCLUSIVE AND NO OTHER WARRANTY OR CONDITION, WHETHER WRITTEN OR ORAL, IS EXPRESSED OR IMPLIED AND AGILENT SPECIFICALLY DISCLAIMS ANY IMPLIED WARRANTIES OR CONDITIONS OF MERCHANTABILITY, SATISFACTORY QUALITY, AND FITNESS FOR A PARTICULAR PURPOSE.

Agilent will be liable for damage to tangible property per incident up to the greater of \$300,000 or the actual amount paid for the product that is the subject of the claim, and for damages for bodily injury or death, to the extent that all such damages are determined by a court of competent jurisdiction to have been directly caused by a defective Agilent product.

TO THE EXTENT ALLOWED BY LOCAL LAW, THE REMEDIES IN THIS WARRANTY STATEMENT ARE CUSTOMER'S SOLE AND EXCLUSIVE REMEDIES. EXCEPT AS INDICATED ABOVE, IN NO EVENT WILL AGILENT OR ITS SUPPLIERS BE LIABLE FOR LOSS OF DATA OR FOR DIRECT, SPECIAL, INCIDENTAL, CONSEQUENTIAL (INCLUDING LOST PROFIT OR DATA), OR OTHER DAMAGE, WHETHER BASED IN CONTRACT, TORT, OR OTHERWISE.

For consumer transactions in Australia and New Zealand: the warranty terms contained in this statement, except to the extent lawfully permitted, do not exclude, restrict or modify and are in addition to the mandatory statutory rights applicable to the sale of this product to you.

Assistance

Product maintenance agreements and other customer assistance agreements are available for Agilent Technologies products.

For any assistance, contact your nearest Agilent Technologies Sales and Service Office.

Safety Considerations (contd)

WARNING

INSTRUCTIONS FOR ADJUSTMENTS WHILE COVERS ARE REMOVED AND FOR SERVICING ARE FOR USE BY SERVICE-TRAINED PERSONNEL ONLY. TO AVOID DANGEROUS ELECTRIC SHOCK, DO NOT PERFORM SUCH ADJUSTMENTS OR SERVICING UNLESS QUALIFIED TO DO SO.

WARNING

ANY INTERRUPTION OF THE PROTECTIVE GROUNDING CONDUCTOR (INSIDE OR OUTSIDE THE PRODUCT'S CIRCUITRY) OR DISCONNECTING THE PROTECTIVE EARTH TERMINAL WILL CAUSE A POTENTIAL SHOCK HAZARD THAT COULD RESULT IN PERSONAL INJURY. (GROUNDING ONE CONDUCTOR OF A TWO CONDUCTOR OUTLET IS NOT SUFFICIENT PROTECTION.)

Whenever it is likely that the protection has been impaired, the instrument must be made inoperative and be secured against any unintended operation.

If this instrument is to be energized via an autotransformer (for voltage reduction) make sure the common terminal is connected to the earthed pole terminal (neutral) of the power source.

Instructions for adjustments while covers are removed and for servicing are for use by trained-personnel only. To avoid dangerous electric shock, do not perform such adjustments or servicing unless qualified to do so.

For continued protection against fire, replace the line fuse(s) of the same current rating and type (for example, normal blow, time delay). Do not use repaired fuses or short circuited fuseholders.

Acoustic Noise Emissions

LpA<47 dB at operator position, at normal operation, tested per EN 27779. All data are the results from type test.

Geräuschemission

LpA<47 dB am Arbeitsplatz, normaler Betrieb, geprüft nach EN 27779.
Die Angaben beruhen auf Ergebnissen von Typenprüfungen.



Agilent Technologies

DECLARATION OF CONFORMITY

According to ISO/IEC Guide 22 and CEN/CENELEC EN 45014



Manufacturer's Name: Agilent Technologies, Incorporated
Manufacturer's Address: Santa Clara Site
5301 Stevens Creek Blvd
Santa Clara, California 95051

Declares, that the product

Product Name: Universal Counter Frequency Counter
Model Number: 53131A, 53132A 53181A
Product Options: *This declaration covers all options of the above product.*

Conforms with the following European Directives:

The product herewith complies with the requirements of the Low Voltage Directive 73/23/EEC and the EMC Directive 89/336/EEC (including 93/68/EEC) and carries the CE Marking accordingly.

EMC	Standard	Limit
	IEC 61326-1:1997+A1:1998 / EN 61326-1:1997+A1:1998 CISPR 11:1990 / EN 55011:1991 IEC 61000-4-2:1995+A1:1998 / EN 61000-4-2:1995 IEC 61000-4-3:1995 / EN 61000-4-3:1995 IEC 61000-4-4:1995 / EN 61000-4-4:1995 IEC 61000-4-5:1995 / EN 61000-4-5:1995 IEC 61000-4-6:1996 / EN 61000-4-6:1996 IEC 61000-4-11:1994 / EN 61000-4-11:1994	Group 1 Class A ^[1] 4kV CD, 8kV AD 3 V/m, 80-1000 MHz 0.5kV signal lines, 1kV power lines 0.5 kV line-line, 1 kV line-ground 3V, 0.15-80 MHz 1 cycle, 100%
	Canada: ICES-001:1998 Australia/New Zealand: AS/NZS 2064.1	
Safety	IEC 61010-1:1990+A1:1992+A2:1995 / EN 61010-1:1993+A2:1995 Canada: CSA C22.2 No. 1010.1:1992	

Supplemental Information:

^[1] *The product was tested in a typical configuration with Agilent Technologies test systems.*

July 31, 2001

Date

Art Nanawa, Product Regulations Manager

Contents

In This Guide

Contents and Organization	xii
Related Documents	xiii
Types of Service Available if Your Instrument Fails	xiv
Standard Repair Services (Worldwide)	xiv
Express Repair/Performance Calibration Service (USA Only)	xiv
Assembly-Level Service Guide	xiv
Repackaging for Shipment	xv
Description of the 225 MHz Universal Counter	xvi
Options	xviii
Hardware	xviii
Support	xviii
Accessories Supplied and Available	xix
Accessories Supplied	xix
Accessories Available	xix
Supplied Manuals	xix
Differences Between Prior and Current Revisions of the Agilent 53131A/132A	xx
Agilent 53131A Containing Firmware Revisions (3317, 3335, or 3402)	xx
Calibrations	xxi
Measurements	xxi
Statistics	xxii
GPIB Commands	xxii
Agilent 53132A Time Interval Delay Arming	xxii

1 Getting Started

The Front Panel at a Glance	1-2
The Front Panel Indicators at a Glance	1-3
The Front Panel Indicators at a Glance (Cont.)	1-4
The Front Panel Menus at a Glance	1-5
The Front Panel Menus at a Glance (Cont.)	1-6
The Front Panel Menus at a Glance (Cont.)	1-7
The Front Panel Menus at a Glance (Cont.)	1-8
The Display Annunciators at a Glance	1-9
The Display Special Character at a Glance	1-10
The Limit Test Graph Characters at a Glance	1-10
The Rear Panel at a Glance	1-11
Making Measurements	1-12
To Measure Frequency	1-13
To Select Input Coupling and Impedance	1-15
Selecting Input Coupling	1-15
Selecting Input Impedance	1-16
To Set Input Channel Trigger Level/Sensitivity	1-17
Changing Trigger Mode	1-17
Modifying Input Trigger Level	1-17
Selecting Input Trigger Slope	1-18
Selecting Input Sensitivity	1-19
Starting the Measurement	1-19
To Select Scale and Offset	1-19
Entering the Scale Value	1-20
Entering the Offset Value	1-21
Displaying the Math Results	1-22
Disabling Math	1-22
To Set Limits of Measurements	1-23
Setting the Upper Limit	1-24
Setting the Lower Limit	1-26

Contents

Setting the Counter to Flag and Stop Measuring On Out-of-Limit Measurements	1-28
Setting the Counter to Flag On Limits But Continue Measuring	1-29
Disabling Limit Testing	1-30
Disabling Math	1-30
To Perform Statistics on Measurements	1-31
Selecting the Type of Statistics (Stats)	1-31
Computing Stats on Filtered Data Only	1-32
Displaying Stats After Filtering Data of Input Signal	1-34
Disabling Stats and Math	1-35
To Control Measurement	1-36

2 Operating Your Universal Counter

Introduction 2-2

Chapter Summary 2-2

Where to Find Some Key Working Examples 2-3

How this Counter Works for You 2-4

Using the Measurement Control Keys (Run and Stop/Single) 2-5

Overview of the Measurement Control Keys 2-5

To Use the Measurement Control Keys 2-6

Using Entry/Select (Arrow) Keys 2-8

To Use During Numeric Entry 2-8

To Use When Sequencing Through the Measurement Function Menus (Freq & Ratio, Time & Period, Other Meas) and the Recall Menu 2-8

To Use During State Changing (ON/OFF, LO/MED/HI, etc.) 2-9

To Use on Prompted Event Messages (SET OFFSET ?, CAL: OFFS n ?, TEST: ALL?, etc.) 2-9

To Use on Prompted Help Messages (MATH HELP ?, PRINT HELP ?) 2-9

Using the MEASURE Menu Keys 2-10

Overview of the MEASURE Menus 2-10

Contents

To Measure Frequency	2-11
To Measure Frequency Ratio	2-12
To Measure Time Interval	2-13
To Measure Period	2-13
To Measure Rise/Fall Times	2-13
To Measure Positive/Negative Pulse Widths	2-14
To Measure Duty Cycle	2-14
To Make Totalize Measurements	2-14
To Make Phase Measurements	2-15
To Measure Positive/Negative Voltage Peaks	2-15
Using the Gate & External Arm Menu Key	2-16
Overview of Gate/External Arming Functions	2-16
Gate/External Arming Capabilities	2-16
AUTO Arming	2-16
EXTERNAL Arming	2-17
TIME Arming	2-17
DIGITS Arming	2-17
Agilent 53131A (and Agilent 53132A With S/N Prefix Below 3646) Time Interval DELAY Arming	2-17
Agilent 53132A (With S/N Prefix 3646 and Above) Time Interval DELAY Arming	2-20
To Use the Gate and External Arm	2-24
Example Procedure for Gate and External Arm	2-24
Example Procedure for Changing the Number of Digits of Resolution Displayed for More Precise Measurements	2-25
Using the MATH Menu Keys	2-27
Overview of Scale/Offset Math Menu	2-27
To Use the Scale/Offset Math Menu	2-28
Example Procedure for Scale Function	2-28
Example Procedure for Offset Function	2-29
Example Procedure for Turning Off Math Mode	2-30

Contents

Example Procedure for Setting the Offset From the Last Measurement Value	2-31
Overview of Statistics (Stats) Menu	2-32
To Use the Stats Menu for Automatic and Continuous Statistical Analysis	2-33
Example Procedure for Computing Stats	2-33
Example Procedure for Easy Viewing of Stats	2-34
Example Procedure for Filtering Data (Using Limits) During Stats	2-35
Example Procedure for Configuring SINGLE to Initiate N Measurements	2-36
Example Procedure for Turning Off Stats Mode	2-36
Using the LIMITS Menu Keys	2-37
Overview of Limits Menus	2-37
To Set and Use Automatic Limit Testing	2-38
Limits Testing Example 1—Flag and Stop Measuring On Limits	2-38
Limits Testing Example 2—Flag On Limits but Continue Measuring	2-40
Limits Testing Example 3—Use Analog Graph Display While Adjusting Input Signal	2-40
Limits Testing Example 4—Selecting Filtering Conditions of Stats Computation	2-42
Limits Testing Example 5—Sending the Limit-Detect Output to the RS-232 Serial Port	2-43
Using CHANNEL 1 and CHANNEL 2 Input Conditioning Keys	2-44
Overview of Trigger/Sensitivity Menu	2-44
To Use the Trigger/Sensitivity Keys to Adjust Counter's Triggering Level	2-48
Example Procedure for Setting Trigger Voltage and Sensitivity Levels	2-48
Example Procedure for Using Common 1 to Make Time Interval (TI) Measurements on a Single Signal	2-51

Contents

Overview of Input Conditioning Toggle Keys	2-51
Using the Save and Recall Menus	2-52
Overview of Save and Recall Functions	2-52
To Use the Save Function	2-53
To Use the Recall Function	2-54
To Unsave a Measurement Setup	2-55
Using the Print Menu	2-56
Overview of the Print Menu	2-56
To Use the Print Menu	2-56
Using the Utility Menu	2-57
Overview of the Utility Menu	2-57
To Set the GPIB Address	2-58
Selecting Operating Mode (Talk/Listen, Talk-Only)	2-58
Setting the GPIB Address	2-58
To Choose the Timebase Source	2-59
To Run the Self-Test Routines	2-59
Overview of the Self-Test Routines	2-59
Example Procedure for Running the Self Test	2-61
To Configure the RS-232 Serial Port for Printing	2-61
Setting the Hardware Pacing	2-62
Setting the Baud Rate	2-62
Setting the Parity	2-63
Setting the Software Pace	2-63
To Configure the RS-232 Serial Port for Sending Limit-Detect Output	2-64
To Select the Numerical Convention for the Display	2-65
To Connect the Counter to a Serial Printer via the RS-232 Port	2-65
To Connect the Counter to a Printer via GPIB	2-66
To Select the GPIB Talk-Only Mode for Printing	2-66
Using the Calibration Menu	2-67
Overview of the Calibration Menu	2-67
To View the Calibration Menu and Security Status	2-68

Contents

- To Unsecure for Calibration 2-68
- To Initiate the Calibration Routines 2-69
- To Secure Against Calibration 2-71
- To Change to a New Security Code 2-72
- To View the Calibration Count 2-72
- To Get Help With the Calibration Menu 2-72

Front Panel Display Messages 2-73

- Measurement Result Displays 2-73
- Power-Up/Self Test Messages 2-74
- Menu Messages 2-75
- GPIB Messages 2-77

Preset Values After Power-Up and *RST 2-78

Agilent 53131A (and Agilent 53132A With S/N Prefix Below 3646)
Preset Values for Functions Accessible Via Front Panel or
GPIB 2-79

Agilent 53132A (With S/N Prefix 3646 and Above) Preset Values for
Functions Accessible Via Front Panel or GPIB 2-85

Preset Values for Functions Accessible Via GPIB Only 2-91

Summary of the Measurement Sequence 2-93

Common Questions 2-94

- Why is Stats result not available yet? 2-94
- Why won't printer work? 2-94
- Why did Counter stop measuring? 2-94
- Why did Counter go to its default state after I set up my RS-232
port? 2-94
- Counter's numeric display does not follow the numerical convention
for my country. 2-94
- How do I display the 13th digit in my numerical result? 2-94

3 Specifications

Introduction 3-2

- Instrument Inputs 3-2
- Instrument Inputs (Continued) 3-3

Contents

Time Base	3-4
Measurement Specifications	3-5
Measurement Specifications (Continued)	3-6
Measurement Definitions	3-12
Measurement Definitions (Continued)	3-13
Measurement Arming and Processing	3-14
Measurement Arming and Processing (Continued)	3-15
General Information	3-16

Index

In This Guide

This book is the operating guide for the Agilent 53131A and Agilent 53132A 225 MHz Universal Counters. It consists of a table of contents, this preface, a quick reference guide, three chapters, and an index.

This preface contains the following information:

- Contents and Organization page xii
- Related Documents page xiii
- Types of Service Available if Your Instrument Fails page xiv
- Repackaging for Shipment page xv
- Description of the 225 MHz Universal Counter page xvi
- Options page xviii
- Accessories Supplied and Available page xix
 - Supplied Manuals page xix
- Differences Between Prior and Current Revisions of the Agilent 53131A/132A page xx

Contents and Organization

Table of Contents

The **Quick Reference Guide** consists of a Menu Tree (cut-out sheet) that serves as a device to trigger your memory or get you quickly reacquainted with the instrument, and Menu Roadmaps that illustrate how to navigate through the menus. It is located after this preface.

Chapter 1, “**Getting Started**,” is a quick start guide that gives you a brief overview of the Counter’s keys, indicators, menus, display, and connectors. Last, a graphical procedure for performing a complete measurement is provided.

Chapter 2, “**Operating Your Universal Counter**,” is an operator’s reference. You are given an overview of each group of front-panel keys, operating functions, and menus followed by a series of exercises that guide you through the operation of the Counter.

Chapter 3, “**Specifications**,” lists the specifications and characteristics of the Counter.

Index

Related Documents

For more information on universal counters refer to the following Series 200 Application Notes:

- *Fundamentals of Electronic Frequency Counters*
Application Note 200—Agilent part number 02-5952-7506.
- *Fundamentals of Time Interval Measurements*
Application Note 200-3—Agilent part number 02-5952-7561.
- *Understanding Frequency Counter Specifications*
Application Note 200-4—Agilent part number 02-5952-7522.

Types of Service Available if Your Instrument Fails

If your Agilent 53131A/132A fails within one year of original purchase, Agilent will repair it free of charge. If your instrument fails after your one-year warranty expires, Agilent will repair it, or you can repair it yourself by ordering the service guide (Agilent part number 53131-90039).

There are three types of repair services:

- Standard repair service—if downtime is not critical.
- Express Repair/Performance Calibration Service—if downtime is critical.
- Order the Assembly-Level Service Guide and repair unit yourself.

Standard Repair Services (Worldwide)

Contact your nearest Agilent Technologies Service Center. They will arrange to have your Agilent 53131A/132A Universal Counter repaired.

Express Repair/Performance Calibration Service (USA Only)

If downtime is critical, you can receive your repaired Agilent 53131A/132A via overnight shipment. Just call 1-800-403-0801 and ask for *Express Repair/Performance Calibration Service*. When your Counter is repaired, it will be returned via overnight shipment.

Assembly-Level Service Guide

If your Agilent 53131A/132A 1-year warranty has expired and you choose to repair the instrument yourself or would like more details on self test and calibration, refer to the Agilent 53131A/132A Assembly-Level Service Guide, Agilent part number 53131-90039.

Repackaging for Shipment

For the Express Repair/Performance Calibration Service described above, return your failed Agilent 53131A/132A to the designated Agilent Technologies Service Center, using the shipping carton of the instrument. Agilent will notify you when your failed instrument has been received.

If the instrument is to be shipped to Agilent for service or repair, be sure you do the following:

- Attach a tag to the instrument identifying the owner and indicating the required service or repair. Include the instrument model number and full serial number.
- Place the instrument in its original container with appropriate packaging material.
- Secure the container with strong tape or metal bands.

If the original shipping container is not available, place your unit in a container which will ensure at least 4 inches of compressible packaging material around all sides of the unit. Use static free packaging materials to avoid additional damage to your unit.

Agilent Technologies suggests that you always insure shipments.

Description of the 225 MHz Universal Counter

The Agilent 53131A and Agilent 53132A are universal counters capable of measuring frequencies to 225 MHz on Channels 1 and 2. With an optional Channel 3 Option 030, Option 050, or Option 124, this capability is extended to 3.0, 5.0, or 12.4 GHz, respectively.

For the Agilent 53131A, frequency and time interval resolutions are 10 digits in one second and 500 picoseconds, respectively. The Agilent 53131A provides users with a GPIB measuring speed of up to 200 measurements per second, and is suitable for bench-top operation and lower-volume ATE operation. The frequency and time interval resolutions for the Agilent 53132A are up to 12 digits in one second and 150 picoseconds, respectively. The Agilent 53132A provides users with exceptional resolution, and is ideal for ATE systems operation.

The Agilent 53131A/132A basic measurement functions include Frequency, Period, Pulse Width, Duty Cycle, Rise/Fall Time, Time Interval, Frequency Ratio, Totalize, Phase, and Peak Voltage. The Agilent 53131A/132A Counter has four arming modes: auto, external, digits and time. However, the Agilent 53132A with serial number prefix 3646 and above has expanded arming capabilities for Time Interval measurements.

In This Guide

The Agilent 53131A/132A include additional measurement functions and features that are designed specifically for manufacturing and service applications:

- 1, 5, 10 MHz external reference capability—to match customer's house standard (however, the Agilent 53132A's external reference capability is 10 MHz only),
- optional ultra high, high, or medium stability oven oscillators for high accuracy needs and lengthened calibration cycles,
- external gating,
- statistics,
- automatic limit testing,
- SCPI programming capability, and
- analog display mode limit testing

Programmable control is performed via an GPIB. The GPIB and a talk-only RS-232C serial port are standard for the Agilent 53131A and Agilent 53132A. The serial port is for printing measured and analyzed data on serial printers, or for outputting an out-of-limit signal.

Options

The options available for the Agilent 53131A/132A 225 MHz Universal Counter are listed following this paragraph. Specifications for the options are listed in Chapter 3, “Specifications.” If you’ve purchased an option with the initial order, it will be installed at the factory and ready for operation at delivery. Refer to the “Retrofitting Options” chapter in the Assembly-Level Service Guide for instructions on field installation of the options.

NOTE

The “0’s” and “1’s” in the following option numbers are numeric characters (that is, they are not letters).

Hardware

- Medium Stability Oven Timebase, Option 001
- DC Power Input, Option 002
- High Stability Oven Timebase, Option 010
- Ultra-High Stability Oven Timebase, Option 012 (Agilent 53132A only)
- 3.0 GHz RF Input Channel (Channel 3), Option 030
- 5.0 GHz RF Input Channel (Channel 3), Option 050
- 12.4 GHz RF Input Channel (Channel 3), Option 124
- Rear Terminals¹, Option 060
- Rack Mount Kit, Option 1CM. Also available under Agilent part number 5062-9240.
- Lock-Link Kit (side-by-side) available under Agilent part number 5061-9694. Also requires Flange Kit, part number 5062-3974.

Support

- 5-year Return to Agilent for Repair, Option W50
- 5-year Return to Agilent for Calibration, Option W52

¹ The two standard input channels (1 and 2) will have both front and rear terminals. Option 030 Channel 3 will have a rear terminal only. Option 050 and Option 124 Channel 3 will have a front terminal only.

Accessories Supplied and Available

Accessories Supplied

- Power cord, 2.3 meters

Accessories Available

- Agilent 34161A Accessory Pouch
- Agilent 34131A Transit Case
- Printer RS-232 Interface cables, Agilent 24542G or Agilent 24542H
- GPIB cables, Agilent 10833A/B/C/D

Supplied Manuals

- Agilent 53131A/132A Operating Guide—this guide
(Agilent P/N 53131-90055)
- Agilent 53131A/132A Programming Guide
(Agilent P/N 53131-90044)
- Agilent 53131A/132A Assembly-Level Service Guide
(Agilent P/N 53131-90039)

Differences Between Prior and Current Revisions of the Agilent 53131A/132A

If you have an Agilent 53131A containing one of the prior firmware revisions (3317, 3335, or 3402), read the subsection below titled “Agilent 53131A Containing Firmware Revisions (3317, 3335, or 3402)” to get an overview of the differences between the earlier firmware revisions and current firmware revision.

If you have an Agilent 53132A with a serial number prefix below 3646, read the subsection titled “Agilent 53132A Time Interval Delay Arming” on page xxii.

NOTE

Note that throughout the guide, differences between the earlier and current firmware revisions are noted where applicable.

Agilent 53131A Containing Firmware Revisions (3317, 3335, or 3402)

There are four main areas that differ:

- Calibrations
- Measurements
- Statistics
- GPIB Commands

In This Guide

Calibrations

If your Counter contains other than the current firmware revision, the following calibration features are different:

- The calibration functions are in the Utility menu instead of the Calibration menu, which is accessed by pressing and holding the front-panel **Utility** key and then cycling **POWER** key.
- Calibrations are not protected by a security code.
- A calibration count does not exist to aid in monitoring the number of calibrations performed.
- A more accurate Time Interval calibration (FINE TI) is not available.

See the section titled “Using the Calibration Menu” in Chapter 2 of the *Agilent 53131A/132A Operating Guide* for details.

Measurements

If your Counter contains other than the current firmware revision, the following measurement capabilities are different:

- Ratio channel selections Ratio 2 to 1 and Ratio 3 to 1 (for those counters equipped with Channel 3) are not available.
- Ratio “AUTO-armed” does not automatically extend gate to capture sufficient edges.

If Channel 1 input frequency is less than approximately 10 Hz, the Ratio gate time is not extended to capture sufficient Channel 1 edges to produce a valid measurement. Default gate time is 100 msec, which is not long enough to capture two edges on a low-frequency signal. The user is required to extend the gate by switching to TIME arming, and selecting a gate time appropriately long.

- Sensitivity for firmware revision below does not have adjusted controls to LO and MED sensitivity.

In some Counters that contained firmware revision 3317, LO sensitivity fails to correctly count very high frequency signals.

In This Guide

Statistics

If your Counter contains other than the current firmware revisions, single-shot statistics are not available using the **ON SINGLE:** menu item found in the Statistics menu (use **Stats** key).

GPIB Commands

[[:SENSE]:EVENT[1|2]:HYSTERESIS:RELATIVE

If your Counter contains firmware revisions 3402 and below, the input hysteresis command and query does not operate in the conventional way. That is, [[:SENSE]:EVENT[1|2]:HYSTERESIS:RELATIVE sets high sensitivity when the parameter is MINimum or 0 percent, and sets low sensitivity when the parameter is MAXimum or 100 percent.

In the prior firmware revisions (3317, 3335, or 3402), MINimum or 0 percent corresponded to low sensitivity, and MAXimum or 100 percent corresponded to high sensitivity.

:CONFigure:TOTalize:TIMed :CONFigure:TOTalize:CONTinuous :MEASure:TOTalize:TIMed?

If your Counter contains firmware revisions 3402 and below, the Totalize Measurement Instruction commands (shown above) are not available to disable auto-trigger.

In the firmware revisions 3402 and below, these commands enabled auto-trigger at the 50% level.

Agilent 53132A Time Interval Delay Arming

Agilent 53131A and Agilent 53132A Counters with a serial number prefix below 3646 are identical in their TI arming modes. Both only offer Time Interval Delay, where the STOP trigger of a time interval measurement can be delayed by a user-specified time.

Agilent 53131A/132A Quick Reference Guide

The Quick Reference Guide is designed for experienced users of the Agilent 53131A/132A Universal Counter. It is intended to be used as a tool to trigger your memory. If you are using the Agilent 53131A/132A for the first time, Agilent Technologies recommends that you at least read Chapter 1, “Getting Started,” in the Operating Guide first.

The Quick Reference Guide follows this page, and consists of the following items:

- Menu Trees which may be torn out of the guide for external use (pages 1, 2, 3a, and 3b).
- Menu Roadmaps which illustrate via key-press sequences how to navigate through the menus under the menu keys (pages 4 through 11). Key-press sequences are provided for the following menu keys:
 - **Freq & Ratio**
 - **Time & Period**
 - **Other Meas**
 - **Gate & ExtArm**
 - **Uppr & Lower**
 - **Limit Modes**
 - **Scale & Offset**
 - **Stats**
 - **Trigger/Sensitivity**

Agilent 53131A/132A Universal Counter

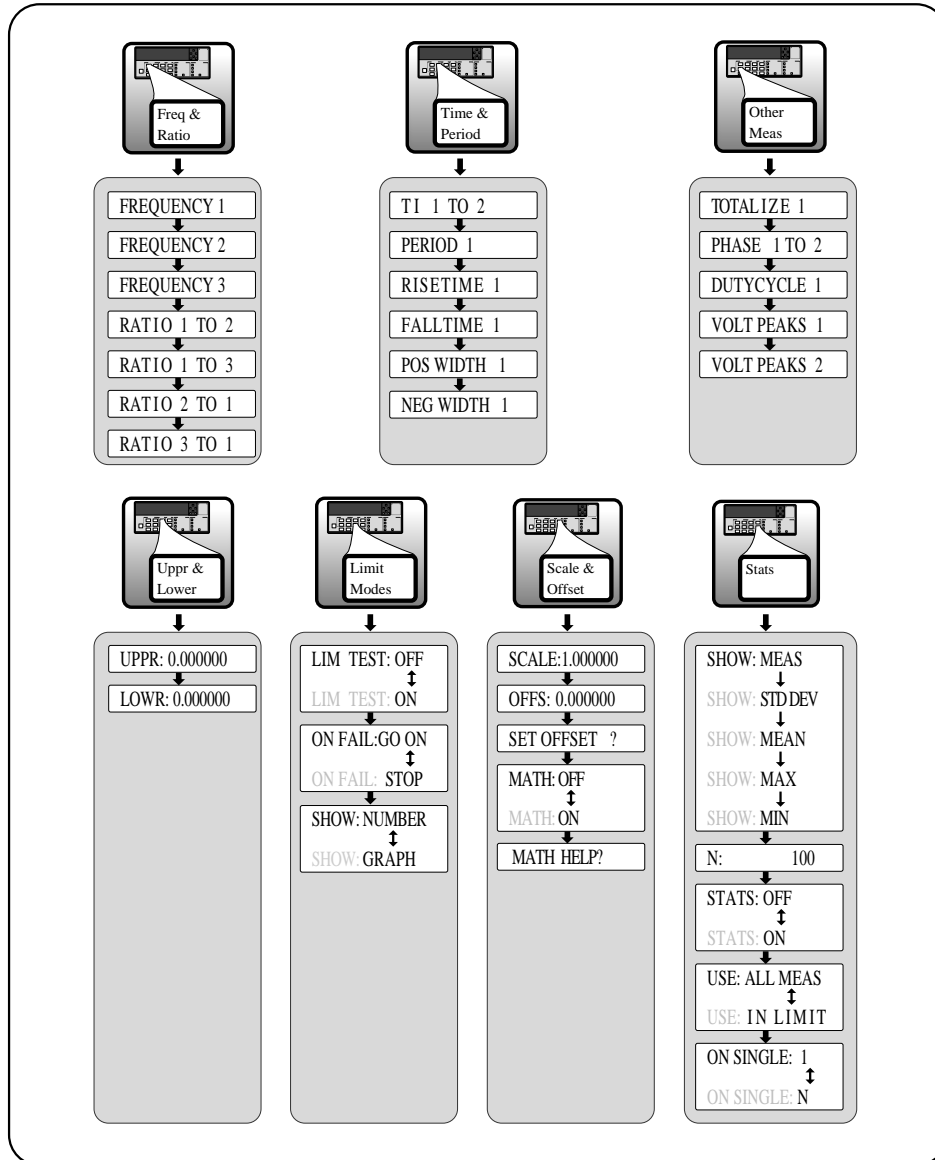

(Agilent 53131A and Agilent 53132A)

Agilent 53131A/132A Universal Counter

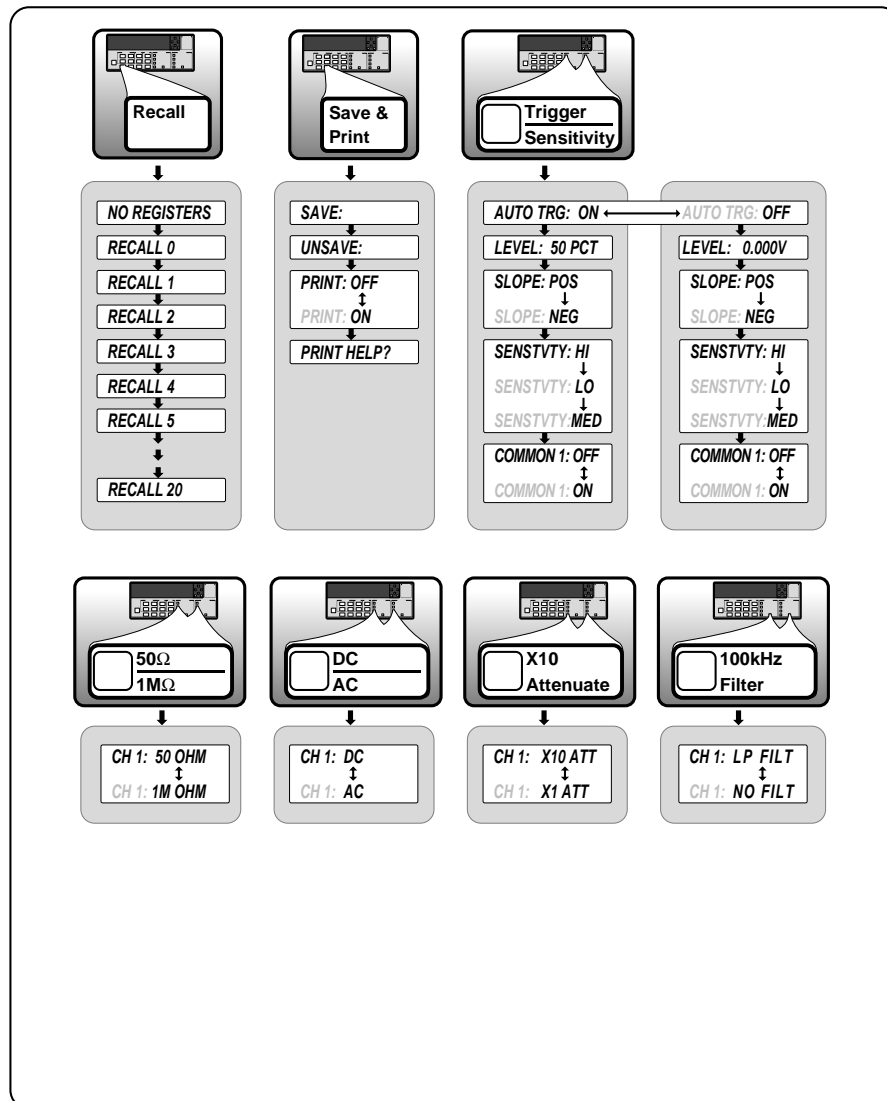

(Agilent 53131A and Agilent 53132A)

**Agilent 53131A and
Agilent 53132A (Serial Number Prefix below 3646)
Universal Counter**

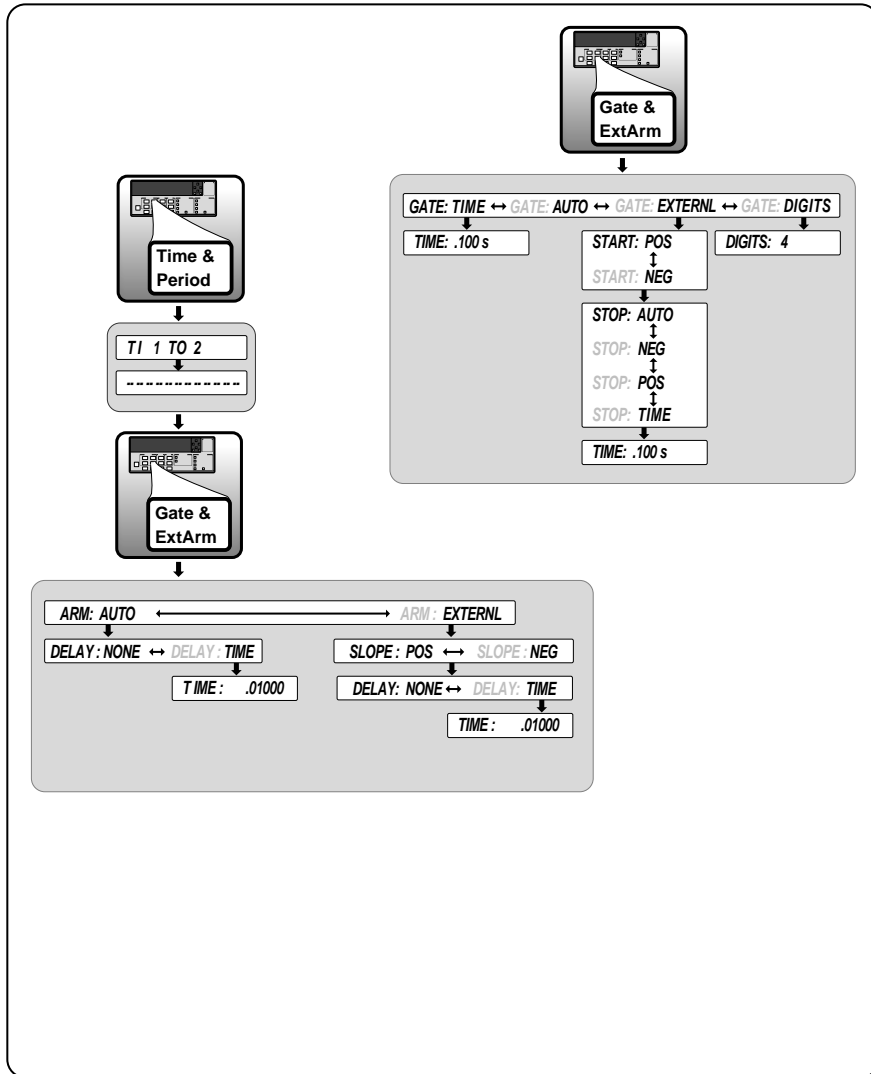

(Agilent 53131A and Agilent 53132A S/N below 3646)

**Agilent 53132A (Serial Number Prefix 3646 and above)
Universal Counter**

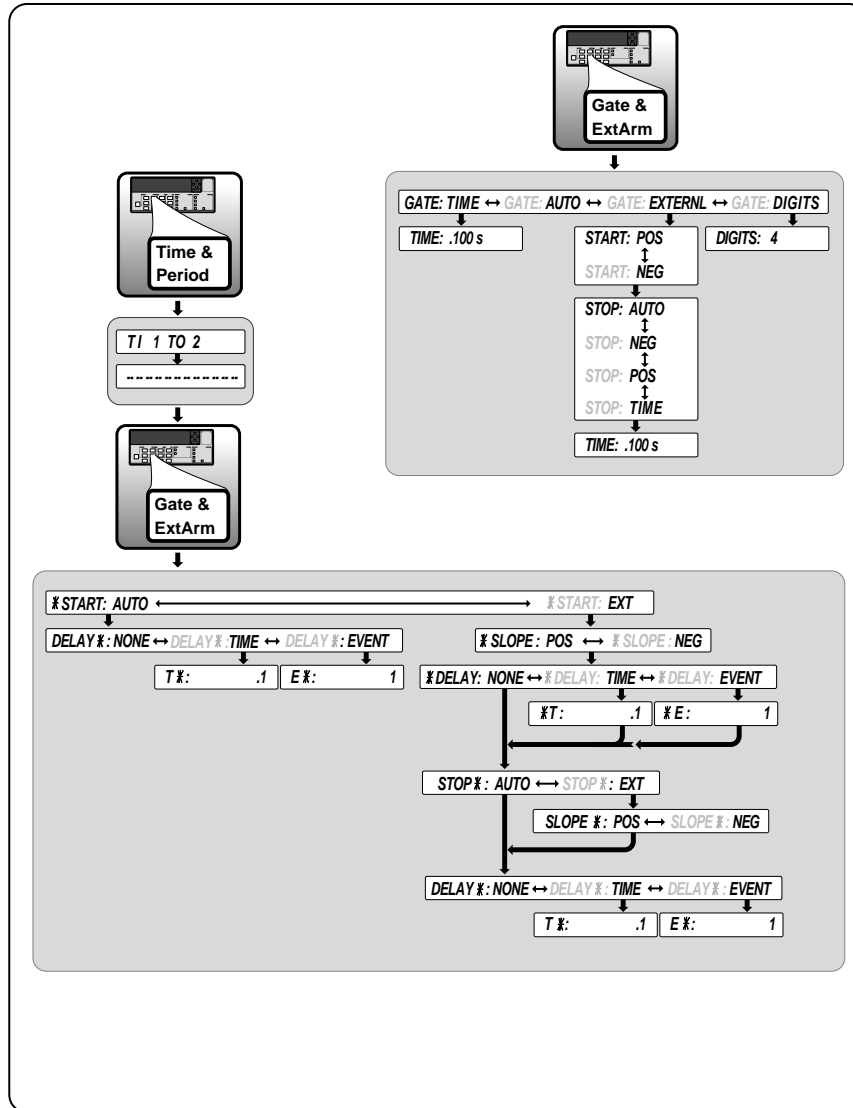

(Agilent 53132A S/N 3646 and above)

Agilent 53131A/132A Universal Counter

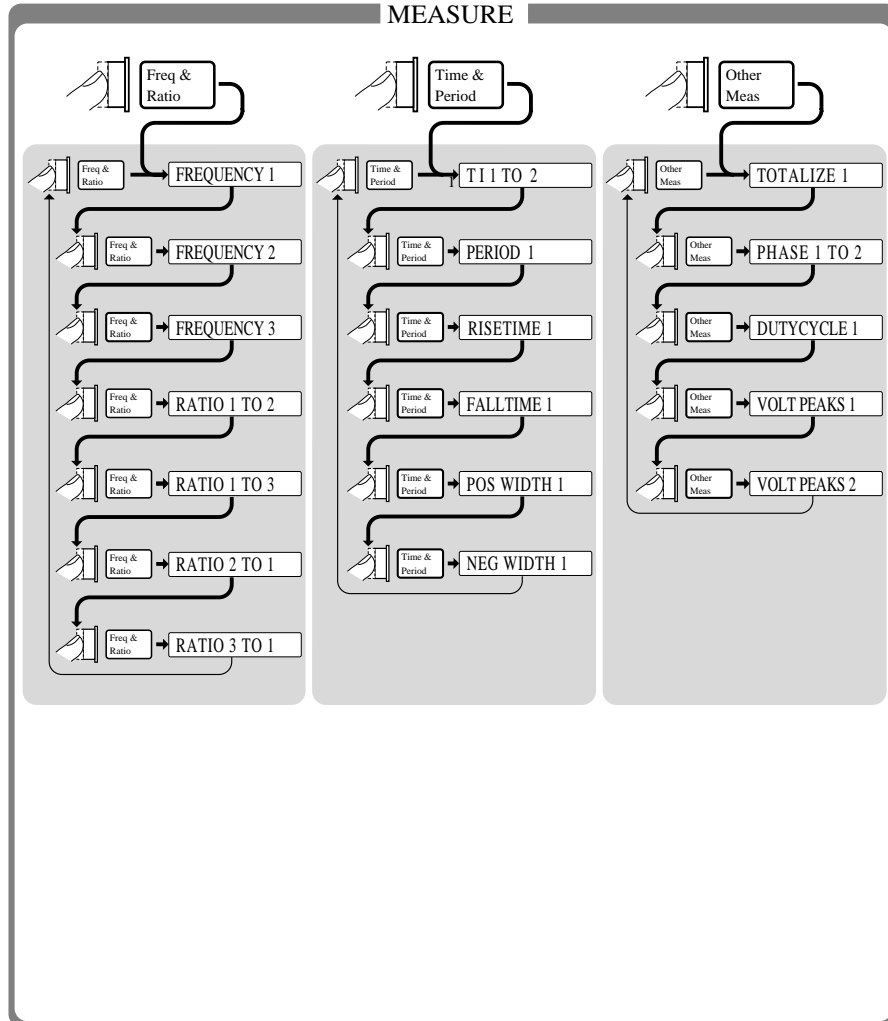
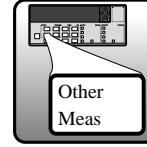
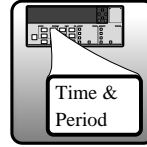
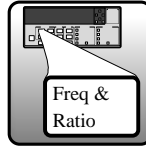

(Agilent 53131A and Agilent 53132A)

Agilent 53131A/132A Universal Counter

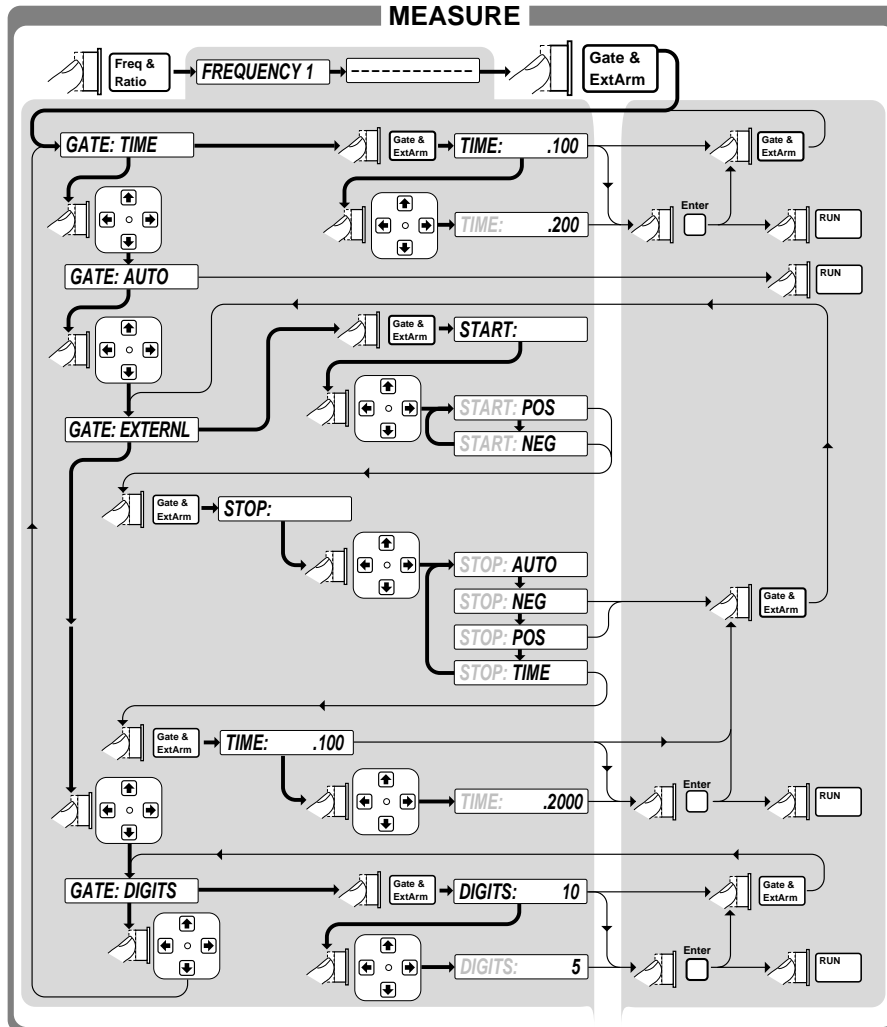
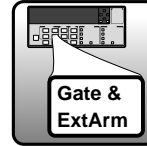

(Agilent 53131A and Agilent 53132A)

**Agilent 53131A and
Agilent 53132A (Serial Number Prefix below 3646)
Universal Counter**

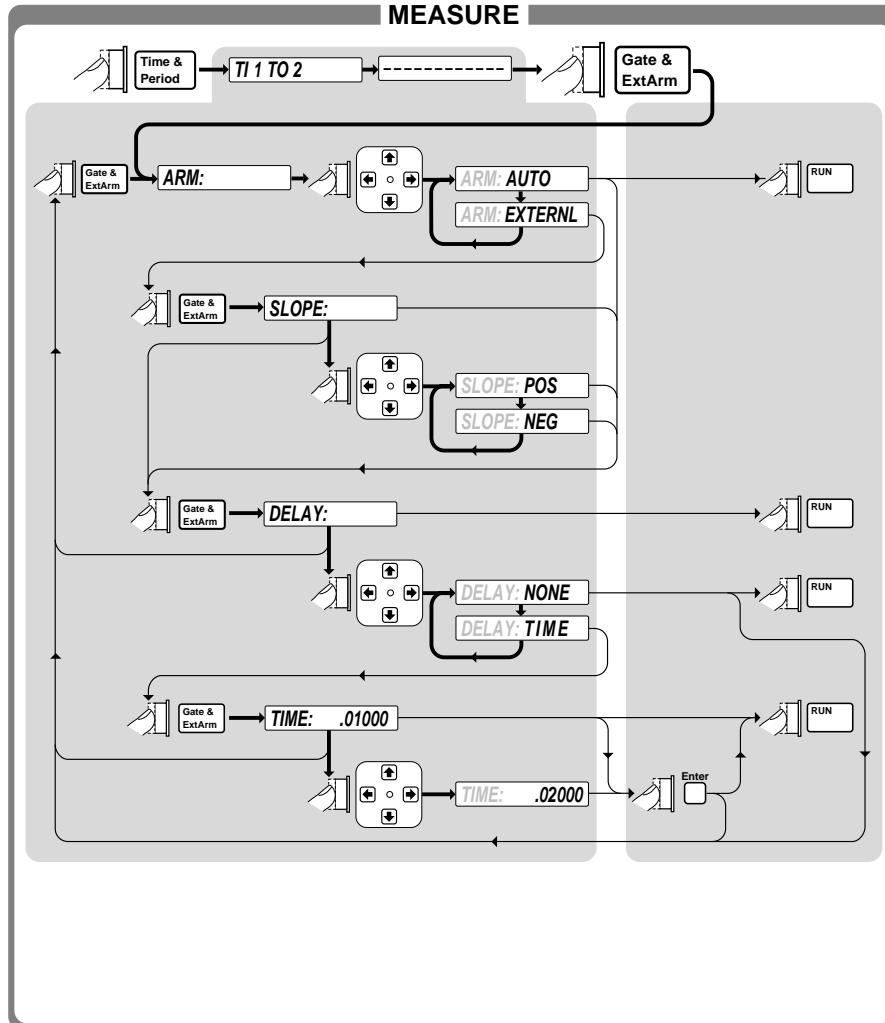
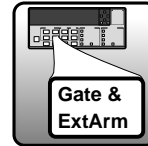

Agilent 53132A (Serial Number Prefix 3646 and above)
Universal Counter

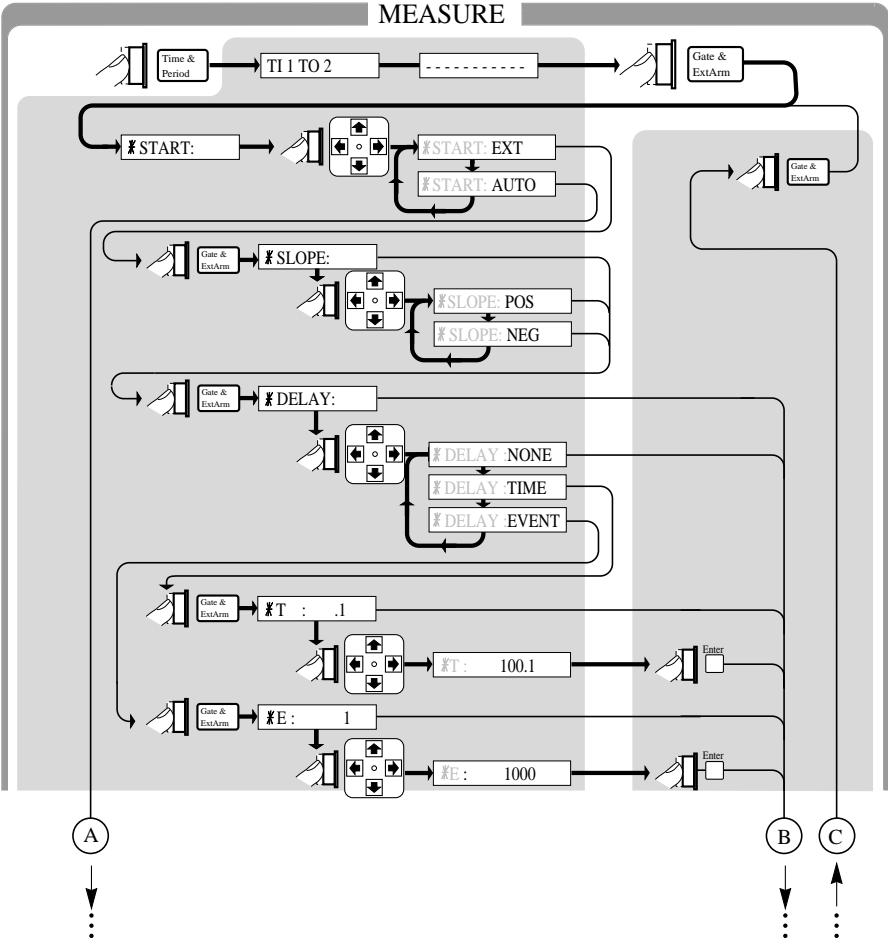
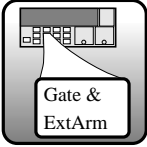

(Agilent 53132A S/N 3646 and above)
 6b

Agilent 53132A (Serial Number Prefix 3646 and above)
Universal Counter

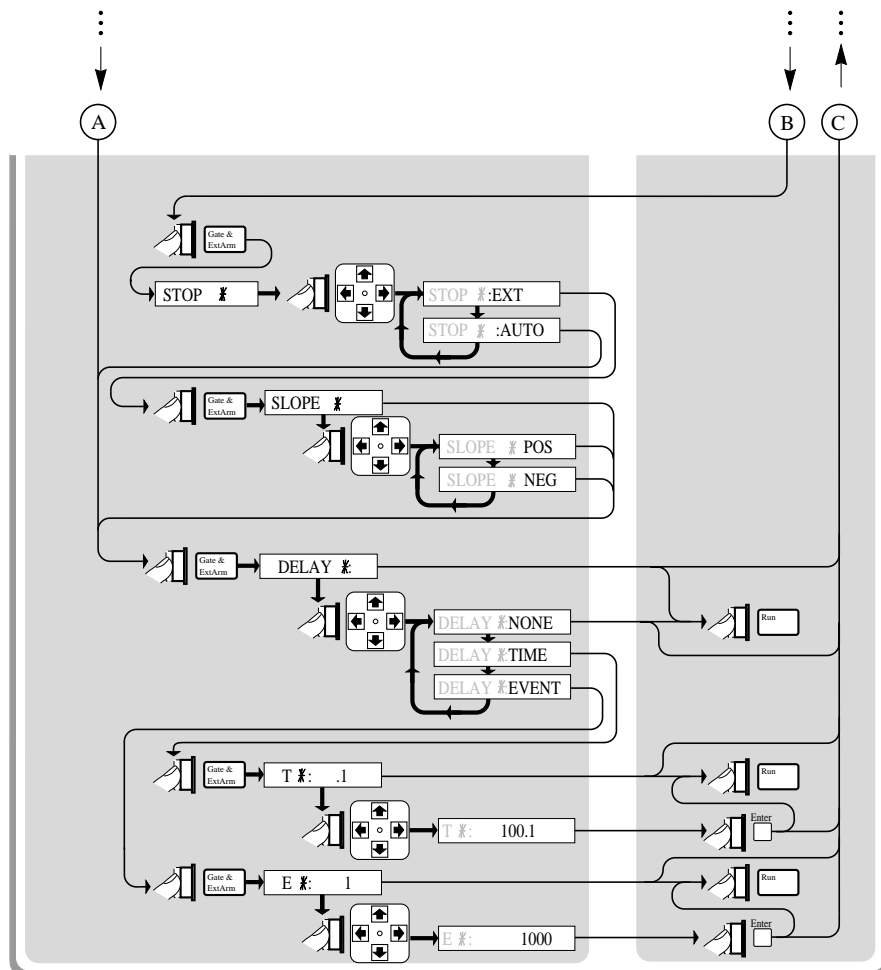
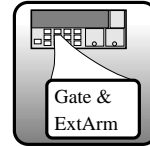

(Agilent 53132A S/N 3646 and above)

Agilent 53131A/132A Universal Counter

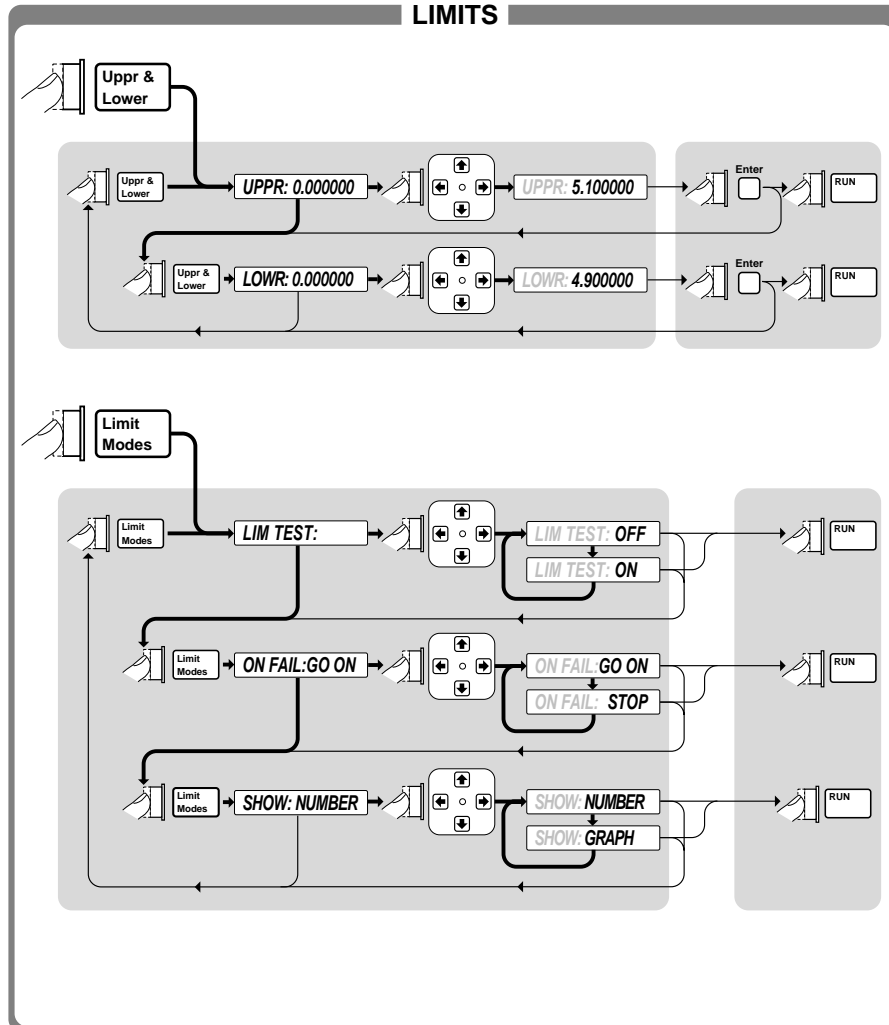
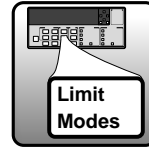
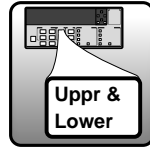

(Agilent 53131A and Agilent 53132A)

Agilent 53131A/132A Universal Counter

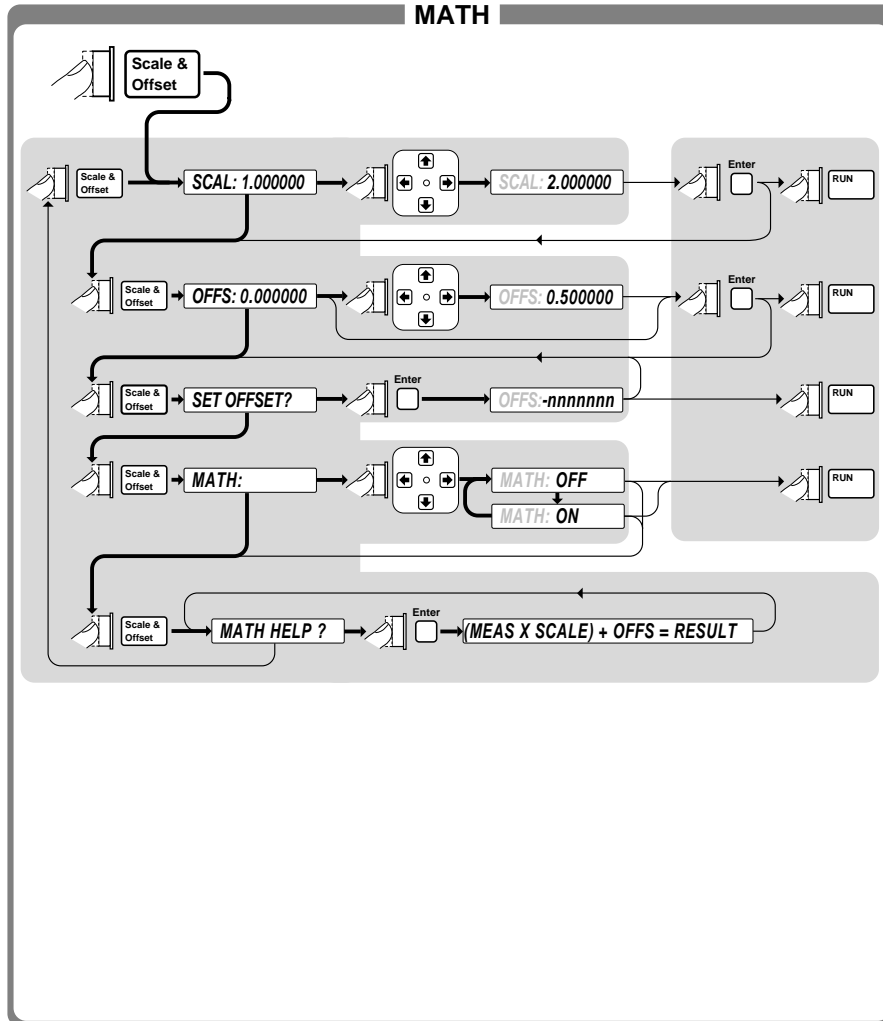

(Agilent 53131A and Agilent 53132A)

Agilent 53131A/132A Universal Counter

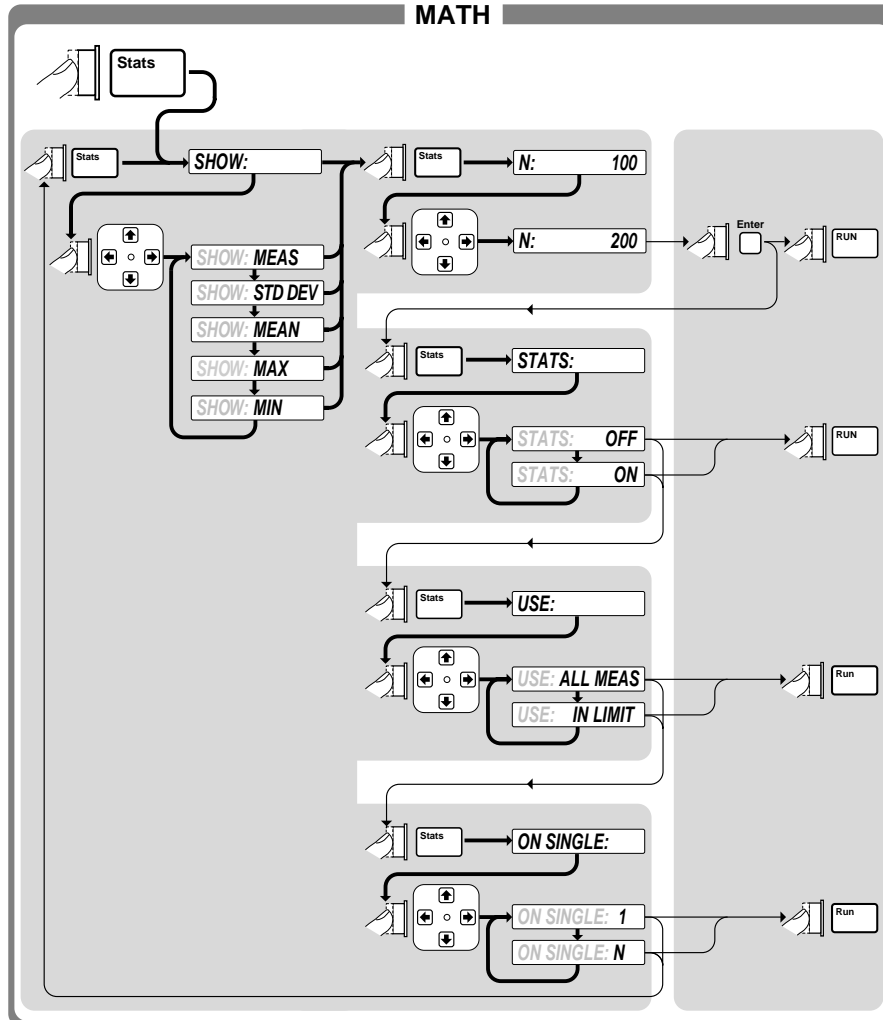

(Agilent 53131A and Agilent 53132A)

Agilent 53131A/132A Universal Counter

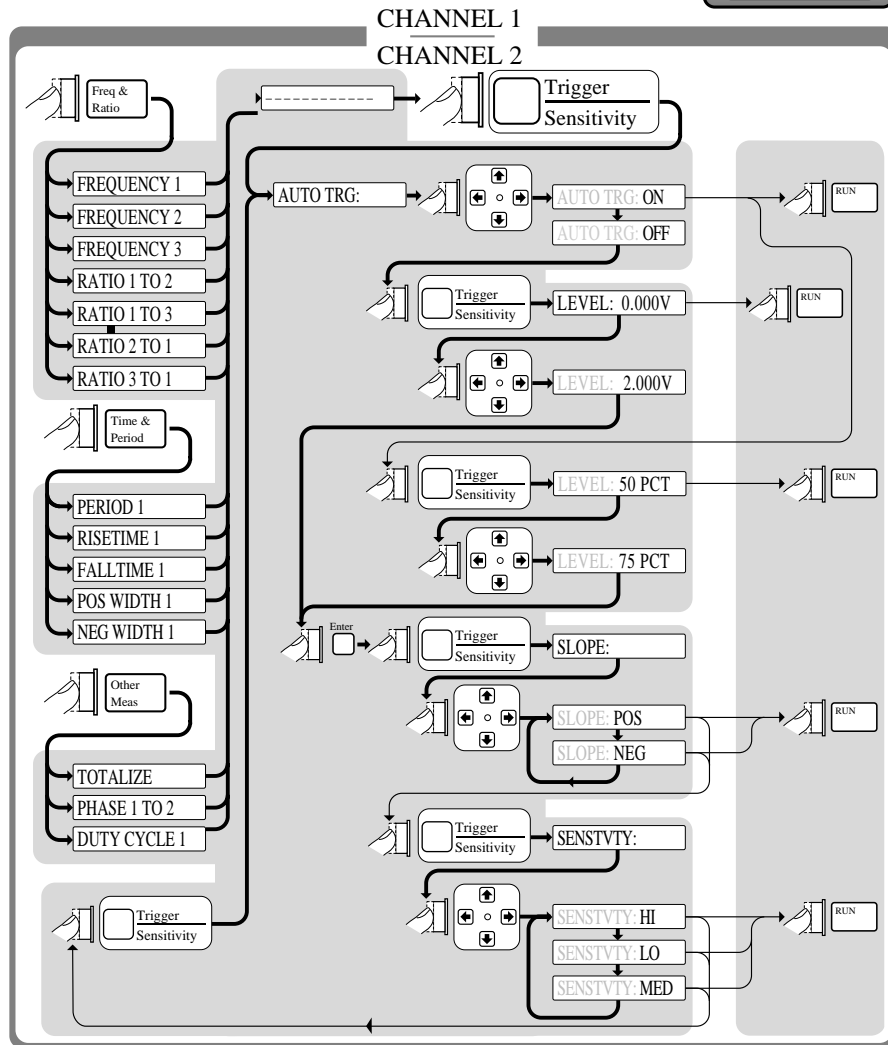
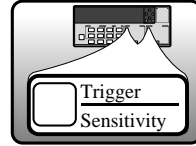

(Agilent 53131A and Agilent 53132A)

Agilent 53131A/132A Universal Counter

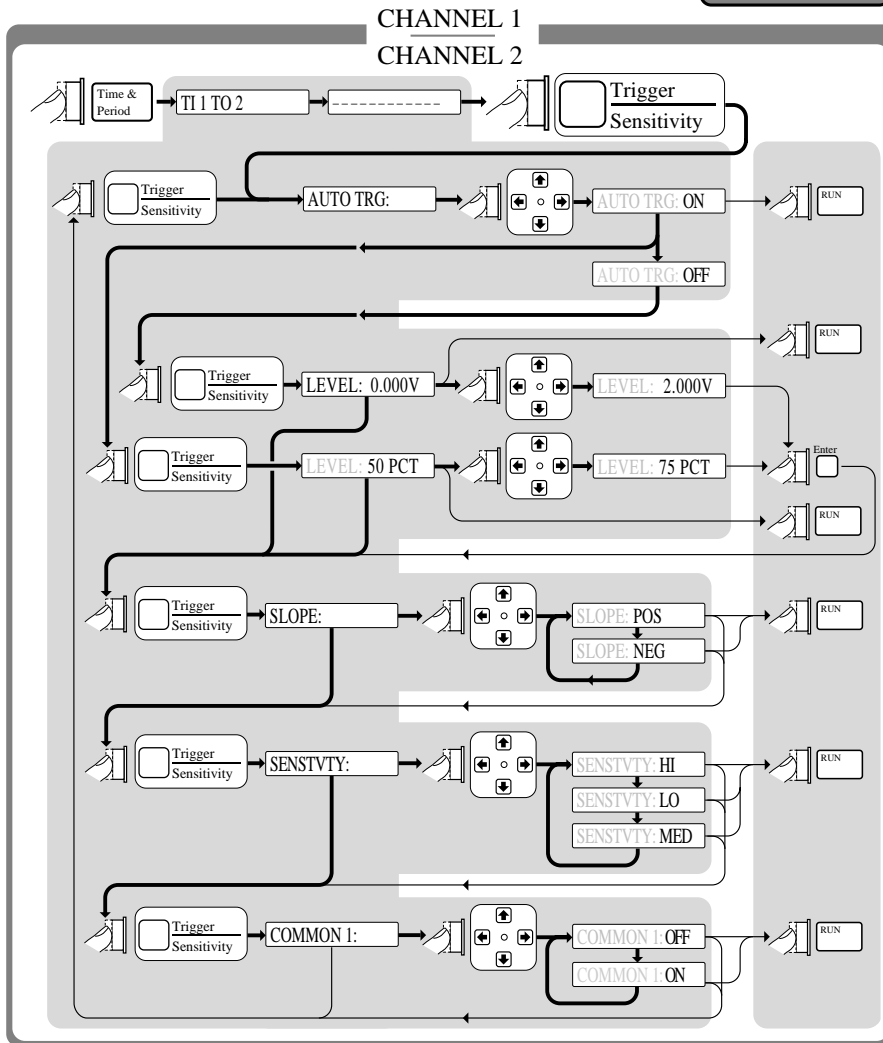
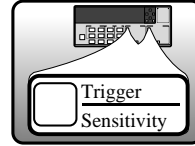

(Agilent 53131A and Agilent 53132A)

1

Getting Started

Chapter 1 Getting Started
The Front Panel at a Glance

The Front Panel at a Glance

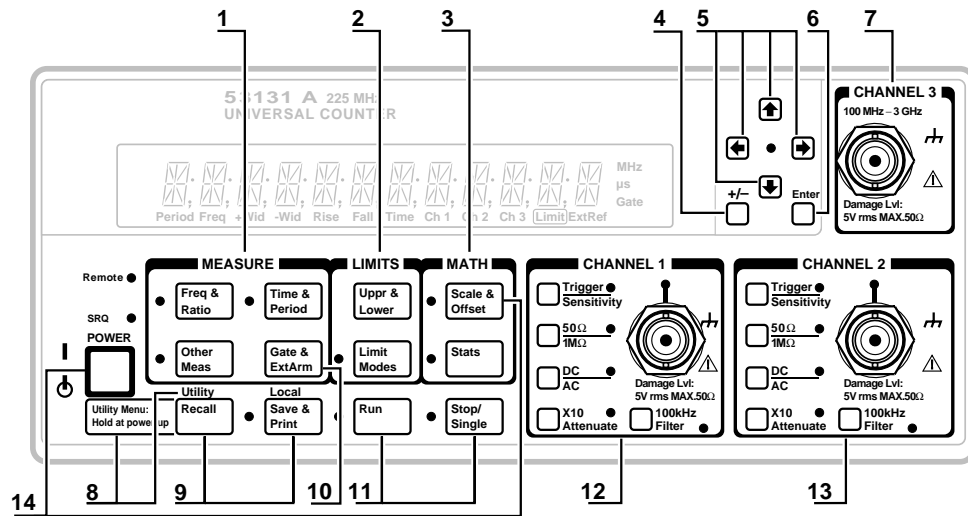

Note: Unit shown with Option 030.





- | | |
|---|--|
| <ul style="list-style-type: none"> 1 Measurement function menu keys 2 Limits menu keys 3 Math menu keys 4 Sign (+ or -) selection toggle key 5 Data Entry/Select (or arrow) keys 6 Enter numeric data (terminate) key 7 3.0/5.0/12.4 GHz RF input channel (optional) 8 Utility menu key (Hold during power-up to access Utility functions.) | <ul style="list-style-type: none"> 9 Recall, Save and Print menu keys 10 Gate and External Arm menu key 11 Measurement control keys 12 Channel 1 Trigger/Sensitivity menu key and input conditioning keys 13 Channel 2 Trigger/Sensitivity menu key and input conditioning keys 14 Calibration menu key (Hold Scale & Offset key during power-up to access Calibration functions.) |
|---|--|

NOTE

It is normal operation for the fan in the Counter to continue to run after the Counter is placed in Standby mode. Power to the timebase is continuous to maintain long term measurement reliability, and the fan helps maintain timebase temperature stability.

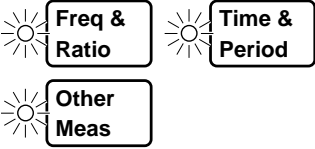
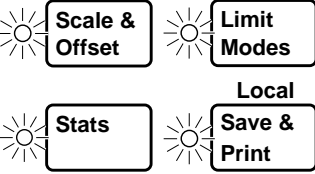
The Front Panel Indicators at a Glance

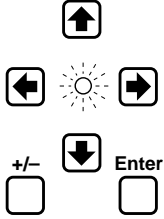
There are eight different groups of indicators or LEDs. They are listed and described in the following table.

Indicators	Description of the Indicators
 <p>Three indicator boxes: 'Freq & Ratio', 'Time & Period', and 'Other Meas'. Each box has a sun-like LED icon to its left.</p>	<p>When one of these indicators is lit, it simultaneously indicates which key's menu (for example, Time & Period key) and its menu item (for example, TI 1 to 2) is enabled.</p>
 <p>Four indicator boxes: 'Scale & Offset', 'Limit Modes', 'Stats', and 'Local Save & Print'. Each box has a sun-like LED icon to its left.</p>	<p>When these indicators are lit, the key's "enable" menu item (that is, Limit Modes/LIM TEST, Scale & Offset/MATH, Stats/STATS, and Save & Print/PRINT) is enabled.</p>
 <p>A single indicator box labeled 'Trigger Sensitivity' with a sun-like LED icon to its right.</p>	<p>When this indicator is lit, it indicates that you are in the Trigger/Sensitivity menu for the corresponding channel.</p>
 <p>A collection of icons: an upward arrow, a left arrow, a right arrow, a downward arrow, a +/- symbol, and an Enter key. A sun-like LED icon is positioned between the left and right arrows.</p>	<p>When this indicator flashes, it indicates that the arrow keys can be used to modify or enter data.</p>
 <p>Two indicator boxes: 'Run' and 'Stop/Single'. Each box has a sun-like LED icon to its left.</p>	<p>When one of these indicators is lit, it indicates that the Run or Single function is enabled.</p>

The Front Panel Menus at a Glance

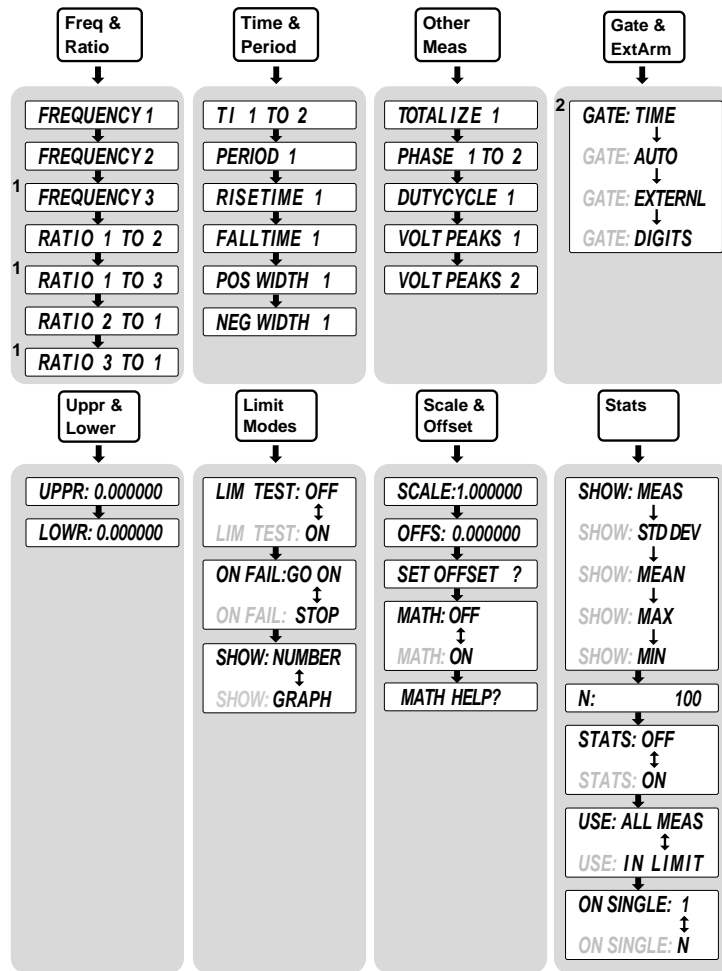

¹ These menu items appear only if your Counter contains the optional Input Channel.

² Refer to the Menu Tree in the Quick Reference Guide (which precedes this chapter) and/or the Gate/External Arming table in Chapter 2 for details on the Gate & ExtArm menu.

The Front Panel Menus at a Glance (Cont.)

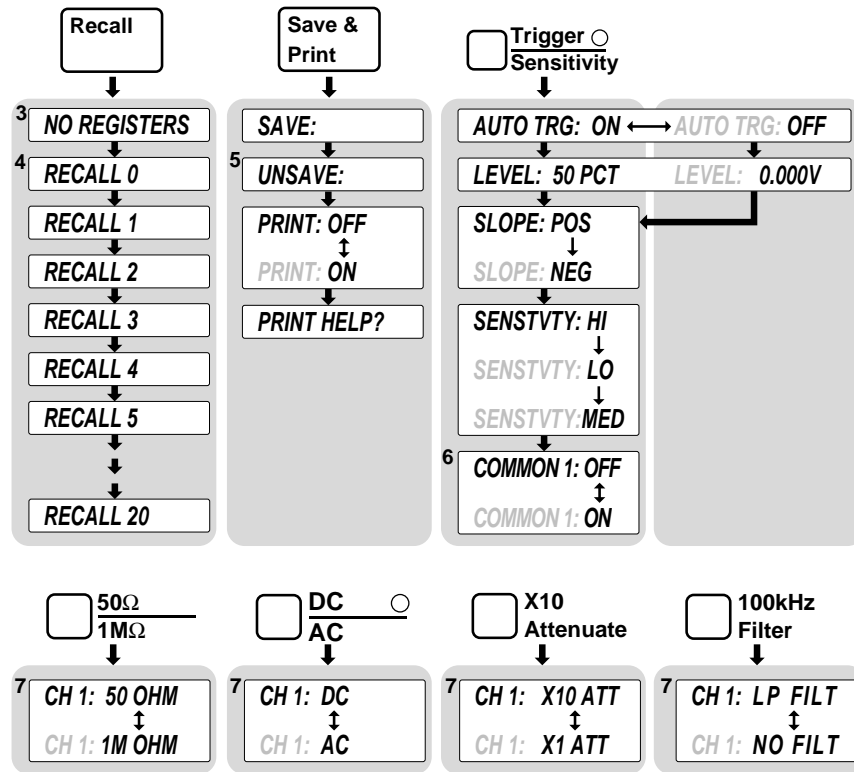

- ³ This appears when nothing can be recalled.
- ⁴ Only registers which can be recalled will appear in this menu.
- ⁵ This menu item only appears if an instrument setup has been saved.
- ⁶ COMMON 1 only appears when the Counter is operating in the Time Interval measurement function (T1 1 TO 2).
- ⁷ Channel 2 is the same, except "CH 2" instead of "CH 1" is displayed. These menus will terminate after two seconds.

The Front Panel Menus at a Glance (Cont.)

NOTE

Turn power off, press and hold Recall (**Utility**) key, then press **POWER** key to access this menu.

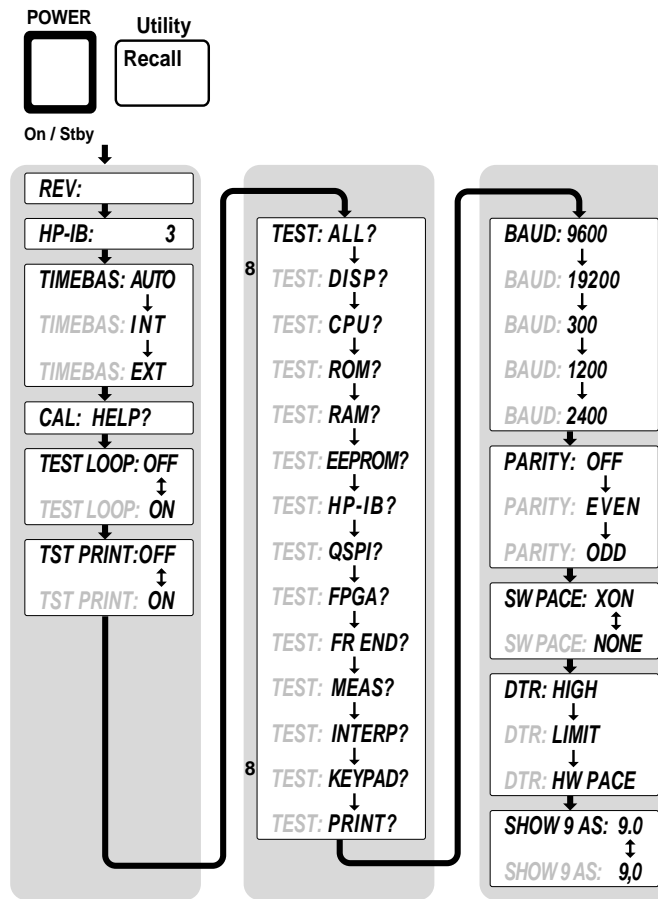

The Front Panel Menus at a Glance (Cont.)

1

NOTE

Turn power off, press and hold **Scale & Offset** key, then press **POWER** key to access this menu. (This menu does not exist in early versions of the Counter. In the early versions of the Counter, the CAL: menu item resides in the Utility menu, and there is no calibration security capability.)

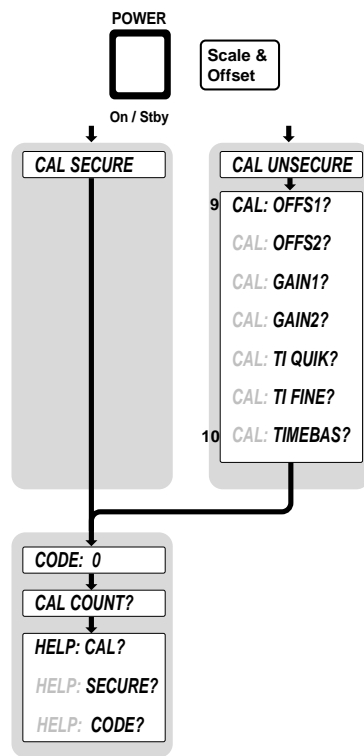

⁹ This menu item appears and calibration is permitted only if calibration is unsecure. Enter in the correct code to change calibration to secure; refer to the section titled "Using the Calibration Menu" in Chapter 2 in this guide for more information.

¹⁰ Timebase can be automatically calibrated only if the timebase option is installed.

The Display Annunciators at a Glance

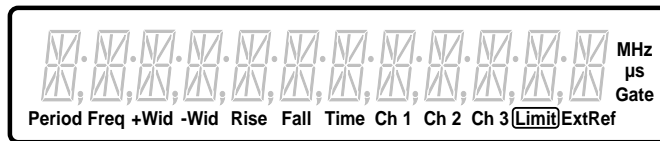

Annunciator	Indication
Period	Counter is set to measure Period.
Freq	Counter is set to measure Frequency.
+Wid	Counter is set to measure Positive Pulse Width.
-Wid	Counter is set to measure Negative Pulse Width.
Rise	Counter is set to measure Rise Time. (The Time annunciator is also turned on when the Rise annunciator is on.)
Fall	Counter is set to measure Fall Time. (The Time annunciator is also turned on when Fall annunciator is on.)
Time	Counter is set to measure Time Interval. (The Time annunciator is also turned on when the Rise or Fall annunciator are on.)
Ch 1	Counter's channel 1 is selected to measure an input signal.
Ch 2	Counter's channel 2 is selected to measure an input signal.
Ch 3	Counter's channel 3 is selected to measure an input signal.
Limit	Counter is limit testing and the current measurement exceeds the user-entered limits.
ExtRef	Counter is set to use the signal connected at rear panel Ref In connector as the timebase (TIMEBAS: EXT); or Counter is set to automatically (TIMEBAS: AUTO) select the timebase and has chosen the signal connected at the rear panel Ref In connector.
Hz	The displayed data is in units of Hertz.
M	The prefix for the units of the displayed data is mega (10^6).
μ	The prefix for the units of the displayed data is micro (10^{-6}).
s	The displayed data is in units of seconds.
Gate	The gate is open. Before a measurement starts, this annunciator is OFF, indicating the gate is closed. During a measurement, the annunciator is ON, indicating the gate is open.

The Display Special Character at a Glance

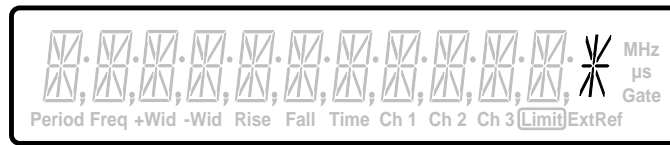

Special Character	Description
*	A placeholder that indicates this digit is not significant.

The Limit Test Graph Characters at a Glance

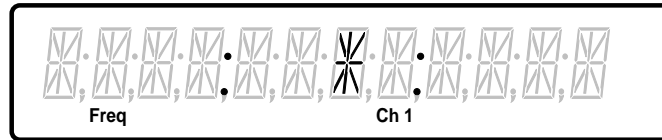

Special Character	Description
.	The colons represent the lower and upper limits.
*	The asterisk represents the last measurement.
/ or \	These marks indicate that the last measurement was significantly past the limit in the direction indicated.

The Rear Panel at a Glance

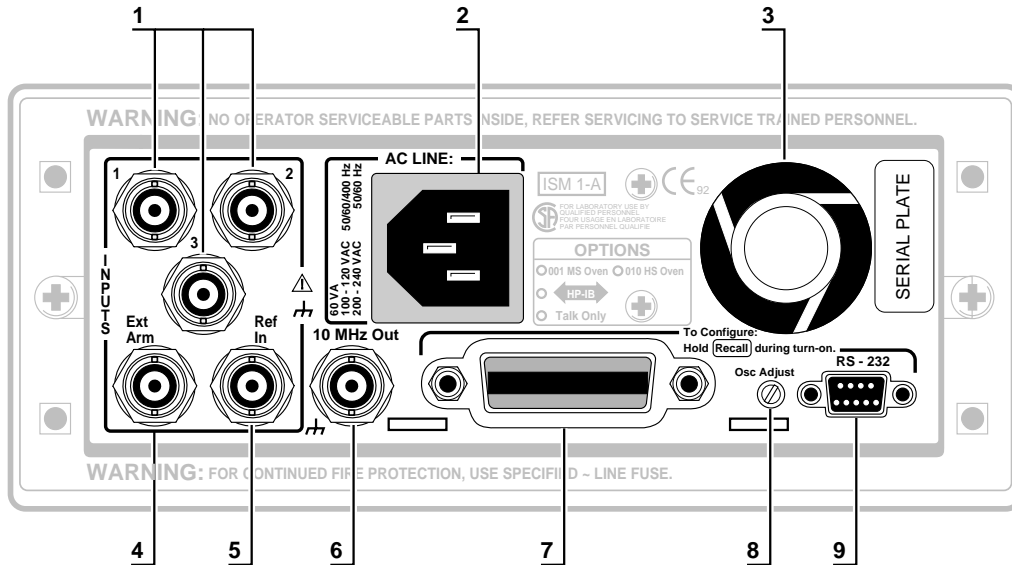

- | | |
|--|--|
| <ul style="list-style-type: none"> 1 Rear-panel input connectors (optional) 2 Power module (Senses incoming voltage and automatically selects proper setup.) 3 Fan 4 External Arm input connector 5 External Reference Input connector | <ul style="list-style-type: none"> 6 10 MHz Output connector 7 GPIB (IEEE-488.1) interface connector 8 Oscillator Adjust potentiometer (This potentiometer is not present for options 001, 010, and 012.) 9 RS-232 interface or Limit Output connector |
|--|--|

NOTE

It is normal operation for the fan in the Counter to continue to run after the Counter is placed in Standby mode. Power to the timebase is continuous to maintain long term measurement reliability, and the fan helps maintain timebase temperature stability.

Making Measurements

One of the first things you will want to do with your Agilent 53131A/132A Universal Counter is to become acquainted with its front panel. Therefore, we have written the procedures in this section to familiarize you with some of its controls. The following procedures are provided:

- First you are shown how to turn on the Counter and measure the frequency of a signal applied to the Counter's input channels.
- Second, you are shown how to use the input coupling, impedance, and trigger/sensitivity keys to set the input conditions of the appropriate input channel to match the signal being measured.
- Third, you are shown how to scale and offset the measurement result.
- Fourth, you are shown how to set upper and lower limits for measurements.
- Fifth, you are shown how to enable the Counter to compute statistics (such as standard deviation) and display statistics of measurements.
- Last, you are shown how to use the Run and Stop/Single keys to control measurements.

The order of the procedures in this chapter is the recommended order for making measurements with this Counter.

Study and refer to the following legend, as needed, to understand the meaning of the icons which are used throughout this chapter.

Chapter 1 Getting Started
Making Measurements

Legend

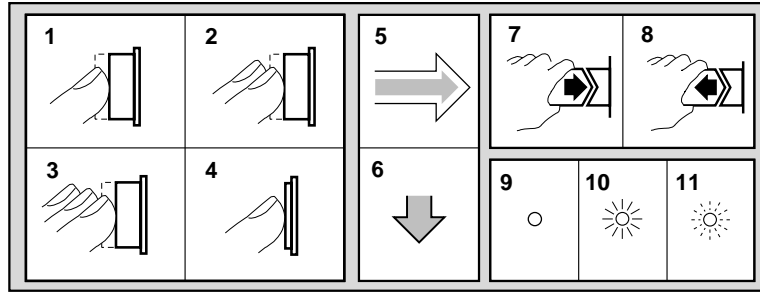

- | | | |
|--|-------------------------|------------------------------|
| 1 Press key one time and release | 4 Press and hold | 8 Disconnect signal |
| 2 Press key two times and release | 5 Result | 9 Indicator off |
| 3 Repeated key presses | 6 Auto operation | 10 Indicator on |
| | 7 Connect signal | 11 Indicator flashing |

To Measure Frequency

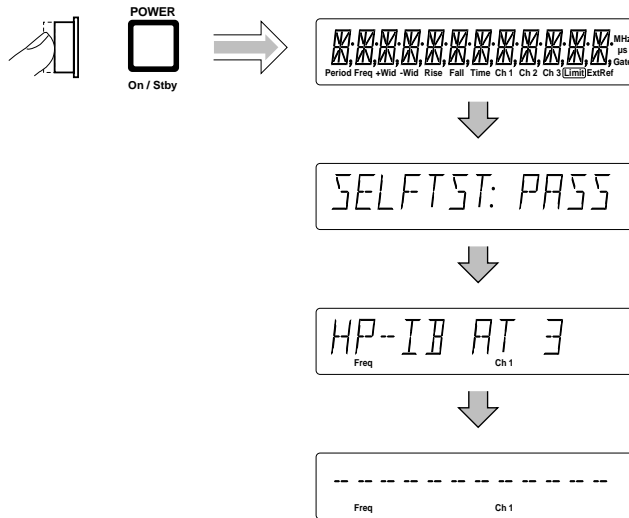

Chapter 1 Getting Started

Making Measurements

NOTE

Earlier versions of the Counter do not momentarily display the GPIB address at turn-on.

Connect (for demonstration purposes) the Counter's rear-panel **10 MHz Out** signal to CHANNEL 1 input as shown in the illustrated procedure, below.

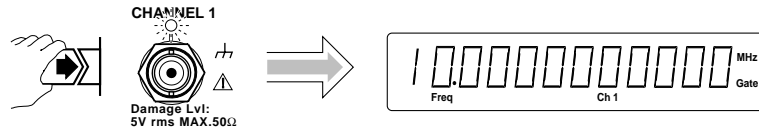

The Counter will automatically display the measured frequency of the input signal.

Disconnect the demonstration signal from CHANNEL 1, and connect it to CHANNEL 2 as shown in the following steps.

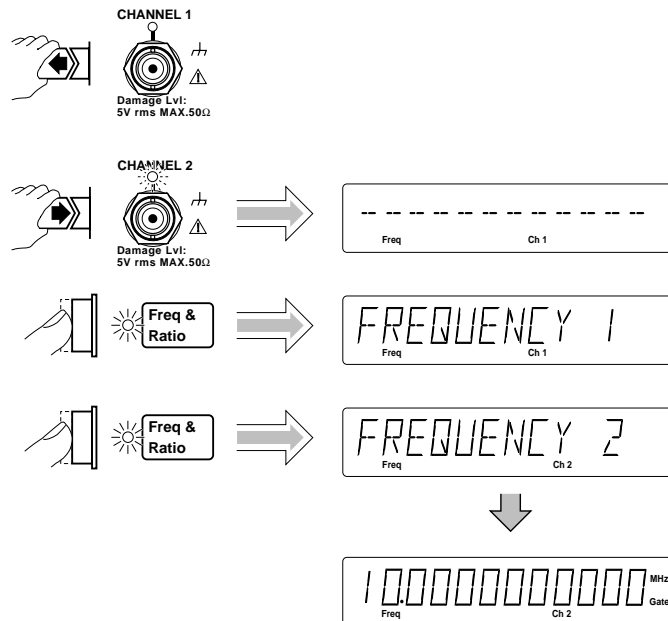
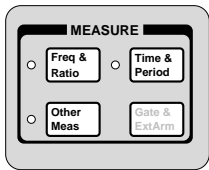

Chapter 1 Getting Started

Making Measurements

Again, the Counter will automatically display the measured frequency of the input signal.

If you need or want to change CHANNEL 2's coupling, impedance, and triggering conditions to match the input signal you are trying to measure, the next procedures "To Select Input Coupling and Impedance" and "To Set Input Channel Trigger Level/Sensitivity" demonstrate this. Perform these procedures whether or not you want to customize the Counter's input conditions to measure your signal; doing this will help you become familiar with the **DC/AC**, **50Ω/1MΩ**, and **Trigger/Sensitivity** keys.

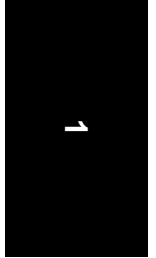

To Select Input Coupling and Impedance

Remember, the input signal is still connected to CHANNEL 2.

Selecting Input Coupling

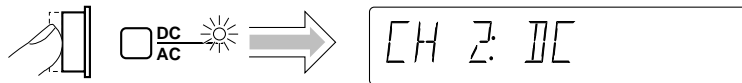
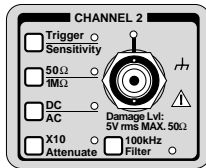

Channel 2's input coupling is now set to dc.

If you want to change the coupling back to the default ac coupling, perform the following step.

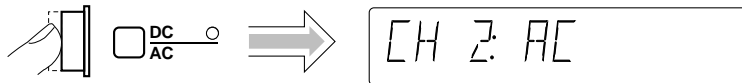

Chapter 1 Getting Started
Making Measurements

Selecting Input Impedance

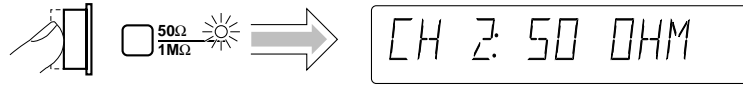

Channel 2's input impedance is now set to 50Ω

NOTE

The “arrow” keys can also be used to toggle the state of toggle keys (DC/AC, 50Ω/1MΩ etc.) as indicated by the flashing indicator within the arrow keys. However, for simplicity in this procedure, use the corresponding toggle key to change states.

If you want to change the input impedance back to the default 1 MΩ impedance, perform the following step.

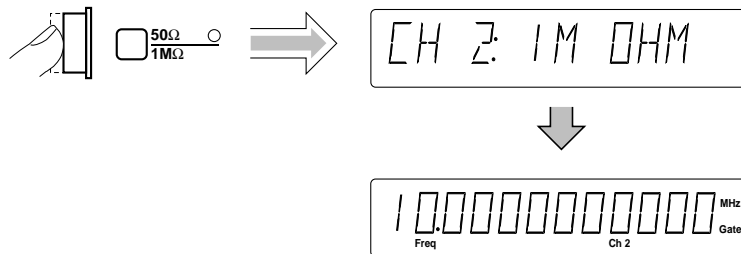

Chapter 1 Getting Started
Making Measurements

To Set Input Channel Trigger Level/Sensitivity

Changing Trigger Mode

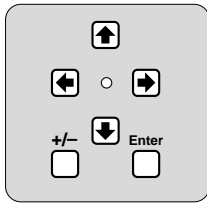
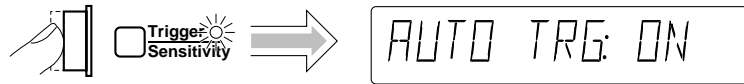

Press any one of these arrow keys to toggle to the next state of Auto Trigger.

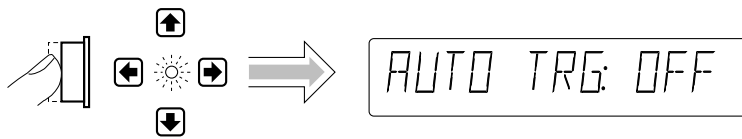

Modifying Input Trigger Level



The leftmost “0” digit in the LEVEL display is highlighted, indicating that if you press the d key once the displayed value will increase to 1.000 volt as shown in the following step.



NOTE

BE SURE to always press the Enter key to complete numeric data entries.

Channel 2's trigger level is now set to +1V.

Chapter 1 Getting Started
Making Measurements

To set the trigger level to -0.05V , perform the following steps.

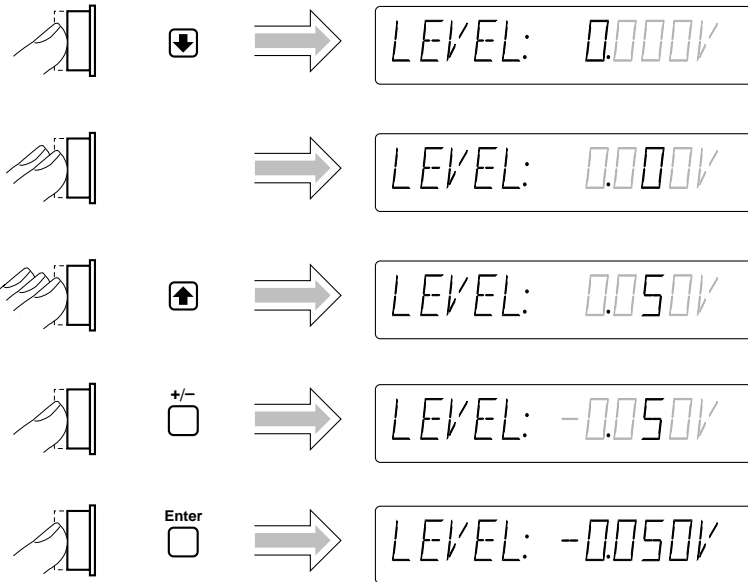

NOTE

BE SURE to always press the Enter key to complete numeric data entries.

Channel 2's trigger level is now set to -0.05V .

Selecting Input Trigger Slope

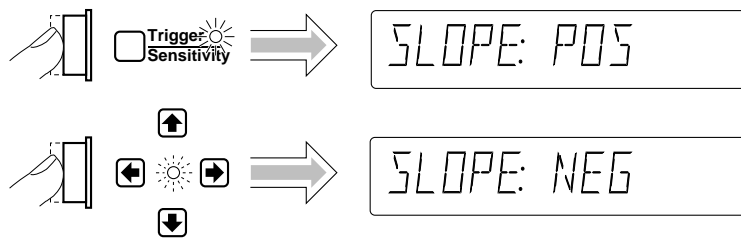

Chapter 1 Getting Started
Making Measurements

Selecting Input Sensitivity

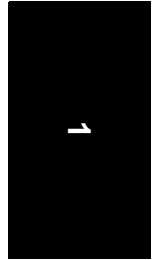
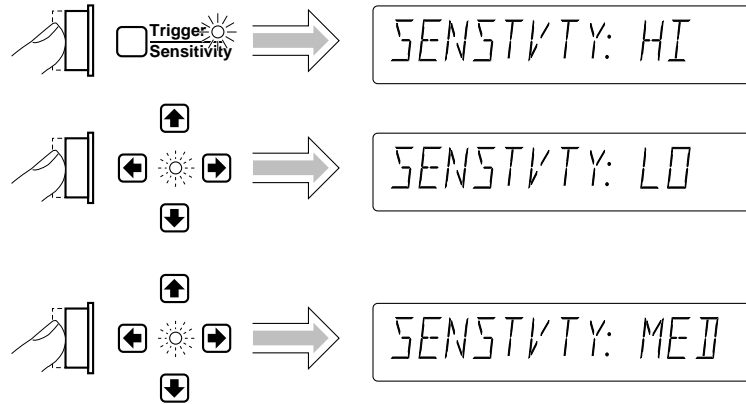

Starting the Measurement

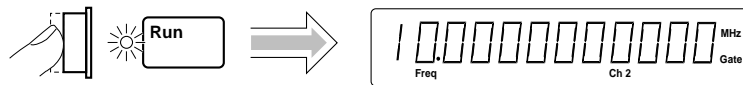

The **Run** key initiates repetitive measurements, and is described in the section titled “To Control Measurement” at the end of this chapter.

To Select Scale and Offset

The **Scale & Offset** key allows for multiplication and addition, respectively, of the measurement by user-specified constants. Modification of the displayed measurement by these Math operations is represented by the following equation:

$$(\text{Measurement} \times \text{Scale}) + \text{Offset} = \text{Displayed Results}$$

The Scale and Offset Math operations can be used, for example, to subtract systematic errors or display the percentage difference between signals.

Chapter 1 Getting Started
Making Measurements

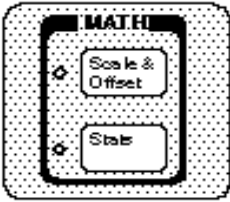
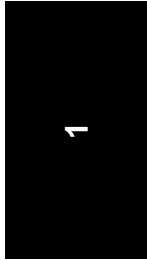

Entering the Scale Value

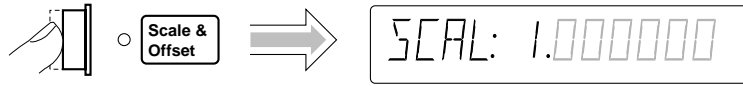

To demonstrate the Scale Math operation, set Scale to 10 as shown in the following steps.



Press and hold the d key until the value of Scale is 10 as shown in the following step.

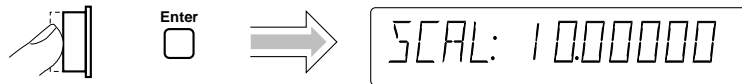
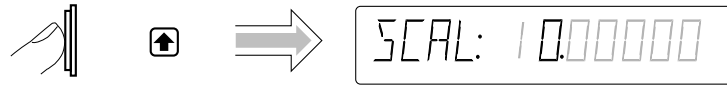

NOTE

BE SURE to press the Enter key to enter the value of 10.

The Scale is now set to 10, and MATH has been enabled. The Scale & Offset indicator is now lit to show that MATH is enabled. Since MATH is enabled, the results are being scaled and offset.

Chapter 1 Getting Started
Making Measurements

Entering the Offset Value

To demonstrate the Offset Math operation, set the Offset to 1 MHz as shown in the following steps.

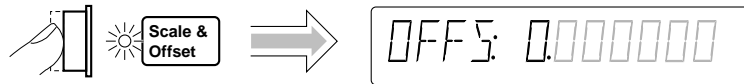

At this point, pressing the \leftarrow key will cause the Counter to display the full display of the Offset value as shown in the following step.

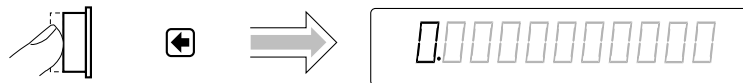

Press the \leftarrow key six more times to cause the Counter to display your entry in Mega units as shown in the following step.

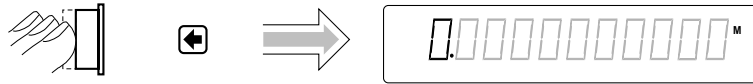

The leftmost "0" digit in the OFFSet display is highlighted, indicating that if you press \uparrow key once the displayed value will increase to 1 Mega (that is, 1E6) as shown in the following step.

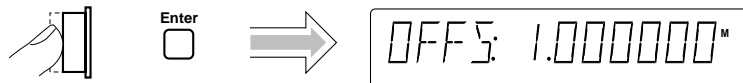
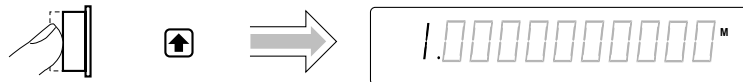

NOTE

BE SURE to press the Enter key to enter the 1 Mega value.

The Offset is now set to 1 Mega.

Chapter 1 Getting Started
Making Measurements

Displaying the Math Results

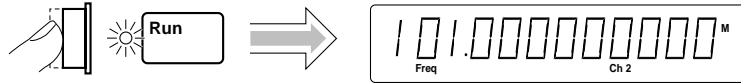

The Counter displays the modified measurement results, which are based on the scale and offset values that you selected in the previous steps. That is, the 101 represents the original 10, scale multiplied by 10, then offset by 1.

(For more details and real applications of the Math Scale and Offset operations, refer to the appropriate section in Chapter 2, “Operating Your Universal Counter.”)

Disabling Math

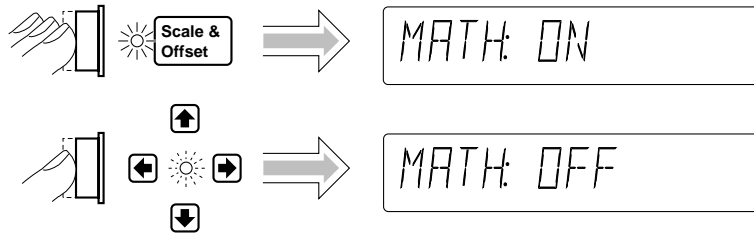

Note that the **Scale & Offset** key indicator is now off.



NOTE

DO NOT cycle **POWER** because you will need to use these Scale and Offset values in the following procedure “To Set Limits of Measurements.” Continue to the following procedure.

Chapter 1 Getting Started
Making Measurements

To Set Limits of Measurements

To demonstrate how Math and Limits work together, use the Scale (10) and Offset (1 Mega) values selected in the previous procedure “To Select Scale and Offset.” Enable Math by performing the following steps.

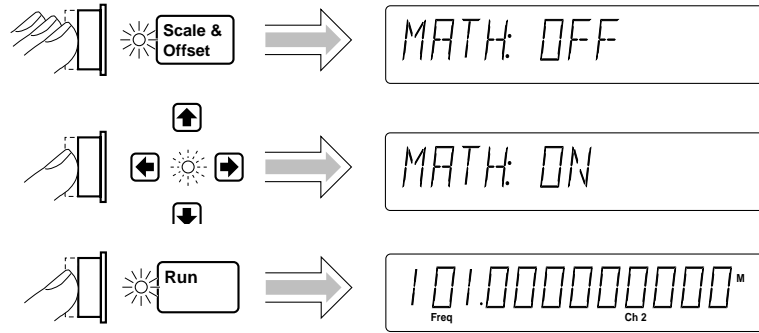
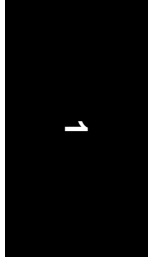

The result of this Math operation is a measurement of 101 MHz.

$$(\text{Measurement} \times \text{Scale}) + \text{Offset} = \text{Result}$$

$$(10 \text{ MHz} \times 10) + 1\text{Mega} = 101 \text{ Mega}$$

Now, set the upper limit to 102 Mega and the lower limit to 100 Mega by performing the following procedures. (Figure 1-1 and Figure 1-2 illustrate the limits settings.)

Chapter 1 Getting Started
Making Measurements

Setting the Upper Limit

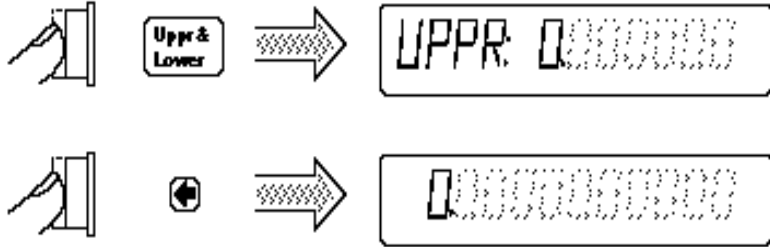
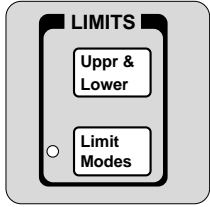
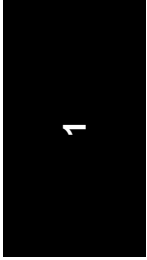

Press the s key six more times to cause the Counter to display your entry in Mega units as shown in the following step.

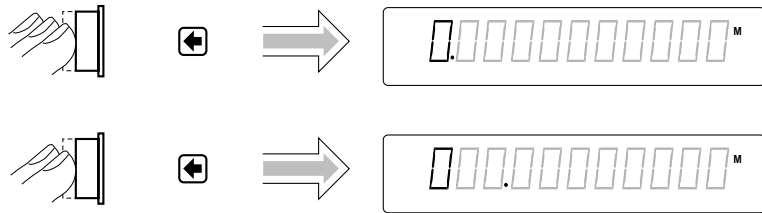

The leftmost “0” digit in the UPPR display is highlighted as shown above, indicating that each press of the d key will increase the displayed value.

Chapter 1 Getting Started
Making Measurements

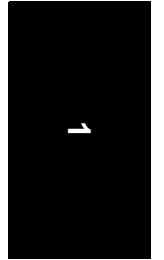
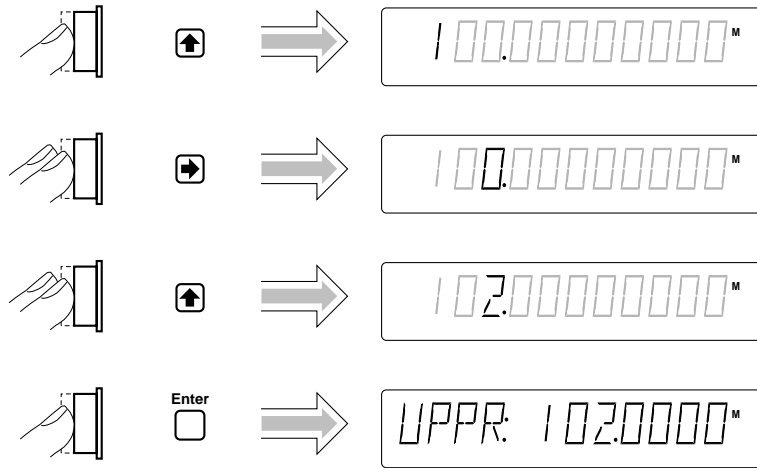

NOTE

BE SURE to press the Enter key to enter the 102 Mega value.

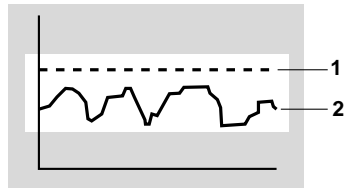

- 1 102 Mega Upper Limit
- 2 101 Mega Scale/Offset Measurement

Figure 1-1. 102 Mega Upper Limit Setting

Chapter 1 Getting Started
Making Measurements

Setting the Lower Limit

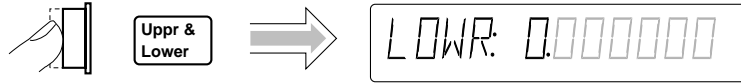

Press the arrow keys as shown in the following steps to set the lower limit value.



Press the s key six more times to cause the Counter to display your entry in Mega units as shown in the following step.

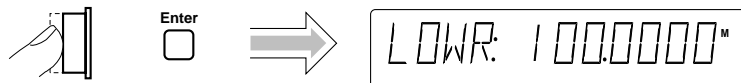
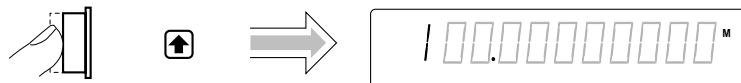

Chapter 1 Getting Started
Making Measurements

NOTE

BE SURE to press the Enter key to enter the 100 Mega value.

Limits should now be set as shown in Figure 1-2.

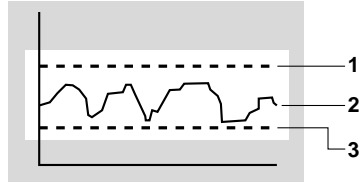

- 1 102 Mega Upper Limit
- 2 101 Mega Scale/Offset Measurement
- 3 100 Mega Lower Limit

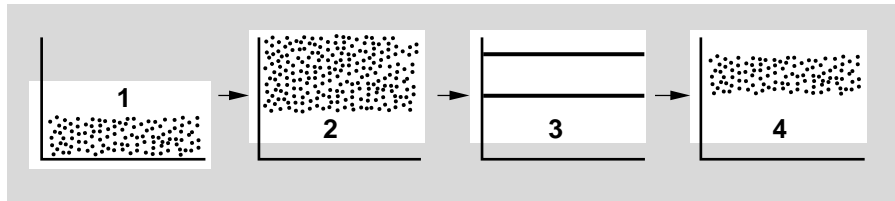

Figure 1-2. 100 Mega Lower and 102 Mega Upper Limits Settings

Figure 1-3 represents what transpired during this Math and Limits procedure.

- 1 Raw Measurements
- 2 Math
- 3 Limits
- 4 Measurements (Scale/Offset Results) within Limits

Figure 1-3. Math and Limits Results

Chapter 1 Getting Started
Making Measurements

Setting the Counter to Flag and Stop Measuring On Out-of-Limit Measurements

If you want the Counter to stop measuring when the signal exceeds the limits (102 to 100 Mega) that you entered in the previous procedure, perform the following steps to select the STOP choice in the ON FAIL display. (Note that ON FAIL: GO ON is the default state after power-up.)

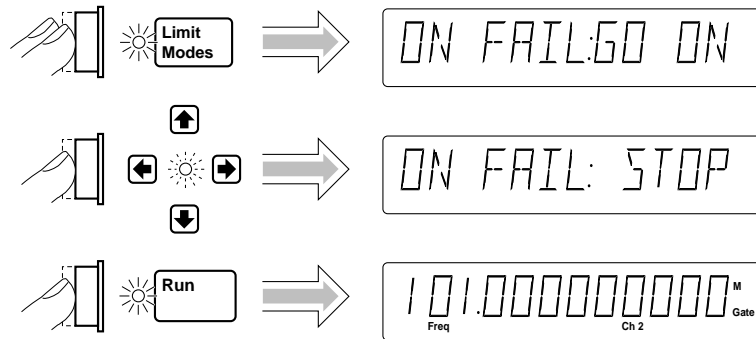

The current modified measurement of the input signal applied to CHANNEL 2 is displayed.

Since the Counter is now in the stop-on-fail mode, the **Limit** annunciator in the display will light and the Counter will stop making measurements when a measurement exceeds the limits you set.

Chapter 1 Getting Started
Making Measurements

Setting the Counter to Flag On Limits But Continue Measuring

Perform the following steps to select the GO ON choice in the ON FAIL display if you want the Counter to continue measuring even though an measurement result exceeds the limits previously entered.

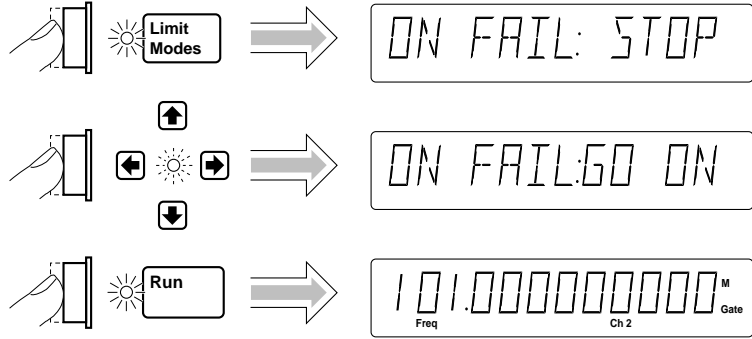
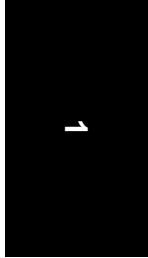

The current modified measurement of the input signal applied to CHANNEL 2 is displayed.

Since the Counter is now in the go-on-fail mode, the **Limit** annunciator in the display will light each time a measurement exceeds the limits you set. However, the Counter will continue to make measurements.

Chapter 1 Getting Started
Making Measurements

Disabling Limit Testing

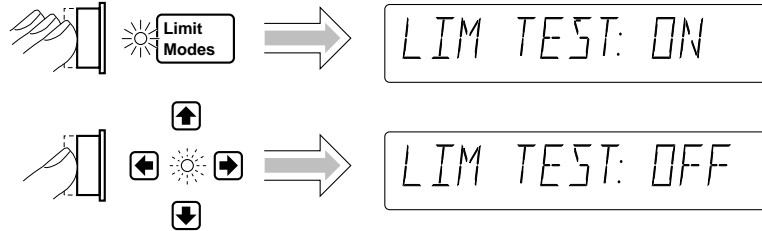

The Counter is now making measurements without limit testing.

Disabling Math

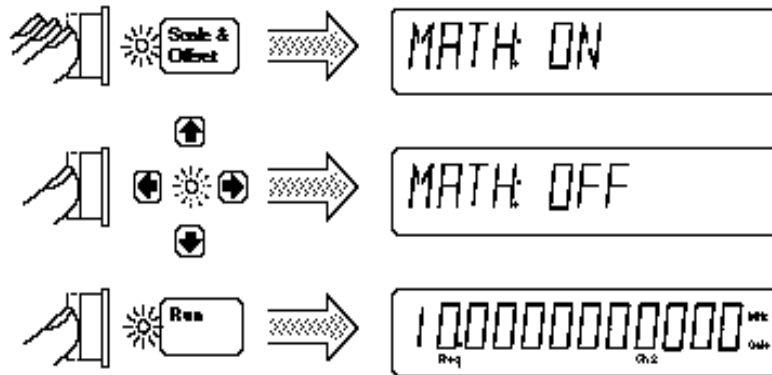

The Counter is now making measurements without the scale/offset values calculated into the measurements.

Chapter 1 Getting Started
Making Measurements

To Perform Statistics on Measurements

Selecting the Type of Statistics (Stats)

Suppose you want the Counter to compute and display the **standard deviation** of the current input data (which is the 10 MHz signal applied to CHANNEL 2). Also, you want the Counter to make 20 measurements before it computes the standard deviation. Perform the following steps.

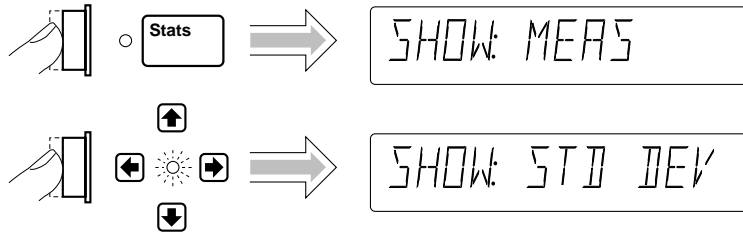
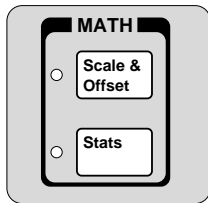

Updating the SHOW configuration caused Stats to be enabled. The Stats indicator is now lit.

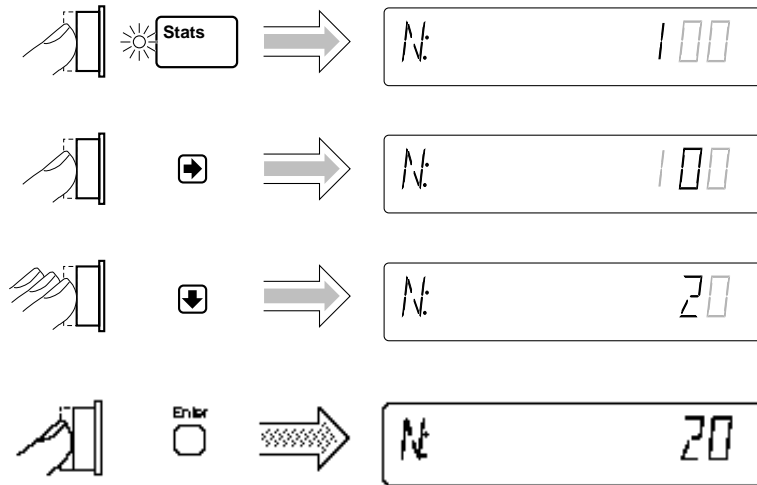

Chapter 1 Getting Started
Making Measurements

NOTE

BE SURE to press the Enter key to enter the value of 20.

The Counter is now set to make statistics based on 20 measurements.

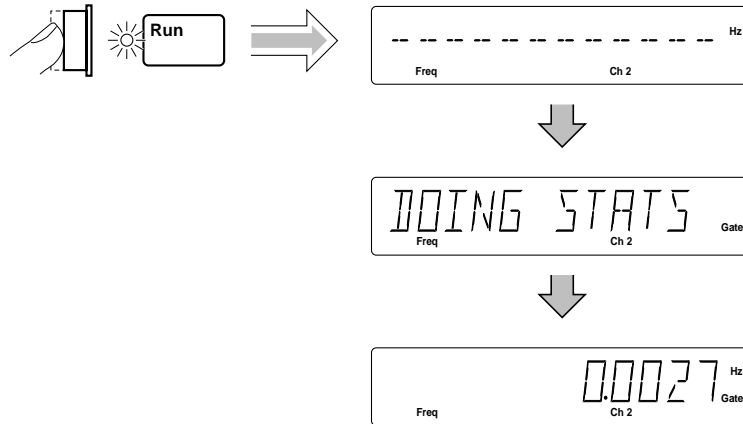

In this case, the displayed standard deviation value is computed on all measurements of the 10 MHz signal since no limits were set.

Computing Stats on Filtered Data Only

A special feature of the Counter allows you to use the upper and lower limits to filter data before statistical processing or computation as shown in Figure 1-4.



1 Raw Measurements

3 Filtered data (USE: IN LIMIT)

2 Limits

4 Statistics

Figure 1-4. Filtering Data Before Statistical Computation

Chapter 1 Getting Started
Making Measurements

Perform the following steps to select the IN LIMIT choice in the USE display if you want the Counter to compute statistics on only frequency measurements within the limits you set.

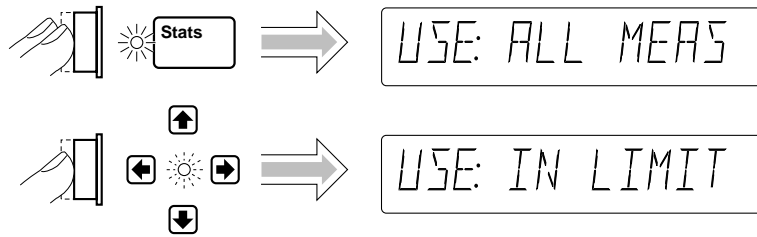
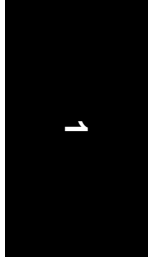

Since the Limits were set to 101 Mega and 102 Mega values that are based on a scale of 10 and offset of 1 Mega, you must re-enable Math now to get the measurements to be within the limits. Perform the following steps.

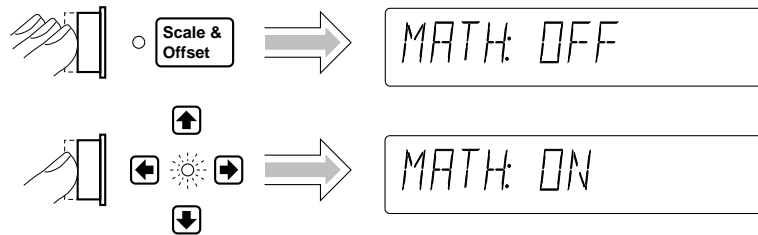

Chapter 1 Getting Started
Making Measurements

Displaying Stats After Filtering Data of Input Signal

Let's assume you have set the upper and lower limits for the input signal, and selected the IN LIMIT (filtering) choice. Now, perform the following steps to display the standard deviation of the filtered measurements. (Note that the first step in the following procedure is optional since you should have already set Stats to show standard deviation at the beginning of this Stats procedure. But, you may want to perform the step anyway to verify that the Counter is displaying the standard deviation of the measurement.)

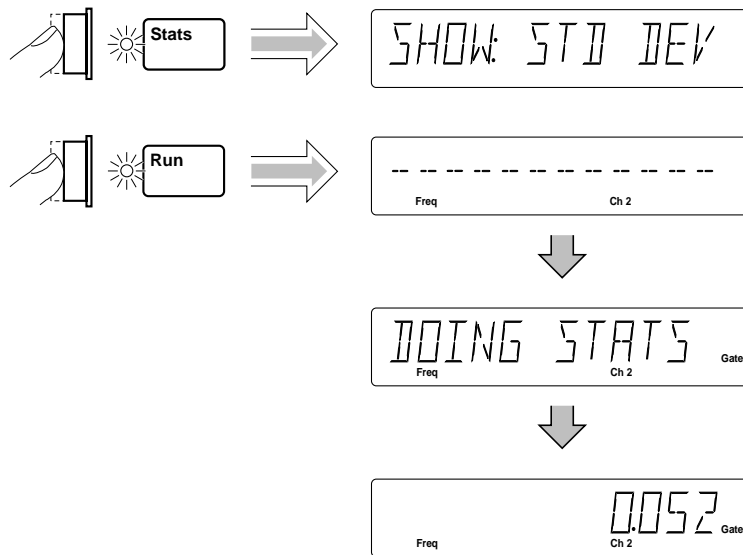

The standard deviation value shown in the previous illustration is for demonstration purposes. The statistic is computed using only those measurements which fell within the limits you set.

(For more details on the Stats and Limits functions, refer to the appropriate sections in Chapter 2, “Operating Your Universal Counter.”)

Now, disable Math and Stats as shown in the following procedure.

Chapter 1 Getting Started

Making Measurements

To Control Measurement

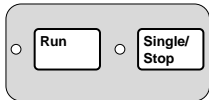

Use these two keys to control the measurement of the Counter. The **Run** key provides repetitive measurements, whereas the **Stop/Single** key allows you to make one measurement.

With the 10 MHz signal still connected to CHANNEL 2, perform the following steps so you can better understand the Run and Stop/Single operations.

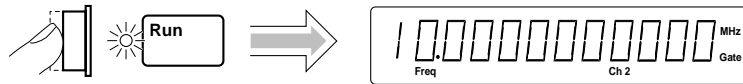

The Counter is now making repetitive measurements (continuously making “live” measurements).



The Counter stopped making measurements. The **Gate** annunciator is not lit. Hence, pressing the **Stop/Single** key while the Counter is making measurements (in **Run**) causes the Counter to stop after the measurement in progress is completed. If you press the **Stop/Single** key again while the Counter is stopped, the Counter will make a single measurement and then stop—the **Gate** annunciator will light one time, momentarily.

If you press the **Stop/Single** key while the Counter is stopped and when the Stats menu item ON SINGLE is set to N, the Counter will make N measurements and then stop. This enables a set of statistics to be computed.

While the Counter is still stopped, perform the following step.

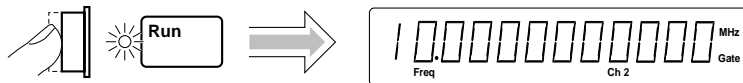

The Counter is making repetitive measurements again.

2

Operating Your Universal Counter

Operator's Reference

Introduction

This is the operator's reference chapter which contains information and procedures for the front-panel keys, operating functions, and menus of the Agilent 53131A/132A 225 MHz Universal Counter.

Chapter Summary

- How this Counter Works for You page 2-4
- Using the Measurement Control Keys (Run and Stop/Single) page 2-5
- Using Entry/Select (Arrow) Keys page 2-8
- Using the MEASURE Menu Keys page 2-10
- Using the Gate & External Arm Menu Key page 2-16
- Using the MATH Menu Keys page 2-27
- Using the LIMITS Menu Keys page 2-37
- Using CHANNEL 1 and CHANNEL 2 Input Conditioning Keys page 2-44
- Using the Save and Recall Menus page 2-52
- Using the Print Menu page 2-56
- Using the Utility Menu page 2-57
- Using the Calibration Menu page 2-67
- Front Panel Display Messages page 2-73
- Preset Values After Power-Up and *RST page 2-78
- Summary of the Measurement Sequence page 2-93
- Common Questions page 2-94

Introduction

Where to Find Some Key Working Examples

- Example Procedure for Gate and External Arm page 2-24
- Example Procedure for Changing the Number of Digits of Resolution Displayed for More Precise Measurements page 2-25
- Example Procedure for Scale Function page 2-28
- Example Procedure for Offset Function page 2-29
- Example Procedure for Turning Off Math Mode page 2-30
- Example Procedure for Setting the Offset From the Last Measurement Value page 2-31
- Example Procedure for Computing Stats page 2-33
- Example Procedure for Easy Viewing of Stats page 2-34
- Limits Testing Example 1—Flag and Stop Measuring On Limits page 2-38
- Limits Testing Example 2—Flag On Limits but Continue Measuring page 2-40
- Limits Testing Example 3—Use Analog Graph Display While Adjusting Input Signal page 2-40
- Limits Testing Example 4—Selecting Filtering Conditions of Stats Computation page 2-42
- Limits Testing Example 5—Sending the Limit-Detect Output to the RS-232 Serial Port page 2-43

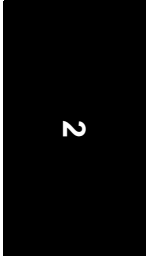

How this Counter Works for You

The following text lists some of the key things the Counter does for you.

- The Counter presets the menus to default states and values at power-up (refer to Table 2-7A for a detailed list of the preset values). Cycling the **POWER** key presets the Counter.
- The Counter's Utility menu allows you to select such things as timebase source, GPIB configuration, and RS-232 serial port configuration. After your selections, the Counter automatically stores all these selections in *non-volatile* memory (**except the timebase source**); thus, these settings (except timebase source) *will not* change when power has been off or after a remote interface reset.
- The Counter automatically displays measurement(s) in a couple of seconds after you select a measurement function (e.g., Period).
- The Counter accepts your numeric entry for a menu item after you press the **Enter** key. *You MUST press the Enter key to complete numeric entry.*
- The Counter automatically enables Limits when you enter a numeric value for upper and/or lower limits, or update any menu item in the Limit Modes menu.
- The Counter automatically enables Math after you enter a numeric value for scale and offset.
- The Counter performs Statistical analyses for you, and will enable Stats when you update any item in the Stats menu.
- The Counter automatically disables Limits, Math, and Stats when you select another measurement function.
- The Counter saves measurement setup(s).
- The Counter instantly recalls the measurement setup you want to use.
- The Counter prints out your measurement and analysis data.

Using the Measurement Control Keys (Run and Stop/Single)

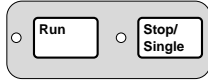

Overview of the Measurement Control Keys

Two measurement control keys are provided on the Agilent 53131A/132A Counter: **Run** and **Stop/Single**. In general, the **Run** key provides repetitive measurements while the **Stop/Single** key allows you to make single-shot measurements.

The **Run** key allows you to:

- put the Counter into a continuous measurement loop.
- exit any measurement after your selection of another measurement function.
- abort the current measurement by starting a new measurement (if already in Run mode or in Single mode with a measurement in progress). This also clears any statistics being processed.

The **Stop/Single** key allows you to:

- put the Counter into Single mode (if the Counter was in Run mode) where one measurement is taken with each **Stop/Single** keypress. (Stats menu item **ON SINGLE** should be set to **1**.)
- put the Counter into Single mode (if the Counter was in Run mode) where N measurements are taken with each **Stop/Single** keypress. (Stats menu item **ON SINGLE** should be set to N.)
- stop (abort) the current measurement (if the Counter was in Single mode).

Chapter 2 Operating Your Universal Counter
Using the Measurement Control Keys (Run and Stop/Single)

To Use the Measurement Control Keys

The following procedure demonstrates how these keys function.

- 1 Connect power source to Counter, and turn on Counter.

All segments of the front-panel display will light up while the Counter performs its power-on self-test, and then dashes are displayed. The Counter is now ready to measure frequency of a signal applied to CHANNEL 1 input. Note that the **Freq** and **Ch1** annunciators light.

- 2 Connect an input signal to CHANNEL 1.

The Counter automatically displays the measured frequency of the input signal. Note that the **Run** key indicator is ON.

- 3 Press **Stop/Single** key.

The Counter is put into Single mode and the current measurement is completed. One measurement is taken with each press of **Stop/Single** key. Note that the **Stop/Single** key indicator is ON.

- 4 Press **Run** key.

The Counter aborts any measurement in progress, and starts making repetitive measurements. That is, the Counter is in a continuous measurement loop.

- 5 Press **Stop/Single** key.

The Counter is put into Single mode.

- 6 Press **Stats** key until **ON SINGLE** menu item appears, then press any one of the arrow keys to set **ON SINGLE** menu item to **N**.

The Counter is set to take N measurements on each **Stop/Single** keypress. The state of **ON SINGLE** menu item affects the **Stop/Single** key operation while statistics are enabled.

Observe that the Stats indicator is ON. This indicates statistical processing is enabled.

Chapter 2 Operating Your Universal Counter
Using the Measurement Control Keys (Run and Stop/Single)

- 7 Press **Stop/Single** key.

One set of N frequency measurements is taken with each press of the **Stop/Single** key.
One set of statistics is computed with each press of the **Stop/Single** key.

- 8 Press **Stats** key until **SHOW** menu item appears.

- 9 Press any one of the arrow keys to select a statistical result to display, and press **Enter** key.

The Counter is now displaying one of the statistical results.

- 10 Press **Stop/Single** key.

One set of N frequency measurements is taken with each press of the **Stop/Single** key.
At the completion of the Nth measurement, the Counter displays the statistical result selected in step 9.

- 11 Press **Stats** key until **ON SINGLE** menu item appears, then press any one of the arrow keys to set **ON SINGLE** menu item to 1.

The Counter is set to take one measurement on each **Stop/Single** keypress.

Disabling the statistics (with the **STATS: OFF** menu item) is another way to cause the **Stop/Single** key to initiate one measurement at time.

Using Entry/Select (Arrow) Keys

There are six entry/select keys of which four are “arrow” keys. The function of the four arrow keys and the Enter key depends on the Counter’s operating mode (that is, numeric entry, state changing, sequencing through choices in a menu, etc.). This section describes how the keys perform in the different operating modes.

To Use During Numeric Entry

- Use the **s** key to move left to select adjustable digits (it does not wrap around).
- Use the **g** key to move right to select adjustable digits (it does not wrap around).
- Use the **d** key to increment the selected (highlighted) digit of the displayed value.
- Use the **f** key to decrement the selected (highlighted) digit of the displayed value.
- Use the **+/-** key to change the sign of the numeric value.
- Use the **Enter** key to complete a numeric entry. (If a numeric entry is changed and the **Enter** key is NOT pressed, then the value is not changed.)

To Use When Sequencing Through the Measurement Function Menus (Freq & Ratio, Time & Period, Other Meas) and the Recall Menu

- Use the **d** or **s** key to go back to the previous choice in a function or recall menu. Repeatedly pressing this key will cycle through (and loop around) the list of choices.
- Use the **f** or **g** key to go forward or to the next choice in a function or recall menu. Repeatedly pressing this key will cycle through (and loop around) the list of choices.
- Use the **Enter** key to select the function or execute the recall, or wait for the menu to time out for automatic selection/execution.

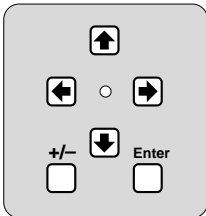

To Use During State Changing (ON/OFF, LO/MED/HI, etc.)

- Press **any** of the arrow keys to toggle or change to the next state of the parameters found in the following menus:
 - Gate & ExtArm
 - Limit Modes
 - Scale & Offset
 - Stats
 - Trigger/Sensitivity
 - 50Ω/1MΩ
 - DC/AC
 - X10 Attenuate
 - 100kHz Filter
 - Save & Print
 - Utility Menu
- The **Enter** and +/-keys are ignored during the state changing operating mode.

To Use on Prompted Event Messages (SET OFFSET ?, CAL: OFFS n ?, TEST: ALL?, etc.)

- For **SET OFFSET ?**, and all the **TEST: ?** prompted event messages, press **Enter** key to start the event.
- For **CAL: OFFS n ?** and **GAIN n ?**, press **Enter** key to display instructions. Press **Enter** key again to start the event.

To Use on Prompted Help Messages (MATH HELP ?, PRINT HELP ?)

- When **MATH HELP ?** is displayed, press **Enter** key to display the “**(MEAS x SCALE) + OFFS = RESULT**” message.
- When **PRINT HELP ?** is displayed, press **Enter** key to display the “**CONFIGURE PORT ON UTILITY MENU; REMEMBER TO SAVE SETUP FIRST**” instruction.

Using the MEASURE Menu Keys

Overview of the MEASURE Menus

The measurement function menus are divided into three categories:

- Frequency measurements on channel 1, 2, or 3 (optional) and ratio of frequencies between channels.
- Time interval, period, and pulse characterization measurements. (The Agilent 53131A/132A provides one key-press operation for such pulse measurements as risetime, falltime, pulse width, etc., which have traditionally required multiple key presses or operations.)
- Other measurements (duty cycle, phase, peak voltage, and totalize).

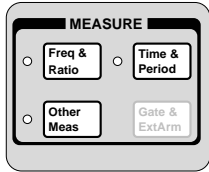

Table 2-1. Menus of the MEASUREMENT Keys

Freq & Ratio Key	Time & Period Key	Other Meas Key
FREQUENCY 1	TI 1 TO 2	TOTALIZE 1
REQUENCY 2	PERIOD 1	PHASE 1 TO 2
REQUENCY 3 (optional)	RISETIME 1	DUTYCYCLE 1
ATIO 1 TO 2	FALLTIME 1	VOLT PEAKS 1
ATIO 1 TO 3 (optional)	POS WIDTH 1	VOLT PEAKS 2
ATIO 2 TO 1	NEG WIDTH 1	
RATIO 3 TO 1 (optional)		

To sequence through the menus of the MEASUREMENT function keys (**Freq & Ratio**, **Time & Period**, and **Other Meas** keys), you simply need to repeatedly press the appropriate MEASURE key to cycle through (and loop around) the menus under the key. Each press of a MEASURE key will advance the Counter to the next measurement function in the menu.

NOTE

The menus under the MEASURE keys will terminate (select function and return to measurement result display) after two seconds.

Chapter 2 Operating Your Universal Counter

Using the MEASURE Menu Keys

To Measure Frequency

- 1 Connect power source to Counter, and turn on Counter.

All segments of the front-panel display will light up while the Counter performs its power-on self-test, and then dashes are displayed. The Counter is now ready to measure frequency of a signal applied to CHANNEL 1 input. Note that the **Freq** and **Ch1** annunciators light.

- 2 Connect an input signal to CHANNEL 1.

The Counter should automatically display the measured frequency of the input signal. The trigger levels are set to the 50% points of the signal. However, you may disable auto triggering, and change the trigger levels and slopes.

To set up CHANNEL 1's coupling, impedance, and triggering conditions to match the input signal you are trying to measure, refer to the procedures "To Select Input Coupling and Impedance" and "To Set Input Channel Trigger Level/Sensitivity" in Chapter 1, "Getting Started," or the section titled "Using CHANNEL 1 and CHANNEL 2 Input Conditioning Keys" in this chapter.

- 3 Press the **Freq/Ratio** key until **FREQUENCY 2** is displayed to measure the frequency of an input signal applied to CHANNEL 2.

FREQUENCY 2 is momentarily displayed, the **Freq** and **Ch2** annunciators light, and the Counter is ready to measure frequency of a signal applied to CHANNEL 2 input. The trigger levels are set to the 50% points of the signal. However, you may disable auto triggering, and change the trigger levels and slopes.

- 4 To measure the frequency of a signal applied to optional CHANNEL 3 input, repeat step 3 until **FREQUENCY 3** is displayed.

FREQUENCY 3 will be momentarily displayed and the **Freq** and **Ch3** annunciators will light. The Counter will be ready to measure the frequency of a signal applied to CHANNEL 3 input.

Note that the Frequency 3 menu item is not available in Counters that do not contain optional Channel 3.

To Measure Frequency Ratio

- 1 Press **Freq & Ratio** key until **RATIO 1 TO 2** is displayed.

RATIO 1 TO 2 is momentarily displayed, the **Freq**, **Ch1**, and **Ch2** annunciators light, and the Counter is ready to measure and display the frequency ratio of a signal applied to CHANNEL 1 in relation to a signal applied to CHANNEL 2 (Ch1/Ch2). The trigger levels are set to the 50% points of each signal. However, you may disable auto triggering, and change the trigger levels and slopes.

Note the result is not scaled by 100; it is not a percentage.

Note that RATIO 2 TO 1 is also available (Ch2/Ch1).

- 2 To measure the frequency ratio between a signal applied to CHANNEL 1 input and a signal applied to Option 030/050 CHANNEL 3 input, repeat step 1, above.

RATIO 1 TO 3 will be momentarily displayed and the **Freq**, **Ch1**, and **Ch3** annunciators will light. The Counter will be ready to measure the frequency ratio of a signal applied to CHANNEL 1 in relation to a signal applied to CHANNEL 3 (Ch1/Ch3).

Note that the Ratio 1 to 3 menu item is not available in Counters that do not contain optional Channel 3.

Note the result is not scaled by 100; it is not a percentage.

Note that RATIO 3 TO 1 is also available (Ch3/Ch1).

By pressing the **Freq & Ratio** key, the Counter will return to the Frequency 1 measurement mode; this demonstrates the loop around feature of the measurement function menu keys.

The front-panel “arrow” (or entry/select) keys can also be used when sequencing through the measurement function menus. Refer to the section titled “Using Entry/Select (Arrow) Keys” for details.

To Measure Time Interval

Press **Time & Period** key until **TI 1 TO 2** is displayed.

TI 1 TO 2 is momentarily displayed, the **Time**, **Ch1**, and **Ch2** annunciators light, and the Counter is ready to measure the length of time between a start event on CHANNEL 1 and a stop event on CHANNEL 2. The Counter is automatically set to measure from **separate** signal sources. (**The start and stop events may be derived from separate signal sources, or they may be from a single source. Refer to the section in this chapter titled “Using CHANNEL 1 and CHANNEL 2 Input Conditioning Keys” for specifics in performing Time Interval measurements on a single source—COMMON 1: ON**). Independent slope, trigger level, and sensitivity controls for the start and stop events allow variable triggering on either positive- or negative-going slopes.

The trigger levels are set to the 50% points of each signal. However, you may disable auto triggering, and change the trigger levels and slopes.

To Measure Period

Press **Time & Period** key until **Period 1** is displayed.

Period 1 is momentarily displayed, the **Period** and **Ch1** annunciators light, and the Counter is ready to measure the period of a signal applied to CHANNEL 1.

To Measure Rise/Fall Times

Press **Time & Period** key until **RISETIME 1** or **FALLTIME 1**, depending on which measurement you want to make, is displayed.

RISETIME 1 or **FALLTIME 1** is momentarily displayed, and the **Rise** or **Fall**, **Time**, and **Ch1** annunciators light. The risetime and falltime modes of operation automatically configure the Counter to perform risetime or falltime measurements through CHANNEL 1 input. The triggering is automatically set to AUTO TRIG: ON. In the risetime and falltime modes, AUTO TRIG automatically locates the 10% and 90% points of the input signal, and sets the trigger levels accordingly. You may override these automatic selections if you want.

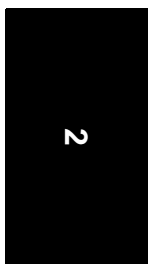

To Measure Positive/Negative Pulse Widths

Press **Time & Period** key until **POS WIDTH 1** or **NEG WIDTH 1**, depending on which measurement you want to make, is displayed.

POS WIDTH 1 or **NEG WIDTH 1** is momentarily displayed, and the **+Wid** or **–Wid**, and **Ch1** annunciators light. The pulse width measurement automatically configures the Counter to perform positive or negative pulse width measurements through CHANNEL 1 input. The AUTO TRIG is set to trigger at the 50% point of the signal.

To Measure Duty Cycle

Press **Other Meas** key until **DUTYCYCLE 1** is displayed.

DUTYCYCLE 1 is momentarily displayed, the **Ch1** annunciator lights. The dutycycle mode of operation is ready to measure a continuous waveform applied to CHANNEL 1 input. The input is automatically set to common-channel 1, and triggering set to AUTO TRIG: ON. The trigger levels are set to the 50% points of each signal. However, you may disable auto triggering, and change the trigger levels.

Results will range from 0 to 1. The dutycycle is defined as the positive pulse width divided by the period. (Note that the result is not scaled by 100; it is not a percentage.)

To Make Totalize Measurements

Press **Other Meas** key until **TOTALIZE 1** is displayed.

TOTALIZE 1 is momentarily displayed, the **Ch1** annunciator lights, and the Counter is in its totalize mode. Auto-triggering is automatically disabled on CHANNEL 1 since there may not be a suitable signal at the beginning of the measurement. The totalize mode of operation displays the number of counts (events) received through CHANNEL 1. The count is continuously displayed if GATE: AUTO is selected.

The totalize measurement is cleared to zero when the totalize function is first invoked, when the front-panel **Run** key is pressed, or when the Stop/**Single** key is pressed.

Chapter 2 Operating Your Universal Counter

Using the MEASURE Menu Keys

To Make Phase Measurements

Press **Other Meas** key until **PHASE 1 TO 2** is displayed.

PHASE 1 TO 2 is momentarily displayed, the **Ch1** and **Ch2** annunciators light, and the Counter is ready to measure the phase of a signal applied to CHANNEL 1 input relative to a signal applied to CHANNEL 2 input. The phase difference is displayed in degrees. If auto triggering is enabled, the trigger levels are set to the 50% points of each signal. However, you may disable auto triggering, and change the trigger levels and slopes.

Use CHANNEL 2 as the reference. One period on CHANNEL 2 will define 360°. If CHANNEL 1 is leading CHANNEL 2, the pulse result is positive.

To Measure Positive/Negative Voltage Peaks

Press **Other Meas** key until **VOLT PEAKS 1** or **VOLT PEAKS 2**, depending on which measurement you want to make, is displayed.

VOLT PEAKS 1 or **VOLT PEAKS 2** is momentarily displayed, the **Ch1** or **Ch2** annunciator lights, and the Counter is ready to measure minimum and maximum voltage peaks of signals applied to CHANNEL 1 or CHANNEL 2, respectively.

NOTE

In Voltage Peaks function, the Counter measures the input signal *after* the signal has been conditioned by the input settings (impedance, coupling, attenuation, and filter). One reminder of this is the (**AC COUPLED**) message, which is displayed when Voltage Peaks is selected and the measurement channel is ac coupled.

The result is corrected for X10 attenuation.

Note that Arming is not used for Voltage Peaks measurements, and that neither Limits nor Math is available.



2

Using the Gate & External Arm Menu Key

Overview of Gate/External Arming Functions

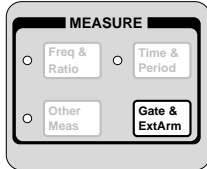

Table 2-2 for the Agilent 53131A (and Agilent 53132A with a serial number prefix below 3646) and Table 2-3 for the Agilent 53132A with a serial number prefix 3646 and above (on page 2-19 and page 2-23, respectively) list the menus for all the arming configurations, and shows how the Gate and External Arming menu changes as a function of the measurement and the arming mode.

The Agilent 53131A/132A Counter has four arming modes: auto, external, digits, and time. However, the Agilent 53131A (or Agilent 53132A with a serial number prefix below 3646) and Agilent 53132A have different arming capabilities for Time Interval measurements. Thus, for simplicity, their Time Interval arming capabilities are discussed in separate subsections.

- If you are using an Agilent 53131A (or Agilent 53132A with a serial number prefix below 3646), read the Time Interval Delay arming information *starting on page 2-17*.
- If you are using an Agilent 53132A (with a serial number prefix 3646 and above), read the Time Interval Delay arming information *starting on page 2-20*.

Gate/External Arming Capabilities

AUTO Arming

For frequency, period, frequency ratio, risetime, falltime, pulse width, dutycycle, and phase, **auto arming** means make individual measurements as fast as possible.

For totalize, auto arming means the Counter starts to count when it is enabled by the pressing of either the **Run** or **Stop/Single** key. The Counter stops counting when the **Stop/Single** key is pressed.

Chapter 2 Operating Your Universal Counter Using the Gate & External Arm Menu Key

EXTERNAL Arming

For frequency, period, frequency ratio, and totalize, **external arming** means you can control the start of a measurement by using an external signal.

NOTE

When external arming mode is enabled, a signal must be connected to the Counter's rear-panel **Ext Arm** connector.

TIME Arming

For frequency, period, ratio, and totalize, **time arming** means you can set the gate time—the length of time for which your signal is measured.

NOTE

Gate time and resolution are linked: the longer the gate time, the greater the resolution. With an increase in resolution, you get a larger number of digits on the display.

Time arming is demonstrated in the sub-section titled “Example Procedure for Gate and External Arm.”

DIGITS Arming

For frequency, period, and ratio, **digits arming** means you can set the number of digits of resolution that you require your result to provide.

Digits arming is demonstrated in the sub-section titled “Example Procedure for Changing the Number of Digits of Resolution Displayed for More Precise Measurements.”

Agilent 53131A (and Agilent 53132A With S/N Prefix Below 3646) Time Interval DELAY Arming

The DELAY capability (specified in the Time Interval arming menu) provides a variable delay between the start event (Channel 1) and the enabling of the stop event (Channel 2) as shown Figure 2-1. Potential stop events are ignored during the specified delay time.

External arming can also be used to control the start of a measurement by using an external signal.

Chapter 2 Operating Your Universal Counter
Using the Gate & External Arm Menu Key

NOTE

When external arming mode is enabled, a signal must be connected to the Counter's rear-panel **Ext Arm** connector.

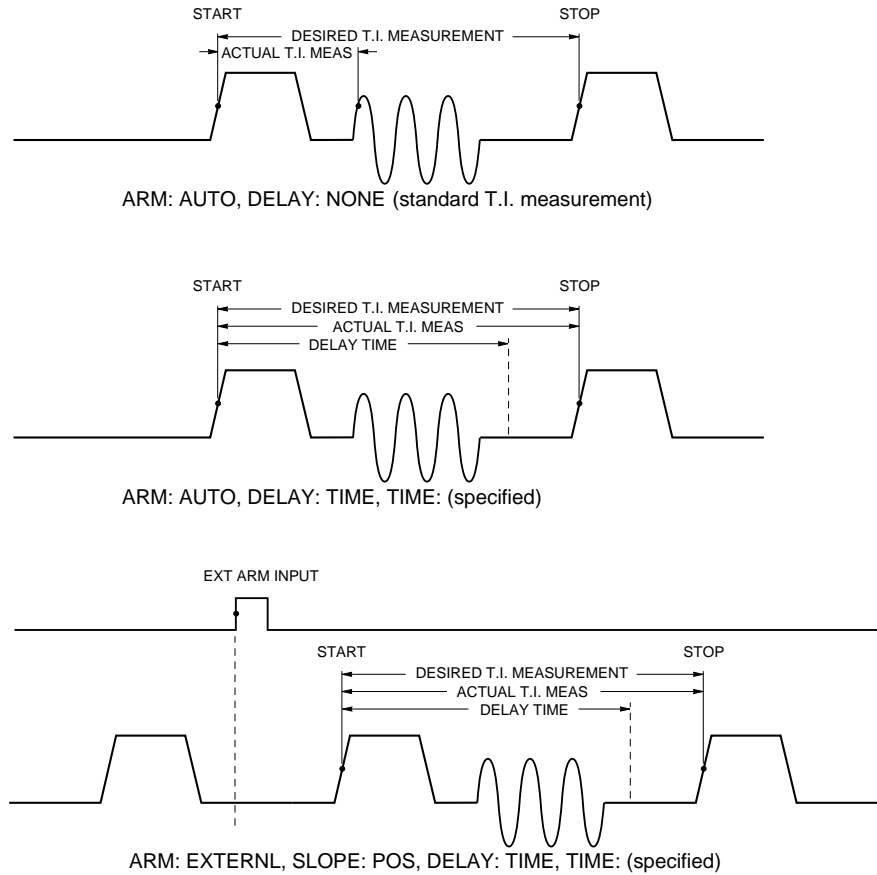

Figure 2-1. Agilent 53131A (Agilent 53132A S/N Prefix Below 3646) Time Interval Delay

NOTE

The examples in Figure 2-1 have the input signal applied to Channel 1 with COMMON 1: ON, Channel 1 SLOPE: POS, and Channel 2 SLOPE: POS.

Chapter 2 Operating Your Universal Counter
Using the Gate & External Arm Menu Key

Table 2-2. * Agilent 53131A (Agilent 53132A S/N Prefix Below 3646) Gate & External Arm Key Menus as a Function of the Measurement and Arming Mode

Freq, Period, Ratio	Phase	Totalize	RiseTime, Fall Time, +/-Width, DutyCycle	Time Interval
Auto Arming: GATE: AUTO	Auto Arming: ARM: AUTO	Auto Arming: GATE: AUTO	Auto Arming: ARM: AUTO	Auto Arming: ARM: AUTO DELAY: NONE TIME: <time>
Digits Arming: GATE: DIGITS DIGITS: <digits>	_____	_____	_____	_____
Time Arming: GATE: TIME TIME: <time>	_____	Time Arming: GATE: TIME TIME: <time>	_____	_____
External Arming: GATE: EXTERNL START: POS NEG STOP: AUTO NEG POS TIME TIME: <time>	External Arming: ARM: EXTERNL SLOPE: POS NEG	External Arming: GATE: EXTERNL START: POS NEG STOP: NEG POS TIME TIME: <time>	External Arming: ARM: EXTERNL SLOPE: POS NEG	External Arming: ARM: EXTERNL SLOPE: POS NEG DELAY: NONE TIME TIME: <time>

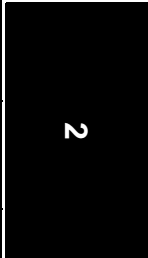

* There is no Gate and External Arm menu available for Voltage Peaks measurements.

Chapter 2 Operating Your Universal Counter Using the Gate & External Arm Menu Key

Agilent 53132A (With S/N Prefix 3646 and Above) Time Interval DELAY Arming

In the following subsections, a leading star (*) means the parameter affects the START event. A trailing star means the parameter affects STOP event.

AUTO ARMING (*START: AUTO)

The DELAY* (stop delay) capability (specified in the Time Interval arming menu) provides a variable delay between the start event (Channel 1) and the enabling of the stop event (Channel 2) as shown in Figure 2-2. Two types of delay are possible: 1) TIME—potential stop events are ignored during the specified delay time, or 2) EVENT—the measurement is stopped when the specified number of stop events has occurred.

EXTERNAL ARMING (*START: EXT)

External arming can be used to control the start, or start and stop, of a measurement by using an external signal as shown in Figure 2-3.

Set STOP* and/or *START to EXT to activate.

NOTE

When external arming mode is enabled, a signal must be connected to the Counter's rear-panel **Ext Arm** connector.

The *DELAY (start delay) capability (specified when *START is set to EXT) provides a variable delay between the arming event (Ext Arm) and the enabling of the start of the measurement. Two types of delay are possible: 1) TIME—potential start events (Channel 1) are ignored during the specified delay time, or 2) EVENT—the measurement is started after the specified number of Channel 2 events has occurred. A DELAY* (stop delay) as described in AUTO ARMING above can also be used in conjunction with *DELAY (start delay) as shown in Figure 2-3.

Chapter 2 Operating Your Universal Counter
Using the Gate & External Arm Menu Key

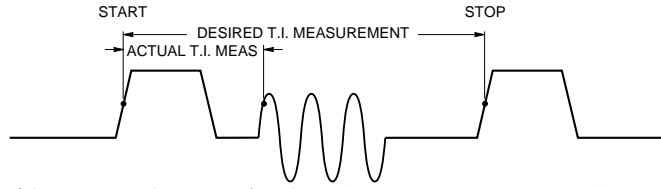

⌘START: AUTO, DELAY ⌘: NONE (standard T.I. measurement)

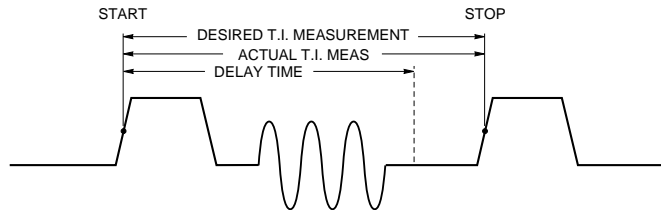

⌘START: AUTO, DELAY ⌘: TIME, T⌘: (specified)

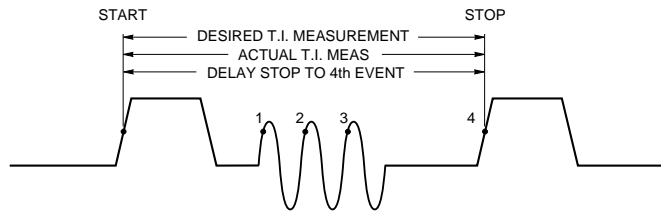

⌘START: AUTO, DELAY ⌘: EVENT, E⌘: 4

Figure 2-2. Agilent 53132A (With S/N Prefix 3646 and Above) Auto Arming

NOTE

The examples in Figure 2-2 have the input signal applied to Channel 1 with COMMON 1: ON, Channel 1 SLOPE: POS, and Channel 2 SLOPE: POS.

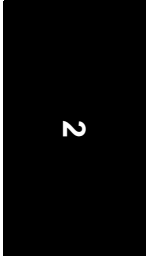

Chapter 2 Operating Your Universal Counter
Using the Gate & External Arm Menu Key

2

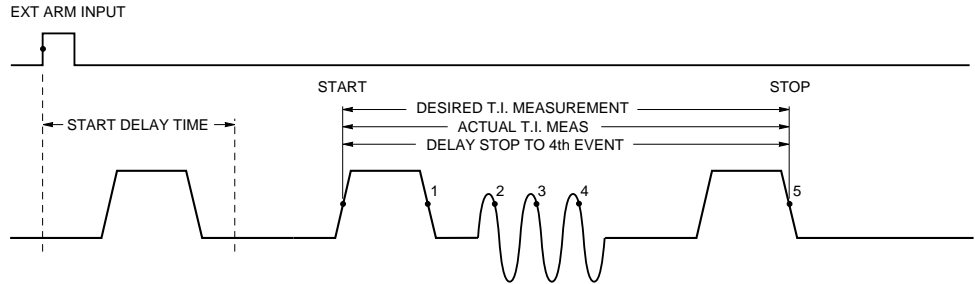

⌘ START: EXT, ⌘ SLOPE: POS, ⌘ DELAY: TIME, ⌘ T: (specified), STOP ⌘: AUTO, DELAY ⌘: EVENT, E ⌘: 5

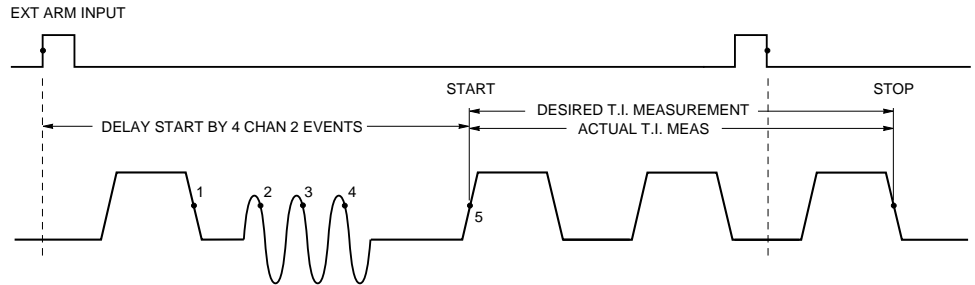

⌘ START: EXT, ⌘ SLOPE: POS, ⌘ DELAY: EVENT, ⌘ E: 5, STOP ⌘: EXT, SLOPE ⌘: NEG, DELAY ⌘: NONE

Figure 2-3. Agilent 53132A (With S/N Prefix 3646 and Above) External Arming

NOTE

The examples in Figure 2-3 have the input signal applied to Channel 1 with COMMON 1: ON, Channel 1 SLOPE: POS, and Channel 2 SLOPE: NEG. Thus, the signals applied to Channel 1 and Channel 2 are identical, however, the channel events occur on opposite slopes.

Chapter 2 Operating Your Universal Counter
Using the Gate & External Arm Menu Key

Table 2-3. * Agilent 53132A (S/N Prefix 3646 and Above) Gate & External Arm Key Menus as a Function of the Measurement and Arming Mode

Freq, Period, Ratio	Phase	Totalize	RiseTime, Fall Time, +/-Width, DutyCycle	**Time Interval
Auto Arming: GATE: AUTO	Auto Arming: ARM: AUTO	Auto Arming: GATE: AUTO	Auto Arming: ARM: AUTO	Auto Arming: *START: AUTO DELAY*: NONE TIME EVENT T*: <time> E*: <events>
Digits Arming: GATE: DIGITS DIGITS: <digits>	_____	_____	_____	_____
Time Arming: GATE: TIME TIME: <time>	_____	Time Arming: GATE: TIME TIME: <time>	_____	_____
External Arming: GATE: EXTERNL START: POS NEG STOP: AUTO NEG POS TIME TIME: <time>	External Arming: ARM: EXTERNL SLOPE: POS NEG	External Arming: GATE: EXTERNL START: POS NEG STOP: NEG POS TIME TIME: <time>	External Arming: ARM: EXTERNL SLOPE: POS NEG	External Arming: *START: EXT *SLOPE: POS NEG *DELAY: NONE TIME EVENT *T: <time> *E: <events> STOP*: AUTO EXT SLOPE*: POS NEG DELAY*: NONE TIME EVENT T*: <time> E*: <events>



* There is no Gate and External Arm menu available for Voltage Peaks measurements.

** A leading star (*) means the parameter affects the START event. A trailing star means the parameter affects the STOP event.

To Use the Gate and External Arm

Example Procedure for Gate and External Arm

For demonstration purposes, you want to set up the Counter so that it uses an external arm to start a measurement. You want to make a Totalize measurement on the positive edges (that is, count the number of positive edges) of a pulse-train signal applied to channel 1. Also, you want to perform the measurement during an interval of 5 milliseconds as shown in the following figure.

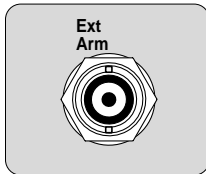
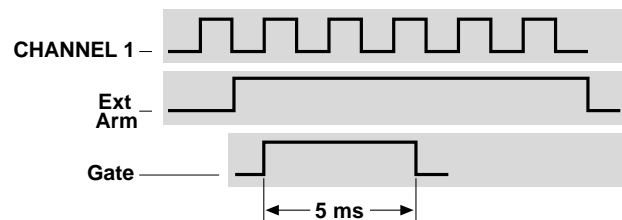

Perform the following procedure to accomplish this task.

- 1 Turn on the Counter, and press **Stop/Single** to put the Counter into the single measurement mode.
 - 2 Connect the pulse-train signal to channel 1 input, and press Other Meas key until **TOTALIZE 1** is displayed.
 - 3 Connect an external TTL signal to the Counter's rear-panel **Ext Arm** connector.
 - 4 Press **Gate & ExtArm** key.
- GATE: TIME** is displayed.
- 5 Press any one of the arrow keys until **GATE: EXTERNL** is displayed.
 - 6 Press **Gate & ExtArm** key.

START: POS is displayed. (If **START: NEG** is displayed instead, then press any one of the arrow keys to toggle to the next state—**POS**).

Chapter 2 Operating Your Universal Counter
Using the Gate & External Arm Menu Key

- 7 Press **Gate & ExtArm** key.
STOP: NEG is displayed.
- 8 Press any one of the arrow keys until **STOP: TIME** is displayed.
- 9 Set the Gate Time to 5 ms by performing the following steps:
 - a. Press **Gate & ExtArm** key.
TIME: .100 seconds (the default time) is displayed.
 - b. Press the appropriate arrow keys to until **TIME: .00500** seconds is displayed.
 - c. Press **Enter** key.

NOTE

BE SURE to press the Enter key to complete the numeric entry.

The counter will now gate for a duration of 5 ms.

- 10 Press **Stop/Single** key to start the measurement.

The measurement is started after the external arm pulse occurs.

Example Procedure for Changing the Number of Digits of Resolution Displayed for More Precise Measurements

- 1 Turn **POWER** key OFF then ON again (cycle **POWER** key) to preset the Counter.
- 2 Connect (for demonstration purposes) the **10 MHz Out** signal to the channel 1 input.
- 3 Press **Time & Period** key until **PERIOD 1** is displayed.

After a few seconds, **0.1000000000** μs is displayed. Hence, the default number of digits (or resolution) displays a precise measurement.

Chapter 2 Operating Your Universal Counter

Using the Gate & External Arm Menu Key

- 4 To demonstrate how to use “digits arming” to change the number of digits displayed, perform the following steps first.
- Press **Gate & ExtArm** key
GATE: TIME is displayed.
 - Press any one of the arrow keys until **AUTO** is displayed.
 - Press **Run** key.
0.1000 μs is displayed. Note that fewer digits are displayed.

In “auto arming” you produce results quickly. The short gate time produces a lower-resolution result.

- 5 To change the display to the better measurement resolution using digits arming, perform the following steps:
- Press **Gate & ExtArm** key
GATE: AUTO is displayed.
 - Press any one of the arrow keys until **DIGITS** is displayed.
 - Press **Gate & ExtArm** key.
DIGITS: 4 is displayed (the default number of digits)
 - To set the number of digits displayed to 8, press the appropriate arrow keys until **DIGITS: 8** is displayed.
 - Press **Enter** key.
 - Press **Run** key.
0.1000000 μs is displayed. Note that 8 digits of resolution are displayed.

Using the MATH Menu Keys

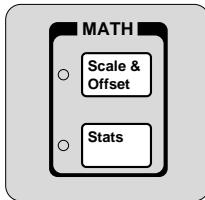

Note that Math and Limits are not available for Totalize and Voltage Peaks measurements.

Overview of Scale/Offset Math Menu

The Scale and Offset functions within the Math menu allow you to perform simple mathematical operations on the measurement result before it is displayed. The Scale and Offset functions allow for multiplication and addition. Modification of the displayed measurement by these math operations is represented by the following equation:

$$(\text{Measurement} \times \text{Scale}) + \text{Offset} = \text{Displayed Result}$$

The math operations can be used, for example, to subtract systematic errors or display the percentage difference between signals. Also, the overall math operation can be disabled and then re-established without having to re-enter constants.

The menu items of the Scale and Offset Math functions allow you to:

- enter a desired multiplication factor for a measurement (**SCAL:**).
- enter a desired addition or subtraction value for a measurement (**OFFS:**).
- get and display the last measurement value, and use it as the offset (**SET OFFSET ?**).
- disable or enable the Math mode (**MATH: OFF** or **ON**)—Note that the Math mode is automatically enabled when you enter the scale and/or offset value(s); thus, the primary function of this menu item is to allow you to turn the Math mode off.
- get Help, which displays the equation “**(MEAS X SCALE) + OFFS = RESULT**” to tell you how the scale and offset results are computed by the Counter (**MATH HELP ?**).

To Use the Scale/Offset Math Menu

Example Procedure for Scale Function

For demonstration purposes, you have a motor that has a tachometer attached to its rotating shaft that generates a pulse for every revolution of the shaft.

Your task is to measure the speed or revolutions per minute (rpm) of the tachometer's sinusoidal output, and make the Counter directly display the measurement in rpm (which is fundamentally a frequency measurement). The equation for this task is:

$$\text{Frequency} \left(\frac{\text{Resolution}}{\text{Sec}} \right) \times \text{Scale} \left(\frac{60\text{Sec}}{\text{Min}} \right) = \text{Results} \left(\frac{\text{Resolution}}{\text{Min}} \right)$$

Perform the following procedure to accomplish this task.

- 1 Connect the sinusoidal output to channel 1 input, and set up the Counter to measure frequency of the signal. (Refer to the section in this chapter titled "To Measure Frequency" if needed.)
- 2 Press **Scale & Offset** key until **SCAL: 1.000000** is displayed.
- 3 Set the Scale to 60 (since there are sixty seconds in a minute) by performing the following steps:
 - a. Press appropriate arrow keys to set Scale to 60.
 - b. Press **Enter** key.

NOTE

BE SURE to press the Enter key to complete the numeric entry.

The scale is now set to 60.

When the scale factor is set, both scale and offset are applied to the measurement result. Verify that the offset value is zero for applications requiring only scale by performing the following step.

Chapter 2 Operating Your Universal Counter
Using the MATH Menu Keys

- 4 Press **Scale & Offset** key until **OFFS:** is displayed.

OFFS: 0.000000 should be displayed. If the Offset value is not set to “0.000000”:

- a. Press the appropriate arrow keys to set the Offset to “0.000000.”
- b. Press **Enter** key.

NOTE

BE SURE to press the Enter key to complete the numeric entry.

The offset is now set to 0.

- 5 Press **Run** key.

The rpm measurement is displayed.

Example Procedure for Offset Function

Your task is to measure the Period of a signal connected to channel 1, and to offset the measurement by 100 nanoseconds. Perform the following procedure to accomplish this task.

- 1 Cycle **POWER** key to preset the Counter.
- 2 Connect a signal to channel 1, and set up the Counter to measure the period of the signal, using the **Time & Period** key. (**Refer to the section in this chapter titled “To Measure Period” if needed.**)
- 3 Press **Scale & Offset** key until **SCAL:** is displayed.
- 4 Set Scale to “1” by pressing the appropriate arrow keys to enter the value 1.000000 if Scale is not already set to “1.”
- 5 Press **Enter** key.

NOTE

BE SURE to press the Enter key to complete the numeric entry.

Chapter 2 Operating Your Universal Counter
Using the MATH Menu Keys

- 6 Press **Scale & Offset** key until **OFFS:** is displayed.

OFFS: 0.000000 seconds should be displayed. This is the default value.

- 7 Set the Offset to $\mp 1000000 \mu\text{s}$.

Refer to the sub-section titled “Entering the Offset Value” in Chapter 1, “Getting Started,” for details on how to perform numeric entry for Offset.

- a. Use the appropriate combination of the arrow keys to display a value of **.1000000** μs .
- b. Press **+/-**-key, which is located below the arrow keys, to change the plus sign to minus.
OFFS: $\mp 1000000 \mu\text{s}$ is displayed.
- c. Press **Enter** key.

NOTE

BE SURE to press the Enter key to complete numeric entry.

The counter will add $\mp 1000000 \mu\text{s}$ to each measurement.

- 8 Press **Run** key.

The resultant period measurement is displayed with 100 nanoseconds subtracted from each result.

Example Procedure for Turning Off Math Mode

- 1 Press **Scale & Offset** key until **MATH: ON** is displayed.
- 2 Press any one of the arrow keys.

MATH: OFF is displayed. Now, Scale and Offset no longer are used to modify the displayed result.

- 3 Press **Run** key to return the Counter to its normal operation.

Chapter 2 Operating Your Universal Counter

Using the MATH Menu Keys

Example Procedure for Setting the Offset From the Last Measurement Value

The **SET OFFSET ?** menu item uses the negative of the last measurement value, rounded to eleven digits, to set the **OFFSET**. Thus, any difference in the offset (or now the reference value) and the current measurement value is displayed.

Let's assume you are measuring the frequency of a stable source, but you are only interested in the least significant digits of the measurement. Use the **SET OFFSET ?** menu item to configure the appropriate **OFFSET** value.

Your task is to measure a stable source to obtain the changes in the least significant digits.

- 1 Cycle **POWER** key to preset the Counter.
- 2 Change gate time to 15.0 seconds on **GATE** menu.
- 3 To demonstrate **SET OFFSET?**, connect a 10 MHz sine wave signal to channel 1 of the Counter, and set up the Counter to measure the frequency of the signal. (Refer to the section in this chapter titled "To Measure Frequency" if needed.)

10.000000001 MHz is displayed.

- 4 Press **Scale & Offset** key until **SET OFFSET ?** is displayed.
- 5 Press **Enter** key.

OFFS:-10.00000 MHz is displayed, for example.

Note that this value represents the last measurement of the input signal rounded to eleven digits. The Counter uses it as the reference offset value, and reverses the sign from + to -.

Chapter 2 Operating Your Universal Counter

Using the MATH Menu Keys

- 6 Press **Run** key.

$-12^* \mu$ is displayed, for example, at the completion of the next measurement.

This value (-0.00012) is the small difference between the signal being measured and the reference value (**OFFS: -10.00000 MHz**) obtained in step 5.

Using the reference allows you to observe small differences in the 13th–15th digits which would not be observable in the 12-digit display.

Overview of Statistics (Stats) Menu

The Stats menu allows you to:

- select which computed statistics you want displayed (**SHOW: STD DEV, MEAN, MAX, or MIN**).
- choose between having the actual measurement or statistical result displayed (**SHOW: MEAS**).
- select the number of measurements you want to make for each computed statistic (**N:**).
- enable or disable the Stats mode (**STATS: ON or OFF**).
- enable the Counter to perform statistical computation on only measurements that are within the user-entered limits; that is, filter data (**USE: IN LIMIT**), or
- enable the Counter to perform statistical computation on all measurements, whether they fall in or out of the user-entered limits (**USE: ALL MEAS**).
- configure Stop/**Single** key to initiate a set of N measurements (**ON SINGLE: 1 or N**).

To Use the Stats Menu for Automatic and Continuous Statistical Analysis

Example Procedure for Computing Stats

For demonstration purposes, let's say you need to know the mean (average) and minimum risetime values of a digital signal.

Also, you want the Counter to make 20 measurements before it performs these statistical computations.

Perform the following procedure to accomplish this task.

- 1 Connect the digital signal to channel 1 input, and set up the Counter to measure risetime of the signal, using the **Time & Period** key. (Refer to the section in this chapter titled "To Measure Rise/Fall Times" if needed.)
- 2 Press **Stats** key until **N:** is displayed.
N: 100 is displayed (100 is the default value).
- 3 Set **N** to 20 (since you want the Counter to make 20 measurements before computing the mean and minimum values) by pressing the appropriate arrow keys.
N: 20 is displayed.
- 4 Press **Enter** key.

NOTE

BE SURE to press the Enter key to complete numeric entry.

The Counter is now set to make 20 measurements before computing statistics.

- 5 Press **Stats** key until **SHOW:** is displayed.
- 6 Press any one of the arrow keys until **SHOW: MEAN** is displayed.

Chapter 2 Operating Your Universal Counter

Using the MATH Menu Keys

- 7 Press **Run** key.

Immediately after the **Run** key is pressed, the Counter momentarily displays **DOING STATS**. When the Counter has made 20 valid measurements, it then displays the **mean** risetime value of the digital input signal.

NOTE

The Counter will display updated statistics results every 20 measurements.

- 8 Press **Stop/Single** key after you have a mean value displayed.
- 9 To display the **minimum** risetime value, perform the following:

- a. Press **Stats** key.
- b. Press any one of the arrow keys until **SHOW: MIN** is displayed.
- c. Press **Enter** key.

CAUTION

Pressing the **Run** key now would clear the present statistics results and calculate a new set of results after “N” measurements.

Example Procedure for Easy Viewing of Stats

The d and f arrow keys provide a short cut to viewing each of the stats (that is, standard deviation, mean, maximum, and minimum) when the Counter is already displaying a statistic measurement. These keys allow you to cycle through the different Stats results and automatically view them.

While the Counter is displaying a statistics measurement, press either the d or f arrow key to cycle through and display each of the four computed statistics, and the current measurement.

Chapter 2 Operating Your Universal Counter
Using the MATH Menu Keys

Example Procedure for Filtering Data (Using Limits) During Stats

- 1 Using the procedure in the previous sub-section titled “Example Procedure for Easy Viewing of Stats,” set up the Counter to display the minimum risetime value of an input signal.
- 2 Set the upper and lower limits. (Refer to the section in Chapter 1 titled “To Set Limits of Measurements” if needed.)
- 3 Press **Stats** key until **USE:** is displayed.
- 4 Press one of the arrow keys to toggle to **IN LIMIT** state.

USE: IN LIMIT is displayed.

- 5 Press **Run** key.

The Counter will now perform the statistical computations (that is, standard deviation, mean, maximum, and minimum) on only those measurements that are within the user-entered limits. The Counter then displays the statistics you picked (minimum, in this case).

- 6 Press **Stats** key until **USE:** is displayed.
- 7 Press any one of the arrow keys to toggle to **ALL MEAS** state.

USE: ALL MEAS is displayed.

- 8 Press **Run** key.

The Counter will now perform the statistical computations (that is, standard deviation, mean, maximum, and minimum) on all measurements, whether they fall in or out of the user-entered limits. The Counter then displays the statistic you picked (minimum, in this case).

Example Procedure for Configuring SINGLE to Initiate N Measurements

Please refer to the procedure titled “To Use the Measurement Control Keys” on page 2-6 for an example use of ON SINGLE.

Chapter 2 Operating Your Universal Counter
Using the **MATH Menu Keys**

Example Procedure for Turning Off Stats Mode

- 1 Press **Stats** key until **STATS: ON** is displayed.
- 2 Press any one of the arrow keys.
STATS: OFF is displayed.
- 3 Press **Run** key to return the Counter to its normal operation.

Using the LIMITS Menu Keys

Note that Math and Limis menus are not available for Totalize and Voltage Peaks measurements.

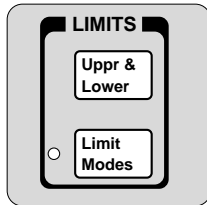

Overview of Limits Menus

The menu items under the Limits keys allow you to:

- select the desired upper and lower measurement limits (**UPPR:**, **LOWR:**).
- disable or enable Limit Testing (**LIM TEST: OFF** or **ON**)—Note that the Limit Testing is automatically enabled when you set the upper and lower limits, or update any menu item in the Limit Modes menu; thus, the primary function of the LIM TEST menu item is to allow you to turn Limit Testing off.
- set the Counter to stop making measurements when a measurement exceeds the user-entered limits (**ON FAIL: STOP**). (Stop on limits does not have any effect if the Counter is in the single measurement mode.)
- enable the Counter to continue taking measurements after a measurement exceeds the user-entered limits (**ON FAIL: GO ON**).
- change the Counter display from numeric to analog graph to quickly visualize changes in the signal (or to quickly see when measurements are in or out of limits) (**SHOW: NUMBER** or **GRAPH**).

2

To Set and Use Automatic Limit Testing

Limits Testing Example 1—Flag and Stop Measuring On Limits

For demonstration purposes, you want to first measure the ratio between signals applied to channels 1 and 2 of the Counter. Next, you want to set limits that would cause the Counter to flag (turn on the Limits annunciator in the front-panel display) and stop making measurements if these signals drift more than $\pm 10\%$ apart.

- 1 Connect input signals to channels 1 and 2 of the Counter, and set up the Counter to measure the ratio between these signals. (Refer to the section in this chapter titled “To Measure Frequency Ratio” if needed.)

Assume that the ratio measured between the two signals is 2. If the drift is not to be larger than $\pm 10\%$, then the upper limit should be set to **2.2** and the lower limit to **1.8**. Let’s set these values in the following steps.

- 2 Press **Uppr/Lower** key until **UPPR:** is displayed.

UPPR: 0.000000 is displayed (0 is the default value).

- 3 Set **UPPR** to 2.2. (Refer to the section in Chapter 1 titled “To Set Limits of Measurements” if needed.)

NOTE

After you enter the value 2.2, BE SURE to press the Enter key to complete the entry.

- 4 Press **Uppr/Lower** key until **LOWR:** is displayed.

LOWR: 0.000000 is displayed (0 is the default value).

- 5 Set **LOWR** to 1.8.

NOTE

After you enter the value 1.8, BE SURE to press the Enter key to complete the entry.

Chapter 2 Operating Your Universal Counter
Using the LIMITS Menu Keys

- 6 Press **Limit Modes** key until **LIM TEST: ON** is displayed.

Note that once either the upper or lower limits have been set, the limit testing is automatically enabled as indicated by the **LIM TEST: ON** display, and the Limit Modes indicator.

- 7 Press **Limit Modes** key.

ON FAIL: GO ON is displayed.

- 8 Press any one of the arrow keys to toggle to the next state.

ON FAIL: STOP is displayed. The **ON FAIL: STOP** function tells the Counter to stop making measurements when the input signals drift more than $\pm 10\%$ apart.

- 9 Press **Run** key to start making measurements with this limits-testing choice selected.

Now, if a measurement drifts out of the user-entered limits the **Limit** annunciator in the display will light. The Counter will stop making measurements.

Chapter 2 Operating Your Universal Counter

Using the LIMITS Menu Keys

Limits Testing Example 2—Flag On Limits but Continue Measuring

If you decide that you want the Counter to flag measurements that are out of limits but to continue taking measurements, then perform the following steps.

- 1 Press **Limit Modes** key until **ON FAIL: STOP** is displayed.
- 2 Press any one of the arrow keys to toggle to the next state.

ON FAIL: GO ON is displayed.

- 3 Press **Run** key to start making measurements with this limits-testing choice selected.

Now, each time a measurement drifts out of the user-entered limits the **Limit** annunciator in the display will light, but the Counter will continue to make measurements.

The Limit annunciator will go on whenever a result is out of limits. As soon as a result is within limits, the Limit annunciator will go off.

Limits Testing Example 3—Use Analog Graph Display While Adjusting Input Signal

- 1 For demonstration purposes, connect a 10 MHz signal to channel 1 and set up the Counter to measure the frequency of the signal, using the **Freq & Ratio** key. (Refer to section in this chapter titled “To Measure Frequency” if needed.)
- 2 Using the **Uppr & Lower** key, set the upper limit to 10.2 MHz and the lower limit to 9.8 MHz. (Refer to the section in Chapter 1 titled “To Set Limits of Measurements” if needed.)
- 3 Press **Limit Modes** key until **SHOW: NUMBER** is displayed.
- 4 Press any one of the arrow keys to toggle to the next state.

SHOW: GRAPH is displayed.

Chapter 2 Operating Your Universal Counter
Using the LIMITS Menu Keys

- 5 Press **Run** key to display the graph as shown below.

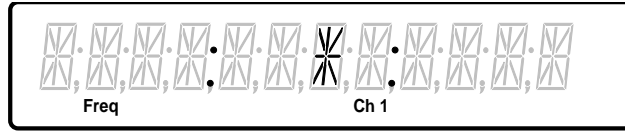

The asterisk (*) or star represents the measurement and the colons (:) represent the limits you set. This graph indicates that the measurement is within the limits. The colon to the left represents the lower limit, and the colon to the right represents the upper limit.

- 6 Adjust your signal down to 9.7 MHz.

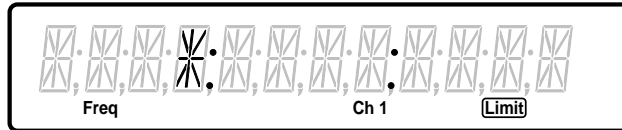

The star is now out of the limits as it is below the entered 9.8 MHz lower limit. (Note the **Limit** annunciator lights since the signal is out of limits.)

- 7 Now, adjust your signal up to 10.3 MHz.

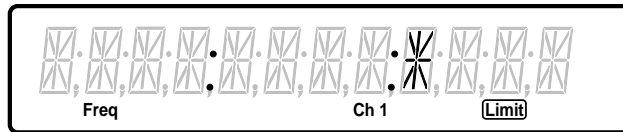

The star is now out of the limits as it has exceeded the entered 10.2 MHz upper limit. (Note the **Limit** annunciator lights since the signal is out of limits.)

- 8 To change the Counter back to displaying numbers, press **Limit Modes** key until **SHOW: GRAPH** is displayed.
- 9 Press any one of the arrow keys to toggle to **SHOW: NUMBER**.
- 10 Press **Run** key to display measurements as numbers.

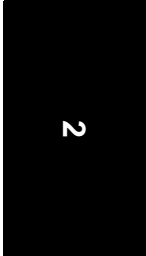

Chapter 2 Operating Your Universal Counter
Using the LIMITS Menu Keys

Limits Testing Example 4—Selecting Filtering Conditions of Stats Computation

Let's assume you have set the upper and lower limits to reasonable values as in the previous procedure.

NOTE

Since the Limit Testing and Stats functions are independent, **LIM TEST:** doesn't have to be ON in order to filter measurements for statistics.

- 1 Press **Stats** key until **USE: ALL MEAS** is displayed.
- 2 Press any one of the arrow keys to display **USE: IN LIMIT**.
- 3 Press **Run** key to start the measurement.

The Counter will compute statistics using only measurements that are within the user-entered limits.

- 4 Press **Stats** key until **USE: IN LIMIT** is displayed.
- 5 Press any one of the arrow keys to display **USE: ALL MEAS**.

The Counter will compute statistics using all measurements, whether they fall in or out of the user-entered limits.

- 6 Press **Run** key to start the measurement.
- 7 To turn off the Limit Testing, perform the following steps:
 - a. Press **Limit Modes** key until **LIM TEST: ON** is displayed.
 - b. Press any one of the arrow keys to toggle Limits OFF.
LIM TEST: OFF is displayed.

When Limit Testing is off, the Limit annunciator, the stop-on limit capability, the limit graph, and the rear panel RS-232 Limit Output (if DTR: LIMIT choice was selected as described in the following Example 5 procedure) are disabled.

NOTE

Stats will still filter data using your upper and lower limits if you set Stats to USE: IN LIMIT.

- 8 Press **Run** key to return the Counter to computing statistics on all measurements.

Chapter 2 Operating Your Universal Counter

Using the LIMITS Menu Keys

Limits Testing Example 5—Sending the Limit-Detect Output to the RS-232 Serial Port

NOTE

If you cycle power, you will lose everything except saved measurement setups and special parameters saved to non-volatile memory; therefore, make sure you use the Save and Recall functions of the Counter to retain the measurement setup prior to powering down to set up the the Limit-Detect Output line (pin 4) of the RS-232 serial connector. Refer to the appropriate section in this chapter for details on how to use Save and Recall.

- 1 To use the Limit-detect output from the serial port, perform the following steps:
 - a. Save your measurement setup that includes your Limit Testing choices, by simply pressing the **Save & Print** key until **SAVE: 1** is displayed, then **Enter** key to save to register 1.
 - b. Turn off the Counter.
 - c. Press and hold **Recall (Utility)** key, then press **POWER** key.
 - d. Press **Recall (Utility)** key until **DTR:** is displayed.
 - e. Press any one of the arrow keys until **DTR: LIMIT** is displayed.
- 2 Press **Run** key.
- 3 Press **Recall (Utility)** key until **RECALL 1** is displayed, then wait a few seconds to recall the measurement setup saved in register 1.

Since your measurement setup included your settings for upper and lower limits, and **LIM TEST:** was set to **ON**, the Counter is now set for limit testing with the Limit-detect output.

If a measurement drifts out of the user-entered limits, the Limit annunciator in the display will light. Also, pin 4 on the RS-232 connector will change state (to a low-voltage RS-232 level) to flag each time a measurement drifts out of the limits. (RS-232 voltage levels swing from $\pm 12V$.)

Using CHANNEL 1 and CHANNEL 2 Input Conditioning Keys

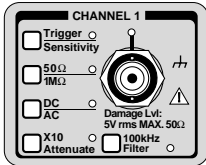

The **Trigger/Sensitivity** keys are menu keys, while the other keys in this group (that is, **50Ω/1 MΩ**, **DC/AC**, **X10 Attenuate**, and **100 kHz Filter**) are toggle keys.

Use the CHANNEL 1 and CHANNEL 2 group of keys (which are identical) to set up the Counter's input conditions for measuring input signals applied to channels 1 and 2. Each channel can be set up independently. (The Trigger/Sensitivity menu is unavailable for Voltage Peaks measurements.)

Overview of Trigger/Sensitivity Menu

Many of the measurement functions (that is, frequency, period, etc.) automatically set the auto trigger mode and trigger level. The Trigger/Sensitivity menu items allow you to override the automatic settings.

The menu items under the Trigger/Sensitivity keys allow you to manually:

- select the auto trigger mode (**AUTO TRIG: ON** or **OFF**).

If auto trigger is OFF, you are allowed to:

- select the voltage level at which the corresponding input channel will trigger (**LEVEL: n V**, where n is a numeric value).

If auto trigger is ON, you are allowed to:

- select the percentage of an input signal at which the Counter will trigger (**LEVEL: n PCT**, where n is a numeric value).

Setting **AUTO TRIG:** to ON causes the Counter to measure and compute a trigger level corresponding to the auto-trigger percentage of the selected channel.

NOTE

Chapter 2 Operating Your Universal Counter

Using CHANNEL 1 and CHANNEL 2 Input Conditioning Keys

While AUTO TRIG: is ON, the Counter will, for each measurement, check that the measurement signal(s) are triggering at the current level(s). If no triggering is found, the Counter will measure and compute new trigger level(s). (While AUTO TRIG: is ON, the Counter also measures and computes new trigger level(s) whenever measuring is invoked with the front-panel Stop/**Single** and **Run** keys, or whenever the auto-trigger percentage is updated.)

The menu items under the Trigger/Sensitivity keys also allow you to manually:

- select what slope or edge (positive or negative) of an input signal will trigger the Counter (**SLOPE: POS** or **NEG**).
- select medium, high, or low sensitivity levels (thus, varying the hysteresis window or trigger band) for the optimum sensitivity for certain measurement applications (**SENSVTY: MED, HI, or LOW**). Sensitivity is defined in the paragraph titled “Definition of Sensitivity” *starting on page 2-45*.
- select a common input signal to make a Time Interval (TI) measurement (**COMMON 1: ON or OFF**). In **COMMON 1: ON**, an input signal applied to CHANNEL 1 is split to allow the Counter to use it for both CHANNEL 1 and CHANNEL 2 input amplifiers when the Counter is operating in its Time Interval (TI 1 TO 2) measurement function. By independently adjusting CHANNEL 1 and CHANNEL 2 keys, the Counter performs a TI measurement on a single input signal as shown in the following figure.

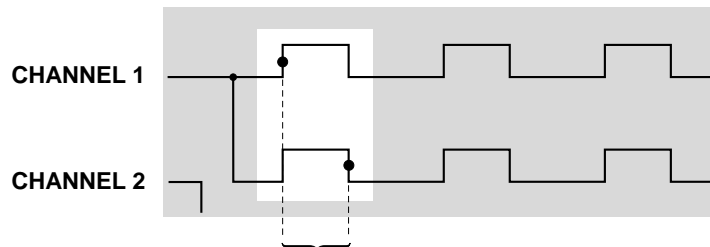

COMMON 1: ON, CHAN 1 SLOPE: POS, CHAN 2 SLOPE: NEG

DEFINITION OF SENSITIVITY. Sensitivity is the lowest amplitude signal at a particular frequency that the Counter will count. The amplifier gain and the voltage difference between the input trigger hysteresis levels determine the Counter’s sensitivity. Sensitivity is specified with the trigger level set at a value equal to the midpoint of the input signal. The input waveform must cross both the upper and lower hysteresis levels to generate a count as shown in the following figure.

Chapter 2 Operating Your Universal Counter
Using CHANNEL 1 and CHANNEL 2 Input Conditioning Keys

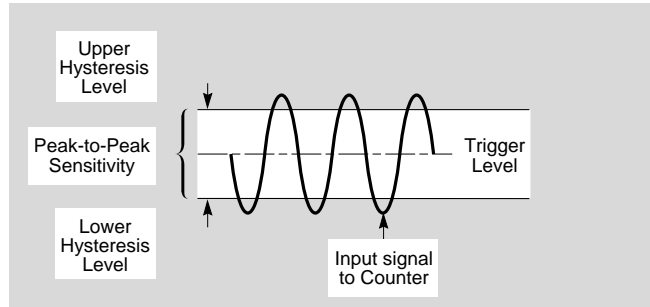

Signal crosses through both hysteresis levels to effect a count.

If the signal peaks do not exceed beyond both hysteresis limits, the input signal will not generate a count. For example, the peak-to-peak amplitude is insufficient, or trigger level is set above or below the midpoint of the input signal as shown in the following figures.

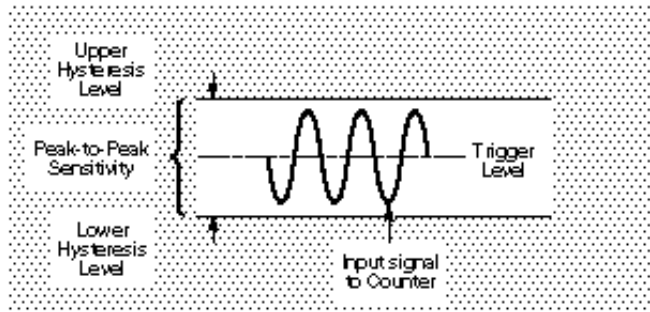

Signal will not generate a count because the peak-to-peak amplitude of the signal is insufficient.

Chapter 2 Operating Your Universal Counter
Using CHANNEL 1 and CHANNEL 2 Input Conditioning Keys

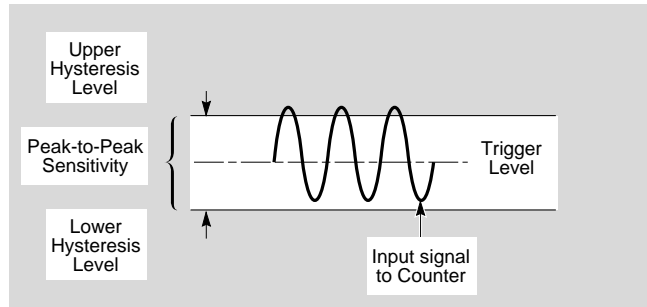

Signal will not generate a count because the trigger level is set below the midpoint of the signal, causing the lower hysteresis level to not be crossed.

The sensitivity specification is given in terms of volts rms for applications that involve measuring a sine wave signal, though it should be noted that a different waveform with the same rms voltage may not trigger a count.

Since the Counter input does not respond to the rms value of the waveform but only to the peak-to-peak value, the sensitivity specification is also given for volts peak-to-peak with a minimum pulse width.

As previously mentioned, the sensitivity of the Counter can be changed by using the **SENSVTY: MED, HI, or LOW** menu choices in the **Trigger/Sensitivity** key menu for optimum sensitivity for certain measurement applications. For example, low sensitivity setting is very useful when measuring noisy signals.

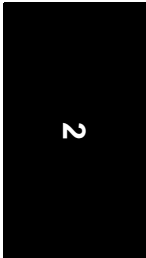

Chapter 2 Operating Your Universal Counter
Using CHANNEL 1 and CHANNEL 2 Input Conditioning Keys

To Use the Trigger/Sensitivity Keys to Adjust Counter's Triggering Level

Example Procedure for Setting Trigger Voltage and Sensitivity Levels

- 1 Connect a signal to channel 1 input, and set up the Counter to measure the frequency of the signal. (Refer to section in this chapter titled "To Measure Frequency" if needed.)
- 2 Press CHANNEL 1 **Trigger/Sensitivity** key.
AUTO TRG: ON is displayed.
- 3 Press any one of the arrow keys to toggle to the auto trigger off mode.
AUTO TRG: OFF is displayed.
- 4 Press **Trigger/Sensitivity** key.
LEVEL: 0.000V is displayed. (Actual value may be different.)
- 5 Suppose you want to set the trigger level to 1V (actual value may be different). Perform the following steps:
 - a. Press the appropriate arrow keys until **LEVEL: 1.000V** is displayed.
 - b. Press **Enter** key.

NOTE

BE SURE to press the Enter key to complete the numeric entry.

The trigger voltage level for channel 1 is now set to 1V as shown in the following figure.

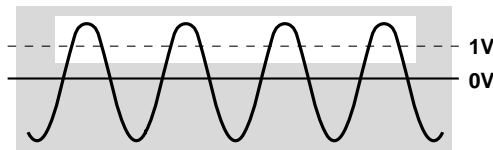

Chapter 2 Operating Your Universal Counter
Using CHANNEL 1 and CHANNEL 2 Input Conditioning Keys

- 6 Press **Trigger/Sensitivity** key.

SLOPE: POS is displayed. The trigger slope is set at positive; thus, the Counter triggers on the rising edge of the input signal as shown in the following figure.

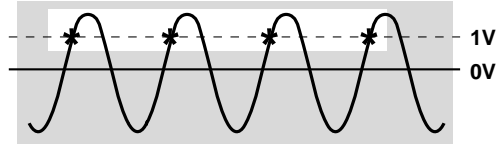

If you want to trigger on the negative (or falling) edge of the input signal, then perform the following step.

- 7 Press any one of the arrow keys until **SLOPE: NEG** is displayed.

The trigger is set at negative; thus, the Counter triggers on the falling edge of the input signal as shown in the following figure.

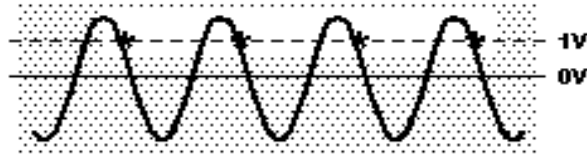

- 8 Press **Trigger/Sensitivity** key to set the input channel sensitivity level.

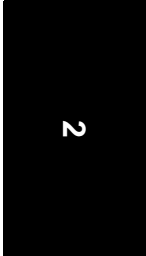

Chapter 2 Operating Your Universal Counter
Using CHANNEL 1 and CHANNEL 2 Input Conditioning Keys

- 9 Press any one of the arrow keys until **SENSTVTY: HI** is displayed.

The Counter's CHANNEL 1 sensitivity is set high as shown in the following figure.

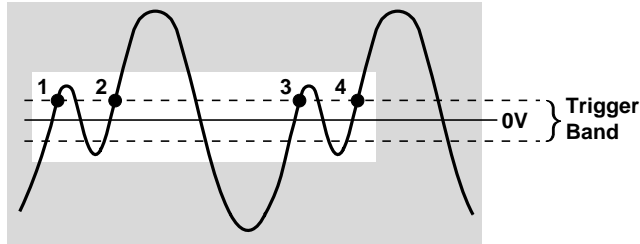

The Counter should now be triggering as determined by the sensitivity level, and displaying the input signal's frequency if the input signal peak-to-peak voltage is large enough for the selected sensitivity level.

The signal must travel completely through the trigger band before a valid trigger is recognized.

- 10 Press any one of the arrow keys until **SENSTVTY: LO** is displayed.

The Counter's CHANNEL 1 sensitivity is set low as shown in the following figure.

Chapter 2 Operating Your Universal Counter
Using CHANNEL 1 and CHANNEL 2 Input Conditioning Keys

Example Procedure for Using Common 1 to Make Time Interval (TI) Measurements on a Single Signal

- 1 Connect a signal to channel 1 of the Counter.
- 2 Press **Time & Period** key until **TI 1 TO 2** is momentarily displayed. (Note that the Time, Ch1, and Ch2 annunciators light.)
- 3 Press **Trigger/Sensitivity** key until **COMMON 1: OFF** is displayed.
- 4 Press any one of the arrow keys until **COMMON 1: ON** is displayed.

When the Counter is operating in Common 1 mode, the signal applied to CHANNEL 1 is used for both start and stop event. The trigger level, slope, and sensitivity for the start signal can be modified by using the CHANNEL 1 input conditioning keys. Whereas, the trigger level, slope, and sensitivity of the stop signal can be modified by using CHANNEL 2 input conditioning keys. (See the figure located at the end of the sub-section of this section titled “Overview of Trigger/Sensitivity Menu.”)

2

Overview of Input Conditioning Toggle Keys

NOTE

Identical functions are available on CHANNEL 1 and CHANNEL 2. The following text describes only CHANNEL 1 functions (as indicated by the “1” in the display) for simplicity.

The toggle keys of the input channels allow you to:

- select 50Ω input impedance or 1 MΩ input impedance for the input channel (**CH 1: 50 OHM**, or **1M OHM**).
- select dc coupling or ac coupling for the input channel (**CH 1: DC**, or **AC**).
- select the attenuation of signals at the input channel. The normal or “no” attenuation state (key indicator OFF) connects the input signal directly to the input amplifier. The X10 state attenuates the input signal by a factor of 10.
- insert a low pass filter into the input channel, which attenuates frequencies above 100 kHz. When the 100 kHz filter is enabled, the key indicator is ON. When the filter is disabled (key indicator OFF), the Counter resumes normal operation over the entire bandwidth (**CH 1: LP FILT**, or **NO FILT**).

Using the Save and Recall Menus



Overview of Save and Recall Functions

The combined use of the Save and Recall functions allows you to save and recall the measurement setups which determine how the Counter measures, analyzes, and reports answers. A setup can include the measurement to be made, the precision desired, offset and scaling factor to apply, limits to be met, and statistics to compute. Setups can also control printing of hardcopy. Setups saved to memory registers are preserved when the Counter is powered down or disconnected from a power source.¹

The Save and Recall functions enable faster and easier operation, fewer operator errors, and minimum training.

The **Save** and **Recall** keys allow you to:

- create and save up to 20 different instrument measurement setups into internal non-volatile memory (**SAVE:**).
- recall up to 20 user-selected measurement setups that were previously saved (**RECALL 1, 2, 3, ... 20**). With a total of 21 save/recall registers, there are 20 registers available to you for save/recall operations. The Counter automatically saves the current setup to register 0 (**RECALL 0**) before executing a recall function.¹
- delete any of the saved setups (**UNSAVE:**).

¹ For firmware revisions 3622 and above, RECALL 0 is stored in volatile memory. RECALL 0 is not preserved if you cycle power.

Chapter 2 Operating Your Universal Counter

Using the Save and Recall Menus

To Use the Save Function

The following step-by-step procedure describes how to SAVE a simple measurement setup to quickly get you familiar with the Save function.

You will SAVE the following in register 1 (**SAVE: 1**):

- the Period measurement function,
- the input conditioning parameters:
 - auto trigger to off
 - trigger level to 1.5V
 - input impedance to 50Ω
 - input coupling to DC

- 1 Cycle **POWER** key to preset the Counter setup.

The Counter is now ready to measure the **frequency** of a signal applied to CHANNEL 1 input as indicated by the **Freq** and **Ch1** annunciators.

- 2 Press **Other Meas** key until **PERIOD 1** is displayed.

The Counter is now ready to measure the **period** of a signal applied to CHANNEL 1 input as indicated by the **Period** and **Ch1** annunciators.

- 3 Press **Trigger/Sensitivity** key.

AUTO TRG: ON is displayed.

- 4 Press any one of the arrow keys.

AUTO TRG: OFF is displayed.

- 5 Press **Trigger/Sensitivity** key, or **Enter** key.

LEVEL: 0.000V is displayed.

- 6 Using the appropriate arrow keys, set the trigger level to 1.5V.

Chapter 2 Operating Your Universal Counter

Using the Save and Recall Menus

- 7 Press **Enter** key to complete the 1.5V entry.
- 8 Press **50Ω/1MΩ** key to set input impedance to 50Ω
- 9 Press **DC/AC** key to set input coupling to DC.
- 10 To save these settings, which make up your measurement setup, simply perform the following steps:
 - a. Press **Save & Print** key.
SAVE: NO is displayed.
 - b. Press the appropriate arrow key until **SAVE: 1** is displayed.
 - c. Press **Enter** key.

The measurement setup is now saved in register 1. To recall this measurement setup, perform the recall procedure in the following section.

To Use the Recall Function

This procedure describes how to RECALL the measurement setup you've saved in the previous procedure.

NOTE

You cannot save a setup to register 0 (**RECALL 0**). The Counter automatically saves the current setup to register 0 before executing a recall function. You can, however, recall the setup in the register 0 if you need to, which is the purpose of this "backup" storage register.

- 1 Cycle **POWER** key to preset the Counter.

Note the Counter is set to measure the **frequency** of a signal applied to channel 1 as indicated by the **Freq** and **Ch1** annunciators.

- 2 Press **Recall** key until **RECALL 1** is displayed, and press **Enter** key or let the Counter time out.

Note that the measurement setup has been recalled as indicated by the **Period** and **Ch1** annunciators, and **50Ω** and **DC** LEDs.

Chapter 2 Operating Your Universal Counter
Using the Save and Recall Menus

To Unsave a Measurement Setup

- 1 To unsave the measurement setup you've saved in the previous procedure, press **Save & Print** key until **UNSAVE: NO** is displayed.
- 2 Press the appropriate arrow keys to select **UNSAVE: 1**, then press **Enter** key.

The measurement setup that was saved in register 1 (**RECALL: 1**) is deleted or unsaved.

ADDITIONAL INFORMATION ABOUT UNSAVE

If the **UNSAVE:** display DOES NOT show up after the **SAVE:** display, then no setups have been saved; all registers are empty.

If **UNSAVE:** display is present in the **Save & Print** key menu, then at least one setup has been saved. (To determine how many setups are saved, continuously press the d key while **UNSAVE: n** is displayed and count the number of registers that are present.) Perform step 2, below, to delete a measurement setup.

- 1 Suppose there are two registers (1 and 2) that have setups saved in them. To remove these setups, perform the following:
 - a. At the **UNSAVE: 1** display, press **Enter** key.
UNSAVE: 2 is displayed, indicating that register 1 has been cleared. To check if the clearing was done, press the d key; the “1” display should not exist.
 - b. At the **UNSAVE: 2** display, press **Enter** key.
All registers are cleared when the **UNSAVE** menu item is NOT present in the **Save & Print** key menu.
- 2 Now, suppose in the previous step (2) you wanted to leave register 1 alone, but you want to delete register 2. Perform the following steps:
 - a. At the **UNSAVE: 1** display, press d key.
UNSAVE: 2 is displayed.
 - b. Press **Enter** key to delete register 2.

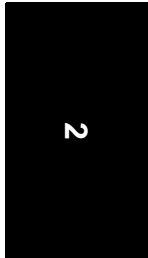

Using the Print Menu



Overview of the Print Menu

The Print menu allows you to:

- enable or disable printing (**PRINT: OFF** or **ON**).
- get help on how to print (**PRINT HELP ?**).

To Use the Print Menu

- 1 Press **Save & Print** key until **PRINT:** is displayed.
- 2 If **PRINT: OFF** is displayed, press any one of the arrow keys to toggle the next state.

PRINT: ON is displayed.

When PRINT is enabled, the Counter displays and prints the results for each measurement. In addition, if **STATS: ON**, all statistics (that is, standard deviation, mean, maximum, and minimum) will be printed.

NOTE

Printing may slow the update rate of the Counter because the Counter may have to wait for the printer.

- 3 Press **Save & Print** key.

PRINT HELP ? is displayed.

- 4 Press **Enter** key.

The instruction “**CONFIGURE PORT ON UTILITY MENU; REMEMBER TO SAVE SETUP FIRST**” is displayed.

- 5 Save your current setup as shown in the section titled “To Use the Save Function.”
- 6 Refer to the section in this chapter titled “To Configure the RS-232 Serial Port for Printing” for information on how to configure and connect the Counter to a printer.

Using the Utility Menu

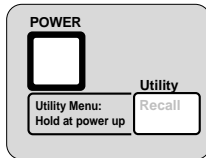

Overview of the Utility Menu

The Utility menu is accessed by holding the **Recall** key and cycling **POWER** key.

The Utility menu allows you to:

- view the firmware revision of your Counter (**REV: n**).
- select and/or display the current GPIB address (**HP-IB: 1, ... 30, or TALK**).
- choose timebase source (**TIMEBAS: AUTO, INT, or EXT**).
- execute several self tests (refer to the paragraph in this section titled “To Run the Self-Test Routines” for details).
- configure the following parameters for the RS-232 port:
 - set the print baud rate (**BAUD: 9600, 19200, 300, 1200, or 2400**).
 - set print parity (**PARITY: OFF, EVEN, or ODD**).
 - set the software pace (**SW PACE: XON or NONE**).
 - set the hardware pace to send data to a serial printer, or to send the Limit-detect output to a computer or controller, via the RS-232 port (**DTR: HIGH, HW PACE, or LIMIT**).
 - change the numerical convention of the Counter’s displayed measurement values. The numeric convention used in the USA separates the integral and fractional portions of a number with a period (a decimal point), and separates groups of three digits in the integer portion with a comma. You can reverse this setting to conform to the numerical convention used in many other countries (**SHOW 9 AS: 9.0 or 9,0**).

Early revisions of the Counter allowed calibration from the Utility menu with **CAL:** menu item. Calibration and the **CAL:** menu item now reside on the Calibration menu; the **CAL HELP?** menu item resides on the Utility menu as a pointer to the Calibration menu.

To Set the GPIB Address

Each device on the GPIB must have a unique address. You can set the Counter's address to any value between 0 and 30. The address is set to "3" when the Counter is shipped from the factory.

Selecting Operating Mode (Talk/Listen, Talk-Only)

The Counter has two GPIB operating modes:

- Addressed (talk/listen)—This mode is for bi-directional communication. The Counter can receive commands and setups from the computer, and can send data and measurement results.

To select the talk/listen operating mode, set the Counter's GPIB address from 0 to 30. Refer to the following sub-section titled "Setting the GPIB Address" for instructions on how to select an GPIB address from the front panel.

- Talk-only—In this mode, the Counter can send data to a printer. It cannot receive commands or setups from the computer.

To select the talk-only operating mode, set the Counter's GPIB mode to "TALK". Refer to the section titled "To Select the GPIB Talk-Only Mode for Printing" for instructions on how to select talk-only operating mode.

Setting the GPIB Address

- 1 Press and hold **Recall (Utility)** key, then cycle **POWER** key.

REV: *n* is displayed; where "n" represents the numeric firmware revision code.

- 2 Press **Recall (Utility)** key until **HP-IB:** is displayed.

HP-IB: **3** is displayed, for example.

- 3 To set the address to 15 (for example), use the appropriate arrow keys to enter the value 15, then press **Enter** key.

NOTE

BE SURE to press the Enter key to complete the numeric entry.

The address is now stored in *non-volatile* memory, and *does not* change when power has been off or after a remote interface reset.

Chapter 2 Operating Your Universal Counter

Using the Utility Menu

To Choose the Timebase Source

- 1 Press and hold **Recall (Utility)** key, then cycle **POWER** key.
- 2 Press **Recall (Utility)** key until **TIMEBAS:** is displayed.
- 3 Press any one of the arrow keys until desired choice (that is, **AUTO**, **INT**, or **EXT**) is displayed.

To Run the Self-Test Routines

Overview of the Self-Test Routines

The Utility menu includes the following three self-test menu items:

- TEST LOOP:
- TST PRINT:
- TEST:

The Counter includes several self-tests. Some self tests are performed at the powerup of the Counter. Some of these self tests can also be invoked from the Utility menu. Other tests can also be invoked from the Utility menu, but a slightly different test is performed. For example, a powerup self test might work regardless of connections to the inputs while a Utility menu self test may require a specific signal to be connected. Some self tests can only be invoked from the Utility menu, for example, the keypad test.

You can specify that the tests should loop forever (**TEST LOOP: ON** or **OFF**) or until any key is pressed.

You can also specify that failure messages be sent to a printer, the RS-232, and the GPIB—if in talk-only (**TST PRINT: ON** or **OFF**).

Chapter 2 Operating Your Universal Counter

Using the Utility Menu

There are 13 choices for the TEST: menu item. They are listed and described in the following text.

- TEST: ALL?** — run all tests, except display, keypad and printer tests.
- DISP?** — illuminate the indicators and vacuum-fluorescent display (VFD) segments. *Note, this test is not available if TEST LOOP: is ON. TEST LOOP: must be OFF.*
- CPU?** — test processor(s).
- ROM?** — checksum the ROM.
- RAM?** — test RAM.
- EEPROM?** — checksum the EEPROM, which is used for non-volatile memory.
- HP-IB?** — test GPIB chip.
- QSPI?** — test serial hardware control loops.
- FPGA?** — internally measure the timebase to test count circuitry.
- FR END?** — check front end circuits, either by swinging trigger levels (during power on test and ALL test) or asking you to connect the timebase output to channels 1 and 2 using a BNC-T connector to split the signal.
- MEAS?** — make a measurement, either by swinging trigger levels (during power on test and ALL test) or asking you to connect the timebase output to channel 1.
- INTERP?** — test interpolators.
- KEYPAD?** — request user to press all keys. *Note, this test is not available if TEST LOOP: is ON. TEST LOOP: must be OFF.*
- PRINT?** — send three test lines to a printer via the RS-232. If in talk-only, also send three test lines to a printer via the GPIB.

Chapter 2 Operating Your Universal Counter

Using the Utility Menu

Example Procedure for Running the Self Test

- 1 Press and hold **Recall (Utility)** key, then cycle **POWER** key.
- 2 Press **Recall (Utility)** key until **TEST:** is displayed.
- 3 Press any one of the arrow keys to select the desired menu choice in the menu item (for example, the **ALL?** menu choice).
- 4 Press **Enter** key to start the test.
- 5 If you are asked to do something, press **Enter** key when you have completed the requested task.

A pass or fail message will be displayed.

To Configure the RS-232 Serial Port for Printing

Software pacing, baud rate, parity, data bits, and stop bits parameters for each port are user-selectable and independent of configuration of the other.

The table below lists the configuration factory-default values for the RS-232 port.

Parameter	Default	Possible Choices	
Software Pacing	XON	XON or NONE	
Baud Rate	9600	300, 1200, 2400, 9600, or 19200	
Parity	NONE	EVEN or ODD ¹	NONE
Data Bits	8	FIXED at 7	FIXED at 8
Stop Bits	1	FIXED	
Full Duplex	ON	ON or OFF	
DTR	HIGH	PACE, HIGH, LIMIT	

¹ When parity is EVEN or ODD, data bits are fixed at 7. When parity is NONE, data bits are fixed at 8.

Chapter 2 Operating Your Universal Counter

Using the Utility Menu

Configuring the RS-232 serial port for printing requires that you:

- set the hardware pacing in the DTR (Data Terminal Ready) menu item,
- turn PRINT:ON in the SAVE&PRINT menu,
- set the baud rate in the BAUD menu item,
- set the parity type in the PARITY menu item, and
- set the software pacing in the SW PACE menu item.

Setting the Hardware Pacing

- 1 Press and hold **Recall (Utility)** key, then cycle **POWER** key.
- 2 Press **Recall (Utility)** key until **DTR:** is displayed.
- 3 Press any one of the arrow keys until the desired hardware pacing is displayed.

NOTE

- Choose **HW PACE** to use the DTR line for pacing. (**CAUTION: You should only choose this option if your printer and cable support DTR handshaking.**)
- Choose **HIGH** to disable hardware pacing.

The Counter's talk-only RS-232 port is now set to be the driver for a RS-232 serial printer. The hardware pacing choice is stored in *non-volatile* memory, and *does not* change when power has been off or after a remote interface reset.

Setting the Baud Rate

You can select one of five baud rates for RS-232 operation. The rate is set to 9600 baud when the Counter is shipped from the factory.

- 1 Press **Recall (Utility)** key until **BAUD:** is displayed.
- 2 Press any one of the arrow keys until the desired baud rate is displayed.

The baud rate is stored in *non-volatile* memory, and *does not* change when power has been off or after a remote interface reset.

Chapter 2 Operating Your Universal Counter

Using the Utility Menu

Setting the Parity

You can select the parity for RS-232 operation. The Counter is configured for parity off when shipped from the factory.

- 1 Press **Recall (Utility)** key until **PARITY:** is displayed.
- 2 Press any one of the arrow keys until the desired parity is displayed.

The parity choice is stored in *non-volatile* memory, and *does not* change when power has been off or after a remote interface reset.

Setting the Software Pace

You can select the software pace for RS-232 operation.

- 1 Press **Recall (Utility)** key until **SW PACE:** is displayed.
- 2 Press any one of the arrow keys until the desired software pacing is displayed.

The software pacing choice is stored in *non-volatile* memory, and *does not* change when power has been off or after a remote interface reset.

To Configure the RS-232 Serial Port for Sending Limit-Detect Output

NOTE

If you cycle power, you will lose everything except saved measurement setups and special parameters stored in non-volatile memory; therefore, make sure you use the Save function of the Counter to retain the measurement setup prior to powering down to set up the Limit-Detect Output line (pin 4) of RS-232 serial connector. Refer to the appropriate section in this chapter for details on how to use Save and Recall.

- 1 To use the Limit-detect output from the serial port, perform the following steps:
 - a. Save your measurement setup that includes your Limit Testing choices, by simply pressing the **Save & Print** key until **SAVE: 1** is displayed, then **Enter** key to save to register 1.
 - b. Turn off the Counter.
 - c. Press and hold **Recall (Utility)** key, then press **POWER** key.
 - d. Press **Recall (Utility)** key until **DTR:** is displayed.
 - e. Press any one of the arrow keys until **DTR: LIMIT** is displayed.
- 2 Press **Run** key.
- 3 Press **Recall (Utility)** key until **RECALL 1** is displayed, then wait a few seconds to recall the measurement setup saved in register 1.

Since your measurement setup included your settings for upper and lower limits, and **LIM TEST:** was set to **ON**, the Counter is now set for limit testing with the Limit-detect output.

If a measurement drifts out of the user-entered limits, the Limit annunciator in the display will light. Also, pin 4 on the RS-232 connector will change state (to a low-voltage RS-232 level) to flag each time a measurement drifts out of the limits. (RS-232 voltage levels swing from $\pm 12V$.)

To Select the Numerical Convention for the Display

- 1 Press and hold **Recall (Utility)** key, then cycle **POWER** key.
- 2 Press **Recall (Utility)** key until **SHOW 9 AS:** is displayed.
- 3 Press any one of the arrow keys until your menu choice is displayed.

If you choose **SHOW 9 AS: 9.0**, the Counter will display a frequency measurement similar to **12.000000001 MHz**, for example. Note that the integral portion (12) is separated from the fractional portion of the number by a *period* (or decimal point). This numerical convention is used in the USA.

If you choose **SHOW 9 AS: 9,0**, the Counter will display a frequency measurement similar to **12,000000001 MHz**, for example. Note that the integral portion (12) is separated from the fractional portion of the number by a *comma*. This numerical convention is used in many other countries.

Your numerical convention choice for the display is stored in *non-volatile* memory, and *does not* change when power has been off or after a remote interface reset.

To Connect the Counter to a Serial Printer via the RS-232 Port

The RS-232 port on the Counter's rear panel is a 9-pin connector (DB-9, male connector). You can connect the Counter to any printer with a properly configured DTE connector (DB-25). You can use a standard Agilent 24542G or 24542H interface cable.

Connect the Counter to a terminal or printer by simply installing an RS-232 cable (such as an AT Printer Cable—Agilent P/N 24542H cable) between the units.

To Connect the Counter to a Printer via GPIB

You can connect the Counter to a printer via GPIB either with or without a computer. If you connect a computer, you can operate the printer under program control. In the absence of a computer, the Counter, when in talk-only, becomes the controller for the printer.

To Select the GPIB Talk-Only Mode for Printing

- 1 Press and hold **Recall (Utility)** key, then cycle **POWER** key.
- 2 Press **Recall (Utility)** key until **HP-IB:** is displayed.
- 3 To set the GPIB to talk-only, press the appropriate arrow keys until **HP-IB: TALK** is displayed.

The TALK choice follows 30 and precedes 0 in the set of choices for the GPIB menu item.

NOTE

BE SURE to press the Enter key to complete the numeric entry.

The talk-only operating mode is now stored in *non-volatile* memory, and *does not* change when power has been off or after a remote interface reset.

Using the Calibration Menu

Overview of the Calibration Menu

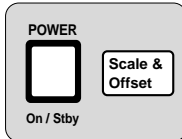

The Calibration menu is accessed by holding the **Scale & Offset** key and cycling the **POWER** key. All of the calibration factors and security settings are stored in *non-volatile* memory, and *do not* change when power has been off or after a remote interface reset.

The security code is set to 53131 or 53132 (corresponding to the model) when the Counter is shipped from the factory. If you forget your security code, you can reset the security code to the model-number default by resetting all of the non-volatile memory to a default state. See the Agilent 53131A/132A Assembly-Level Service Guide for more information.

The Calibration menu allows you to:

- view the calibration security status of the Counter (**CAL SECURE** or **CAL UNSECURE**)
- initiate the Counter's calibration routines, which can perform automatic calibration of the voltage offset and gain of the front-end input amplifiers (**CAL: OFFS 1 / 2 ?**, **GAIN 1 / 2 ?**), of the optional timebase (**CAL: TIMEBAS?**), and of the differences in electrical path-length between channels 1 and 2 (**CAL: TI QUIK?** and **CAL: TI FINE?**)
- secure against calibration by entering the security code while the Counter is unsecured (**CODE:**)
- unsecure for calibration by entering the security code while the Counter is secured (**CODE:**)
- change the security code by entering a new code while the Counter is unsecured (**CODE:**)

Chapter 2 Operating Your Universal Counter

Using the Calibration Menu

- view the calibration count, which indicates the number of times that the Counter has been calibrated (**CAL COUNT?**). The calibration count increments up to a maximum of 32,767 after which it wraps around to 1. A calibration count of 0 indicates that the Counter is completely uncalibrated. (The calibration count is unaffected by interpolator calibration.)
- get Help (**HELP:**) with any of the following:
 - how to calibrate (**CAL?**),
 - how to secure (**SECURE?**), and
 - how to change the code (**CODE?**)

2

NOTE

A good precaution is to use an GPIB program (see the programming example titled “To Read and Store Calibration Data” in Chapter 3 of the Programming Guide) to read and store the calibration factors prior to initiating any calibration.

To View the Calibration Menu and Security Status

The Calibration menu is accessed by holding the Scale & Offset key and cycling the POWER key. The first item in the Calibration menu is a message indicating the calibration security status: **CAL SECURE** or **CAL UNSECURE**.

To Unsecure for Calibration

- 1 Press and hold **Scale & Offset** key, then cycle **POWER** key.

CAL SECURE is displayed.

If **CAL UNSECURE** is displayed, then the Counter is already unsecured for calibration, and the remaining steps are not applicable.

- 2 Press **Scale & Offset** key until **CODE:** is displayed.
- 3 Press the appropriate arrow keys to enter the security code, then press **Enter** key.

CAL UNSECURE is displayed.

To Initiate the Calibration Routines

- 1 Press and hold **Scale & Offset** key, then cycle **POWER** key.
- 2 Unsecure for calibration by performing the preceding procedure.
- 3 Press **Scale & Offset** key until **CAL: OFFS1?** is displayed.
- 4 Press any one of the arrow keys until your calibration choice (that is, **CAL: OFFS2?**, **CAL: GAIN 1?**, **CAL: GAIN 2?**, **CAL: TI QUIK?**, **CAL: TI FINE?**, or **CAL: TIMEBAS?**) is displayed.

Note that the timebase choice (**CAL: TIMEBAS?**) only appears when a Timebase Option is installed.

CAL:TI QUIK? and **CAL:TI FINE?** are two different ways to calibrate out the differences in electrical path length between Channel 1 and Channel 2. When you provide the calibration signal, the instrument measures how the difference in path length translates to an average delay between the two channels.

The Quick Time Interval Calibration requires a simple input signal. You provide on Channel 1 a clean square wave with a rapid rise time and an approximate frequency of 10 MHz. The instrument routes the calibration signal in **COMMON** to both channels 1 and 2, and measures the average delay between the two channels so configured. The advantage of the Quick Calibration is that it is easy, quick, and requires little special equipment. The disadvantage is that the calibration term is best fit for **TI** measurements configured **COMMON** and measured from rising to rising edge; it leaves uncorrected a small systematic error for all other configurations. The Fine Time Interval Calibration minimizes systematic error by calibrating the instrument in each configuration.

The Fine Time Interval Calibration requires a special calibrator signal source to provide input—because it produces eight calibration terms, each tailored to a different combination of input conditions. It requires the synthesizer driving the calibrator to produce a very accurate 10 MHz waveform—because it calibrates the pulse width configuration against the 50-nanosecond pulse width so provided. It minimizes systematic error by calibrating the instrument in each of the eight configurations: falling to falling edges, falling to rising edges, etc., and both **SEPARATE** and **COMMON** routing.

Chapter 2 Operating Your Universal Counter Using the Calibration Menu

- 5 Press **Enter** key to display the setup instructions.

Notes Pertaining to the CAL: TI QUIK?

Advantage: Calibration signal is simple.

Disadvantage: One correction term for all slope and routing configurations.

Input signal: clean square wave, fast rise time, approximately 10 MHz, 1 volt peak-to-peak, no dc offset (oscillating about 0.0 volts), driving 50Ω

Timebase: Any external timebase you provide is ignored during calibration.

Procedure: From the front-panel calibration menu, one keypress invokes the calibration.

Notes Pertaining to the CAL: TI FINE?

Advantage: Calibration minimizes systematic error for any supported combination of input slope and routing.

Disadvantage: Calibration signal is more complex. *If you perform a calibration that you feel is erroneous and do not feel you can perform the fine calibration, perform the CAL: TI QUIK? calibration instead, or restore the calibration factors that you saved prior to starting.*

Equipment: Agilent 8130A Pulse Generator or equivalent.
Agilent 59992A J06 Time Interval Calibrator or equivalent.

Equipment and Counter Setup: See Figure 2-4.

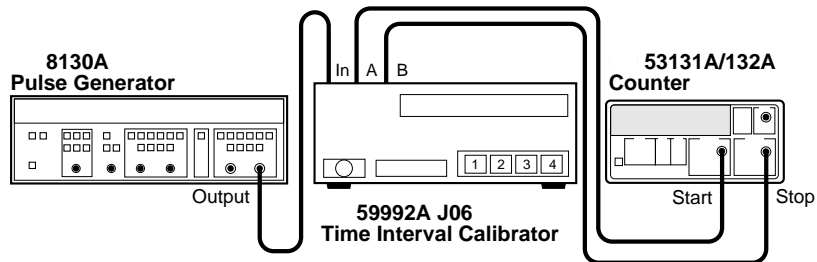

Figure 2-4. Calibration Setup for CAL: TI FINE?

Chapter 2 Operating Your Universal Counter

Using the Calibration Menu

Out of Agilent 8130A, into Agilent 59992A J06 Calibrator Signal:

PERIOD: 100 ns
WIDTH: 50 ns
High: 0.50 V Low: -0.50 V
Input Mode: Normal

Timebase: Any external timebase you provide is ignored during calibration.

Procedure: From the front-panel calibration menu, one keypress invokes the calibration. You are prompted to press buttons on the Agilent 59992A J06 Calibrator for each part of a four-part calibration.

Note that **CAL: TI FINE?** requires the completion of four steps in order.

To Secure Against Calibration

- 1 Press and hold **Scale & Offset** key, then cycle **POWER** key.
CAL UNSECURE is displayed. If **CAL SECURE** is displayed, then the Counter is already secured against calibration and the remaining steps are not applicable.
- 2 Press **Scale & Offset** key until **CODE:** is displayed.
- 3 Press the appropriate arrow keys to enter the security code, then press **Enter** key.
CAL SECURE is displayed.

Chapter 2 Operating Your Universal Counter

Using the Calibration Menu

To Change to a New Security Code

- 1 Press and hold **Scale & Offset** key, then cycle **POWER** key.
- 2 Unsecure for calibration by the using the procedure described in the section titled “To Unsecure for Calibration.”
- 3 Press **Scale & Offset** key until **CODE:** is displayed.
- 4 Press the appropriate arrow keys to enter the new or customized security code, then press **Enter** key.

A scrolling message will appear, indicating what the new code is. For example, the Counter displays the **NEW CODE IS 5** if you entered “5” as the new code.

To View the Calibration Count

- 1 Press and hold **Scale & Offset** key, then cycle **POWER** key.
- 2 Press **Scale & Offset** key until **CAL COUNT?** is displayed.
- 3 Press any one of the entry keys (arrow, +/-, **Enter**) to have a scrolling message appear, indicating what the calibration count is.

Your Counter was calibrated before it left the factory. When you receive your Counter, read the calibration count to determine its initial value.

To Get Help With the Calibration Menu

- 1 Press and hold **Scale & Offset** key, then cycle **POWER** key.
- 2 Press **Scale & Offset** key until **HELP: CAL?** is displayed.
- 3 Press any one of the arrow keys until your help choice (that is, **HELP: CAL?**, **HELP: SECURE?**, **HELP: CODE?**) is displayed.
- 4 Press **Enter** key to display the help information.

Front Panel Display Messages

There are four types of displays:

- Measurement Result Displays
- Power-Up/Self Test Messages
- Menu Messages
- GPIB Messages

Measurement Result Displays

Table 2-4. Measurement Result Displays

Display Message	Probable Cause
NEW TIMEBASE	You have selected the auto reference mode (TIMEBAS: AUTO) and the Counter detected that the external reference became invalid <i>during</i> the measurement. Therefore, the current result is not valid, and the Counter switches to using the internal reference.
NO TIMEBASE	You have selected external reference (TIMEBAS: EXT) and there is no external reference applied to the rear-panel Ref In connector, or the external signal is not an allowed frequency.
¹ INTERP FAIL	Interpolator calibration failed on the last measurement; therefore, no valid measurement was taken.
¹ MEAS FAIL	A measurement calibration failed on the last measurement.
DOING STATS	You have chosen to see a statistics result and the Counter is calculating statistics, but does not have valid statistics results yet.
-----	There is no valid measurement available to display. The Counter may be stopped between measurements while in Single mode, and you need to press the Stop/Single key; or trigger level or input conditioning may need adjustment.

¹ If this condition recurs, your Counter may need servicing.

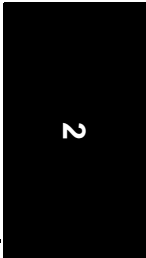

Chapter 2 Operating Your Universal Counter

Front Panel Display Messages

Power-Up/Self Test Messages

The following sequence occurs when you turn on the Counter:

1. All of the vacuum-fluorescent display segments and the indicators (or LEDs) are illuminated for the power-up test.
2. If all tests pass: **SELFTST: PASS** will be displayed (See NOTE below).
3. **HP-IB AT X** will be momentarily displayed (where X represents the GPIB address number), then the Counter will start taking measurements. (**Note:** Earlier versions of the Counter do not display the GPIB address.)

2

NOTE

If there is a failure, each test that fails will display a failure message, and **SELFTST: FAIL** will be displayed. You must press any key in order for the Counter to go on.

Possible individual failure messages are:

FAIL: DISP	display test
FAIL: CPU	processor test
FAIL: ROM	ROM test
FAIL: RAM	RAM test
FAIL: EEPROM	EEPROM test
FAIL: HP-IB	GPIB hardware test
FAIL: QSPI	serial hardware loops test
FAIL: FPGA	count circuit test
FAIL: FR END	front end test
FAIL: MEAS	measurement test
FAIL: INTERP	interpolator test

In addition, the following power-up message may be displayed:

UNCALIBRATED

This means that at least one type of calibration has NOT been performed.

Chapter 2 Operating Your Universal Counter
Front Panel Display Messages

Menu Messages

Table 2-5. Menu Messages

Display Message	Description
(AC COUPLED)	You have selected the VOLT PEAKS function to be measured on a channel which is ac coupled.
BAD CODE	The Counter's calibration is secured and you have entered an incorrect code.
CAL ABORTED	Calibration was aborted because of GPIB or the user pressing a key besides the Enter key.
CAL SECURE	You are in the Calibration menu, and the first menu item indicates that the Counter is secure against calibration.
CAL UNSECURE	You are in the Calibration menu, and the first menu item indicates that the Counter is unsecure for calibration.
CALIBRATING	You have invoked calibration from the Calibration menu item CAL: , and the Counter is currently performing the calibration.
¹ EEPROM FAIL	You have requested that a Counter setting which is stored in the EEPROM (HP-IB: , BAUD: , PARITY: , SW PACE: , DTR: , SHOW 9 AS: , or CAL:) be updated, and a hardware failure has resulted.
GAIN 1 FAIL	You have invoked the GAIN 1 ? choice from the Calibration menu item CAL: , and the calibration failed.
GAIN 1 PASS	You have invoked the GAIN 1 ? choice from the Calibration menu item CAL: , and the calibration passed.
GAIN 2 FAIL	You have invoked the GAIN 2 ? choice from the Calibration menu item CAL: , and the calibration failed.
GAIN 2 PASS	You have invoked the GAIN 2 ? choice from the Calibration menu item CAL: , and the calibration passed.
IN REMOTE	You have pressed a key (other than Local) while in remote.
LOCAL LCKOUT	You have pressed the Local (Save & Print) key while in remote with local lockout.
OFFS 1 FAIL	You have invoked the OFFS 1 ? choice from the Calibration menu item CAL: , and the calibration failed.
OFFS 1 PASS	You have invoked the OFFS 1 ? choice from the Calibration menu item CAL: , and the calibration passed.

Chapter 2 Operating Your Universal Counter
Front Panel Display Messages

Table 2-5. Menu Messages (continued)

Display Message	Description
OFFS 2 FAIL	You have invoked the OFFS 2 ? choice from the Calibration menu item CAL: , and the calibration failed.
OFFS 2 PASS	You have invoked the OFFS 2 ? choice from the Calibration menu item CAL: , and the calibration passed.
NO GATE MENU	You currently have the VOLT PEAKS function selected and requested the Gate & Ext Arm menu.
NO LIM MENU	You currently have the VOLT PEAKS or TOTALIZE function selected and requested the Upper & Lower or Limit Modes menu.
NO MATH MENU	You currently have the VOLT PEAKS or TOTALIZE function selected and requested the Scale & Offset menu.
NO REGISTERS	There are no registers which can be recalled and you selected the Recall menu.
NO STAT MENU	You currently have the VOLT PEAKS or TOTALIZE function selected and requested the Stats menu.
NO TRIG MENU	You currently have the VOLT PEAKS function selected and requested the Trigger/Sensitivity menu.
¹ RECALL FAIL	You have requested the Counter to perform a recall (from the Recall menu) and a hardware failure has resulted.
¹ SAVE FAIL	You have requested the Counter to perform a save (from the Save & Print menu) and a hardware failure has resulted.
TB CAL FAIL	You have invoked the TIMEBAS? choice from the Calibration menu item CAL: , and the calibration failed.
TB CAL PASS	You have invoked the TIMEBAS? choice from the Calibration menu item CAL: , and the calibration passed.
TI CAL FAIL	You have invoked the TI QUIK? or TI FINE? choice from the Calibration menu item CAL: , and the calibration failed.
TI CAL PASS	You have invoked the TI QUIK? or TI FINE? choice from the Calibration menu item CAL: , and the calibration passed.

¹ If this condition recurs, your Counter may need servicing.

Chapter 2 Operating Your Universal Counter
Front Panel Display Messages

GPIB Messages

Table 2-6. GPIB Messages

Display Message	Description
¹ HP-IB +nnnn	You have generated the GPIB error corresponding to the indicated error number. Refer to Chapter 5, "Errors," in the Programming Guide for a list of the error descriptions.
¹ HP-IB -nnn	You have generated the GPIB error corresponding to the indicated error number. Refer to Chapter 5, "Errors," in the Programming Guide for a list of the error descriptions.

¹ +nnnn and -nnn represent GPIB error code numbers that would actually be displayed.

Preset Values After Power-Up and *RST

This section provides separate preset value lists for the Agilent 53131A and the Agilent 53132A with a serial number prefix below 3646 (Table 2-7A) and Agilent 53132A with a serial number prefix of 3646 and above (Table 2-7B) to make it easy for you to differentiate from the counters, which have different arming capabilities for the Time Interval measurements. This section contains the following preset value sections or tables:

- Agilent 53131A (*and Agilent 53132As with serial number prefixes below 3646*) Preset Values for Functions Accessible Via Front Panel or GPIB, *starts on page 2-79.*
- Agilent 53132A (*with serial number prefixes 3646 and above*) Preset Values for Functions Accessible Via Front Panel or GPIB, *starts on page 2-85.*
- Agilent 53131A/132A (*all Agilent 53131As and Agilent 53132As*) Preset Values for Functions Accessible Via GPIB Only, *starts on page 2-91.*

Chapter 2 Operating Your Universal Counter
Preset Values After Power-Up and *RST

**Agilent 53131A (and Agilent 53132A With S/N Prefix Below 3646)
Preset Values for Functions Accessible Via Front Panel or GPIB**

Table 2-7A lists preset values for the Agilent 53131A (and the Agilent 53132A with serial number prefix below 3646).

Table 2-7A. Agilent 53131A (and Agilent 53132A With S/N Prefix Below 3646) Preset Values

Description	In Save/Recall	Value at *RST (GPIB Reset)	Value at Power- Up	In Non-VolatileMe mory
Function-Select Parameters				
Measurement function	yes	FREQ1	FREQ1	no
Frequency, Period, and Ratio Arming Parameters				
Frequency arm	yes	_____	TIME	no
Frequency start arm	yes	IMMediate	_____	no
Frequency stop arm	yes	TIMer	_____	no
Frequency stop arm digits	yes	4	4	no
Frequency gate time	yes	100.E-3s	100.E-3s	no
Frequency ext start arm slope	yes	POS	POS	no
Frequency ext stop arm	yes	_____	AUTO	no
Totalize Arming Parameters				
Totalize arm	yes	_____	TIME	no
Totalize start arm	yes	IMMediate	_____	no
Totalize stop arm	yes	TIMer	_____	no
Totalize gate time	yes	100.E-3s	100.E-3s	no
Totalize ext start arm slope	yes	POS	POS	no
Totalize ext stop arm	yes	_____	EDGE	no

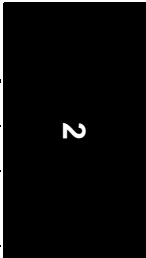

Chapter 2 Operating Your Universal Counter
Preset Values After Power-Up and *RST

Table 2-7A. Agilent 53131A (and Agilent 53132A With S/N Prefix Below 3646) Preset Values

Description	In Save/Recall	Value at *RST (GPIB Reset)	Value at Power- Up	In Non-VolatileMe mory
Phase Arming Parameters				
Phase arm	yes	IMMediate	AUTO	no
Phase ext start arm slope	yes	POS	POS	no
Time Interval, Rise, Fall, Pulse, Dutycycle Arming Parameters				
Time Interval arm	yes	_____	AUTO	no
Time Interval start arm	yes	IMMediate	_____	no
Time Interval ext start arm slope	yes	POS	POS	no
Time Interval Only Arming Parameters				
Time Interval delay enable	yes	_____	OFF	no
Time Interval stop arm	yes	IMMediate	_____	no
Time Interval delay	yes	10.E-3s	10.E-3s	no
Input Coupling Parameters				
Channel 1 input coupling	yes	AC	AC	no
Channel 2 input coupling	yes	AC	AC	no
Input Impedance Parameters				
Channel 1 input impedance	yes	1E+6 Ohms	1E+6 Ohms	no
Channel 2 input impedance	yes	1E+6 Ohms	1E+6 Ohms	no
Input Attenuation Parameters				
Channel 1 input attenuation	yes	X1	X1	no
Channel 2 input attenuation	yes	X1	X1	no

Chapter 2 Operating Your Universal Counter
Preset Values After Power-Up and *RST

Table 2-7A. Agilent 53131A (and Agilent 53132A With S/N Prefix Below 3646) Preset Values

Description	In Save/Recall	Value at *RST (GPIB Reset)	Value at Power- Up	In Non-VolatileMe mory
Display Parameters				
Display blank	no	disabled	disabled	no
Display mode (result/menu)	no	results	results	no
Trigger Level Parameters				
Channel 1 trigger level (volts)	yes	0.000V ¹	0.000V ¹	no
Channel 2 trigger level (volts)	yes	0.000V ¹	0.000V ¹	no
Channel 1 trigger level (percent)	yes	50%	50%	no
Channel 2 trigger level (percent)	yes	50%	50%	no
Trigger Slope Parameters				
Channel 1 trigger slope	yes	POS	POS	no
Channel 2 trigger slope	yes	POS	POS	no
Sensitivity Parameters				
Channel 1 sensitivity	yes	100%	HIGH	no
Channel 2 sensitivity	yes	100%	HIGH	no
Input Routing Parameters				
Input route for Time Interval	yes	SEPARATE	SEPARATE	no
Measurement Control Parameters				
Run/Single selection	yes	SINGLE	RUN²	no
Math Operation Parameters				
Math on/off	yes	OFF	OFF	no
Scale	yes	1.000000	1.000000	no
Offset	yes	0.0000000000	0.0000000000	no

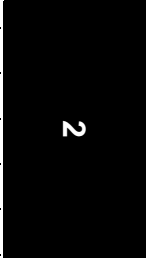

Chapter 2 Operating Your Universal Counter
Preset Values After Power-Up and *RST

Table 2-7A. Agilent 53131A (and Agilent 53132A With S/N Prefix Below 3646) Preset Values

Description	In Save/Recall	Value at *RST (GPIB Reset)	Value at Power- Up	In Non-VolatileMe mory
Limits Parameters				
Limit test on/off	yes	OFF	OFF	no
On fail stop/go on	yes	GO ON	GO ON	no
Lower limit	yes	0.0000000000	0.0000000000	no
Upper limit	yes	0.0000000000	0.0000000000	no
Limit display number/graph	yes	NUMBER	NUMBER	no
Stats Parameters				
Stats on/off	yes	OFF	OFF	no
Stats measurement count, N	yes	100	100	no
Display measurement/stats	yes	MEAS	MEAS	no
Stats use all/in limits	yes	USE ALL	USE ALL	no
On-single measurement count	yes	1 (AUTO OFF)	1 (AUTO OFF)	no
Print Parameters				
Printing on/off	yes	OFF	OFF	no
Timebase Parameters				
Timebase auto/internal/external	no	AUTO	AUTO	no
Expected Frequency Parameters				
Channel 1 expected frequency	no	_____ ³	_____ ³	no
Channel 2 expected frequency	no	_____ ³	_____ ³	no
Channel 3 expected frequency	no	_____ ³	_____ ³	no

2

Chapter 2 Operating Your Universal Counter
Preset Values After Power-Up and *RST

Table 2-7A. Agilent 53131A (and Agilent 53132A With S/N Prefix Below 3646) Preset Values

Description	In Save/Recall	Value at *RST (GPIB Reset)	Value at Power- Up	In Non-VolatileMe mory
Auto-Frequency Parameters				
Channel 1 auto-frequency on/off	no	ON	ON	no
Channel 2 auto-frequency on/off	no	ON	ON	no
Channel 3 auto-frequency on/off	no	ON	ON	no
Trigger Offset Cal Parameters				
Channel 1 trigger offset cal	no	_____4	_____4	yes, (2048)
Channel 2 trigger offset cal	no	_____4	_____4	yes, (2048)
Trigger Gain Cal Parameters				
Channel 1 trigger gain cal	no	_____4	_____4	yes, (1700)
Channel 2 trigger gain cal	no	_____4	_____4	yes, (1700)
Time Interval Offset Cal Parameters				
	no	_____4	_____4	yes, (2100)
Utility Menu Parameters				
Option Timebase cal	no	_____4	_____4	yes, (2048)
GPIB address	no	_____4	_____4	yes,(3)
Digit separator (radix)	no	_____4	_____4	yes, (USA STYLE)
Baud rate, (RS-232)	no	_____4	_____4	yes, (9600)
Parity, (RS-232)	no	_____4	_____4	yes, (OFF)
Pacing, (RS-232)	no	_____4	_____4	yes, (XON)
DTR, (RS-232)	no	_____4	_____4	yes, (DTR_HIGH)



Chapter 2 Operating Your Universal Counter
Preset Values After Power-Up and *RST

Table 2-7A. Agilent 53131A (and Agilent 53132A With S/N Prefix Below 3646) Preset Values

Description	In Save/Recall	Value at *RST (GPIB Reset)	Value at Power- Up	In Non-VolatileMe mory
Calibration Security Parameters				
Secure state	no	_____4	_____4	yes, (SECURE)
Security code	no	_____4	_____4	yes, (53131 or 53132)
Calibration count	no	_____4	_____4	yes, (0)

¹ At power-up, the trigger level is defaulted. The default value is shown in the table. The Counter retains this value until the first auto-trigger cycle runs. Since the Counter powers up on Run mode with auto-trigger ON, the auto-trigger cycle runs almost immediately. The default value is overwritten by a measured result almost immediately.

At *RST, the trigger level variable is defaulted. The default value is shown in the table. Same as for power-up, the Counter retains this value until the first auto-trigger cycle runs. However, on *RST, the Counter is set up in Single mode, (not Run mode), with auto-trigger ON. The auto-trigger cycle runs only on initiation of a measurement. The default value for the variable persists until overwritten by a measured result, but it may be a long time before you request a measurement; therefore, it may be a long time that the default value persists.

² At power-up, you can bring up the Counter either in the Utility menu, or in the results display. The default behavior of the Run/Single variable differs according to that choice.

When the Counter powers up in the result display, it powers up in Run mode and begins making measurements immediately.

The Counter does not make measurements when the Utility menu is selected. (This is to reduce confusion while the user configures major attributes of the instrument.) When you power up on the Utility menu, the Counter is in Single. Upon exit of the Utility menu, the Counter transitions to Run automatically.

³ At *RST and at power-up, this value is undefined. The frequency-estimation routine, ("auto-frequency" routine), is enabled. When you select auto-frequency OFF, and provide a value, the variable takes on that value.

⁴ Fundamental instrument settings are stored in non-volatile RAM. These settings persist even if the Counter is powered down and back up again. They persist if the Counter is reset over GPIB with *RST. You can change these settings, and the changed value is stored so that it is unaffected if the Counter is powered down or reset over GPIB with *RST.

The default values for these special features are indicated in the table. The default values are used when new EPROMs are installed; they remain in effect until you overwrite them.

An example is the trigger calibration setting. Calibration values are defaulted until calibration is performed at the factory. Another example is the RS-232 BAUD rate. BAUD rate is defaulted until you pick a different rate.

Chapter 2 Operating Your Universal Counter
Preset Values After Power-Up and *RST

Agilent 53132A (With S/N Prefix 3646 and Above) Preset Values for Functions Accessible Via Front Panel or GPIB

Table 2-7B lists preset values for the Agilent 53132A (with serial number prefix 3646 and above).

Table 2-7B. Agilent 53132A (S/N 3646 and above) Preset Values

Description	In Save/Recall	Value at *RST (GPIB Reset)	Value at Power-Up	In Non-Volatile Memory
Function-Select Parameters				
Measurement function	yes	FREQ1	FREQ1	no
Frequency, Period, and Ratio Arming Parameters				
Frequency arm	yes	_____	TIME	no
Frequency start arm	yes	IMMediate	_____	no
Frequency stop arm	yes	TIMer	_____	no
Frequency stop arm digits	yes	4	4	no
Frequency gate time	yes	100.E-3s	100.E-3s	no
Frequency ext start arm slope	yes	POS	POS	no
Frequency ext stop arm	yes	_____	AUTO	no
Totalize Arming Parameters				
Totalize arm	yes	_____	TIME	no
Totalize start arm	yes	IMMediate	_____	no
Totalize stop arm	yes	TIMer	_____	no
Totalize gate time	yes	100.E-3s	100.E-3s	no
Totalize ext start arm slope	yes	POS	POS	no
Totalize ext stop arm	yes	_____	EDGE	no
Phase Arming Parameters				
Phase arm	yes	IMMediate	AUTO	no
Phase ext start arm slope	yes	POS	POS	no

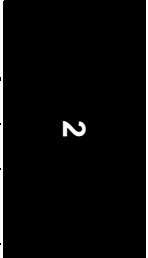

Chapter 2 Operating Your Universal Counter
Preset Values After Power-Up and *RST

Table 2-7B. Agilent 53132A (S/N 3646 and above) Preset Values (continued)

Description	In Save/Recall	Value at *RST (GPIB Reset)	Value at Power- Up	In Non-Volatile Memory
Pulse, Rise, Fall, Duty-cycle Arming Parameters				
Pulse Arming Parameters				
Pulse start arm	yes	IMMEDIATE	AUTO	no
Pulse ext start arm slope	yes	POS	POS	no
Time Interval Arming Parameters				
Time Interval start arm	yes	IMMEDIATE	AUTO	no
Time Interval ext start arm slope	yes	POS	POS	no
Time Interval start arm delay	yes	IMMEDIATE	NONE	no
Time Interval start arm delay time	yes	100 E-9s	100 E-9s	no
Time Interval start arm delay events	yes	1	1	no
Time Interval stop arm	yes	IMMEDIATE	AUTO	no
Time Interval ext stop arm slope	yes	POS	POS	no
Time Interval stop arm delay	yes	IMMEDIATE	NONE	no
Time Interval stop arm delay time	yes	100 E-9s	100 E-9s	no
Time Interval stop arm delay events	yes	1	1	no
Input Coupling Parameters				
Channel 1 input coupling	yes	AC	AC	no
Channel 2 input coupling	yes	AC	AC	no
Input Impedance Parameters				
Channel 1 input impedance	yes	1E+6 Ohms	1E+6 Ohms	no
Channel 2 input impedance	yes	1E+6 Ohms	1E+6 Ohms	no
Input Attenuation Parameters				no
Channel 1 input attenuation	yes	X1	X1	no

Chapter 2 Operating Your Universal Counter
Preset Values After Power-Up and *RST

Table 2-7B. Agilent 53132A (S/N 3646 and above) Preset Values (continued)

Description	In Save/Recall	Value at *RST (GPIB Reset)	Value at Power- Up	In Non-Volatile Memory
Channel 2 input attenuation	yes	X1	X1	no
Display Parameters				
Display blank	no	disabled	disabled	no
Display mode (result/menu)	no	results	results	no
Trigger Level Parameters				
Channel 1 trigger level (volts)	yes	0.000V ¹	0.000V ¹	no
Channel 2 trigger level (volts)	yes	0.000V ¹	0.000V ¹	no
Channel 1 trigger level (percent)	yes	50%	50%	no
Channel 2 trigger level (percent)	yes	50%	50%	no
Trigger Slope Parameters				
Channel 1 trigger slope	yes	POS	POS	no
Channel 2 trigger slope	yes	POS	POS	no
Sensitivity Parameters				
Channel 1 sensitivity	yes	100%	HIGH	no
Channel 2 sensitivity	yes	100%	HIGH	no
Input Routing Parameters				
Input route for Time Interval	yes	SEPARATE	SEPARATE	no
Measurement Control Parameters				
Run/Single selection	yes	SINGLE	RUN ²	no
Math Operation Parameters				
Math on/off	yes	OFF	OFF	no
Scale	yes	1.000000	1.000000	no
Offset	yes	0.0000000000	0.0000000000	no

2

Chapter 2 Operating Your Universal Counter
Preset Values After Power-Up and *RST

Table 2-7B. Agilent 53132A (S/N 3646 and above) Preset Values (continued)

Description	In Save/Recall	Value at *RST (GPIB Reset)	Value at Power- Up	In Non-Volatile Memory
Limits Parameters				
Limit test on/off	yes	OFF	OFF	no
On fail stop/go on	yes	GO ON	GO ON	no
Lower limit	yes	0.0000000000	0.0000000000	no
Upper limit	yes	0.0000000000	0.0000000000	no
Limit display number/graph	yes	NUMBER	NUMBER	no
Stats Parameters				
Stats on/off	yes	OFF	OFF	no
Stats measurement count, N	yes	100	100	no
Display measurement/stats	yes	MEAS	MEAS	no
Stats use all/in limits	yes	USE ALL	USE ALL	no
On-single measurement count	yes	1 (AUTO OFF)	1 (AUTO OFF)	no
Print Parameters				
Printing on/off	yes	OFF	OFF	no
Timebase Parameters				
Timebase auto/internal/external	yes	AUTO	AUTO	no
Expected Frequency Parameters				
Channel 1 expected frequency	no	_____ ³	_____ ³	no
Channel 2 expected frequency	no	_____ ³	_____ ³	no
Channel 3 expected frequency	no	_____ ³	_____ ³	no
Auto-Frequency Parameters				
Channel 1 auto-frequency on/off	no	ON	ON	no
Channel 2 auto-frequency on/off	no	ON	ON	no
Channel 3 auto-frequency on/off	no	ON	ON	no

2

Chapter 2 Operating Your Universal Counter
Preset Values After Power-Up and *RST

Table 2-7B. Agilent 53132A (S/N 3646 and above) Preset Values (continued)

Description	In Save/Recall	Value at *RST (GPIB Reset)	Value at Power-Up	In Non-Volatile Memory
Trigger Offset Cal Parameters				
Channel 1 trigger offset cal	no	_____4	_____4	yes, (2048)
Channel 2 trigger offset cal	no	_____4	_____4	yes, (2048)
Trigger Gain Cal Parameters				
Channel 1 trigger gain cal	no	_____4	_____4	yes, (1700)
Channel 2 trigger gain cal	no	_____4	_____4	yes, (1700)
Time Interval Offset Cal Parameters				
	no	_____4	_____4	yes, (2100)
Utility Menu Parameters				
Option Timebase cal	no	_____4	_____4	yes, (2048)
GPIB address	no	_____4	_____4	yes, (3)
Digit separator (radix)	no	_____4	_____4	yes, (USA STYLE)
Baud rate, (RS-232)	no	_____4	_____4	yes, (9600)
Parity, (RS-232)	no	_____4	_____4	yes, (OFF)
Pacing, (RS-232)	no	_____4	_____4	yes, (XON)
DTR, (RS-232)	no	_____4	_____4	yes, (DTR_HIGH)
Calibration Security Parameters				
Secure state	no	_____4	_____4	yes, (SECURE)
Security code	no	_____4	_____4	yes, (53131 or 53132)
Calibration count	no	_____4	_____4	yes, (0)

¹ At power-up, the trigger level is defaulted. The default value is shown in the table. The Counter retains this value until the first auto-trigger cycle runs. Since the Counter powers up on Run mode with auto-trigger ON, the auto-trigger cycle runs almost immediately. The default value is overwritten by a measured result almost immediately.

At *RST, the trigger level variable is defaulted. The default value is shown in the table. Same as for power-up,

Chapter 2 Operating Your Universal Counter

Preset Values After Power-Up and *RST

the Counter retains this value until the first auto-trigger cycle runs. However, on *RST, the Counter is set up in Single mode, (not Run mode), with auto-trigger ON. The auto-trigger cycle runs only on initiation of a measurement. The default value for the variable persists until overwritten by a measured result, but it may be a long time before you request a measurement; therefore, it may be a long time that the default value persists.

- ² At power-up, you can bring up the Counter either in the Utility menu, or in the results display. The default behavior of the Run/Single variable differs according to that choice.

When the Counter powers up in the result display, it powers up in Run mode and begins making measurements immediately.

The Counter does not make measurements when the Utility menu is selected. (This is to reduce confusion while the user configures major attributes of the instrument.) When you power up on the Utility menu, the Counter is in Single. Upon exit of the Utility menu, the Counter transitions to Run automatically.

- ³ At *RST and at power-up, this value is undefined. The frequency-estimation routine, ("auto-frequency" routine), is enabled. When you select auto-frequency OFF, and provide a value, the variable takes on that value.

- ⁴ Fundamental instrument settings are stored in non-volatile RAM. These settings persist even if the Counter is powered down and back up again. They persist if the Counter is reset over GPIB with *RST. You can change these settings, and the changed value is stored so that it is unaffected if the Counter is powered down or reset over GPIB with *RST.

The default values for these special features are indicated in the table. The default values are used when new EPROMs are installed; they remain in effect until you overwrite them.

An example is the trigger calibration setting. Calibration values are defaulted until calibration is performed at the factory. Another example is the RS-232 BAUD rate. BAUD rate is defaulted until you pick a different rate.

Chapter 2 Operating Your Universal Counter
Preset Values After Power-Up and *RST

Preset Values for Functions Accessible Via GPIB Only

Table 2-8. Agilent 53131A/132A Preset Values—Accessible Via GPIB Only

Description	In Save/Recall	Value at *RST (GPIB Reset)	Value at Power- Up	In Non-Volatile Memory
Arming Parameters				
Frequency ext stop arm slope	yes	NEG	NEG	no
Totalize ext stop arm slope	yes	NEG	NEG	no
Math, Limit Parameters				
Math, limit-test recalculate	yes	OFF	ON	no
Reset limit-test fail count on INITiate	yes	ON	ON	no
Statistics Parameters				
Statistics type	yes	MEAN	MEAN	no
Miscellaneous Measurement Parameters				
Monitor external timebase	no	TRUE	TRUE	no
Interpolator calibration on/off	no	ON	ON	no
Status Reporting Parameters				
Event status enable	no	_____	0	no
Service request enable	no	_____	0	no
OSR enable	no	_____	0	no
OSR negative transition filter	no	_____	0	no
OSR positive transition filter	no	_____	1809	no
QSR enable	no	_____	0	no
QSR positive transition filter	no	_____	18277	no
QSR negative transition filter	no	_____	0	no
Error queue	no	_____	cleared	no

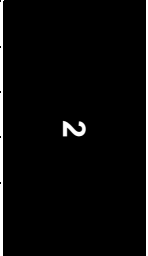

Chapter 2 Operating Your Universal Counter
Preset Values After Power-Up and *RST

Table 2-8. Agilent 53131A/132A Preset Values—Accessible Via GPIB Only (continued)

Description	In Save/Recall	Value at *RST (GPIB Reset)	Value at Power- Up	In Non-Volatile Memory
Miscellaneous GPIB Parameters				
Response format	yes	ASCIi	ASCIi	no
Device trigger definition	yes	INIT	INIT	no
Macros	no	disabled	disabled	no
CONFigure? response	no	_____	undefined	no
READ, FETCh function memory	no	_____	_____	no

Summary of the Measurement Sequence

Use **Utility** menu to:

- choose the timebase source.
- configure the GPIB if you intend to operate the Counter remotely.
- set RS-232 serial port if you intend for the Counter to perform printing and/or limit-detecting.

Use **MEASURE** menu keys to select the measurement function.

Use **CHANNELs 1** and **2** keys to set up input conditioning.

Use **Gate & ExtArm** key to:

- set the gate time and resolution.
- set arming.

Use **Scale & Offset** key to set up math operations.

Use **Uppr & Lower** key to set limits.

Use **Limit Modes** key to set up limit testing.

Use **Stats** key to set up statistics and limit filtering.

Use **Save & Print** key to enable or disable printing.

Use **Run** and **Stop/Single** keys to control measurements.

Common Questions

Why is Stats result not available yet?

Your Counter has not completed N measurements yet.

Why won't printer work?

Go to the Utility menu and set up serial port.

Why did Counter stop measuring?

- Did you set the Counter to stop on limits?
- Are all measurements outside the limits?

Why did Counter go to its default state after I set up my RS-232 port?

- Did you save your state before you cycled power?
- Did you restore your state after configuring the port?

Counter's numeric display does not follow the numerical convention for my country.

- Go to the Utility menu and change the numerical convention to be displayed (use the **SHOW 9 AS:** menu item).

How do I display the 13th digit in my numerical result?

- Use the Offset feature. Instructions appear on page 2-31 and page 2-32 in the section titled "Using the MATH Menu Keys."

3

Specifications

Chapter 3 Specifications

Instrument Inputs

Introduction

The specifications of the Agilent 53131A/132A Universal Counter are provided in this chapter.

Instrument Inputs

Channel 1 & 2 Input Specifications¹

Frequency Range

DC Coupled:	DC to 225 MHz
AC Coupled:	1 MHz to 225 MHz (50 Ω) 30 Hz to 225 MHz (1 M Ω)
FM Tolerance:	25%

Voltage Range and Sensitivity (Sinusoid)²

DC to 100 MHz:	20 mVrms to ± 5 V ac + dc (75 mVrms with optional rear connectors) ³
100 MHz to 200 MHz:	30 mVrms to ± 5 V ac + dc (75 mVrms with optional rear connectors) ³
200 MHz to 225 MHz:	40 mVrms to ± 5 V ac + dc (75 mVrms with optional rear connectors) ³

Voltage Range and Sensitivity (Single-Shot Pulse)²

4.5 ns to 10 ns Pulse Width:	100 mVpp to 10 Vpp (150 mVpp with optional rear connectors) ³
>10 ns Pulse Width:	50 mVpp to 10 Vpp (100 mVpp with optional rear connectors) ³

Trigger Level²

Range:	± 5.125 V
Accuracy:	$\pm (15$ mV + 1% of trigger level)
Resolution:	5 mV

Damage Level

0 to 3.5 kHz, 50 Ω	5 Vrms
0 to 3.5 kHz, 1 M Ω	350 V dc + ac pk
3.5 kHz to 100 kHz, 1 M Ω	350 V dc + ac pk linearly derated to 5 Vrms
>100 kHz, 1 M Ω	5 Vrms

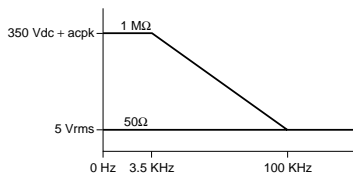

¹ Specifications and Characteristics for Channels 1 and 2 are identical for both Common and Separate configurations.

² Values shown are for X1 attenuator setting. Multiply all values by 10 (nominal) when using the X10 attenuator setting. Note that it may be necessary to recalibrate the input offset in the application environment (especially at high temperature) to achieve maximum sensitivity.

³ When ordered with optional rear terminals, the Channel 1 and 2 inputs are active on both the front and rear of the universal counter though the specifications provided only apply to the rear terminals. Performance for the front terminals is degraded, but may be improved by terminating the rear terminals into 50 Ω .

Channel 1 & 2 Input Characteristics¹

Impedance:	1 M Ω or 50 Ω
1 M Ω Capacitance:	30 pF
Coupling:	AC or DC
Low-Pass Filter:	100 kHz (or disabled) -20 dB at > 1 MHz
Input Sensitivity:	Selectable between Low, Medium, or High (default). Low is approximately 2x High Sensitivity.

Trigger Slope:

Positive or Negative

Auto Trigger Level

Range:	0 to 100% in 10% steps
Frequency:	> 100 Hz
Input Amplitude:	> 100 mVpp (No amplitude modulation)

Attenuator

Voltage Range:	x10
Trigger Range:	x10

Chapter 3 Specifications
Instrument Inputs (Continued)

Instrument Inputs (Continued)

Channel 3 Input Specifications^{4, 5}

Frequency Range

Option 030	100 MHz to 3 GHz
Option 050	200MHz to 5 GHz
Option 124	200 MHz to 12.4 GHz

Power Range and Sensitivity (Sinusoid)

Option 030

100 MHz to 2.7 GHz:	-27 dBm to +19 dBm
2.7 GHz to 3 GHz:	-21 dBm to +13 dBm

Option 050

200 MHz to 5 GHz:	-23 dBm to +13 dBm
-------------------	--------------------

Option 124

200 MHz to 12.4 GHz	-23 dBm to +13 dBm
---------------------	--------------------

Damage Level:

Option 030	5 Vrms
Option 050	+25 dBm
Option 124	+25 dBm

External Arm Input Specifications

Signal Input Range:

TTL compatible⁶

Timing Restrictions:

Pulse Width:	> 50 ns
Transition Time:	< 250 ns
Start-to-Stop Time:	> 50 ns

Damage Level: 10 Vrms

Channel 3 Input Characteristics

Impedance:	50 Ω
Coupling:	AC
VSWR:	< 2.5:1

External Arm Input Characteristics

Impedance:	1 kΩ
Input Capacitance:	17 pF
Start Slope:	Positive or Negative
Stop Slope:	Positive or Negative

Notes:

External Arm is available for all measurements except Peak Volts.

External Arm is referred to as External Gate for some measurements.

⁴ Channel 3 is available as an option.

⁵ When ordered with optional rear terminals, the Channel 3 connector on the front panel for Option 030 will be routed to the rear panel (rear panel only). There is no degradation in specifications for this input. Option 050 and Option 124 input connectors are available on the front panel only.

⁶ 53131A—Applies to Serial Number Prefix 3710A and above.
 53132A—Applies to Serial Number Prefix 3546A and above.

Below these Serial Number Prefixes, the specification is :

High-level input:	>3.0 V
Low-level input:	<1.5 V.

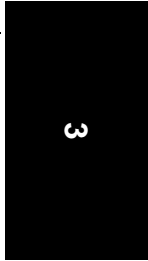

Chapter 3 Specifications
Time Base

Time Base

Internal Time Base Stability

	Standard (0° to 50° C)	Medium Stability Oven (Option 001)	High Stability Oven (Option 010)	Ultra High Stability Oven (Option 012)
Temperature Stability: (referenced to 25° C)	$< 5 \times 10^{-6}$	$< 2 \times 10^{-7}$	$< 2.5 \times 10^{-9}$	$< 2.5 \times 10^{-9}$
Aging Rate (after 30 days) Per Day: Per Month: Per Year:	$< 3 \times 10^{-7}$	$< 4 \times 10^{-8}$ $< 2 \times 10^{-7}$	$< 5 \times 10^{-10}$ $< 1.5 \times 10^{-8}$	$< 1 \times 10^{-10}$ $< 3 \times 10^{-9}$ $< 2 \times 10^{-8}$
Turn-on stability vs. time: (in 30 minutes)		$< 2 \times 10^{-7}$ (referenced to 2 hours)	$< 5 \times 10^{-9}$ (referenced to 24 hours)	$< 5 \times 10^{-9}$ (referenced to 24 hours)
Calibration:	Manual Adjust	Electronic	Electronic	Electronic

Note that power to the time base is maintained when the counter is placed in standby via the front panel switch. The internal fan will continue to operate under this condition, to maintain long-term instrument reliability.

External Time Base Input Specifications

Voltage Range: 200 mVrms to 10 Vrms
 Damage Level: 10 Vrms

External Time Base Input Characteristics

Threshold: 0 V
 Impedance: 1 kΩ
 Input Capacitance: 23 pF
 Frequency (53131A): 1 MHz, 5 MHz or 10 MHz
 (automatic selection)
 Frequency (53132A): 10 MHz

Internal vs. External Time Base Selection:

Manual: Select Internal or External
 Automatic: Internal used when External not present
 (default)

Time Base Output Specifications

Output Frequency: 10 MHz
 Voltage: > 1 Vpp into 50 Ω
 (centered around 0 V)

Chapter 3 Specifications
Measurement Specifications

Measurement Specifications

Frequency, Period

Channel 1 and 2 Range: 0.1 Hz to 225 MHz 4.44 ns to 10 s

Channel 3 Range:

Option 030	100 MHz to 3 GHz	0.33 ns to 10 ns
Option 050	200 MHz to 5 GHz	0.2 ns to 5 ns
Option 124	200 MHz to 12.4 GHz	80 ps to 5 ns

(Period 2 or 3 selectable only via the GPIB interface)

For Automatic or External Arming:

(and signals < 100 Hz using Timed Arming)

LSD Displayed:

$$\left(\frac{t_{res}}{Gate\ Time} \right) \times \begin{matrix} Frequency \\ or \\ Period \end{matrix}$$

RMS Resolution:

$$\left(\frac{\sqrt{t_{res}^2 + (2 \times Trigger\ Error)^2}}{Gate\ Time} \right) \times \begin{matrix} Frequency \\ or \\ Period \end{matrix}$$

	Agilent 53131A	Agilent 53132A
	t_{res}	t_{res}
typical	650 ps	200 ps
see graphs for worst case resolution performance		

For Automatic Arming: $Gate\ Time = \frac{N}{Frequency}$

where $N =$ 1 for Ch1 or Ch2 Frequency < 1 MHz
4 for Ch1 or Ch2 Frequency > 1 MHz
128 for Ch3

Systematic Uncertainty: $\left(\pm Time\ Base\ Error \pm \frac{t_{acc}}{Gate\ Time} \right) \times \begin{matrix} Frequency \\ or \\ Period \end{matrix}$

	Agilent 53131A	Agilent 53132A
	t_{acc}	t_{acc}
typical	350 ps	100 ps
worst case	1.25 ns	500 ps

Trigger: Default setting is Auto Trigger at 50%

For Time or Digits Arming:

LSD Displayed:

$$\left(\frac{2\sqrt{2} \times t_{res}}{Gate\ Time \times \sqrt{Number\ or\ Samples}} + \frac{t_{jitter}}{Gate\ Time} \right) \times \begin{matrix} Frequency \\ or \\ Period \end{matrix}$$

RMS Resolution:

$$\left(\frac{4 \times \sqrt{t_{res}^2 + 2 \times Trigger\ Error^2}}{Gate\ Time \times \sqrt{Number\ or\ Samples}} + \frac{t_{jitter}}{Gate\ Time} \right) \times \begin{matrix} Frequency \\ or \\ Period \end{matrix}$$

	Agilent 53131A		Agilent 53132A	
	t_{res}	t_{jitter}	t_{res}	t_{jitter}
typical	500 ps	50 ps	225 ps	3 ps
see graphs for worst case resolution performance				

$Number\ of\ Samples =$
 $\frac{Gate\ Time \times Frequency}{Gate\ Time \times 200,000}$ (Frequency < 200 kHz)
(Frequency > 200 kHz)

Systematic Uncertainty: $\left(\pm Time\ Base\ Error \pm \frac{t_{acc}}{Gate\ Time} \right) \times \begin{matrix} Frequency \\ or \\ Period \end{matrix}$

	Agilent 53131A	Agilent 53132A
	t_{acc}	t_{acc}
typical	100 ps	10 ps
worst case	300 ps	100 ps

Trigger: Default setting is Auto Trigger at 50%

The following graphs may also be used to compute errors for Period Measurements. To find the Period error (ΔP), calculate the frequency of the input signal ($F = \frac{1}{P}$) and find the frequency error (ΔF) from the chart. Then, calculate the period error as: $\Delta P = \left(\frac{\Delta F}{F} \right) \times P$

Chapter 3 Specifications
Measurement Specifications (Continued)

Measurement Specifications (Continued)

Agilent 53131A—Worst Case RMS Resolution

Automatic or External Arming:

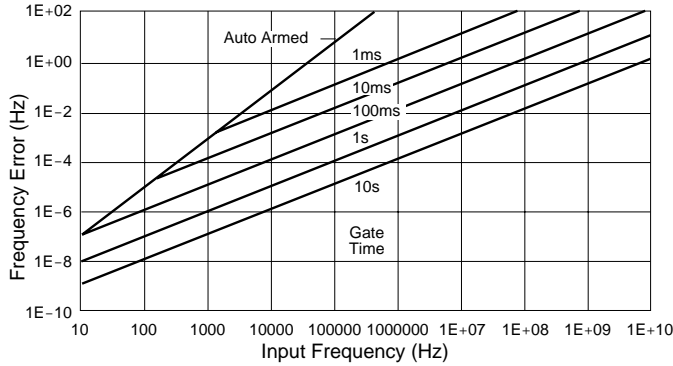

Time or Digit Arming:

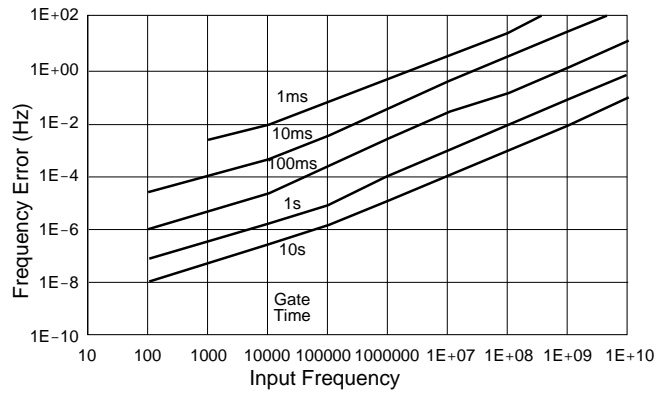

The preceding graphs do not reflect the effects of trigger error. To place an upper bound on the added effect of this error term, determine the frequency error from the appropriate graph and add a trigger error term as follows:

<p>Automatic or External Arming</p> $\text{Frequency Error} + \left(\frac{\sqrt{2} \times \text{Trigger Error}}{\text{Gate Time}} \right) \times \frac{\text{Frequency}}{\text{or Period}}$	<p>Time or Digit Arming</p> $\text{Frequency Error} + \left(\frac{4 \times \sqrt{2} \times \text{Trigger Error}}{\text{Gate Time} \times \sqrt{\text{Number of Samples}}} \right) \times \frac{\text{Frequency}}{\text{or Period}}$
---	---

Chapter 3 Specifications
Measurement Specifications (Continued)

Measurement Specifications (Continued)

Agilent 53132A—Worst Case RMS Resolution

Automatic or External Arming:

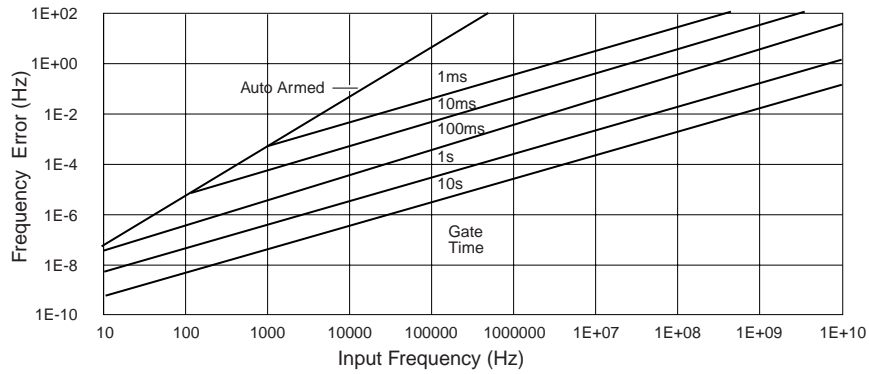

Time or Digit Arming:

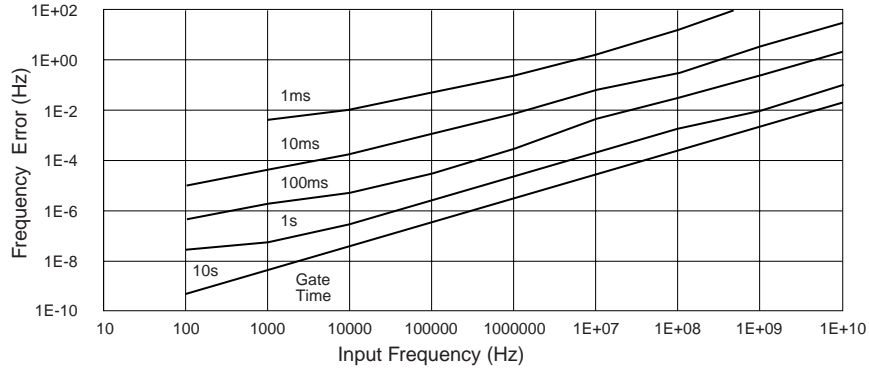

The preceding graphs do not reflect the effects of trigger error. To place an upper bound on the added effect of this error term, determine the frequency error from the appropriate graph and add a trigger error term as follows:

Time or Digit Arming

$$\text{Frequency Error} + \left(\frac{4 \times \sqrt{2} \times \text{Trigger Error}}{\text{Gate Time} \times \sqrt{\text{Number of Samples}}} \right) \times \begin{matrix} \text{Frequency} \\ \text{or} \\ \text{Period} \end{matrix}$$

Automatic or External Arming

$$\text{Frequency Error} + \left(\frac{\sqrt{2} \times \text{Trigger Error}}{\text{Gate Time}} \right) \times \begin{matrix} \text{Frequency} \\ \text{or} \\ \text{Period} \end{matrix}$$

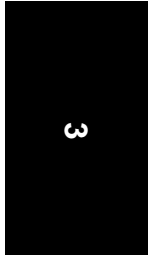

Chapter 3 Specifications
Measurement Specifications (Continued)

Measurement Specifications (Continued)

Frequency Measurement Example:

Given an Agilent 53132A with a High Stability Oven that was calibrated 3 days ago, measure a 15 MHz square wave signal (which has negligible trigger error) with a 1 second gate time. Compute the measurement error to within 2-sigma confidence.

Measurement Error = Systematic Uncertainty ± 2 × RMS Resolution

$$= \left(\left(\pm \text{Time Base Error} \pm \frac{t_{acc}}{\text{Gate Time}} \right) \pm 2 \times \left(\frac{4 \times \sqrt{t_{res}^2 + (2 \times \text{Trigger Error})^2}}{\text{Gate Time} \times \sqrt{\text{Number of Samples}}} + \frac{t_{jitter}}{\text{Gate Time}} \right) \right) \times \text{Frequency}$$

Number of Samples = 200,000 since Frequency is greater than 200kHz and gate time equals 1 second

Time Base Error = Temperature Stability + 3 Days × Daily Aging Rate

$$= 2.5 \times 10^{-9} + 3 \times (5 \times 10^{-10})$$

$$= 4.0 \times 10^{-9}$$

$$\text{Measurement Error} = \left(\left(\pm 4.0 \times 10^{-9} \pm \frac{1 \times 10^{-11} \text{ s}}{1 \text{ s}} \right) \pm 2 \times \left(\frac{4 \times \sqrt{(225 \times 10^{-12} \text{ s})^2 + (2 \times 0)}}{1 \text{ s} \times \sqrt{200,000}} + \frac{3 \times 10^{-12} \text{ s}}{1 \text{ s}} \right) \right) \times 15 \text{ MHz}$$

$$= (\pm 4.0 \times 10^{-9} \pm 2 \times (2.01 \times 10^{-12} + 3 \times 10^{-12})) \times 15 \text{ MHz}$$

$$= (\pm 4.0 \times 10^{-9} \pm 1 \times 10^{-11}) \times 15 \text{ MHz}$$

$$= \pm 60.2 \text{ mHz}$$

Which is to say that the Agilent 53132A would display results in the range 15 MHz ± 60.2 mHz. Note however that the dominant error is the Time Base Error. If an even higher stability time base is available or if the instrument can be source locked to the 15 MHz signal, then this error term can be substantially reduced. The measurement resolution under these conditions is ± 75 μHz (1 sigma) which determines the number of digits displayed.

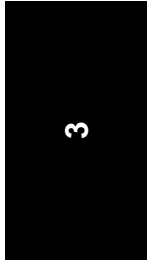

Chapter 3 Specifications
Measurement Specifications (Continued)

Measurement Specifications (Continued)

Time Interval

Measurement is specified over the full signal ranges⁷ of Channels 1 and 2.

Results Range: -1 ns to 10⁵ s

LSD:

53131A	53132A
500 ps	150 ps

RMS Resolution: $\sqrt{t_{res}^2 + \text{Start Trigger Error}^2 + \text{Stop Trigger Error}^2}$
 t_{res}

53131A	53132A
750 ps	300 ps

Systematic Uncertainty: $\pm(\text{Time Base Error} \times TI) \pm \text{Trigger Level Timing Error} \pm 1.5 \text{ ns Differential Channel Error (Agilent 53131A)}$
 $\pm 900 \text{ ps Differential Channel Error (Agilent 53132A)}$

Time Interval Delay

After a Time Interval Measurement has begun by satisfying the trigger conditions on Channel 1, the instrument will wait for the user-entered delay time to elapse before the end-of-measurement trigger will be accepted on Channel 2. Please refer to Measurement Arming for additional information.

Frequency Ratio: $\frac{\text{Ch2}}{\text{Ch1}}$ $\frac{\text{Ch1}}{\text{Ch3}}$ $\frac{\text{Ch2}}{\text{Ch1}}$ $\frac{\text{Ch3}}{\text{Ch1}}$

Measurement is specified over the full signal range of each input.

Results Range: 10⁻¹⁰ to 10¹¹

'Auto' Gate Time: 100 ms (or sufficient cycles on Channel 2 or 3 to make a valid measurement, whichever is longer)

LSD:

$$\text{Ratio } 1/2 : \frac{1}{\text{Ch2 Freq} \times \text{Gate Time}}$$

$$\text{Ratio } 1/3 : \frac{1}{\text{Ch3 Freq} \times \text{Gate Time}}$$

$$\text{Ratio } 2/1 : \frac{\text{Ch2 Freq}}{(\text{Ch1 Freq})^2 \times \text{Gate Time}}$$

$$\text{Ratio } 3/1 : \frac{\text{Ch3 Freq}}{(\text{Ch1 Freq})^2 \times \text{Gate Time}}$$

RMS Resolution:

$$\text{Ratio } 1/2 : \frac{2 \times \sqrt{1 + (\text{Ch1 Freq} \times \text{Ch2 Trigger Error})^2}}{\text{Ch2 Freq} \times \text{Gate Time}}$$

$$\text{Ratio } 1/3 : \frac{2 \times \sqrt{1 + (\text{Ch1 Freq} \times \text{Ch3 Trigger Error})^2}}{\text{Ch3 Freq} \times \text{Gate Time}}$$

$$\text{Ratio } 2/1 : \frac{2 \times \text{Ch2 Freq} \times \sqrt{1 + (\text{Ch1 Freq} \times \text{Ch2 Trigger Error})^2}}{(\text{Ch1 Freq})^2 \times \text{Gate Time}}$$

$$\text{Ratio } 3/1 : \frac{2 \times \text{Ch3 Freq} \times \sqrt{1 + (\text{Ch1 Freq} \times \text{Ch3 Trigger Error})^2}}{(\text{Ch1 Freq})^2 \times \text{Gate Time}}$$

To minimize relative phase measurement error, connect the higher frequency signal to Channel 1 when possible.

⁷ See Specifications for Pulse Width and Rise/Fall Time measurements for additional restrictions on signal timing characteristics.

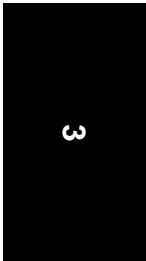

Chapter 3 Specifications
Measurement Specifications (Continued)

Measurement Specifications (Continued)

Pulse Width

Measurement is specified over the full signal range of Channel 1. The width of the opposing pulse must be greater than 4 ns (e.g., when measuring the positive pulse width, the negative pulse width must be greater than 4 ns).

Pulse Selection: Positive or Negative
Trigger: Default setting is Auto Trigger⁸ at 50%
Results Range: 5 ns to 10⁵ s

LSD:

53131A	53132A
500 ps	150 ps

RMS Resolution: $\sqrt{t_{res}^2 + Start\ Trigger\ Error^2 + Stop\ Trigger\ Error^2}$

t_{res} **53131A** **53132A**
 750 ps 300 ps

Systematic Uncertainty:
 $\pm (Time\ Base\ Error \times Pulse\ Width) \pm Trigger\ Level\ Timing\ Error \pm 1.5\ ns\ Differential\ Channel\ Error\ (Agilent\ 53131A)$
 $\pm 900\ ps\ Differential\ Channel\ Error\ (Agilent\ 53132A)$

Rise/Fall Time

Measurement is specified over the full signal ranges of Channel 1. The interval between the end of one edge and start of a similar edge must be greater than 4 ns. (e.g., when measuring a rising edge, 4 ns must elapse between the 90% point of one rising edge and the 10% point of the next rising edge).

Edge Selection: Positive or Negative
Trigger: Default setting is Auto Trigger⁸ at 10% and 90%
Results Range: 5 ns to 10⁵ s

LSD:

53131A	53132A
500 ps	150 ps

RMS Resolution: $\sqrt{t_{res}^2 + Start\ Trigger\ Error^2 + Stop\ Trigger\ Error^2}$

t_{res} **53131A** **53132A**
 750 ps 300 ps

Systematic Uncertainty:
 $\pm (Time\ Base\ Error \times Transition\ Time) \pm Trigger\ Level\ Timing\ Error \pm 1.5\ ns\ Differential\ Channel\ Error\ (Agilent\ 53131A)$
 $\pm 900\ ps\ Differential\ Channel\ Error\ (Agilent\ 53132A)$

Phase

Measurement is specified over the full signal range of Channels 1 and 2.

Results Range: -180° to +360°

RMS Resolution: $\sqrt{(t_{res}^2 + (2 \times Trigger\ Error^2)) \times \left(1 + \left(\frac{Phase}{360^\circ}\right)^2\right)} \times Frequency \times 360^\circ$

t_{res} **53131A** **53132A**
 750 ps 300 ps

Systematic Uncertainty: $(\pm Trigger\ Level\ Timing\ Error \pm 1.5\ ns\ Differential\ Channel\ Error) \times Frequency \times 360^\circ\ (Agilent\ 53131A)$
 $(\pm Trigger\ Level\ Timing\ Error \pm 900\ ps\ Differential\ Channel\ Error) \times Frequency \times 360^\circ\ (Agilent\ 53132A)$

⁸ Restrictions noted on page 3-2 for Auto Trigger apply to the proper operation of these measurements. The Peak Volts measurement is used to determine the signal amplitude and inaccuracies from this, noted on page 3-11, should be included in calculating the Trigger Level Timing Error.

Chapter 3 Specifications
Measurement Specifications (Continued)

Measurement Specifications (Continued)

Duty Cycle

Measurement is specified over the full signal range of Channel 1. However, both the positive and negative pulse widths must be greater than 4 ns.

Results Range: 0 to 1 (e.g. 50% duty cycle would be displayed as .5)

RMS Resolution: $\sqrt{(t_{res}^2 + (2 \times \text{Trigger Error}^2)) \times (1 + \text{Duty Cycle}^2)} \times \text{Frequency}$

	53131A	53132A
t_{res}	750 ps	300 ps

Totalize

Measurement is specified over the full signal range of Channel 1.

Results Range: 0 to 10^{15}

Resolution: ± 1 count

Peak Volts

Measurement is specified on Channels 1 and 2 for DC signals; or for AC signals of frequencies between 100 Hz and 30 MHz with peak-to-peak amplitude greater than 100 mV. (The measurement will continue to operate up to 225 MHz, though results are for indication only.)

Results Range: -5.1 V to +5.1 V

Resolution: 10 mV

Systematic Uncertainty for AC signals: 25 mV + 10% of V

for DC signals: 25 mV + 2% of V

Use of the input attenuator multiplies all voltage specifications (input range, results range, resolution and systematic uncertainty) by a nominal factor of 10. For example with AC signals, the Systematic Uncertainty becomes: 250 mV + 10% of V.

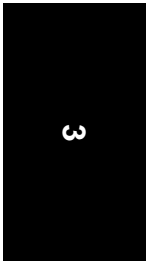

Chapter 3 Specifications
Measurement Definitions

Measurement Definitions

Definitions of Systematic Uncertainty Terms

• **Trigger Error**

External source and input amplifier noise may advance or delay the trigger points that define the beginning and end of a measurement. The resulting timing uncertainty is a function of the slew rate of the signal and the amplitude of spurious noise spikes (relative to the input hysteresis band).

The (rms) trigger error associated with a single trigger point is:

$$\text{Trigger Error} = \frac{\sqrt{(E_{input})^2 + (E_{signal})^2}}{\text{Input Signal Slew Rate at Trigger Point}} \text{ (in seconds)}$$

where

E_{input} = RMS noise of the input amplifier: 1 mVrms (350 μ Vrms typical). Note that the internal measurement algorithms significantly reduce the contribution of this term.

E_{signal} = RMS noise of the input signal over a 225 MHz bandwidth (100 kHz bandwidth when the low-pass filter is enabled). Note that the filter may substantially degrade the signal's slew rate at the input of the trigger comparator.

For two-trigger-point measurements (e.g. Rise Time, Pulse Width), the Trigger Errors will be referred to independently as Start Trigger Error and Stop Trigger Error.

• **Trigger Level Timing Error**

Trigger level timing error results from a deviation of the actual trigger level from the specified (indicated) level. The magnitude of the measurement timing error depends on several factors, primarily: resolution and accuracy of the trigger level circuit, fidelity of the input amplifier, slew rate of the input signal at the trigger point, and width of the input hysteresis band (see illustration).

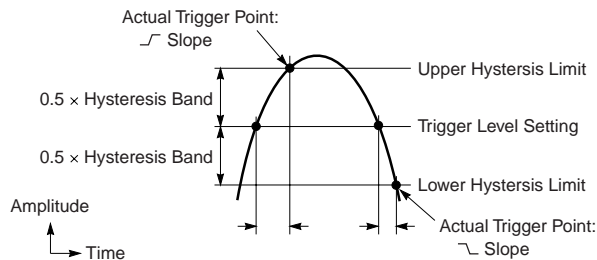

Trigger Level Timing Errors

Trigger level timing error is associated with Time Interval, Pulse Width, Rise Time, Fall Time, Phase, and Duty Cycle measurements. The following equations define the general interpretation of its component error terms for a measurement. These should be summed together to obtain the overall Trigger Level Timing Error.

$$\text{Input Hysteresis: } \frac{0.5 \times \text{Hysteresis Band}}{\text{Input Signal Slew Rate at Start Trigger Point}} - \frac{0.5 \times \text{Hysteresis Band}}{\text{Input Signal Slew Rate at Stop Trigger Point}}$$

$$\text{Trigger Level Setting: } \pm \frac{15 \text{ mV} \pm (1\% \times \text{Start Trigger Level Setting})}{\text{Input Signal Slew Rate at Start Trigger Point}} \pm \frac{15 \text{ mV} \pm (1\% \times \text{Stop Trigger Level Setting})}{\text{Input Signal Slew Rate at Stop Trigger Point}}$$

Chapter 3 Specifications Measurement Definitions (Continued)

Measurement Definitions (Continued)

- **Fractional Time Base Error**

Time base error is the maximum fractional frequency variation of the time base due to aging or fluctuations in ambient temperature or line voltage:

$$\text{Time Base Error} = \left(\frac{\Delta f}{f} \Big|_{\text{aging rate}} + \frac{\Delta f}{f} \Big|_{\text{temperature}} + \frac{\Delta f}{f} \Big|_{\text{line voltage}} \right)$$

Multiply this quantity by the measurement result to yield the absolute error for that measurement. Averaging measurements will not reduce (fractional) time base error. The Agilent 53131A/132A universal counters exhibit negligible sensitivity to line voltage; consequently this term may be ignored.

- **Differential Channel Error**

The Differential Channel Error term included in many of the Systematic Uncertainty equations accounts for channel-to-channel mismatch and internal noise. This error can be substantially reduced by performing the TI Calibration in the temperature environment in which future measurements are to be made and by careful measurement technique. Calibration is accessible via the Calibration Menu during power-up.

Typical Versus Worst Case Specifications

Specifications identified as "Typical" represent performance of the instrument that the majority of users will perceive under a wide variety of conditions and signals. The specifications identified as "Worst Case" should be used when the instrument is under extreme environmental conditions or when the accuracy of the measurement results are critically important.

Time Interval Measurement LSD Definition

For the Time Interval, Pulse Width, and Rise/Fall Time measurements, the LSD is the measurement quantization error. "t_{res}" is the LSD plus the effects of certain internal error producing sources.

Additional Considerations for Digits and Time Arming Modes

For sample rates defined below, resolution will be reduced by up to 1 decade. The instruments display detects this condition and displays a reduced-resolution result. Resolution is reduced in a band about f_s, such that

$$x.y = \frac{10\text{MHz}}{f_s}$$

where *x* is any integer, and *y* is any fraction in the set:

$$1/3, 2/3, 1/4, 2/4, 3/4, 1/5, 2/5, 3/5,$$

The width of the band is at most:

$$\frac{6 \times 10^{-7} \times f_{\text{input}}}{\text{Gate Time}}$$

For Example:

$$25.25 = \frac{10\text{MHz}}{396,039.6}$$

$$x = 25$$

$$y = 0.25 = 1/4$$

The value of f_s is not available to the user, but the instrument can be queried over GPIB to determine if this condition exists. After the measurement completes, use the query :DIAGnostic:MEASure:PRESolution?. The response is an ASCII text formatted string "0" for normal resolution and "1" for reduced resolution. This command is valid only when making frequency measurements in time or digits arming and the input frequency is greater than 100 Hz.

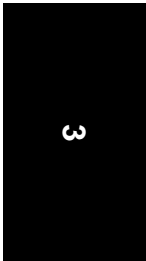

Chapter 3 Specifications

Measurement Arming and Processing

Measurement Arming and Processing

Gate Time

Auto Mode, or 1 ms to 1000 s

Measurement Throughput

GPIB ASCII: 200 Measurements/s (maximum)
 (See examples in the Programming Guide for ways to optimize measurement throughput)

Measurement Arming

Start Measurement: Free Run, Manual, or External
Stop Measurement: Continuous, Single, External, or Timed

Arming Modes:
 (Note that not all arming modes are available for every measurement function.)

- Auto Arming:** Measurements are initiated immediately and acquired as fast as possible, using a minimum number of signal edges. Auto arming offers the highest measurement throughput, though measurement resolution may be reduced.
- Timed Arming:** The duration of the measurement is internally timed to a user-specified value (also known as the "gate time"). This mode should be used when the length of the measurement time must be controlled.
- Digits Arming:** Measurements are performed to the requested resolution (number of digits) through automatic selection of the acquisition time. This is the most convenient mode for when a specific measurement resolution is desired.
- External Arming:** An edge on the External Arm Input enables the start of each measurement. Depending on the measurement function, Auto Arming, Timed arming modes or another edge on the External Arm Input may be used to complete the measurement.

Time Interval Arming Modes:

Agilent 53131A
 Time Interval Stop Delay Arming: The Stop Measurement condition on Channel 2 is inhibited (trigger hold-off) for a user specified time following the Start Measurement on Channel 1.
 Time Interval Delay Range: 100 μ s to 10 s*
 Time Interval Delay Resolution: 10 μ s from 100 μ s to 100 ms
 1 ms from 100 ms to 10 s

Agilent 53132A
 Time Interval Start Delay Arming: The start of a Time Interval measurement is delayed for a user-specified amount of time, or number of Channel 2 events, from the Start External Arming edge.
 Start Delay TimeRange: 100 ns to 999.9999 ms
 Start Delay Time Resolution: 100 ns
 Start Delay Event Range: 1 to 99,999,999 Channel 2 events
 Start Delay Event Rate: 5 MHz maximum
 Start Delay Event Setup Time: 30 ns minimum
 Time Interval Stop Delay Arming: The Stop Measurement condition on Channel 2 is inhibited (trigger hold-off) for a user-specified amount of time, or number of Channel 2 stop events, following the Start Measurement on Channel 1, or, if enabled, the Stop External Arming edge.
 Stop Delay Time Range: 100 ns to 10 s**
 Stop Delay Time Resolution: 100 ns from 100 ns to 1 s
 1 ms from 1 s to 10 s
 Stop Delay Event Range: 1 to 99,999,999 Channel 2 events
 Stop Delay Event Rate: 5 MHz maximum
 Stop Delay Event Setup Time: 30 ns minimum

* For firmware revisions below 3427 the valid range of delay is 1 ms to 10 s.
 ** For firmware revisions below 3646 the valid range of delay is 1 ms to 10 s.

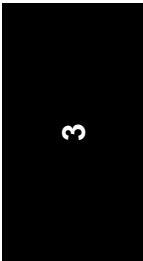

Chapter 3 Specifications
Measurement Arming and Processing (Continued)

Measurement Arming and Processing (Continued)

Measurement Statistics

- Available Statistics:** Mean, Minimum, Maximum, Standard Deviation
- Number of Measurements:** 2 to 1,000,000. Statistics may be collected on all measurements or on only those which are between the limit bands. When the Limits function is used in conjunction with Statistics, N (number of measurements) refers to the number of in-limit measurements. In general, measurement resolution will improve in proportion to $1/\sqrt{N}$, up to the numerical processing limits of the instrument.
- Measurements:** Statistics may be collected for all measurements except Peak Volts and Totalize.
-

Measurement Limits

- Limit Checking:** The measurement value is checked against user-specified limits at the end of each measurement.
- Display Modes:** The measurement result may be displayed as either the traditional numeric value or graphically as an asterisk moving between two vertical bars. These bars define the upper and lower limits, and the asterisk represents the current measurement result relative to these limits.
- Out-of-Limits Indication:** The out-of-limits condition can be indicated by any of the following methods:
- The limits annunciator will light on the front panel display.
 - The instrument will generate an SRQ if enabled via GPIB.
 - The limits hardware signal provided via the RS-232 connector will go low for the duration of the out-of-limit condition (see the description of this connector under the General Information section of this specifications table).
 - If the Analog Display mode is enabled, the asterisk appears outside the vertical bars, which define the upper and lower limits.

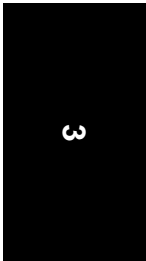

Chapter 3 Specifications

General Information

General Information

Save and Recall:	Up to 20 complete instrument setups may be saved and recalled later. These setups are retained when power is removed from the universal counter.	
Rack Dimensions (HxWxD):	88.5 mm x 212.6 mm x 348.3 mm	
Weight:	3.5 kg maximum	
Power Supply Voltage:	AC Line Supply	DC Supply (Option 002 Only)
Power Requirements:	100 to 120 VAC $\pm 10\%$ - 50, 60 or 400 Hz $\pm 10\%$ 220 to 240 VAC $\pm 10\%$ - 50 or 60 Hz $\pm 10\%$ AC Line Voltage Selection: Automatic	10 to 32 VDC, 3-pin male XLR connector Option 002 may not be ordered with Option 060 4A initial inrush at 10 VDC 3A max, once stabilized
Operating Environment:	0° C to 55° C	
Storage Environment:	-40° C to 71° C	
Remote Interface:	GPIB (IEEE 488.1-1987, IEEE 488.2-1987)	
GPIB Interface Capabilities:	SH1, AH1, T5, TE0, L4, LE0, SR1, RL1, PP0, DC1, DT1, C0, E2	
Remote Programming Language:	SCPI-1992.0 (Standard Commands for Programmable Instruments)	
Safety:	Designed in compliance with IEC 1010-1, UL 3111-1 (draft), CAN/CSA 1010.1	
EMC:	CISPR-11, EN50082-1, IEC 801-2, -3, -4 Electrostatic Discharge and Fast Transient/Burst Immunity Testing: When the product is operated at maximum sensitivity (20 mVrms) and tested with 8kV AD according to IEC801-2 or with 1kV power line transients according to IEC 801-4, frequency miscounts may occur that will affect measurement data made during these disturbances. Radiated Immunity Testing: When the product is operated at maximum sensitivity (20 mVrms) and tested at 3 V/m according to IEC 801-3, external 100 to 200 MHz electric fields may cause frequency miscounts.	
RS-232C:	The rear-panel RS-232 connector is a 9-pin connector (DB-9, male). You can connect the universal counter to any terminal or printer with a properly configured DTE connector (DB-25). You can use a standard interface cable (Agilent part number 24542G or 24542H). Data is "output only"; the instrument cannot be programmed via the RS-232 interface.	
Note on Pin 4:	May be used as either a DTR signal or an indication of measurement in-limit as configured by the Utility menu. When used as an in-limit indicator, the signal will be high for every measurement within the user set limits.	

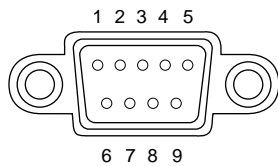

Pin Number	Type	Description
2	Input	Receive Data (RxD) (for Xon/Xoff only)
3	Output	Transmit Data (TxD)
4	Output	Data Terminal Ready (DTR) Measurement In-Limit Signal
5	—	Signal Ground
6	Input	Data Set Ready (DSR)
*	All other pins: no connection	

Index

SYMBOLS

+/- key, 1-18, 2-8

NUMERICS

10 MHz Output connector, 1-11

100 kHz Filter key, 2-44

50W/1 MW key, 1-16, 2-44

A

abort, 2-5

ac line selection, 1-11

accessories

available, xix

supplied, xix

addressed (talk/listen), 2-58

adjusting trigger level, 2-48

annunciators, front panel, 1-9

arming modes

auto, xvi, 2-16

digits, xvi, 2-17

external, xvi, 2-17

time, xvi, 2-17

arrow keys

entry/select keys, 2-8

auto arming, 2-16

auto triggering, 2-48

available options, xviii

B

baud rate, 2-62

C

CAL SECURE, 2-71

CAL UNSECURE, 2-68, 2-71

calibration, 2-67

count, 2-72

Help menu, 2-72

initiate, 2-69

new security code, 2-72

unsecure, 2-68

Calibration menu, 1-8, 2-67

changing the numerical convention of the display, 2-65

changing the slope, 2-49

changing trigger mode, 1-17

characters

*, 1-10

X, 1-10

choosing HIGH to disable hardware pacing, 2-62

choosing HW PACE, 2-62

choosing the timebase source, 2-59

COMMON 1

ON, 2-45

common questions, 2-94

computing Stats on filtered data only, 1-32

configuring the RS-232 for sending limit-detect output, 2-64

connecting to a printer via GPIB, 2-66

connecting to a serial printer via the RS-232 port, 2-65

controlling measurement, 1-36

counter description, xvi

coupling, 2-51

D

data entry keys

numeric entry, 2-8

DC/AC key, 1-15, 2-44

definition of sensitivity, 2-46

description of

display annunciators, 1-9

entry/select (arrow) keys, 2-8

Gate & ExtArm Menu key, 2-16

input conditioning toggle keys, 2-51

LIMITS keys

Limit Modes, 2-37

Uppr&Lower, 2-37

Local key, 1-4

MATH keys

Scale & Offset key, 2-27

Index

- Stats, 2-32
 - MEASURE keys
 - Freq & Ratio, 2-10
 - Other Meas, 2-10
 - Time & Period, 2-10
 - Print menu, 2-56
 - Recall menu, 2-52
 - Remote indicator, 1-4
 - Run key, 2-5
 - Save menu, 2-52
 - scale and offset, 1-19
 - self-test routines, 2-59
 - special character, display, 1-10
 - Stop/Single key, 2-5
 - Trigger/Sensitivity menu key, 2-44
 - Utility menu, 2-57
 - description of counter, xvi
 - differences between firmware revisions, xx
 - digits arming, 2-17
 - digits, displaying more, 2-94
 - digits, thirteenth, 2-94
 - disabling Limit Testing, 1-30
 - disabling Math, 1-22
 - display
 - menu messages, 2-75
 - messages, 2-73
 - numerical convention
 - other countries, 2-65
 - USA, 2-65
 - power-up/self test messages, 2-74
 - SHOW
 - GRAPH, 2-40
 - NUMBER, 2-41
 - display annunciators, 1-9
 - display special character, 1-10
 - display thirteenth digit, 2-94
 - displaying Math results, 1-22
 - displaying Stats after filtering data of input signal, 1-34
 - DTR (Data Terminal Ready) menu, 2-62
 - duty cycle, 2-14
- E**
- Enter key, 2-8

- entering numeric values, 2-8
 - entering offset value, 1-21
 - entering scale value, 1-20
 - entry/select keys
 - arrow keys, 2-8
 - equation
 - scale and offset, 1-19
 - example procedure for
 - changing the number of digits of resolution, 2-25
 - computing Stats, 2-33
 - easy viewing of Stats, 2-34
 - filtering data (using limits) during Stats, 2-35
 - Gate and External Arm, 2-24
 - Offset function, 2-29
 - running the self test, 2-61
 - Scale function, 2-28
 - setting the Offset from the last measurement value, 2-31
 - setting trigger voltage and sensitivity levels, 2-48
 - turning off Math mode, 2-30
 - turning off Stats mode, 2-36
 - using the Common 1 function to make time interval measurements, 2-51
 - Example Procedure for Turning Off Math Mode, 2-30
 - Ext Arm connector, 2-17, 2-18, 2-20, 2-24
 - External Arm input connector, 1-11
 - external arming, 2-16, 2-17
 - External Reference Input connector, 1-11
- F**
- falltime, 2-13
 - fan, 1-2, 1-11
 - Features and Functions
 - Recall, 2-52
 - Save, 2-52
 - sensitivity, 2-46, 2-47
 - Unsave, 2-55
 - fine time interval calibration, 2-69
 - firmware revisions, xx
 - Freq & Ratio key, 2-10

Index

- frequency, 2-11
- frequency ratio, 2-12
- front-panel indicators, 1-3, 1-4
- front-panel menus, 1-5, 1-6, 1-7, 1-8
- function
 - duty cycle, 2-14
 - fall time, 2-13
 - frequency, 2-11
 - frequency ratio, 2-12
 - period, 2-13
 - phase, 2-15
 - pulse widths, 2-14
 - rise time, 2-13
 - time interval, 2-13
 - totalize, 2-14
 - voltage peaks, 2-15

G

- Gate, 2-16
- Gate and External Arming menu, 2-16
 - auto, 2-16
 - digits, 2-17
 - external, 2-17
 - time, 2-17
- Gate time and resolution, 2-17
- GPIB Address, 2-58
- GPIB connector, 1-11
- GPIB messages, 2-77
- GPIB to talk-only, 2-66

H

- hardware pacing, 2-62
- how to make measurements, 1-12
- how to set limits, 1-23
- hysteresis, 2-46

I

- impedance, 2-51
- in case of trouble, 2-94
- indicators (LEDs), 1-3, 1-4
- initiating measurements, 2-5
- input calibration, 2-69
- input conditioning keys, 2-44
- input impedance, 2-51

L

- Legend, 1-13
- Limit testing, 2-38
- Limit-detect output, 2-43, 2-64
- Limit-Detect Output connector, 1-11
- Limits Testing Example 1—Flag and Stop Measuring On Limits, 2-38
- Limits Testing Example 2—Flag On Limits but Continue Measuring, 2-40
- Limits Testing Example 3—Use Analog Graph Display While Adjusting Input Signal, 2-40
- Limits Testing Example 4—Selecting Filtering Conditions of Stats Computation, 2-42
- Limits Testing Example 5—Sending the Limit-Detect Output, 2-43
- list of options, xviii
- Local key, 1-4, 2-75
- low pass filter, 2-51

M

- making a single measurement, 1-36
- making repetitive measurements, 1-36
- making the Counter flag on limits but continue measuring when the signal exceeds the user-entered limits, 1-28
- Math
 - offset, 2-27
 - scale, 2-27
- Math menu, 2-27
- MEASURE keys
 - Freq & Ratio, 2-10
 - Other & Meas, 2-10
 - Time & Period, 2-10
- measurement control keys, 2-5
 - Run key, 2-5
 - Stop/Single key, 2-5
- measurement function menus, 2-10
- measurement sequence, 2-93
- measuring duty cycle, 2-14
- measuring falltime, 2-13
- measuring frequency, 2-11
- measuring frequency ratio, 2-12

Index

- measuring period, 2-13
 - measuring phase, 2-15
 - measuring positive/negative pulse widths, 2-14
 - measuring positive/negative voltage peaks, 2-15
 - measuring risetime, 2-13
 - measuring time interval, 2-13
 - common, 2-51
 - measuring, totalize, 2-14
 - menu messages, 2-75
 - menus of
 - 100kHz Filter key, 1-6
 - 50 Ohm/1M Ohm key, 1-6
 - Calibration (Scale & Offset) key, 1-8
 - DC/AC key, 1-6
 - Freq & Ratio key, 1-5
 - Gate & ExtArm key, 1-5
 - Limit Modes key, 1-5
 - Other Meas key, 1-5
 - Recall key, 1-6
 - Save & Print key, 1-6
 - Scale & Offset key, 1-5
 - Stats key, 1-5
 - Time & Period key, 1-5
 - Trigger/Sensitivity key, 1-6
 - Uppr & Lower key, 1-5
 - Utility key, 1-7
 - X10 Attenuate key, 1-6
 - messages
 - front panel, 2-73
 - GPIB, 2-77
 - menu, 2-75
 - power-up/self-test, 2-74
 - modifying input trigger level, 1-17
- N**
- new security code entry, 2-72
 - numeric entry for a menu item, 2-4
 - numerical convention, 2-65
- O**
- offset, 1-19, 2-27
 - ON SINGLE menu item, 2-6
- options, xviii
- oscillator adjust potentiometer, 1-11
 - Other Meas key, 2-10
- P**
- pace
 - software, 2-63
 - pacing, 2-62
 - parity, 2-63
 - parity type, 2-62
 - peaks, 2-15
 - performing statistics on measurements, 1-31
 - period, 2-13
 - phase, 2-15
 - preface, xi
 - preset value lists, 2-78
 - preset values, 2-78, 2-79, 2-85
 - presetting the Counter, 2-4
 - PRINT
 - ON, 2-62
 - print function, 2-56
 - printer
 - connect Counter to printer, 2-66
 - printing, 2-56
 - pulse widths, 2-14
- Q**
- questions, 2-94
 - quick reference guide, xxiii
 - quick time interval calibration, 2-69
- R**
- ratio, 2-12
 - Recall function, 2-54
 - recalling measurement setups, 2-52
 - related documents, xiii
 - remote, 1-4
 - Remote indicator (LED), 1-4
 - repackaging for shipment, xv
 - resetting the Counter, 2-4
 - resolution, 2-17
 - revision
 - firmware, xx
 - risetime, 2-13

Index

RS-232 interface, 1-11
RS-232 serial port, 2-43
Run key, 2-5
run mode, 2-5
running the self-test routines, 2-59

S

Save function, 2-53
saving measurement setups, 2-52
Scale & Offset key, 1-19
scale and offset equation, 1-19
Scale and Offset functions, 2-27
Securing against calibration, 2-71
security status, 2-68
selecting input sensitivity, 1-19
selecting input trigger slope, 1-18
Selecting Operating Mode (Talk/Listen, Talk-Only), 2-58
selecting sensitivity, 2-50
selecting the type of Statistics (Stats), 1-31
self test messages, 2-74
self-test, 2-59
sending limit-detect output, 2-43
sensitivity, 1-19, 2-46
serial port, 2-43, 2-62
SET OFFSET ?, 2-31
setting lower limit, 1-26
Setting the Baud Rate, 2-62
Setting the Hardware Pacing, 2-62
Setting the GPIB Address, 2-58, 2-66
Setting the GPIB address, 2-58
Setting the Parity, 2-63
Setting the Software Pace, 2-63
setting upper limit, 1-24
sign (+/-) key, 1-18
sign key, 2-8
Single key, 2-5
single measurement, 1-36
single mode, 2-5
software pace, 2-63
software pacing, 2-62
specifications, 3-2
 Agilent 53131A/132A, 3-2
 dimensions, 3-16

 frequency range, 3-2
 measurement throughput, 3-14
 power supply voltage, 3-16
 RS-232C connector pin assignments, 3-16
 time base stability, 3-4
 voltage range and sensitivity, 3-2
starting measurements, 1-19
Stats function, 2-32
stop, 2-5
summary of measurement sequence, 2-93
SW PACE, 2-62, 2-63

T

talk/listen, 2-58
talk-only, 2-58, 2-66
TEST, 2-59
The Gate & External Arm Key Menus, 2-19, 2-23
thirteenth digit, 2-94
Time & Period key, 2-10
time arming, 2-17
time interval
 common, 2-45
 separate, 2-13
time Interval delay arming, 2-17, 2-20
timebase
 auto, 2-59
 calibration, 2-67, 2-69
 external, 2-59
 internal, 2-59
timebase source, 2-59
totalize, 2-14
trigger band, 2-50
trigger level, 2-48
trigger slope, 2-49
types of measurement functions, 2-10
types of service available if your instrument fails, xiv

U

Unsave, 2-55
using Enter key, 2-8
using LIMITS, 2-38
using ON FAIL

Index

- GO ON menu item, 1-29
- STOP menu item, 1-28
- using SET OFFSET ?, 2-31
- using SHOW
 - Stats menu item, 2-33
- using Stats key, 2-33
- using the +/- (sign) key, 1-18
- using the arrow keys
 - to change states of menu items, 2-9
 - to enter numeric values, 2-8
 - to execute prompted event messages, 2-9
 - to execute prompted help messages, 2-9
 - to sequence through the menus of the MEASURE keys, 2-8
- using the Calibration Menu, 2-67
- using the entry select keys
 - to enter numeric values, 2-8
- using the entry/select keys
 - to change states of menu items, 2-9
 - to execute prompted event messages, 2-9
 - to execute prompted help messages, 2-9
 - to sequence through the menus of the MEASURE keys, 2-8
- using the Ext Arm connector, 2-24
- using the Gate & ExtArm key, 2-24
- using the input coupling toggle keys, 1-15
- using the input impedance toggle keys, 1-16
- using the Math operations
 - offset, 2-28
 - scale, 2-28
- using the measurement control keys
 - Run key, 2-6
 - Stop/Single key, 2-6
- using the Print menu, 2-56
- using the Recall function, 2-54
- using the Save function, 2-53
- using the Scale & Offset, 2-28
- using the Scale & Offset key, 2-28
- using the Trigger/Sensitivity key, 2-48
- using the Unsave function, 2-55
- Utility menu, 1-7, 2-4, 2-57

V

- voltage peaks, 2-15

X

- X10 Attenuate key, 2-44