



Advanced Test Equipment Rentals
www.atecorp.com 800-404-ATEC (2832)



AMX & ASX Series

High Performance AC Test Power
Single and Three Phase AC Power Sources

Linear and Switch-mode Models from 500 VA to 30 kVA



THE POWER OF EXPERTISE



Take Control of Your AC Test Power



The AMX and ASX Series are two families of High Performance AC Power Sources covering the power range of 500 VA to 30 kVA. The product lines offer both Linear (AMX) and PWM (ASX) technologies and are available in both single and three phase models. Units are conservatively designed and rated with output power based on the most severe combination of input line, output voltage, power factor and temperature. This approach to product design allows the AMX/ASX Series Power sources to excel when delivering the precision power demanded in the AC test environment. Great emphasis has been placed on low acoustic noise, ease of installation and maximum power per cubic inch of rack space. Control and operating features provide a high degree of application versatility and ease of use for the test engineer. Applications range from simple, manually controlled frequency conversion to harmonic testing and sophisticated bus programmable transient simulation.

Design Provides Total Control of AC Power

- All AMX/ASX Series Power Source models may be equipped with either a programmable or manual Oscillator/Controller.
- Single phase power sources may be switched between 1Ø or 2Ø output forms.
- Three phase power source models may be switched between 1Ø, 2Ø or 3Ø output forms.
- Control of the output power form and the selection of either the direct output or the optional transformer output is made available from the front panel or by computer interface.
- All operating functions may be controlled from either the front panel or from a remote RS-232 or IEEE-488.2/ SCPI interface.



Pacific Model 360ASX with UPC Controller

Simplify and Automate with UPC Studio

UPC Studio makes it easy and convenient to take full advantage of the advanced features installed in your Pacific AC Power Source. Whether it's a quick test at a new voltage, frequency or waveform using your 3120ASX, or the application of a new power line disturbance test using your AMX Series-based test system, UPC Studio is the answer.

Easy-To-Use UPC Studio Control Panel

UPC Studio provides quick and easy control over the basic functions of a Pacific Power AC Power Source. Presets for 50, 60 and 400 Hz are provided for most common applications. Form, Coupling, Current Limit, Voltage and Waveforms are all easily accessed from this single easy-to-use soft panel.



Enhanced Waveform Editor

UPC Studio's Waveform Editor allows you to view all waveforms stored on your PC or within your UPC. With the Waveform Editor almost any waveform may be produced. Import waveforms captured on external instruments, Freehand draw, enter harmonic and phase angle content, create ringwaves, random noise, clipping and other custom waveshapes.

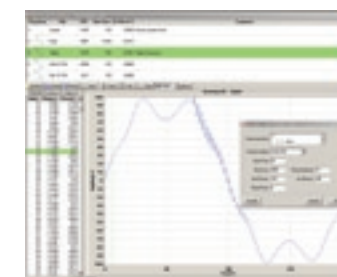

Write, Evaluate and Execute Output Sequences from a Single Window

UPC Studio's Output Sequence Editor provides a comprehensive view of all Power Source Output parameters. Steady State conditions, waveforms and associated transients are displayed. Transient values are entered as discrete values or a percentage of nominal with transient timing stated in seconds or cycles. Output graph shows envelope results of selected output transient.



Browse Output Sequences

UPC Studio's Output Sequence Browser provides the ability to easily view and transfer annotated Output Sequences (programs) between the UPC Controller and the host computer.

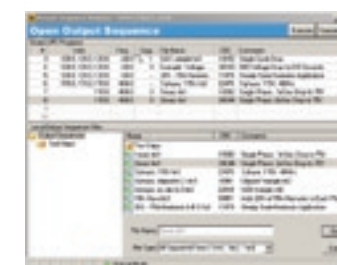

UPC Test Manager (option)

Test Manager allows you to consolidate all UPC Manager features into a single comprehensive test executive. Automate testing, collect data, and generate test reports all within the Test Manager application.



Standard Features:

- IEEE-488.2 or RS-232C with SCPI compatibility.
- Metering of RMS and Peak Values.
- Continuous Self Calibration (CSC).
- Models with up to 6:1 Peak Current Capability. (AMX)
- Up to 300 VAC Direct Coupled Output.
- 1 Phase / 3 Phase Selectable Output.
- 20–5,000 Hz Full Power Bandwidth. (AMX)
- Power Levels from 500 VA to 30 kVA.
- Externally Referenced Meter Calibration.
- CE or ETL Mark Available.

Available options:

- Waveform Creation by Harmonic Synthesis.
- Harmonic Analysis (Voltage and Current).
- Line Sync.
- Programmable Output Impedance.
- Power Source Paralleling.
- DO-160, ABD-0100 Avionics Test Sequences (Requires UPC Test Manager).

Dual Range Output Transformer Option (Available for AMX and ASX Series)

AMX and ASX Series Power Sources can be equipped with output transformers to provide an alternate output voltage range. Selection of direct or transformer coupled range is performed by the controller via front panel or bus command. The standard frequency range for transformer coupled outputs is 45 to 5,000 Hz for AMX Series and 45 to 1,200 Hz for ASX Series. Standard output ratios are 1.5:1, 2.0:1, and 2.5:1. Transformer outputs are supplied internally or externally via a Magnetics Module as listed in the model tables. Consult the factory for additional information regarding special output ranges not listed.

Mechanical Specifications (Typical for both AMX and ASX Series)

MOUNTING	Standard 19-inch rack. Slide rails are available as an option for all models.
HEIGHT	See model tables for panel height.
DEPTH	Approximately 24-inch, from the front panel to the rear of the chassis.
COOLING	Front or side forced air intake with rear exhaust. Automatic Fan Speed Control for low acoustic noise and extended fan life (depending on model).

All models are designed for operation in 19-inch equipment racks. Models 2.5 kVA and higher have side handles for ease of handling.

Selecting the Best Technology for Your Application

Pacific Power Source designs and manufactures both linear and pulse-width modulated (PWM) AC Power Sources. Understanding the capabilities and differences between these technologies is especially helpful in determining which models best satisfy your requirement.

Application and Technological Considerations

There is no single-parameter right-or-wrong solution when deciding which technology is best for a given application. Careful evaluation of individual test requirements will determine whether linear or PWM technology is correct. Over-specifying may lead to avoidable cost, weight, and environmental concerns. Using a matrix approach with the tables below, compare the "Features/Capabilities" of each technology to that best suited for a specific "Application". The technology with the highest combination of features for your application will usually be the best technology for the job.

APPLICATION	LINEAR	PWM
DC supply ATE tests	Best	
400Hz, synchronous ATE system	Best	
R&D power line disturbance tests	Best	
Watt-hour meter testing	Best	
Power line disturbance tests	Best	
Production life tests (frequency conversion)		Best
Circuit breaker tests		Best
Safety compliance tests		Best
Commercial appliance test and burn-in		Best
Motor performance and safety tests		Best

FEATURE/CAPABILITY	LINEAR	PWM
Highest amplifier efficiency		Best
Lowest operating temperature		Best
Lowest weight		Best
Smallest size		Best
Lowest cost		Best
Low-power factor handling		Best
Lowest harmonic distortion	Best	
Lowest output impedance	Best	
Highest bandwidth	Best	
Active impedance control	Best	
Highest crest-factor	Best	
Highest startup surge current	Best	

AMX Series – Linear AC Power Source

Linear AC Power Sources produce low-distortion, high fidelity, output waveforms. The advantage of linear amplification is its ability to faithfully reproduce oscillator waveforms with very high small signal bandwidth and low output distortion. The disadvantage is larger size and lower efficiency inherent to Class A/AB amplifiers. The graphic below demonstrates the characteristics of Linear-Amplifier technology.

Characteristics of Linear-Amplifier Technology



- Very low output distortion
- Wide output bandwidth
- High crest factor handling for wide range of loads without waveform distortion
- Higher temperature operation due to class A, B, and AB amplifier inefficiencies
- Larger size due to increased component count
- Higher weight due to increased component count

ASX Series – PWM AC Power Source

PWM AC Power Sources offer very good density, high efficiency, and perform well into low power factor loads. They use a combination of both linear and non-linear methods to achieve high efficiency conversion in lighter and smaller packages. A disadvantage is the method's lesser ability to provide high crest factor current and very low output distortion. The graphic below demonstrates the characteristics of PWM technology.

Characteristics of Switch-Mode Technology

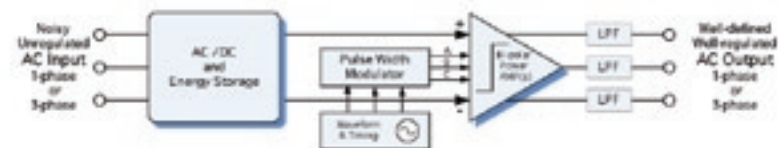

- Moderately low output distortion
- Ability to provide full current into very low power factor reactive loads
- Ability to provide full current over full voltage range without derating at low voltage
- Moderately wide output bandwidth
- Lower weight due to higher amplification efficiencies
- Smaller size due to smaller/fewer components
- Lower temperature operation due to higher amplifier efficiencies
- Limited ability to reproduce complex transient waveforms

Requirements for Specifying a Precision AC Source

- Output voltage range
- Output frequency range
- Output current requirements, including inrush and overload
- High peak current for non-linear (high crest factor) loads
- Phase angle of output current (power factor)
- Accurate replication of custom or high harmonic waveforms or both
- Fast transient capability
- Amplifier output voltage distortion
- Amplifier output impedance and control
- Size, weight, and efficiency limits
- Environmental needs and limits
- Performance versus price considerations

Pulse-Width Modulated (PWM) AC Power Sources

An often critical difference between linear and PWM supplies is each technology's ability to sink or source current at various voltages and power factors. PWM technology has the ability to provide full-rated current over the entire voltage range, up to the kW limit of the device. While linear amplifiers can provide very high peak currents and fast dv/dt rates, they must dissipate low power factor currents internally as heat. Subsequently, continuous output current is de-rated at low power factors or reduced voltages.

System Architecture

Pacific Power Source AMX/ASX series products are designed to operate in various modes and forms with each phase independently controlled by the operator. This feature provides three phase power sources with the ability to supply power to one (1) single phase load, one (1) dual range (150/300V) load, three (3) single phase loads, or one (1) three phase load. By the addition of a dual range magnetics option, these abilities are multiplied with an additional high voltage range capability.

Power Source Form

Form 1 – Single Phase

Enables Single phase output with the load connected between the 1 Phase and Neutral output terminals. Voltages are programmed phase to neutral.



Form 2 – Split/Single Phase

Enables high range Split/Single phase output. Load is connected either between the Phase A and Phase B output terminals (full voltage) or Phase and Neutral (half voltage). Voltages are programmed phase to phase.

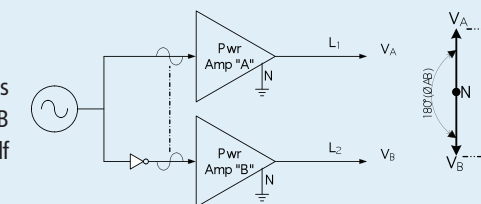

Form 3 – Three Phase

Enables Three phase output with the load connect between the A, B, C, and Neutral terminals. Loads may be connected either line to line or line to neutral. Voltages are programmed phase to neutral.

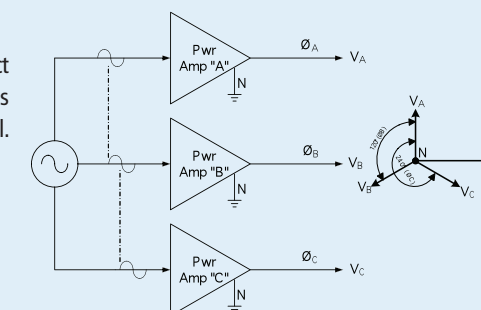

Power Source Mode

Power Source mode refers to the method of output coupling. When equipped with high range output magnetics, Pacific Power Source products may operate in either "Direct" or "Transformer" coupled modes. Selection of direct or transformer coupled mode is performed by the power source controller via front panel or bus command. High performance, multi-filer autotransformers are used to minimize any impact on power source performance specifications.

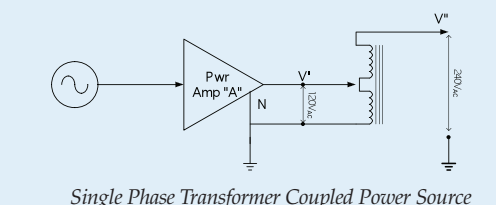
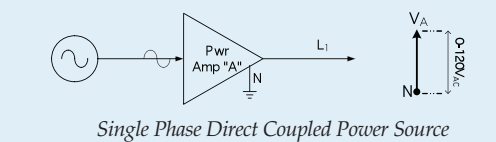

AMX Series Single Phase Power Sources

Direct Coupled Units (20 – 5,000 Hz.)

MODEL	Rated Power (VA) ¹	Output Form ²	Output Voltage Max ³ (I-n/I-l)	Output Current ⁴ (A _{rms})	Input Power Form ⁵	Unit Height (in.-U)	Unit Weight (lbs/kg)
105AMX	500	1/2	0-135/270	4/2	1Ø	5.25-3U	65/29.5
108AMX	750	1/2	0-135/270	6/3	1Ø	5.25-3U	65/29.5
112AMX	1200	1/2	0-150/300	10/5	1Ø	5.25-3U	70/32
140AMX	4000	1/2	0-135/270	32/16	3Ø	14-8U	170/77
160AMX	6000	1/2	0-135/270	48/16	3Ø	14-8U	185/84

Direct/Transformer Selectable Units (45 – 5,000 Hz.)

MODEL	Rated Power (VA) ¹	Output Form ²	Output Voltage Max ³ (I-n/I-l)			Output Current ⁴ (A _{rms})			Input Power Form ⁵	Unit Height (in.-U) Weight (lbs/kg)	Transformer Height (in.-U) Weight (lbs/kg)		
			Direct	Transformer		Direct	Transformer						
				Ratio 1.5:1	Ratio 2.0:1		Ratio 2.5:1	Ratio 1.5:1				Ratio 2.0:1	Ratio 2.5:1
105AMXT	500	1/2	0-135/270	0-202/404	0-270/540	0-338/600	4/2	2.6/1.3	2/1	1.6/0.8	1Ø	5.25-3U 75/34	Integrated
108AMXT	750	1/2	0-135/270	0-202/404	0-270/540	0-338/600	6/3	4/2	3/1.5	2.4/1.2	1Ø	5.25-3U 75/34	Integrated
140AMXT	4000	1/2	0-135/270	0-202/404	0-270/540	0-338/600	32/16	21.3/10.7	16/8	12.8/6.4	3Ø	14-8U 170/77	5.25-3U 120/55
160AMXT	6000	1/2	0-135/270	0-202/404	0-270/540	0-338/600	48/16	32/10.7	24/8	19.2/6.4	3Ø	14-8U 185/84	5.25-3U 120/55

1. Rated output power is based on a combination of output voltage, current and load power factor. Values stated represent the rated capabilities of a given model. Consult factory for assistance in determining specific unit capabilities as they might apply to your application.
2. All single phase units are operable with dual voltage ranges as listed. Output voltage ranges and 1Ø/2Ø conversions are selected by front panel or bus command.
3. Output voltage ranges listed are for standard units. VMAX is achievable with nominal input voltage at full load.
4. Current ratings at 125 V_{max} output. Current may vary with power factor.
5. Input power frequency is 47–63 Hz. Single Phase: 100, 110, 120, 200, 208, 220, 230, 240, VAC ±10%. Three phase: 208, 220, 240, 380, 400, 416 VAC ±10% (480 VAC option available).
6. Single phase and 400 Hz input options may be available. Consult Factory.

AMX Power Source Specifications (V_{out} > 25% FS.)

Output Frequency	Line Regulation	Load Regulation (Direct Coupled)	Output Distortion	Ripple And Noise	Response Time
20 to 5,000 Hz Full Power.	0.1% max for a ±10% line change.	0.25% 20 to 2,000 Hz.; 0.5% 2,000 to 5,000 Hz. Can be improved to less than 0.03% with CSC engaged.	0.1% THD _{AVG} from 45 to 1,000 Hz.; 0.25% THD _{AVG} from 1,000 to 5,000 Hz.	-72 dB	5µsec typical to a step load change. Small signal bandwidth is 5 Hz to 50 kHz, typical.

ASX Series Single Phase Power Sources

Direct Coupled Units (15 – 1,200 Hz.)

MODEL	Rated Power (VA) ⁷	Output Form ⁸	Output Voltage Max ⁹ (I-n/I-l)	Output Current ¹⁰ (A _{rms})	Input Power Form ⁵	Unit Height (in.-U)	Unit Weight (lbs/kg)
115ASX	1500	1	0-132	16	1Ø	5.25-3U	65/29.5
120ASX	2000	1/2	0-150/300	20/14	1Ø	5.25-3U	75/34
140ASX	4000	1/2	0-135/270	32/16	3Ø	8.75-5U	120/54.5
160ASX	6000	1/2	0-132/264	48/16	3Ø	8.75-5U	145/66

Direct/Transformer Selectable Units (45 – 1,200 Hz.)

MODEL	Rated Power (VA) ⁷	Output Form ⁸	Output Voltage Max ⁹ (I-n/I-l)			Output Current ¹⁰ (A _{rms})			Input Power Form ⁵	Unit Height (in.-U) Weight (lbs/kg)	Transformer Height (in.-U) Weight (lbs/kg)		
			Direct	Transformer		Direct	Transformer						
				Ratio 1.5:1	Ratio 2.0:1		Ratio 2.5:1	Ratio 1.5:1				Ratio 2.0:1	Ratio 2.5:1
115ASXT	1500	1	0-132	0-198	0-264	0-330	16	10.7	8	6.4	1Ø	5.25-3U	Integrated
140ASXT	4000	1/2	0-135/270	0-202/404	0-270/540	0-330/600	32/16	21.3/10.7	16/8	12.8/6.4	3Ø	8.75-5U 120/54.5	5.25-3U 110/50
160ASXT	6000	1/2	0-132/264	0-198/396	0-264/528	0-330/600	48/16	32/10.6	24/8	19.2/6.4	3Ø	8.75-5U 145/66	5.25-3U 110/50

7. Rated output power is based on a combination of output voltage, current and load power factor. Values stated represent the rated capabilities of a given model. Consult factory for assistance in determining specific unit capabilities as they might apply to your application.
8. All single phase output units (Model 115 ASX excepted) are operable with dual voltage ranges as listed. Output voltage ranges and 1Ø/2Ø conversions are selected by front panel or bus commands.
9. Output voltage ranges listed are for standard units. VMAX is output voltage with nominal input and full rated load applied. Other voltage ranges are available with the output magnetics options below.
10. Available current will vary with output voltage and power factor.
11. Single phase input: 100, 110, 120, 208, 220, 230 and 240 VAC ±10%. Three phase input: 208, 220, 240, 380, 400 and 416 VAC ± 10%.

ASX Power Source Specifications (V_{out} > 25% FS.)

Output Frequency	Line Regulation	Load Regulation (Direct Coupled)	Output Distortion	Ripple And Noise	Response Time
15 to 1,200 Hz. Full Power.	0.1% max for a ±10% line change.	0.25% 15 to 400 Hz. (Typ. 3 phase direct coupled) 0.50% 400 to 1,200 Hz. Improves to less than 0.1% with external sense and CSC enabled.	0.25% THD _{AVG} 15 to 200 Hz. 1.0% THD _{AVG} 200 to 1,200 Hz.	-66dB	60 µsec typical, 10–90% load step.

Single Phase Oscillator/Controller Feature Table (Common for both AMX and ASX)

MODEL ¹	Output Modes	Output Frequency ²	Remote Interface	Waveform Library	Transient Functions	Program Library	Program Current Limit	Program Current Protect	Programmable Phase Angle	Metering Accuracy ³	Waveform Harmonic Analysis and Synthesis	Programmable Output Impedance	DRM Link, Line Sync Options	Inrush Peak Detect Option
UPC-1M	1 and 2 phase	15-1,200 Hz.	No	Sine only	No	No	Yes	Yes	No	+/-0.2% of FS + Cal	No	No	No	No
UPC-1	1 and 2 phase	15-1,200 Hz.	RS-232 Std. GPIB Optional	Sine + 21 Editable	Yes	Yes	Yes	Yes	Yes	+/-0.2% of FS + Cal	Optional	Optional	No	Optional
UPC-12	1 and 2 phase	20-5,000Hz.	GPIB Std. RS-232 Optional	Sine + 15 Editable	Yes	Yes	Yes	Yes	Yes	+/- 0.25% of rdg + 0.1% of Range	Optional	Optional	Optional	No

1. Features apply to firmware versions 5.22 and greater. For earlier versions, consult factory.
2. Output Frequency limited by amplifier series; ASX-1200Hz., AMX-5,000Hz.
3. Current meter accuracy as a percentage of power source full scale range.

Controller Models (Common for both AMX and ASX)

Three controller models are available for single-phase power sources offering both manual and programmable control. All controllers provide manual operation from the front panel. Programmable Controllers may be programmed from the front panel or from a remote interface via RS-232 or GPIB.

- UPC-1M; 1 Phase Manual Control 15 Hz to 1,200 Hz.
- UPC-1; 1 Phase Programmable Control 15 Hz to 1,200 Hz.
- UPC-12; 1 Phase Programmable Control 20 Hz to 5,000 Hz.

Total Control, Metering, and Analysis of AC Power. Simple, Intuitive Operation.

AMX & ASX Series

Metering

V/I METER: ENTRY: 120.0
 FREQ=60.00 Va=120.0 Vb=120.0 Vc=120.0
 SENSE=INT Vab=208.0 Vbc=208.0 Vca=208.0
 MANUAL MODE Ia=06.00 Ib=06.22 Ic=06.15

POWER METER: PHASE A PHASE B PHASE C
 KVA 0.720 0.746 0.738
 KW 0.720 0.746 0.738
 PF 1.000 1.000 1.000

AMPS METER: PHASE A PHASE B PHASE C
 RMS 0.720 0.746 0.738
 PEAK 1.044 1.119 1.383
 CREST FACTOR 1.45 1.50 1.90

Waveform Control/Analysis

EDIT WAVEFORM: NUMBER=16 RANGE=2-16
 STARTING PHASE ANGLE=0 0-359.5°
 ENDING PHASE ANGLE=0 0-359.5°
 VOLTAGE IN PERCENT=-100 (+/-)0-100%

WAVEFORM SYNTHESIS: WAVEFORM #2
 HARMONIC: 2nd 3rd 4th 5th 6th
 CONTENT: .1% 0% 0% 0% 0%
 ØANGLE: 0° 0° 0° 0° 0°

ØA CURRENT THD=17.8 % OHD=17.8 EHD=0.3%
 HARMONIC: 2nd 3rd 4th 5th 6th
 CONTENT 1% 17.8% 0% 0% 0%
 ØANGLE ° 0° 0° 0° 0°

Function Key Provides Access to Special Functions

SETUP: PRESS 1 FOR PROGRAM SETUP
 2 FOR WAVEFORM SETUP
 3 FOR GENERAL SETUP
 4 FOR CALIBRATION MENU

Program Setup

- Copy a program.
- Delete a program.
- Erase all memory, reset CPU.

Waveform Setup

- Edit a waveform.
- Copy a waveform.
- Waveform synthesis. (option)

General Setup

- UPC setup.
- LCD setup.
- UPC status.
- Power source status.
- Range control.
- Slew rate setup.

Calibration Menu

- Execute externally referenced calibration.
- View calibration constants.

Special Functions Accessed Through UPC Setup Menu

- Sense establishes either local or remote sense for metering and CSC.
- CSC Continuous Self Calibration – provides for exceptional voltage accuracy.
- Program Z_0 Programmable output impedance dynamically compensates for output transformer or line distribution losses. Can simulate a soft power grid.
- Transition Time permits control of the time required to change voltage and/or frequency from one value to another.
- Frequency Limits sets min and max programmable frequency limits.
- Voltage Limits sets min and max programmable voltage limits.

160 Character LCD Display

Adjustable soft green backlight.

Parameter Select Keys

Select phase voltages and operating frequency when manual control is desired. The selected parameter is indicated by the LCD display. The CLEAR key erases entries and keeps erasing with repeated pressing until the basic V/I screen is displayed.

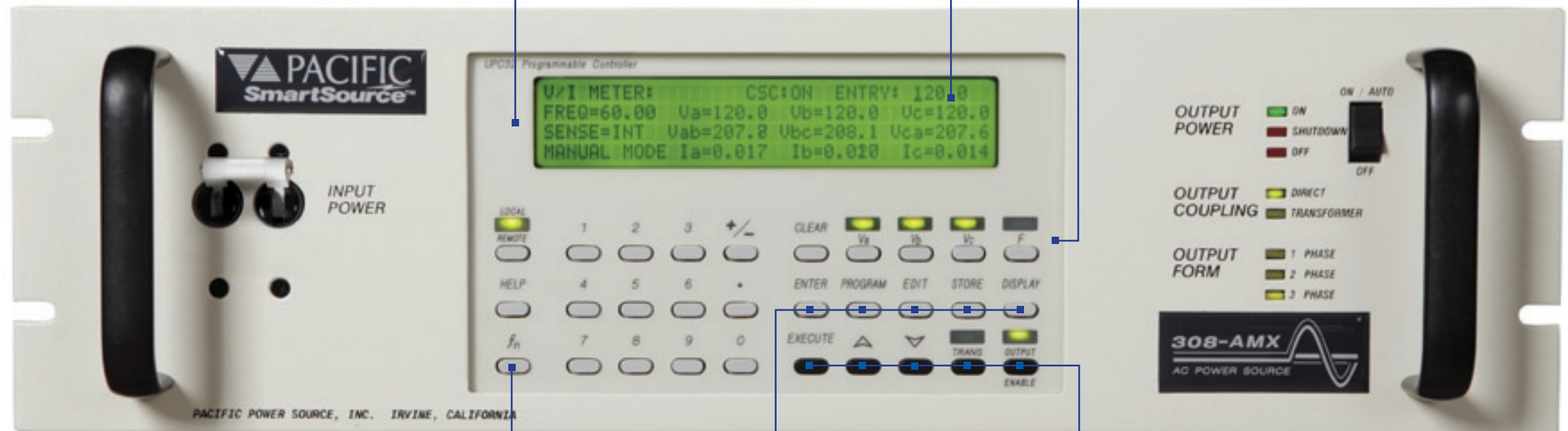

(Typical for both AMX and ASX Series)

Enter Key

Stores new parameter data that has been keyed in.

Program Key

Selects 1 of 99 programs for edit or execution.

Edit Key

Selects the program edit mode and prompts for new entry.

Store Key

Stores a program upon completion of editing.

Display Key

Sequences through each metering screen:

- V/I Meter.
- Power Meter.
- AMPS Meter.
- Waveform Analysis (option).

Execute Key

Instantly executes a stored program that has been selected with the program key.

Slew Keys

Smoothly change the designated voltage or frequency parameters. Rates are separately programmable.

Transient (Trans) Key

Turns time based or cycle based transients On or Off. Indicator is On when transient is executed.

Output Enable Key

Turns the output contactor of the power source On or Off. Indicator is On when the contactor is closed.

AMX Series Three Phase Power Sources

Direct Coupled Units (20 – 5,000 Hz.)

MODEL	Rated Power (VA) ¹	Output Form ²	Output Voltage Max ³ (l-n/l-l)	Output Current ⁴ (A _{rms})	Input Power Form ⁵	Unit Height (in.-U)	Unit Weight (lbs/kg)
305AMX	500	1/2 3	0-135/270 0-135/234	4/2 1.5/Ø	1Ø	5.25-3U	65/29.5
308AMX	750	1/2 3	0-135/270 0-135/234	6/2 2/Ø	1Ø	5.25-3U	65/29.5
312AMX	1200	1/2 3	0-135/270 0-135/234	10/3.3 3.3/Ø	1Ø	5.25-3U	70/31.8
320AMX	2000	1/2 3	0-135/270 0-135/234	18/6 6/Ø	3Ø	8.75-5U	100/45.4
345AMX	4500	1/2 3	0-135/270 0-135/234	36/12 12/Ø	3Ø	14-8U	175/79.5
360AMX	6000	1/2 3	0-135/270 0-135/234	48/16 16/Ø	3Ø	14-8U	185/84

Direct/Transformer Coupled Units (45 – 5,000 Hz.)

MODEL	Rated Power (VA) ¹	Output Form ²	Output Voltage Max ³ (l-n/l-l)				Output Current ⁴ (A _{rms})				Input Power Form ⁵	Unit Height (in.-U) Weight (lbs/kg)	Transformer Height (in.-U) Weight (lbs/kg)
			Direct	Transformer			Direct	Transformer					
				Ratio 1.5:1	Ratio 2.0:1	Ratio 2.5:1		Ratio 1.5:1	Ratio 2.0:1	Ratio 2.5:1			
305AMXT	500	1/2 3	0-135/270 0-135/234	0-202/404 0-202/350	0-270/540 0-270/468	0-338/600 0-338/585	4/2 1.5/Ø	2.6/1.3 1.0/Ø	2/1 0.75/Ø	1.6/0.8 0.6/Ø	1Ø	5.25-3U 75/34	Integrated
308AMXT	750	1/2 3	0-135/270 0-135/234	0-202/404 0-202/350	0-270/540 0-270/468	0-338/600 0-338/585	6/2 2/Ø	4/1.3 1.3/Ø	3/1 1/Ø	2.4/0.8 0.8/Ø	1Ø	5.25-3U 75/34	Integrated
320AMXT	2000	1/2 3	0-135/270 0-135/234	0-202/404 0-202/350	0-270/540 0-270/468	0-338/600 0-338/585	18/6 6/Ø	12/4 4/Ø	9/3 3/Ø	7.2/2.4 2.4/Ø	3Ø	8.75-5U 100/45.4	5.25-3U 120/55
345AMXT	4500	1/2 3	0-135/270 0-135/234	0-202/404 0-202/350	0-270/540 0-270/468	0-338/600 0-338/585	36/12 12/Ø	24/8 8/Ø	18/6 6/Ø	14.4/4.8 4.8/Ø	3Ø	14-8U 175/79.5	5.25-3U 120/55
360AMXT	6000	1/2 3	0-135/270 0-135/234	0-202/404 0-202/350	0-270/540 0-270/468	0-338/600 0-338/585	48/16 16/Ø	32/10.7 10.7/Ø	24/8 8/Ø	19.2/6.4 6.4/Ø	3Ø	14-8U 185/84	5.25-3U 120/55

- Rated output power is based on a combination of output voltage, current and load power factor. Values stated represent the rated capabilities of a given model. Consult factory for assistance in determining specific unit capabilities as they might apply to your application.
- All three phase units are operable as single phase with dual voltage range capability or as three phase. Output voltage ranges and 1Ø/3Ø conversions are selected by front panel or bus command.
- Output voltage ranges listed are for standard units. VMAX is achievable with nominal input voltage at full load. Other voltage ranges are available with the output magnetics option.
- Current ratings at 125 V_{rms} output. Current may vary with power factor.
- Input power frequency is 47–63 Hz. Single Phase: 100, 110, 120, 200, 208, 220, 230, 240, VAC ±10%. Three phase: 208, 220, 240, 380, 400, 416 VAC ±10% (480 VAC option may be available).
- Single phase and 400 Hz input options may be available. Consult Factory.

AMX Power Source Specifications (V_{out} > 25% F.S.)

Output Frequency	Line Regulation	Load Regulation (Direct Coupled)	Output Distortion	Ripple And Noise	Response Time
20 to 5,000 Hz Full Power.	0.1% max for a ±10% line change.	0.25% 20 to 2,000 Hz.; 0.5% 2,000 to 5,000 Hz. Can be improved to less than 0.03% with CSC engaged.	0.1% THD _{AVG} from 45 to 1,000 Hz.; 0.25% THD _{AVG} from 1,000 to 5,000 Hz.	-72 dB	5µsec typical to a step load change. Small signal bandwidth is 5 Hz to 50 kHz, typical.

Three Phase Oscillator/Controller Feature Table (Common for both AMX and ASX)

MODEL ¹	Output Modes	Output Frequency ²	Remote Interface	Waveform Library	Transient Functions	Program Library	Program Current Limit	Program Current Protect	Programmable Phase Angle	Metering Accuracy ³	Waveform Harmonic Analysis and Synthesis	Programmable Output Impedance	DRM Link, Line Sync Options	Inrush Peak Detect Option
UPC-3M	1,2, and 3 phase	15-1,200 Hz.	No	Sine only	No	No	Yes	Yes	No	+/-0.2% of FS + Cal	No	No	No	No
UPC-3	1,2, and 3 phase	15-1,200 Hz.	RS-232 Std. GPIB Optional	Sine + 21 Editable	Yes	Yes	Yes	Yes	Yes	+/-0.2% of FS + Cal	Optional	Optional	No	Optional
UPC-32	1,2, and 3 phase	20-5,000Hz.	GPIB Std. RS-232 Optional	Sine + 15 Editable	Yes	Yes	Yes	Yes	Yes	+/- 0.25% of rdg + 0.1% of Range	Optional	Optional	Optional	No

- Features apply to firmware versions 5.22 and greater. For earlier versions, consult factory.
- Output Frequency limited by amplifier series; ASX-1200Hz., AMX-5,000Hz.
- Current meter accuracy as a percentage of power source full scale range.

ASX Series Three Phase Power Sources

Direct Coupled Units (15 – 1,200 Hz.)

MODEL	Rated Power (VA) ⁷	Output Form ⁸	Output Voltage Max ⁹ (l-n/l-l)	Output Current ¹⁰ (A _{rms})	Input Power Form ¹¹	Unit Height (in.-U)	Unit Weight (lbs/kg)
315ASX	1500	1/2 3	0-132/264 0-132/228	12/6 4/Ø	1Ø	5.25-3U	75/34
320ASX	2000	1/2 3	0-150/300 0-150/260	20/12 7/Ø	1Ø	5.25-3U	85/42.5
345ASX	4500	1/2 3	0-135/270 0-135/234	36/12 12/Ø	3Ø	8.75-5U	145/66
360ASX	6000	1/2 3	0-132/264 0-132/228	48/16 16/Ø	3Ø	8.75-5U	145/66
390ASX	9000	1/2 3	0-135/270 0-135/234	72/36 24/Ø	3Ø	15.75-9U	224/102
3120ASX	12000	1/2 3	0-135/270 0-135/234	96/48 32/Ø	3Ø	15.75-9U	244/111

Direct/Transformer Coupled Units (45 – 1,200 Hz.)

MODEL	Rated Power (VA) ⁷	Output Form ⁸	Output Voltage Max ⁹ (l-n/l-l)				Output Current ¹⁰ (A _{rms})				Input Power Form ¹¹	Unit Height (in.-U) Weight (lbs/kg)	Transformer Height (in.-U) Weight (lbs/kg)
			Direct	Transformer			Direct	Transformer					
				Ratio 1.5:1	Ratio 2.0:1	Ratio 2.5:1		Ratio 1.5:1	Ratio 2.0:1	Ratio 2.5:1			
345ASXT	4500	1/2 3	0-135/270 0-135/234	0-202/404 0-202/350	0-270/540 0-270/468	0-338/600 0-338/585	36/12 12/Ø	24/8 8/Ø	18/6 6/Ø	14.4/4.8 4.8/Ø	3Ø	8.75-5U 145/66	5.25-3U 120/55
360ASXT	6000	1/2 3	0-132/264 0-132/228	0-198/396 0-198/343	0-264/528 0-264/457	0-330/600 0-330/572	48/16 16/Ø	32/10.7 10.7/Ø	24/8 8/Ø	19.2/6.4 6.4/Ø	3Ø	8.75-5U 145/66	5.25-3U 120/55
390ASXT	9000	1/2 3	0-135/270 0-135/234	0-202/404 0-202/350	0-270/540 0-270/468	0-338/600 0-338/585	72/36 24/Ø	48/24 16/Ø	36/18 12/Ø	28.8/14.4 9.6/Ø	3Ø	15.75-9U 224/102	7.00-4U 280/127
3120ASXT	12000	1/2 3	0-135/270 0-135/234	0-202/404 0-202/350	0-270/540 0-270/468	0-338/600 0-338/585	96/48 32/Ø	64/32 21.3/Ø	48/24 16/Ø	38.4/19.2 12.8/Ø	3Ø	15.75-9U 244/111	7.00-4U 280/127

- Rated output power is based on a combination of output voltage, current and load power factor. Values stated represent the rated capabilities of a given model. Consult factory for assistance in determining specific unit capabilities as they might apply to your application.
- All three phase units are operable as single phase with dual voltage range capability or as three phase. Output voltage ranges and 1Ø/3Ø conversions are selected by front panel or bus commands.
- Output voltage ranges listed are for standard units. VMAX is output voltage with nominal input and full rated load applied. Other voltage ranges are available with the output magnetics options below.
- Current ratings at 125Vrms output. Current may vary with power factor.
- Single phase input: 100, 110, 120, 208, 200, 220 and 240 VAC ±10%. Three phase input: 208, 220, 240, 380, 400 and 416 VAC ± 10%. (480 V input and 400 Hz input may be available as a cost option.)

ASX Power Source Specifications (V_{out} > 25% F.S.)

Output Frequency	Line Regulation	Load Regulation (Direct Coupled)	Output Distortion	Ripple And Noise	Response Time
15 to 1,200 Hz. Full Power.	0.1% max for a ±10% line change.	0.25% 15 to 400 Hz. (Typ. 3 phase direct coupled) 0.50% 400 to 1,200 Hz. Improves to less than 0.1% with external sense and CSC enabled.	0.25% THD _{AVG} 15 to 200 Hz. 1.0% THD _{AVG} 200 to 1,200 Hz.	-66dB	60 µsec typical, 10–90% load step.

Controller Models (Common for both AMX and ASX)

Three controller models are available for three-phase power sources offering both manual and programmable control. All controllers provide manual operation from the front panel. Programmable Controllers may be programmed from the front panel or from a remote interface via RS-232 or GPIB.

- UPC-3M; 3 Phase Manual Control 15 Hz to 1,200 Hz.
- UPC-3; 3 Phase Programmable Control 15 Hz to 1,200 Hz.
- UPC-32; 3 Phase Programmable Control 20 Hz to 5,000 Hz.

UPC Controller

Summary

The UPC Controller is a modular component and is available in six configurations ranging from 1 Phase to 3 Phase and Manual Control to Programmable Control. The table below lists each model according to key features.

All UPC Controllers include precise metering functions with data displayed via a 160 character LCD display. This, along with the 30-key front panel, provides the industry's most powerful and user-friendly controller.

Controllers are available with either the RS-232 or GPIB remote interface. Commands are structured in accordance with SCPI (Standard Commands for Programmable Instruments). The RS-232 serial port operates up to 38.4 Bps. The GPIB interface is compatible with the IEEE-488.2.

Programmable Output Impedance (optional)

This feature creates positive, negative, or zero output impedance (Z_o).

- Compensates for line distribution or transformer losses.
 - Simulates a soft power line for product testing.
- Typical compensation range is $\pm 15\%$ of the output voltage.

Transient Generation

Time-Based Transients

Create and execute transients that occur over a specified time segment to modify the output waveform, voltage, and frequency for any or all phases. An output trigger is provided for synchronizing external test equipment to the actual transient event.

Cycle-Based Transients

Create and execute transients that substitute a waveform in any or all phases for 1 to 100 cycles. The waveform being substituted can be selected and/or modified from the waveform library.

Features

MODEL	UPC - 1M	UPC - 3M	UPC - 1	UPC - 3	UPC - 12	UPC - 32
OUTPUT MODES	1Ø	1Ø & 3Ø	1Ø	1Ø & 3Ø	1Ø	1Ø & 3Ø
WAVEFORM LIBRARY	Sine	Sine	Sine + 21 Editable	Sine + 21 Editable	Sine + 15 Editable	Sine + 15 Editable
TRANSIENT FUNCTIONS	NO	NO	YES	YES	YES	YES
PROGRAM LIBRARY	NO	NO	99 Programs	99 Programs	99 Programs	99 Programs
PROGRAMMABLE CURRENT LIMIT	YES	YES	YES	YES	YES	YES
PROGRAMMABLE CURRENT PROTECT	YES	YES	YES	YES	YES	YES
PHASE ANGLE	N/A	Fixed. ØB = 120° ØC = 240°	N/A	Prog. 0 to 360°	N/A	Prog. 0 to 360°
CSC (Continuous Self-Calibration)	YES	YES	YES	YES	YES	YES
REMOTE INTERFACE	NO	NO	RS-232, std. or GPIB, opt.	RS-232, std. or GPIB, opt.	GPIB, std. or RS-232, opt.	GPIB, std. or RS-232, opt.
WAVEFORM SYNTHESIS/ANALYSIS	NO	NO	OPTIONAL	OPTIONAL	OPTIONAL	OPTIONAL
PROG. OUTPUT IMPEDANCE	NO	NO	OPTIONAL	OPTIONAL	OPTIONAL	OPTIONAL

Arbitrary Waveform Generation and Analysis

Waveform Edit

A full-featured editor permits modification of a stored waveform. This method can be used to quickly create spikes, dropouts, notches and other sub-cycle wave conditions. The resulting modified waveform is stored for execution in steady-state or transient programs.

Waveform Library

Up to 22 (16 waveforms on UPC-12/UPC-32) different waveforms can be stored in the waveform library for execution as part of a steady state program or for substitution in any output phase as part of a transient test program. Memory location #1 is a noneditable high resolution sine wave. Locations 2-22 are editable and can be substituted in any output phase.

Waveform Harmonic Synthesis (optional)

Quickly create virtually any AC test waveform by building it with harmonics. The process is as simple as keying in the magnitude and phase angle of each desired harmonic up through the 51st.

Waveform Analysis (optional)

Provides both graphic (using UPC Studio) and numeric displays of the harmonic structure of a voltage or current waveform. Each waveform is analyzed for its harmonic content, up to the 51st harmonic. Amplitude and phase are reported to the local display. UPC Manager displays numeric values as well as a graphic summary of the harmonic spectrum.

Specifications

SPECIFICATION		UPC1/UPC3	UPC12/UPC32
FREQUENCY	Range	15-1200 Hz.	20-5,000 Hz.
	Resolution	4 Significant Digits	
	Accuracy	$\pm 0.01\%$ of full scale	
VOLTAGE	Range (I-n)	0-150/341	0-150/375
	Resolution	0.1V / 0.5V	0.1V / 0.5V
	Accuracy	0.5% of full scale (CSC Disabled) $\pm 0.05\%$ referenced to Internal Meter (CSC Enabled)	
PHASE ANGLE ØB & ØC relative to ØA	Range	0-359°	
	Resolution	$\pm 1^\circ$	
	Accuracy	15.00-150 Hz., $\pm 0.5^\circ$ 15.00-300 Hz., $\pm 1^\circ$ 15.00-600 Hz., $\pm 2^\circ$ 15.00-1200 Hz., $\pm 3^\circ$	$\pm 0.5^\circ$
CURRENT LIMIT	Range	Varies by power source model	
	Resolution	0.05%	
	Accuracy	$\pm 3\%$	$\pm 1\%$
VOLTMETER	Range	0-354V-I, 708V-I	
	Resolution	0.1 V _{rms} front panel, 0.001 Vrms via remote interface	
	Accuracy	$\pm 0.2\%$ F.S. plus Cal ref.	$\pm 0.25\%$ of rdg. 50-500 Hz., $\pm 0.1\%$ F.S. 20-5,000 Hz., $\pm 0.5\%$ F.S.
AMMETER	Full Range	Varies by power source model	
	Display Range	0.01A rms or peak	
	Resolution	0.01A _{rms} or peak front panel, 0.001A via remote interface	
kVA METER Vmtr x Amtr	Range	XXX.XXX kVA	XXX.XXX kVA
	Resolution	XXX.XXX kVA	XXX.XXX kVA
	Accuracy	$\pm 1\%$ full range	$\pm 1\%$ full range
kW METER	Range	XXX.XXX kW	XXX.XXX kW
	Resolution	XXX.XXX kW	XXX.XXX kW
	Accuracy	$\pm 1\%$ full range	$\pm 1\%$ full range
Pf METER kWmtr / kVA mtr	Range	X.XXX	X.XXX
	Resolution	X.XXX	X.XXX
	Accuracy	$\pm 1\%$ full range	$\pm 1\%$ full range
FREQ. DISPLAY	Range	15.00-1200 Hz.	20.00-5000 Hz.
	Accuracy	$\pm 0.01\%$ of F.S.	
	Resolution	10.00-99.99 Hz., 0.01 Hz. 100.0-999.9 Hz., 0.1 Hz. 1000-1200 Hz., 1 Hz.	
WAVEFORM SYNTHESIS	HAS Option	Creates waveform by entering magnitude as % of fundamental and specifying phase angle for 2nd through the 51st harmonic	
WAVEFORM ANALYSIS	HAS Option	Reports waveform harmonic content and phase angle relative the fundamental for the 2nd through the 51st harmonic as Total, Odd, and Even harmonic distortion.	
ANALOG INPUTS	AUX-Auxiliary Input	Each phase is algebraically summed with UPC waveform and amplified 25 x to the direct coupled output. ± 10 Vac-pk (20Vpk-pk) One input per phase	
	AM-Amplitude Modulation	± 10 Vdc (20Vpk-pk) modulates the output voltage $\pm 100\%$. One input per phase	
SYNC OUTPUTS	Zero Crossing Trigger	Positive Zero Crossing (0°) of Phase A analog output	
	Transient Trigger	Pulse at the start of a transient event. (UPC12/32 only).	
	Transient Pedestal	TTL True when a transient is in progress	
Output Clock		TTL level pulse, rate varies w/ Fout	TTL Level pulse 1024 x Fout



Oscilloscope of voltage and current waveform at load due to distribution losses. THD=6.6%



Programmable Output Impedance Same conditions as above with programmable Z_o engaged. THD=0.25%



Time-Based Transients



Cycle-Based Transients

EDIT WAVEFORM: NUMBER=16	RANGE=2-16
STARTING PHASE ANGLE=0	0-359.5°
ENDING PHASE ANGLE=0	0-359.5°
VOLTAGE IN PERCENT=-100	(+/-)0-100%

Waveform Edit

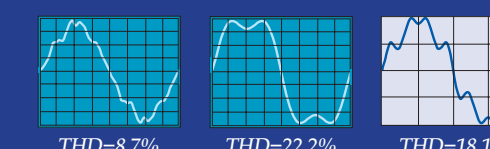

THD=8.7% THD=22.2% THD=18.1%

WAVEFORM SYNTHESIS: WAVEFORM #2	
HARMONIC: 2nd 3rd 4th 5th 6th	
CONTENT: .1% 0% 0% 0% 0%	
ØANGLE: 0° 0° 0° 0° 0°	

Waveform Harmonic Synthesis

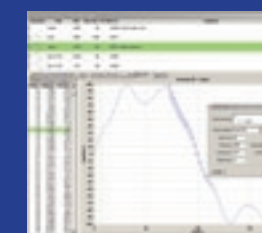

Waveform Analysis Shows harmonic content of metered waveform.

AMX Series Parallelable Models

The versatility of the Master/Slave Paralleling option for the 140/160/345/360AMX and 140/160/345/360AMXT AC power sources provide the operator with a wide variety of options using building block approach to a higher capacity AC Power Source System. Each paralleled group of AC Power Sources requires at least one 'Master' unit with a UPC-12 or UPC-32 controller. The following tables list the available three phase and single phase parallelable models.

Single Phase Parallelable Models (Parallel up to five like units to form up to a 30kVA System)

MODEL ³	Rated Power (VA)	Output Form	Output Voltage Max (I-n/I-l)				Internal/External Transformer Option	Function ^{1,2}	Total Height
			Direct	Transformer					
				1.5:1 ratio	2.0:1 ratio	2.5:1 ratio			
140AMX-UPC12/MST	4000	1/2	0-135/270	-	-	-	-	Master/Slave Selectable	8U
140AMX/SLV	4000	1/2	0-135/270	-	-	-	-	Dedicated Slave	8U
140AMXT-UPC12/MST	4000	1/2	0-135/270	0-202/404	0-270/540	0-338/600	External	Master/Slave Selectable	11U
140AMXT/SLV	4000	1/2	0-135/270	0-202/404	0-270/540	0-338/600	External	Dedicated Slave	11U
160AMX-UPC12/MST ⁵	6000	1/2	0-135/270	-	-	-	-	Master/Slave Selectable	8U
160AMX/SLV ⁵	6000	1/2	0-135/270	-	-	-	-	Dedicated Slave	8U
160AMXT-UPC12/MST ⁵	6000	1/2	0-135/270	0-202/404	0-270/540	0-338/600	External	Master/Slave Selectable	11U
160AMXT/SLV ⁵	6000	1/2	0-135/270	0-202/404	0-270/540	0-338/600	External	Dedicated Slave	11U

1. Parallelable "Master" delivered with UPC-12 Controller. Power Source provided with Master/Slave select switch on rear panel
2. Dedicated "Slave" Power Source requires master of the same base model (no UPC required).
3. Complete model number for basic unit shown
4. MST formerly known as M5283, SLV formerly known as M5283/M5304
5. 4kVA in 2 phase mode

Three Phase Parallelable Models (Parallel up to five like units to form up to a 30kVA System)

MODEL ⁸	Rated Power (VA)	Output Form	Output Voltage Max (I-n/I-l)				Internal/External Transformer Option	Function ^{6,7}	Total Height
			Direct	Transformer					
				1.5:1 ratio	2.0:1 ratio	2.5:1 ratio			
345AMX-UPC32/MST	4500	1/2 3	0-135/270 0-135/234	-	-	-	-	Master/Slave Selectable	8U
345AMX/SLV	4500	1/2 3	0-135/270 0-135/234	-	-	-	-	Dedicated Slave	8U
345AMXT-UPC32/MST	4500	1/2 3	0-135/270 0-135/234	0-202/404 0-202/350	0-270/540 0-270/468	0-338/600 0-338/585	External	Master/Slave Selectable	11U
345AMXT/SLV	4500	1/2 3	0-135/270 0-135/234	0-202/404 0-202/350	0-270/540 0-270/468	0-338/600 0-338/585	External	Dedicated Slave	11U
360AMX-UPC32/MST ¹⁰	6000	1/2 3	0-135/270 0-135/234	-	-	-	-	Master/Slave Selectable	8U
360AMX/SLV ¹⁰	6000	1/2 3	0-135/270 0-135/234	-	-	-	-	Dedicated Slave	8U
360AMXT-UPC32/MST ¹⁰	6000	1/2 3	0-135/270 0-135/234	0-202/404 0-202/350	0-270/540 0-270/468	0-338/600 0-338/585	External	Master/Slave Selectable	11U
360AMXT/SLV ¹⁰	6000	1/2 3	0-135/270 0-135/234	0-202/404 0-202/350	0-270/540 0-270/468	0-338/600 0-338/585	External	Dedicated Slave	11U

6. Parallelable "Master" delivered with UPC-32 Controller and Master/Slave select switch on rear panel
7. Dedicated "Slave" Power Source requires master of the same base model (no UPC required).
8. Complete model number for basic unit shown
9. MST formerly known as M5283, SLV formerly known as M5283/M5304
10. 4kVA in 2 phase mode

Configure your system and decide the level of flexibility for both your current and future requirements.

The paralleling option for the models 140, 160, 345, 360AMX and 140, 345, 360AMXT describes a multi-cabinet AC Power Source which can be expanded up to 5 power source chassis, to reach system power levels up to 30 kVA. Addition or deletion of chassis is easily performed by the user in the field. The system may consist of one master unit and any combination of 4 additional units which can be either Master/Slave selectable or dedicated slave units. One Master unit with UPC-12 or UPC-32 oscillator is required per system.

Example Configurations

Single Phase Paralleled Systems

POWER	Number of Master Units	Master Model Number	Number of Slave Units	Slave Model Number	Number of Chassis	Total Height
8kVA (2 x 4kVA)	1	140AMXT-UPC12/MST	1	140AMXT/SLV	2 PS + 2 XFMR	22U
	2	140AMXT-UPC12/MST	0	-		
12kVA (2 x 6kVA)	1	160AMXT-UPC12/MST	1	160AMXT/SLV	2PS + 2 XFMR	22U
	2	160AMXT-UPC12/MST	0	-		
12kVA (3 x 4kVA)	1	140AMX-UPC12/MST	2	140AMX/SLV	3 PS	24U
	2	140AMX-UPC12/MST	1	140AMX/SLV		
	3	140AMX-UPC12/MST	0	-		
16kVA (4 x 4kVA)	1	140AMX-UPC12/MST	3	140AMX/SLV	4 PS	32U
	2	140AMX-UPC12/MST	2	140AMX/SLV		
	3	140AMX-UPC12/MST	1	140AMX/SLV		
	4	140AMX-UPC12/MST	0	-		

Three Phase Paralleled Systems

POWER	Number of Master Units	Master Model Number	Number of Slave Units	Slave Model Number	Number of Chassis	Total Height
13.5kVA (3 x 4.5kVA)	1	345AMXT-UPC32/MST	2	345AMXT/SLV	3 PS + 3 XFMR	33 U
	2	345AMXT-UPC32/MST	1	345AMXT/SLV		
	3	345AMXT-UPC32/MST	0	345AMXT/SLV		
18kVA (3 x 6kVA)	1	360AMXT-UPC32/MST	2	360AMXT/SLV	3 PS + 3 XFMR	33 U
	2	360AMXT-UPC32/MST	1	360AMXT/SLV		
	3	360AMXT-UPC32/MST	0	-		
24kVA (4 x 6kVA)	1	360AMXT-UPC32/MST	3	360AMXT/SLV	4 PS + 4 XFMR	44 U
	2	360AMXT-UPC32/MST	2	360AMXT/SLV		
	3	360AMXT-UPC32/MST	1	360AMXT/SLV		
	4	360AMXT-UPC32/MST	0	-		
30kVA (5 x 6kVA)	1	360AMXT-UPC32/MST	4	360AMXT/SLV	5 PS + 5 XFMR	55 U
	2	360AMXT-UPC32/MST	3	360AMXT/SLV		
	3	360AMXT-UPC32/MST	2	360AMXT/SLV		
	4	360AMXT-UPC32/MST	1	360AMXT/SLV		
	5	360AMXT-UPC32/MST	0	-		

Addition or deletion of power source chassis is easily performed by the user in field. The standard AMX-Series features, such as automatic output form selection, extensive output metering, etc. remain intact.

Note that only like models may be paralleled with each other. That is, only 345AMX chassis may be paralleled with other 345AMX chassis, 140AMX with 140 AMX, etc. All Master units are master/slave selectable from rear panel switch.

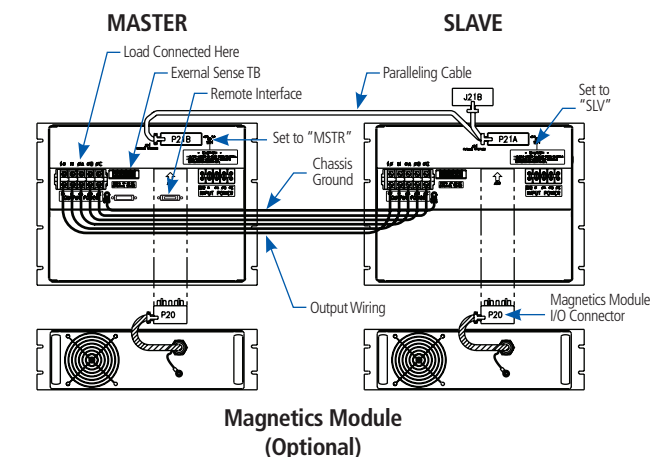

Magnetics Module (Optional)

The Power of Expertise

The Leader in Power Technology

As a privately held, leading manufacturer of high-quality AC Power Conversion Equipment, Pacific Power Source, Inc. offers standard catalog products that range in power from 500 VA to >625 kVA. Low-power products include line conditioners, frequency converters and Programmable AC Power Sources. High-power systems include programmable power test equipment, power line conditioners, frequency converters and uninterruptible AC Power Sources.

Founded in 1971, the Irvine, California, company was an early pioneer in the development of linear solid-state power conversion for use in high-reliability applications. The company now manufactures both advanced linear and broadband switching types of AC Power Sources.



17692 Fitch, Irvine, CA 92614 USA

Phone +1 949.251.1800

Fax +1 949.756.0756

800.854.2433

E-mail sales@pacificpower.com
www.pacificpower.com

ASX Series High-Density AC Test Power



The AMX and ASX Series are two families of High Performance AC Power Sources covering the power range of 500 VA to 30 kVA. The product lines offer both single and three phase models. Units are conservatively designed and rated, with output power based on the most severe combination of input line, output voltage, power factor and temperature. This approach to product design allows the AMX/ASX Series Power sources to excel when delivering the precision power demanded in the AC test environment. Great emphasis has been placed on low acoustic noise, ease of installation and maximum power per cubic inch of rack space. Control and operating features provide a high degree of application versatility and ease of use for the test engineer. Applications range from simple, manually controlled frequency conversion to harmonic testing and sophisticated bus programmable transient simulation.

AMX Series Precision AC Test Power



ACX Series Compact AC Power Source



The model 118ACX-UPC1 provides the universal connectivity, high power density, and on demand technical ability required for all your low power, single phase, AC Power Source applications. Convenient to operate from the front panel keypad or remote interface, the 118ACX-UPC1 is ideal for AC Power simulation, frequency conversion, laboratory, and bench-top power applications.

MS Series High Power Frequency Converter



MS Series equipment is a family of High Performance Line Conditioners/ Frequency Converters designed to provide highly flexible, yet reliable, AC power ranging from 62.5 to >625 kVA. Combined with the optional SCU/UPC32 Programmable Controller, the 3060-MS becomes a fully featured AC Test power system.



Schulz Electronic
Professional Power Supplies

Schulz-Electronic GmbH
Dr.-Rudolf-Eberle-Straße 2
D-76534 Baden-Baden
Fon +49.7223.9636.30
Fax +49.7223.9636.90
vertrieb@schulz-electronic.de
www.schulz-electronic.de