



**Advanced Test Equipment Rentals**  
**www.atecorp.com 800-404-ATEC (2832)**

# Portable Surface Roughness Tester **SURFTEST SJ-410 Series**

Bulletin No. 2080



## Portable surface roughness tester evolution

Rich choice of options provide easier, smoother and more accurate measurements



# Portable surface roughness tester evolves!

The large touch-screen, color-graphic LCD ensures both intuitive control and advanced operability

## Enhanced power for making measurements on site

### Color-graphic LCD

The color-graphic LCD with excellent visibility displays calculated results and assessed profiles even clearer. This is really useful for checking results without printing them out.

### Backlight provided

A backlight improves usability in dim testing environments.

### Touch screen for easier operations

The screen display can be switched between icon display and text display. Successfully combining operability with utility and usability.



Icon display

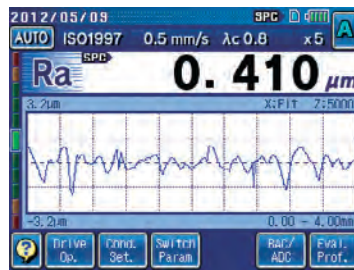

Text display

### Easy to use and highly functional

This portable surface roughness tester is equipped with analysis functionality rivaling that of benchtop surface roughness testers.

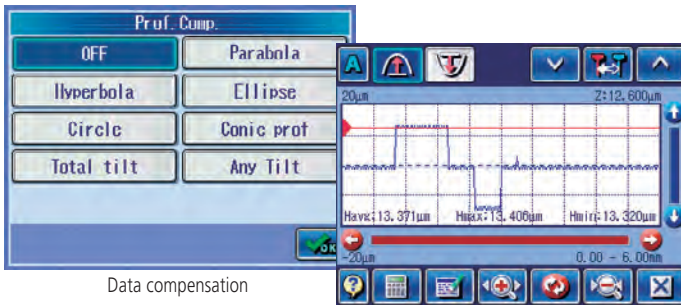

Data compensation

Simple contour analysis function

## Applicable standards

### Complies with many industry standards

The SurfTest SJ-410 complies with the following standards: JIS (JIS-B0601-2001, JIS-B0601-1994, JIS B0601-1982), VDA, ISO-1997, and ANSI.



## Multilingual support

The display interface supports 16 languages.



## High accuracy measuring

### A wide range, high-resolution detector

Measuring range/ resolution  
 800 $\mu$ m/0.01 $\mu$ m  
 80 $\mu$ m/0.001 $\mu$ m  
 8 $\mu$ m/0.0001 $\mu$ m

### High straightness drive unit

Straightness/ traverse length  
 0.3 $\mu$ m/25mm (SJ-411)  
 0.5 $\mu$ m/50mm (SJ-412)



# Surftest SJ-410

## Interfaces

### A variety of interfaces supplied as standard

The external device interfaces that come as standard include USB, RS-232C, SPC output and footswitch I/F.



## Data storage

### Memory card (optional) is supported

The measurement conditions and data can be stored in a memory card (optional) and recalled as required. This enables batch analysis and printout of data after on-site measurement.



- **Measurement condition**  
Internal memory: 10 sets  
Memory card: 500 sets
- **Measurement result**  
Memory card: 1000 sets

## Password protection

### Access to functions can be restricted by a password

A pre-registered password can limit use of measurement conditions and other settings to the tester's administrator.

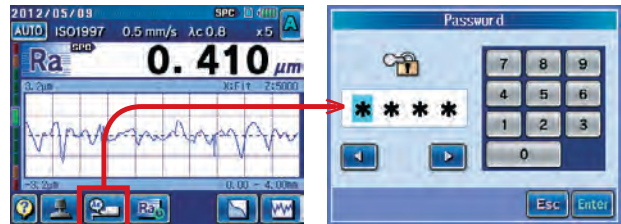

## Key-sheet buttons

A sturdy key-sheet-button panel with superior durability in any environment is provided. For repeat measurement of the same work, simply pressing the start switch can complete measurement, analysis and printout.

## Printer

### High-speed printer prints out measurement results on site

A high-quality, high-speed thermal printer prints out measurement results. It can also print a BAC curve or an ADC curve as well as calculated results and assessed profiles. These results and profiles are printed out in landscape format, just as they appear on the color-graphic LCD.

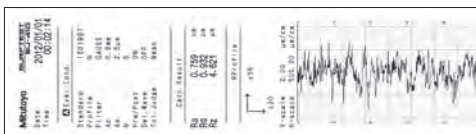

## Carrying case

The unit is easily transported in a dedicated carrying case which includes holders for the accessories as well as the tester itself. (Standard accessory.)





# Enhanced measuring functions

## Your choice of skidless or skidded measurement

Patent registered in Japan, U.S.A.. Patent pending in Germany

### • Skidless measurement

Skidless measurement is where surface features are measured relative to the drive unit reference surface. This measures waviness and finely stepped features accurately, in addition to surface roughness, but range is limited to the stylus travel available. The SJ-410 series supports a variety of surface feature measurements simply by replacing the stylus.

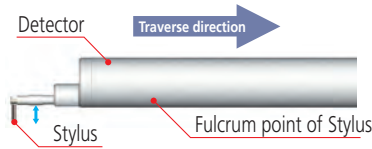

Measuring example of stepped features: Skidless



Measured profile



### • Skidded measurement

In skidded measurements, surface features are measured with reference to a skid following close behind the stylus. This cannot measure waviness and stepped features exactly but the range of movement within which measurement can be made is greater because the skid tracks the workpiece surface contour.

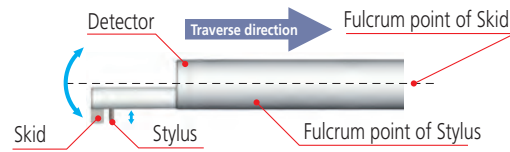

Measuring example of stepped features: Skidded



Measured profile



## Powerful support for leveling

Patent registered in Japan, U.S.A.. Patent pending in Germany

The height/tilt adjustment unit comes as standard for leveling the drive unit prior to making skidless measurements and, supported by guidance from the unique D.A.T. function, makes it easy to achieve highly accurate alignment.

### • Height/tilt adjustment unit (Standard accessory)



Height/tilt adjustment unit

Tilt adjustment knob

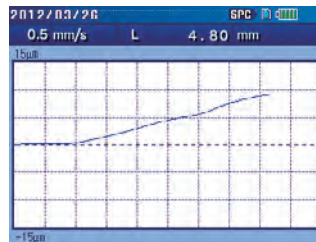

Preliminary measurement

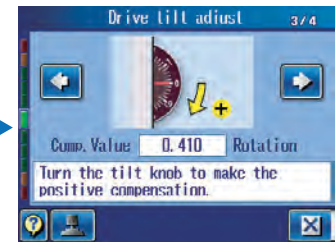

Amount of tilt adjustment

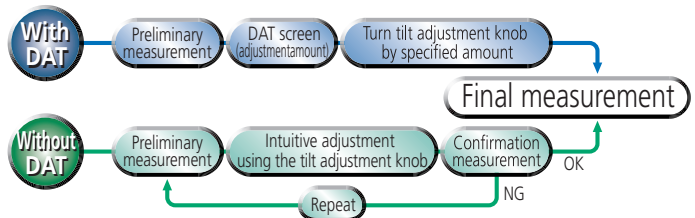

When the SJ-410 Series detector is mounted on the manual column stand\*<sup>1</sup> for measurement, it can be combined with any of the optional products for easier leveling: leveling table\*<sup>1</sup>, 3-axis alignment table\*<sup>1</sup> or tilt adjustment unit\*<sup>1</sup>.

\*1: For details about optional products, see P6-7.

## More measuring functions than expected from a compact tester

Usually, a spherical or cylindrical surface (R-surface) cannot be evaluated, but, by removing the radius with a filter, R-surface data is processed as if taken from a flat surface.

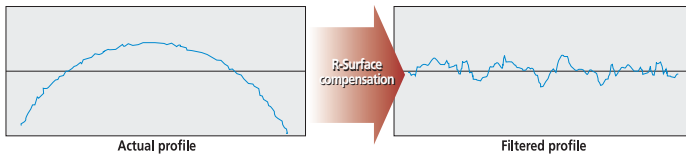

## Recalculating

Previously measured data can be recalculated for use in other evaluations by changing the current standard, assessed profile and roughness parameters.

## GO/NG judgement function

An "OK/NG" judgment symbol is displayed when limits are set for the roughness parameter. In case of "NG," the calculated result is highlighted. The calculated result can also be printed out.



Calc. Result		
Ra	↑ 1.103	μm
Rq	OK 1.427	μm
Rz	↓ 7.259	μm

The "OK" symbol means the measurement is within the limits set; "NG" means it is not, in which case an arrow points to either the upper or lower limit in the printout.

## Assessing a single measurement result under two different evaluation conditions

A single measurement enables simultaneous analysis under two different evaluation conditions. A single measurement allows calculation of parameters and analysis of assessed profiles without the need for recalculation after saving data, contributing to higher work efficiency.

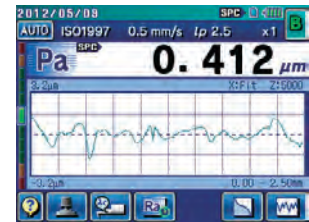

## Arbitrary sampling length setting

This function allows a sampling length to be arbitrarily set in 0.01mm increments (SJ-411: 0.1mm to 25mm, SJ-412: 0.1mm to 50mm). It also allows the SJ-410 series to make both narrow and wide range measurements.

## Narrow space measuring function Patent pending in Japan

Surface roughness measurement requires a run-up distance before starting the measurement (or retrieving data). When the SJ-410 Series measures, its run-up distance is normally set to 0.5mm. This distance, however, can be shortened to 0.15mm using the narrow part measurement function (starting from the origin point of the drive unit). The function extends the possibility of measurement of narrow locations such as grooves in piston ring / O-ring mounts.

### • Narrow space measuring Typical applications

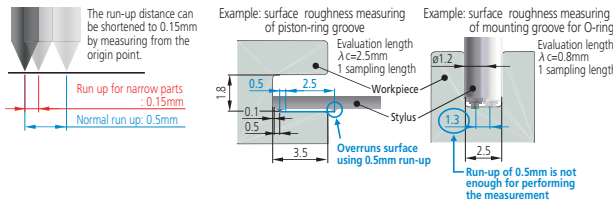

## Real sampling

This function samples stylus displacement for a specified time without engaging detector traverse, which enables use as a simplified vibration meter or displacement gage incorporated in another system.

## Simple contour analysis function

Point group data collected for surface roughness evaluation is used to perform simplified contour analysis (step, step height, area and coordinate variation). It assesses minute forms that cannot be assessed by a contour measurer.

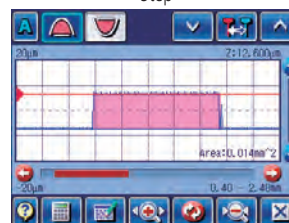
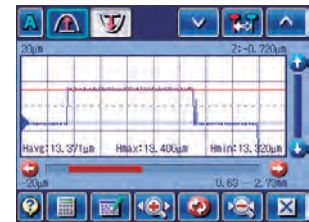

# Optional Accessories

## Simple column stand

Can be adjusted to match the height of the item to be measured.

### No.178-039

Vertical adjustment range: 250mm  
Dimensions: 400x250x578mm  
Mass: 20kg

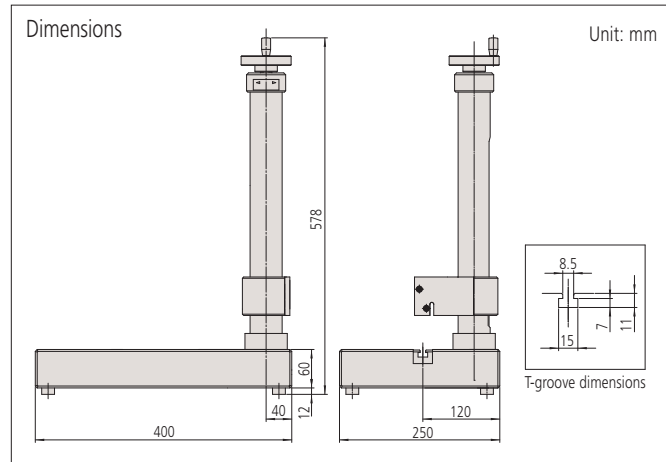

## Options for simple column stand

Three new optional products are available to be attached to the manual column stand (No.178-039). You can choose the unit that suits your application. Or, you can also use the three products in any combination. Using the optional units makes SJ-411/412 more convenient and easier to use to ensure accurate measurements.

### •Auto-set unit (178-010)\*

This unit enables the vertical (Z axis) direction to be positioned automatically (auto-set function).

A single button operation completes a series of operations from measurement, saving and auto-return (saving and auto-return can be switched on and off by operating the drive unit).



### •X-axis adjustment unit (178-020)\*

This unit helps fine-tune the horizontal (X axis) direction.

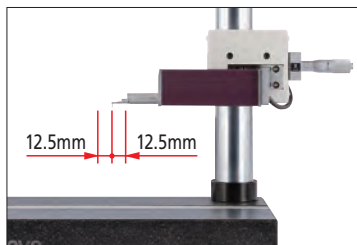

### •Tilting adjustment unit (178-030)\*

This unit is used for aligning the workpiece surface with the detector reference plane. It supports the DAT function to make the leveling of workpiece surfaces easier.

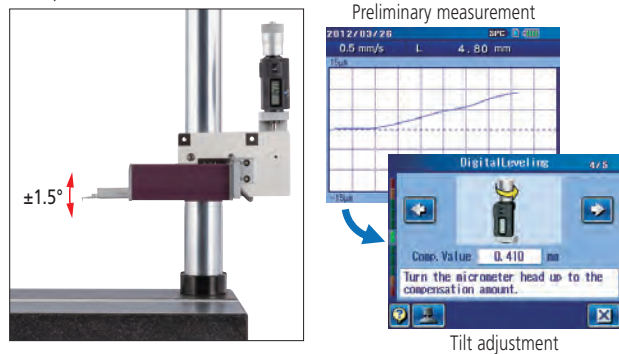

### Complete set of optional units for the manual column stand

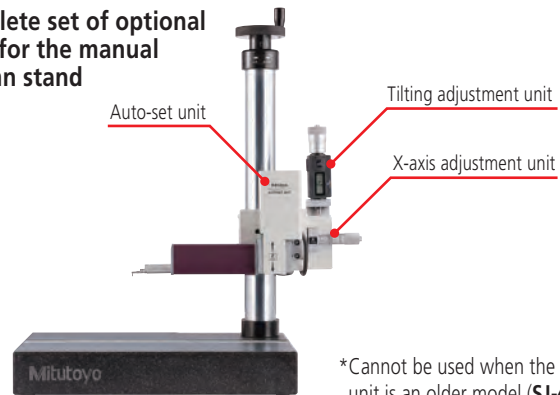

\*Cannot be used when the tester's main unit is an older model (SJ-401/402).

### 3-axis Adjustment Table: 178-047

Patent registered in Japan, U.S.A... Patent pending in Germany

This table helps make the alignment adjustments required when measuring cylindrical surfaces. The corrections for the pitch angle and the swivel angle are determined from a preliminary measurement and the Digimatic micrometers are adjusted accordingly. A flat-surfaced workpiece can also be leveled with this table.

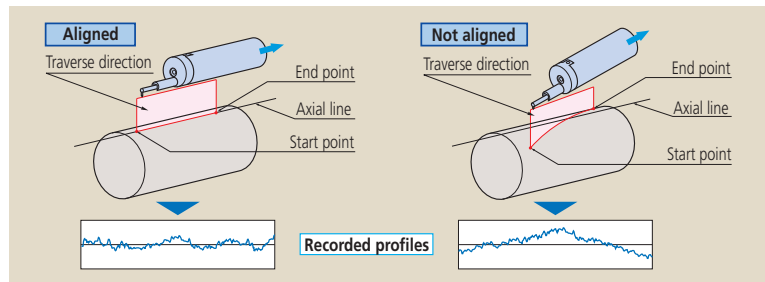

### DAT Function for the optional leveling table

Patent registered in Japan, U.S.A... Patent pending in Germany

The levelling table can be used to align the surface to be tested with the detector reference plane. The operator is guided through the procedure by screen prompts.



**No. 178-048**  
Inclination adjustment angle:  $\pm 1.5^\circ$   
Table dimensions: 130x100mm  
Maximum load: 15kg

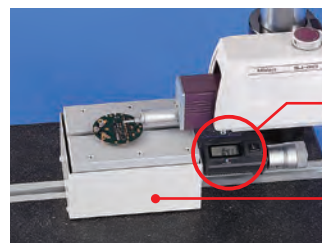

DAT screen guides the user when leveling  
Digimatic micrometer head  
Amount of micrometer head adjustment required  
Leveling table (DAT) (Option)

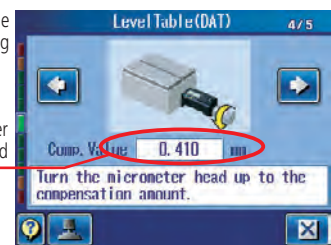

### XY leveling tables

The tester includes X- and Y-axes micrometer heads. This makes axis alignment much easier because the tilt adjustment center is the same as the rotation center of the table.  
(Code No. 178-042-1/178-043-1)

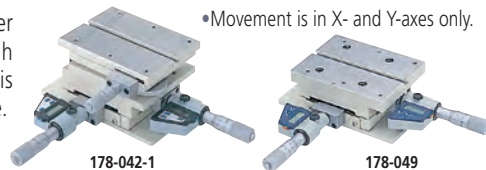

Order No.	178-042-1(mm) 178-052-1(inch) *with digital heads	178-043-1(mm) 178-053-1(inch) *with analog heads	178-049(mm) 178-058(inch/mm) *with digital heads
Table dimensions	130x100mm		
Maximum load	15kg		
Inclination adjustment angle	$\pm 1.5^\circ$		
Swiveling angle	$\pm 3^\circ$		
XY-axis travel range	$\pm 12.5$ mm	$\pm 12.5$ mm	$\pm 12.5$ mm
Resolution	0.001mm	0.01mm	0.001mm
Dimensions (WxDxH)	262x233x83mm	220x189x83mm	262x233x55mm
Mass	6.3kg	6kg	5kg

\*T-groove dimensions

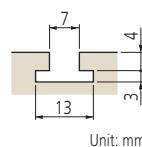

### Precision vise

• Fits on the stand.

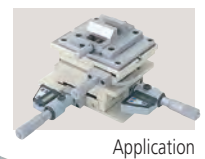

Order No.	178-019
Clamping method	Sliding jaws
Jaw opening	36mm
Jaw width	44mm
Jaw depth	16mm
Height	38mm

### Cylinder attachment

This block can be positioned on top of cylindrical objects to perform measurements.

**No. 12AAB358**  
Diameter:  $\phi 15\text{--}60$ mm

Configuration:

- Cylindrical measurement block
- Auxiliary block
- Clamp

\*Drive unit not included.

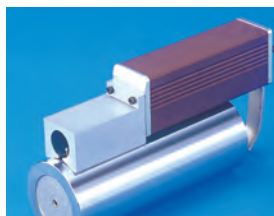

### Reference step specimen

Used to calibrate detector sensitivity.

**No. 178-611**  
Step nominal values:  $2\mu\text{m}/10\mu\text{m}$





# Optional Accessories: Detectors / Styli

## Detectors

Unit: mm

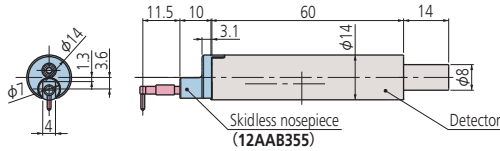

Order No.	Measuring force	
178-396-2	0.75mN	ISO-1997 and JIS-2001 compliant detectors
178-397-2	4mN	Detectors that comply with previous standards, for general use, etc.

## Extension rods

- 12AAG202 Extension rod 50mm
- 12AAG203 Extension rod 100mm



\* No more than one extension rod can be connected.

## Styli

Unit: mm

### Standard stylus

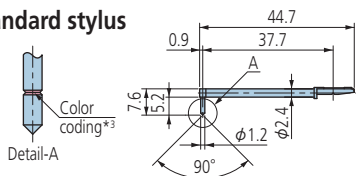

- 12AAE882 (1μm) \*1
  - 12AAE924 (1μm)
  - 12AAC731 (2μm) \*1
  - 12AAB403 (5μm)
  - 12AAB415 (10μm)
  - 12AAE883 (250μm) \*4
- ( ): Tip radius

### Double-length for deep hole \*2

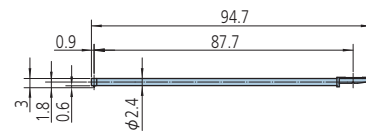

- 12AAE898 (2μm) \*1
  - 12AAE914 (5μm)
- ( ): Tip radius

### For small hole

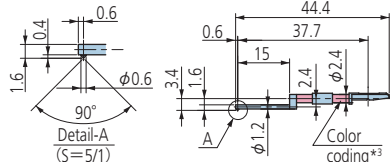

- 12AAC732 (2μm) \*1
  - 12AAB404 (5μm)
  - 12AAB416 (10μm)
- ( ): Tip radius

### For small hole / Double-length for deep hole \*2

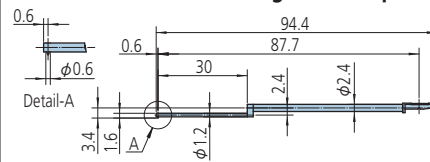

- 12AAE892 (2μm) \*1
  - 12AAE908 (5μm)
- ( ): Tip radius

### For extra-small hole

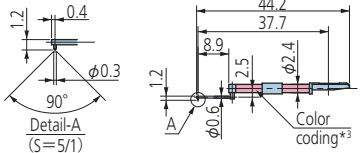

- 12AAC733 (2μm) \*1
  - 12AAB405 (5μm)
  - 12AAB417 (10μm)
- ( ): Tip radius

### For small hole \*2 \*4

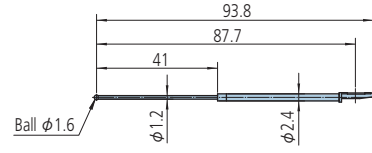

- 12AAE884 (φ1.6mm)
- ( ): Tip radius

### For ultra-small hole

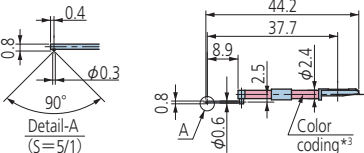

- 12AAC734 (2μm) \*1
  - 12AAB406 (5μm)
  - 12AAB418 (10μm)
- ( ): Tip radius

### For ultra-small hole \*4

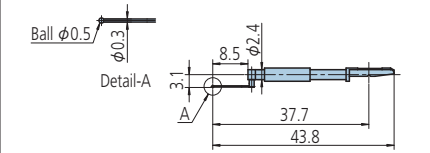

- 12AAJ662 (φ0.5mm)
- ( ): Tip radius

### For deep hole (double-length and triple-length) \*2

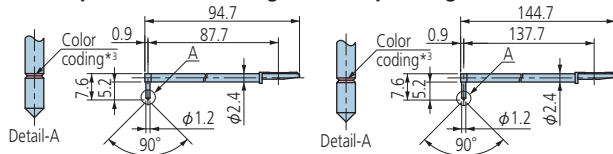

- 2X stylus
- 12AAC740 (2μm) \*1
  - 12AAB413 (5μm)
  - 12AAB425 (10μm)
- ( ): Tip radius

- 3X stylus
- 12AAC741 (2μm) \*1
  - 12AAB414 (5μm)
  - 12AAB426 (10μm)
- ( ): Tip radius

### For small slotted hole \*2

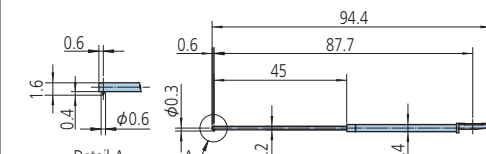

- 12AAE938 (2μm) \*1
  - 12AAE940 (5μm)
- ( ): Tip radius

\*1: Tip angle 60°

\*2: For downward-facing measurement only.

\*3:

Tip radius	1μm	2μm	5μm	10μm	250μm
Color coding	White	Black	No color	Yellow	No notch or color

\*4: Used for calibration, a standard step gauge (No.178-611, option) is also required



# Styli

Unit: mm

## For deep groove (10mm)

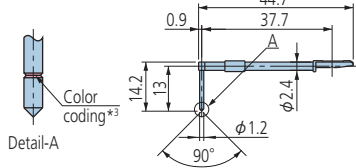

12AAC735 (2μm) \*1  
12AAB409 (5μm)  
12AAB421 (10μm)  
( ): Tip radius

## For deep groove \*2 (20mm)

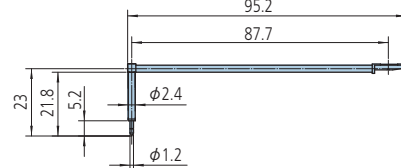

12AAE893 (2μm) \*1  
12AAE909 (5μm)  
( ): Tip radius

## For deep groove \*2 (20mm)

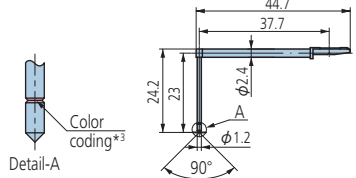

12AAC736 (2μm) \*1  
12AAB408 (5μm)  
12AAB420 (10μm)  
( ): Tip radius

## For deep groove \*2 (40mm)

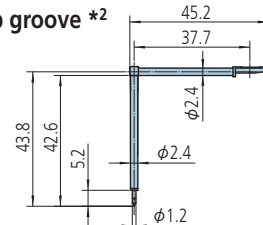

12AAE895 (2μm) \*1  
12AAE911 (5μm)  
( ): Tip radius

## For deep groove \*2 (30mm)

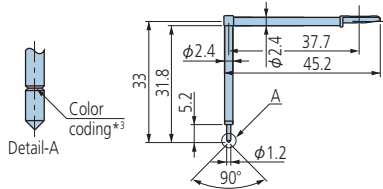

12AAC737 (2μm) \*1  
12AAB407 (5μm)  
12AAB419 (10μm)  
( ): Tip radius

## For deep groove (30mm) / Double-length for deep hole \*2

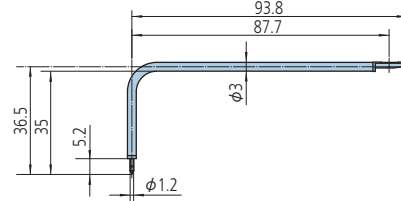

12AAE894 (2μm) \*1  
12AAE910 (5μm)  
( ): Tip radius

## For gear tooth

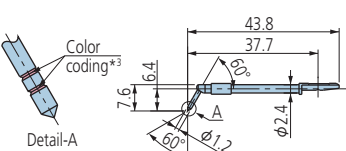

12AAB339 (2μm) \*1  
12AAB410 (5μm)  
12AAB422 (10μm)  
( ): Tip radius

## For gear tooth / Double-length for deep hole \*2

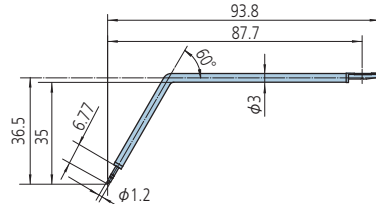

12AAE896 (2μm) \*1  
12AAE912 (5μm) \*1  
( ): Tip radius

## For rolling circle waviness surface \*4

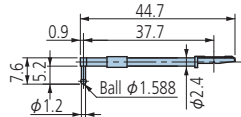

12AAB338 (φ1.588)  
( ): Tip radius

## For rolling circle waviness / Double-length for deep hole \*2 \*4

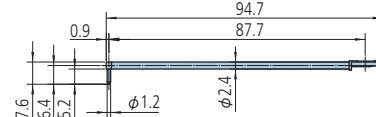

12AAE886 (250μm)  
( ): Tip radius

## For knife-edge \*4

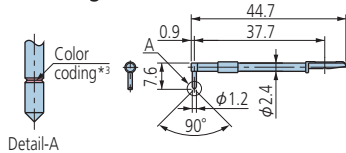

12AAC738 (2μm) \*1  
12AAB411 (5μm)  
12AAB423 (10μm)  
( ): Tip radius

## For corner hole / Double-length for deep hole \*2

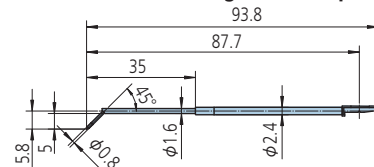

12AAE897 (2μm) \*1  
12AAE913 (5μm) \*2  
( ): Tip radius

## For eccentric arm \*2

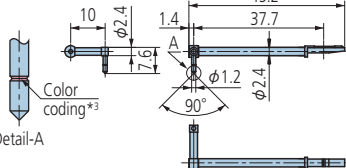

12AAC739 (2μm) \*1  
12AAB412 (5μm)  
12AAB424 (10μm)  
( ): Tip radius

## For hole bottom

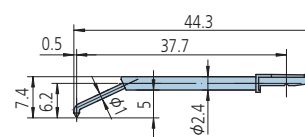

12AAE899 (2μm) \*1  
12AAE915 (5μm)  
( ): Tip radius

\*1: Tip angle 60°

\*2: For downward-facing measurement only.

\*3: Customized special interchangeable styli are available on request. Please contact any Mitutoyo office for more information.

\*3:

Tip radius	2μm	5μm	10μm
Color coding	Black	No color	Yellow

\*4: Used for calibration, a standard step gauge (No.178-611, option) is also required

# Optional Accessories: For External Output

## Contour / Roughness analysis software FORMTRACEPAK

More advanced analysis can be performed by loading SJ-410 series measurement data to software program FORMTRACEPAK via a memory card (option) for processing back at base.

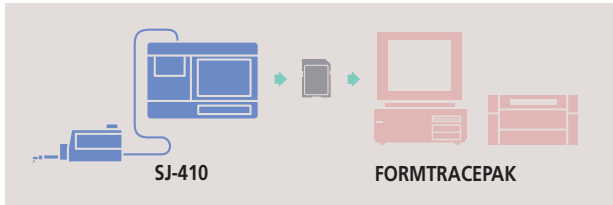

## Digimatic mini processor DP-1VR

By connecting this printer to the Surfctest SJ-410's digimatic output, you can print calculation results, perform a variety of statistical analyses, draw a histogram or D chart, and also perform complicated operations for X-R control charts.



No.264-504 -5A

SJ-410 → DP-1VR Connecting cable  
1m: No.936937  
2m: No.965014

## Measurement Data Wireless Communication System U-WAVE

This unit allows you to remotely load Surfctest SJ-410 calculation results (SPC output) into commercial spreadsheet software on a PC. You can essentially use a one-touch operation to enter the calculation results (values) into the cells in the spreadsheet software.



**U-WAVE-R**  
(Connects to the PC)  
No.02AZD810D



**U-WAVE-T \***  
(Connects to the SJ-410)  
No.02AZD880D

\*Requires the optional Surfctest SJ-410 connection cable.

No.02AZD790D

## Simplified communication program for SURFTEST SJ series

The Surfctest SJ-410 series has a USB interface, enabling data to be transferred to a spreadsheet or other software. We also provide a program that lets you create inspection record tables using a Microsoft Excel\* macro.

This program can be downloaded free of charge from the Mitutoyo website.  
<http://www.mitutoyo.co.jp>

### Required environment\*

- OS: Windows XP-SP3  
Windows Vista  
Windows 7
- Spreadsheet software: Microsoft Excel 2002  
Microsoft Excel 2003  
Microsoft Excel 2007  
Microsoft Excel 2010

\*Windows OS and Microsoft Excel are products of Microsoft Corporation.

### The optional USB cable is also required.

- USB cable for SJ-410 series No.12AAD510

## Calculation results input unit INPUT TOOL

This unit allows you to load Surfctest SJ-410 calculation results (SPC output) into commercial spreadsheet software on a PC via a USB connector. You can essentially use a one-touch operation to enter the calculation results (values) into the cells in the spreadsheet software.



**USB-ITN-D**  
No.06ADV380D



**USB keyboard signal conversion type\*  
IT-012U**  
No.264-012-10

\*Requires the optional Surfctest SJ-410 connection cable.

1m: No.936937  
2m: No.965014

## Optional accessories, consumables, and others for SJ-410

- Printer paper (5 rolls) No.270732
- Durable printer paper (5 rolls) No.12AAA876
- Touch-screen protector sheet (10 sheets) No.12AAN040
- Memory card (2GB) \* No.12AAL069
- Connecting cable (for RS-232C) No.12AAA882

\*micro SD card (with a conversion adapter to SD card)

# Specifications

Model No.	inch/mm	SJ-411		SJ-412	
		178-581-01A	178-581-02A	178-583-01A	178-583-02A
Measuring range	X axis	25mm (1inch)		50mm (2inch)	
	Z1 axis (detector unit)	800 $\mu$ m, 80 $\mu$ m, 8 $\mu$ m *Up to 2,400 $\mu$ m with an optional stylus			
Detector	Measuring principle	Differential inductance			
	Resolution	0.01 $\mu$ m (800 $\mu$ m range) / 0.001 $\mu$ m (80 $\mu$ m range) / 0.0001 $\mu$ m (8 $\mu$ m range) 0.4 $\mu$ inch (32000 $\mu$ inch) / 0.04 $\mu$ inch (3200 $\mu$ inch) / 0.004 $\mu$ inch (320 $\mu$ inch)			
	Stylus tip	60°/2 $\mu$ m (80 $\mu$ inch)	90°/5 $\mu$ m (200 $\mu$ inch)	60°/2 $\mu$ m (80 $\mu$ inch)	90°/5 $\mu$ m (200 $\mu$ inch)
	Measuring force	0.75mN	4mN	0.75mN	4mN
	Radius of skid curvature	R40 mm (R1.57")			
	Measuring method	Skidded measurement / skidless measurement			
Drive unit: X-axis	Measuring speed	0.05, 0.1, 0.2, 0.5, 1.0mm/s (0.002, 0.004, 0.02, 0.04 inch/s)			
	Drive speed	0.5, 1, 2, 5mm/s (0.02, 0.04, 0.08, 0.2 inch/s)			
	Straightness	0.3 $\mu$ m / 25mm (12 $\mu$ inch/ 1inch)		0.5 $\mu$ m / 50mm (20 $\mu$ inch/ 2inch)	
Height-tilt adjustment unit	Height adjustment	10mm (0.39inch)			
	Tilt adjustment	$\pm$ 1.5°			
Standards	JIS1982 / JIS1994 / JIS2001 / ISO1997 / ANSI / VDA				
Parameters	Ra, Rq, Rz, Ry, Rp, Rv, Rt, R3z, Rsk, Rku, Rc, Rpc, RSm, Rmax*1, Rz1max*2, S, HSC, RzJIS*3, Rppi, R $\Delta$ a, R $\Delta$ q, Rlr, Rmr, Rmr(c), R $\sigma$ c, Rk, Rpk, Rvk, Mr1, Mr2, A1, A2, Vo, $\lambda$ a, $\lambda$ q, Lo, Rpm, tp*4, Htp*4, R, Rx, AR, W, AW, Wx, Wte, Possible Customize				
Measured profiles	Primary, Roughness, DF, Filtered waviness curve, R-Motif, W-Motif				
Graph analysis	BAC and ADC curves				
Data compensation	Parabola/ Hyperbola/ Ellipse/ Circle/ Conic/ Tilting, Compensation off				
Filter	2CR, PC75, Gaussian filter				
Cut-off length	$\lambda_c$	0.08, 0.25, 0.8, 2.5, 8.0mm			
	$\lambda_s$ *5	2.5, 8.0, 25mm (100, 320, 1000 $\mu$ inch)			
Sample length	0.08, 0.25, 0.8, 2.5, 8.0, 25.0mm				
Number of sampling lengths	x1, x2, x3, x4, x5, x6, x7, x8, x9, x10, x11, x12, x13, x14, x15, x16, x17, x18, x19, x20				
Arbitrary length	0.1~25mm		0.1~50mm		
	Customization	Desired parameters can be selected for calculation and display			
Functions	Simple contour analysis function	Step, Step volume, Dimensions, Coordinate difference			
	DAT function	Helps to adjust leveling during skidless measurement			
	Real sampling function	Samples stylus displacement for a specified time without engaging detector traverse.			
	Statistical processing	Static measurement (max. 3 parameters) is possible. Static processing for MAX, MIN, AVERAGE, standard deviation, histogram and pass rate is possible			
	GO/ NG judgement*6	Max rule / 16% rule / Average rule / Standard deviation (1 $\sigma$ , 2 $\sigma$ , 3 $\sigma$ )			
	Storage functions	10 measuring conditions can be stored in internal memory			
	Printing function	Measurement conditions / Calculation results / GO / NG judgement result / Calculation results for each sampling length / Measurement curve / BAC / ADC / Environmental setting information			
	Display languages	Japanese, English, German, French, Italian, Spanish, Portuguese, Korean, Traditional Chinese, Simplified Chinese, Czech, Polish, Hungarian Turkish, Swedish, Dutch			
	Storage	Internal memory: Measurement condition (10 sets) Memory card (option): 500 measurement condition, 10000 measuring data, 10000 text data, 500 statistic data, 1 backup of machine setting, the last ten traces (Trace 10)			
	External I/O	USB I/F, Digimatic output, RS-232C I/F, External SW I/F			
Power supply	Battery	Two-way power supply: battery (rechargeable Ni-MH battery) and AC adapter *Charging time: about 4 hours (may vary due to ambient temperature) *Endurance: about 1500 measurements (differs slightly due to use conditions / environment)			
	Power consumption	50W			
Size (WxDxH)	Display unit	275x198x109mm (10.83x4.29x7.80inch)			
	Height adjustment unit	130.9x63x99mm (5.16x2.48x3.90 inch)			
	Drive unit	128x35.8x46.6mm (5.04x1.41x1.83 inch)	154.5x35.8x46.6mm (6.08x1.41x1.83inch)		
Mass	Display unit	1.7kg			
	Height adjustment unit	0.4kg			
	Drive unit	0.6kg		0.64kg	
Standard accessories	Detector*7, Stylus*8, Roughness specimen <b>270732</b> Printing paper <b>12BAL402</b> Touch-screen protection sheet		<b>12BAG834</b> Touch pen <b>12AAN041</b> Carrying case		AC adapter, Philips screwdriver, Strap for stylus pen, Operation manual, Quick reference manual, Warranty

\*1: Only for VDA/ANSI/JIS'82 standards.

\*2: Only for JIS'97 standard.

\*3: Only for JIS'01 standard.

\*4: Only for ANSI standard.

\*5:  $\lambda_s$  may not be switchable depending on standard selected.

\*6: Standard deviation only can be selected in ANSI.16% rule cannot be selected in VDA.

\*7: Either **No.178-396-2** or **No.178-397-2** is supplied as a standard accessory depending on the Order No. of the main unit for SJ-410 Series.

\*8: The standard stylus (**No.12AAC731** or **No.12AAB403**), which is compatible with the detector supplied, is a standard accessory.

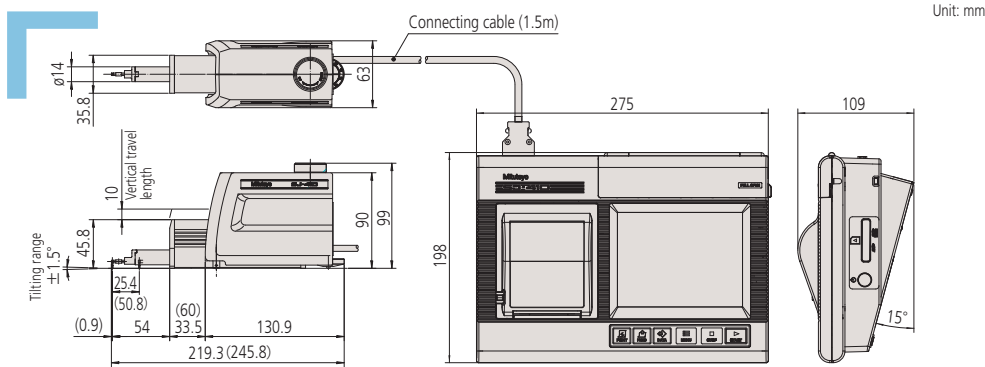

\*The dimensions in parentheses indicate those for SJ-412

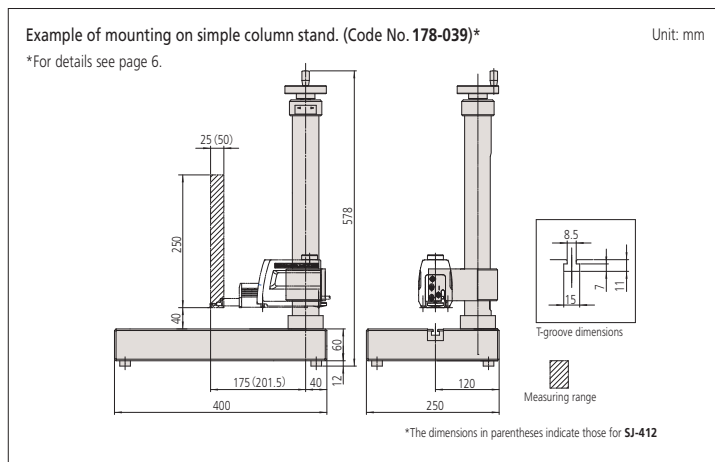

\*The dimensions in parentheses indicate those for SJ-412

**Note:** All information regarding our products, and in particular the illustrations, drawings, dimensional and performance data contained in this printed matter as well as other technical data are to be regarded as approximate average values. We therefore reserve the right to make changes to the corresponding designs. The stated standards, similar technical regulations, descriptions and illustrations of the products were valid at the time of printing. In addition, the latest applicable version of our General Trading Conditions will apply. Only quotations submitted by ourselves may be regarded as definitive.

Mitutoyo products are subject to US Export Administration Regulations (EAR). Re-export or relocation of our products may require prior approval by an appropriate governing authority.

**Trademarks and Registrations**

Designations used by companies to distinguish their products are often claimed as trademarks. In all instances where Mitutoyo America Corporation is aware of a claim, the product names appear in initial capital or all capital letters. The appropriate companies should be contacted for more complete trademark and registration information.

Unit: mm

- Coordinate Measuring Machines
- Vision Measuring Systems
- Form Measurement
- Optical Measuring
- Sensor Systems
- Test Equipment and Seismometers
- Digital Scale and DRO Systems
- Small Tool Instruments and Data Management

**Mitutoyo America Corporation**

www.mitutoyo.com

One Number to Serve You Better  
1-888-MITUTOYO (1-888-648-8869)

**M<sup>3</sup> Solution Centers**

- Aurora, Illinois  
(Corporate Headquarters)
- Westford, Massachusetts
- Huntersville, North Carolina
- Mason, Ohio
- Plymouth, Michigan
- City of Industry, California
- Birmingham, Alabama

**Mitutoyo**  
Precision is our Profession