



## AC/DC Electronic load

### MODEL 63800 SERIES

#### Key Features :

- Power Rating : 1800W, 3600W, 4500W
- Voltage Range : 50V - 350Vrms
- Current Range : Up to 18Arms, 45Arms
- Peak Current : Up to 54A, 135A
- Parallel / 3-Phase Function
- Frequency Range : 45 to 440Hz, DC
- Crest Factor Range : 1.414 to 5.0
- Power Factor Range : 0 to 1 lead or lag (Rectified mode)
- CC, CR, CV, CP for DC Loading
- Constant & Rectified Load Modes for AC Loading
- Analog Voltage & Current Monitor
- Timing Measurement for Battery, UPS, Fuse and Breaker tests
- Measurement : V, I, PF, CF, P, Q, S, F, R, Ip-/+ and THDv
- Short circuit simulation
- Full Protection : OP, OC, OV and OT protection
- GPIB & RS-232 interfaces



## PROGRAMMABLE AC/DC ELECTRONIC LOAD MODEL 63800 SERIES

Chroma's 63800 Series AC/DC Electronic Loads are designed for testing uninterruptible power supplies(UPS), Off-Grid Inverters, AC sources and other power devices such as switches, circuit breakers, fuses and connectors.

The Chroma 63800 Loads can simulate load conditions under high crest factor and varying power factors with real time compensation even when the voltage waveform is distorted. This special feature provides real world simulation capability and prevents over-stressing thereby giving reliable and unbiased test results.

The 63800's state of the art designed uses DSP technology to simulate non-linear rectified loads in a unique RLC operation mode. This mode improves stability by detecting the impedance of the UUT and dynamically

adjusting the load's control bandwidth to ensure system stability.

Comprehensive measurements allow users to monitor the output performance of UUT. Additionally, voltage & current signals can be routed to an oscilloscope through analog outputs. The instrument's GPIB/RS232 interface options provide remote control & monitor for system integration. In addition, built-in digital outputs may be used to control external relays for short circuit (crowbar) testing.

Chroma's 63800 Loads also feature fan speed control ensuring low acoustic noise. The diagnosis/protection functions include self-diagnosis routines and protection against over-power, over-current, over-voltage and over-temperature.



**Chroma**

# Complete AC & DC Load Simulations

Chroma's 63800 AC/DC Electronic Load is designed for both AC & DC Load Simulations. Illustrated below are the various load modes which are available:

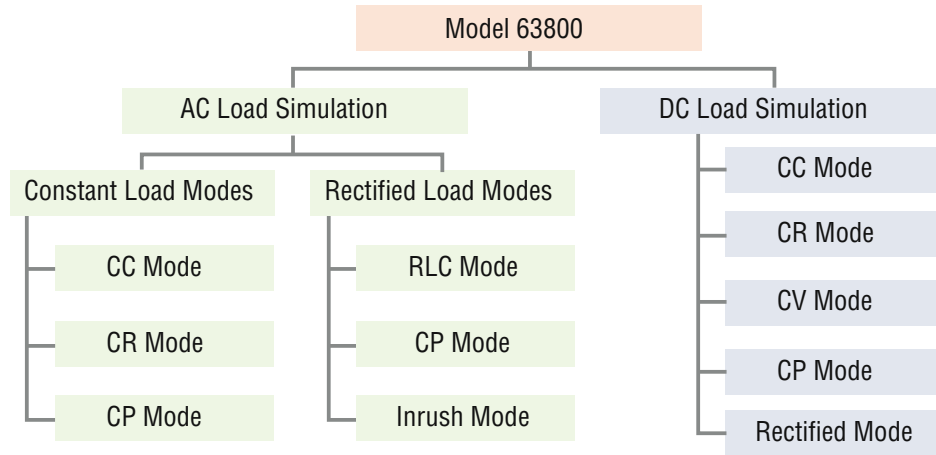

## AC Load Simulation

The Model 63800 AC/DC Electronic Load provides two unique operating modes for AC load simulation; (1) Constant Load Modes and (2) Rectified AC Load Modes. Each are described below.

### Constant Load Modes

The Constant Load Modes allow users to set the following operating modes : CC, CR and CP mode. The CC & CP modes in this category allow users to program PF or CF, or both. For CR mode the PF is always set to 1.

When both the PF & CF of the loading current are programmed, the 63800 load controls power factor from 1 to 0 by shifting the current (with CF defined) relative to the input voltage to get desired displacement power factor. The power factor range will be limited based on crest factor programmed. If the programmed PF is positive then the current will lead the voltage waveform, in opposite, when PF is set negative, the current will then lag the voltage waveform. (See below)

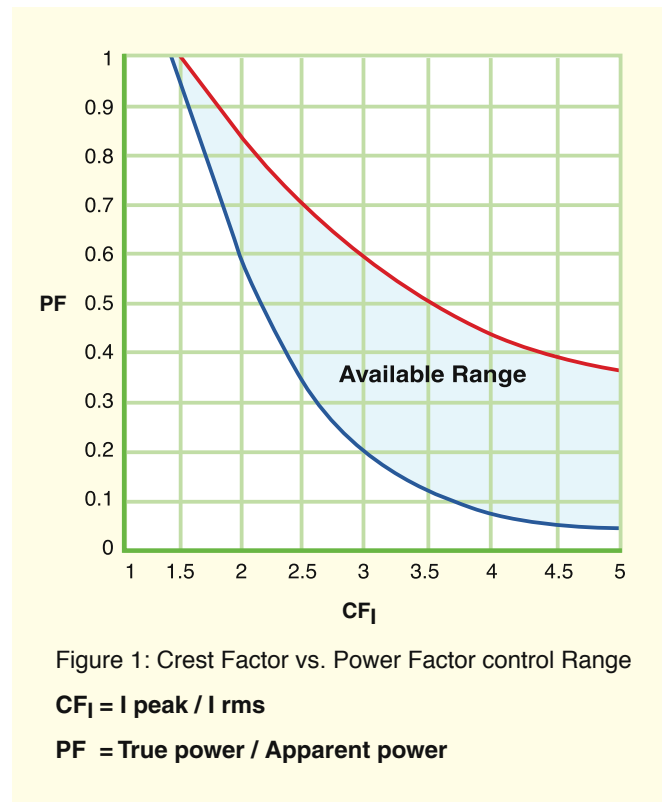
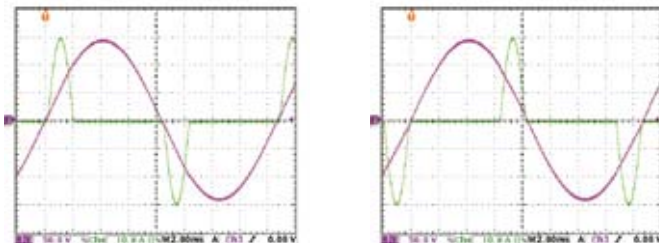

As seen in Figure 1, for a crest factor of 1.414, the programmed power factor can only be 1 if the input voltage is sine-wave. However, for a CF of 2.0, the acceptable PF ranges from 0.608 to 0.85; for CF = 3, the PF can then be set from 0.211 to 0.6, etc. So, higher crest factors enable wider range of power factors.

## Rectified AC Load Modes

The 63800 AC/DC Electronic Load provides unique capability to simulate non-linear rectified loads for a wide range of testing applications. There are three load modes available for rectified load simulations-RLC, CP and Inrush Current modes.

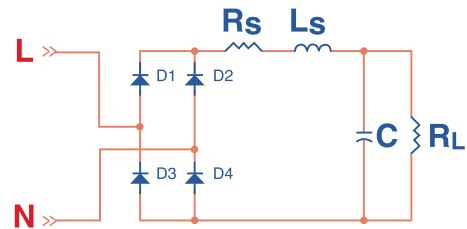

Figure 2 : Typical Rectified Circuit

Figure 2 shows the typical model of a rectifier input. Under RLC mode, users can set the RLC values to 100% simulate the behavior of actual UUT. Figure 3 & 4 compares the voltage and loading waveforms between the actual RLC built circuit and the simulated rectified circuit by using Chroma RLC load mode. The waveform of the 63800 in RLC mode looks almost identical to the waveform of actual hardware circuit. The waveform obtained under CC mode with same loading crest factor shown in Figure 5 looks far from the waveform of actual hardware circuit.

In addition, traditional AC loads can only use CR mode to test discontinuous square or quasi-square wave UUTs because CC and CP are all active loadings and requires a defined frequency. It's very difficult to detect the frequency of a discontinuous square or quasi-square wave. Since RLC mode of the 63800 load is actually simulating passive loading it doesn't require a defined frequency, therefore it allows the user to simulate loading in modes other than just CR. Using discrete RLC network may solve the problem too, however due to component weight, size and limited RLC values this makes it inconvenient for testing. In contrast, Chroma's 63800 RLC mode provides versatile settings and higher test flexibilities.

For production line testing, most of users may not know their required RLC values but likely know the UUTs power rating and PF values. In this case, CP mode is ideal for test engineers. Under CP mode, the 63800 built-in algorithm will find the best solution to get the RLC values automatically according to the power rating and PF value set by the user.

To avoid overstressing the UUT, both the RLC and CP modes will gradually increase the loading current up to the programmed loading current shown in Figure 4, simulating actual RLC circuit loading as shown in Figure 3. This will alleviate the sudden voltage drop from constant current loading mode as shown in Figure 5.

For one that wishes to simulate the inrush current, the 63800 provides Inrush Current mode, allowing users to set different inrush current amplitude and the voltage phase angle where the inrush current started.

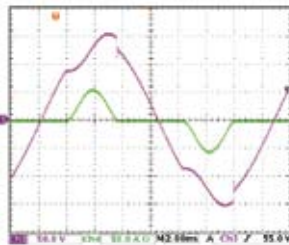

Figure 3: Actual RLC Circuit

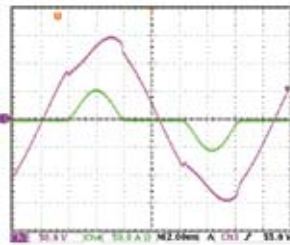

Figure 4: Simulated RLC Mode

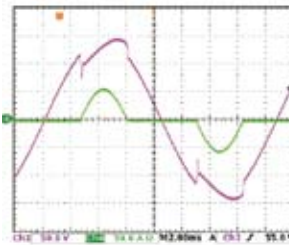

Figure 5: CC Mode

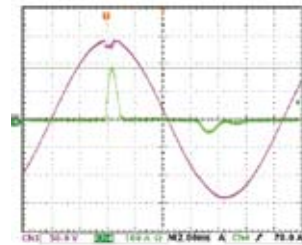
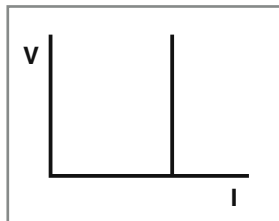

Figure 6: Inrush Current Mode

## DC Load Simulation

Chroma's 63800 DC load simulation includes four load modes : constant current, constant resistance, constant voltage and constant power as depicted below.



Constant current

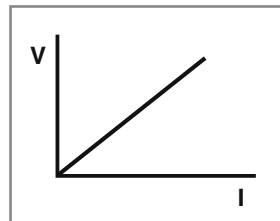

Constant resistance

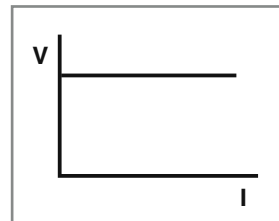

Constant voltage

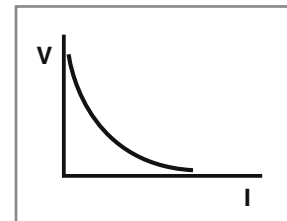

Constant power

CC, CR, CP mode can be used for regulated voltage power supplies testing. For battery charger, CV mode may help to check its current regulation.

A special DC Rectified mode is included to simulate the loading behavior of Distributed Inverters. Many inverter designs, although its input is DC, the input current will show rectified pattern. This unique load mode makes Chroma 63800 load ideal for Fuel Cell, PV module/array and Battery test because those devices will be loaded by Inverters.

## Comprehensive Measurements

Chroma's 63800 Series AC/DC Electronic Loads includes built-in 16-bits precision measurement circuits to measure the steady-state and transient responses for true RMS voltage, true RMS current, true power(P), apparent power(S), reactive power(Q), crest factor, power factor, THDv and peak repetitive current.

In addition to these discrete measurements, two analog outputs, one for voltage and one for current, are provided as a convenient means of monitoring these signals via an external oscilloscope.

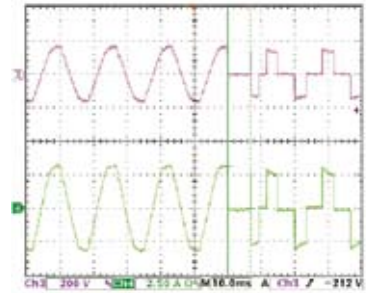

Figure 7:  
Transfer time for Off-Line UPS

## Timing Measurement

Timing parameters are critical to many products such as UPS, Breaker and Fuse. The 63800 AC/DC Load also includes unique timing measurement function to measure the trip time of fuse & circuit breaker or the transfer time for UPS (Off-Line).

## Automatic Bandwidth Adjustment (ABA)

When using active load mode (CC,CP), traditional AC loads operate under fixed bandwidth. When the load is working at low control bandwidth will limit the load from simulating high crest factor loading. In opposite, increase control bandwidth will influence the control loop stability especially when the UUT output impedance is high. To resolve this problem in traditional AC load, Chroma 63800 AC/DC Load dynamically adjusts the operating bandwidth by detecting the impedance\*1 of the UUTs to alleviate the risk of system instability.

The examples on the right compare voltage and current waveforms using traditional fixed bandwidth (@15kHz) load and the Chroma 63800 load for UPS load simulation. Noticeable difference can be observed with or without the ABA.

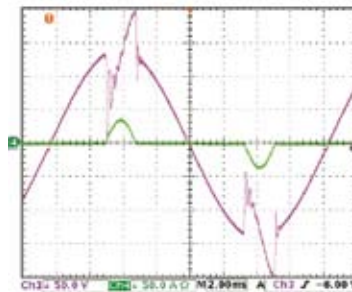

Figure 8: Fixed Bandwidth

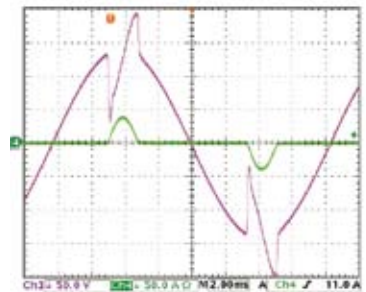

Figure 9: With ABA

Note 1: A test current will be programmed prior the actual loading defined by user for impedance detection.

When the UUT has higher output impedance such as Generator, the current waveform won't be stable as shown below without ABA. In most cases, the loading current will be oscillating and spoil the test.

## Parallel / 3-Phase Control

The 63800 series provides parallel and 3-phase functions for high power and three phase applications. All the models within the 63800 series can be used together for both parallel and 3-phase functions as well as paralleled AC Load units in 3-phase configuration, providing excellent flexibility and cost savings for the 63800 series AC load. Parallel and 3-phase controls are made easy by linking the AC Load units together, control of all AC load units will be made through the Master Unit. Connections of parallel and 3-phase functions are as shown in Figures 11, 12 and 13.



Figure 10: Parallel connection

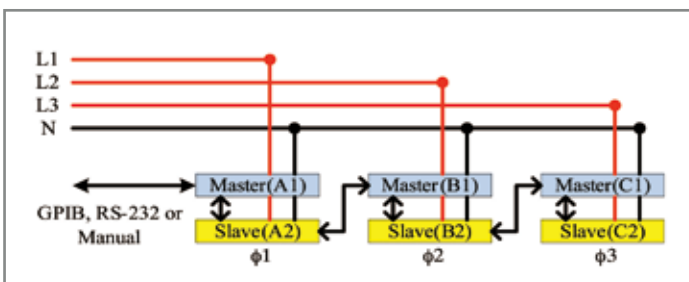

Figure 11: Parallel/3-Phase Y connection

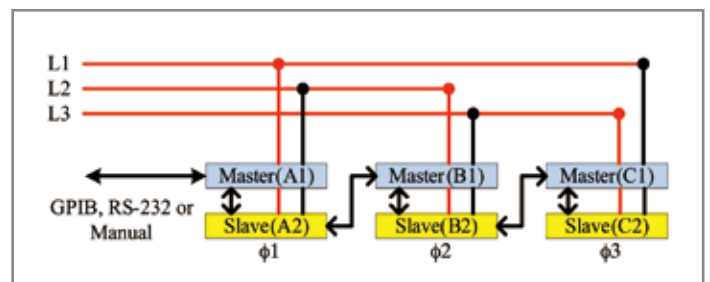

Figure 12: Parallel/3-Phase Delta connection

## Auto Power Factor Correction

Allowing user to set the power factor is one of the major features to the 63800. The power factor is defined as :

$$PF = \frac{P_{active}}{V_{rms} \cdot I_{rms}} = \frac{\frac{1}{T} \int_0^T v(t) \cdot i(t) dt}{\frac{1}{T} \int_0^T v(t) dt \cdot \frac{1}{T} \int_0^T i(t) dt}$$

Since PF is a function of real time voltage and current, traditional AC load designs assumes the voltage waveform to be sinusoidal all the time, as seen Figure 11. This is not realistic because the voltage waveform may be distorted after the load is applied shown in Figure 12, if the control of power factor is base on the belief of sinusoidal voltage waveform, it will result in a lower power factor than the user programmed thus overstressing the UUT.

Chroma's 63800 AC loads monitor the power factor reading constantly and uses this data to dynamically adjust the loading waveform. As a result, the power factor setting is precise without overstressing the UUT.

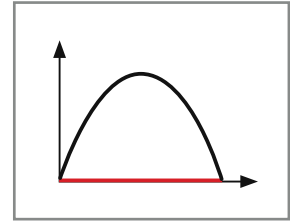

Figure 13

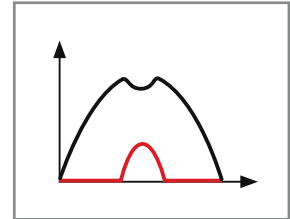
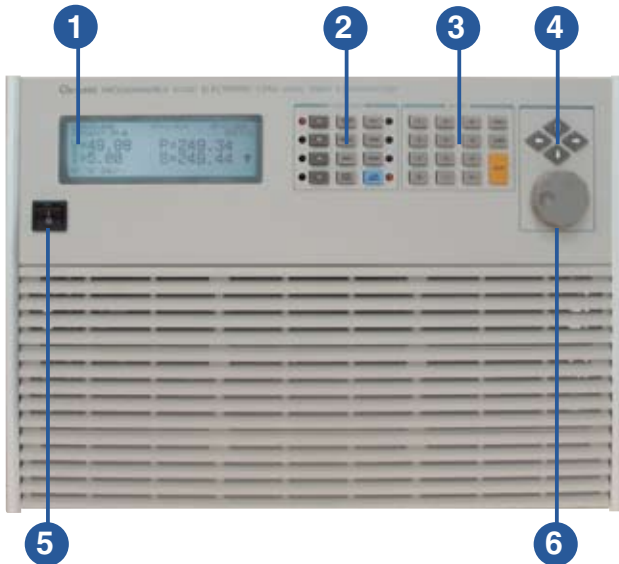
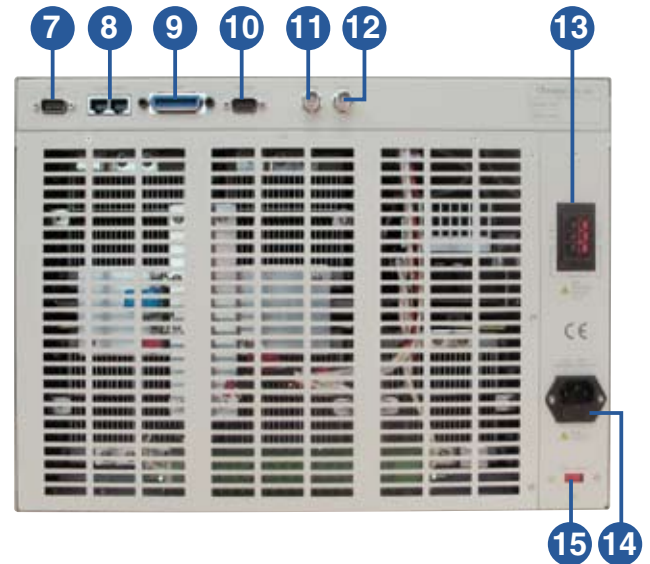

Figure 14

## Panel Overview



1. **LCD display**
2. **Function keypad :**  
To select load mode, control mode, and system config setting
3. **Numeric keypad :**  
For data setting
4. **Cursor key :**  
For setting and editing
5. **Power switch**
6. **Rotary knob :**  
For rapid control of active parameter
7. **TTL I/O :**  
For system input/output control signal



8. **System bus :**  
For master/slave control system data communication
9. **GPIB connector**
10. **RS-232 connector**
11. **Voltage monitor output :**  
Analog output proportional to voltage waveform
12. **Current monitor output :**  
Analog output proportional to the current waveform
13. **Load terminal & Voltage sense terminal**
14. **AC input connector**
15. **AC input voltage switch**

## Ordering Information

- 63802 : Programmable AC Electronic Load 1800W/18A/350V  
 63803 : Programmable AC Electronic Load 3600W/36A/350V  
 63804 : Programmable AC Electronic Load 4500W/45A/350V



# Specifications

Model	63802	63803	63804
<b>Power</b>	1800W	3600W	4500W
<b>Current</b>	0 ~ 18Arms (54 Apeak)	0 to 36Arms (108Apeak, continue)	0 to 45Arms (135Apeak, continue)
<b>Voltage</b>	50 ~ 350Vrms (500 Vpeak)	50 to 350Vrms (500Vpeak)	50 to 350Vrms (500Vpeak)
<b>Frequency</b>	45 to 440Hz, DC	45 to 440Hz, DC	45 to 440Hz, DC
<b>AC Section</b>			
<b>Constant Current Mode</b>			
Range	0 to 18Arms, Programmable	0 to 36Arms, Programmable	0 to 45Arms, Programmable
Accuracy	0.1% + 0.2%F.S.	0.1% + 0.2%F.S.	0.1% + 0.2%F.S.
Resolution	2mA	2mA	5mA
<b>Constant Resistance Mode</b>			
Range	2.77Ω ~ 2.5kΩ, Programmable	1.39Ω~2.5kΩ	1.11Ω~2.5kΩ
Accuracy	0.5% + 0.5%F.S.	0.5% + 0.5%F.S.	0.5% + 0.5%F.S.
Resolution	20μ mho	20μ mho	50μ mho
<b>Constant Power Mode</b>			
Range	1800W, Programmable	3600W, Programmable	4500W, Programmable
Accuracy	0.5% + 0.5%F.S.	0.2% + 0.3%F.S.	0.2% + 0.3%F.S.
Resolution	20μ mho	0.375W	1.125W
<b>Crest Factor (under CC, CP modes)</b>			
Range	1.414 to 5.0, Programmable	1.414 to 5.0, Programmable	1.414 to 5.0, Programmable
Accuracy	(0.5% / Irms) + 1% F.S.	1%F.S. + (0.5%/Irms)	1%F.S. + (0.5%/Irms)
Resolution	0.005	0.005	0.005
<b>Power Factor</b>			
Range	0 to 1 lead or lag, Programmable	0 to 1 lead or lag, Programmable	0 to 1 lead or lag, Programmable
Accuracy	1%F.S.	1%F.S.	1%F.S.
Resolution	0.001	0.001	0.001
<b>Rectified Load Mode</b>			
Operating Frequency	45Hz~70Hz		
RLC Mode	Parameter : Ip(max), Rs, Ls, C, R <sub>i</sub>		
Constant Power Mode	Parameter : Ip(max), Power setting=200W to 4500W, PF=0.4 to 0.75		
Inrush Current Mode	Parameter : Ip(max), Rs, Ls, C, R <sub>i</sub> , Phase		
Rs Range	80A (peak current)	160A (peak current)	200A (peak current)
Ls Range	0 to 9.999Ω	0 to 9.999Ω	0 to 9.999Ω
C Range	0 to 9999μH	0 to 9999μH	0 to 9999μH
RL Range	100 to 9999μF	100 to 9999μF	100 to 9999μF
RL Range	2.77 to 9999.99Ω	1.39 to 9999.99Ω	1.11 to 9999.99Ω
<b>DC Section</b>			
Voltage Range	7.5V to 500V	7.5V to 500V	7.5V to 500V
Current Range	0A to 18A	0A to 36A	0A to 45A
Min. operating voltage	7.5V	7.5V	7.5V
Rise time	75μs	75μs	75μs
Operating Mode	CC, CV, CR, CP, DC Rectified		
Short Circuit Simulation	Use the CR mode loading under max. power rating		
<b>Measurement Section</b>			
DVM Range	500.0V	500.0V	500.0V
DVM Accuracy	0.1% + 0.1%F.S.	0.1% + 0.1%F.S.	0.1% + 0.1%F.S.
DVM Resolution	10mV	10mV	10mV
DAM Range	80.00A	200.00A	200.00A
DAM Accuracy(<70Hz)	0.1% + 0.2%F.S.	0.1% + 0.2%F.S.	0.1% + 0.2%F.S.
DAM Accuracy(>70Hz)	0.1% + 0.2%F.S. + 0.1% x CF <sup>2</sup> x kHz	0.1% + 0.2%F.S. + 0.1% x CF <sup>2</sup> x kHz	0.1% + 0.2%F.S. + 0.1% x CF <sup>2</sup> x kHz
DAM Resolution	1.0mA	2.5mA	2.5mA
Other Parameter	P(W), S(VA), Q(VAR), CF, PF, Freq, R, Ip-, Ip+, THDv		
<b>Others</b>			
Vmonitor	±500V / ±10V (Isolated)	±500V / ±10V (Isolated)	±500V / ±10V (Isolated)
Imonitor	±80A / ±10V (Isolated)	±200A / ±10V (Isolated)	±200A / ±10V (Isolated)
Protection	OCP : 19.2Arms ; OVP : 360Vrms (DC : 510VDC) OPP : 1920W ; OTP	OCP : 38.4Arms ; OVP : 360Vrms (DC : 510VDC) OPP : 3840W ; OTP	OCP : 48Arms ; OVP : 360Vrms (DC : 510VDC) OPP : 4800W ; OTP
Remote Interface	GPIO, RS-232 or analog control		
Line Voltage	115/230 Vac ± 15%		
Dimension (H x W x D)	177 x 430 x 585 mm / 7.0 x 17.0 x 23.0 inch	177 x 440 x 585 mm / 7.0 x 17.3 x 23.2 inch	310 x 440 x 585 mm / 12.2 x 17.3 x 23.2 inch
Weight	34kg / 74.89lbs	60 kg / 132.16 lbs	60 kg / 132.16 lbs

All specifications are subject to change without notice.

Developed and Manufactured by :

**CHROMA ATE INC.**

致茂電子股份有限公司

**HEADQUARTERS**

66, Hwaya 1st Rd., Hwaya Technology Park,

Taoyuan 333, Taiwan

Tel: +886-3-327-9999

Fax: +886-3-327-8898

http://www.chromaate.com

E-mail: chroma@chroma.com.tw

**U.S.A.**

**CHROMA ATE INC. (U.S.A.)**

7 Chrysler Irvine, CA 92618

Tel: +1-949-421-0355

Fax: +1-949-421-0353

Toll Free: +1-800-478-2026

**JAPAN**

**CHROMA JAPAN CORP.**

4-20-7 Nishikoizumi, Oizumi,

Oragun, Gunma 370-0517,

Japan

Tel: +81-2-7661-0548

**EUROPE**

**CHROMA ATE EUROPE B.V.**

Morsestraat 32, 6716 AH Ede,

The Netherlands

Tel: +31-318-648282

Fax: +31-318-648288

**CHINA**

**CHROMA ELECTRONICS**

**(SHENZHEN) CO., LTD.**

8F, No.4, Nanyou Tian An

Industrial Estate, Shenzhen,

China PC: 518054

Tel: +86-755-2664-4598

Fax: +86-755-2641-9620

Distributed by:

Worldwide Distribution and Service Network

63800-200902-PDF