

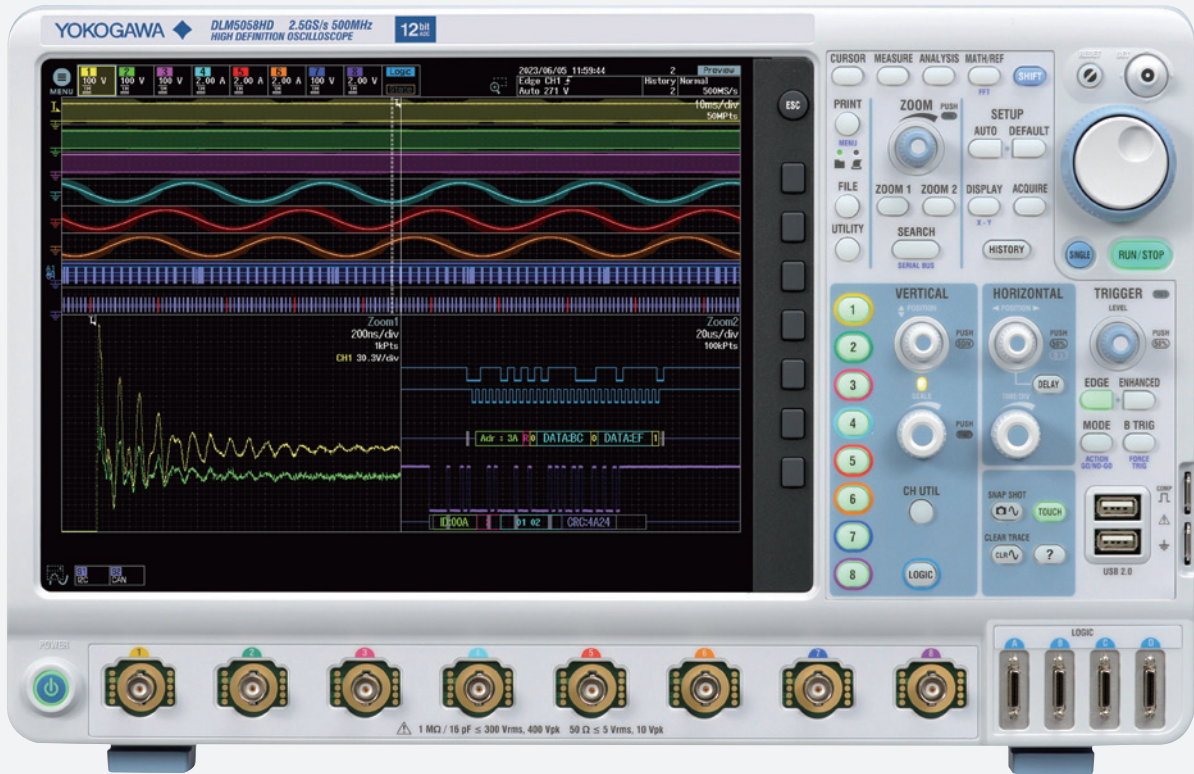

Test&Measurement

YOKOGAWA 



**DLM5000HD** **DLM5000**

# Uncover Every Detail

DLM5000HD Series  
High Definition Oscilloscope

DLM5000 Series  
Mixed Signal Oscilloscope



Precision Making

Bulletin DLM5000-01EN

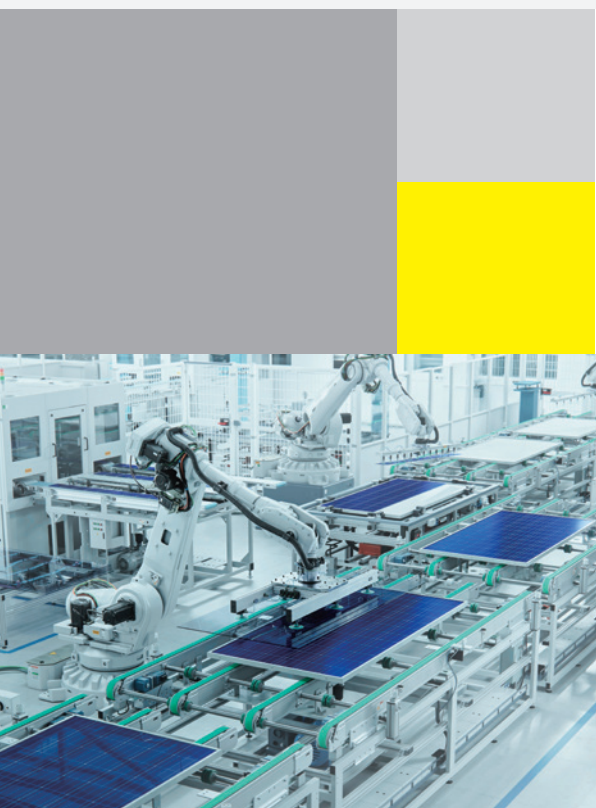

The DLM5000HD from Yokogawa is a state-of-the-art high-definition oscilloscope that goes beyond eight channels. The DLM5000HD offers adaptability, increased resolution, extended record length, and time synchronization. Improved features for serial bus auto setup make it an indispensable tool for engineers and researchers in the automotive industry. The large and highly responsive touchscreen and panel enable intuitive navigation through a wealth of analysis features. Experience the power of Yokogawa's latest innovation and take your testing and development to new heights with the DLM5000HD high-definition oscilloscope.

**Effortless** – The DLM5000HD is a compact eight-channel 12-bit oscilloscope with the ability to observe and analyze complex high-speed waveforms in high resolution, making it easy to check fine noise, ringing, and other details. The intuitive touchscreen, auto setup, and extensive analysis functions accelerate complex diagnosis, providing unparalleled testing precision.

**Harmonizing** – With a growing need to correlate accurate power data with waveform data, it is now possible to synchronize the DLM5000HD with a high-precision power analyzer using IEEE1588. DLMsync allows for 16 synchronized channels of waveform insights and 32/64 logic inputs.

**Reliable** – The DLM5000HD covers a wide range of applications from circuit checks to troubleshooting and advanced timing analysis. Engineers can have confidence in their daily measurements with a dedicated operating system and fast response time enables users to be up and running quickly and securely.





**1.6** MHz  
POWER SUPPLY SWITCHING FREQUENCY

**0.35** WATT  
POWER LOSS



**500** kbps  
CAN BUS BIT RATE

**145** H  
CAN IDENTIFIER

**19.2** kbps  
CXPI BUS BIT RATE

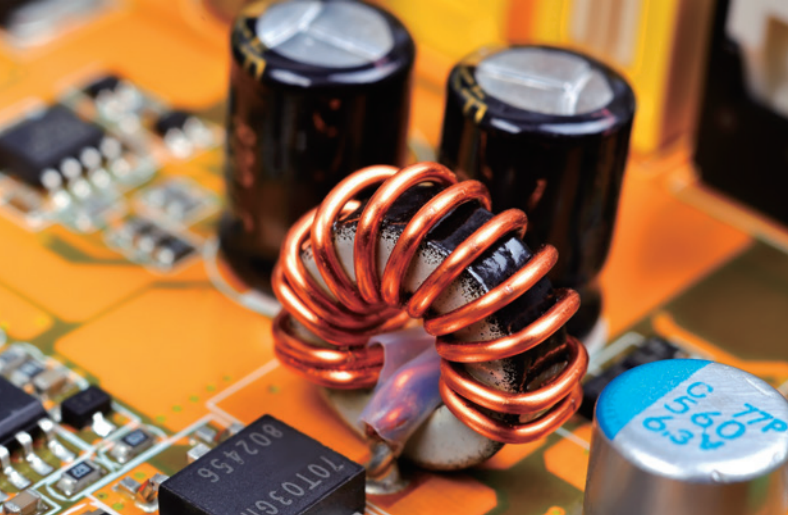
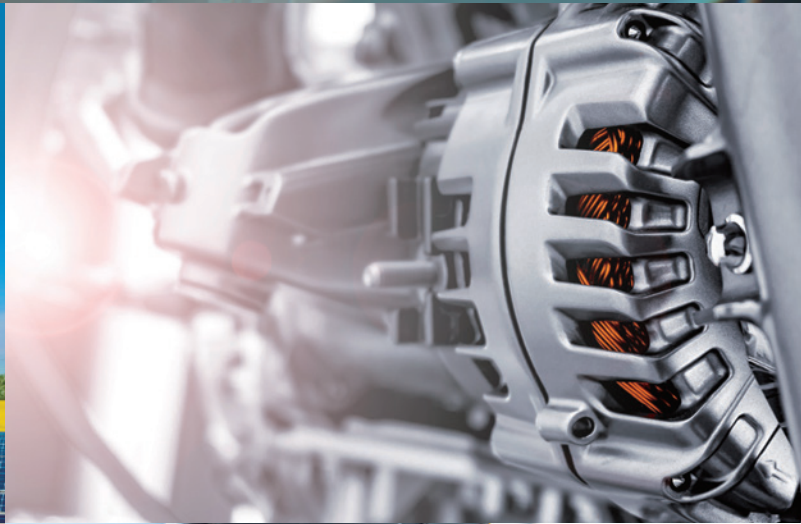
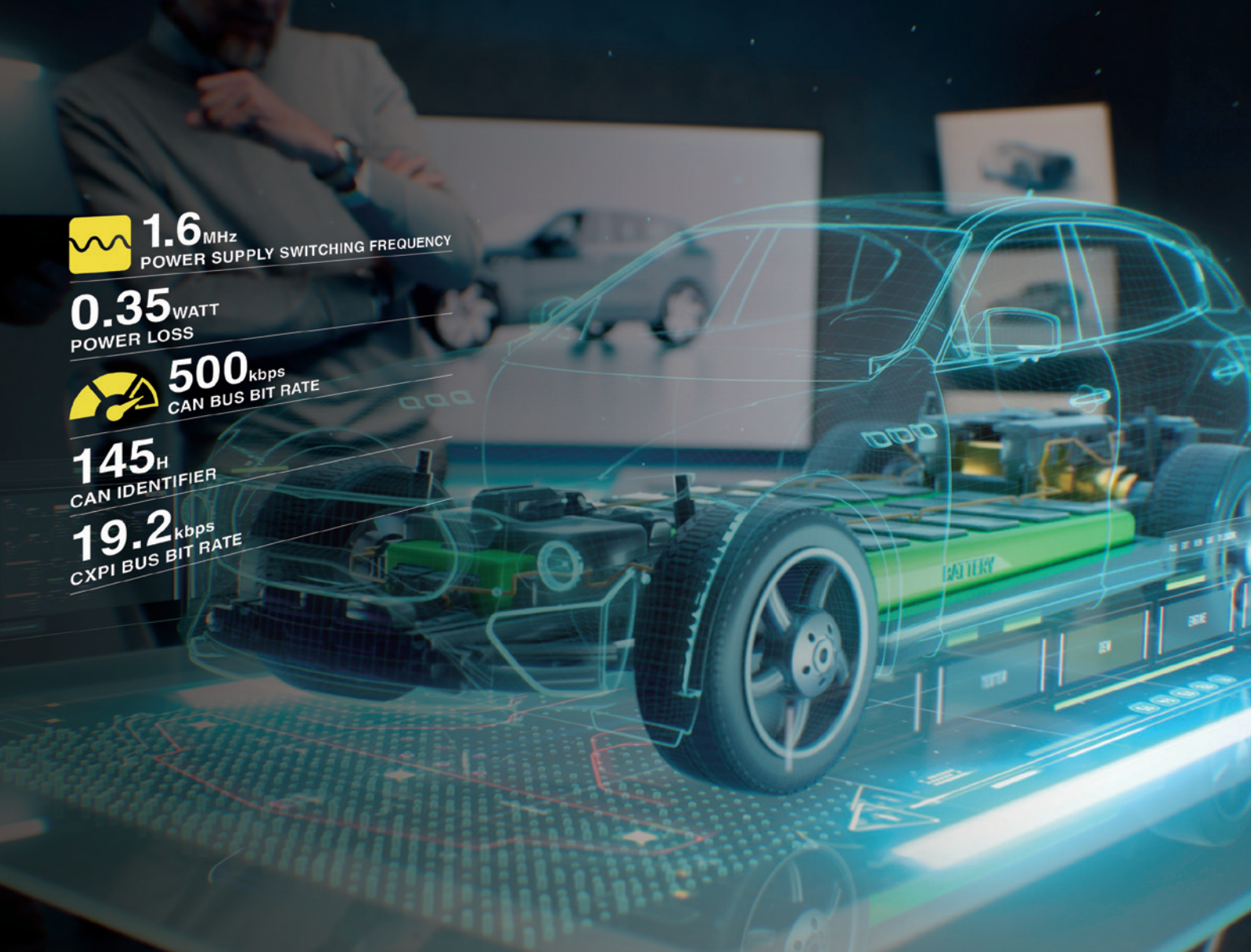





Yokogawa 8-channel Oscilloscopes Timeline

Digital Oscilloscope  
**DL5180**  
1993



Digital Oscilloscope  
**DL2700**  
1996



Digital Oscilloscope  
**DL7480**  
2002

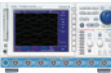

## One Gpoints-long memory to complete measurements in one go

The memory size of a measuring instrument is directly related to the measurement time. Equipped with a long, 1 G point memory, the DLM5000HD can record multiple channels at once, greatly increasing work efficiency.

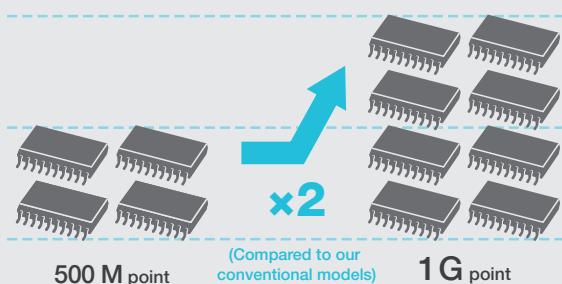

## Superior noise immunity for noisy environments

The touch panel can be disabled so that the DLM5000HD is operated using just the buttons.

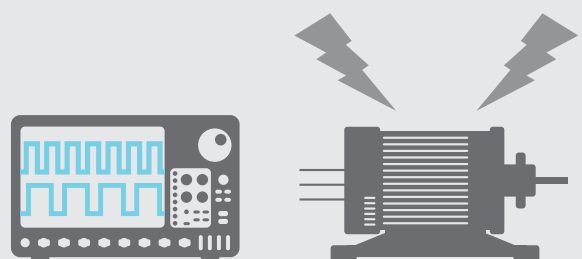

# “16x” more detailed measurements than a conventional MSO

Meet the new standard of high-definition oscilloscope that is ideal for everyday use by engineers

- ✓ **Best-in-class startup speed for superior usability**
- ✓ **High noise immunity allows operations even in harsh environments**
- ✓ **Never missing a measurement target High performance in the mid-range segment**
  - Frequency bandwidth: 500 MHz\*
  - Sample rate: 2.5 G sample/second\*
  - Number of simultaneous measurements: 8 channel + 32 bit\*
  - Vertical axis resolution: 12 bit
  - Measurement memory: 1 G points\* \*Max. value
- ✓ **Supports measurement of up to 16 channels**
- ✓ **Easy two-unit synchronization at the touch of a button**

Mixed Signal Oscilloscope  
**DLM4000**  
2012



Mixed Signal Oscilloscope  
**DLM5000**  
2020

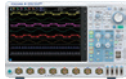

## 2023 High Definition Oscilloscope **DLM5000HD** Series

### Cover a wide measurement range with 12 bits

The DLM5000HD accurately captures waveform overshoot and ringing to enable more accurate measurements than ever before.

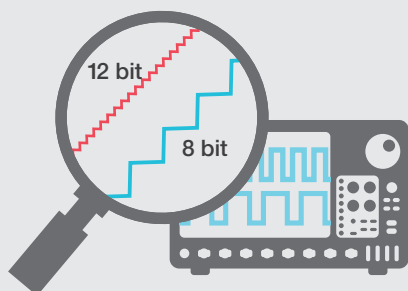

### DLM5000HD/DLM5000 Comparison

Feature	DLM5000HD	DLM5000
Vertical axis resolution	12 bit (Hi-res 16 bit)	8 bit (Hi-res 12 bit)
Memory size	Up to 1 G point	Up to 500 M point
Number of history waveforms	Up to 200000	Up to 100000
IEEE1588 synchronous support	Master function available (/CY)	Requires another master machine.

# Applications

## Development of motor/inverter circuits to perform high voltage switching

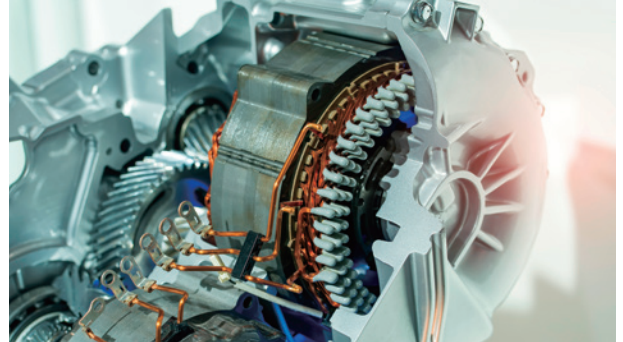
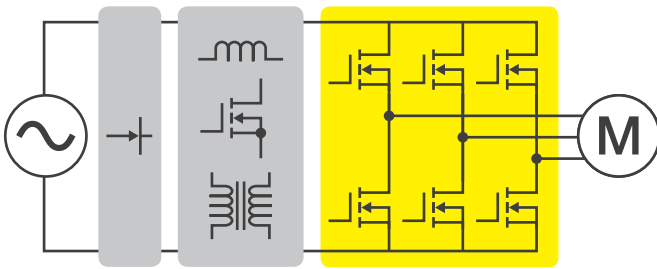

Example.

- Measuring 3 line voltages and 3 phase currents of a 3-phase motor at the same time
- Measuring gate control signals of 6 SiCs in an inverter at the same time

The DLM5000HD is a high-definition oscilloscope ideal for measuring fast switching of inverters. It can measure eight channels simultaneously at up to 2.5 GS/s with bandwidths of up to 500 MHz and provide high-precision analysis with 12-bit resolution. In addition, the DLMsync allows two DLM5000HD Series models to be connected without complicated settings, so settings to allow evaluation tests to be completed all at once by performing multi-point measurements.

The SW Loss math function is effective for inverter characterization and provides powerful analysis support. A full line of accessories for high voltages is also available that is especially useful for inverter development.

## Automotive electronic control unit and mechatronics embedded device development

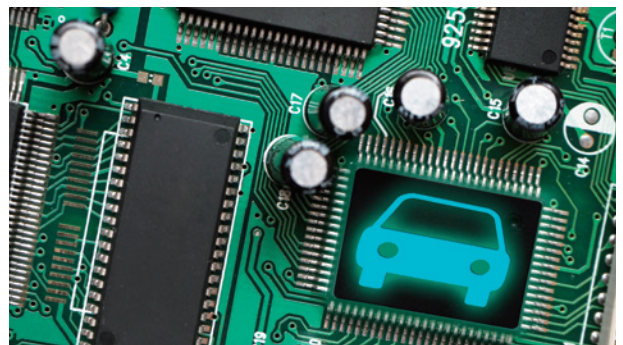
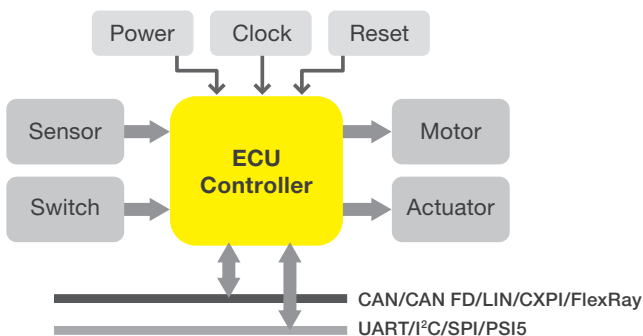

Example.

- Measuring controller I/O signals and serial bus signals at the same time
- Measuring the analog behavior of logic signals and serial bus signals

Digital waveform analysis using logic inputs alone cannot reveal anomalies such as voltage drift, noise, distortion or ringing, and measure rise-fall times. ECU testing requires stringent examination of all digital waveforms – and analog input channels are the best tool for the job.

Numerous I/O analog, digital, and serial-bus waveforms surrounding the electronic control unit (ECU) must be measured. The DLM5000HD offers ample channel-count and architecture to monitor eight analog channels and up to 32-bits of logic input while simultaneously performing protocol analysis such as UART, I<sup>2</sup>C, SPI, CAN, CAN FD, LIN, CXPI, PSI5, and FlexRay.



# Integrated Measurements

## Time synchronization with IEEE1588 master function

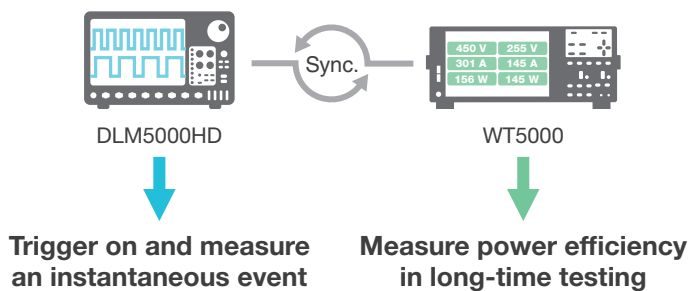

In evaluation of power conditioning systems, measuring for long periods of time at low sampling rates are required to determine overall power efficiency. However, they are sometimes situations where you want to capture events at a high sampling rate, like when a high load is applied.

The DLM5000HD has the IEEE1588 master function while utilizes highly accurate time synchronization with the WT5000 Precision Power Analyzer and other IEEE1588-supported models to allow easy synchronized measurement. The DLM5000HD captures an event of several microseconds without omissions and the WT5000 accurately measures power efficiency over a long period of time.

## Link with a PC

It is often more effective and efficient to perform analysis using a PC because of its high CPU processing power. The IS8000 Integrated Software Platform integrates multiple waveform and power measurement results and supports users' tasks with its powerful analysis capabilities.

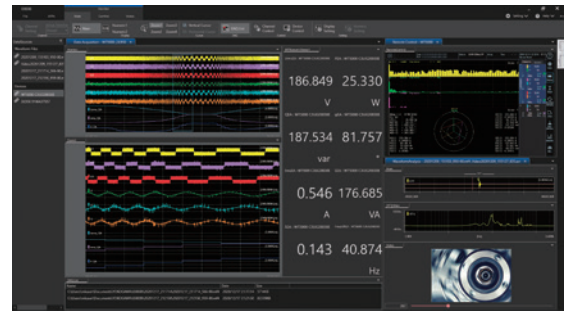

## Stable and reliable purpose-built operation system

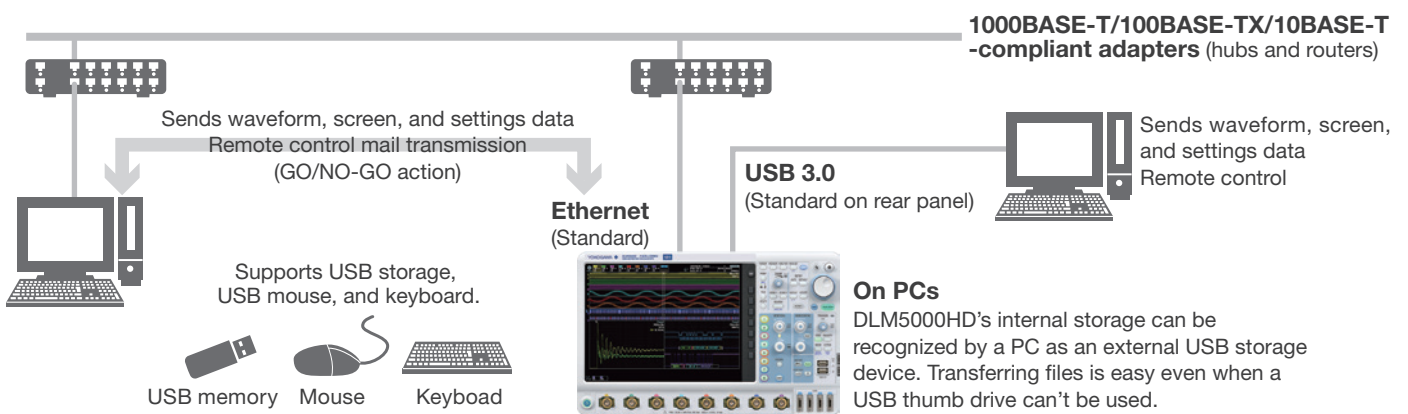

# Advantages and Features

## Wide bandwidth measurement

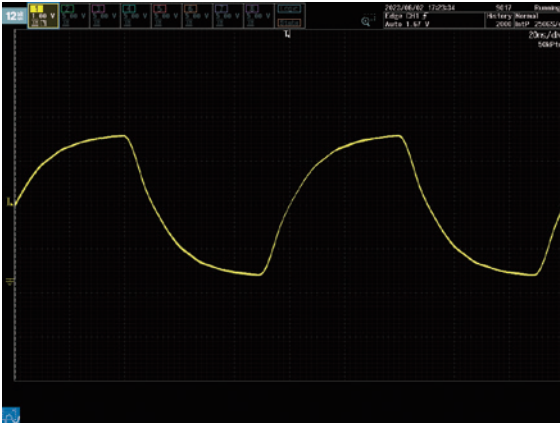
Supported models **DLM5000HD** DLM5000

At 20 MHz



At 500 MHz

Momentary phenomena, such as overshoot, at the rise of a high-speed inverter cannot be verified with a low bandwidth oscilloscope. The DLM5000HD combines a wide bandwidth of up to 500 MHz with a sample rate of up to 2.5 GS/s, making it a powerful tool for measuring a wide variety of devices that have become increasingly faster in recent years.

## 12-bit high resolution

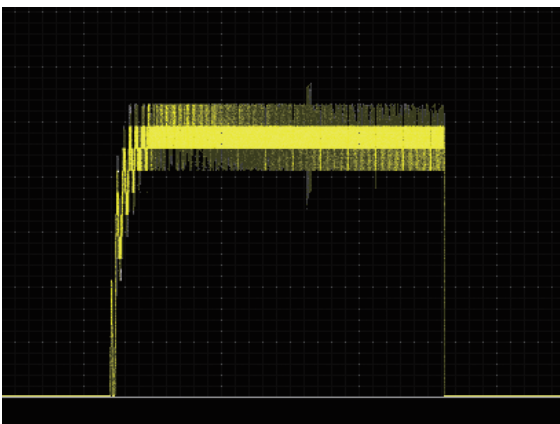
Supported models **DLM5000HD**

At 8 bit

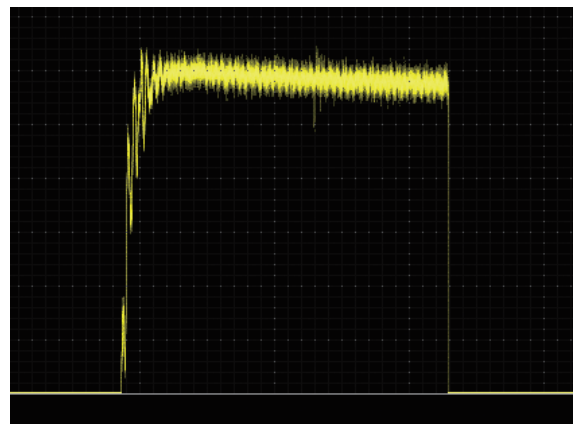

At 12 bit

A 12-bit measuring instrument is very effective in accurately measuring events such as ringing after overshoot. Optimal range settings can be made to capture minute changes accurately while checking the whole image of the waveform.



## Multi-channel measurement up to 16 channels

Supported models **DLM5000HD** **DLM5000**

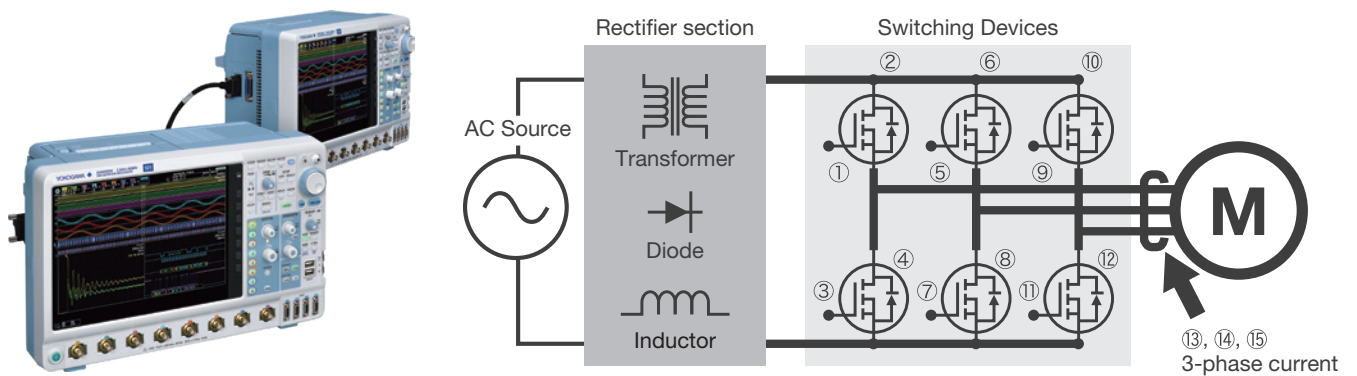

With a low-channel-count measuring instrument, you need to repeat tests several times to evaluate a single inverter. Additionally, it is difficult to make a comprehensive analysis because other device operations cannot be observed when an event of interest occurs. A single DLM5000HD can measure up to eight channels simultaneously and connecting two DLM5000HDs enables synchronous measurement up to 16 channels. This allows necessary evaluations to be completed in a single test, improving your work greatly improving efficiency.

## Useful history function

Supported models **DLM5000HD** DLM5000

### Automatically save previously captured waveforms

With the DLM5000HD series, up to 200000 previously captured waveforms can be saved in the acquisition memory. With the History function, you can display just one or all of the previously captured waveforms (history waveforms) on screen. You can also perform cursor measurement, computation, and other operations on history waveforms. Using the History function, you can analyze rarely-occurring abnormal signals even when an appropriate trigger condition is hard to find because its waveform shapes are not constant.

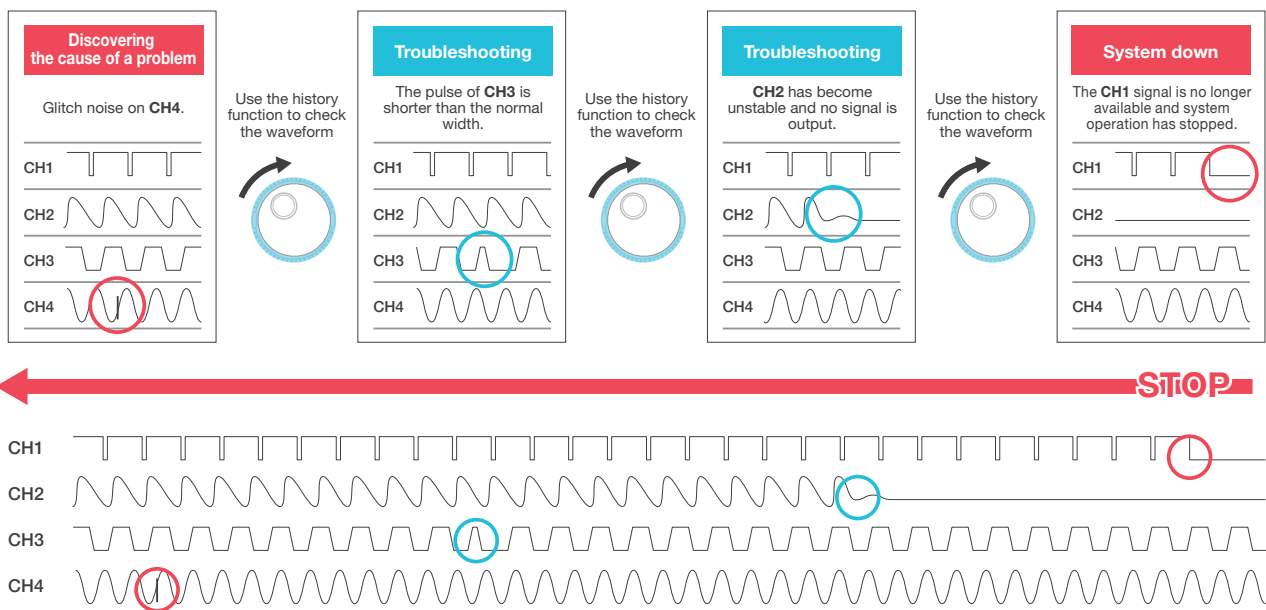

## History search function

Supported models **DLM5000HD** DLM5000

Various and powerful search methods are available to search up to 200000 waveforms\* for events meeting your custom requirements. Intuitive and simple waveform search functions are provided. For example, you can specify a rectangular zone that captures a part of a waveform on the screen, a zone that covers an entire measured waveform, or a polygonal zone. If you know a value of interest, such as an abnormal value of voltage or pulse width, you can search history waveforms using waveform parameters.

\*Up to 100000 for DLM5000

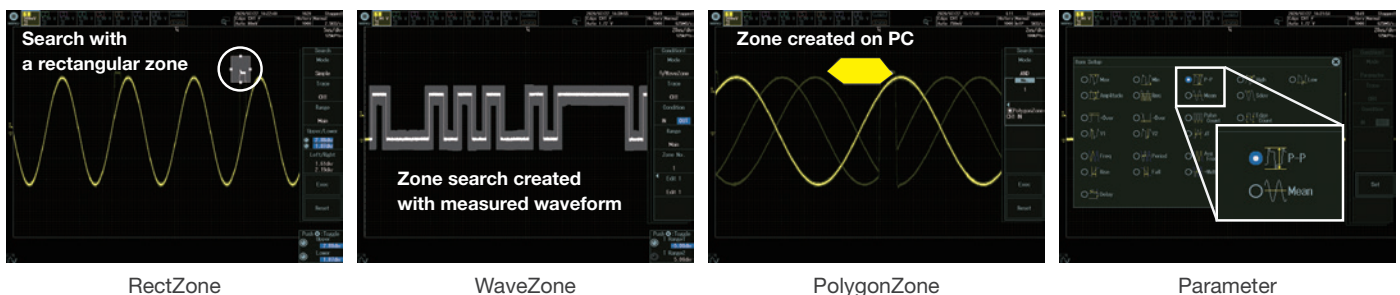

RectZone

WaveZone

PolygonZone

Parameter

## Up to 2.5 GS/s (eight channels at once) and up to 1 G points-long memory

Supported models **DLM5000HD** **DLM5000**

The evaluation of an embedded system requires the verification of its operation over a relatively long period of time with software commands and the simultaneous viewing of waveforms of high-speed signals such as clock noise. The DLM5000HD has a memory capacity of up to 500 M points in single mode/125 M points in repeat mode for waveform capture when all channels are used. You can observe waveforms with very few omissions.

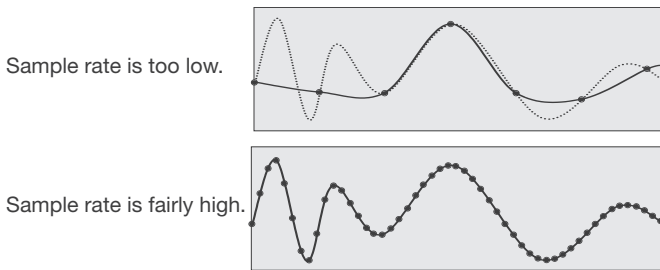

More memory is needed to use higher sample rates and capture the most accurate waveform representation.

### Maximum record length (Points)

	Repeat	Single <sup>*1</sup>
Standard model	12.5 M	125 M
/M1 or /M1S	25 M	250 M
/M2 or /M2S	50 M	500 M
/M3 <sup>*2</sup> or /M3S <sup>*2</sup>	125 M	1 Giga

\*1: At odd-numbered channels \*2: DLM5000HD only

## Large selection of triggers

Supported models **DLM5000HD** **DLM5000**

When you capture a waveform of concern, your work efficiency will deteriorate if you are at a loss to determine whether the characteristic waveform is occurring regularly or under specific conditions.

The DLM5000HD's extensive triggers can be used to trigger on the feature points of waveforms to extract waveforms of interest and store them in the history memory. You can display a list of history waveforms to see the intervals between triggers or line up several waveforms to see what trends are evident around the feature points. This helps determine how often or under what conditions a characteristic waveform occurs.

### Trigger types

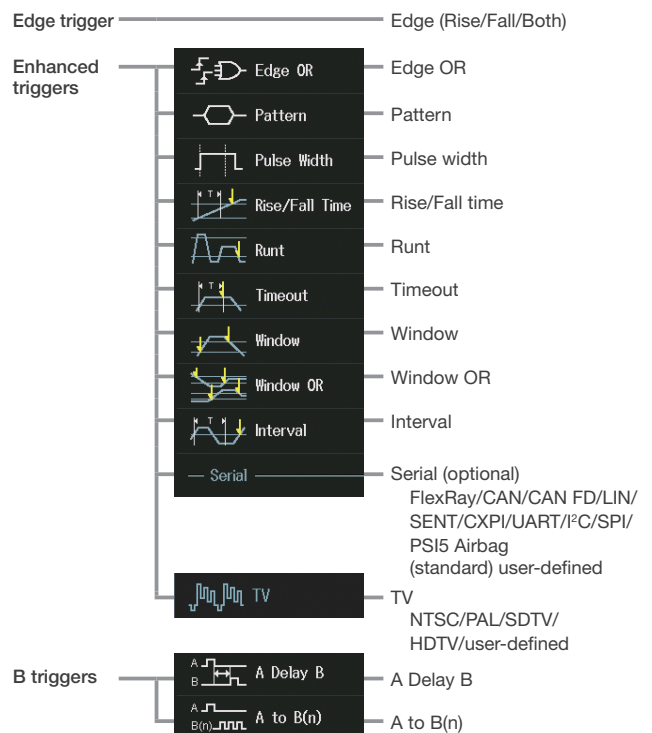



## DLMsync two-unit connection function for more channels (/SY or /SYN option)

Supported models **DLM5000HD** **DLM5000**

Connecting two DLM5000 Series models (with /SY or /SYN option) with a dedicated cable (701982) enables synchronous measurement of up to 16 channels. Captured waveforms are displayed on each unit. Triggers operate in common, and common items, such as record length, sample rate, acquisition settings and horizontal axis scale settings, are linked, so they can be used like a single 16-channel oscilloscope. You can also connect 4 ch models, making “8 + 4 = 12 channels” or “4 + 4 = 8 channels” possible.

\*Between DLM5000 and DLM5000HD cannot be connected via the DLMsync function.



When two DLM5000HD/5000 series models are connected, the one that you press the “Connect” button in the “DLMsync” menu on becomes the main unit, and the other becomes the sub unit. The two units capture waveforms simultaneously with the sampling clock and trigger of the main unit.

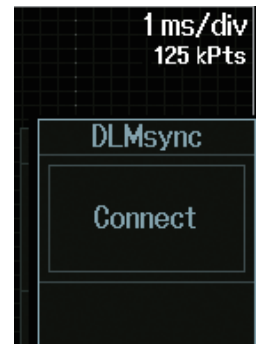

Two synchronized instruments become linked and some operations are shared between the main unit and the sub unit. For example, if you zoom in on a waveform on the main or sub unit, the corresponding waveform on the other unit will automatically get zoomed in at the same spot. As measurement data can be output in batches, 16 channels can be checked at once in combination with the IS8000 integrated software platform.

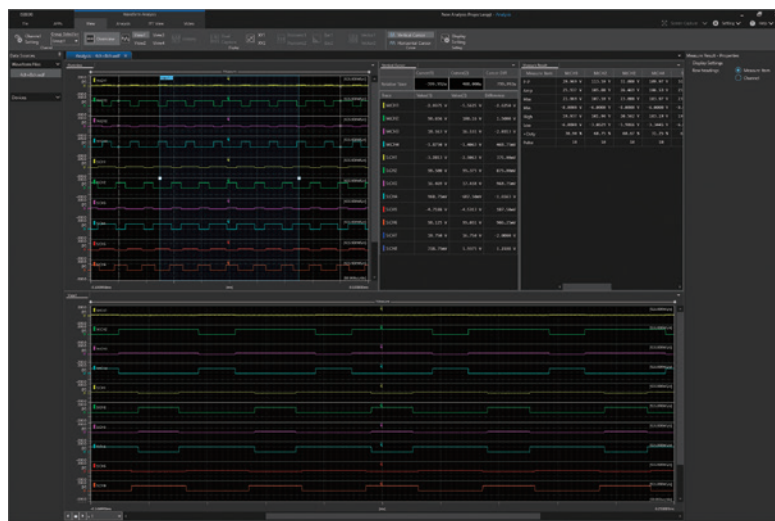

## IEEE1588 integrated measurement master function

Supported models **DLM5000HD**

The DLM5000HD can be set as the master unit for time-synchronized measurement using IEEE1588. This function connects measuring instruments in a LAN network to each other without a dedicated cable or complex settings for synchronization, allowing you to start synchronized measurements easily. All measured data and results can be integrally analyzed on the same time axis on the IS8000.

\*If you use a network HUB, use an IEEE1588-supported one.

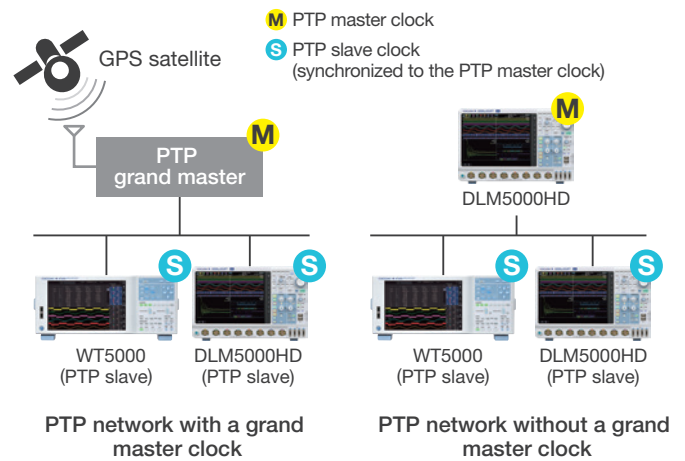

## 12.1 inch large screen provides a comfortable debugging environment

Supported models **DLM5000HD** **DLM5000**

Equipped with a 12.1-inch large touch screen. The large screen is useful for observing analog signals in detail and displaying information for debugging, such as parameters, zoom screen, XY display, and FFT analysis results.



## Easy to carry and measures quickly

Supported models **DLM5000HD** **DLM5000**

While the DLM5000HD is a large screen model with multichannel inputs, it comes in a portable, thin & lightweight design. The instrument starts up from OFF to waveform display in twelve seconds. You can start measurement work immediately.

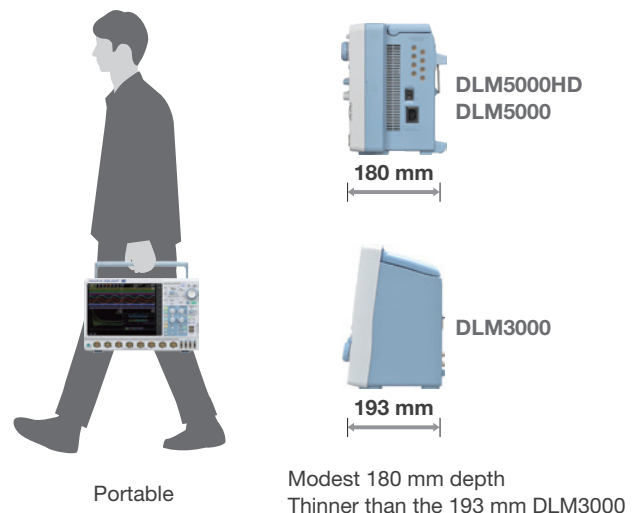

## Zoom and search function

Supported models **DLM5000HD** **DLM5000**

Multi-channel waveforms captured in the long memory need to be zoomed in vertically and horizontally for detailed viewing. The DLM5000 Series has dedicated zoom keys and knob, allowing you to quickly zoom in on the part you want to see. You can also specify the area you want to zoom in on by using the touch screen.

### Zoom two locations simultaneously

You can display two zoomed waveforms with different time axis scales at the same time. Also, use Auto Scroll to sweep the zoom window across the waveforms automatically. Being able to zoom in on two distant locations at the same time, such as “cause” and “effect” of a certain event, or to display them with different zoom factors is very useful for software debugging.

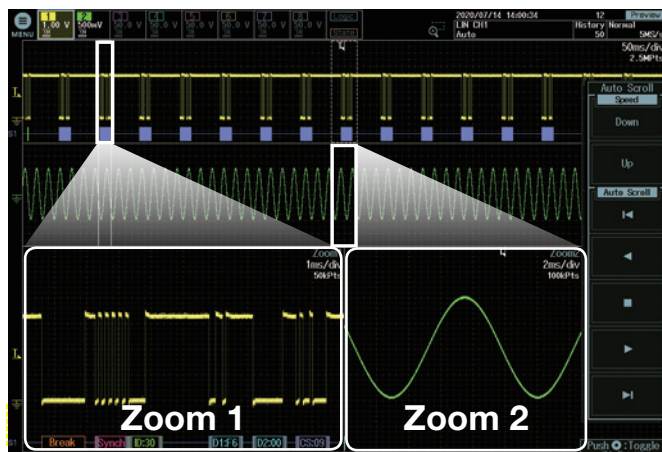

### Zoom search function

Use several search criteria to automatically find and zoom into features in the waveform for further inspection. The locations of the found waveforms are marked on screen (▼ shows the current location).

### Waveform search criteria

Edge, edge (qualified), state/pattern, pulse width, state width, serial bus (only on models with the serial bus analysis option)

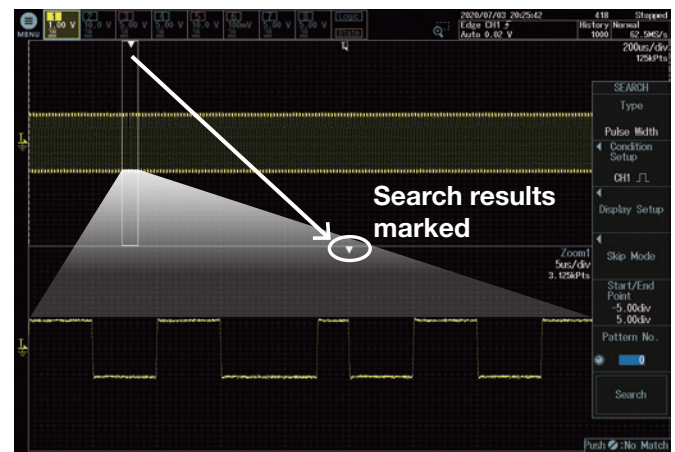

Waveform search by pulse width

## Touchscreen

Supported models **DLM5000HD** **DLM5000**

By using the touchscreen to move the waveform position, change the scale, move the cursor, and such, you can operate the instrument without taking your eyes off the waveform. If you want to zoom in a part of the waveform, use Rect Zoom for easy zooming by swiping your finger diagonally across the screen to specify the area. To select items on the dialog box, you can directly touch them, which eliminates the trouble of using select keys.



Changing zoom ratio by pinching in and out

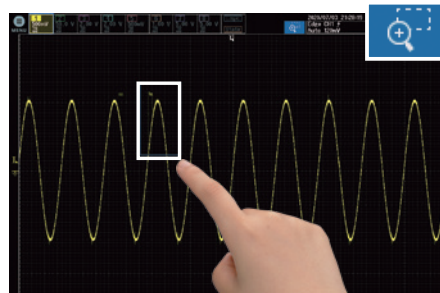

Rect Zoom



Selecting waveform parameter items



## Logic signal measurement and analysis

Supported models **DLM5000HD** **DLM5000**

The flexible MSO inputs are included as standard. This enables the DLM5000HD to be converted to a 8 analog and 16 digital input MSO. With the /L4 or /L32 option, up to 32 logic signals can be measured. Bus/State display and optional DA calculation function, which is useful for evaluating AD/ DA converters, are also provided.

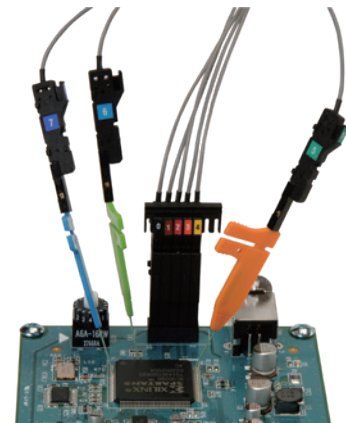
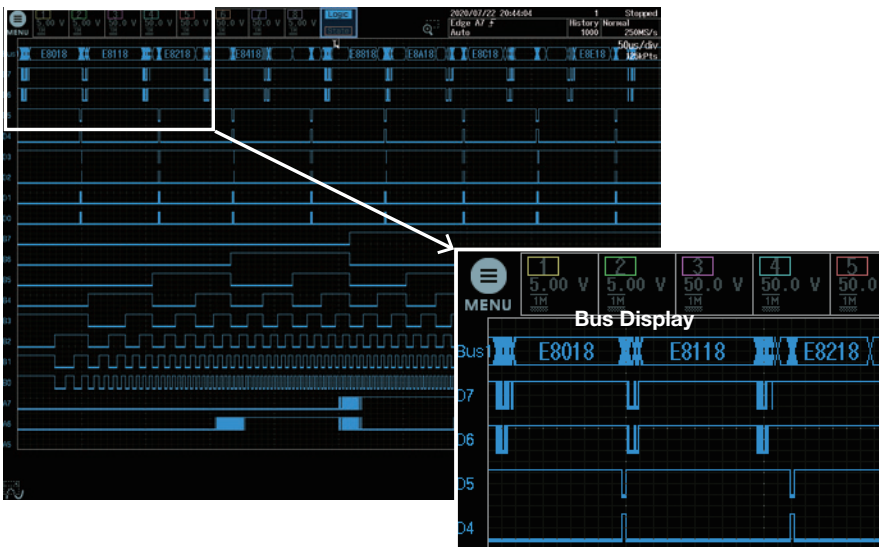

## Filter functions

Supported models **DLM5000HD** **DLM5000**

**Real time filter with optimum noise reduction supports a wide range of frequencies — from 8 kHz to 200 MHz —** Each channel has 14 low pass filters available with cutoff frequencies from 8 kHz to 200 MHz. Waveforms are filtered prior to storage in memory. Real-time filters allow for stable triggering of superimposed noise signals.

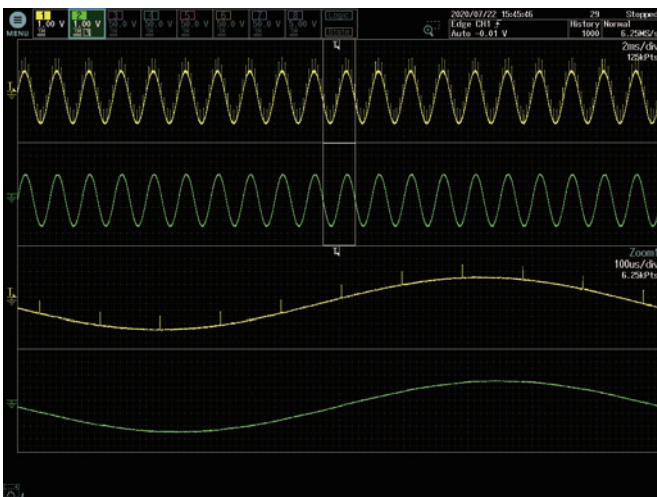

Processing with Real time filters

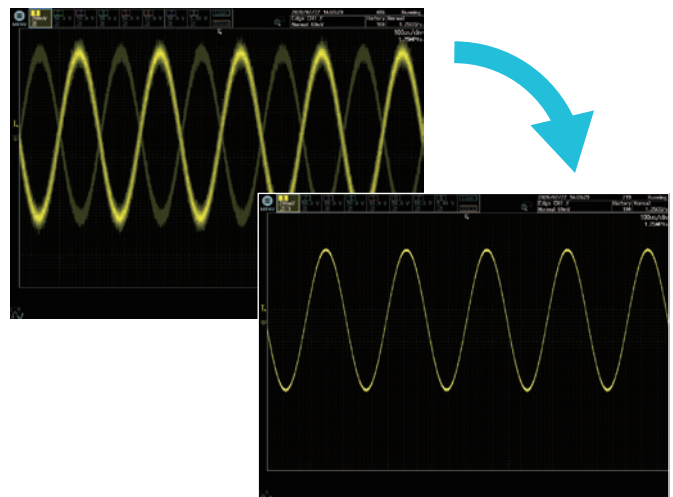

Stable trigger as a result of noise reduction

## Functions to improve operational efficiency

Supported models **DLM5000HD** **DLM5000**

### Displays trends of peak-to-peak or pulse width per cycle

#### Measure function and statistics

Twenty-nine waveform parameter measurements are included. Automated measurement of up to 120 simultaneous measurements is available. Statistical values can also be measured continuously, cycle-by-cycle or using history memory. In addition, cycle-by-cycle parameter measurement is possible to calculate fluctuations of a captured waveform.

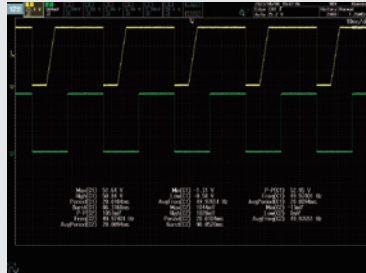

#### Trend and histogram displays

Waveform parameters such as period, pulse width, and amplitude can be measured repeatedly and displayed in graphs. In a single screen you can observe period-by-period fluctuations, compute amplitudes every screen using multiple waveforms, and display amplitudes as trends. You can also display histograms referencing the voltage or time axis using values from repeated automated measurement of waveform parameters.

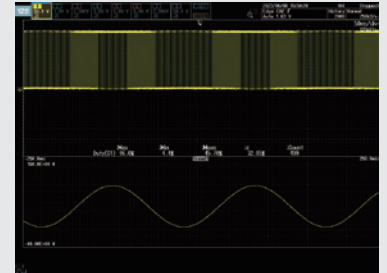

Trend display of waveform parameters  
Histogram display using the time axis

### Measures voltage/time differences automatically

#### Cursor Measurement

Cursors can be placed on the displayed waveform from signal data, and various measurement values at the intersection of the cursor and waveform can be displayed. There are five types of cursor;  $\Delta T$ ,  $\Delta V$ ,  $\Delta T \& \Delta V$ , Marker, Degree Cursor.

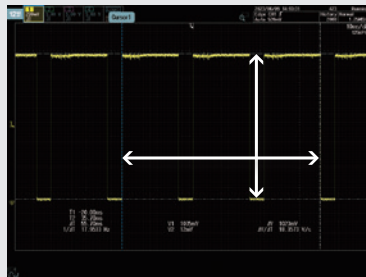

Simultaneous level and time difference measurement with the  $\Delta T$  &  $\Delta V$  cursor

### Analyzes frequency spectra

#### FFT analysis

Up to 4 FFT analyses can be performed simultaneously. FFT can be performed on computed waveforms in addition to the actual waveforms on CH1 to CH8. The peak detection function that automatically detects the spurious frequency is a useful feature for searching for a noise source, such as clock and power supply switching noise.

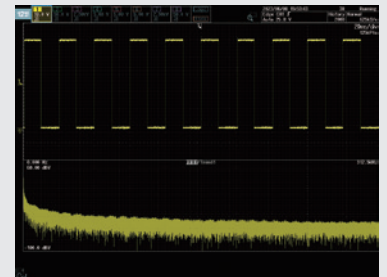

FFT analysis

### Keeps waveforms with one push of a button

#### Snapshot

By pressing the "SNAP SHOT" key to the lower right of the screen, you can freeze a white trace of the currently displayed waveform on the screen. You can press the key repeatedly and conveniently leave traces for comparing multiple waveforms. Also, snapshot data recorded on screen can be saved or loaded as files, and can be recalled for use as reference waveforms when making comparisons.

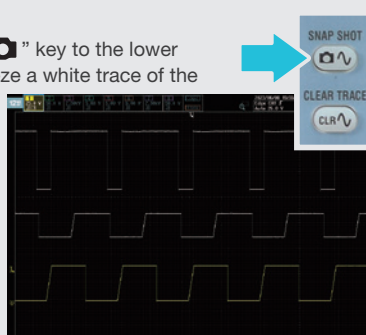

Using snapshots (white waveforms)

### Displays stored files in thumbnail format

#### Thumbnails of saved files

Display thumbnails of saved waveforms, waveform images, and Wave Zone files for easier browsing, copying or deleting. A full-size view shows even more details.



Thumbnails of saved files

### Has a GO/NO-GO function, Action on trigger

GO/NO-GO automates pass or fail determination for trigger conditions, waveforms, measured parameters, and other criteria. Actions automate buzzer sounds, file saving, or email notification. Waveforms in which an abnormality occurred can be saved for confirmation and analysis of the phenomena at a later time.

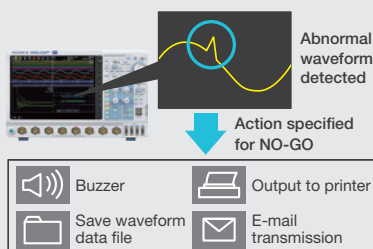

### Graphical online help

Get help without having to find the user manual. Pressing the "?" key opens detailed graphical explanations of the oscilloscope's functions.

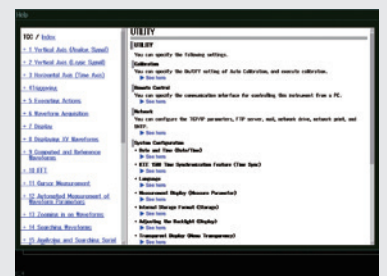

# Application-specific analysis options

## Serial analysis function options (/F1 to /F6, /F01 to /F06) Supported models **DLM5000HD** **DLM5000**

### UART (RS232) /I<sup>2</sup>C/SPI/CAN/CAN FD/LIN/FlexRay/SENT/CXPI/PSI5 Airbag

Dedicated trigger and analysis options are available for various serial buses of both in-vehicle and embedded systems. Logic input can also be used for I<sup>2</sup>C/SPI/UART/SENT. When it is not necessary to observe waveform quality of a bus, decoding or analysis using logic inputs is possible.

### Unique auto setup

Yokogawa's proprietary auto setup function automatically analyzes the input signal or captured waveforms and complex parameters such as bit rate and threshold level, selecting the optimal settings in seconds. This feature not only saves time but is also a powerful debugging feature when the bit rate and other parameters are unknown.

### Simultaneous analysis of up to 4 buses

Perform high-speed simultaneous analysis on up to four different serial buses operating at different speeds. Extensive search capabilities enhance the usability, allowing the user to find specific data in the very long memory. The dual-zoom facility means that different buses can be viewed and debugged alongside each other.

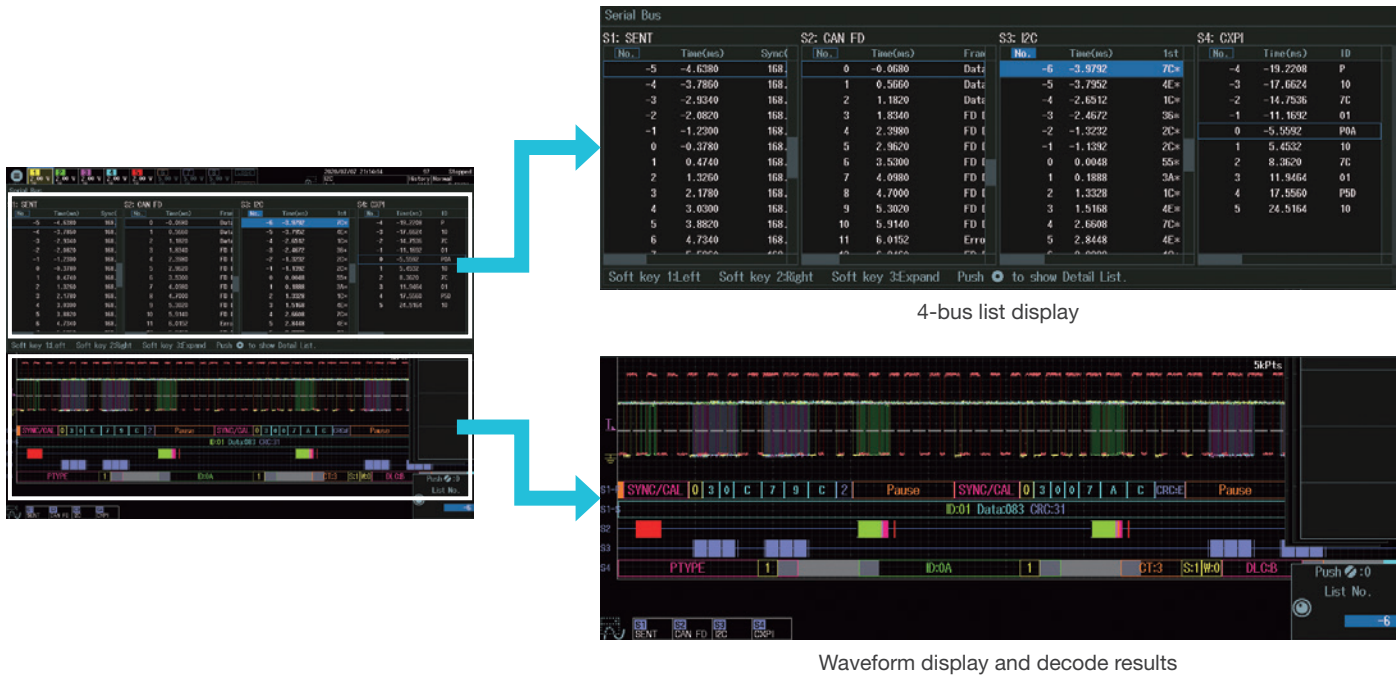

### Related accessories (sold separately)

#### Differential probe PBDH0500 (701925)

DC to 500 MHz bandwidth  
 Input impedance 1 MΩ, approximately 1.1 pF  
 Maximum differential input voltage range: ±25 V

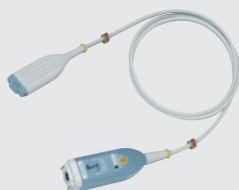

#### Logic probe PBL100/PBL250 (701988/701989)

100 MHz/250 MHz toggle frequency  
 Input impedance 1 MΩ, 10 pF/100 kΩ, 3 pF

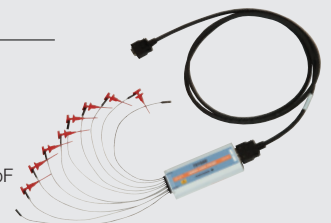



### User defined math option (/G2 or /G02)

Supported models **DLM5000HD** **DLM5000**

Equations can be arbitrarily created using a suite of operators such as trigonometric and logarithmic operators, integration and differentiation, pulse width operators, phase measurement and digital to analog conversion.

### Power supply analysis option (/G3 or /G03)

Supported models **DLM5000HD** **DLM5000**

#### Switching loss analysis

Calculate switching loss  $[V(t) \times i(t)]$  over long test cycles utilizing the long built-in memory. A wide variety of switching loss analyses are supported, including turn-on/off loss calculation, loss including continuity loss, and loss over long cycles of 50 Hz/60 Hz power line.

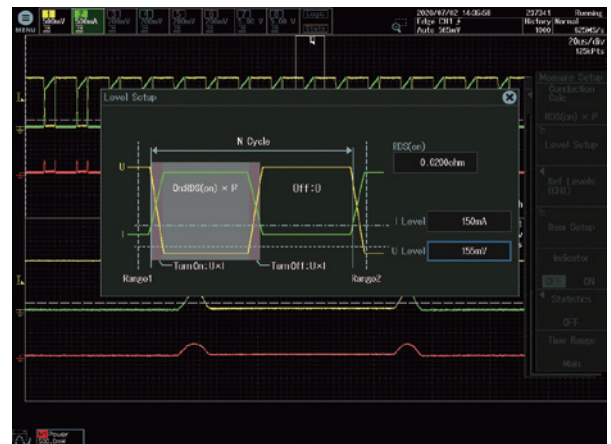
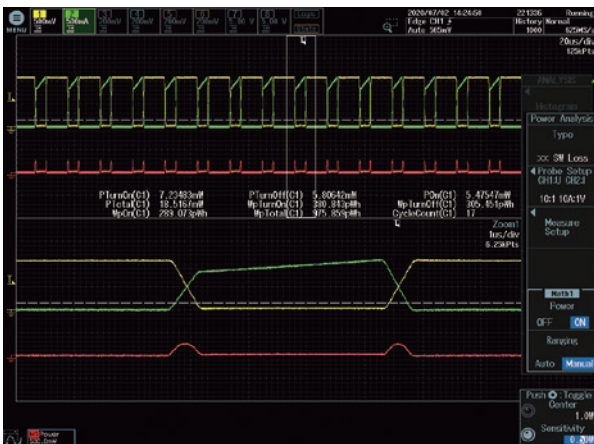

#### Power parameter measurement

Measure power parameters automatically for up to four pairs of voltage and current waveforms, such as active power, apparent power, power factor, and more. Cycle statistics and history statistics can also be calculated.

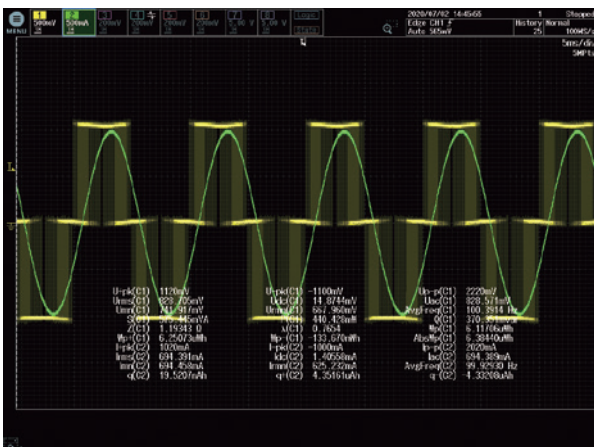

#### Related accessories (sold separately)

##### Differential probe PBDH0150 (701927)

DC to 150 MHz  
1000 Vrms/ ±1400 Vpeak

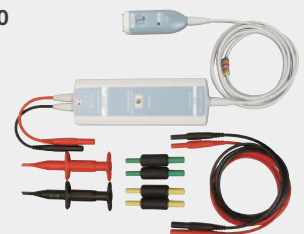

##### Current probe PBC100/PBC050 (701928/701929)

DC to 100 MHz (701928)  
DC to 50 MHz (701929)  
30 Arms

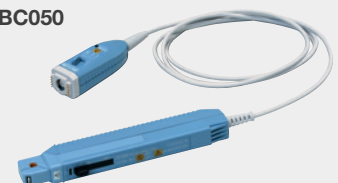

# Intuitive control panel and connectivity

**DLM5000HD/DLM5000** \*The photo shows the 8-channel model.

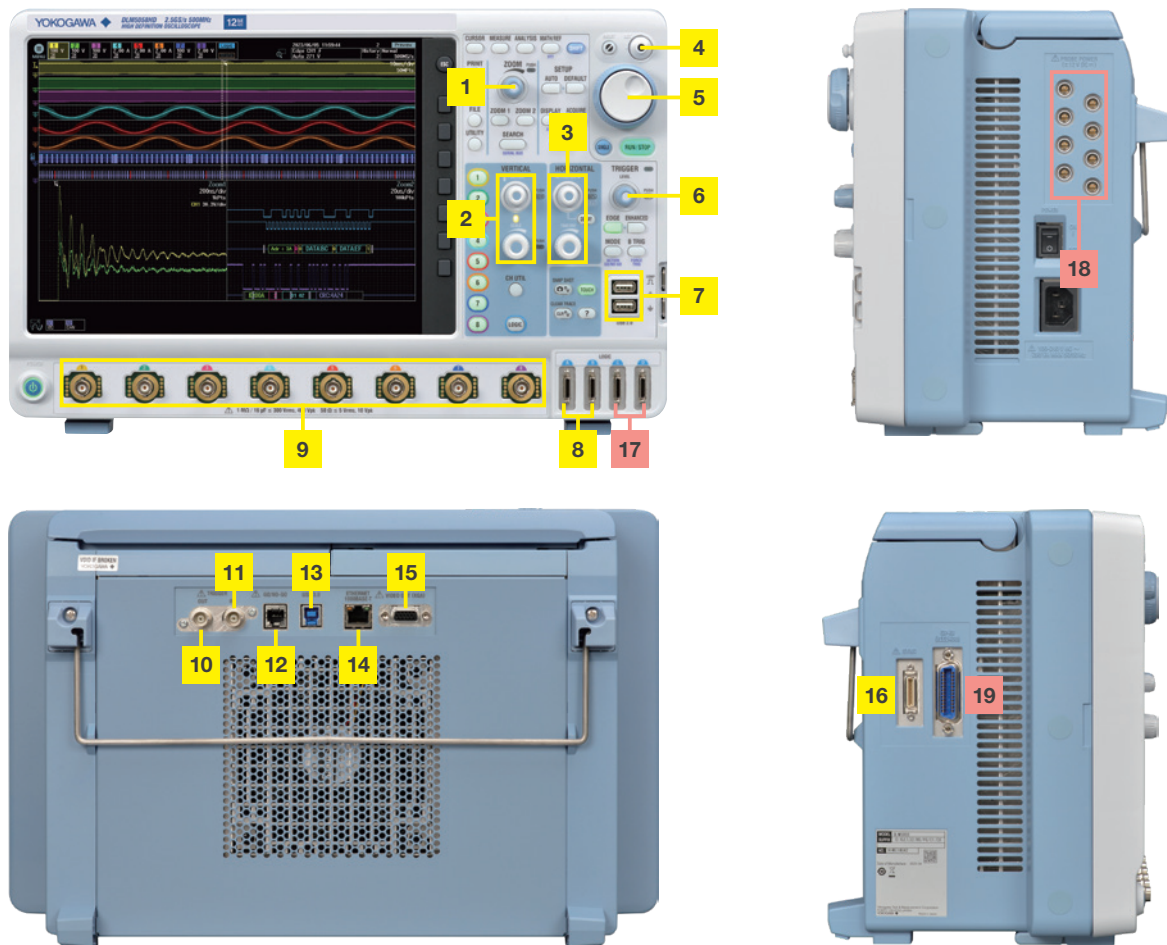

## Standard equipment

## Optional

- |   |  |
|---|--|
| <ul style="list-style-type: none"> <li><b>1</b> Dedicated Zoom Knob</li> <li><b>2</b> Vertical Position and Scale Knob</li> <li><b>3</b> Horizontal Position and Scale Knob</li> <li><b>4</b> Four-Direction Selector Button Select key moves the cursor up/down/left/right</li> <li><b>5</b> Jog Shuttle and Rotary Knob</li> <li><b>6</b> Dedicated Trigger Level Knob</li> <li><b>7</b> USB peripheral connection terminal × 2</li> <li><b>8</b> Logic input connector 16 bit</li> </ul> | <ul style="list-style-type: none"> <li><b>9</b> Eight Analog Input Channels<sup>*1</sup></li> <li><b>10</b> External trigger output</li> <li><b>11</b> External trigger input</li> <li><b>12</b> GO/NO-GO output terminal</li> <li><b>13</b> USB-PC connection terminal</li> <li><b>14</b> 1000 BASE-T Ethernet</li> <li><b>15</b> RGB video output terminal</li> <li><b>16</b> Synchronous operation terminal (for DLMsync<sup>*2</sup>)</li> </ul> |
|---|--|

- 17** Logic input connector 16 bit
- 18** Probe power supply terminal × 8<sup>\*3</sup>
- 19** GP-IB connection terminal

<sup>\*1</sup>: Four ch model has 4 analog inputs  
<sup>\*2</sup>: Option is required for feature activation  
<sup>\*3</sup>: Four ch model has 4 terminals

# Specifications

(On the 4-channel model, CH8 should be read as CH4 and M8 should be read as M4.)

Models					
Model name	A/D resolution	Frequency bandwidth	Analog input	Logic input	Max. sample rate
DLM5038HD	12 bit	350 MHz	8 channels	16 bit (Standard) or 32 bit (/L4 or /L32)	2.5 GS/s
DLM5058HD		500 MHz			
DLM5034HD		350 MHz	4 channels		
DLM5054HD		500 MHz			
DLM5038	8 bit	350 MHz	8 channels		
DLM5058		500 MHz			
DLM5034		350 MHz	4 channels		
DLM5054		500 MHz			

## Analog Signal Input

Input channels	DLM50x8HD, DLM50x8: CH1 to CH8 DLM50x4HD, DLM50x4: CH1 to CH4	
Input coupling setting	AC 1 MΩ, DC 1 MΩ, DC 50 Ω	
Input impedance	Analog input 1 MΩ ±1.0%, approximately 16 pF 50 Ω ±1.0% (VSWR 1.4 or less, DC to 500 MHz)	
Voltage axis sensitivity setting range	1 MΩ 500 μV/div to 10 V/div (steps of 1-2-5) 50 Ω 500 μV/div to 1 V/div (steps of 1-2-5)	
Max. input voltage	1 MΩ Must not exceed 300 Vrms or 400 Vpeak 50 Ω Must not exceed 5 Vrms or 10 Vpeak	
Max. DC offset setting range	1 MΩ 500 μV/div to 50 mV/div ±1 V 100 mV/div to 500 mV/div ±10 V 1 V/div to 10 V/div ±100 V 50 Ω 500 μV/div to 50 mV/div ±1 V 100 mV/div to 1 V/div ±5 V	

Vertical-axis (voltage-axis)	DC accuracy <sup>1</sup> 500 μV/div ±(3.0% of 8 div + offset voltage accuracy) 1 mV/div to 10 V/div ±(1.5% of 8 div + offset voltage accuracy)	
Offset voltage accuracy <sup>1</sup>	500 μV to 50 mV/div ±(1% of setting + 0.2 mV) 100 mV to 500 mV/div ±(1% of setting + 2 mV) 1 V to 10 V/div ±(1% of setting + 20 mV)	

Frequency characteristics (-3 dB attenuation when inputting a sinewave of amplitude ±3 div) <sup>1,2</sup>			
		DLM503xHD, DLM503x	DLM505xHD, DLM505x
1 MΩ (when using attached 10:1 passive probe)	20 mV to 100 V/div	350 MHz	500 MHz
	10 mV/div	350 MHz	350 MHz
	5 mV/div	200 MHz	200 MHz
50 Ω	2 mV to 1 V/div	350 MHz	500 MHz
	1 mV/div	350 MHz	350 MHz
	500 μV/div	200 MHz	200 MHz

Isolation between channels	Maximum bandwidth: DLM50xxHD: -65 dB (typical value) <sup>6</sup> DLM50xx: -34 dB (typical value) <sup>7</sup>															
Residual noise level <sup>3</sup>	DLM503xHD: 103 μVrms (2 mV/div) (typical value) DLM505xHD: 134 μVrms (2 mV/div) (typical value) DLM50xx: The larger of 0.2 mVrms or 0.05 div rms (typical value)															
A/D resolution	DLM50xxHD: 12 bit (400 LSB/div), DLM50xx: 8 bit (25 LSB/div)															
Bandwidth limit	FULL, 200 MHz, 100 MHz, 20 MHz, 10 MHz, 5 MHz, 2 MHz, 1 MHz, 500 kHz, 250 kHz, 125 kHz, 62.5 kHz, 32 kHz, 16 kHz, 8 kHz (can be set for each channel)															
Maximum sample rate	Real time sampling mode: 2.5 GS/s Repetitive sampling mode: 250 GS/s															
Maximum record length (Points)	<table border="1"> <thead> <tr> <th></th> <th>Repeat</th> <th>Single (when odd ch only)</th> </tr> </thead> <tbody> <tr> <td>Standard model</td> <td>12.5 M</td> <td>50 M (125 M)</td> </tr> <tr> <td>/M1 or /M1S</td> <td>25 M</td> <td>125 M (250 M)</td> </tr> <tr> <td>/M2 or /M2S</td> <td>50 M</td> <td>250 M (500 M)</td> </tr> <tr> <td>/M3 or /M3S</td> <td>125 M</td> <td>500 M (1 Giga)</td> </tr> </tbody> </table> <p><sup>4</sup>/M3 or /M3S are applicable to DLM50xxHD only</p>		Repeat	Single (when odd ch only)	Standard model	12.5 M	50 M (125 M)	/M1 or /M1S	25 M	125 M (250 M)	/M2 or /M2S	50 M	250 M (500 M)	/M3 or /M3S	125 M	500 M (1 Giga)
	Repeat	Single (when odd ch only)														
Standard model	12.5 M	50 M (125 M)														
/M1 or /M1S	25 M	125 M (250 M)														
/M2 or /M2S	50 M	250 M (500 M)														
/M3 or /M3S	125 M	500 M (1 Giga)														

Ch-to-Ch deskew	±1 μs
Time axis setting range	1 ns/div to 500 s/div (steps of 1-2-5)
Time base accuracy <sup>1</sup>	±2.5 ppm (at shipping or calibration), ±1.0 ppm/year (ageing)
Dead time in N Single mode	Approx. 0.9 μs

Logic Signal Input	
Number of inputs	16 bit (/L4 or /L32: 32 bit)
Maximum toggle frequency <sup>1</sup>	Model 701988: 100 MHz, Model 701989: 250 MHz

Compatible probes	701988, 701989 (8 bit input)
Min. input voltage	701988: 500 mVp-p, 701989: 300 mVp-p
Input range	Model 701988: ±40 V Model 701989: threshold ±6 V
Max. nondestructive input voltage	Model 701988: ±42 V (DC + ACpeak) or 29 Vrms Model 701989: ±40 V (DC + ACpeak) or 28 Vrms
Threshold level setting range	Model 701988: ±40 V (setting resolution of 0.05 V) Model 701989: ±6 V (setting resolution of 0.05 V)
Input impedance	701988: Approx. 1 MΩ/approx. 10 pF, 701989: Approx. 100 kΩ/approx. 3 pF
Maximum sample rate	1.25 GS/s

Maximum record length (Points)	Repeat	Single
	Standard	12.5 M
/M1 or /M1S	25 M	125 M (250 M)
/M2 or /M2S	50 M	250 M (500 M)
/M3 or /M3S	125 M	500 M (1 Giga)

When selected in parentheses, only logic ports A and B are valid.  
<sup>5</sup>/M3 or /M3S are applicable to DLM50xxHD only

## Triggers

Trigger modes	Auto, Auto Level, Normal, Single, N-Single, Force trigger	
Trigger type, trigger source	A triggers	
Edge	CH1 to CH8, Logic, EXT, LINE	
Edge OR	CH1 to CH8	
Pulse Width	CH1 to CH8, Logic	
Timeout	CH1 to CH8, Logic	
Pattern	CH1 to CH8, Logic	
Runt	CH1 to CH8	
Rise/Fall Time	CH1 to CH8	
Interval	CH1 to CH8, Logic	
Window	CH1 to CH8	
Window OR	CH1 to CH8	
TV	CH1 to CH8	
Serial Bus	I <sup>2</sup> C (optional)	CH1 to CH8, Logic
	SPI (optional)	CH1 to CH8, Logic
	UART (optional)	CH1 to CH8, Logic
	FlexRay (optional)	CH1 to CH8
	CAN (optional)	CH1 to CH8
	CAN FD (optional)	CH1 to CH8
	LIN (optional)	CH1 to CH8
	SENT (optional)	CH1 to CH8, Logic
	CXPI (optional)	CH1 to CH8
	PSI5 Airbag (optional)	CH1 to CH8
	User Define	CH1 to CH8
AB triggers	A Delay B	10 ns to 10 s
	A to B(n)	1 to 10 <sup>9</sup>

Trigger level setting range	CH1 to CH8	±4 div from center of screen
Trigger level setting resolution	CH1 to CH8	0.01 div (TV trigger: 0.1 div)
Trigger level accuracy <sup>1</sup>	CH1 to CH8	±0.04 div

## Display

Display <sup>4</sup>	12.1-inch TFT LCD with a capacitive touch screen, 1024 × 768 (XGA)
----------------------	--

## Functions

Waveform acquisition modes	Normal, Envelope, Average	
High Resolution mode	DLM50xxHD: Maximum 16 bit, DLM50xx: Maximum 12 bit	
Sampling modes	Real time, Interpolation, Repetitive	
Accumulation	Select OFF, Intensity (waveform frequency by brightness), or Color (waveform frequency by color) Accumulation time: 100 ms to 100 s, Infinite	
Roll mode	Enabled at 100 ms/div to 500 s/div (depending on the record length setting)	
Zoom function	Two zooming windows can be set independently (Zoom1, Zoom2)	
Zoom factor	×2 to 2.5 points/10 div (in zoom area)	
Scroll	Auto Scroll	
Search functions	Edge, Pulse Width, Timeout, Pattern, I <sup>2</sup> C (optional), SPI (optional), UART (optional), CAN (optional), CAN FD (optional), LIN (optional), FlexRay (optional), SENT (optional), CXPI (optional), PSI5 Airbag (optional), User Define	
History memory	Max. data (record length 1.25 k Points, with) /M3 or /M3S: 200000, /M2 or /M2S: 100000, /M1 or /M1S: 50000, Standard: 20000 <sup>5</sup> /M3 or /M3S are applicable to DLM50xxHD only	
History search	Select Rect, Wave, Polygon, or Parameter mode	
Replay function	Automatically displays the history waveforms sequentially	
Display	Specified or average waveforms	



Cursor	Types	$\Delta T$ , $\Delta V$ , $\Delta T$ & $\Delta V$ , Marker, Degree
Snapshot	Currently displayed waveform can be retained on screen	
<b>Computation and Analysis Functions</b>		
Parameter Measurement	Max, Min, P-P, High, Low, Amplitude, Rms, Mean, Sdev, IntegTY+, IntegTY-, +Over, -Over, Pulse Count, Edge Count, V1, V2, $\Delta T$ , Freq, Period, Avg Freq, Avg Period, Burst, Rise, Fall, +Width, -Width, Duty, Delay	
Statistical computation of parameters	Max, Min, Mean, $\sigma$ , Count	
Statistics modes	Continuous, Cycle, History	
Trend/Histogram display of wave parameters	Up to 2 trend or histogram display of specified wave parameters	
Computations (MATH)	+, -, $\times$ , /, Filter (Delay, Moving Avg, IIR Lowpass, IIR Highpass), Integ, Count (Edge, Rotary), user defined math (optional)	
Computable no. of traces	8 (M1 to M8) (4 trace for 4 ch model) (mutually exclusive with REF trace)	
Max. computable memory length	Same as the maximum record length	
Reference function	Up to 8 traces (Ref1 to Ref8) of saved waveform data can be displayed and analyzed (4 trace for 4 ch model) (mutually exclusive with MATH trace)	
Action-on-trigger	Actions: Buzzer, Print, Save, Mail	
GO/NO-GO	Modes: Rect, Wave, Polygon, Parameter Actions: Buzzer, Print, Save, Mail	
X-Y	Displays XY1 to XY4 and T-Y simultaneously (XY1, XY2 and T-Y for 4ch model)	
FFT	Number of points: 1.25 k, 2.5k, 12.5 k, 25 k, 125 k, 250 k, 1.25 M Window functions: Rectangular, Hanning, Flat-Top FFT Types: PS (LS, RS, PSD, CS, TF, CH are available with /G2 or /G02 option)	
Histogram	Displays a histogram of acquired waveforms	
User-defined math (/G2 or /G02 option)	The following operators can be arbitrarily combined in equations: +, -, $\times$ , /, SIN, COS, TAN, ASIN, ACOS, ATAN, INTEG, DIFF, ABS, SQRT, LOG, EXP, LN, BIN, DELAY, P2 (power of 2), PH, DA, MEAN, HLBT, PWHH, PWLL, PWHL, PWWX, FV, DUTYH, DUTYL, FILT1, FILT2 The maximum record length that can be computed is the same as the standard math functions.	
Power supply analysis (/G3 or /G03 option)	Power analysis Selectable from 4 analysis types Deskewing between the voltage and current waveforms can be executed automatically.	
	Switching loss	Measurement of total loss and switching loss, power waveform display, Automatic measurement and statistical analysis of power analysis items (PTurn On, PTurn Off, POn, PTotal, WpTurn On, WpTurn Off, Wp On, WpTotal, Cycle Count)
	Safety operation area	SOA analysis by X-Y display, using voltage as X axis, and current as Y axis is possible
	Harmonic analysis	Basic comparison is possible with following standard Harmonic emission standard IEC61000-3-2 edition 4.0, EN61000-3-2 (2006), IEC61000-4-7 edition 2.1
	Joule integral	Joule integral (Ft) waveform display, automatic measurement and statistical analysis is possible
Power Measurement	Automated measurement of power parameters for up to four pairs of voltage and current waveforms. Values can be statistically processed and calculated.	
	Measurement parameters	Urms, Umn, Udc, Urmn, Uac, U+pk, U-pk, Up-p, lrms, lmn, ldc, lrmn, lac, l+pk, l-pk, lp-p, P, S, Q, Z, $\lambda$ , Wp, Wp+, Wp-, Abs.Wp, q, q+, q-, Abs.q, Avg Freq (voltage, current)
<b>Common Features of Serial Bus Signal Analysis Functions</b>		
Analysis result display	Decoded information is displayed together with waveforms or in list form.	
Auto setup function	A threshold value, time axis scale, voltage axis scale and other bus-specific parameters such as a bit rate and recessive level are automatically detected. Trigger conditions are set based on the detected result and decoded information is displayed. (The type of a bus signal needs to be specified in advance.)	
Search function	Search of all waveforms for a position that matches a pattern or condition specified by data information.	
Analysis result saving function	Analysis list data can be saved to CSV-format files.	
<b>PC Bus Signal Analysis Functions (/F1 or /F01 Option)</b>		
Applicable bus	PC bus	Bus transfer rate: 3.4 Mbit/s max. Address mode: 7 bit/10 bit
	SM bus	Complies with System Management Bus
Analyzable signals	CH1 to CH8, Logic input, or M1 to M8	

PC trigger modes	Every Start, Address & Data, NON ACK, General Call, Start Byte, HS Mode	
Analyzable no. of data	300000 bytes max.	
List display items	Analysis no., Time from trigger position [Time (ms)], 1st byte address, 2nd byte address, R/W, Data, Presence/absence of ACK, Information	
<b>SPI Bus Signal Analysis Functions (/F1 or /F01 Option)</b>		
Trigger types	3 wire, 4 wire After assertion of CS, compares data after arbitrary byte count and triggers.	
Analyzable signals	CH1 to CH8, Logic input, M1 to M8	
Byte order	MSB, LSB	
Analyzable no. of data	300000 bytes max.	
List display items	Analysis no., Time from trigger position [Time (ms)], Data 1, Data 2	
<b>UART Signal Analysis Functions (/F1 or /F01 Option)</b>		
Bit rate	115200 bps, 57600 bps, 38400 bps, 19200 bps, 9600 bps, 4800 bps, 2400 bps, 1200 bps, User Define (an arbitrary bit rate from 200 to 10 Mbps with resolution of 0.5 bps)	
Analyzable signals	CH1 to CH8, Logic input, or M1 to M8	
Data format	Select a data format from the following 8 bit (Non Parity), 7 bit Data + Parity, 8 bit + Parity	
UART trigger modes	Every Data, Data, Error	
Analyzable no. of data	300000 bytes max.	
List display items	Analysis no., Time from trigger position [Time (ms)], Data (Bin, Hex) display, ASCII display, Information.	
<b>CAN Bus Signal Analysis Functions (/F2 or /F02 Option)</b>		
Applicable bus	CAN version 2.0A/B, Hi-Speed CAN (ISO11898), Low-Speed CAN (ISO11519-2)	
Analyzable signals	CH1 to CH8, M1 to M8	
Bit rate	1 Mbps, 500 kbps, 250 kbps, 125 kbps, 83.3 kbps, 33.3 kbps, User Define (an arbitrary bit rate from 10 kbps to 1 Mbps with resolution of 100 bps)	
CAN bus trigger modes	SOF, ID/Data, ID OR, Error, Message and signal (enabled when loading physical values/symbol definitions)	
Analyzable no. of frames	100000 frames max.	
List display items	Analysis no., Time from trigger position [Time (ms)], Frame type, ID, DLC, Data, CRC, Presence/absence of Ack, Information	
Auxiliary analysis functions	Field jump functions	
<b>CAN FD Bus Signal Analysis Functions (/F2 or /F02 Option)</b>		
Applicable bus	CAN FD (ISO 11898-1:2015 and non-ISO)	
Analyzable signals	CH1 to CH8, M1 to M8	
Bit rate	Arbitration	1 Mbps, 500 kbps, 250 kbps, User Define (an arbitrary bit rate from 20 kbps to 1 Mbps with resolution of 100 bps)
	Data	8 Mbps, 5 Mbps, 4 Mbps, 2 Mbps, 1 Mbps, 500 kbps, User Define (an arbitrary bit rate from 250 kbps to 10 Mbps with resolution of 100 bps)
CAN FD bus trigger modes	SOF, Error, ID/Data, ID OR, FDF, ESI, Message (enabled when loading physical values/symbol definitions)	
Analyzable no. of frames	50000 frames max.	
List display items	Analysis no., Time from trigger position [Time (ms)], Frame type, ID, DLC, Data, CRC, Presence/absence of Ack, Information	
Auxiliary analysis functions	Field jump functions	
<b>LIN Bus Signal Analysis Functions (/F2 or /F02 Option)</b>		
Applicable bus	LIN Rev. 1.3, 2.0	
Analyzable signals	CH1 to CH8, M1 to M8	
Bit rate	19.2 kbps, 9.6 kbps, 4.8 kbps, 2.4 kbps, 1.2 kbps, User Define (an arbitrary bit rate from 1 kbps to 20 kbps with resolution of 10 bps)	
LIN bus trigger modes	Break Synch, ID/Data, ID OR, Error	
Analyzable no. of frames	100000 frames max.	
List display items	Analysis no., Time from trigger position [Time (ms)], ID, ID-Field, Data, Checksum, Information	
Auxiliary analysis functions	Field jump functions	
<b>FlexRay Bus Signal Analysis Functions (/F3 or /F03 Option)</b>		
Applicable bus	FlexRay Protocol Version 2.1	
Analyzable signals	CH1 to CH8, M1 to M8	
Bit rate	10 Mbps, 5 Mbps, 2.5 Mbps	
FlexRay bus trigger modes	Frame Start, Error, ID/Data, ID OR	
Analyzable no. of frames	5000 frames max.	
List display items	Analysis no., Time from trigger position [Time (ms)], Segment (Static or Dynamic), Indicator, FrameID, Payload length, Cycle count, Data, Information	
<b>SENT Signal Analysis Functions (/F4 or /F04 Option)</b>		
Applicable standard	J2716 APR2016 and older	

Analyzable signals	CH1 to CH8, Logic input, or M1 to M8
Clock period	1 μs to 100 μs with resolution of 0.01 μs
Data type	Fast channel Nibbles/User Defined Slow channel Short/Enhanced
SENT trigger modes	Every Fast CH, Fast CH Status & Communication, Fast CH Data, Every Slow CH, Slow CH ID/Data, Error
Analyzable no. of frames	100000 frames max.
List display items	Fast channel Analysis no., Time from trigger position [Time (ms)], Sync/Cal period, Tick, Status & Comm, Data, CRC, Frame length, Information Slow channel Analysis no., Time from trigger position [Time (ms)], ID, Data, CRC, Information
Auxiliary analysis functions	Trend functions (up to 4 trend waveforms)

CXPI Bus Signal Analysis Functions (/F5 or /F05 Option)	
Applicable bus	CXPI JASO D 015-3:2015
Analyzable signals	CH1 to CH8, M1 to M8
Bit rate	19.2 kbps, 9.6 kbps, 4.8 kbps, User Define (an arbitrary bit rate from 4 kbps to 50 kbps with resolution of 10 bps)
Analyzable no. of frames	10000 frames max.
List display items	Analysis no., Time from trigger position [Time (ms)], ID, DLC, W/S, CT, Data, CRC, Error information, Wakeup/Sleep

PSI5 Signal Analysis Functions (/F6 or /F06 Option)	
Applicable standard	PSI5 Airbag <sup>5</sup>
Analyzable signals	CH1 to CH8, M1 to M8
Bit rate	189 kbps, 125 kbps, User Define (10.0 k to 1000.0 kbps, with resolution of 0.1 kbps)
PSI5 Airbag Trigger modes	Sync, Start Bit, Data, Frame In Slot, Error
Analyzable no. of frames	400000 frames max.
List display items	Analysis no., Time from trigger position, Time from Sync, Slot no., Data, Parity/CRC, Information
Auxiliary analysis function	Trend functions (up to 4 trend waveforms)

GP-IB (/C1 Option)	
Electromechanical specifications	Conforms to IEEE std. 488-1978 (JIS C 1901-1987)
Protocol	Conforms to IEEE std. 488.2-1992

Auxiliary Input	
Rear panel I/O signal	External trigger input, External trigger output, GO/NO-GO output, Video output
Probe interface terminal (front panel)	8 terminals (8 ch model), 4 terminals (4 ch model)
Probe power terminal (side panel)	8 terminals (/P8 option), 4 terminals (/P4 option)
Synchronous Operation I/O (SYNC)	26-pin half pitch (female) Dedicated synchronous operation cable (701982-01, -02)

Internal Storage (Standard model, /C8 Option)	
Capacity	Standard model: Approx. 1.7 GB, /C8 option: Approx. 64 GB

Built-in Printer (/B5 Option)	
Built-in printer	112 mm wide, monochrome, thermal

Synchronous Operation (/SY or /SYN Option)	
Connection method	Connect two DLM5000 units or DLM5000HD with the dedicated cable for synchronous operation (701982-01, -02). Between DLM5000 and DLM5000HD cannot be connected
Synchronization items	Measurement start/stop, Sampling clock, Time, Trigger
Sampling skew between units	20.20 ns with 701982-01 (Typical) 27.90 ns with 701982-02 (Typical) Adjustable to within ±50 ps (De-skew)
Skew adjustment between units (De-skew)	Adjustable sampling skew between units Adjustment range: 15.0 ns to 35.0 ns (0.05 ns resolution)

USB Peripheral Connection Terminal	
Connector	USB type A connector × 2 (front panel × 2)
Electromechanical specifications	USB 2.0 compliant
Supported transfer standards	High Speed, Full Speed, Low Speed
Supported devices	USB Printer Class Ver. 1.0 compliant HP (PCL) inkjet printers, USB Mass Storage Class Ver. 1.1 compliant mass storage devices (Usable capacity: 8 TB, Partition format: GPT/MBR, File format: exFAT/FAT 32/FAT 16) <sup>1</sup> Please contact your local YOKOGAWA sales office for model names of verified devices

USB-PC Connection Terminal	
Connector	USB type B connector × 1
Electromechanical specifications	USB 3.0 compliant
Supported transfer standards	Super Speed, High Speed, Full Speed
Supported class	Mass Storage Class Ver. 1.1 USBTMC-USB488 (USB Test and Measurement Class Ver. 1.0)

Ethernet	
Connector	RJ-45 connector × 1
Transmission methods	Ethernet (1000BASE-T/100BASE-TX/10BASE-T)
Supported services	Server: FTP, VXI-11, Socket Client: FTP, SMTP, SNMP, LPR, DHCP, DNS
PTP	Protocol: IEEE1588-2008 (PTPv2) (client only, master feature is available with /CY option)  Synchronization accuracy: ±200 ns (typical) when 1000BASE-T is used and an Ethernet switch is not used  Synchronization items: Built-in time, Sampling clock

General Specifications	
Rated supply voltage	100 to 120 VAC/220 to 240 VAC (Automatic switching)
Rated supply frequency	50 Hz/60 Hz
Maximum power consumption	290 VA
External dimensions	426 (W) × 266 (H) × 180 (D) mm (when printer cover is closed, excluding protrusions)
Weight	Approx. 7.3 kg, With no options
Operating temperature range	5°C to 40°C

- <sup>1</sup>: Measured under standard operating conditions after a 30-minute warm-up followed by calibration. Standard operating conditions: Ambient temperature: 23°C±5°C, Ambient humidity: 55±10% RH  
Error in supply voltage and frequency: Within 1% of rating
- <sup>2</sup>: Value in the case of repetitive phenomenon. The frequency bandwidth of a single-shot phenomenon is the smaller of the two values, DC to sampling frequency/2.5 or the frequency bandwidth of the repetitive phenomenon.
- <sup>3</sup>: When the acquisition mode is set to Normal, accumulation is OFF, and the probe attenuation is set to 1:1.
- <sup>4</sup>: The LCD may include a few defective pixels (within 3 ppm over the total number of pixels including RGB).
- <sup>5</sup>: Support for analysis of ECU synchronization signals and sensor signals.
- <sup>6</sup>: Input/Output Ratio measured using FFT (dB)
- <sup>7</sup>: Input/Output Ratio of SDEV on the time axis (dB)

**External Dimensions**

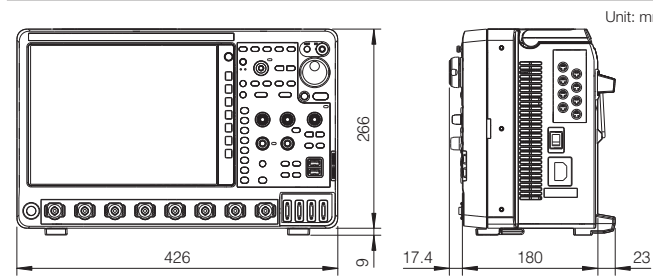

## Model and Suffix Codes

### High Definition Oscilloscope DLM5000HD Series

Model <sup>1</sup>	Suffix code	Description
DLM5038HD		High Definition Oscilloscope: 8 ch, 350 MHz
DLM5058HD		High Definition Oscilloscope: 8 ch, 500 MHz
DLM5034HD		High Definition Oscilloscope: 4 ch, 350 MHz
DLM5054HD		High Definition Oscilloscope: 4 ch, 500 MHz
Power cord	-D	UL/CSA Standard and PSE compliant
	-F	VDE/Korean Standard
	-Q	British Standard
	-R	Australian Standard
	-H	Chinese Standard
	-N	Brazilian Standard
	-T	Taiwanese Standard
	-B	Indian Standard
	-U	IEC Plug Type B
Language	-HJ	Japanese message and panel
	-HE	English message and panel
	-HC	Chinese message and panel
	-HG	German message and panel
	-HF	French message and panel
	-HK	Korean message and panel
	-HL	Italian message and panel
	-HS	Spanish message and panel
	Option	/L4
/B5		Built-in printer (112 mm)
/M1 <sup>2</sup>		Memory expansion option (8 ch model only) During continuous measurement: 25 M points; Single mode: 125 M points/250 M points <sup>3</sup>
/M2 <sup>2</sup>		Memory expansion option (8 ch model only) During continuous measurement: 50 M points; Single mode: 250 M points/500 M points <sup>3</sup>
/M3 <sup>2</sup>		Memory expansion option (8 ch model only) During continuous measurement: 125 M points; Single mode: 500 M points/1 G points <sup>3</sup>
/M1S <sup>2</sup>		Memory expansion option (4 ch model only) During continuous measurement: 25 M points; Single mode: 125 M points/250 M points <sup>3</sup>
/M2S <sup>2</sup>		Memory expansion option (4 ch model only) During continuous measurement: 50 M points; Single mode: 250 M points/500 M points <sup>3</sup>
/M3S <sup>2</sup>		Memory expansion option (4 ch model only) During continuous measurement: 125 M points; Single mode: 500 M points/1 G points <sup>3</sup>
/P8 <sup>4</sup>		8 probe power terminals (for 8 ch model)
/P4 <sup>4</sup>		4 probe power terminals (for 4 ch model)
/C1		GP-IB interface
/C8		Internal storage (64 GB)
/CY		IEEE1588 master function
/SY <sup>5</sup>		Synchronous Operation
/G2 <sup>6</sup>		User-defined math function
/G3 <sup>6</sup>		Power supply analysis function
/GA <sup>6</sup>		User-defined math function + Power supply analysis function
/F1		UART + I <sup>2</sup> C + SPI trigger and analysis
/F2		CAN + CAN FD + LIN trigger and analysis
/F3		FlexRay trigger and analysis
/F4		SENT trigger and analysis
/F5	CXPI trigger and analysis	
/F6	PSI5 trigger and analysis	
/E1 <sup>7</sup>	Four additional 701937 probes (8 in total) (for 8 ch model)	
/E2 <sup>7</sup>	Attach four 701949 probes	
/E3 <sup>7</sup>	Attach eight 701949 probes (for 8 ch model)	

#### Standard Main Unit Accessories

Power cord, Passive probe<sup>8</sup>, Protective front cover, Panel sheet<sup>9</sup>, Soft carrying case for probes, Printer roll paper (for /B5 option), Manuals<sup>10</sup>

### Additional Option License for DLM5000HD

Model	Suffix code	Description
709823	-CY	IEEE1588 master function
	-SY	Synchronous operation
	-G2	User-defined math function
	-G3	Power supply analysis function
	-F1	UART + I <sup>2</sup> C + SPI trigger and analysis
	-F2	CAN + CAN FD + LIN trigger and analysis
	-F3	FlexRay trigger and analysis
	-F4	SENT trigger and analysis
	-F5	CXPI trigger and analysis
	-F6	PSI5 trigger and analysis

### Mixed Signal Oscilloscope DLM5000 series

Model <sup>1</sup>	Suffix code	Description
DLM5038		Mixed Signal Oscilloscope: 8 ch, 350 MHz
DLM5058		Mixed Signal Oscilloscope: 8 ch, 500 MHz
DLM5034		Mixed Signal Oscilloscope: 4 ch, 350 MHz
DLM5054		Mixed Signal Oscilloscope: 4 ch, 500 MHz
Power cord	-D	UL/CSA Standard and PSE compliant
	-F	VDE/Korean Standard
	-Q	British Standard
	-R	Australian Standard
	-H	Chinese Standard
	-N	Brazilian Standard
	-T	Taiwanese Standard
	-B	Indian Standard
	-U	IEC Plug Type B
Language	-HJ	Japanese message and panel
	-HE	English message and panel
	-HC	Chinese message and panel
	-HG	German message and panel
	-HF	French message and panel
	-HK	Korean message and panel
	-HL	Italian message and panel
	-HS	Spanish message and panel
	Option	/L32
/B5		Built-in printer (112 mm)
/M1 <sup>2</sup>		Memory expansion option (8 ch model only) During continuous measurement: 25 M points; Single mode: 125 M points/250 M points <sup>3</sup>
/M2 <sup>2</sup>		Memory expansion option (8 ch model only) During continuous measurement: 50 M points; Single mode: 250 M points/500 M points <sup>3</sup>
/M1S <sup>2</sup>		Memory expansion option (4 ch model only) During continuous measurement: 25 M points; Single mode: 125 M points/250 M points <sup>3</sup>
/M2S <sup>2</sup>		Memory expansion option (4 ch model only) During continuous measurement: 50 M points; Single mode: 250 M points/500 M points <sup>3</sup>
/P8 <sup>4</sup>		8 probe power terminals (for 8 ch model)
/P4 <sup>4</sup>		4 probe power terminals (for 4 ch model)
/C1		GP-IB interface
/C8		Internal storage (64 GB)
/SYN <sup>5</sup>		Synchronous Operation
/G02		User-defined math function
/G03		Power supply analysis function
/F01		UART + I <sup>2</sup> C + SPI trigger and analysis
/F02		CAN + CAN FD + LIN trigger and analysis
/F03		FlexRay trigger and analysis
/F04		SENT trigger and analysis
/F05		CXPI trigger and analysis
/F06		PSI5 trigger and analysis
/E1 <sup>7</sup>		Four additional 701937 probes (8 in total) (for 8 ch model)
/E2 <sup>7</sup>		Attach four 701949 probes
/E3 <sup>7</sup>	Attach eight 701949 probes (for 8 ch model)	

#### Standard Main Unit Accessories

Power cord, Passive probe<sup>8</sup>, Protective front cover, Panel sheet<sup>9</sup>, Soft carrying case for probes, Printer roll paper (for /B5 option), User's manuals<sup>11</sup>

### Additional Option License for DLM5000

Model	Suffix code	Description
709821	-G02	User defined math
	-G03	Power supply analysis function
	-F01	UART + I <sup>2</sup> C + SPI trigger and analysis
	-F02	CAN + CAN FD + LIN trigger and analysis
	-F03	FlexRay trigger and analysis
	-F04	SENT trigger and analysis
	-F05	CXPI trigger and analysis
	-F06	PSI5 trigger and analysis
	-SYN	Synchronous Operation

\*1: Standard memory capacity: During continuous measurement: 12.5 M points; Single mode: 50 M points/125 M points (when odd channels only)

Logic probes sold separately.

\*2,\*4,\*6,\*7: When selecting from these options, please select only one.

\*3: When odd channels only

\*4: Specify this option when using current probes or other differential probes that don't support probe interface.

\*5: This option for both main and sub unit and a 701982 connection cable are required for synchronous operation.

\*8: Four 701937 except /E2 or /E3.

\*9: Except suffix code "-HE".

\*10: Start guide as the printed material, and User's manual can be downloaded from our web page.

\*11: Start guide as the printed material, and User's manual as CD-ROM are included.



## Accessory Models

Model	Name	Specification	
701988	Logic probe (PBL100)	1 M $\Omega$ , toggle freq. of 100 MHz	
701989	Logic probe (PBL250)	100 k $\Omega$ , toggle freq. of 250 MHz	
701937	Passive probe <sup>1</sup>	10 M $\Omega$ (10:1), 500 MHz, 1.3 m	
701949	Miniature passive probe	10 M $\Omega$ (10:1), 500 MHz, 1.3 m	
702907	Passive probe (Wide temperature range)	10 M $\Omega$ (10:1), 200 MHz, 2.5 m -40°C to +85°C	
700939	FET probe <sup>1</sup>	DC to 900 MHz BW, 2.5 M $\Omega$ /1.8 pF	
701944	100:1 voltage probe	DC to 400 MHz BW, 1.2 m, 1000 Vrms	
701945	100:1 voltage probe	DC to 250 MHz BW, 3 m, 1000 Vrms	
701977	Differential probe	DC to 50 MHz BW, max. $\pm$ 7000 V	
701978	Differential probe	DC to 150 MHz BW, max. $\pm$ 1500 V	
701924	Differential probe (PBDH1000)	DC to 1 GHz BW, 1 M $\Omega$ , max. $\pm$ 25 V	
701925	Differential probe (PBDH0500)	DC to 500 MHz BW, max. $\pm$ 25 V	
701927	Differential probe (PBDH0150)	DC to 150 MHz BW, max. $\pm$ 1400 V	
701917	Current probe <sup>2</sup>	DC to 50 MHz BW, 5 Arms	
701918	Current probe <sup>2</sup>	DC to 120 MHz BW, 5 Arms	
701929	Current probe (PBC050) <sup>2</sup>	DC to 50 MHz BW, 30 Arms	
701928	Current probe (PBC100) <sup>2</sup>	DC to 100 MHz BW, 30 Arms	
701930	Current probe <sup>2</sup>	DC to 10 MHz BW, 150 Arms	
701931	Current probe <sup>2</sup>	DC to 2 MHz BW, 500 Arms	
702915	Current probe <sup>2</sup>	DC to 50 MHz BW, 0.5, 5, 30 Arms	

Model	Name	Specification	
702916	Current probe <sup>2</sup>	DC to 120 MHz BW, 0.5, 5, 30 Arms	
701936	Deskew correction signal source	For deskew correction	
366973	Go/No-Go Cable	For GO/NO-GO output terminal	
B9988AE	Printer roll paper	Lot size is 10 rolls, 10 meters each	
701919	Probe stand	Round base, 1 arm	
701968	Soft carrying case	With 3 pockets for storage	
701969-E	Rack mount kit	EIA standard-compliant	
701969-J	Rack mount kit	JIS standard-compliant	
701982-01	Connection cable	Connection cable for DLM 1.0 m	
701982-02	Connection cable	Connection cable for DLM 2.8 m	

\*1: Please refer to the Probes and Accessories brochure for probe adapters.

\*2: Current probes' maximum input current may be limited by the number of probes used at a time.

## Accessory Software

Model	Name	Specification
IS8001*	IS8000 Integrated Software	Subscription (Annual license)
IS8002*	Platform	Perpetual (Permanent license)

\*See Bulletin IS8000-01EN for more detail about IS8000.

[DLM is a registered trademark of Yokogawa Electric Corporation.]

Any company's names and product names appearing in this document are the registered trademarks or trademarks of their respective companies.

### NOTICE

- Before operating the product, read the user's manual thoroughly for proper and safe operation.

This is a Class A instrument based on Emission standards EN61326-1 and EN55011, and is designed for an industrial environment. Operation of this equipment in a residential area may cause radio interference, in which case users will be responsible for any interference which they cause.

# YOKOGAWA

**YOKOGAWA TEST & MEASUREMENT CORPORATION**  
Global Sales Dept. /E-mail: tm@cs.jp.yokogawa.com

**YOKOGAWA CORPORATION OF AMERICA**  
**YOKOGAWA EUROPE B.V.**  
**YOKOGAWA TEST & MEASUREMENT (SHANGHAI) CO., LTD.**  
**YOKOGAWA ELECTRIC KOREA CO., LTD.**  
**YOKOGAWA ENGINEERING ASIA PTE. LTD.**  
**YOKOGAWA INDIA LTD.**  
**YOKOGAWA ELECTRIC CIS LTD.**  
**YOKOGAWA AMERICA DO SUL LTDA.**  
**YOKOGAWA MIDDLE EAST & AFRICA B.S.C(c)**

<https://tmi.yokogawa.com/us/>  
<https://tmi.yokogawa.com/eu/>  
<https://tmi.yokogawa.com/cn/>  
<https://tmi.yokogawa.com/kr/>  
<https://tmi.yokogawa.com/sg/>  
<https://tmi.yokogawa.com/in/>  
<https://tmi.yokogawa.com/ru/>  
<https://tmi.yokogawa.com/br/>  
<https://tmi.yokogawa.com/bh/>

<https://tmi.yokogawa.com/>

YMI-N-MI-M-E03

The contents are as of August, 2023 Subject to change without notice.  
Copyright © 2020, Yokogawa Test & Measurement Corporation  
[Ed: 04/b] Printed in Japan, 308(KP)