



Advanced Test Equipment Rentals
www.atecorp.com 800-404-ATEC (2832)

FLUKE®

Fluke 39/41B

Power Harmonics Tester

Users Manual

4822 872 00916
July 1995 Rev. 3, 11/00
© 1995 Fluke Corporation. All rights reserved. Printed in the Netherlands.
All product names are trademarks of their respective companies.

LIMITED WARRANTY & LIMITATION OF LIABILITY

Each Fluke product is warranted to be free from defects in material and workmanship under normal use and service. The warranty period is one year and begins on the date of shipment. Parts, product repairs and services are warranted for 90 days. This warranty extends only to the original buyer or end-user customer of a Fluke authorized reseller, and does not apply to fuses, disposable batteries or to any product which, in Fluke's opinion, has been misused, altered, neglected or damaged by accident or abnormal conditions of operation or handling. Fluke warrants that software will operate substantially in accordance with its functional specifications for 90 days and that it has been properly recorded on non-defective media. Fluke does not warrant that software will be error free or operate without interruption.

Fluke authorized resellers shall extend this warranty on new and unused products to end-user customers only but have no authority to extend a greater or different warranty on behalf of Fluke. Warranty support is available if product is purchased through a Fluke authorized sales outlet or Buyer has paid the applicable international price. Fluke reserves the right to invoice Buyer for importation costs of repair/replacement parts when product purchased in one country is submitted for repair in another country.

Fluke's warranty obligation is limited, at Fluke's option, to refund of the purchase price, free of charge repair, or replacement of a defective product which is returned to a Fluke authorized service center within the warranty period.

To obtain warranty service, contact your nearest Fluke authorized service center or send the product, with a description of the difficulty, postage and insurance prepaid (FOB Destination), to the nearest Fluke authorized service center. Fluke assumes no risk for damage in transit. Following warranty repair, the product will be returned to Buyer, transportation prepaid (FOB Destination). If Fluke determines that the failure was caused by misuse, alteration, accident or abnormal condition of operation or handling, Fluke will provide an estimate of repair costs and obtain authorization before commencing the work. Following repair, the product will be returned to the Buyer transportation prepaid and the Buyer will be billed for the repair and return transportation charges (FOB Shipping Point).

THIS WARRANTY IS BUYER'S SOLE AND EXCLUSIVE REMEDY AND IS IN LIEU OF ALL OTHER WARRANTIES, EXPRESS OR IMPLIED, INCLUDING BUT NOT LIMITED TO ANY IMPLIED WARRANTY OF MERCHANTABILITY OR FITNESS FOR A PARTICULAR PURPOSE. FLUKE SHALL NOT BE LIABLE FOR ANY SPECIAL, INDIRECT, INCIDENTAL OR CONSEQUENTIAL DAMAGES OR LOSSES, INCLUDING LOSS OF DATA, WHETHER ARISING FROM BREACH OF WARRANTY OR BASED ON CONTRACT, TORT, RELIANCE OR ANY OTHER THEORY.

Since some countries or states do not allow limitation of the term of an implied warranty, or exclusion or limitation of incidental or consequential damages, the limitations and exclusions of this warranty may not apply to every buyer. If any provision of this Warranty is held invalid or unenforceable by a court of competent jurisdiction, such holding will not affect the validity or enforceability of any other provision.

Fluke Corporation
P.O. Box 9090
Everett WA
98206-9090

Fluke Europe B.V.
P.O. Box 1186
5602 B.D. Eindhoven
The Netherlands

SERVICE CENTERS

To locate an authorized service center, visit us on the World Wide Web:

<http://www.fluke.com>

or call Fluke using any of the phone numbers listed below:

+1-888-993-5853 in U.S.A. and Canada

+31-402-678-200 in Europe

+1-425-356-5500 from other countries

Table of Contents

Title	Page
Safety	v
About This Manual.....	1
Uses for the Tester	1
Unpacking.....	2
Terminology Used in This Manual.....	5
Battery Considerations	6
Memory Retention.....	6
Automatic Power Down.....	6
Getting Acquainted with Your Tester	7
Input Connections.....	9
Using the Voltage Test Leads	9
Using the Current Probe	10
Three-Phase Power Measurements	11
Keypad.....	14
Display Screen	19
Functions and Screen Modes	25
Waveform Screen Mode	25
Harmonics Screen Mode.....	27
Harmonics Zoom Mode	30
Text Screen Mode	31
VA Check Screen	33
Recording Measurements	35
Power-Up Configuration.....	37
Storing & Recalling Measurements (Model 41B).....	39
Using the Serial Cable (Model 41B).....	41
Printing (Model 41B)	43
Sending to a Printer or PC (Model 41B)	43
Using PC Software With the Tester (Model 41B)	43
Applications	44
Plant Switch Gear (Service Entrance)	46
Distribution Transformer.....	47
Electronic Equipment Load Center	48
Generator Set	50

Fluke 39/41B
Users Manual

Adjustable Frequency (Speed) Motor Drive	51
User Maintenance	52
Cleaning.....	52
Fuse Replacement	52
Battery Replacement	52
Operational Test.....	54
If the Screen Flashes or is Blank at Power-Up	54
If Your Tester Does Not Work.....	54
Accessories and Replacement Parts	55
Specifications.....	57

List of Tables

Table	Title	Page
1.	Key Descriptions	15
2.	Status Line	20
3.	Screen Abbreviations.....	21
4.	Special Messages	24
5.	Replacement Parts.....	56

List of Figures

Figure	Title	Page
1.	Tester and Accessories	3
2.	Additional Items (Model 41B).....	4
3.	Getting Acquainted	8
4.	Measurement Connections (1 ϕ)	10
5.	Three-Phase Measurement Connections (For Balanced Circuits, 3 ϕ , 3-Conductor, Δ).....	11
6.	Three-Phase Measurement, Balanced or Unbalanced Connections (3 ϕ , 3-Conductor, Δ or ∇)	12
7.	Three-Phase Measurement, Balanced or Unbalanced Connections (3 ϕ , 4-Conductor)	13
8.	Keypad.....	14
9.	Display Screen	19
10.	Waveform Screens.....	26
11.	Harmonics Screens	28
12.	Harmonics Overload Screen	29
13.	Harmonics Zoom Screen.....	30
14.	Text Screens	32
15.	Typical VA Check Signatures.....	34
16.	Record Screens.....	36
17.	Configuration Screens	38
18.	Memory Screen	39
19.	Serial Communications (Model 41B).....	42
20.	Typical Applications.....	45
21.	Plant Switch Gear	46
22.	Distribution Transformer (1 ϕ Watts Text Screen)	47
23.	Distribution Transformer (3 ϕ , 3C Watts Text Screen)	48
24.	Receptacle Load Center (Neutral Current Measurement)	49
25.	Generator Set	50
26.	Adjustable Frequency Motor Drive	51
27.	Battery Replacement	53

Using Your Tester Safely









Warning

To avoid electric shock, use only the test leads supplied with the Tester. Use 600V rated probe tip adapters. (“600V” is printed on the equipment.) Remove all test leads that are not in use.

Use only the 80i-500s ac current probe or a safety-designed equivalent (such as the Fluke Model 80i-1000s) that is rated for 600V on both the jaws and the measuring secondary. Remove any current probe that is not in use.

In this manual, a WARNING identifies conditions and actions that pose hazard(s) to the user. A Caution identifies conditions and actions that may damage the tester or the current probe. See below for explanations of international electrical symbols.

Read the following safety information carefully before attempting to operate or service the Tester or the current probe.

	DANGEROUS VOLTAGE		CAUTION see explanation in manual
	AC-ALTERNATING CURRENT		Equipment protected throughout by DOUBLE INSULATION or REINFORCED INSULATION
	DC-DIRECT CURRENT		
	Either DC or AC		RECYCLING
	EARTH		HIGH BNC INPUT

International Safety Symbols

Safety Guidelines for Tester and Voltage Probe

To ensure that you use your Tester safely, follow these guidelines:

- Avoid working alone.
- Inspect the test leads for damaged insulation or exposed metal. Check test lead continuity with a multimeter. Replace damaged leads.
- Do not use the Tester if it looks damaged.

- When using the voltage test leads, keep your fingers away from the probe contacts. Keep your fingers behind the finger guards on the probes.
- Use caution when measuring above 60V-dc or 30V-ac rms. Such voltages pose a shock hazard.

AC Current Probe Safety Guidelines

Follow these safety guidelines when using the AC Current Probe:

-  Never use the 80i-500s current probe on circuits rated higher than 600V. Use extreme caution when clamping the current probe around un-insulated conductors or bus bars.
- Keep your fingers behind the finger guard on the 80i-500s.
- Check the magnetic mating surfaces of the probe jaws; these should be free of dirt, dust, rust, or other foreign matter.
- Do not use a current probe that has been cracked or damaged or has defective leads. If there is any such sign of impaired operation, tape the probe shut to prevent operation.
- The 80i-500s has been designed and tested according to IEC 1010-1:1992 and other safety standards. Follow all warnings to ensure safe operation.

About This Manual

This manual contains instructions for the 39 and 41B Power Harmonics Testers (hereafter referred to as the Tester). All information applies to both models unless otherwise indicated.

Uses for the Tester

You can use the Tester to measure voltage and current inputs at power line and harmonic frequencies. Using these inputs, the Tester automatically calculates power and a wide range of other measurements useful in determining harmonic distortion levels and sources. The Tester can display power calculations in either a single-phase or a 3-phase readout.

These capabilities allow you to monitor power quality before and after an installation, troubleshoot a power distribution system, and (with Model 41B) print out or download data for additional analysis.

The Tester is both a harmonics measurement tool and a power meter or digital multimeter. You can use the Tester to measure voltage events (undervoltage, overvoltage, line outages, and neutral to ground levels), current levels, or to measure power levels. Fundamental frequency measurements (to 100 Hz) and harmonic frequency measurements (to about 2 kHz) are also possible.

The Tester cannot measure frequencies above about 2 kHz. (Use the ScopeMeter® test tool to measure fast power transients.)

Unpacking

The following items are included in your tester kit (see Figure 1):

- Model 39 Power Meter or Model 41B Power Harmonics Analyzer
- 80i-500s AC Current Probe
- TL-24 Test Leads
- TP-20 Test Probes
- AC-20 Test Clips

Your kit also includes the following printed materials:

- Users Manual (this book)
- Quick Reference Guide
- Warranty Registration Card

For Model 41B only, the following additional items are included. Refer to Figure 2.

- RS-232 Serial Cable
- FlukeView® 41 Windows Software Disk

Check the contents of the box for completeness, noting any damage. If something in the kit has been damaged or is missing, contact the supplier immediately.

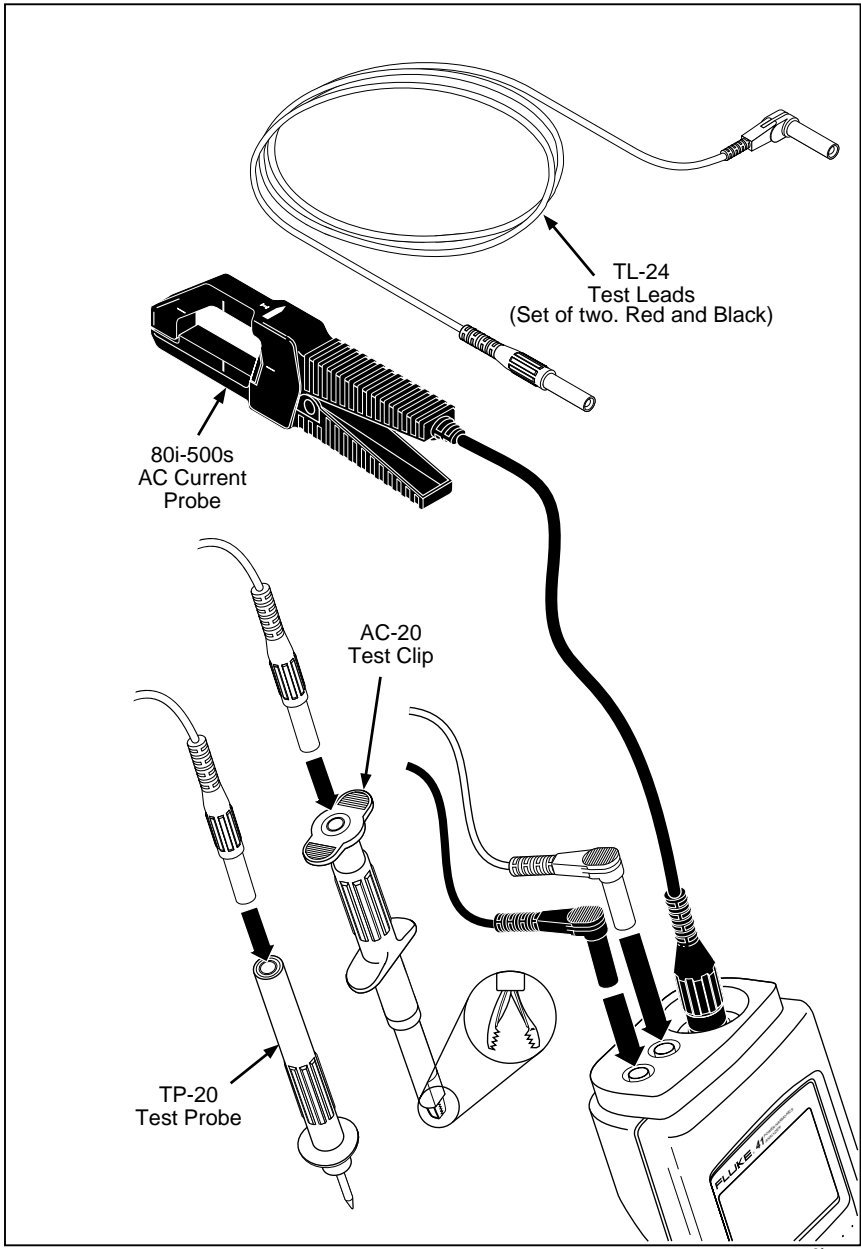

Figure 1. Tester and Accessories

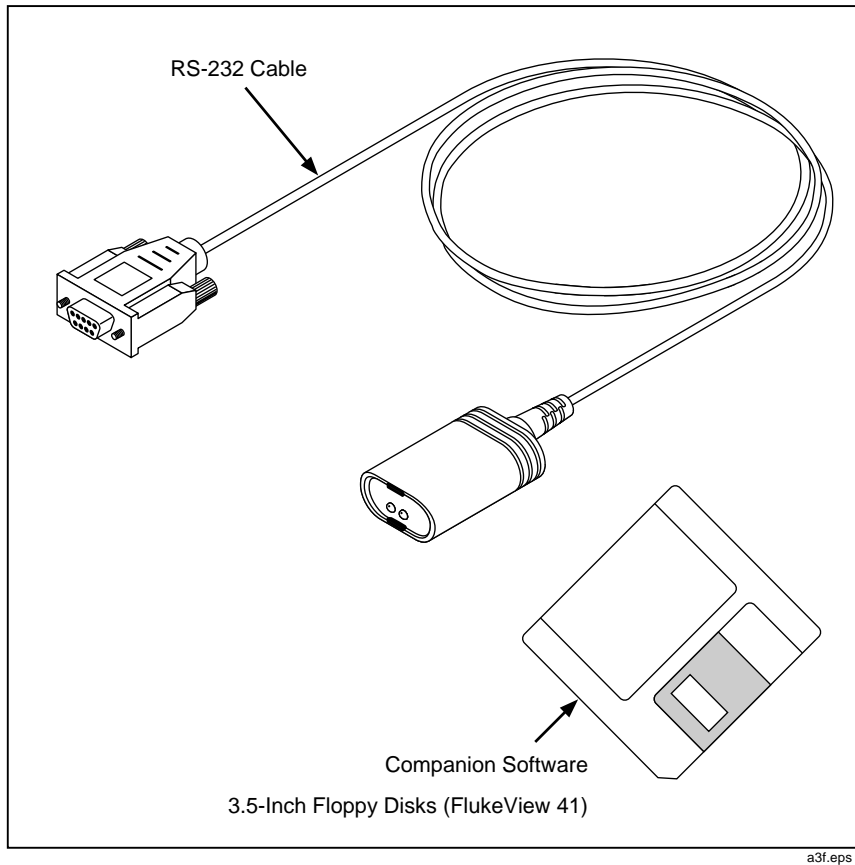

Figure 2. Additional Items (Model 41B)

Terminology Used in This Manual

This manual uses the following standard terminology:

- “Mains” is line voltage or frequency.
- “ $\phi 1$ ”, “ $\phi 2$ ”, and “ $\phi 3$ ” refer to the three current supply phases.
- “Delta” \triangle .
- “Wye” ∇ .
- “N” is Neutral.
- \perp is Earth ground.
- “AC Current Probe” or “Probe” refers to the 80i-500s, which can also be called a “current clamp”.

Battery Considerations

New alkaline C cells typically provide more than 48 hours of continuous operation. You can also use NiCad batteries. However, depending on battery condition, fully charged NiCad batteries provide 16 hours or less of continuous operation.

Plan to replace the batteries as soon as possible after the  symbol comes on. Refer to User Maintenance later in this manual for battery changing instructions.

Note

After the Tester is dropped, it may not turn on. Check the batteries to see if they are misaligned or damaged. Reseat the batteries if they are misaligned; replace the batteries if they are damaged.

Memory Retention

Whenever you remove power from the Tester (pressing  off, letting the batteries run down, removing the batteries, or experiencing an automatic power down), the Tester retains all essential operating information in nonvolatile memory. Specifically, the Tester retains calibration accuracy, power-up configuration information, and any stored waveforms (Model 41B). However, if you remove power when Record is active, the Tester loses all recorded values.

Automatic Power Down













If you do not press any keys for approximately 15 minutes, the Tester normally powers down automatically. If Record is active, the Tester continues to operate unattended as long as the battery condition allows.

The Tester returns to its power-up configuration whenever you turn it on.

If the Tester encounters a memory error at power-up, it automatically turns itself off. Check the batteries and try turning the Tester on again. If this problem persists, contact a Fluke Service Center.

Getting Acquainted with Your Tester

While referring to Figure 3, perform the following key presses to familiarize yourself with basic tester operations.

1.  to turn the Tester on.
2.  (brief press) and  or  to change screen contrast.
-  (hold 1 second) to turn the backlight on or off.
3.  to select a measurement function (Volts, Amps, Watts).
4.  to select a screen mode (Waveform, Harmonics, Text).
5.  to start recording measurements
 or  to select NOW, MAX, AVG, MIN recording.
 to select a different measurement function while recording.
-  to exit recording.
6.  to turn the Tester off.

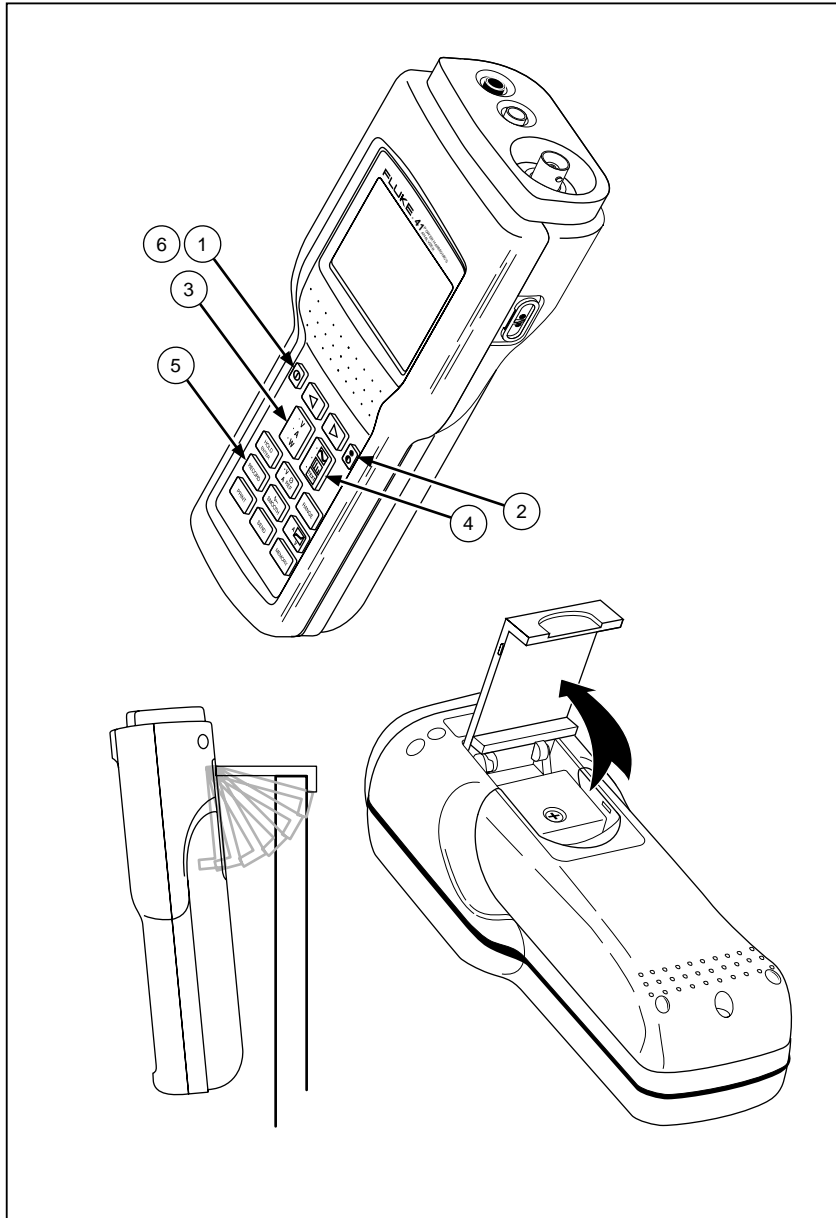

a4f.eps

Figure 3. Getting Acquainted

Input Connections

Refer to Figure 4 for a view of the two-input measurement scheme. To measure voltage, insert the red test lead in “V” and the black test lead in “COM.” Current measurement uses a BNC connector attached to “CURRENT PROBE.” Connect “V” and “COM” to measure only voltage; connect “CURRENT PROBE” to measure only current. Make all three connections for power measurements.

Observe the following connection guidelines:

- **Current**
Clamp the Current Probe around the desired phase or neutral conductor. Make sure the arrow on the probe points toward the load (phase) or the source (neutral). The Tester is set up for use with an 80i-500s Current Probe. If you use another probe, you must make a selection change in the Configuration Screen.
- **Voltage: 3-phase, 4-Wire**
Connect the red test lead to the desired phase voltage; connect the black test lead to neutral.
- **Voltage: 3-phase, 3-Wire, example \triangle**
Connect the red test lead to the phase conductor used by the Current Probe; connect the black test lead to another phase.

Using the Voltage Test Leads

The TL-24 Test Lead and AC-20 Test Clip combination (Figure 1), which allows for hands-free voltage measurements, is preferred when you are also using the Current Probe.

Note

Figure 4 shows suggested test lead and current probe usage.

Using the Current Probe

The accuracy of current and power readings depends on properly using the 80i-500s Current Probe. The accuracy specifications in this manual assume that the Current Probe is used correctly.

- Always clamp the 80i-500s Current Probe with the arrow pointing toward the load (away from the source) for a phase measurement or toward the source for a neutral measurement. Press  to verify the Current Probe orientation. If the resulting VA Check Screen generally extends from the lower left to the upper right of the screen, the Current Probe is connected properly.
- Always clamp the Current Probe around a single conductor or parallel conductors that are carrying current for the same phase.
- Always center the conductor in the Current Probe alignment marks.

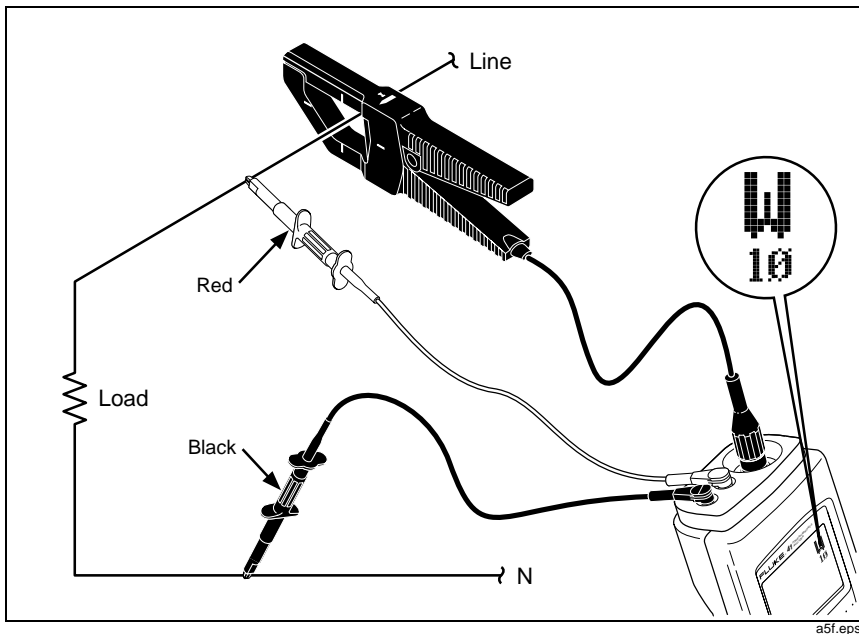

Figure 4. Measurement Connections (1.0)

Three-Phase Power Measurements

Refer to Figures 5, 6, and 7 for various ways to measure total power in a three-phase system. The $W_{3\phi 3C}$ display screen shows the three-phase calculation for the connection shown in Figure 5. All other screens and functions show only single-phase data.

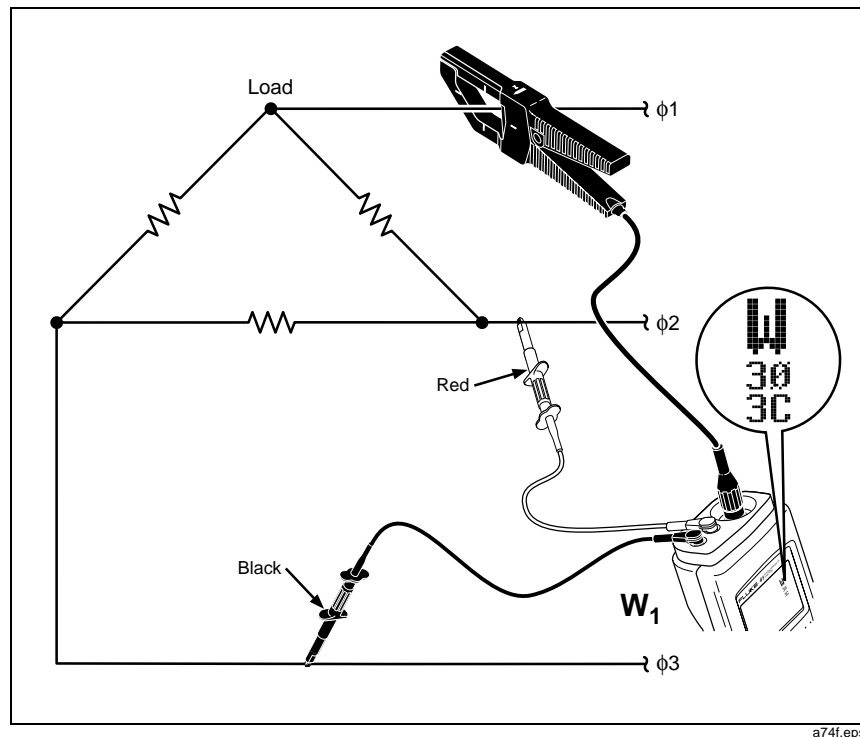

Figure 5. Three-Phase Measurement Connections (For Balanced Circuits, 3ϕ , 3-Conductor, Δ)

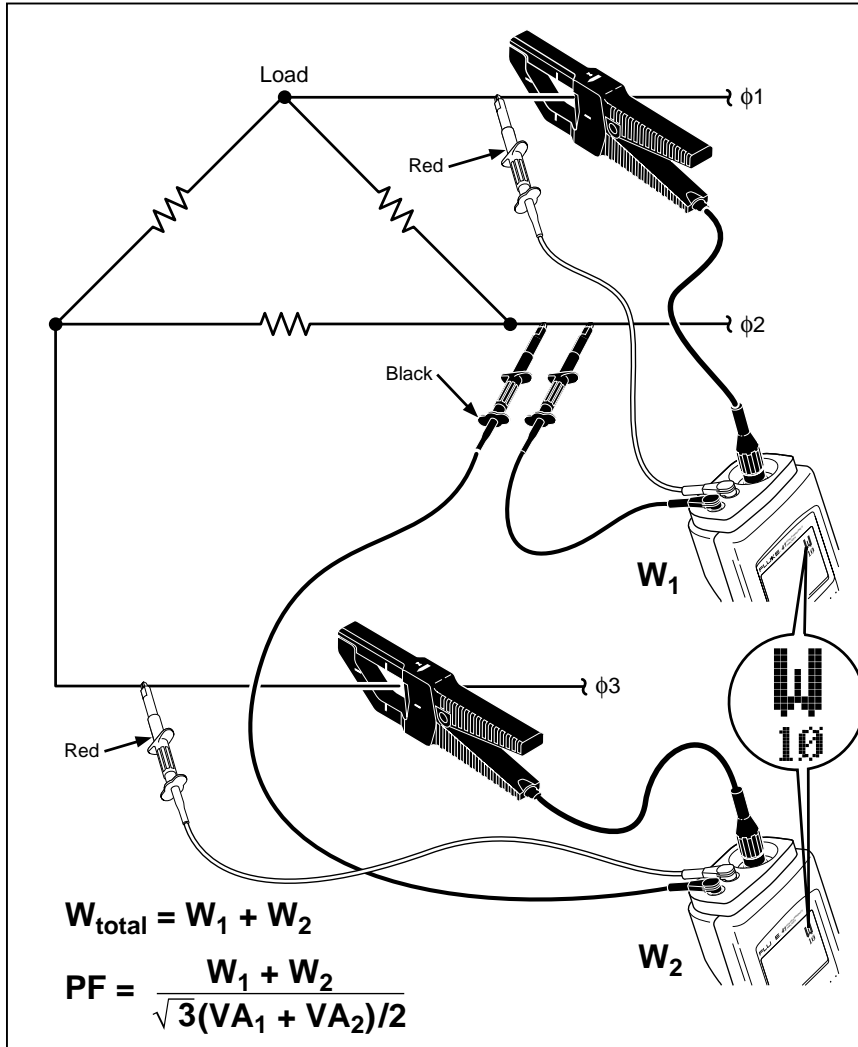
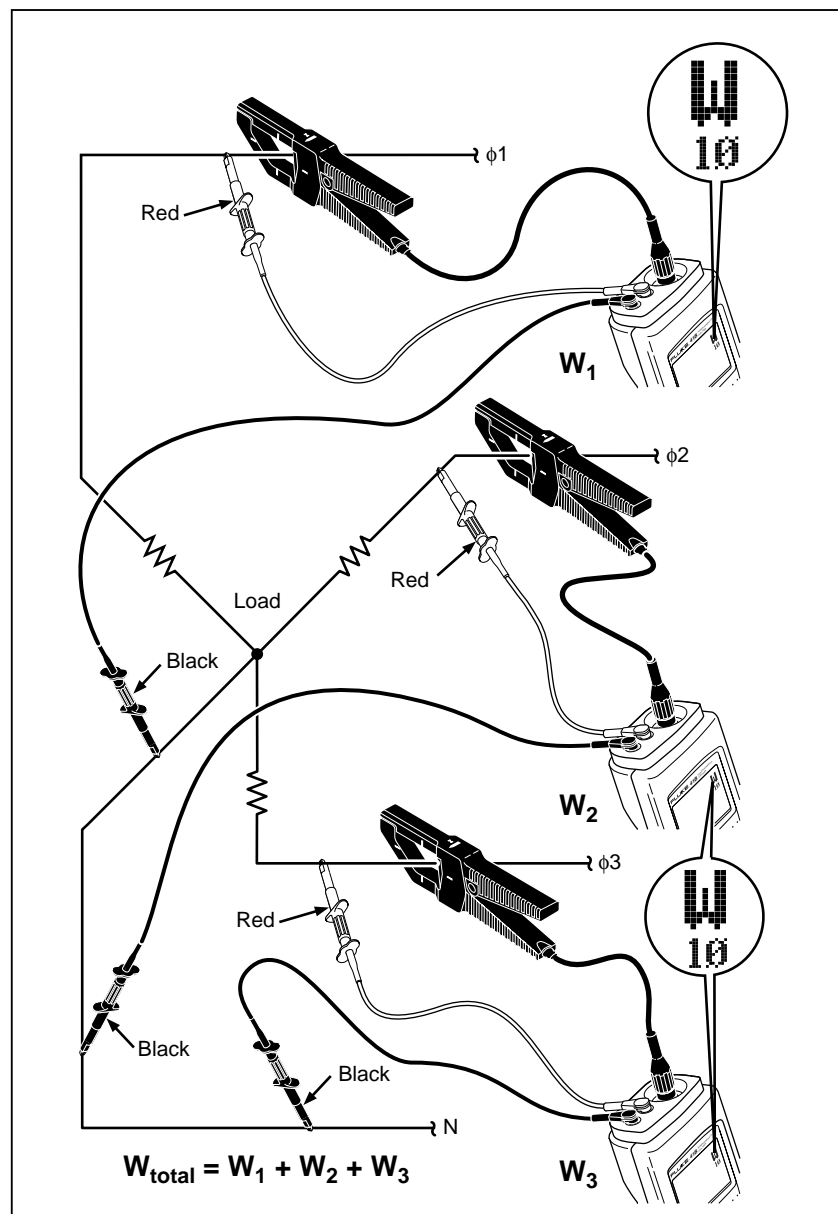

Figure 6. Three-Phase Measurement, Balanced or Unbalanced Connections (3 ϕ , 3-Conductor, Δ or ∇)



a7f.eps

Figure 7. Three-Phase Measurement, Balanced or Unbalanced Connections (3 ϕ , 4-Conductor)

Keypad

Refer to Figure 8 and Table 1 for keypad operation.

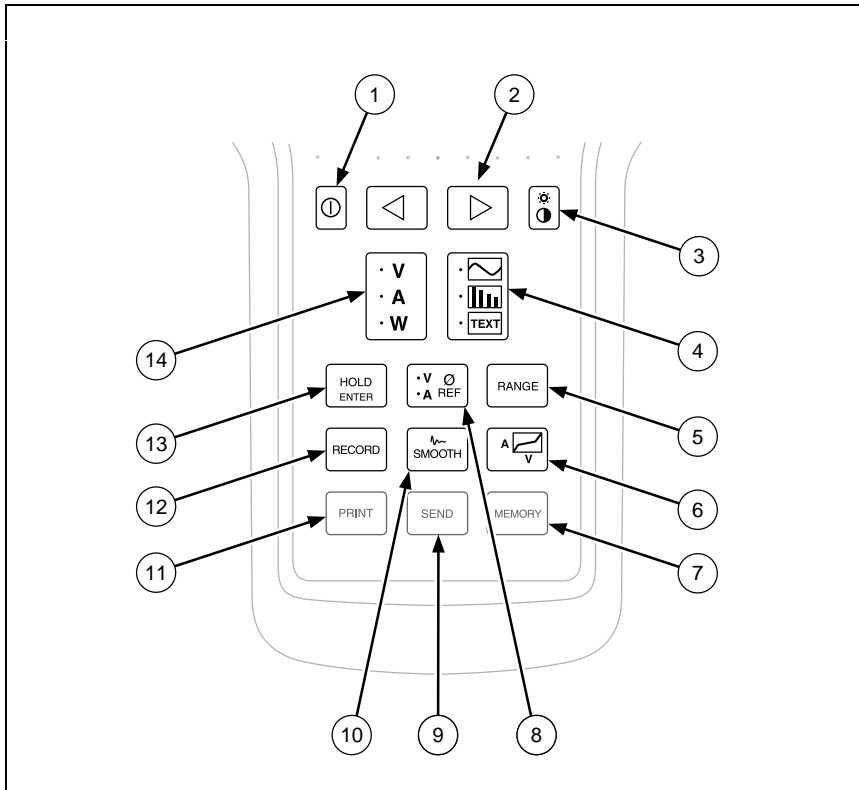

a8f.eps

Figure 8. Keypad

Table 1. Key Descriptions











Number	Symbol	Name & Description
1		<p>Power</p> <p>Press once to turn the Tester on; a test pattern is displayed briefly. (Test pattern remains displayed while key is held pressed.) Press again to turn the Tester off. The Tester sets up to the power-up configuration each time you turn it on.</p>
2	 	<p>Arrow Keys</p> <p>These keys have multiple uses. Refer to other areas for specific  and  descriptions.</p>
3		<p>Contrast/Backlight</p> <p>Tap briefly to adjust contrast (with  ); tap again to store setting and return to normal operation. Press and hold  for about 1 second to turn the backlight on or off.</p>
4		<p>Screen Mode</p> <p>Press to cycle the Tester through Waveform, Harmonics, and Text Screen Modes. You select the Measurement Function (Volts, Amps, or Watts) independently of the Screen Mode.</p>

Table 1. Key Descriptions (cont)









Number	Symbol	Name & Description
5		<p>Range (Waveform and Text)</p> <p>Press  momentarily to start manual ranging (MAN) for all Measurement Functions (V, A, W). Continue momentary presses to cycle through the ranges for the selected Measurement Function only. (Ranges do not change for the other two Measurement Functions.) Press and hold about 1 second to return to autoranging (AUTO) for all Measurement Functions (V, A, W). The Tester always begins autoranging at power-up.</p> <p>Range (Harmonics)</p> <p>Press  momentarily to cycle from 100% to 10%, 20%, 50%, and back to 100%. Other harmonics screen ranges and voltage or current measurement ranges do not change while in harmonics display.</p>
6		<p>VA Check</p> <p>Press at any time for a check of the volts versus amps signature at the test point. Press  a second time to return to normal operation. See also "VA Check" section.</p>
7		<p>Memory (Model 41B)</p> <p>Press to access the Waveform Storage Screen. Press  a second time to return to normal operation. Also, you can clear all stored waveforms by holding  pressed as you press  on. See also "Storing and Recalling Measurements."</p>

Table 1. Key Descriptions (cont)



























Number	Symbol	Name & Description
8		<p>Phase Reference</p> <p>Press to select volts or amps as the display phase reference. Voltage reference is the standard configuration. For current only measurements, press  to set . To change the power-up phase reference, see "Power-Up Configuration" later in this manual.</p>
9		<p>Send (Model 41B)</p> <p>Press to print a test report of calculated measurements to a printer or PC. (The Tester displays SEND.) Do not press  when FlukeView 41 application software is in use. See "Sending to a PC".</p>
10		<p>Smooth</p> <p>Smooth allows you to average waveforms, resulting in a more stable screen and increased accuracy of computations. (See "Specifications.") Press  four times to step through the Smooth selections (, , ,  in the top status line). Pressing  a fifth time returns the Tester to normal operation.</p>

Table 1. Key Descriptions (cont)

Number	Symbol	Name & Description
11		<p>Print (Model 41B)</p> <p>Press to print a screen dump to a printer. (The Tester displays ) To stop printing, press any key. Do not press  when FlukeView 41 application software is in use. See “Sending to a PC”.</p>
12		<p>Record</p> <p>Press to start Record. Press  a second time to resume normal operation. You can also return the Tester to its standard (factory-programmed) configuration by holding  as you press on .</p>
13		<p>Hold</p> <p>Press  to freeze the screen. ( appears in the top line.) You can now observe all screens for a single measurement. Press  again to resume normal operation.</p> <p> serves as the “ENTER” key when used with some other screens. Also, you can access the Power-Up Configuration Screen by pressing  as you press  on.</p>
14		<p>Measurement Function</p> <p>Press to cycle the Tester through Volts, Amps, and Watts Measurement Functions. You select the Screen Mode (Waveform, Harmonic, or Text) independently of the Measurement Function.</p>

Display Screen

The screen consists of the following three areas (see Figure 9):

- Status Line: identifies Tester operating conditions. See Table 2.
- Measurement Area: shows information as waveform, harmonics bar chart, or set of text computations. Refer to Table 3 for abbreviations used in all Measurement Functions and Screen Modes.
- Special Messages. See Table 4.

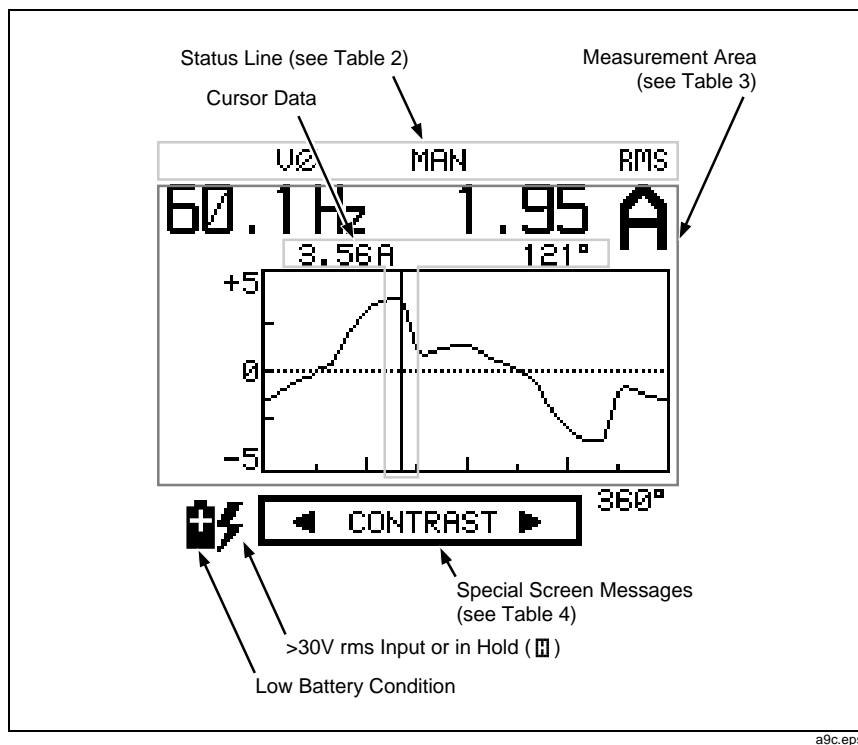

Figure 9. Display Screen

Table 2. Status Line

	Hold active (screen frozen). ⚡ appears in lower left screen to indicate possible high voltage input that is not sensed during Hold.
V∅ A∅	Phase Reference Selection. The volts input or the current input is the reference for determining phase shift. Select A∅ when measuring current only with voltage test leads not connected.
√-2s √-5s √-10s √-20s	Smooth Selection. Smooth is active with averaging times of 2, 5, 10, or 20 seconds. A higher number signifies a more stable measurement reading.
OL-V	Volts Overload Condition for the selected range (over 600V if in AUTO).
OL-A	Amps Overload Condition for the selected range (exceeds 2V peak if in AUTO). Since the input from the Current Probe is 1 mV/A, maximum current input is 2000A pk.
OL-VA	Both volts and amps maximum inputs have been exceeded.
<i>Note</i>	
<i>When an overload occurs, all measurement and computation data must be presumed invalid.</i>	
AUTO	The Tester switches range automatically to deal with changing volts, amps, or watts readings.
MAN	Tester does not switch ranges automatically.
MEMX	Memory location (X) last accessed. (X = 1 to 8)
SEND	Send is active (prints test reports, Model 41B.)
PRNT	Print is active (prints screen dumps, Model 41B.)

Table 3. Screen Abbreviations



Screen Usage	Name and Description
° 	<p>Phase Angle degrees. ($\pm 180^\circ$)</p> <p>Measures time from the positive zero crossing of the fundamental of the selected volts or amp \varnothing REF. 360° represents one cycle at the fundamental or selected harmonic frequency. A positive sign indicates that the positive zero crossing of the measured cycle comes earlier than (leads) that of the reference.</p>
<p style="text-align: center;"><i>Note</i></p> <p><i>For the Watts  screen, the phase angle always shows the relation of Amps to the Volts \varnothing REF at the same frequency. $\cos\phi$ calculations are based on this definition.</i></p>	
A RMS	Amps RMS (includes dc component if using dc capable current probe).
A PK	Peak Amps (1/2 peak-to-peak value).
A DC	Amps DC.
A HM	For a current waveform, A HM identifies the total harmonic current present.
A LEAD	<p>Amps Lead Volts</p> <p>Evidence of capacitive reactance in the system; the current waveform precedes the voltage waveform.</p>
A LAG	<p>Amps Lag Volts</p> <p>Evidence of inductive reactance in the system; the current waveform occurs after the voltage waveform.</p>
CF	<p>Crest Factor</p> <p>Ratio of a waveform's peak value to its rms value.</p>

Table 3. Screen Abbreviations (cont)

Screen Usage	Name and Description
DPF	<p>Displacement Power Factor $\cos\phi$ fundamental</p> <p>The ratio of the active power (W) to the apparent power (VA rms) at the fundamental frequency. Equivalent to $\cos\phi$ at that frequency. Traditional power factor for linear loads.</p>
HZ	<p>Waveform Screens: Fundamental frequency in hertz</p> <p>Harmonics Screens: Frequency of selected harmonic in hertz</p>
KF	<p>K-Factor</p> <p>A load current waveform rating calculation that rates the waveform's capability to produce harmonic-related heat loss in transformers and other magnetic components. Used to select transformer K-ratings that match load current K-factor measurements.</p>
PF	<p>Power Factor</p> <p>Ratio of active power to apparent power (including all harmonics). True power factor for all loads, linear and non-linear.</p>
% THD-F	<p>Total Harmonic Distortion (as % of Fundamental)</p> <p>Defines amount of harmonic distortion as a percentage of the waveform at the fundamental frequency.</p> $\% \text{ THD - F} = \frac{\text{rms of harmonics (less fundamental)}}{\text{rms of fundamental}}$
% THD-R	<p>Total Harmonic Distortion (as % of rms total)</p> <p>Defines amount of harmonic distortion as a percentage of the rms value of waveforms at all frequencies (fundamental and harmonics).</p> $\% \text{ THD - R} = \frac{\text{rms of harmonics (less fundamental)}}{\text{total rms}}$

Table 3. Screen Abbreviations (cont)

Screen Usage	Name and Description
V RMS	Volts rms (includes dc component).
COS ϕ	Cosine of the angle between the voltage and the current at any single frequency.
V PK	Peak Volts (1/2 peak-to-peak value).
V DC	Volts DC.
V HM	Harmonic Volts RMS For a voltage waveform, V HM identifies the total harmonic voltage present.
VA, KVA	(Kilo) Volt Amps Apparent power: a value that the Tester calculates by multiplying the rms value for current by the rms value for voltage.
VAR, KVAR	(Kilo) Volt Amps Reactive The reactive power component of the fundamental frequency.
W, KW	Active Power The average power dissipated (also called real power).

Table 4. Special Messages

<p style="text-align: center;"><CONTRAST></p> <p>Press <input type="button" value="◀"/> or <input type="button" value="▶"/> to adjust contrast. Press <input type="button" value="⏏"/> to exit contrast control and store current setting.</p> <p style="text-align: center;">* CALIBRATION ERROR * CONTACT FLUKE SERVICE</p> <p>The Tester has detected a calibration error at power-up. Since erroneous readings result, the Tester displays this message until calibration is verified. Return the Tester to a Service Center for repair or calibration. See "User Maintenance" later in this manual.</p> <p style="text-align: center;">STOP AVG AT 48 HOURS</p> <p>In Record, averaging stops after 48 hours. Note the average value shown; then, press <input type="button" value="RECORD"/> once to return to normal operation or twice to begin recording with new values.</p> <p style="text-align: center;">* PRINTING * PRESS ANY KEY TO STOP</p> <p>On Model 41B, this message appears when you press <input type="button" value="PRINT"/> or <input type="button" value="SEND"/>. Press any key to resume normal operation.</p>
--

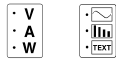

Functions and Screen Modes

The Tester uses a set of multipurpose screens to present each type of measurement (volts, amps, watts) as a waveform, a relational bar chart of harmonics, or a series of digital (text) readouts. With multiple values and computations on each screen, you only need to press a few keys to see everything there is to know about power (or just voltage or current) at the test point. Cycle through the choices by pressing either (or both) of these keys.

The Tester preserves selections that are active in one screen as you switch to another screen. For example, if you are measuring harmonic 7 in the Volts Harmonic Screen and change function, the Tester continues measuring harmonic 7 in the amps and watts harmonic screens.

Waveform Screen Mode

Volts, amps, and watts waveform screens (Figure 10) use a common format to present information about the measurement inputs. This format shows digital information on top and a waveform on the bottom. The waveform vertical scale limits usually change automatically (AUTO on) to accommodate the magnitude of the input. The horizontal scale represents 0 through 360 degrees (one cycle) of the fundamental frequency.

With a waveform screen displayed, press or to activate the vertical cursor bar. Continue to press these keys to position the cursor along the horizontal degree scale. A second line of digital information defines the magnitude and phase for the point where the cursor bar intersects the waveform.

Note



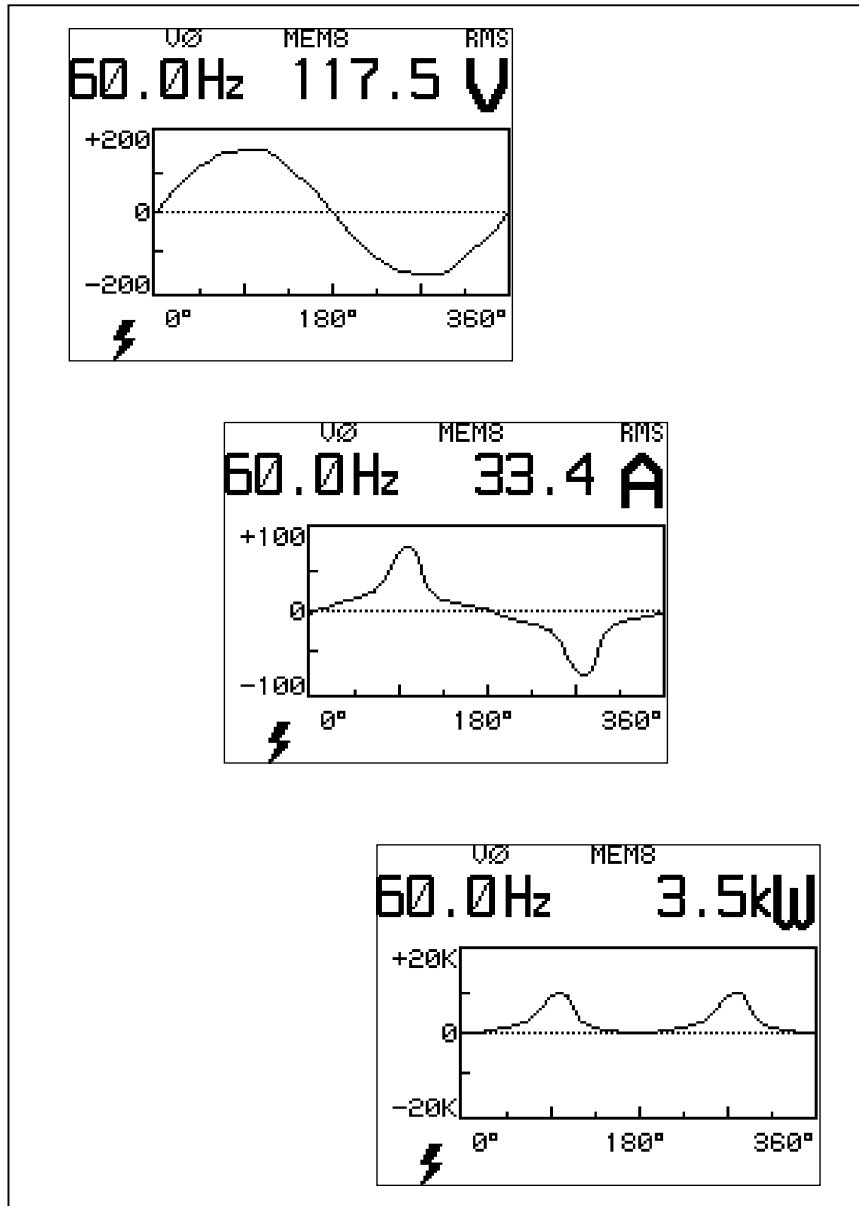

In the waveform screens, the frequency displayed is the frequency of the fundamental. This is normally true even when the signal being measured contains an individual harmonic with an amplitude greater than the fundamental (such as the third harmonic in the neutral current of a 3-wire, 4-wire system supplying non-linear loads). To obtain the frequency of a harmonic, select the harmonic screen and use and to position the cursor arrow under the harmonic of interest.



a10c.eps

Figure 10. Waveform Screens

Harmonics Screen Mode

The Harmonics Screen Mode (Figure 11) uses a set of screens to display magnitude bars for all harmonics and digital information about the selected harmonic. Select a harmonic by pressing  and  to move the cursor along the bottom scale. DC, 1 (the fundamental frequency), and harmonics 2 through 15 appear on the first screen. Harmonics 16 through 31 appear on the second screen. Switch between harmonics screens by pressing  when 15 is selected on the first screen or  when 16 is selected on the second screen.

At the top of the screen, the percentage shown compares the selected cursor magnitude to either the fundamental (%F) or the total rms value (%R) (fundamental and all harmonics). The Tester also shows the magnitude of the cursor selection. The frequency of the selected harmonic is shown in Hertz below the percentage.

Note

The watts harmonic screen always uses the %F (fundamental) definition.

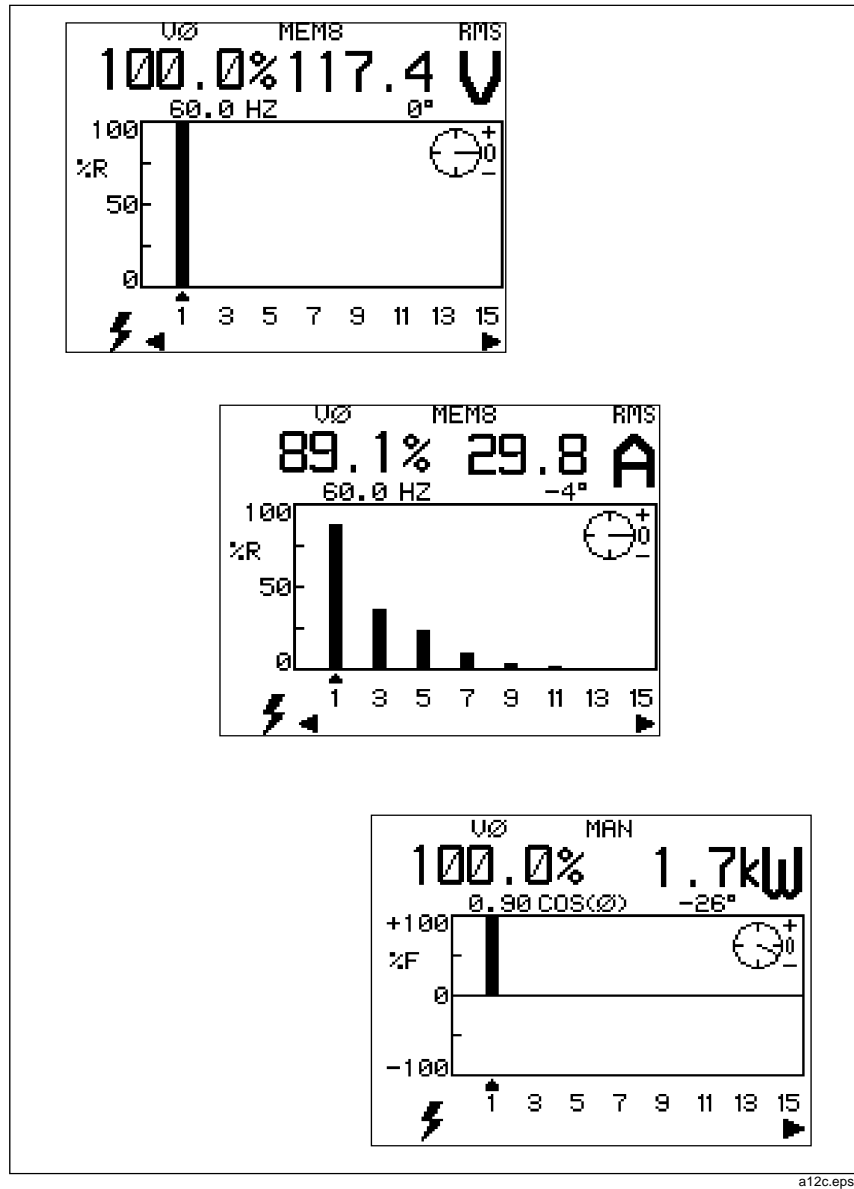
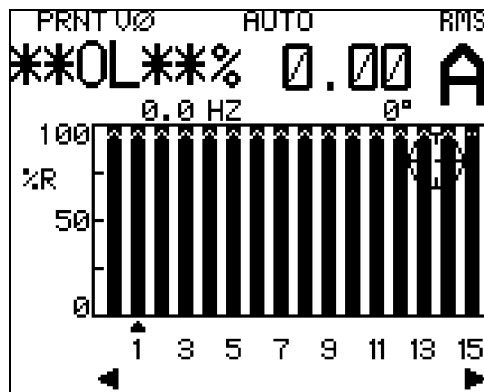

Figure 11. Harmonics Screens

The harmonics overload screen (Figure 12) appears if either of the following conditions exists:

- There is no input on the phase reference channel. For example, there is no voltage input when $V \emptyset$ is selected.
- There is no input on one of the measurement channels (volts or amps).



a11s.eps

Figure 12. Harmonics Overload Screen

Harmonics Zoom Mode

Use **RANGE** to scale a selected harmonic bar graph display (Figure 13) to more easily read the harmonic information. This mode automatically scales the bar graph display to 100%, 50%, 20%, or 10% based on the largest harmonic value; the magnitude of the fundamental is ignored. Using **RANGE** in harmonic screens affects the display only and does not affect measurement range control. To change measurement ranges, the display must be in waveform or text screens.

An arrow at the top of the bar indicates that the harmonic has exceeded its scale. The percent of harmonic and digital values are correct even when the harmonic bar exceeds its scale.

The cursor selection displays the percent of the harmonic and its value in digital form.

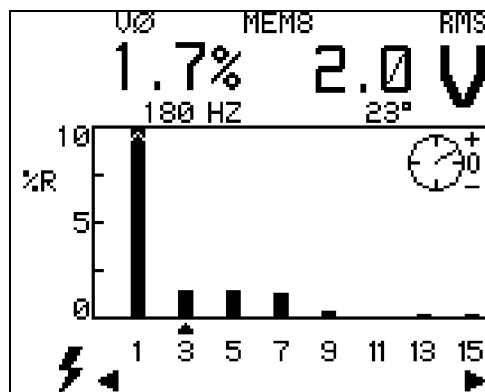

a84s.eps

Figure 13. Harmonics Zoom Screen

Text Screen Mode

Text screens (Figure 14) present digital information for values measured or computed by the Tester. Arrows appear on the primary text screen signifying that you can press  to access a secondary text screen. In watts, the primary screen shows the single-phase (1 ϕ) power reading. The secondary (3 ϕ , 3C) screen shows the estimates of the total three-phase performance from one single-phase reading.

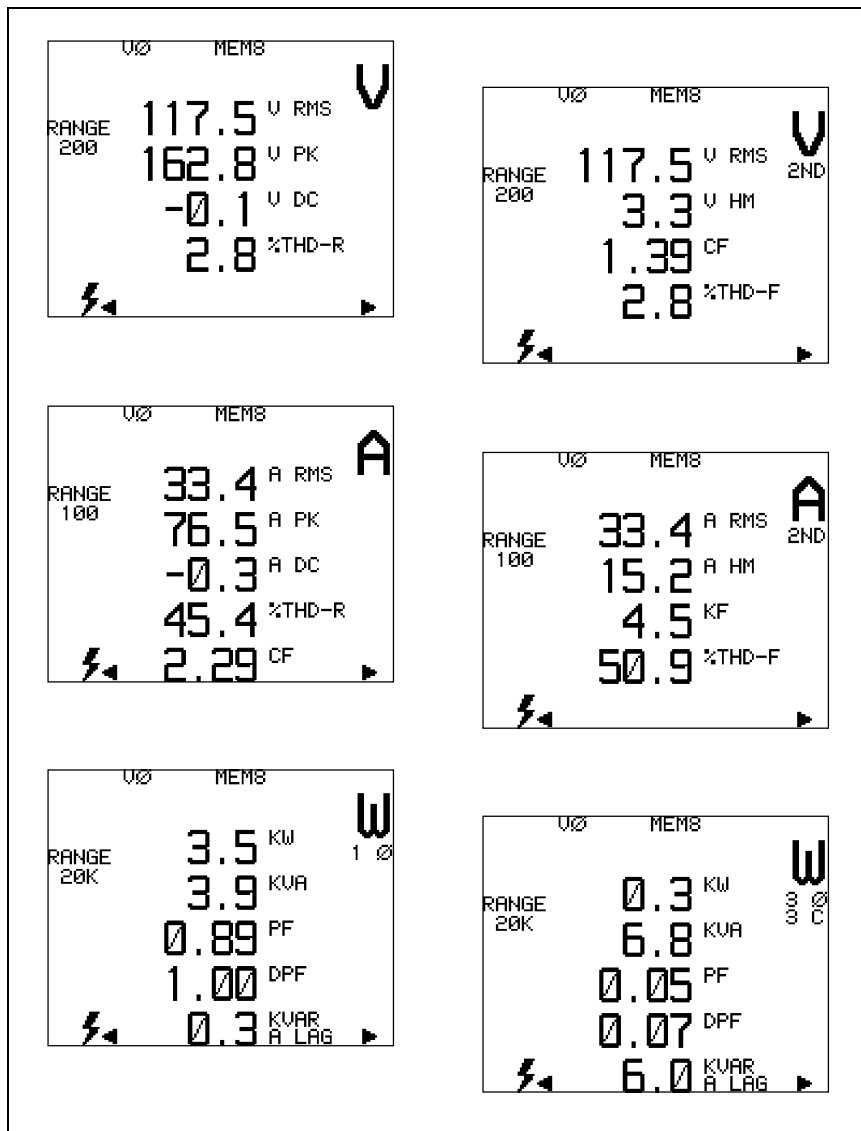



a13c.eps

Figure 14. Text Screens





VA Check Screen

Press  at any time to access the VA Check screen, which displays volts graphed against amps. Press  a second time to exit the VA Check screen and return to your starting point.

With the VA Check screen, the Tester displays one cycle of the fundamental frequency (current on the vertical scale, voltage on the horizontal scale). The resulting graph can appear as a straight line, a stepped line, an ellipsoid, or as some other pattern that you would normally expect to see on an oscilloscope with two input channels.

Use the VA Check screen to show the phase shift of the fundamental frequency and detect the existence and severity of nonlinearity caused by harmonics. It could be that the VA Check screen may simply show that you have clamped the Current Probe in the wrong direction. Figure 15 shows some typical VA Check signatures.

When the Tester is set for autoranging (AUTO), ranges for the vertical and horizontal scales on the VA Check screen are adjusted automatically to provide a meaningful display. If the Tester is set for manual ranging (MAN), both scales (ranges) are fixed; you may have to choose AUTO (press  for 1 second) or select an appropriate manual range in either V or A, or both functions (i.e., press  briefly for each range change).

Note

V or A ranges cannot be changed while in the VA Check screen.

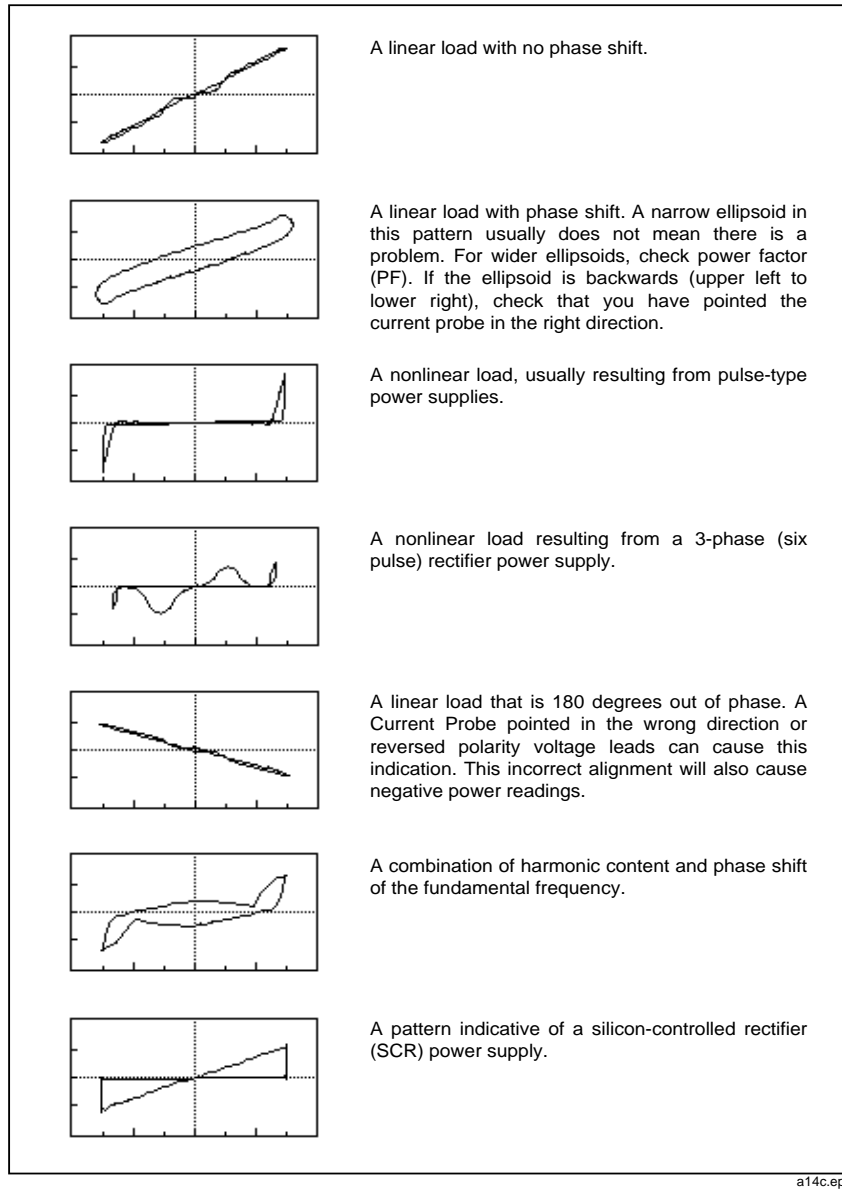

Figure 15. Typical VA Check Signatures

RECORD

Recording Measurements

Press **RECORD** to begin recording readings for all measurement functions. Then press **<** or **>** to cycle through the screens for the function presently selected. You can also switch between measurement functions while in Record mode. (See Figure 16 for an overview of possible record screens.) For any function, the Tester displays screens in the following order:

- **NOW** The present readings. This screen always appears first when you start Record.
- **MAX** The maximum values measured since you started Record.
- **AVG** The averages of values measured since you started Record. (Average values stop updating after 48 hours of continuous record operation.)
- **MIN** The minimum values measured since you started Record.

When in Record, only the following keys are active:



Press **RECORD** a second time to exit Record. This action discards all recorded values and returns to the previous measurement screen. The Tester begins storing a new set of values each time you start Record.

The Tester loses recorded values if the batteries discharge too much. If **⚡** comes on during Record, write down any values of interest. (You have ample time to do this with alkaline batteries. NiCad batteries discharge much more rapidly once **⚡** comes on.) Changing the battery erases the Record memory.

You can access 12 different record screens: **NOW**, **MAX**, **AVG**, and **MIN** for volts, amps, and watts measurement functions. Figure 16 presents an overview of the record measurements and computations available by function.

Note

The Record mode acquires only single-phase data approximately every 500 ms (0.5s). It is not intended to capture transients, nor is it able to capture single events on the power line.

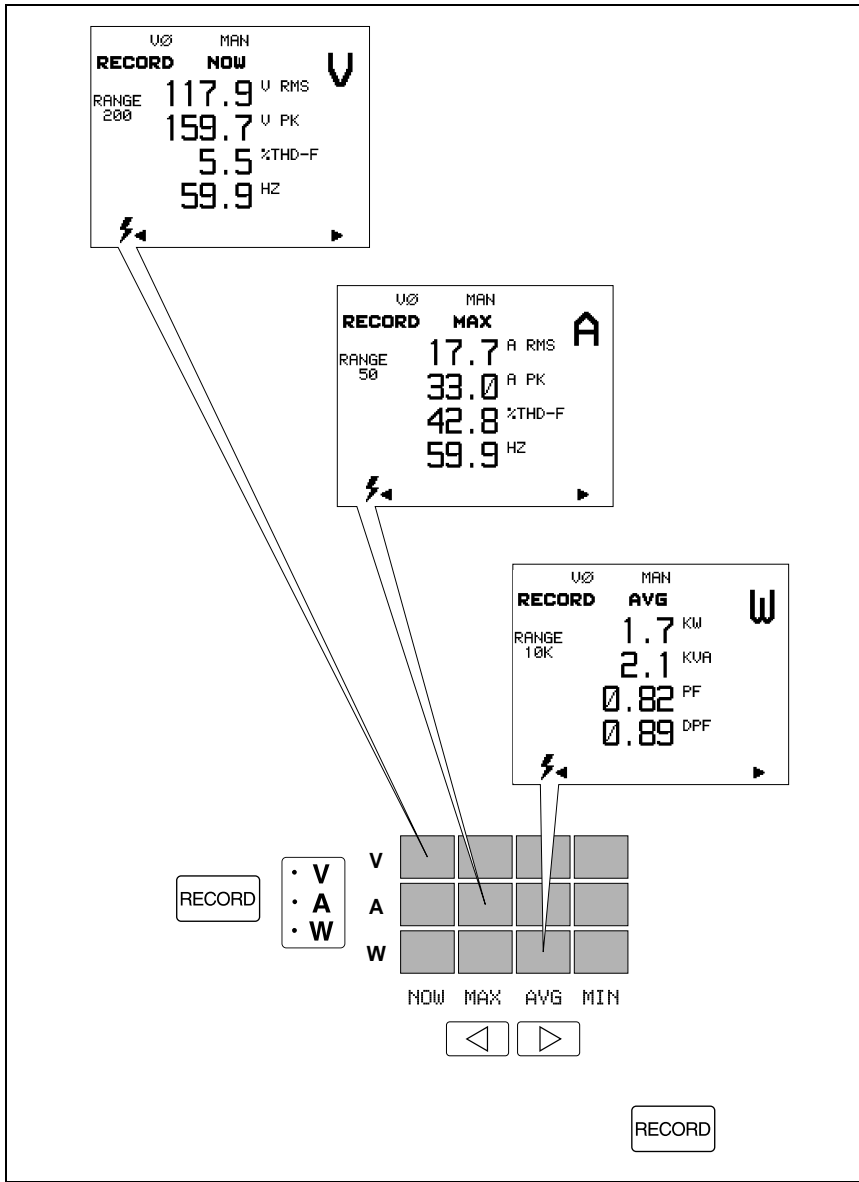

a15c.eps

Figure 16. Record Screens



Power-Up Configuration

The Tester has two types of configurations: standard and power-up. The standard configuration, which is programmed into the Tester and can always be retrieved, includes the following settings:

- FCN V Volts Function selected.
- DISP WAVE Waveform Screen Mode selected.
- THD %RMS Total Harmonic Distortion computed as percentage of the total RMS value.
- CLAMP 80I-500S The 80i-500s Current Probe is selected. OTHER specifies any current probe other than the 80i-500s. The Tester has been calibrated to provide either compensation for the 80i-500s or a flat response for other probes.
- \emptyset REF V Voltage Phase Reference selected.

For Model 41B, KEAUD 9.6 is the standard configuration for Print or Send, and EPSON is the standard configuration. The Tester always selects autoranging at power-up.

The power-up configuration, which is initially the same as the standard configuration, can be changed by making entries from the configuration screen. The Tester sets up to the power-up configuration each time it is turned on. You can change the power-up configuration using the following procedure:

1. Press while pressing to turn the Tester on. The configuration screen appears. (See Figure 17.)
2. Press and to highlight different items on the same line. Press to select the currently highlighted item and proceed to the next line.

3. To exit the screen, press to select a highlighted item on the last line and store all selections you have made during this configuration session. The Tester begins normal operation using these selections. The Tester also automatically sets up to these selections at the next power-up.

To exit the screen without making changes, press to cycle through all selection lines.

4. To restore the standard configuration, press as you press on. (On Model 41B, this action also clears waveform memory.)

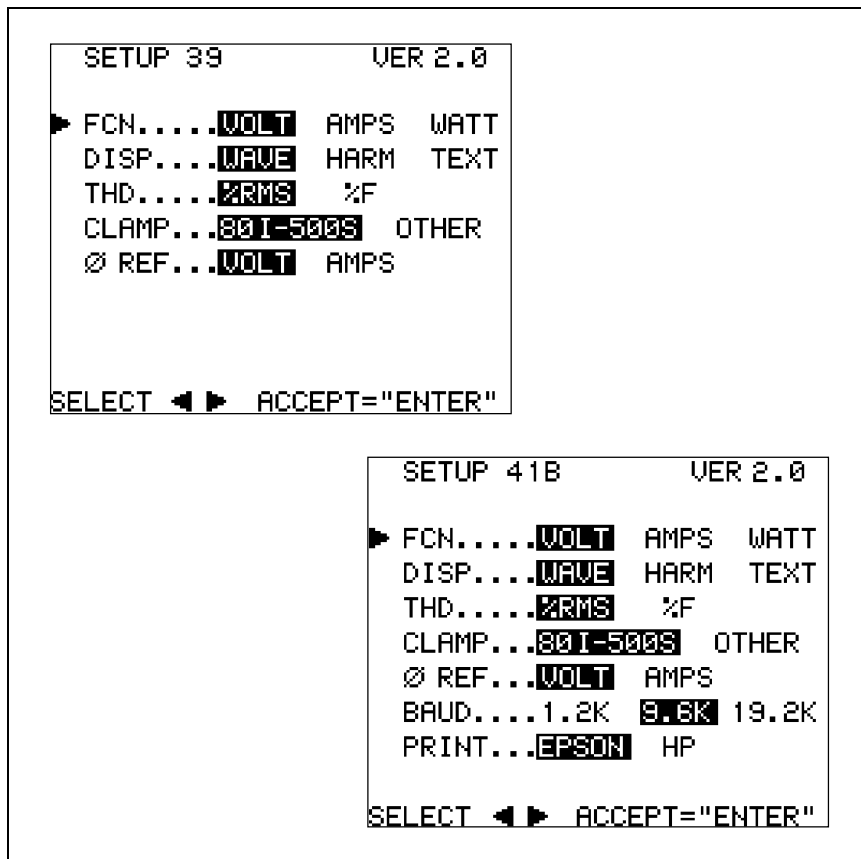

Figure 17. Configuration Screens

MEMORY

Storing & Recalling Measurements (Model 41B)

Model 41B allows you to store a maximum of eight waveforms (and associated data) for volts and amps. You can recall data that you have collected on site for later viewing and analysis. (If you store multiple waveforms in this manner, you will probably want to keep a written record identifying the waveforms by number.)

The Tester stores a measurement as digital data. You can recreate all related waveform, harmonic, and text screen information, except Record, when you recall the waveform.

The Tester stores waveforms in nonvolatile memory. A low battery condition or a battery change does not jeopardize the stored waveforms.

Referring to Figure 18, use the following procedure to store and recall measurements:

1. Press **MEMORY** to access the waveform storage screen. The Tester freezes the existing waveform and shows the screen in Figure 18.
2. Press **◀** or **▶** to select the desired operation (RECALL, STORE, or CLEAR). Then press **HOLD ENTER**.
3. Select one of the eight memory locations by pressing **◀** or **▶** to box one through eight. An underscore appears below a filled memory location.

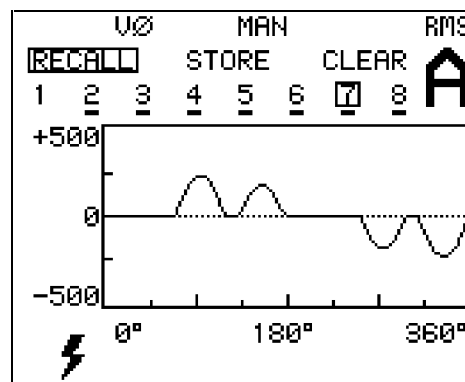





Figure 18. Memory Screen

a17s.eps

4. **STORE** a waveform set (and associated data) into the boxed memory location by pressing . If the location was empty, an underscore now appears below the memory location number. If the underscore already existed, **STORE** overwrites the old waveform.



CLEAR the selected memory location (waveform and associated data) from the boxed memory location by pressing .

RECALL the selected memory location to view the contents directly by pressing .

In all three cases, the Tester holds the data represented by the waveform last seen on the memory screen and returns to the previous display mode. While Hold is maintained, you can access various representations and computations about the waveform by selecting different measurement function and screen mode combinations. You can also send the associated data to a PC or a printer.

5. Release the memory display and return to the active display mode by pressing .

Notes

You can clear all memory locations by holding  pressed while you press  on.

MAX, AVE, and MIN information in the RECORD mode cannot be stored in a memory location.

Using the Serial Cable (Model 41B)

Model 41B communicates with a PC or printer (Figure 19) through an isolated RS-232 port. The Tester outputs data through the RS-232 port when you press or or when you send a command from the PC.

Note

The side of the optical interface connector marked “Optical Interface RS-232-C” faces up when properly attached to the Model 41B.

Using the Configuration Screen, you can set 1.2, 9.6, or 19.2 KBAUD. Other parameters are fixed as follows: 1 start bit, 8 data bits, 1 stop bit, and no parity.

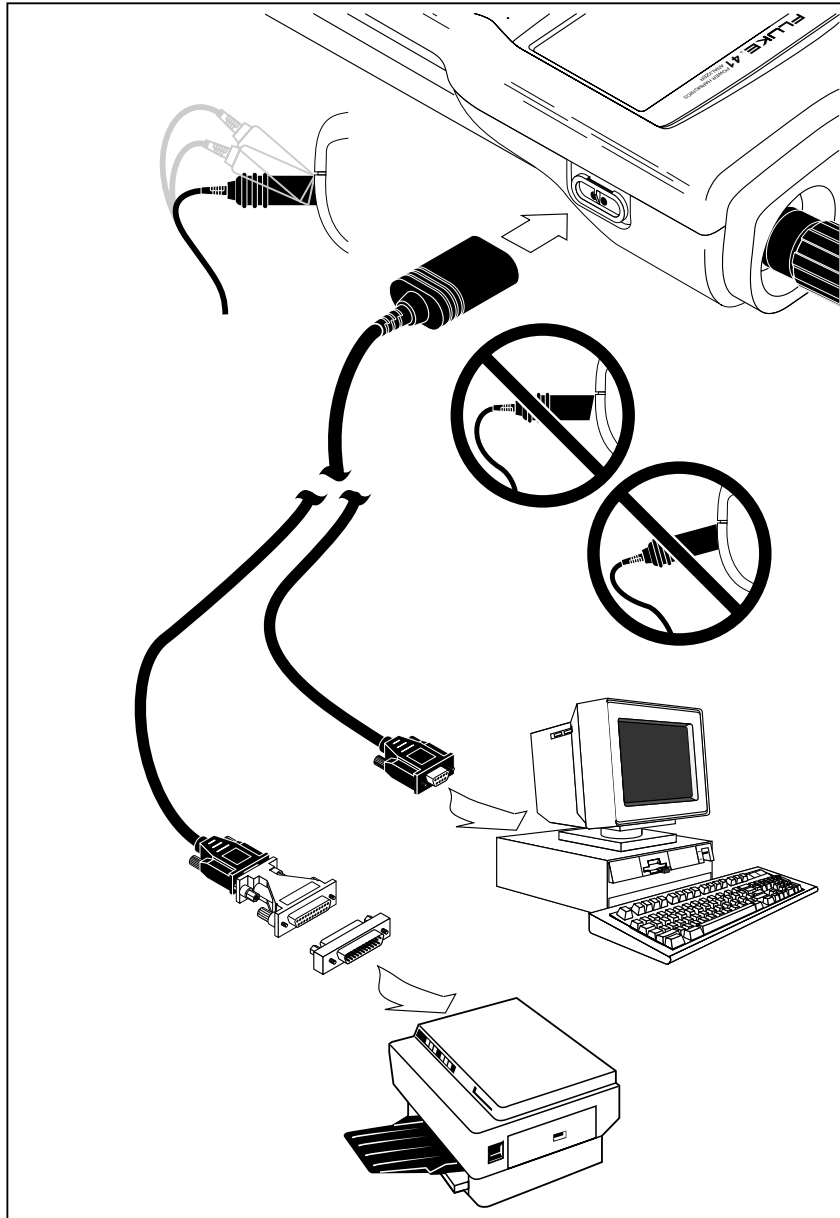

a18f.eps

Figure 19. Serial Communications (Model 41B)

PRINT

Printing (Model 41B)

Pressing sends data for the present screen to a printer. Printer type compatibility is selected on the configuration screen as EPSON or HP.

The Tester displays PRNT and the following message appears:

```
* PRINTING *  
PRESS ANY KEY TO STOP
```

Press any key to abort printing; all keys then return to their normal functions.

SEND

Sending to a Printer or PC (Model 41B)

Press to start outputting calculated results to the printer or PC. Model 41B stops outputting after it has sent a single set of calculated results. At 9600 baud, the Tester requires a few seconds to output a typical set of calculated values (1120 bytes).

Note

Do not press or while printing or using FlukeView 41 software. In either case, pressing or disrupts communications.

Using PC Software with the Tester (Model 41B)

FlukeView® 41 software is provided for Windows. Refer to the operating instructions provided with the software.

Applications

 **Warning** 

To avoid electric shock and/or equipment damage, use caution when connecting alligator clips to live components. The jaws of alligator clips can create a short circuit between closely spaced live parts. Avoid making connections to feeder conductors or bus bars at elevated potentials. Whenever possible, make connections to the output side of a circuit breaker, which can provide better short circuit protection.

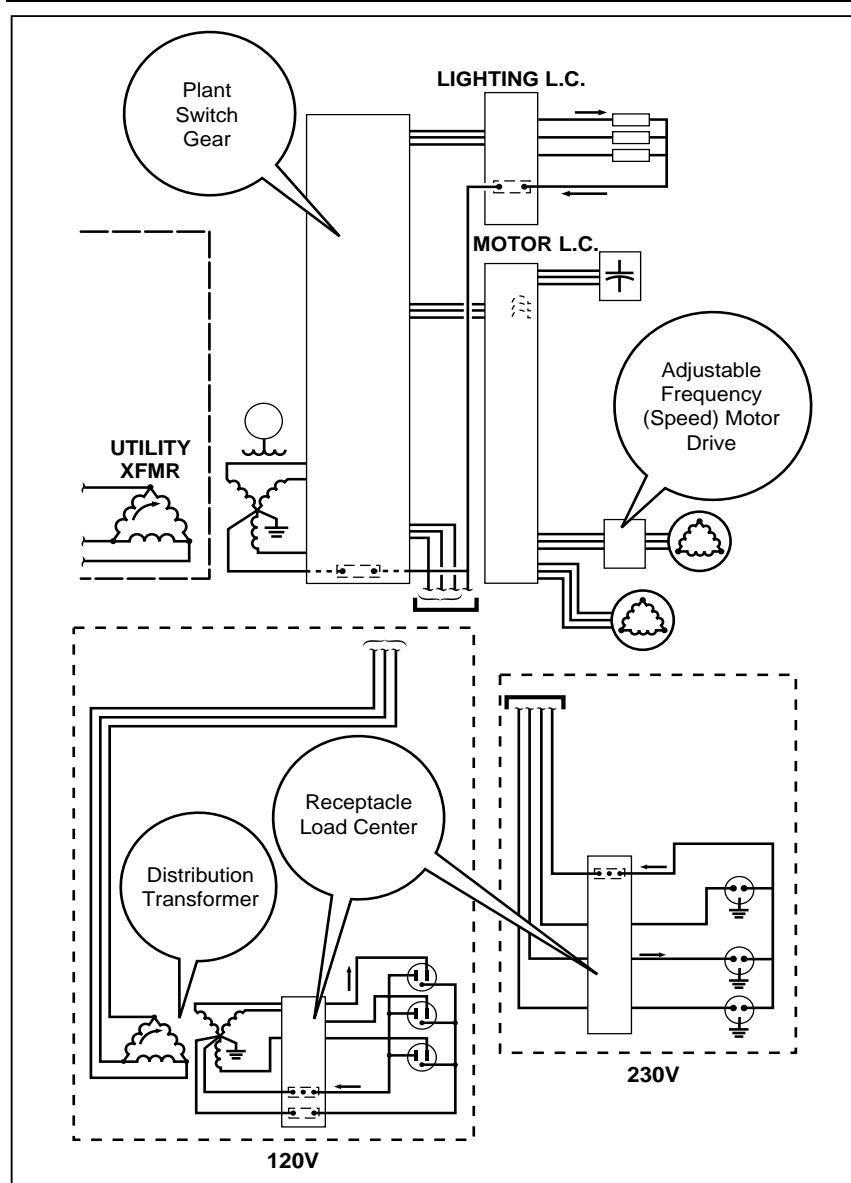

a19f.eps

Figure 20. Typical Applications

Plant Switch Gear (Service Entrance)

Measure current, load balance, and total harmonic distortion. Refer to Figure 21. Press $\begin{matrix} \cdot V \ \emptyset \\ \cdot A \ \text{REF} \end{matrix}$ to select current ($\text{A} \emptyset$) for the display phase reference.

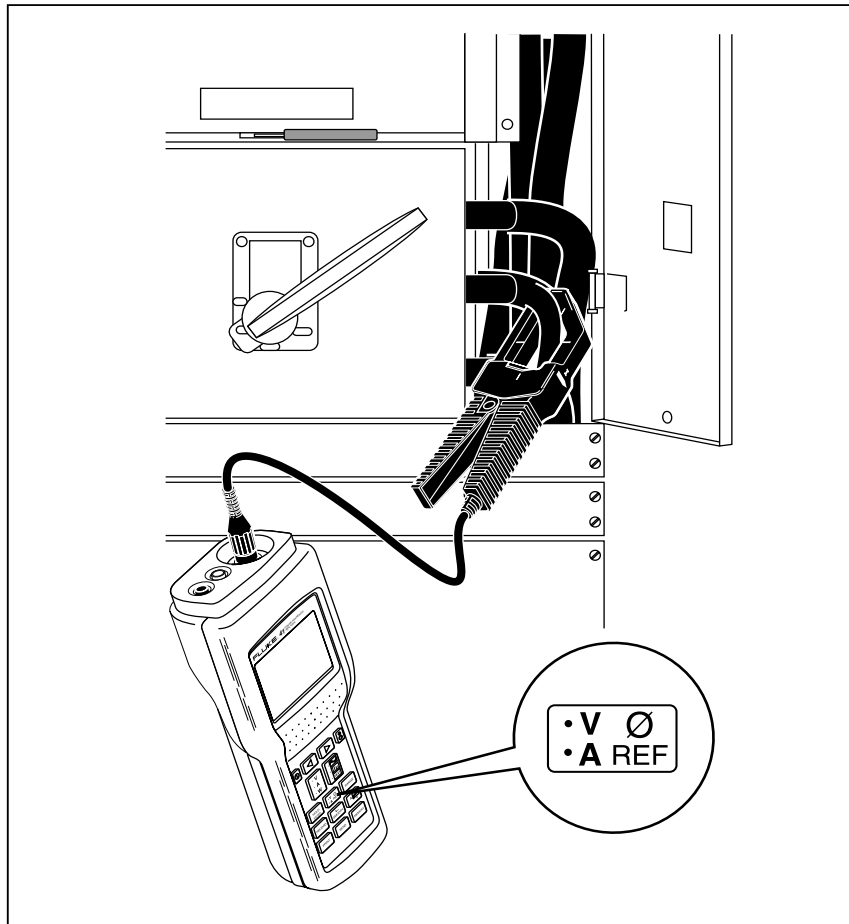

Figure 21. Plant Switch Gear

Distribution Transformer

Measure Power Factor, K Factor, power, neutral current, neutral frequency, and load balance between phases. Refer to Figures 22 and 23.

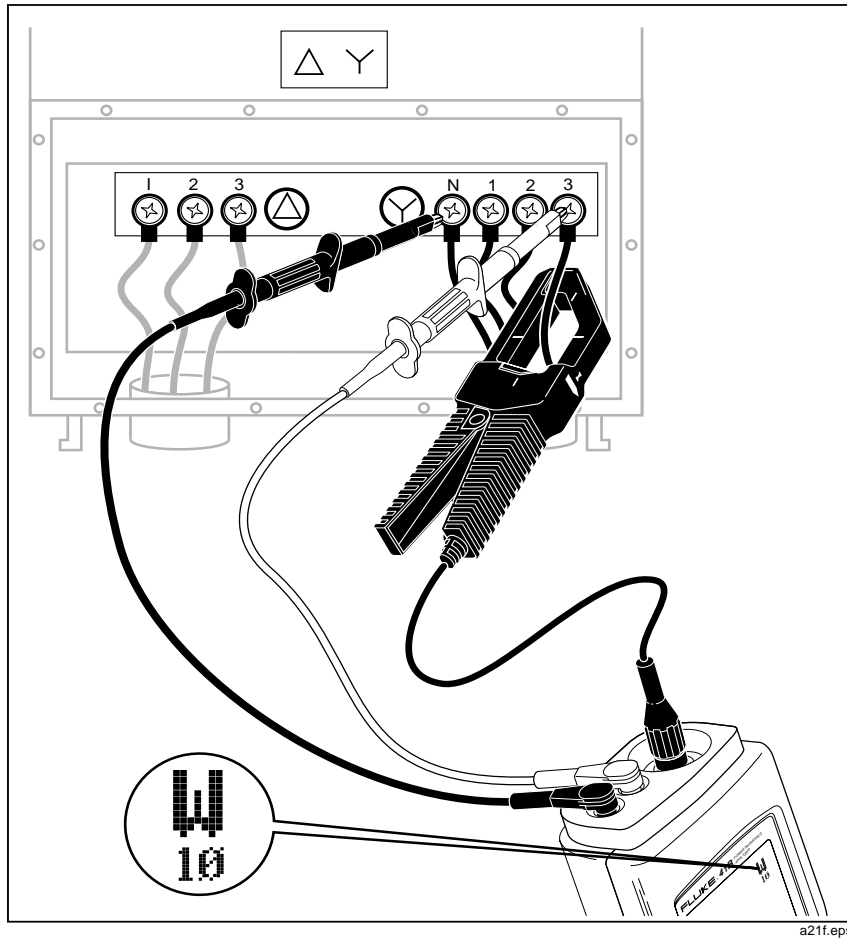

Figure 22. Distribution Transformer (10 Watts Text Screen)

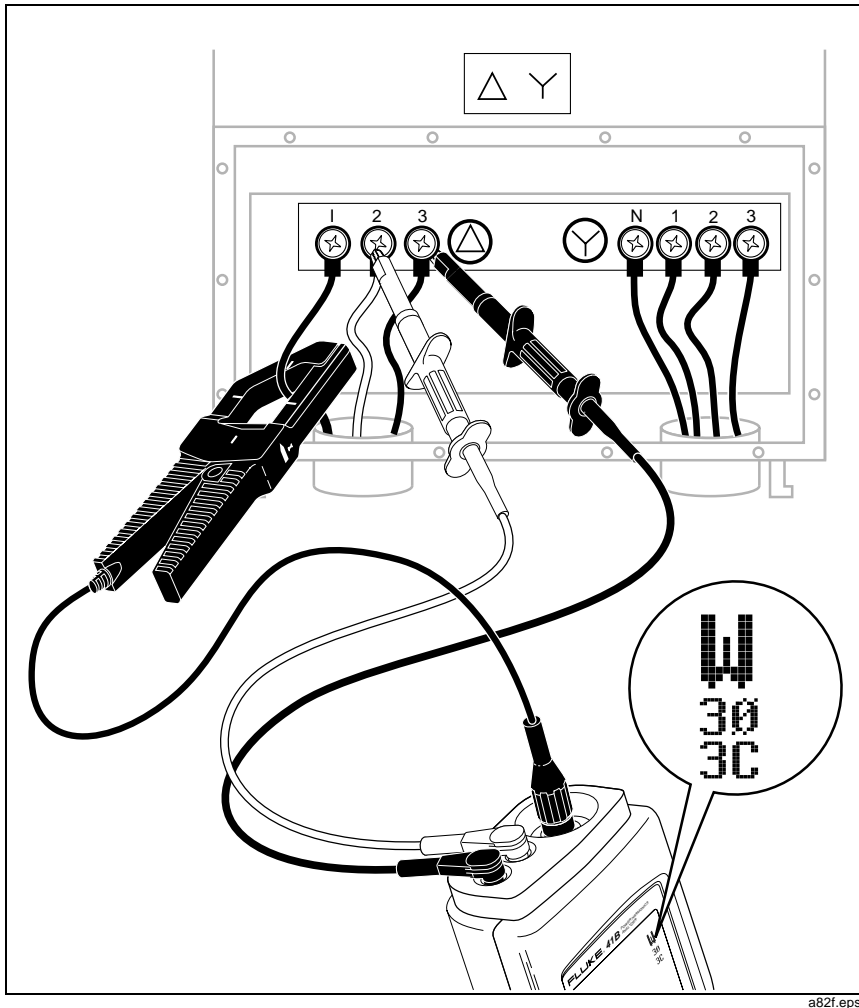

Figure 23. Distribution Transformer (3 ϕ , 3C Watts Text Screen)

Electronic Equipment Load Center

Make connections to circuit breakers by first turning the circuit breaker off. Then connect the alligator clip to the breaker output terminal via a short piece of insulated wire, refer to Figure 24.

Measure for excessive current (tripping of circuit breakers) and other general measurements (such as level of current flow) in each circuit. Measure balance between phases, neutral current and frequency, and harmonic distortion.

Measure input current, crest factor, and harmonics for PC, copier, printer, and single phase UPS. Most electronic equipment loads are nonlinear due to their use of switching-type power supplies.

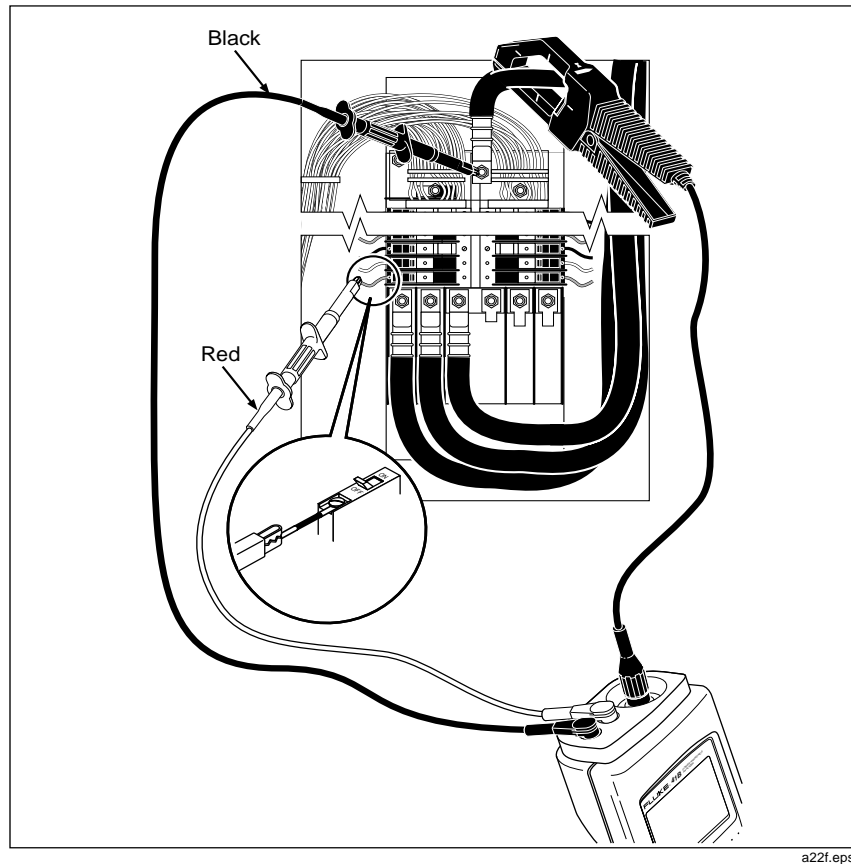
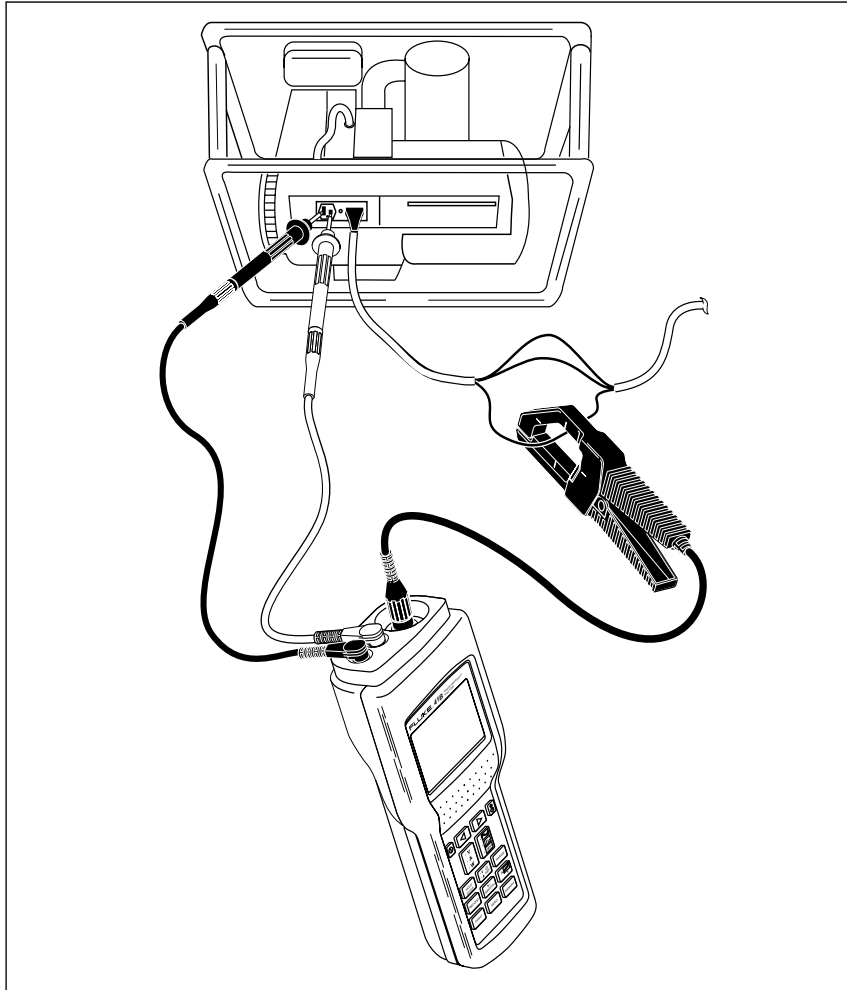

Figure 24. Receptacle Load Center (Neutral Current Measurement)

Generator Set

Measure for excessive current, proper frequency (adjust generator speed), and other general uses. Refer to Figure 25. (Small generator shown.)



a23f.eps

Figure 25. Generator Set

Adjustable Frequency (Speed) Motor Drive

Measure input and output current and current frequency. Refer to Figure 26. The Tester measures the output current frequency of the drive. (Output current provides the most stable frequency measurement.) Input power and harmonic currents can also be measured. Press $\text{V} \ominus$ / A REF to select current $\text{A} \ominus$ for the display reference.

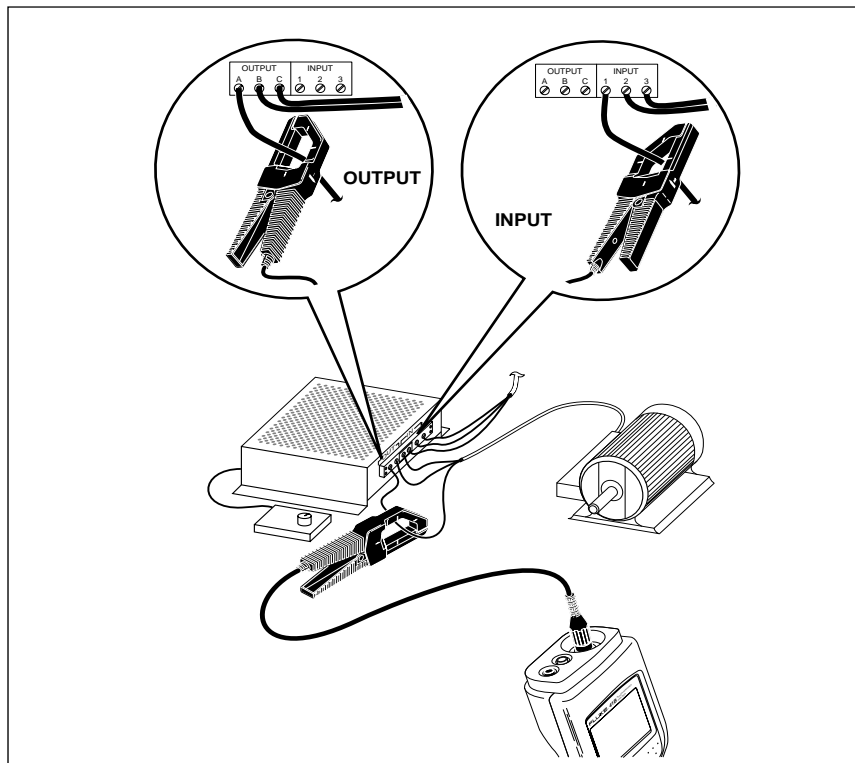

a24f.eps

Figure 26. Adjustable Frequency Motor Drive

User Maintenance

Cleaning

Clean your Tester with a damp cloth and a mild detergent. Do not use abrasives, solvents, or alcohol.

Fuse Replacement

The Tester uses electronically protected inputs; no fuses are required.

Battery Replacement



To avoid electrical shock, disconnect the voltage test leads and the current probe before replacing the batteries.

The Tester must be disconnected from all sources before you can open it for any adjustment, battery replacement, maintenance, or repair.

The Tester uses four alkaline C cells (supplied). You can also use four rechargeable NiCad batteries, which you must supply. (The Tester does not provide for internal recharging.)



Used Nickel-Cadmium batteries should be disposed of by a qualified recycler or hazardous materials handler. Contact your authorized Fluke Service Center for recycling information.

Referring to Figure 27, use the following procedure to replace the batteries:

1. Press  off.
2. Disconnect the voltage test leads and the Current Probe at the test points (first) and at the Tester (second).
3. Place the Tester face down on a nonabrasive surface. Loosen the two screws with a flat-blade screwdriver.

4. Lift the battery access lid away from the Tester.
5. Replace the C cells (alkaline or recharged NiCad) as shown in Figure 24. Observe the battery polarity shown in the battery compartment.
6. Secure the battery access lid back in position with the two screws.

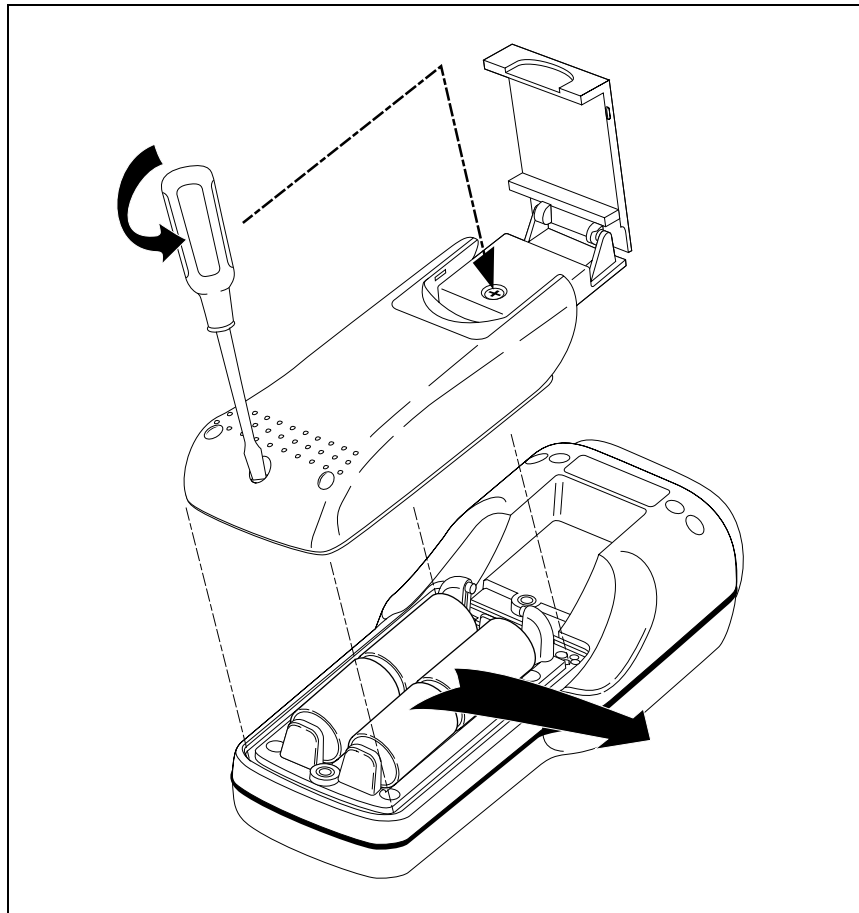

a25f.eps

Figure 27. Battery Replacement



Operational Test

Use any of the applications shown in this manual to verify volts, amps, and watts measurability. For a full operational test, refer to the Service Manual (P/N 601044).

If the Screen Flashes or is Blank at Power-Up

If the screen flashes or is blank at power-up, it may be caused by a low contrast setting. If neither of the following procedures works, refer to “If Your Tester Does Not Work” for instructions on returning the unit for repair.

If the instrument flashes a dark test pattern and then appears blank:

Tap , then hold  down for several seconds. A normal screen display should appear. Adjust to the desired contrast, then tap  again to store the setting.

If the screen is blank (no dark flash):

Check the batteries. If the batteries read below 1.1V, replace them. If the screen is still blank, refer to “If Your Tester Does Not Work” for instructions on returning the unit.

If Your Tester Does Not Work

If your Tester does not work, make the following basic checks:

- Examine the case for physical damage. If you detect damage, contact a Fluke Service Center. (Refer to the list of service centers at the end of this manual.)
- Are you testing a live circuit? Test on a known-live circuit.
- Check the batteries, test leads, and Current Probe. If necessary, replace any of these items.
- Review applicable parts of this manual to make sure you are operating the Tester correctly.
- When measuring current without the voltage test leads connected, you must select A \otimes for the phase reference (see Table 1).

Accessories and Replacement Parts

If the Tester still does not work, pack it securely and forward it, postage paid, to the nearest Service Center. Include a description of the problem. Fluke assumes no responsibility for damage in transit.

At its option, Fluke will repair or replace a Tester under warranty. The Tester will be returned at no charge. Refer to the Warranty Card for warranty terms. If the warranty has lapsed, Fluke will repair and return the Tester for a fixed fee. Contact your nearest Service Center for information and prices.

Accessories and Replacement Parts

Service Manual

The part number for the Service Manual is 601044.

Accessories

For a list of standard accessories included with the Tester, see “Unpacking” earlier in this manual. Optional accessories are as follows:

- 80i-1000s AC Current Probe
- C41s Soft Carrying Case

Replacement Parts

Parts that can be replaced by the user are shown in Table 5. Refer to the Service Manual for a complete list of replaceable parts.

Table 5. Replacement Parts

Description	Fluke PN	Qty
Battery (each, C cell, 4 required)	423582	1
Battery door (with screws)	936807	1
Hook (tilt stand)	936810	1
RS-232 Serial cable (Model 41B)	PM9080	1
FlukeView 41 Windows English software (Model 41B)	936880	1
39/41B Users Manual (English)	482287200916	1
39/41B Users Manual (French)	482287200918	1
39/41B Users Manual (German)	482287200917	1
39/41B Users Manual (Spanish)	482287200921	1
39/41B Users Manual (Italian)	482287200919	1
SW41 FlukeView Application Users Manual	600855	1
Quick Reference Guide, Fluke 39/41B	107653	1
Service Manual, Fluke 39/41B	601044	1
80i-500s AC Current Probe		1
TL24 Test Lead Set		1
TP 20 Test Probe Set		1
AC 20 Test Clip Set		1
80i-1000s AC Current Clamp (Optional)		-
C41s Carrying Case (Optional)		-
⚠ <input type="checkbox"/> Use only specified replacement parts.		

Specifications

Basic electrical specifications are defined over the temperature range from 18°C to 28°C for a period of one year after calibration.

Accuracy is specified as \pm ([% of reading] + [number of units in least significant digit]).

Frequency Range, Fundamental

6-65 Hz and dc

Minimum Input Levels

5V rms or 1A rms

Volts Measurements (True rms)

Input Range: 5.0V to 600V rms (ac + dc)
5.0V to +/-933V peak

Basic Accuracy*:

rms (ac + dc): +/- (0.5% + 2 digits)
peak, dc: +/- (2% + 3 digits)

* < 15V rms, add 2 digits

Input Impedance: 1 M Ω , balanced

Crest Factor: > 3.0 below 300V, 1.56 @ 600V

Amps Measurements (True rms)

(1 mV/A) Isolated Input

Input Range: 1.00 mV (A) to 1000 mV rms (A) (ac + dc)
1.0 mV (A) to +/- 2000 mV (A) peak

Basic Accuracy:

rms (ac + dc): +/- (0.5% + 3 digits) + probe specs.
peak, dc: +/- (2% + 4 digits) + probe specs.

Input Impedance: 1 M Ω || 47 pF

Crest Factor: > 3.0 below 600 mV, 2.0 @ 1000 mV

Watts Measurements (Volt-Amps)

(1 mV/A) Isolated Input

Range: 0 W (VA) to 600 kW (kVA) average
0 W (VA) to 2000 kW (kVA) peak

Accuracy (ac + dc):

Active W (VA): +/- (1% + 4 digits) + probe specs

Harmonics Measurement Accuracy (Cursor Data)

(Harmonic Level > 5% Using Smooth ~20)

Volts:

Fundamental to 13th Harmonic:	+/- (2% + 2 digits)
13th to 31st Harmonic:	13th (+/- (2% + 2 digits)) ----- ----- 31st (+/- (8% + 2 digits))

Amps* or Watts:

Fundamental to 13th Harmonic:	+/- (3% + 3 digits) + probe specs
13th to 31st Harmonic:	13th (+/- (3% + 3 digits) + probe specs) ----- 31st (+/- (8% + 3 digits) + probe specs)

* < 20A, add 3 digits

Phase:

Fundamental:	(±2 degrees) + probe specs
2nd to 31st Harmonic:	2nd (±5 degrees) -- 31st (±20 degrees) + probe specs

Frequency Measurement Accuracy

(Fundamental, 6.0 Hz - 99.9 Hz)

6.0 Hz - 99.9 Hz: +/- 0.3 Hz

Other Measurement Specifications

Measurement Function	Range/Resolution	Accuracy	
Input Bandwidth: (-0.5 dB):	DC 6 Hz to 2.1 kHz		
Crest Factor (CF): (Using Smooth $\Delta\nu=20$)	1.00 to 5.00	$\pm 4\%$	
Power Factor (PF):	0.00 to 1.00	± 0.02	
Displacement Power Factor (DPF):	0.00 to 0.29	unspecified	
	0.30 to 0.69	± 0.04	
	0.70 to 0.89	± 0.03	
	0.90 to 1.00	± 0.02	
Phase Measurement Range:	-179 to 180 degrees		
K-Factor (KF) Model 41B:	1.0 to 30.0	$\pm 10\%$	
Total Harmonic Distortion (THD)			
	%THD-F:	0.0 to 799.9	$\pm(0.03 \times \text{Reading} + 2.0\%)$
	%THD-R:	0.0 to 99.9	$\pm(0.03 \times \text{Reading} + 2.0\%)$

Ranges and Resolution

AC Volts		AC Amps		Watts	
Range (PK)	Resolution	Range (PK)	Resolution	Range (PK)	Resolution
20V	0.1V	2A	0.01A	50W	1.0W
50V	0.1V	5A	0.01A	100W	1.0W
100V	0.1V	10A	0.01A	200W	1.0W
200V	0.1V	20A	0.01A	500W	1.0W
500V	1V	50A	0.1A	1 kW	0.01 kW
1 kV	1V	100A	0.1A	2 kW	0.01 kW
		200A	0.1A	5 kW	0.01 kW
		500A	1A	10 kW	0.1 kW
		1000A	1A	20 kW	0.1 kW
		2000A	1A	50 kW	0.1 kW
				100 kW	1 kW
				200 kW	1 kW
				500 kW	1 kW
				1 kW	1 kW
				2 kW	1 kW

General Specifications

Size: 9.2 x 3.9 x 2.5 inches (234 x 100 x 64 mm)

Weight: 2.0 lbs (1 kg)

Input Connectors:

Voltage: 2 shrouded banana jacks (4 mm)

Current Probe: 1 shrouded BNC jack

Battery:

Type: 4 Alkaline "C" Cells ANSI/NEDA-14A, IEC-LR14
(supplied)

Operating Time: 48 hours, typical (continuous, without backlight)

Alternate Battery:

4 NiCad Cells, customer supplied and externally charged. The tester prevents battery reversal by turning itself off if battery voltage drops below 4.0V dc.

Temperature:

Operating: 0 to 50°C (32 to 122°F)

Storage: -20 to 60°C (-4 to 140°F)

Temperature Coefficient:

0.1 x Specified Accuracy per degree C
(0 to 18 degrees C, 28 to 50 degrees C)

39/41B
Users Manual

Humidity (noncondensing):

Operating:	0 - 30°C:	90%
	30 - 40°C:	75%
	40 - 50°C:	45%
Storage:		90%

Altitude:

Operating:	10,000 feet (3 km)
Storage:	40,000 feet (12 km)

Shock & Vibration: per MIL-T-28800, class 3, sinusoidal, nonoperating

Electro-Magnetic Compatibility:

RF Emissions: EN 50081-1 Commercial Limits,
VFG 243-1991

RF Susceptibility: EN 50082-1 Commercial Limits
Council Directive: Electromagnetic Compatibility Directive (89/336/EEC)

Drip Proof and Dust Proof Case: per IEC 529, Section 3;
IP 52 Dust-Protected, Drip Proof

Display

Type:	Super Twisted Liquid Crystal
Size:	3.0 inch diagonal (76 mm)
Resolution:	160 W x 128 H pixels
Contrast:	User adjustable
Backlight:	Yellow-green LED

Safety

Designed for 600V measurements on industrial power distribution circuits.

⚠ Overload Protection:

Voltage or Current Probe Input: 600V, maximum
Surge Protection: 6 kV per IEC 1010-1
Maximum Voltage Isolation to Earth: 600V from any terminal

Protection Levels:

IEC 1010-1, Pollution Degree 2, Installation
Category III, Material Group II, 600V

Protection Class:

Protection Class II as described in IEC 1010-1, Annex H (Double or Reinforced Insulation).

Waveform Memory (Model 41B)

Eight nonvolatile memories store 2048 sampled points of waveform data for both Voltage and Current inputs for later recall or sending to a computer.

EIA-232-E (RS-232) INTERFACE (Model 41B)

Optically-Isolated, 1.2, 9.6, or 19.2k baud rate.

Printer graphical output in either Epson or HP format. Text data is sent in ASCII format (SEND). Waveform, Data, and Picture formats may be remotely accessed. Remote Trigger function.

