

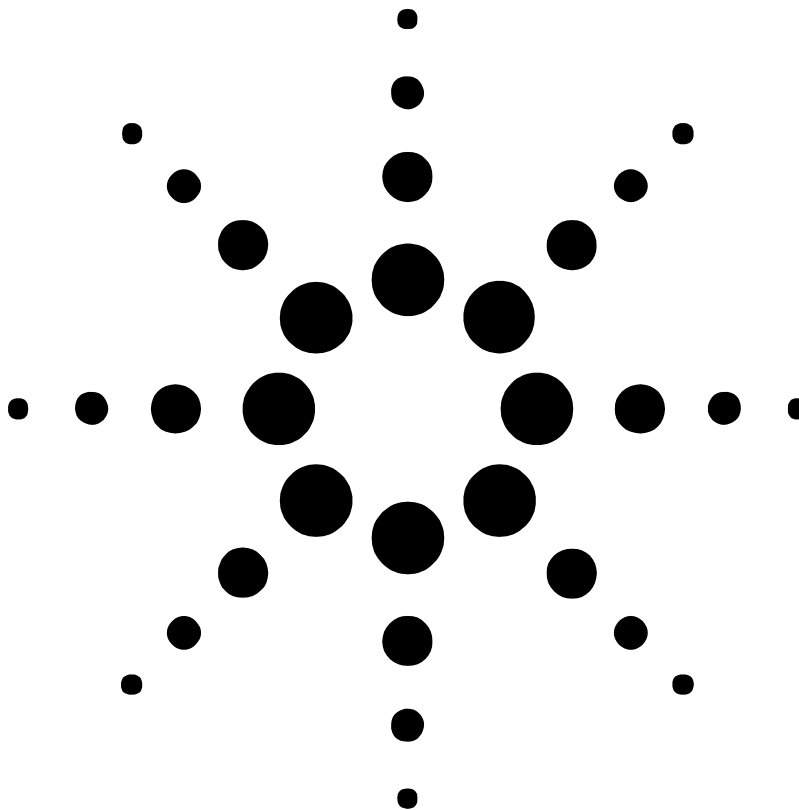

Advanced Test Equipment Rentals
www.atecorp.com 800-404-ATEC (2832)

Agilent Technologies
3458A Multimeter
Assembly-Level Repair Manual



Agilent Technologies

Manual Part Number: 03458-90011
Printed in U.S.A

AGILENT TECHNOLOGIES WARRANTY STATEMENT

AGILENT PRODUCT: 3458A Multimeter

DURATION OF WARRANTY: 1 year

1. Agilent Technologies warrants Agilent hardware, accessories and supplies against defects in materials and workmanship for the period specified above. If Agilent receives notice of such defects during the warranty period, Agilent will, at its option, either repair or replace products which prove to be defective. Replacement products may be either new or like-new.
2. Agilent warrants that Agilent software will not fail to execute its programming instructions, for the period specified above, due to defects in material and workmanship when properly installed and used. If Agilent receives notice of such defects during the warranty period, Agilent will replace software media which does not execute its programming instructions due to such defects.
3. Agilent does not warrant that the operation of Agilent products will be interrupted or error free. If Agilent is unable, within a reasonable time, to repair or replace any product to a condition as warranted, customer will be entitled to a refund of the purchase price upon prompt return of the product.
4. Agilent products may contain remanufactured parts equivalent to new in performance or may have been subject to incidental use.
5. The warranty period begins on the date of delivery or on the date of installation if installed by Agilent. If customer schedules or delays Agilent installation more than 30 days after delivery, warranty begins on the 31st day from delivery.
6. Warranty does not apply to defects resulting from (a) improper or inadequate maintenance or calibration, (b) software, interfacing, parts or supplies not supplied by Agilent, (c) unauthorized modification or misuse, (d) operation outside of the published environmental specifications for the product, or (e) improper site preparation or maintenance.
7. TO THE EXTENT ALLOWED BY LOCAL LAW, THE ABOVE WARRANTIES ARE EXCLUSIVE AND NO OTHER WARRANTY OR CONDITION, WHETHER WRITTEN OR ORAL, IS EXPRESSED OR IMPLIED AND AGILENT SPECIFICALLY DISCLAIMS ANY IMPLIED WARRANTY OR CONDITIONS OF MERCHANTABILITY, SATISFACTORY QUALITY, AND FITNESS FOR A PARTICULAR PURPOSE.
8. Agilent will be liable for damage to tangible property per incident up to the greater of \$300,000 or the actual amount paid for the product that is the subject of the claim, and for damages for bodily injury or death, to the extent that all such damages are determined by a court of competent jurisdiction to have been directly caused by a defective Agilent product.
9. TO THE EXTENT ALLOWED BY LOCAL LAW, THE REMEDIES IN THIS WARRANTY STATEMENT ARE CUSTOMER'S SOLE AND EXCLUSIVE REMEDIES. EXCEPT AS INDICATED ABOVE, IN NO EVENT WILL AGILENT OR ITS SUPPLIERS BE LIABLE FOR LOSS OF DATA OR FOR DIRECT, SPECIAL, INCIDENTAL, CONSEQUENTIAL (INCLUDING LOST PROFIT OR DATA), OR OTHER DAMAGE, WHETHER BASED IN CONTRACT, TORT, OR OTHERWISE.

FOR CONSUMER TRANSACTIONS IN AUSTRALIA AND NEW ZEALAND: THE WARRANTY TERMS CONTAINED IN THIS STATEMENT, EXCEPT TO THE EXTENT LAWFULLY PERMITTED, DO NOT EXCLUDE, RESTRICT OR MODIFY AND ARE IN ADDITION TO THE MANDATORY STATUTORY RIGHTS APPLICABLE TO THE SALE OF THIS PRODUCT TO YOU.

U.S. Government Restricted Rights

The Software and Documentation have been developed entirely at private expense. They are delivered and licensed as "commercial computer software" as defined in DFARS 252.227- 7013 (Oct 1988), DFARS 252.211-7015 (May 1991) or DFARS 252.227-7014 (Jun 1995), as a "commercial item" as defined in FAR 2.101(a), or as "Restricted computer software" as defined in FAR 52.227-19 (Jun 1987)(or any equivalent agency regulation or contract clause), whichever is applicable. You have only those rights provided for such Software and Documentation by the applicable FAR or DFARS clause or the Agilent standard software agreement for the product involved.



3458A Multimeter Assembly Level Repair Manual
Edition 2









Copyright © 1988, 2000 Agilent Technologies, Inc. All rights reserved.

Documentation History

All Editions and Updates of this manual and their creation date are listed below. The first Edition of the manual is Edition 1. The Edition number increments by 1 whenever the manual is revised. Updates, which are issued between Editions, contain replacement pages to correct or add additional information to the current Edition of the manual. Whenever a new Edition is created, it will contain all of the Update information for the previous Edition. Each new Edition or Update also includes a revised copy of this documentation history page.

Edition 1	May, 1988
Update 1	February, 1992
Edition 2	October, 1992
Edition 3	February, 1994
Edition 4	December, 2000

Safety Symbols

	Instruction manual symbol affixed to product. Indicates that the user must refer to the manual for specific WARNING or CAUTION information to avoid personal injury or damage to the product.		Alternating current (AC)
			Direct current (DC).
	Indicates the field wiring terminal that must be connected to earth ground before operating the equipment — protects against electrical shock in case of fault.		WARNING, RISK OF ELECTRIC SHOCK.
 or 	Frame or chassis ground terminal—typically connects to the equipment's metal frame.	WARNING	Calls attention to a procedure, practice, or condition that could cause bodily injury or death.
		CAUTION	Calls attention to a procedure, practice, or condition that could possibly cause damage to equipment or permanent loss of data.

WARNINGS

The following general safety precautions must be observed during all phases of operation, service, and repair of this product. Failure to comply with these precautions or with specific warnings elsewhere in this manual violates safety standards of design, manufacture, and intended use of the product. Agilent Technologies assumes no liability for the customer's failure to comply with these requirements.

Ground the equipment: For Safety Class 1 equipment (equipment having a protective earth terminal), an uninterruptible safety earth ground must be provided from the mains power source to the product input wiring terminals or supplied power cable.

DO NOT operate the product in an explosive atmosphere or in the presence of flammable gases or fumes.

For continued protection against fire, replace the line fuse(s) only with fuse(s) of the same voltage and current rating and type. **DO NOT** use repaired fuses or short-circuited fuse holders.

Keep away from live circuits: Operating personnel must not remove equipment covers or shields. Procedures involving the removal of covers or shields are for use by service-trained personnel only. Under certain conditions, dangerous voltages may exist even with the equipment switched off. To avoid dangerous electrical shock, **DO NOT** perform procedures involving cover or shield removal unless you are qualified to do so.

DO NOT operate damaged equipment: Whenever it is possible that the safety protection features built into this product have been impaired, either through physical damage, excessive moisture, or any other reason, REMOVE POWER and do not use the product until safe operation can be verified by service-trained personnel. If necessary, return the product to Agilent for service and repair to ensure that safety features are maintained.

DO NOT service or adjust alone: Do not attempt internal service or adjustment unless another person, capable of rendering first aid and resuscitation, is present.

DO NOT substitute parts or modify equipment: Because of the danger of introducing additional hazards, do not install substitute parts or perform any unauthorized modification to the product. Return the product to Agilent for service and repair to ensure that safety features are maintained.

Measuring high voltages is always hazardous: ALL multimeter input terminals (both front and rear) must be considered hazardous whenever inputs greater than 42V (dc or peak) are connected to ANY input terminal.

Permanent wiring of hazardous voltage or sources capable of delivering greater than 150 VA should be labeled, fused, or in some other way protected against accidental bridging or equipment failure.

DO NOT leave measurement terminals energized when not in use.

DO NOT use the front/rear switch to multiplex hazardous signals between the front and rear terminals of the multimeter.



Manufacturer's Name: Agilent Technologies, Incorporated
Manufacturer's Address: 815 14th ST. S.W.
Loveland, CO 80537
USA

Declares, that the product

Product Name: Multimeter
Model Number: 3458A
Product Options: *This declaration covers all options of the above product(s).*

Conforms with the following European Directives:

The product herewith complies with the requirements of the Low Voltage Directive 73/23/EEC and the EMC Directive 89/336/EEC (including 93/68/EEC) and carries the CE Marking accordingly

Conforms with the following product standards:

EMC	Standard	Limit
	IEC 61326-1:1997+A1:1998 / EN 61326-1:1997+A1:1998	
	CISPR 11:1990 / EN 55011:1991	
	IEC 61000-4-2:1995+A1:1998 / EN 61000-4-2:1995	Group 1 Class A
	IEC 61000-4-3:1995 / EN 61000-4-3:1995	4kV CD, 8kV AD
	IEC 61000-4-4:1995 / EN 61000-4-4:1995	3 V/m, 80-1000 MHz
	IEC 61000-4-5:1995 / EN 61000-4-5:1995	0.5kV signal lines, 1kV power lines
	IEC 61000-4-6:1996 / EN 61000-4-6:1996	0.5 kV line-line, 1 kV line-ground
	IEC 61000-4-11:1994 / EN 61000-4-11:1994	3V, 0.15-80 MHz I cycle, 100%
	Canada: ICES-001:1998	Dips: 30% 10ms; 60% 100ms
	Australia/New Zealand: AS/NZS 2064.1	Interrupt > 95%@5000ms
	<i>The product was tested in a typical configuration with Agilent Technologies test systems.</i>	

Safety IEC 61010-1:1990+A1:1992+A2:1995 / EN 61010-1:1993+A2:1995
Canada: CSA C22.2 No. 1010.1:1992
UL 3111-1: 1994

8 March 2001

Date

Ray Corson

Product Regulation Program Manager

For further information, please contact your local Agilent Technologies sales office, agent or distributor.
Authorized EU-representative: Agilent Technologies Deutschland GmbH, Herrenberger Straße 130, D 71034 Böblingen, Germany

Contents

Safety Symbols	3	Printed Circuit Assembly Identification	32
WARNINGS	3	Board Part Number	32
Chapter 1 General Information		Engineering Revision Code	32
Introduction	7	Covers Removal/Installation Procedures	33
Manual Description	7	Tools Required	33
Instrument Description	7	Covers Removal Procedure	33
Safety Considerations	8	Covers Installation Procedure	36
Instrument Identification	8	Assemblies Removal/Installation Procedures	39
Tools And Equipment Required	8	Tools Required	39
Tools Required	8	DC Circuitry Assembly Removal/Installation	
Test Equipment Required	9	Procedures	40
Chapter 2 Operating Information		DC Reference Assembly Removal/Installation	
Introduction	11	Procedures	44
Before Applying Power	11	AC Converter Assembly Removal/Installation	
Applying Power	12	Procedures	45
Power-On Self-Test	12	A/D Converter Assembly Removal/Installation	
Power-On State	12	Procedures	46
The Display	13	Inguard Power Supply Assembly Removal/	
Operating from the Front Panel	14	Installation Procedures	49
Making a Measurement	15	Outguard Controller Assembly Removal/	
Changing the Measurement Function	15	Installation Procedures	51
Autorange and Manual Ranging	16	Outguard Power Supply Assembly Removal/	
Self-Test	17	Installation Procedures	52
Reading the Error Register	18	Display Logic Assembly Removal/Installation	
Resetting the Multimeter	19	Procedures	56
Using the Configuration Keys	19	Front/Rear Terminals Switch Removal/Installation	
Using the MENU Keys	23	Procedures	61
Query Commands	24	Replaceable Parts	63
Display Control	25	Ordering Information	63
Digits Displayed	26	Direct Mail Ordering	63
Recall	27	Telephone Ordering	63
Operating from Remote	27	Replaceable Parts List	64
Input/Output Statements	27	Chapter 4 Assembly Level	
Reading the GPIB Address	27	Troubleshooting	
Changing the GPIB Address	28	Introduction	67
Sending a Remote Command	28	Test Equipment Required	67
Getting Data from the Multimeter	28	3458A Adjustments/Calibration	67
The Local Key	29	Assemblies Removal/Installation Procedures	68
Chapter 3 Disassembly/Assembly		3458A Technical Description	68
Procedures and Parts List		General Description	68
Introduction	31	Technical Description	69
Static Handling	31	Outguard Section	70
Clean Handling	32	Inguard Section	71
		Assembly Level Troubleshooting	73

3458A Failures	73
Power Supplies Troubleshooting	82
Outguard Power Supplies Troubleshooting	84
Inguard Power Supplies Troubleshooting	84

Introduction

This manual has information to perform assembly level troubleshooting of the 3458A Multimeter. Included are the removal/installation procedures of the instrument's printed circuit board assemblies, and a parts list. This manual is intended for use by service-trained personnel only. Operating and programming personnel should refer to the 3458A Multimeter User's Guide.

Detailed operating and programming information is excluded from this manual. Only sufficient information for service purposes is included. For more detailed operating and programming information, refer to the 3458A Multimeter User's Guide.

WARNING The information in this manual is for the use of Service Trained Personnel only. To avoid electrical shock, do not perform any procedures in this manual or do any servicing to the 3458A, unless you are qualified to do so.

Manual Description

This manual is separated into the four following chapters.

Chapter 1 - General Information

Chapter 1 contains a brief description of the instrument and other general information.

Chapter 2 - Operating Information

Chapter 2 summarizes instrument operation geared for service-trained personnel. Only service related commands are summarized. For more operating information, refer to the 3458A Multimeter User's Guide.

Chapter 3 - Removal/Installation Procedures and Mechanical Parts List

Chapter 3 has the removal/installation procedures for the 3458A Printed Circuit Board Assemblies. The section also has a mechanical parts list.

Chapter 4 - Assembly Level Troubleshooting

Chapter 4 contains a block diagram theory of operation and assembly level troubleshooting information.

Instrument Description

The 3458A is a high precision digital multimeter that can measure AC and DC volts, AC and DC current, AC+DC volts, AC+DC current, resistance, period, and frequency. It can also perform complex math calculations.

The multimeter has a maximum reading rate of 100,000 readings/sec. The maximum input voltage is 1000 V peak and the resolution is from 4 1/2 to 8 1/2 digits.

The 3458A has a digitizing function that converts continuous analog signals into discrete samples.

All instrument functions are selectable from the front panel or remotely over the General Purpose Interface Bus (GPIB).

Safety Considerations

The 3458A is a safety class 1 instrument provided with a protective earth terminal. The instrument and manuals should be reviewed for safety markings and instructions before operation. Refer to the Safety Summary preceding this section for appropriate safety instructions and markings covering the instrument.

Instrument Identification

Agilent instruments are identified by a two part, ten-digit serial number. The serial number is located on the instrument's rear panel between the rear terminals and fan filter. The number is in the form 0000A00000. The first four digits, called the serial number prefix, is the same for all identical instruments. It changes only when a change is made to the instrument. The letter indicates the country of origin (A indicates the instrument was built in the United States of America). The last five digits, called the serial number suffix, are unique for each instrument.

Be sure to include the entire serial number, both prefix and suffix, in any correspondence about your instrument.

Tools And Equipment Required

Tools Required You need the following tools for instrument covers removal and installation.

1. #1 Pozidriv screwdriver.
2. #TX15 Torx driver.
3. #TX10 Torx driver.

You need the following tools for the printed circuit board assemblies removal/installation procedures.

1. #1 Pozidriv screwdriver.
2. TX10 Torx driver.

3. 6 millimeter nut driver (for A/D Converter assembly only).
4. 7 millimeter nut driver (for Outguard Controller assembly only)
5. Small flat bladed screwdriver (for Display Logic assembly only)
6. Large screwdriver (e.g., #2 Pozidriv; for Display Logic assembly only)

Test Equipment Required

You need the following to troubleshoot the 3458A.

1. 4 1/2 digit digital multimeter that can measure +5 V, +18 V, and -18 V DC.
2. Computer with GPIB capability (for GPIB failures only).
3. Logic Probe or Oscilloscope than can measure a 1 μ S 5 V pulse (for Ext Out failures only).

Introduction

This section summarizes the 3458A operating information. The 3458A User's Guide has the complete operating information.

Before Applying Power

- Make sure the line voltage selection switches on the multimeter's rear panel are set to match the local line voltage.
- Make sure the proper line fuse is installed.

If you have any questions concerning installation or power requirements, refer to Chapter 1.

Table 1. Line Voltage Limits

Nominal Value (RMS)	Allowable Limits (RMS)	Fuse	Fuse part #
100 VAC	90 VAC to 110 VAC	1.5A 250V NTD FE UL	2110-0043
120 VAC	108 VAC to 132 VAC	1.5A 250V NTD FE UL	2110-0043
220 VAC	198 VAC to 242 VAC	0.5A 250V TD FE UL	2110-0202
240 VAC	216 VAC to 250 VAC	0.5A 250V TD FE UL	2110-0202

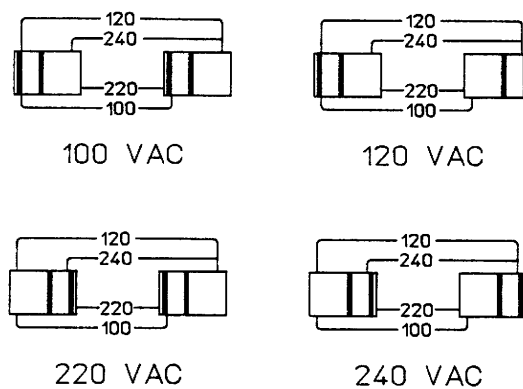

Figure 1. AC line voltage switch positions

Power Cords

Country	Part Number	Option	Voltage
Australia	8120-1369	901	250V 6A
Denmark	1820-2956	912	259V 6A
Europe	1820-1689	902	250V 6A
Great Britain	1820-1351	900	250V 6A
Switzerland	1820-2104	906	250V 6A
United States	1820-1378	903	120 10A
United States	1820-0698	904	240V 10A

Power cords supplied by Agilent have polarities matched to the power input socket on the instrument.

NOTE: Plugs are viewed from connector end. Shape of molded plug may vary within country

*CSA certification includes only these power cords

Figure 2. Power Cords

Applying Power

To turn on the multimeter, depress the front panel **Power** switch. If the multimeter does not appear to turn on, verify that the multimeter is connected to line power. If line power is not the problem, remove the power cord and check the line power fuse and the line voltage selection switch settings.

Power-On Self-Test

When power is applied, the multimeter performs a limited power-on self-test. This test verifies that the multimeter is operating but does not necessarily verify that measurements will be accurate.

Power-On State

When the power-on self-test is finished, the multimeter beeps once, automatically triggers, automatically selects the range, and performs DC voltage measurements. Also, the multimeter has set many of its commands to predefined power-on values as shown in Table 2, This is called the power-on state.

Table 2. Power-On State

Command	Description
ACBAND 20, 2E6	AC bandwidth 20Hz - 2MHz
AZERO ON	Autozero enabled
DCV AUTO	DC voltage, autorange
DEFEAT OFF	Defeat disabled
DELAY -1	Default delay
DISP ON	Display Enabled
EMASK 32767	Enable all error conditions
END OFF	Disable GPIB EOI function
EXTOUT ICOMP, NEG	Input complete EXTOUT signal, negative pulse
FIXEDZ OFF	Disable fixed input resistance
FSOURCE ACV	Frequency and period source is AC voltage
INBUF OFF	Disable input buffer
LEVEL 0, AC	Level trigger at 0%, AC-coupled
LFILTER OFF	Level filter disabled
LFREQ 50 or 60	Measured line frequency rounded to 50 or 60Hz
LOCK OFF	Keyboard enabled
MATH OFF	Disable real-time math
MEM OFF	Disable reading memory (last memory operation = FIFO)
MFORMAT SREAL	Single real reading memory format
MMATH OFF	Disable post-process math
NDIG 7	Display 7.5 digits
NPLC 10	10 power line cycles of integration time
NRDGS 1, AUTO	1 reading per trigger, auto sample event
OCOMP OFF	Disable offset compensated resistance
OFORMAT ASCII	ASCII output format
QFORMAT NORM	Normal query format
RATIO OFF	Disable ratio measurements
RQS 0 (or 8)	0 disables status register conditions (if power-on SRQ was on when power was removed, value = 8).
SETACV ANA	Analog AC voltage mode
SLOPE POS	Positive slope for level triggering
SSRC LEVEL, AUTO	Level sync source event, auto synchronous AC voltage
SWEEP IOOE-9,1024	Sample interval 100 nanoseconds, 1024 samples
TARM AUTO	Auto trigger arm event
TBUFF OFF	Disable external trigger buffering
TIMER 1	1 second timer interval
TRIG AUTO	Auto trigger event

All math registers set to 0 except:

DEGREE = 20 REF=I SCALE = 1 RES=50 PERC = 1

The Display

In the power-on state, the display is continuously updated with each new DC voltage reading. Along the bottom of the display are a series of annunciators. These annunciators alert you to a variety of conditions. For example, the **SMPL** annunciator flashes whenever the multimeter has completed a reading. Table 3 describes the meaning of each display annunciator.

Making a Measurement

In the power-on state, DC voltage measurements are selected and the multimeter automatically triggers and selects the range. In the power-on state, you can make DC voltage measurements simply by connecting a DC voltage to the input terminals as shown in Figure 4. The connections shown in Figure 4 also apply for AC voltage, 2-wire resistance, AC+DC voltage, digitizing, and frequency or period measurements from a voltage input source. Refer to Chapter 3 for a CAUTION concerning the multimeter's maximum input voltage and current.

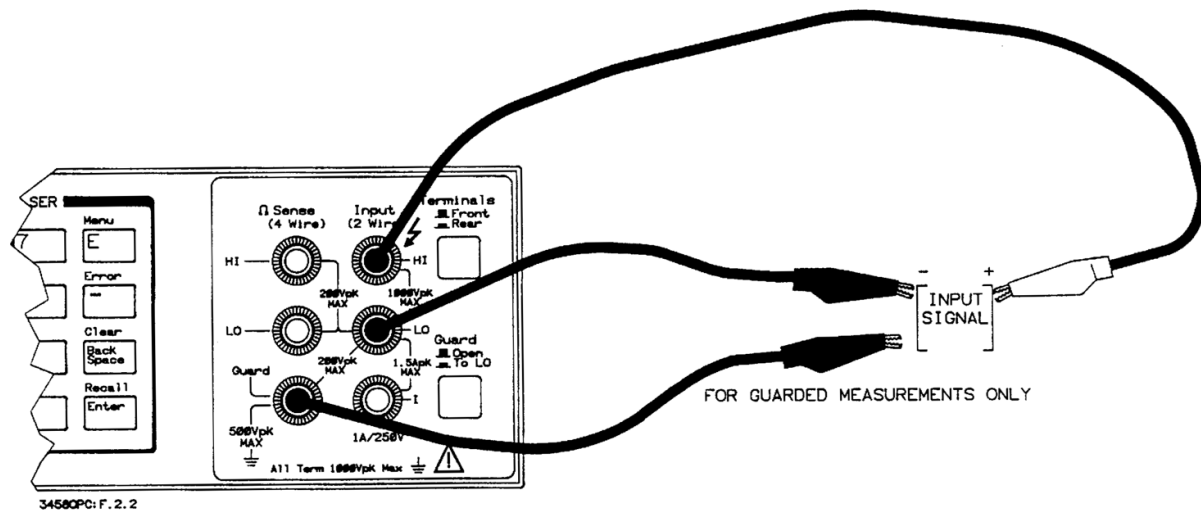















Figure 4. Standard 2-wire (plus guard) measurements

Changing the Measurement Function

The row of keys located directly under the display (**FUNCTION** keys) select the multimeter's standard measurement functions. Table 4 shows the **FUNCTION** keys and the measurement function selected by each.

Table 4. Function Keys

Key	Description
	DC voltage measurements
	AC voltage measurements
	2-wire resistance measurements
	DC current measurements
	AC current measurements
	Frequency measurements
 	AC+DC voltage measurements
 	4-wire resistance measurements
 	AC+DC current measurements
 	Period measurements

In addition to the functions selected by the **FUNCTION** keys, the multimeter can perform direct-sampled or sub-sampled digitizing, ratio measurements, and AC or AC+DC voltage measurements using the synchronous or random measurement methods. These functions can be selected from the front panel by accessing the appropriate command(s) using the alphabetic menu keys (these keys are discussed later in this section under "Using the MENU Keys").

Autorange and Manual Ranging

In the power-on state, the multimeter automatically selects the appropriate measurement range. This is called autorange. In many cases, you will probably want to continue using autorange. However, you have two other ranging choices: hold and manual ranging.

Hold This choice allows you to shut off autoranging. To do this, let autorange choose a range and then Press:



Note When you press the blue shift key, the display's **SHIFT** annunciator illuminates. The shifted keyboard functions are printed in blue above the keys.

Notice the display's **MRNG** (manual range) annunciator is on. This annunciator is on whenever you are not using autorange.

Manual Ranging

The second choice lets you manually select the range. When the multimeter is in the measurement mode (that is, the multimeter is making and displaying measurements or the display is showing OVL D) you can change the range by pressing the up or down arrow keys. To go to a higher range.

Press:



By repeatedly pressing the up arrow key, you can increment up to the highest range. When you reach the highest range, pressing the up arrow key no longer changes the range. To go to a lower range.

Press:



By repeatedly pressing the down arrow key, you can decrement down to the lowest range. When you reach the lowest range, pressing the down arrow key no longer changes the range. To return to autoranging.

Press:



Self-Test

When you applied power to the multimeter, it automatically performed a limited power-on self-test. Before you start making measurements, however, you may want to have more confidence that the multimeter is fully operational. This is the job of the self-test. The self-test performs a series of tests that check the multimeter's operability and accuracy.

Note

Always disconnect any input signals before you run self-test. If you leave an input signal connected to the multimeter, it cause a self-test failure.

The self-test takes over 50 seconds. To run self-test.

Press:



If the self-test passed, the display shows:

SELFTEST PASSED

When self-test passes, you have a high confidence that the multimeter is operational and, assuming proper calibration and autocalibration, that

measurements will be accurate.

If any of the tests failed, the **ERR** annunciator illuminates and the display shows:

SELFTEST FAILED

If the self-test failed, one or more error conditions have been detected. Refer to the next section "Reading the Error Register".

Reading the Error Register

Whenever the display's **ERR** annunciator is illuminated, one or more errors have been detected. A record of hardware errors is stored in the auxiliary error register. A record of programming and syntax errors is stored in the error register. To read the error record(s).

Press:



The lowest numbered error and a description of the error is displayed. For example, a possible error message is:

209, "HARDWARE FAILURE--
INTERNAL OVERLOAD: 101"

Use the right arrow key to view the entire message. When the error message has a 100-series numeric prefix (e.g., 105), it indicates a programming or syntax error. A 200-series prefix (e.g., 209) indicates a hardware error.

Note When you get a hardware error (200-series prefix), run the self-test again. If you repeatedly get the error, the multimeter may need repair.

If the **ERR** annunciator is still illuminated, more errors have been recorded. Repeat the above key sequence until all errors have been read and the ERR annunciator is no longer illuminated. When you have read all the errors, the error annunciator goes off. If you try to read another error, the display shows:

0, "NO ERROR"

You do not have to run self-test to get an error. The multimeter detects errors that occur while entering data, when changing functions or ranges, and so on. The multimeter beeps whenever it detects an error.

Whenever you want to clear information (such as an error description) from the display and return it to displaying measurements.

Press:

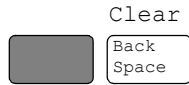

Note You can also clear the display by repeatedly pressing the **Back Space** key (unshifted).

Resetting the Multimeter

Many times during operation, you may wish to return to the power-on state. The front panel **Reset** key returns you to the power-on state without having to cycle the multimeter's power. To reset the multimeter.

Press:



The multimeter begins the reset process with a display test which illuminates all display elements including the annunciators as shown in Figure 5. (By holding down the **Reset** key, the multimeter continuously performs its display test).

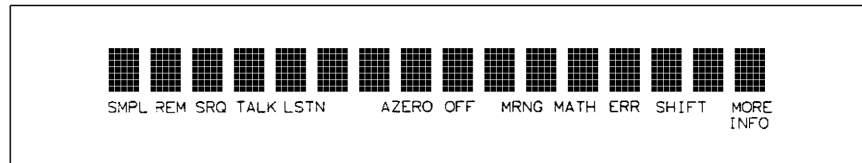

Figure 5. Display Test







Caution Pressing the shifted front panel **Reset** key performs the power-on sequence which has the same effect as cycling the multimeter's power. This destroys any stored reading and compressed subprograms, sets the power-on SRQ bit in the status register (these functions are discussed later in this manual), resets the A/D converter reference frequency and performs the power-on self test. Executing the **RESET** command from the alphabetic command menu (**MENU** keys) returns the multimeter to the power-on state but does not perform the power-on sequence. The **MENU** keys are discussed later in this chapter.

Using the Configuration Keys

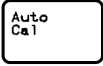
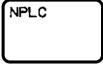
The configuration keys (unshifted **MENU** keys) let you rapidly access the most frequently used multimeter features. Table 5 shows each key, the corresponding multimeter command, and the function of each. (These

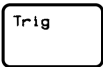
functions are discussed in detail in Chapters 3 and 4.)

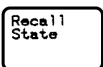
Table 5. Configuration Key Functions

Key	Command	Description
	ACAL	Performs one or all autocal routines (It takes over 11 minutes to run all of the autocal routines. Never reset the multimeter to abort an autocal. Once you start an autocal you must complete it).
	NPLC	Sets integration time in terms of power line cycles
	AZERO	Enables or disables the autozero function
	OCOMP	Enables or disables offset compensation for 2- or 4-wire resistance measurements
	TRIG	Specifies the trigger event
	NRDGS	Selects the number of readings per trigger event and the sample event
	RSTATE	Recalls a previously stored state from memory
	SSTATE	Stores the multimeter's present state in memory

We will use the **Trig** key to demonstrate how to use the configuration keys.
Press:



The display shows:

TRIG ■■

This is the command header for the trigger command. Notice the multimeter automatically placed a space after the command header.

Selecting a Parameter

For parameters that have a list of choices (non-numeric parameters), you can use the up and down arrow keys to review the choices.

Press:



The display shows:

TRIG LEVEL ■■

Press:



The display shows:

TRIG AUTO ■■

When using the up or down arrow keys, if you step past the last parameter choice, a wraparound occurs to the other end of the menu. Suppose you want to suspend triggering. Press the up or down arrow key until the display shows:

TRIG HOLD ■■

Press:



You have now changed the trigger event from auto (power-on state) to HOLD which causes the multimeter to stop taking readings. (Triggering is discussed in detail in Chapter 4.)

Default Values

Most parameters have a default value. A default value is the value selected when you execute a command but do not specify a value. For example, the default value for the trigger parameter is SGL.

Press:



TRIG ■■

Press:



Notice that the multimeter takes one reading and then stops (after the single trigger, the trigger event becomes HOLD regardless of the previously specified trigger event). You can also enter-1 to select the default value.

Press:



The multimeter again takes a single reading and then stops.

Numeric Parameters

Some commands use numeric parameters. A numeric parameter is the actual value used by the multimeter. We will use the **NPLC** configuration key to demonstrate numeric parameters.

Press:

NPLC

This display shows:

NPLC █

Notice that if you press the up or down arrow key, no parameter choice is displayed. This means there is no menu and you must enter a number. For example.

Press:

1 Enter

You have now selected 1 power line cycle of integration time for the A/D converter. Integration time is the actual time that the A/D converter measures the input signal. (Integration time is discussed in detail in Chapter 3.)

Exponential Parameters

You can also enter numeric parameters using exponential notation. For example.

Press:

NPLC 1 0 0 E - 3 Enter

You have now selected 0.1 power line cycles of integration time. At this point, you should reset the multimeter to return the number of power line cycles to 10 by pressing:

Reset
█

Multiple Parameters

Many commands have more than one parameter. (Multiple parameters are separated by commas.) We will use the **NRDGS** command, which has two parameters, as an example of a command with multiple parameters.

Press:

N Rdge/
Trig

The display shows:

NRDGS █

The first parameter in the NRDGS command is a numeric parameter that specifies the number of readings made per trigger event. For example, to specify 5 readings per trigger event.

Press:

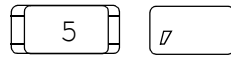

The display shows:

NRDGS 5, ■■

The second parameter of the NRDGS command specifies the event that initiates each reading. Since this is not a numeric parameter, a menu is available for this parameter. Use the up or down arrow keys to cycle through the list of choices. When the display shows:

NRDGS 5, AUTO ■■

Execute the command by pressing:



You have now selected five readings per trigger event. If you execute the TRIG SGL command, for example, the multimeter will take five readings and then stop. (The NRDGS command is discussed in detail in Chapter 4.)

Using the MENU Keys

In addition to the configuration keys, the multimeter has an alphabetic command menu that can be accessed using the shifted **MENU** keys labeled **C, E, L, N, R, S,** and **T**. Each of these letters corresponds to the area you will enter into the command menu. For example, to enter the menu with commands starting with T.

Press:



The display shows:

TARM ■■

You can now use the **Menu Scroll** keys (up or down arrow keys) to step through the menu in alphabetical order (down arrow key) or in reverse alphabetical order (up arrow key). For example, starting with the TARM display shown above, by pressing the down arrow key once, the display shows the next command in alphabetical order (TBUFF). (You can also press and hold the up or down arrow key to rapidly step through the menu.) Once you have found the desired command, you can press the **Enter** key to execute it immediately (using default parameter values if applicable). If you need to specify command parameter(s), with the command displayed, press the right

arrow key or the comma key (or, if the first parameter is numeric, a numeric key). This selects the command and allows you to specify or select parameter(s) using the procedures described earlier in this section.

There are two alphabetic menus available: FULL and SHORT. You can select between these menus using the shifted **Menu** key. The specified menu choice is stored in continuous memory (not lost when power is removed). The FULL menu contains all commands except query commands that can be constructed by appending a question mark to a command (e.g., BEEP, BEEP?). (Query commands are discussed next.) The SHORT menu eliminates the GPIB bus-related commands, commands that are seldom used from the front panel, and any commands that have dedicated front panel keys (e.g., the **NPLC** key or the **Trig** key).

Query Commands

There are a number of commands in the alphabetic command directory that end with a question mark. These commands are called query commands since each returns a response to a particular question. For example, access the LINE? query command from the command menu and press the **Enter** key. The multimeter responds to this query command by measuring and displaying the power line frequency. (Use the right arrow key to view the entire response.) As another example, access the TEMP? command from the command menu and press **Enter**. This command returns the multimeter's internal temperature in degrees Centigrade.

Standard Queries

The FULL command menu contains the following standard query commands:

AUXERR?	MCOUNT?
CAL?	MSIZE?
CALNUM?	OPT?
ERR?	REV?
ERRSTR?	SSPARM?
ID?	STB?
ISCALE?	TEMP?
LINE?	

Additional Queries

In addition to the queries listed above, you can create others by appending a question mark to any command that can be used to program the multimeter. For example, the AZERO command (**Auto Zero** configuration key) enables or disables the autozero function. You can determine the present autozero mode by appending a question mark to the AZERO command. To do this, Press:



The multimeter responds by displaying the present autozero mode (power-on mode = ON). (Notice that this command is immediately executed; you do not have to press the **Enter** key.)

Note The QFORMAT command can be used to specify whether query responses

will be numeric, alpha, or a combination of alpha and numeric. Refer to the QFORMAT command, in Chapter 6, for more information.

Display Control

The shifted **Clear** key, the **Back Space** key, and the **Display/Window** keys (left and right arrow keys) allow you to control the display.

Clearing the Display

Whenever you want to clear information (such as a query response) from the display.

Press:



Display Editing

The **Back Space** key allows you to edit parts of a command string while entering the string or when the string is recalled (discussed later). For alpha parameters or command headers, pressing the **Back Space** key once erases the entire parameter or header. For commas, spaces, and numeric parameters, only one character is erased each time you press **Back Space**. For example, Press:

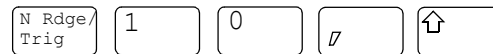

The display shows:

NRDGS 10, LINE ■■

By pressing the **Back Space** key once, the entire second parameter (LINE) is erased. The display shows:

NRDGS 10, ■■

Now by pressing **Back Space** once, the comma is erased. Pressing **Back Space** two more times erases both numeric characters (10). At this point, you can reenter the first parameter using the numeric keypad and the second parameter using the **Menu Scroll** keys. Press the **Enter** key to execute the edited command.

Viewing Long Displays

When entering commands containing more than 16 characters, the previously entered characters are scrolled off the left side of the display to make room for those being entered. The **Display/Window** keys (left and right arrow keys) allow you to view the entire line by scrolling it left or right. The **Display/Window** keys can also be used to view long strings such as error messages, the calibration string (CALSTR? command), and user-defined key definitions (discussed later). For example.

Press:

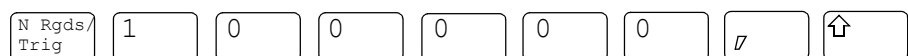

The display shows:

DGS 100000, LINE █

By pressing the left arrow key, you can view the first part of the command while scrolling the last part off the right side of the display. Now, by pressing the right arrow key, you can view the last part of the command and scroll the first part off the left side of the display.

Note Think of the display as a window you can move to the left or right using the arrow keys.

MORE INFO Display

In addition to scrolling the display left and right, the **Display/Window** keys allow you to view additional display information when the display's **MORE INFO** annunciator is illuminated. For example, access and execute the SETACV RNDM command from the alphabetic command menu. Now press the front panel **ACV** key. Notice that the multimeter's **MORE INFO** annunciator is illuminated. This means there is more information available than is being displayed.

Press:



The present AC voltage measurement method (SETACV RNDM) is displayed. At this point, reset the multimeter to return it to the power-on state by pressing:



Digits Displayed

When the multimeter is displaying readings, you can vary the number of digits it displays. In the power-on state, the display is showing 7.5 digits although the multimeter is resolving 8.5 digits. To display all 8.5 digits.

Press:

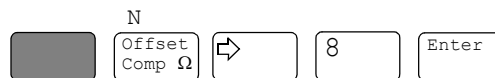

Note The display's leftmost digit (referred to as a 1/2 digit) is implied when you are specifying display digits.

The NDIG command only masks digits from the display. It does not affect readings sent to reading memory or transferred over the GPIB bus. Also, you cannot view more digits than are being resolved by the multimeter.

Recall You can easily recall the last executed command without repeating the command entry process.
Press:



The display will show the last command executed. (You cannot recall commands that are executed immediately such as **Reset** or **DCV**, or any command that contained the calibration security code.) By repeating the above keystrokes, you can recall previously executed commands. After recalling the desired command, you can modify it (see "Display Editing" earlier in this section) and execute it by pressing **Enter**.

Operating from Remote

This section shows you the fundamentals of operating the multimeter from remote. This includes reading and changing the GPIB address, sending a command to the multimeter, and retrieving data from the multimeter.

Input/Output Statements

The statements used to operate the multimeter from remote depend on the computer and its language. In particular, you need to know the statements the computer uses to input and output information. For example, the input statements for the Hewlett-Packard Series 200/300 BASIC language are:

ENTER or TRANSFER

The output statement is:

OUTPUT

Read your computer manuals to find out which statements you need to use. The examples in this manual use Hewlett-Packard Series 200/300 BASIC language.

Reading the GPIB Address

Before you can operate the multimeter from remote, you need to know its GPIB address (factory setting = 22). To check the address.
Press:



A typical display is:

ADDRESS 22 ■■

The displayed response is the device address. When sending a remote command, you append this address to the GPIB interface's select code (normally 7). For example, if the select code is 7 and the device address is 22, the combination is 722.

Changing the GPIB Address

Every device on the GPIB bus must have a unique address. If you need to change the multimeter's address, access the ADDRESS command from the command menu (MENU keys), with the display showing:

ADDRESS █

You can enter the new address. For example.
Press:

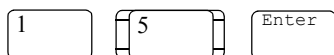

You have now changed the address to 15. If you want to change the address back to 22, repeat the above procedure (or use the **Recall** key) and specify 22 instead of 15.

Sending a Remote Command

To send the multimeter a remote command, combine the computer's output statement with the GPIB select code, the device address, and finally, the multimeter command. For example, to make the multimeter beep, send:

```
OUTPUT 722; "BEEP"
```

Notice the display's **REM** and **LSTN** annunciators are illuminated. This means the multimeter is in the remote mode and has been addressed to listen (receive a command).

Getting Data from the Multimeter

The multimeter is capable of outputting readings and responses to query commands. As an example, have the multimeter generate a response to a query command by sending:

```
OUTPUT 722; "ID?"
```

When you send a query from remote, the multimeter does not display the response as it did when you executed the command from its front panel. Instead, the multimeter sends the response to its output buffer. The output buffer is a register that holds a query response or a single reading until it is read by the computer or replaced by new information. Use the computer's input statement to get the response from the output buffer. For example, the following program reads the response (3458A) and prints it.

```
10 ENTER 722;A$
20 PRINT A$
30 END
```

The same technique allows you to get readings from the multimeter. Whenever the multimeter is making measurements and you have not enabled reading memory (reading memory is discussed in Chapter 4), you can get a reading by running the following program.

```
10 ENTER 722;A
20 PRINT A
30 END
```

The Local Key

When you press a key on the multimeter's keyboard while operating from remote, the multimeter does not respond. This is because the multimeter is in the remote mode (as indicated by the display's **REM** annunciator) and is ignoring all but the **Local** key. To return the multimeter to local mode.

Press:



Chapter 3

Disassembly/Assembly Procedures and Parts List

Introduction

This section contains the 3458A Covers and Printed Circuit Assemblies Disassembly/Assembly procedures. Also included is the 3458A Parts Lists and listings of printed circuit board assemblies.

WARNING Only personnel with knowledge of electronic circuitry and an awareness with the hazards involved should remove and install any printed circuit board assemblies.

Caution To prevent equipment circuit damage, always remove the ac line power cord before removing or replacing any assembly. To prevent electrostatic discharge (ESD) damage to ICs, always observe anti-static techniques when assemblies are handled or serviced.

Static Handling

Static electricity is a familiar phenomenon which, except for an occasional shock, doesn't seem very serious. However, it has been proven that in the electronics industry electrostatic discharge (ESD) is a major cause of component failure. In many cases, the component damaged may not immediately fail, causing low instrument reliability and future repairs. ESD damage can occur at static levels below human perception. It has also been shown that ESD can affect both passive and active devices.

The following guidelines are the minimum requirements for a static safe service environment.

- The workbench should be equipped with a conductive table mat. The mat should be grounded to earth ground through a 1 M ohm resistor. The mat should be equipped with at least one swivel connector for connecting wrist straps.
- All service and handling personnel should wear a conductive wrist strap in contact with bare skin. This strap should be connected to the swivel connector on the conductive table mat through a 1 M ohm resistor.
- All metal equipment at a workstation must be grounded. This includes soldering irons, solder removers, shelving, and equipment stands.

- Only one common ground should be provided at the workstation.
- The workstation should be kept free of nonconductors. No common plastics, polybags, cardboard, cigarette or candy wrappers should be allowed. There should not be rugs or carpet on the floor, shelving, or bench top.
- Only proper containers should be used for shipping, storing or transporting assemblies. This is required on any assembly shipped to Agilent Technologies for repair or replacement.

Clean Handling

Due to the accuracy of the 3458A, use the following clean handling techniques when removing/installing printed circuit board assemblies.

- Handle the assemblies only by their edges.
- Be sure to place them on a clean workbench away from dirty or dusty conditions.

Printed Circuit Assembly Identification

The printed circuit assemblies within the 3458A Multimeter are identified by the part number of the printed circuit board and the engineering revision code (ERC). These two sequences of numbers are used to exactly identify the electrical characteristics of the printed circuit board. In any correspondence concerning a particular printed circuit board, it is important to accurately identify the board configuration. This is done by using the board part number, followed by the engineering revision code (ERC) on the board. For example:

03458-66505-2825

would identify a particular printed circuit board in the 3458A. The board part number is 03458-66505 and the ERC is 2825.

Board Part Number

The Agilent Technologies part number of a printed circuit board is etched on the board. This is a ten-digit number, separated by a hyphen into two groups of five digits. The first five digits identify the model number or accessory number of which the printed circuit board is a part. The last five digits are a unique part number identifying the printed circuit board.

Engineering Revision Code

On the Engineering Revision Code (ERC) label, the four-digit code is in the form of YYWW, where YY represents the last two digits of the year minus 60 and WW is the week code. For example, an Engineering Revision Code of 2825 would identify a change made in the 25th week of 1988.

The ERC number is updated whenever a change is made to the assembly. This change may be a printed circuit board revision, a component change, or

a revised test and assembly procedure. The ERC should be checked against schematics, component locator diagrams, and parts lists to ensure compatibility. ERCs with values lower than those noted on the schematics, component locator diagrams, and parts lists are described in a backdating section. ERCs with a value higher than those noted will be covered by a manual change sheet, manual update, or manual revisions.

NOTE

The label numbers in Figures 5 to 10 show the order of cover removal. Use reverse order for installation.

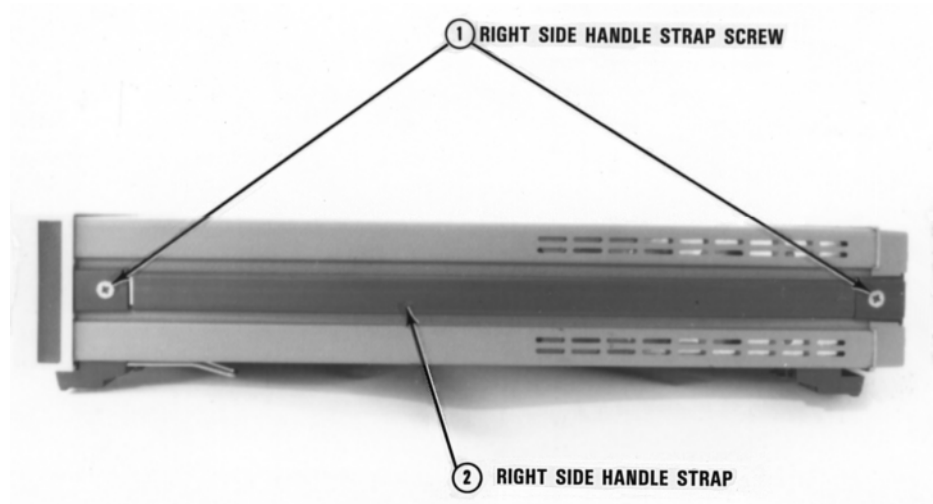

Figure 6. Right Side Handle Removal/Installation

Covers Removal/Installation Procedures

The following procedures show how to remove the top/bottom covers and shields on the 3458A. Removal of the covers and shields are required to replace the printed circuit board assemblies.

Tools Required

You need:

1. #1 Pozidriv screwdriver
2. #TX15 Torx driver
3. #TX10 Torx driver

Covers Removal Procedure

Do the following:

1. Remove all connections to the 3458A.
2. Remove ac power from the 3458A.
3. Refer to Figure 6. Turn the instrument so its right side (as seen from the front) faces you.
4. Use the #1 Pozidriv to remove the right side handle strap screws. Then remove the strap.

5. Refer to Figure 7. Turn the instrument so its left side faces you.

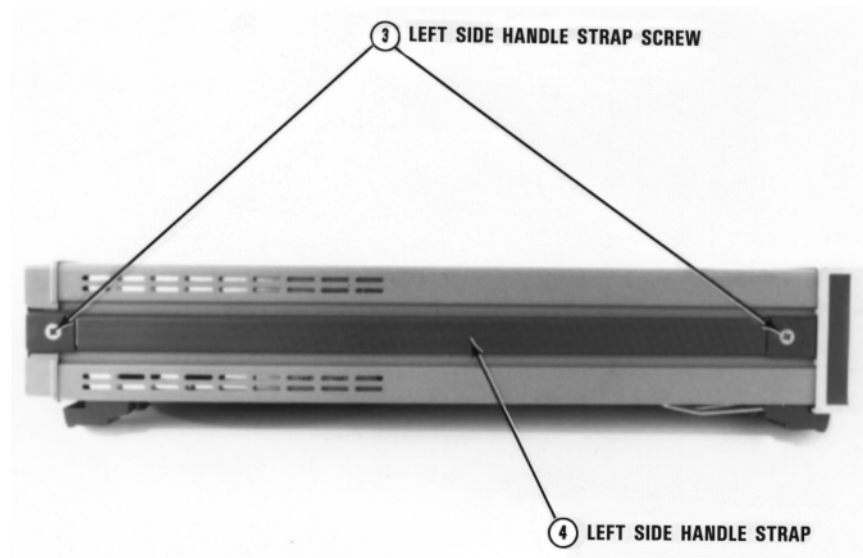

Figure 7. Remove/Install Left Side Handle

6. Use the #1 Pozidriv to remove the left side handle strap screws. Then remove the strap.
7. Refer to Figure 8. Use the #TX10 Torx driver to remove both or either the top and bottom cover ground screws, depending on which cover is to be removed.
8. Refer to Figure 9. Turn the instrument so its rear faces you.
9. Use the #TX15 Torx driver to remove the four rear bezel screws. Then remove the rear bezel.
10. If you do not wish to remove the top cover, continue with step 12.
11. To remove the top cover, pull the cover toward the rear until it clears the front panel. Then slide it forward and away from the instrument.
12. If you do not wish to remove the bottom cover, continue with step 14.
13. Turn the 3458A over so its top sits on your workbench. To remove the bottom cover, pull the cover toward the rear until it clears the front panel. Then slide it forward and away from the instrument. Leave the instrument in its present position.
14. If you do not wish to remove the bottom shield, continue with step 16.
15. Refer to Figure 10. Use the #TX10 Torx driver to remove the bottom shield screw. Then remove the shield. Pull the shield toward the rear of the instrument until the shield retainers line up with the slots in the shield. Lift the shield off.

16. If you do not wish to remove the top shield, continue with step 19.

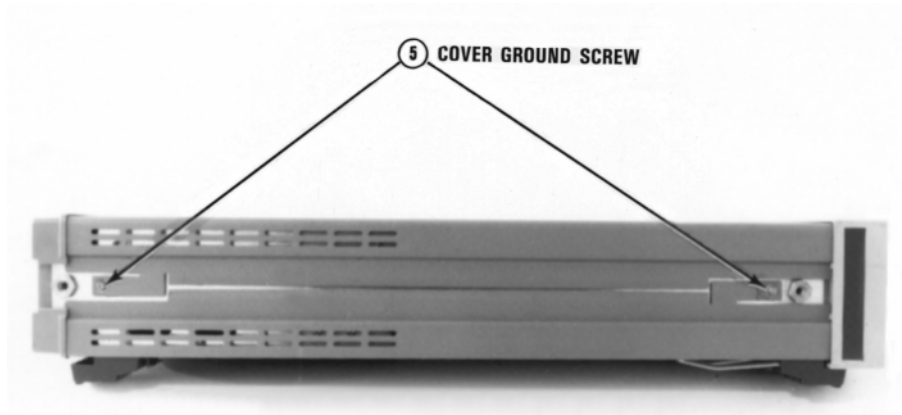

Figure 8. Remove/Install Cover Ground Screws

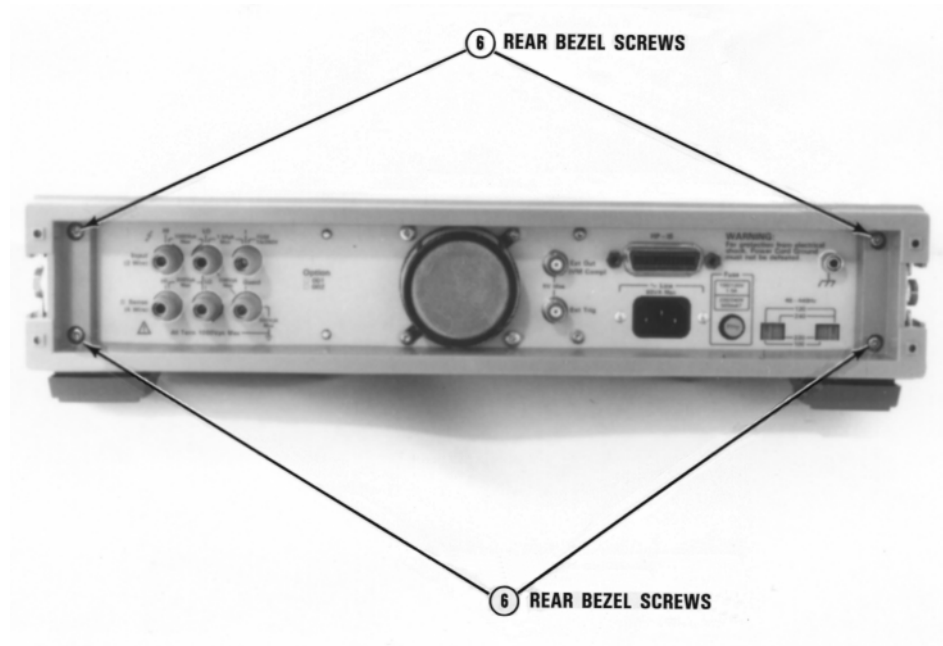

Figure 9. Remove/Install Rear Bezel

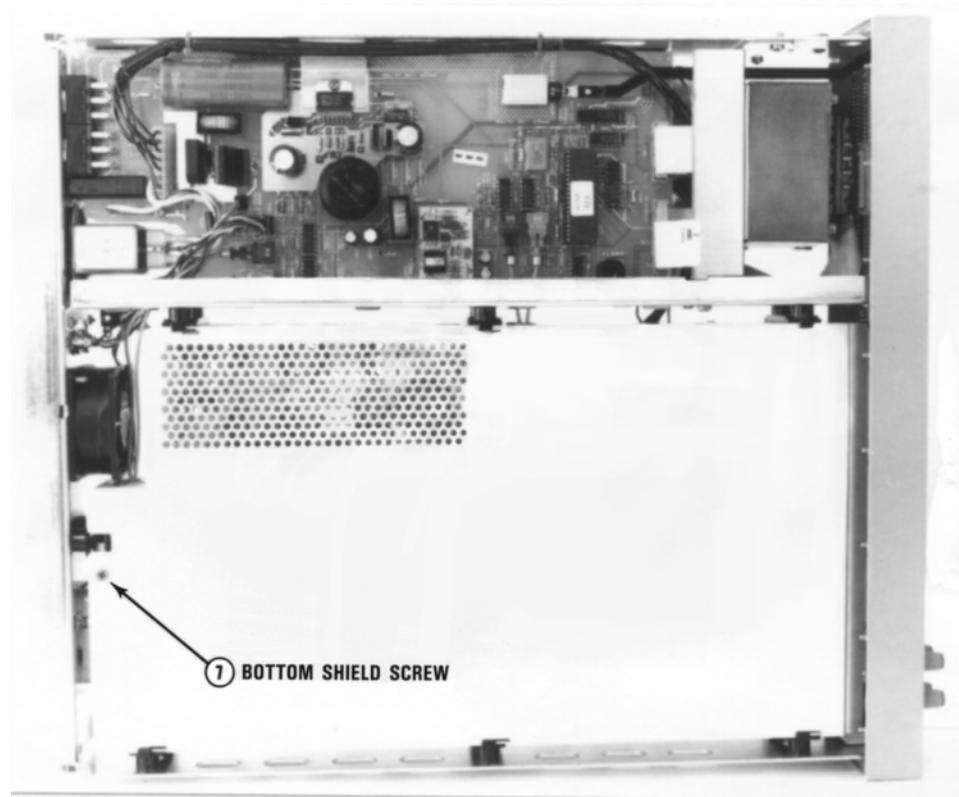

Figure 10. Remove/Install Bottom Shield Screw

17. Refer to Figure 11. Turn the instrument over so its bottom sits on your workbench.
18. Use the #TX10 Torx driver to remove the top shield screw. Then remove the shield. Pull the shield toward the rear of the instrument until the shield retainers line up with the slots in the shield. Lift the shield off.
19. Refer to the appropriate procedures in this section to remove the printed circuit board assembly.

Covers Installation Procedure

Do the following:

1. Remove all connections to the 3458A.
2. If installing the top shield is not required, continue with step 6.
3. Refer to Figure 11. Turn the instrument over so its bottom sits on your workbench.
4. Line up the slots on the top shield with the shield retainers. Then push the shield toward the front of the instrument until the shield screw hole

lines up with the hole in the chassis. Use the #TX10 Torx driver to reinstall the shield screw.

5. If installing the bottom shield is not required, continue with step 9.
6. Refer to Figure 10. Turn the instrument over so its top sits on your workbench.

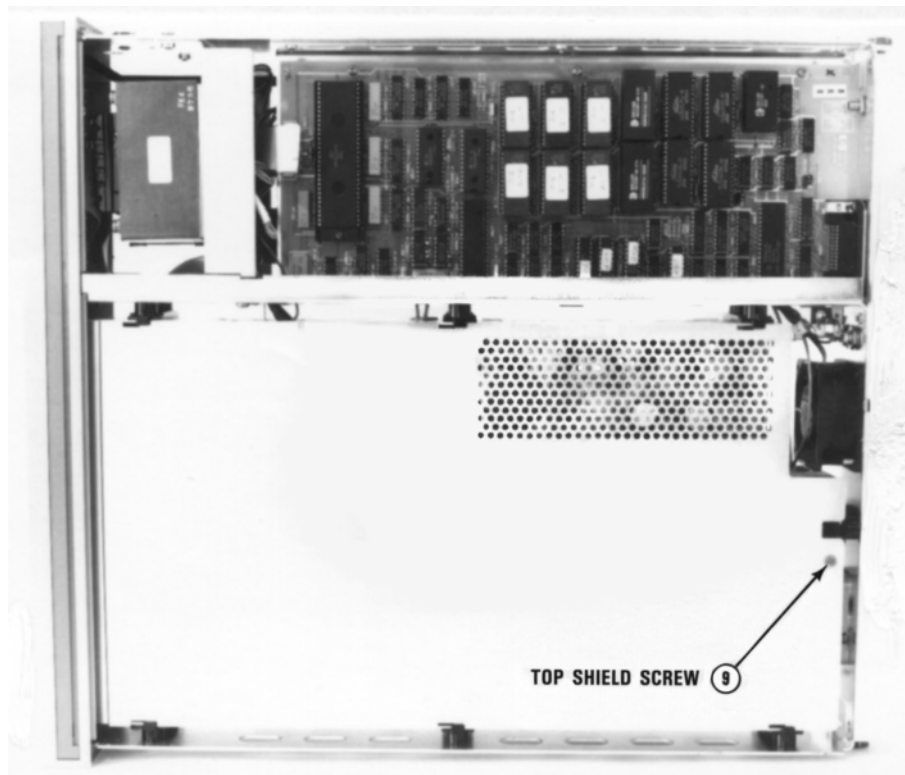

Figure 11. Remove/Install Top Shield Screw

7. Remove ac power from the 3458A.
8. Line up the slots on the bottom shield with the shield retainers. Then push the shield toward the front of the instrument until the shield screw hole lines up with the screw hole in the chassis. Use the #TX10 Torx driver to reinstall the shield screw.
9. If installing the bottom cover is not required, continue with step 11.
10. Install the bottom cover by placing it over the chassis with the front of the cover just clearing the front panel. Then push the cover toward the front of the instrument into the front panel bezel.
11. If installing the top cover is not required, continue with step 14.

12. Turn the 3458A over so the bottom sits on your workbench.
13. Install the top cover by placing it over the chassis with the front of the cover just clearing the front panel. Then push the cover toward the front of the instrument into the front panel bezel.
14. Refer to Figure 9. Turn the instrument so its rear faces you.
15. Reinstall the rear bezel. Use the #TX15 Torx driver to reinstall the four rear bezel screws.
16. Refer to Figure 8. Turn the instrument so its left side faces you. Use the #TX10 Torx driver to reinstall the top and/or bottom cover ground screws.

WARNING For safety purposes and proper operation, it is imperative that the cover grounding screws be reinstalled.

17. Refer to Figure 7. Reinstall the left side handle strap. Use the #1 Pozidriv to reinstall the side handle strap screws.
18. Refer to Figure 6. Turn the instrument so its right side faces you.
19. Reinstall the right side handle strap. Use the #1 Pozidriv to reinstall side handle strap screws.
20. Your instrument is now ready for use. Agilent Technologies suggests that after you apply power that you perform an automatic calibration on the instrument. To do this, use the "ACAL ALL" command.

Assemblies Removal/Installation Procedures

Table 6 lists all 3458A printed circuit board assemblies and assembly locations in the instrument. The assembly locations are also shown in Figure 12 and Figure 13.

Table 6. 3458A Assemblies Locations

Ref Desig	Part Number	Assembly Description	Location in Instrument
A1	03458-66501	DC Circuitry	Inguard/Top
A2	03458-66502	AC Circuitry	Inguard/Bottom
A3	03458-66503	A/D Converter and Inguard Logic	Inguard/Bottom
A4	03458-66504	Inguard Power Supply	Inguard/Bottom
A5	03458-66505	Outguard Controller	Outguard/Top
A5	03458-66515	Outguard Controller (Opt 001)	Outguard/Top
A6	03458-66506	Outguard Power Supply	Outguard/Bottom
A7	03458-66507	Display Logic	Front Panel
A9	03458-66509	DC Reference	Inguard/Top
A9	03458-66519	DC Reference (Opt 002)	Inguard/Top
A10	03458-66510	Front/Rear Switch	Inguard/Top

Tools Required

You need:

1. #1 Pozidriv screwdriver
2. #TX15 Torx driver
3. #TX10 Torx driver
4. 7 millimeter nut driver (for Outguard Controller assembly only)
5. Small flat bladed screwdriver (for Display Logic assembly only)
6. Large screwdriver (e.g., #2 Pozidriv; for Display Logic assembly only)

DC Circuitry Assembly Removal/Installation Procedures

The following procedures show how to remove and install the DC Circuitry Printed Circuit Board Assembly.

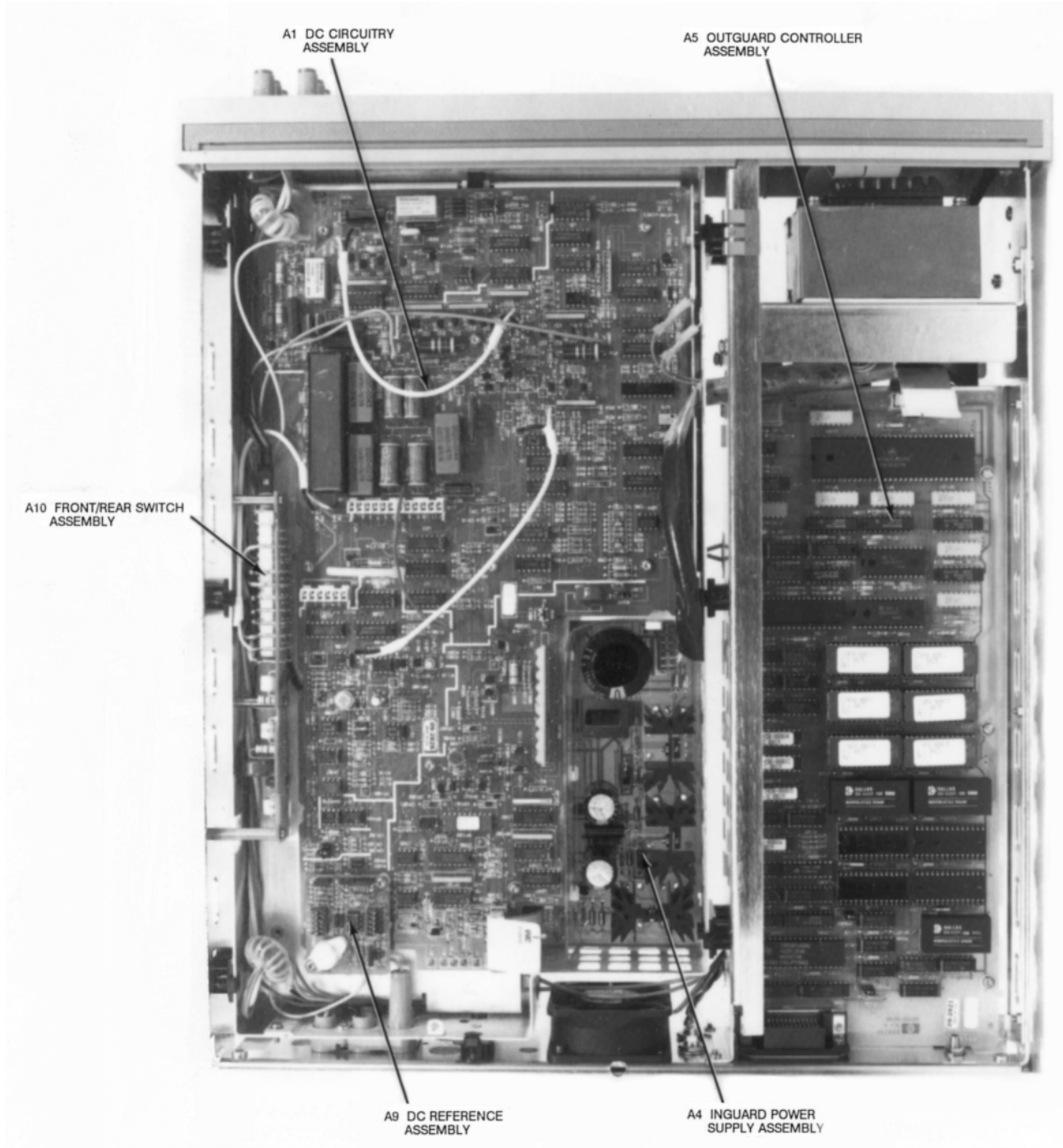

Figure 12. Assembly Locations (Top of Instrument)

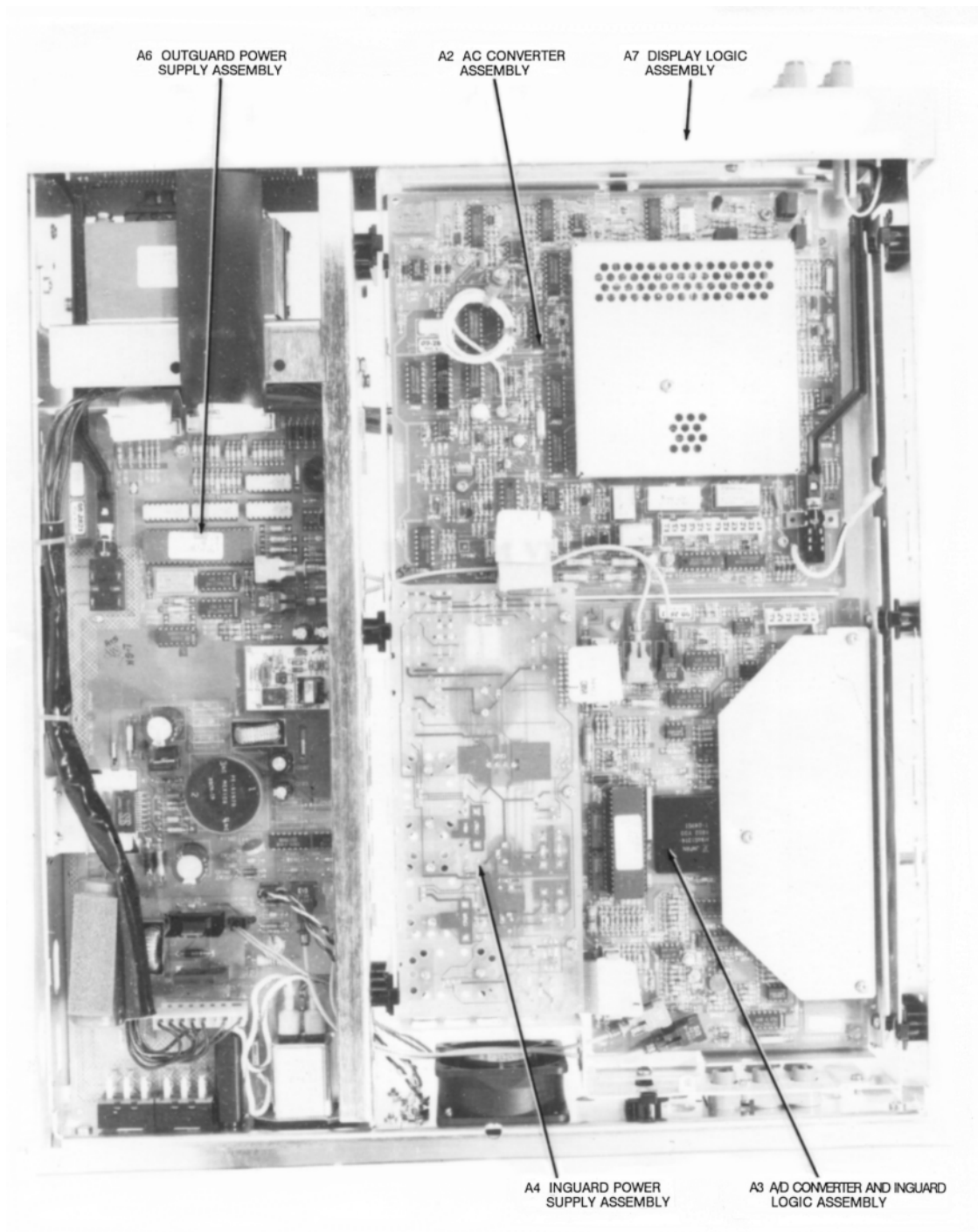

Figure 13. Assembly Locations (Bottom of Instrument)

Refer to Figure 14 for the following procedures.

Removal Procedure

1. Use the Covers Removal Procedure in this section of the manual to remove the 3458A top cover and top shield. It is not necessary to remove the bottom cover and bottom shield.

2. Set the 3458A on your workbench with the top facing you.
3. Unplug the following wires and cables. Unless otherwise noted, all wires and cables are unplugged from the DC Circuitry assembly.
 - a. Blue wire from the metal inguard shield. This wire is not plugged into the DC Circuitry assembly, but must be unplugged to remove the assembly. Move the wire out of the way.
 - b. Grey wire from the metal inguard circuit ground. This wire is not plugged into the DC Circuitry assembly, but must be unplugged to remove the assembly. Move the wire out of the way.
 - c. Yellow wire from P202. Move the wire out of the way.
 - d. Orange wire from P7. Move the wire out of the way.
 - e. Grey wire from P6. Move the wire out of the way.
 - f. Black and white wires from P8 and P9, respectively. The black and white wires form a white cable. Move the cable out of the way.
 - g. Grey 20 pin cable from P3. Move the cable out of the way.
4. Use the #TX 10 Torx driver to remove the two screws from the DC Reference assembly.
5. Use the #TX10 Torx driver to remove the eight screws from the DC Circuitry assembly.
6. Use the plastic board extractor on the DC Circuitry board to unplug the board from the inguard chassis. Then completely remove the board.

Installation Procedure

1. Line up the DC Circuitry board with the connector in the inguard chassis. Plug the board into the connector.
2. Use the #TX10 Torx driver to install the eight screws on the DC Circuitry assembly.
3. Use the #TX10 Torx driver to install the two screws on the DC Reference assembly.
4. Plug in the following wires and cables:
 - a. Locate the blue wire connected to the power transformer. Plug the wire into the metal inguard shield.
 - b. Locate the grey wire connected to the power transformer. Plug the wire into the metal inguard circuit ground.

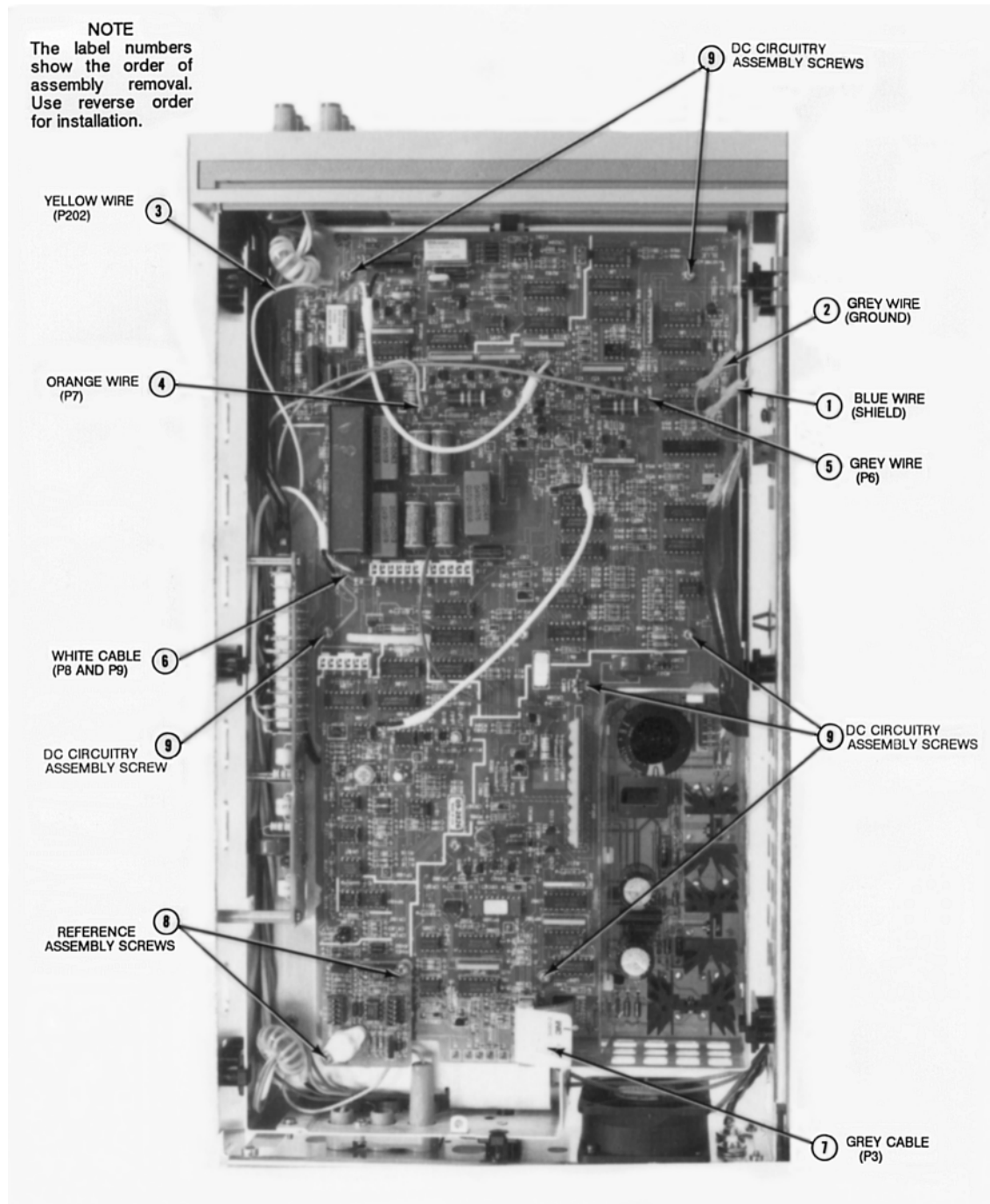

Figure 14. DC Circuitry Assembly Removal/Installation

- c. Locate the yellow wire connected to the Front/Rear Switch assembly. Plug it into P202 on the DC Circuitry assembly.
- d. Locate the orange wire connected to the Front/Rear Switch assembly. Plug it into P7 on the DC Circuitry assembly.

- e. Locate the grey wire connected to the Front/Rear Switch assembly. Plug it into P6 on the DC Circuitry assembly.
 - f. Locate the white cable with the white and black wires connected to the Front/Rear Switch assembly. Plug the white and black wires into P8 and P9, respectively. P8 and P9 are on the DC Circuitry assembly.
 - g. Locate the grey 20-pin cable connected to the A/D Converter and Inguard Logic assembly. Line up the cable plug with socket P3 on the DC Circuitry assembly. Then plug the cable all the way in.
5. Use the Covers Installation Procedure in this section of the manual to install the 3458A top cover and top shield.

DC Reference Assembly Removal/Installation Procedures

The following procedures show how to remove and install the DC Reference Printed Circuit Board Assembly.

Refer to Figure 14 for the following procedures.

Removal Procedure

1. Use the Covers Removal Procedure in this section of the manual to remove the 3458A top cover and top shield. It is not necessary to remove the bottom cover and bottom shield.
2. Set the 3458A on your workbench with the top facing you.
3. Use the #TX10 Torx driver to remove the two screws from the DC Reference assembly.
4. Unplug and remove the board from the DC Circuitry assembly.

Installation Procedure

1. A top and bottom cover needs to be installed over the reference device located on the DC Reference assembly. To install the covers, place one cover over the top of the device and another on the bottom side of the DC Reference assembly printed circuit board. Use your fingers to hold the covers in place. Then line up the screw holes in the covers with the screw holes on the printed circuit board. The covers should now completely enclose the reference device.
2. Line up the DC Reference board with the connectors on the DC Circuitry assembly. Hold the covers over the reference device in place while installing the DC Reference assembly. Then plug the board all the way into the connectors.
3. Use the #TX10 Torx driver to install the two screws on the DC Reference assembly.
4. Use the Covers Installation Procedure in this section of the manual to install the 3458A top cover and top shield.

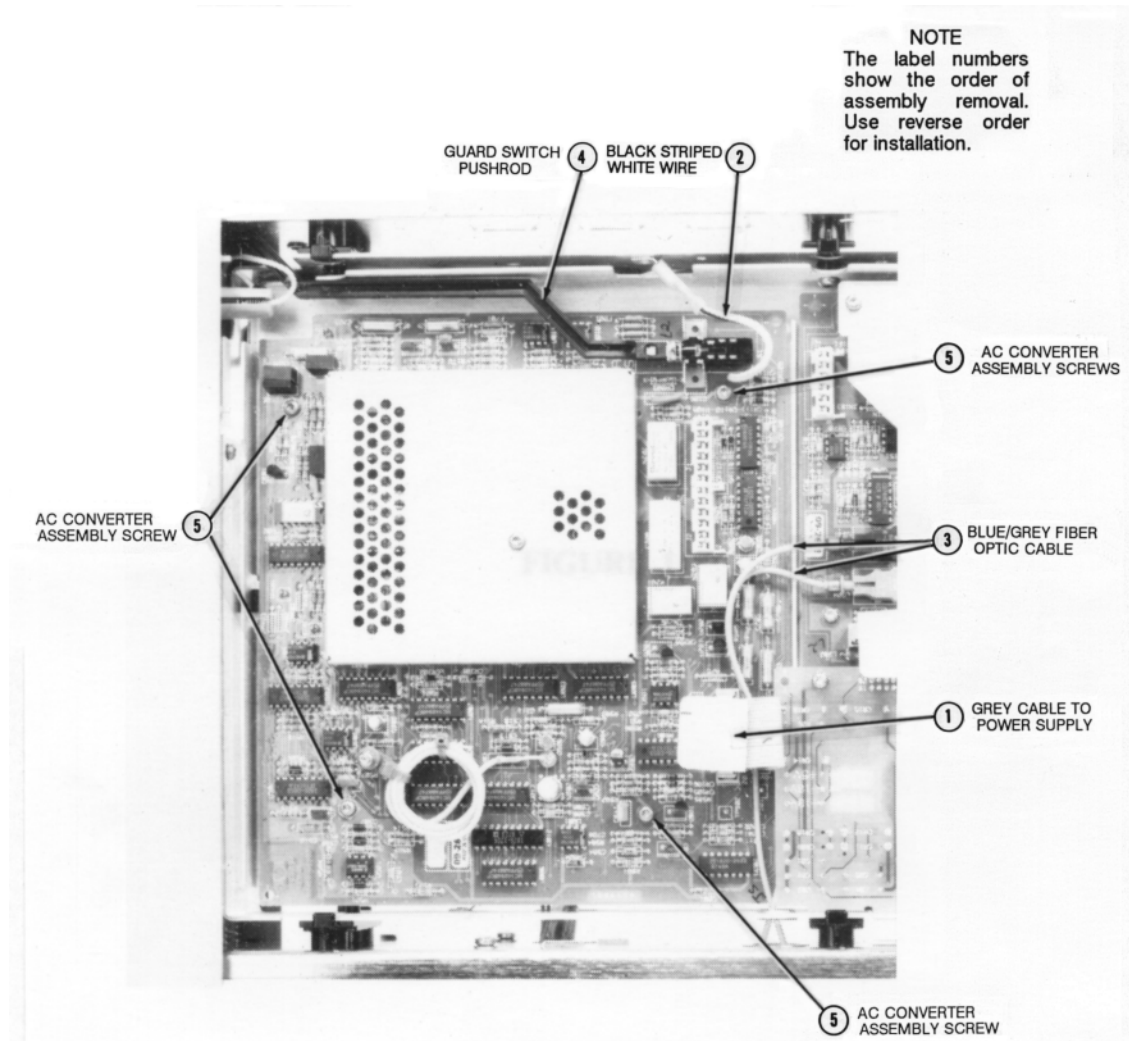

Figure 15. AC Converter Assembly Removal/Installation

AC Converter Assembly Removal/Installation Procedures

The following procedures show how to remove and install the AC Converter Printed Circuit Board Assembly.

Refer to Figure 15 for the following procedures.

Removal Procedure

1. Use the Covers Removal Procedure in this section of the manual to remove the 3458A bottom cover and bottom shield. It is not necessary to remove the top cover and top shield.
2. Set the 3458A on your workbench with the bottom facing you.
3. Unplug the grey 20-pin cable from the AC Converter assembly.
4. Unplug the black striped white wire from the metal inguard chassis.

5. For easier removal of the AC Converter assembly, you may wish to unplug and lay aside both the blue and grey fiber optic cables connecting the A/D Converter and Inguard Logic assembly to the outguard.
6. Remove the pushrod from the Guard switch. You may need to pry the pushrod loose with a small flat blade screwdriver. Then completely remove it from the rear of the front panel.
7. Use the #TX10 Torx driver to remove the four screws from the AC Converter assembly.
8. Unplug and remove the AC Converter board from the inguard chassis.

Installation Procedure

1. Line up the AC Converter board with the connector in the inguard chassis. Then plug the board all the way into the connector.
2. Use the #TX 10 Torx driver to install the four screws on the AC Converter assembly.
3. Locate the grey 20-pin cable connected to the Inguard Power Supply assembly. Line up the cable plug with the socket on the AC Converter assembly. Then plug the cable all the way in.
4. Plug the black striped white wire from the AC Converter into the metal inguard chassis.
5. Plug in both the blue and grey fiber optic cables into the A/D Converter and Inguard Logic assembly, if previously unplugged.
6. Guide the Guard switch pushrod through the rear of the front panel's access hole. Then align the pushrod with the Guard switch shaft and push it all the way onto the shaft.
7. Use the Covers Installation Procedure in this section of the manual to install the 3458A bottom cover and bottom shield.

A/D Converter Assembly

Removal/Installation Procedures

The following procedures show how to remove and install the A/D Converter and Inguard Logic Printed Circuit Board Assembly.

Refer to Figure 16 for the following procedures.

Removal Procedure

1. Use the Covers Removal Procedure in this section of the manual to remove the 3458A bottom cover and bottom shield. It is not necessary to remove the top cover and top shield.
2. Set the 3458A on your workbench with the bottom facing you.
3. Locate the grey 20-pin cable that connects the A/D Converter and

Inguard Logic assembly to the Inguard Power Supply assembly.
Unplug this cable at the A/D Converter and Inguard Logic assembly.

4. Locate the grey 20-pin cable that connects the A/D Converter and Inguard Logic assembly to the DC Circuitry assembly. Unplug this cable at the A/D Converter and Inguard Logic assembly.
5. Unplug both sets (four cables) of the blue and grey fiber optic cables that connect the A/D Converter and Inguard Logic assembly to the Outguard Power Supply assembly.

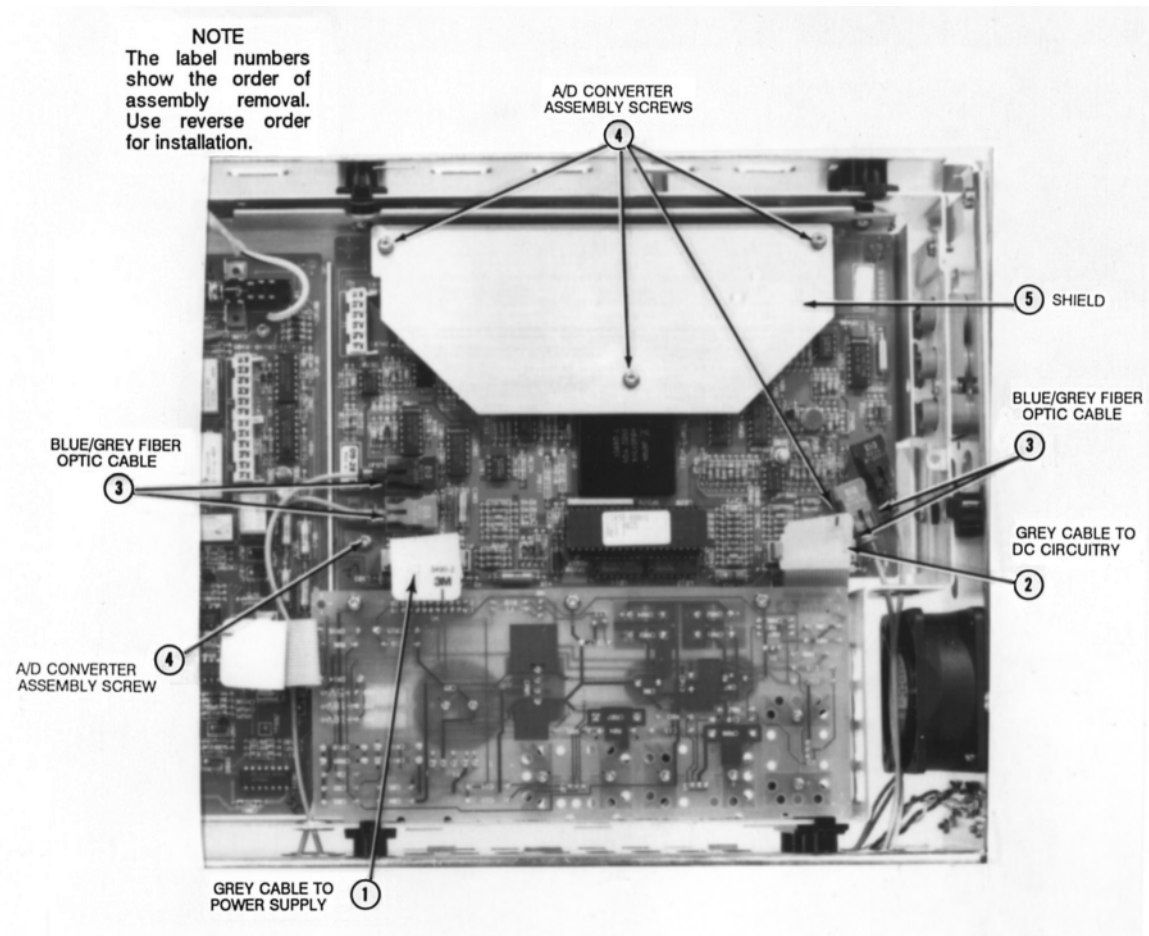

Figure 16. A/D Converter and Inguard Logic Assembly

6. Use the #TX10 Torx driver to remove the three screws on the shield and the two screws on the A/D Converter and Inguard Logic assembly. Then remove the shield.
7. Unplug and remove the A/D Converter and Inguard Logic board from the inguard chassis.

Installation Procedure

1. Line up the A/D Converter and Inguard Logic board with the

connector in the Inguard chassis. Then plug the board all the way into the connector.

2. Place the A/D Converter and Inguard Logic shield on the board. Then use the #TX10 Torx driver to install the three screws on the shield.
3. Locate the grey 20-pin cable connected to the Inguard Power Supply assembly. Line up the cable plug with the corresponding socket on the A/D Converter and Inguard Logic assembly. Then plug the cable all the way in.

NOTE

The label numbers in Figures 16 and 17 show the order assembly removal. Use reverse order for installation.

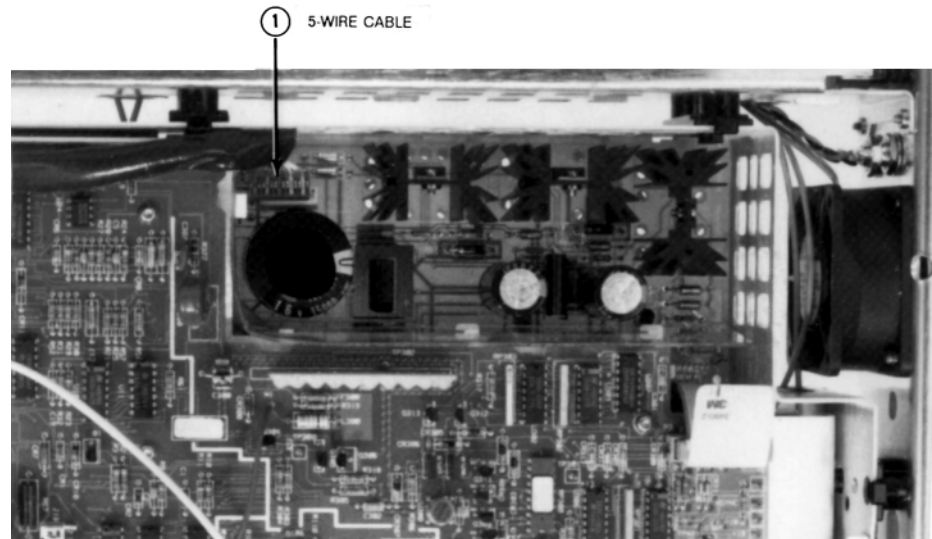

Figure 17. Remove/Install Transformer Cable on Inguard Power Supply

4. Locate the grey 20-pin cable connected to the DC Circuitry assembly. Line up the cable plug with the corresponding socket on the A/D Converter and Inguard Logic assembly. Then plug the cable all the way in.
5. Plug in both sets of the blue and grey fiber optic cables into the corresponding sockets on the A/D Converter and Inguard Logic assembly.
6. Use the Covers Installation Procedure in this section of the manual to install the 3458A bottom cover and bottom shield.

Inguard Power Supply Assembly Removal/Installation Procedures

The following procedures show how to remove and install the Inguard Power Supply Printed Circuit Board Assembly.

Removal Procedure

1. Use the Covers Removal Procedure in this section of the manual to remove the 3458A top/bottom covers and top/bottom shields.
2. Set the 3458A on your workbench with the top facing you.
3. Refer to Figure 17. Unplug the 5-wire cable from the Inguard Power Supply assembly. This cable is connected to the power transformer.
4. Refer to Figure 18 for the rest of this procedure.
5. Set the 3458A on your workbench with the bottom facing you.

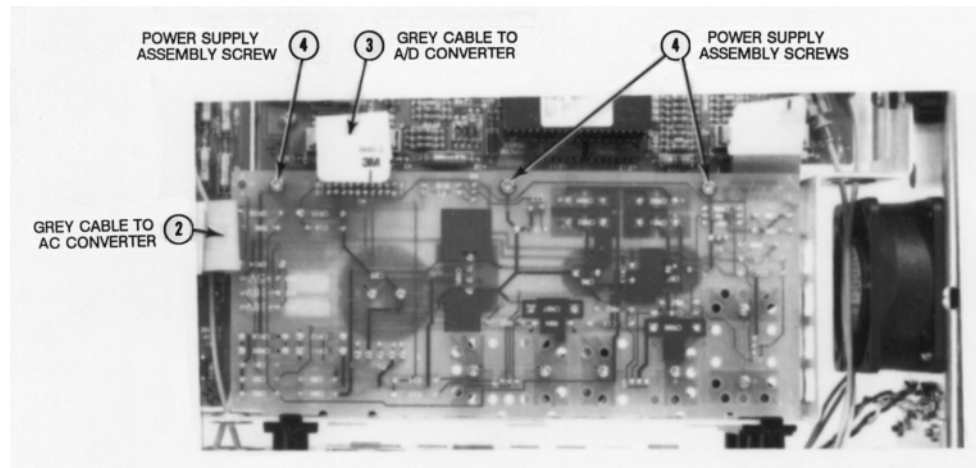

Figure 18. Inguard Power Supply Assembly Removal/Installation

6. Locate the grey 20-pin cable that connects between the A/C Converter assembly and Inguard Power Supply assembly. Unplug the cable at the power supply assembly.
7. Locate the grey 20-pin cable that connects between the A/D Converter assembly and Inguard Power Supply assembly. Unplug the cable at the power supply assembly, and Inguard Logic assembly.
8. Use the #TX 10 Torx driver to remove the three screws on the Inguard Power Supply assembly.
9. Push the Inguard Power Supply assembly toward the left, of the instrument (as seen from the front) until it clears the slot in the chassis. Then remove the board from the instrument.

Installation Procedure

1. Set the 3458A on your workbench with the bottom facing you.
2. Refer to Figure 18. Line up the Inguard Power Supply assembly with the slots in the chassis. Then push the board in.
3. Use the #TX10 Torx driver to install the three screws on the Inguard Power Supply board.
4. Locate the grey 20-pin cable connected to the AC Converter assembly. Line up the cable plug with the socket on the AC Converter assembly. Then plug the cable all the way in.
5. Locate the grey 20-pin cable connected to the A/D Converter and Inguard Logic assembly. Line up the cable plug with the socket on the A/D Converter and Inguard Logic assembly. Then plug the cable all the way in.

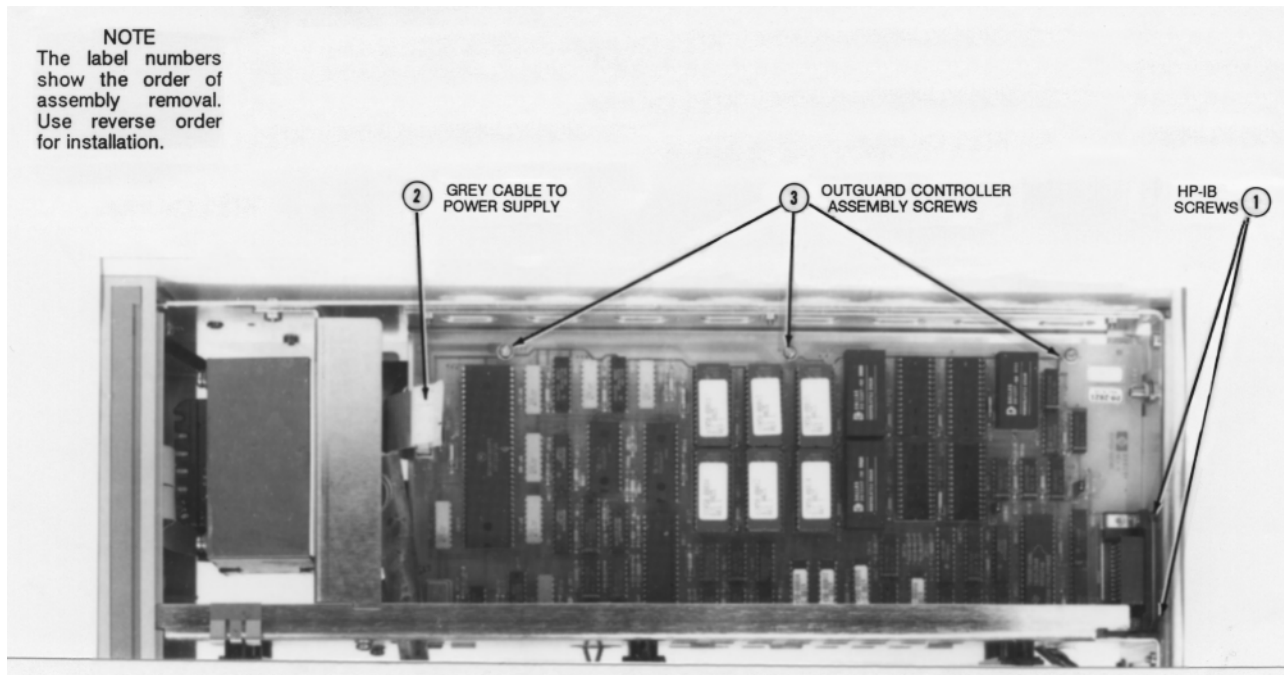

Figure 19. Outguard Controller Assembly Removal/Installation

6. Set the 3458A on your workbench with the top facing you.
7. Refer to Figure 17. Locate the cable connected to the power transformer. Line up the cable plug with the socket on the Inguard Power Supply assembly. Then plug the cable in.
8. Use the Covers Installation Procedure in this section of the manual to install the 3458A top/bottom covers and top/bottom shields.

Outguard Controller Assembly Removal/Installation Procedures

The following procedures show how to remove and install the Outguard Controller Printed Circuit Board Assembly.

Refer to Figure 19 for the following procedures.

Removal Procedure

1. Use the Covers Removal Procedure in this section of the manual to remove the 3458A top cover. It is not necessary to remove the bottom covers and the top/bottom shields.
2. Set the 3458A on your workbench with the top facing you.
3. Use a 7-millimeter nut driver to remove the two hex standoffs on the rear panel GPIB connector.
4. Locate the grey 20-pin cable that connects between the Outguard Controller assembly and Outguard Power Supply assembly. Unplug the cable at the controller assembly.
5. Use the #TX10 Torx driver to remove the three screws on the Outguard Controller assembly.
6. Push the board toward the front of the instrument, as far it will go, while the board is still laying down flat in the chassis.
7. Pull the outside edge of the board up. Do this until the inside edge of the board can be removed from the slots in the instrument chassis. Then pull the board completely out of the instrument.

Installation Procedure

1. Insert the Outguard Controller board into the slots in the chassis. Make sure the board is as far as possible toward the front of the instrument.
2. Place the rest of the board into the instrument until it lays down flat in the chassis. Then slide the board toward the rear of the instrument.
3. Use the #TX10 Torx driver to install the three screws on the Outguard Controller assembly.
4. Locate the grey 20-pin cable connected to the Outguard Power Supply assembly. Line up the cable plug with the socket on the Outguard Controller assembly. Then plug the cable in.
5. Use the 7-millimeter nut driver to install the two hex standoffs on the rear panel GPIB connector.
6. Use the Covers Installation Procedure in this section of the manual to install the 3458A top cover.

Outguard Power Supply Assembly Removal/Installation Procedures

The following procedures show how to remove and install the Outguard Power Supply Printed Circuit Board Assembly.

Refer to Figure 20 for the following procedures.

Removal Procedure

1. Use the Covers Removal Procedure in this section of the manual to remove the 3458A bottom cover. It is not necessary to remove the top cover and the top/bottom shields.
2. Set the 3458A on your workbench with the top facing you.
3. Pull the power switch pushrod off the ac power switch. You may need to pry the pushrod loose with a small screwdriver. Then remove the pushrod by pulling it out of the front panel from the rear.
4. Locate the grey 20-pin cable that connects the Outguard Power Supply assembly to the Main Controller assembly. Unplug this cable at the Outguard Power Supply assembly.
5. Locate the grey 26-pin cable that connects the Outguard Power Supply assembly to the Display assembly. Unplug this cable at the Outguard Power Supply assembly.
6. Locate the 8-pin cable that connects the Outguard Power Supply assembly to the power transformer. Unplug the cable from the power supply assembly. Move the cable so it lays on the outside of the outguard chassis.

NOTE
The label numbers show the order of assembly removal. Use reverse order for installation.

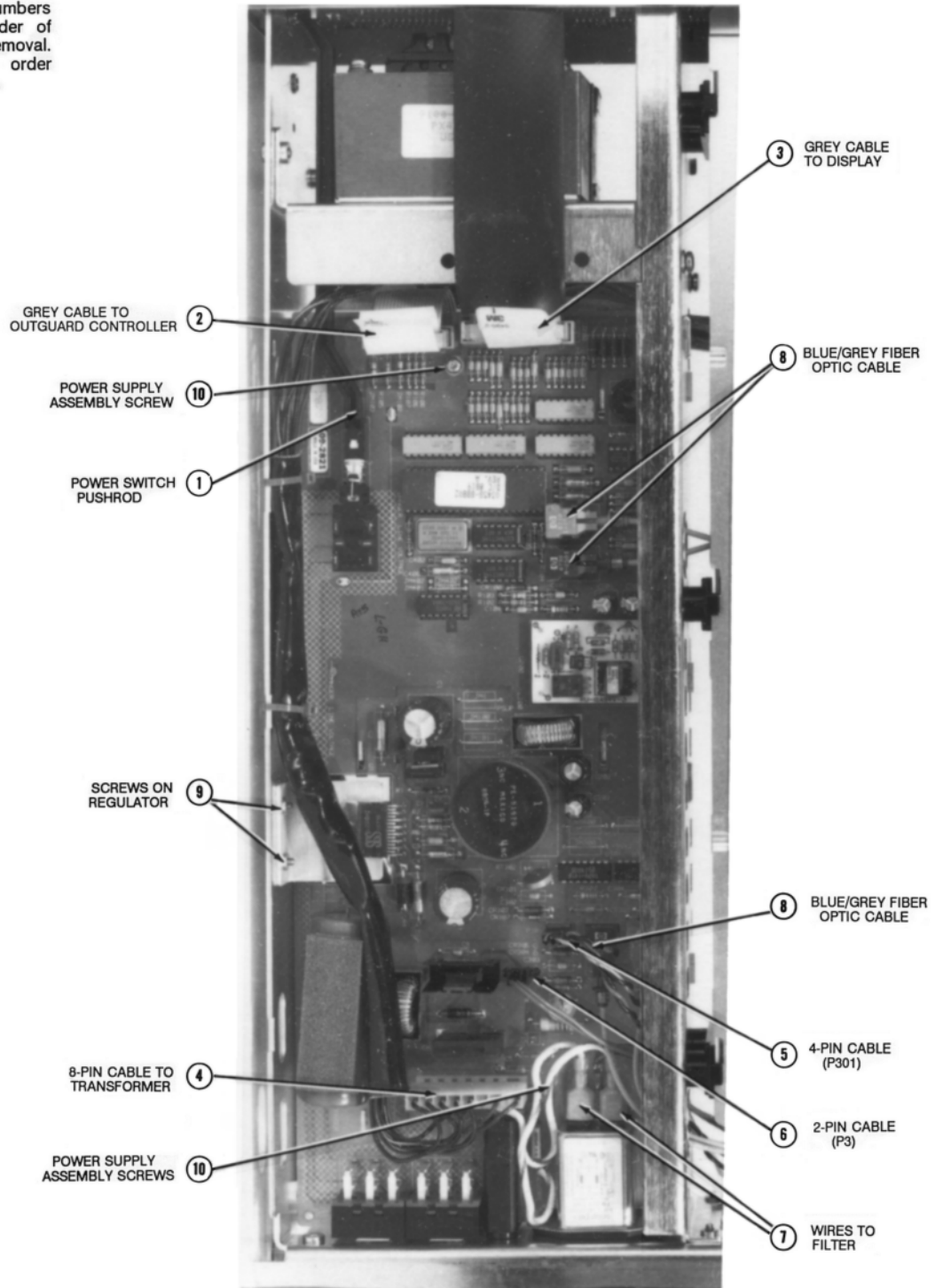

Figure 20. Outguard Power Supply Assembly Removal/Installation

7. Unplug the 4-pin cable from socket P301. This cable is connected to

the Ext Out and Ext Trig connectors on the rear panel. Move the cable out of the way.

8. Unplug the 2-pin cable from socket P3. This cable is connected to the fan. Move the cable out of the way.
9. Unplug the two black striped white wires from the AC power filter on the rear panel. Move the wires out of the way.
10. Unplug both sets (four cables) of the blue and grey fiber optic cables from the Outguard Power Supply Assembly. These cables connect the A/D Converter and Inguard Logic assembly to the Outguard Power Supply assembly. Move the cables out of the way.
11. Use the #TX10 Torx driver to remove the two screws on the power supply regulator heat sink.
12. Use the #TX10 Torx driver to remove the two screws on the Outguard Power Supply assembly.
13. Push the Outguard Power Supply board toward the front of the instrument, as far it will go. Then lift it up and away from the instrument.

Installation Procedure

1. Line up the slots on the Outguard Power Supply board with the sheet metal hook tabs on the chassis. Make sure the board is as far as possible toward the front of the instrument.
2. Place the board on top of the chassis. Then push it all the way to the rear of the instrument.
3. Use the #TX10 Torx driver to install the two screws on the power supply regulator heat sink.
4. Use the #TX10 Torx driver to install the two screws on the Outguard Power Supply assembly.
5. Plug in both sets of the blue and grey fiber optic cables into the corresponding sockets on the Outguard Power Supply assembly.
6. Locate the two black striped white wires. Connect the wire from "LINE" to the left terminal (as seen from the instrument's front) of the filter. Connect the "NEUTRAL" to the right terminal on the filter. These connections are also shown on a drawing on the Outguard Power Supply assembly. The drawing is located toward the rear of the board near ac line select switches.
7. Locate the 2-pin cable connected to the fan. Plug the cable into socket P3.
8. Locate the 4-pin cable connected to the Ext Out and Ext Trig

connectors on the rear panel. Plug the cable into socket P301.

9. Locate the 8-pin cable connected to the power transformer. Move the cable so it lays on top of the Outguard Power Supply assembly. Then plug the cable into socket P3.
10. Locate the grey 20-pin cable connected to the Outguard Controller assembly. Line up the cable plug with the socket on the Outguard Power Supply assembly. Then plug it all the way in.
11. Guide the power switch pushrod through the rear of the transformer shield's access hole. Then guide the pushrod through the rear of the front panel's access hole. Align the pushrod with the ac power switch shaft and push it onto the shaft.

NOTE

The label numbers in Figure 20 and 24 show the order of assembly removal. Use reverse order for installation.

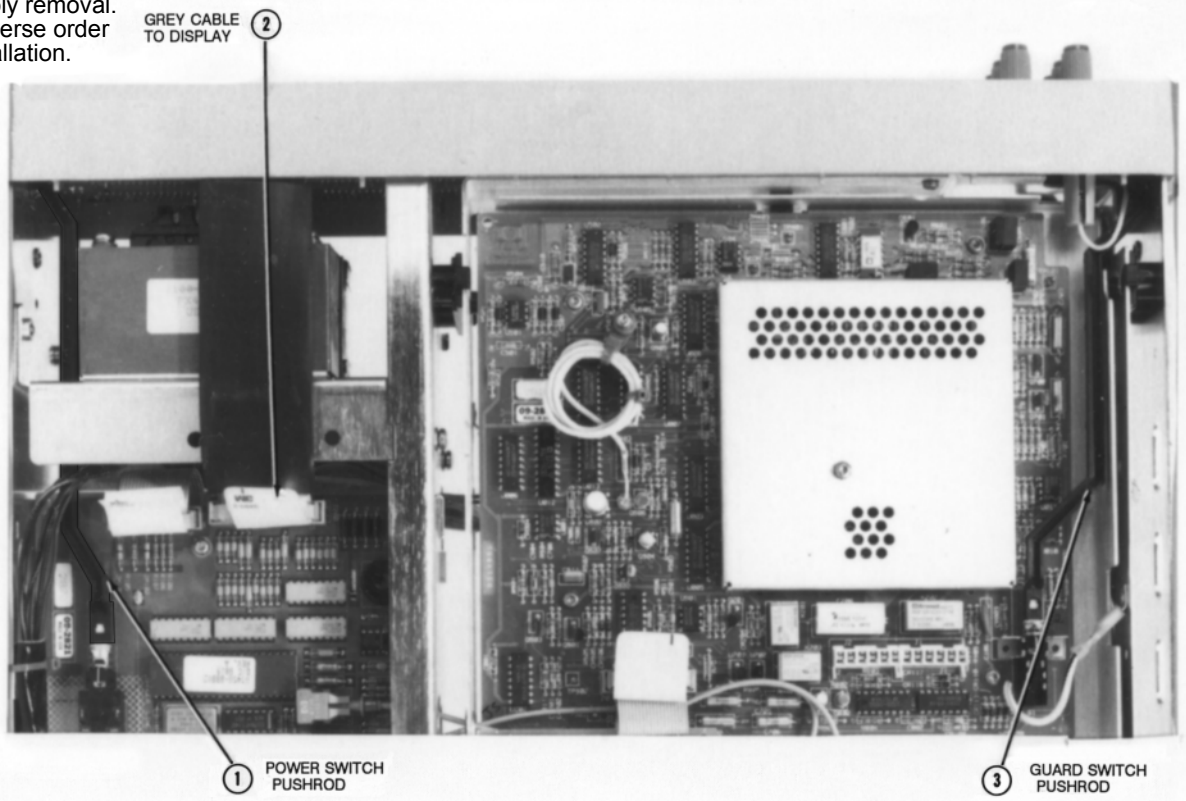

Figure 21. Guard and Power Pushrods, and Display Cable Locations

12. Use the Covers Installation Procedure in this section of the manual to install the 3458A bottom cover.

Display Logic Assembly Removal/Installation Procedures

The following procedures show how to remove and install the Display Logic Board Assembly.

Removal Procedure

1. Use the Covers Removal Procedure in this section of the manual to remove the 3458A top/bottom covers and top/bottom shields.
2. Set the 3458A on your workbench with the bottom facing you.
3. Refer to Figure 21. Do the following:
 - a. Locate and pull the power switch pushrod off the power switch. You may need to pry the pushrod loose with a small screwdriver. Then remove the pushrod by pulling it out of the front panel from the rear.

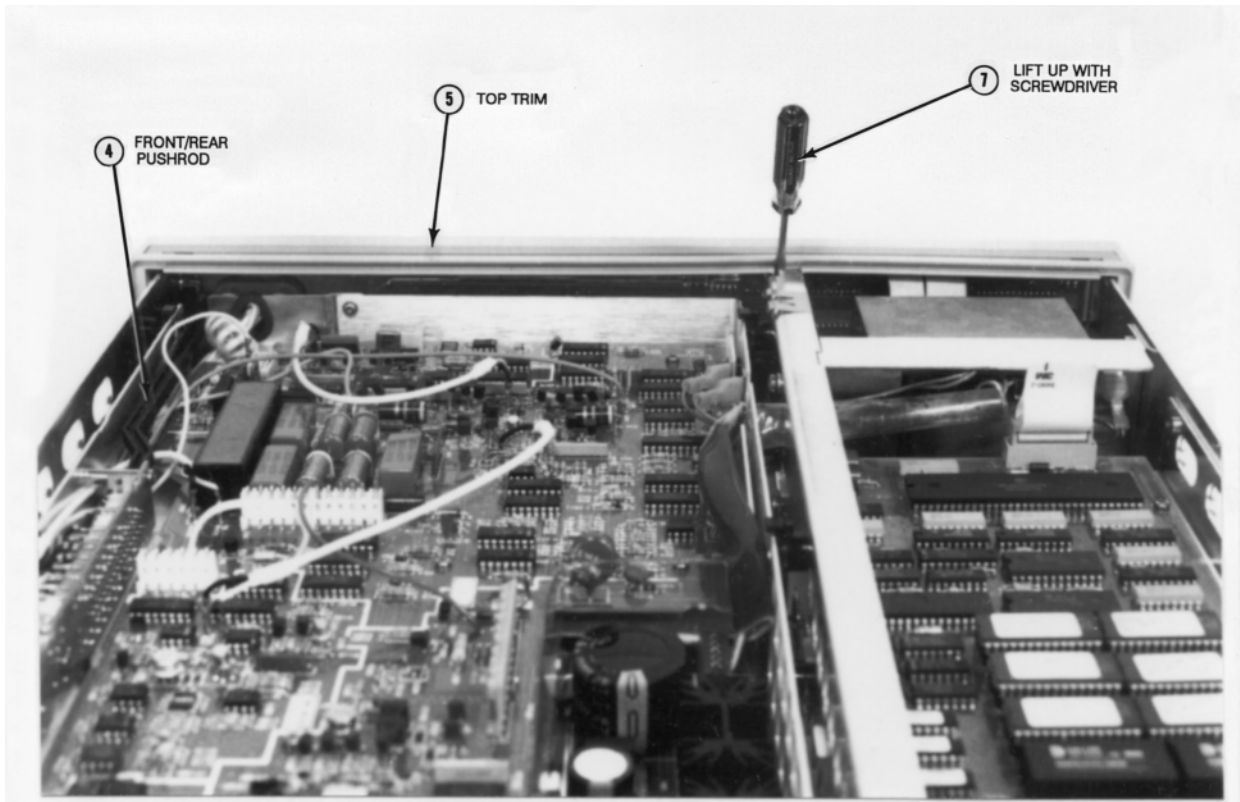

Figure 22. Top Trim and Front/rear Pushrod Locations, and Unlock Panel

- b. Locate the grey 26-pin cable that connects the Outguard Power Supply assembly to the Display assembly. Unplug this cable at the Outguard Power Supply assembly.
- c. Locate and pull the Guard switch pushrod off the Guard switch. You may need to pry the pushrod loose with a small screwdriver.

Then remove the pushrod by pulling it out of the front panel from the rear.

4. Set the 3458A on your workbench with the top facing you.
5. Refer to Figure 22. Do the following:
 - a. Locate and pull the Front/Rear switch pushrod off the Front/Rear Terminals switch. You may need to pry the pushrod loose with a small screwdriver. Then remove the pushrod by pulling it out of the front panel from the rear.
 - b. With a small flat bladed screwdriver, pry the top trim loose and remove from the Front Panel assembly.
6. Set the 3458A on your workbench with the left side facing you.
7. Refer to Figure 23. Insert a large screwdriver between the Front Panel assembly and the chassis, as shown in the figure. With the screwdriver, carefully pry the left side of the Front Panel assembly loose. Move the front panel out of the chassis until it unlocks from the chassis. Do not move it any more, or it may break.

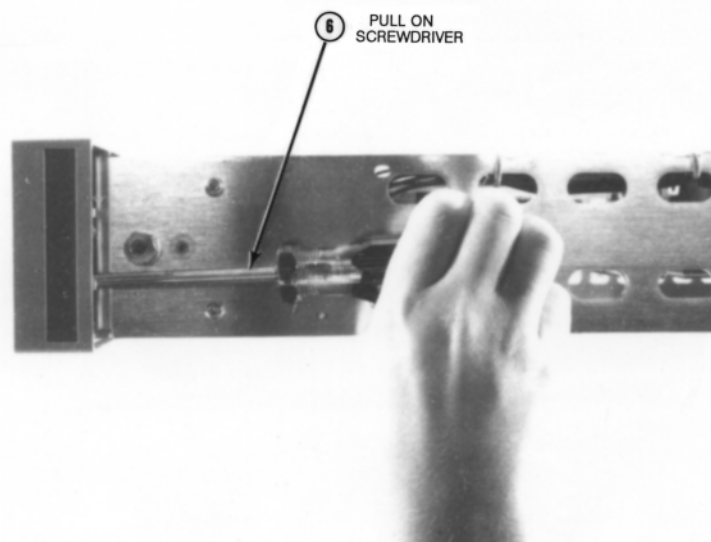

Figure 23. Remove Front Panel Assembly

8. Refer to Figure 22. With a small flat bladed screwdriver, lift up the Front Panel assembly and unlock it from the chassis. Carefully move some more of the Front Panel assembly's left side (as seen from the front of the instrument) until free from the chassis. Then move the rest of the Front Panel assembly out and away from the instrument as far as it can go. Note that the assembly can only be moved a short distance, since the front terminals are still internally connected to the instrument.

9. Turn the instrument so the front panel faces you.
10. Locate and unscrew (rotate counterclockwise) the current terminal binding post until it stops. Push in on the terminal and rotate it clockwise. Then remove the current terminal/fuse assembly.
11. Refer to Figure 24. Use the #TX10 Torx driver to remove the two Torx screws from the front terminals. Then use a #1 Pozidriv screwdriver to remove the two Pozidriv screws from the front terminals. This removes the front terminals from the Front Panel assembly.
12. Completely remove the Front Panel assembly from the instrument.
13. Place the Front Panel assembly face down on a soft anti-static mat.
14. Refer to Figure 25. Use the #TX10 Torx driver to remove the single Torx screw from the Display assembly.
15. Push the Display board toward the left (with input terminals at your right side) as far as it can go. Then pull its bottom up and lift it out from the Front Panel assembly.

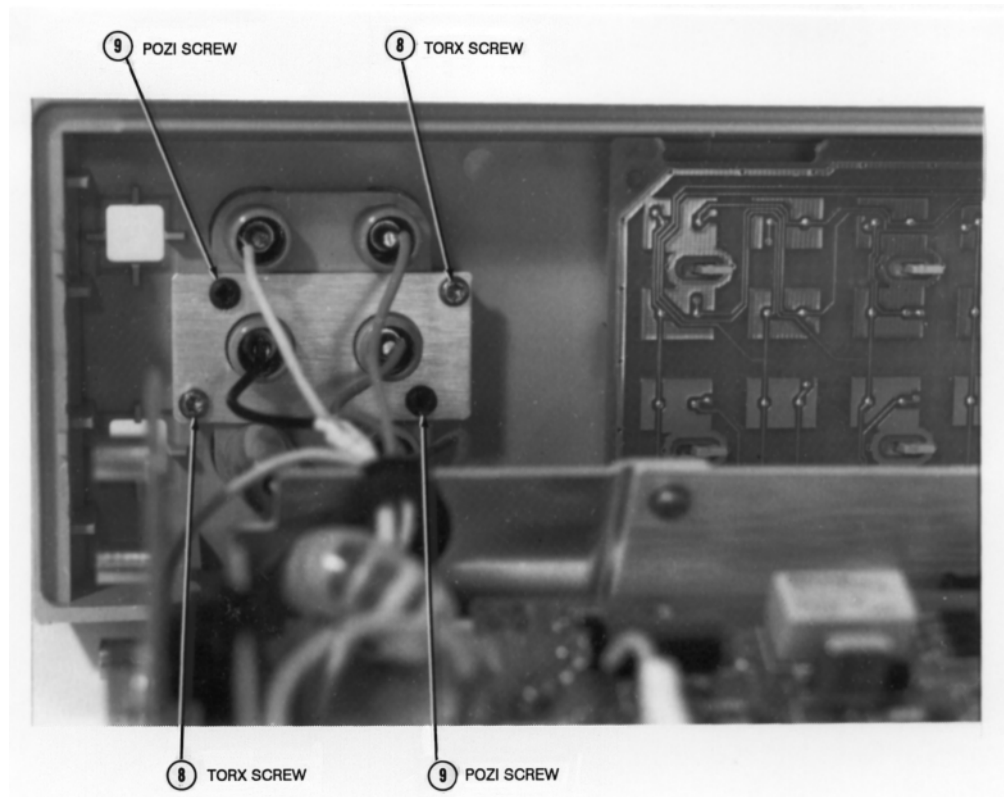

Figure 24. Remove/Install Screws on Front Terminals

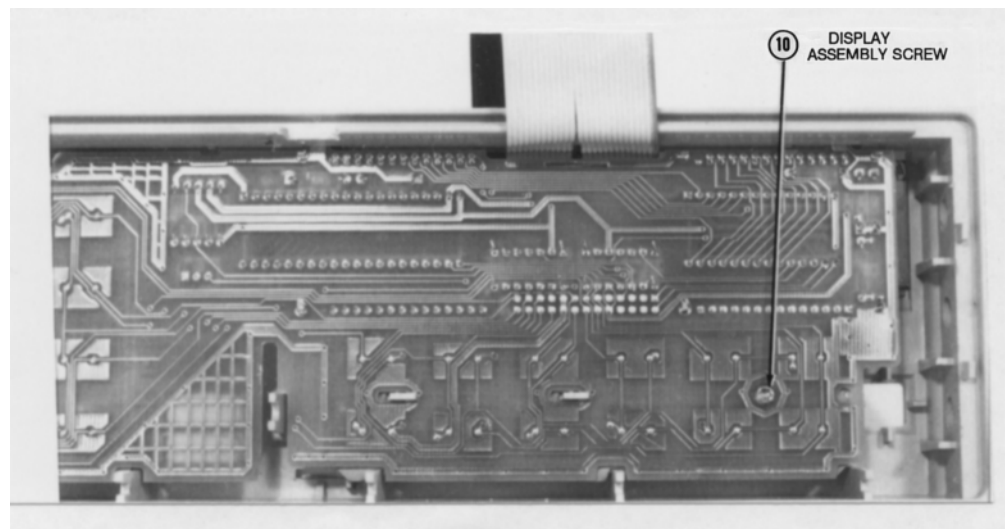

Figure 25. Remove/Install Display Screw

Installation Procedure

1. Align the slots in the Display assembly with the hook tabs on the Front Panel assembly. Be sure the board is as close to the left side of the Front Panel assembly as possible. Then push the board down until it locks in place.
2. Push the board as far as possible toward the right side of the Front Panel assembly.
3. Refer to Figure 25. Use the #TX10 Torx driver to install the screw on the Display assembly.
4. Set the 3458A on your workbench with the right side facing you.
5. Carefully place the front terminals into the appropriate holes in the front panel.
6. Refer to Figure 24. Use the #TX10 Torx driver to install the two Torx screws on the front terminals. Then use a #1 Pozidriv screwdriver to install the two Pozidriv screws on the front terminals.
7. Set the 3458A on your workbench with the front facing you.
8. Place the Front Panel assembly in front of the chassis. Place the cable from the display below the power transformer.
9. Align the Front Panel assembly with the instrument chassis. Be sure the extension on the center portion of the instrument chassis is aligned with the slot in the display board.
10. Place the right side of the Front Panel assembly over the standoffs on

the chassis, then push the left side of the Front Panel assembly over the chassis standoffs until it locks in place.

11. Install the top trim into the channel on top of the Front Panel assembly. Lock it in place (see Figure 22).
12. Install the current terminal/fuse assembly into the binding post. Push the assembly in and turn counterclockwise until it locks in place.
13. Refer to Figure 22. Guide the Front/Rear Terminals switch pushrod through the rear of the front panel's access hole. Then align the pushrod with the Front/Rear Terminals switch shaft and push it all the way onto the shaft.
14. Set the 3458A on your workbench with the bottom facing you.
15. Refer to Figure 21. Do the following:
 - a. Guide the Guard switch pushrod through the rear of the front panel's access hole. Then align the pushrod with the Guard switch shaft and push it all the way onto the shaft.
 - b. Guide the power switch pushrod through the rear of the transformer shield's access hole. Then guide the pushrod through the rear of the front panel's access hole. Align the pushrod with the ac power switch shaft and push it into the onto the shaft.
 - c. Locate the grey 26-pin cable connected to the Display Logic assembly. Line up the cable plug with the socket on the Outguard Power Supply assembly connector. Then plug the cable all the way in.

NOTE
The label numbers show the order of assembly removal. Use reverse order for installation.

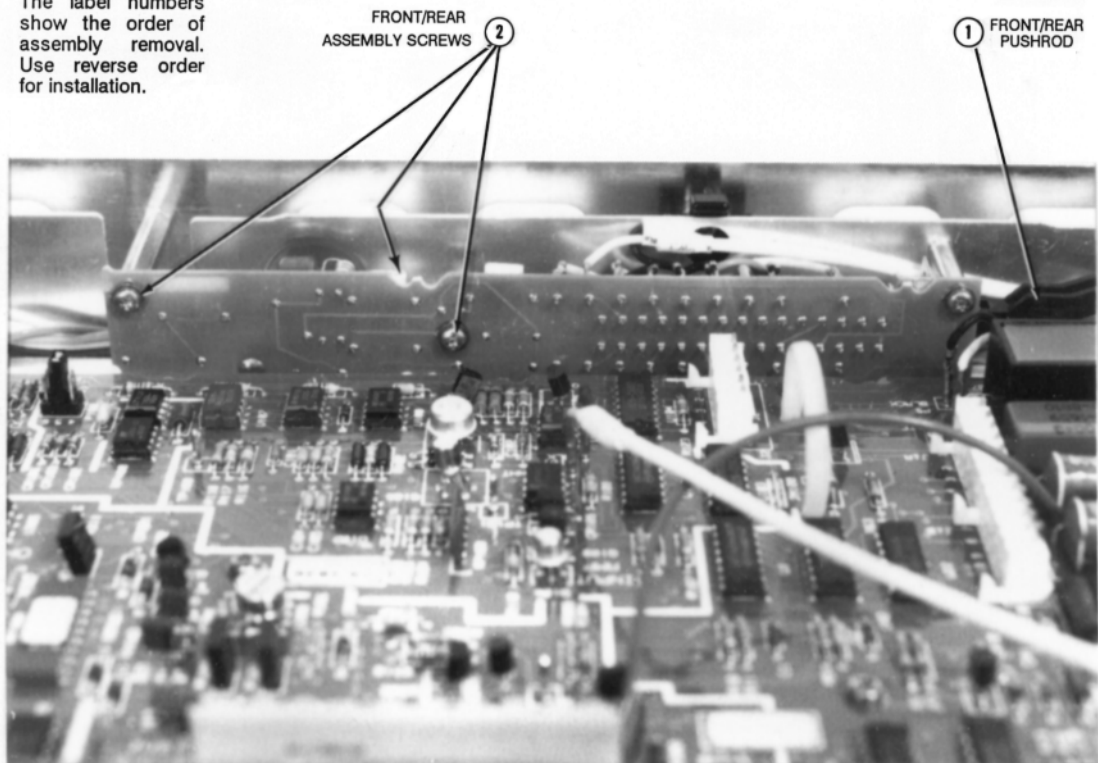

Figure 26. Front/Rear Terminals Switch Assembly Removal/Installation

16. Use the Covers Installation Procedure in this section of the manual to install the 3458A top/bottom covers and top/bottom shields.

Front/Rear Terminals Switch Removal/Installation Procedures

The following procedures show how to remove and install the Front/Rear Terminals Switch Assembly.

Refer to Figure 26 for the following procedures.

Removal Procedure

1. Use the Covers Removal Procedure in this section of the manual to remove the 3458A top cover and top shield. It is not necessary to remove the bottom cover and bottom shield.
2. Set the 3458A on your workbench with the top facing you.
3. Pull the Front/Rear Terminals switch pushrod off the Front/Rear Terminals switch. You may need to pry the pushrod loose with a small screwdriver. Then remove the pushrod by pulling it out of the front panel from the rear.

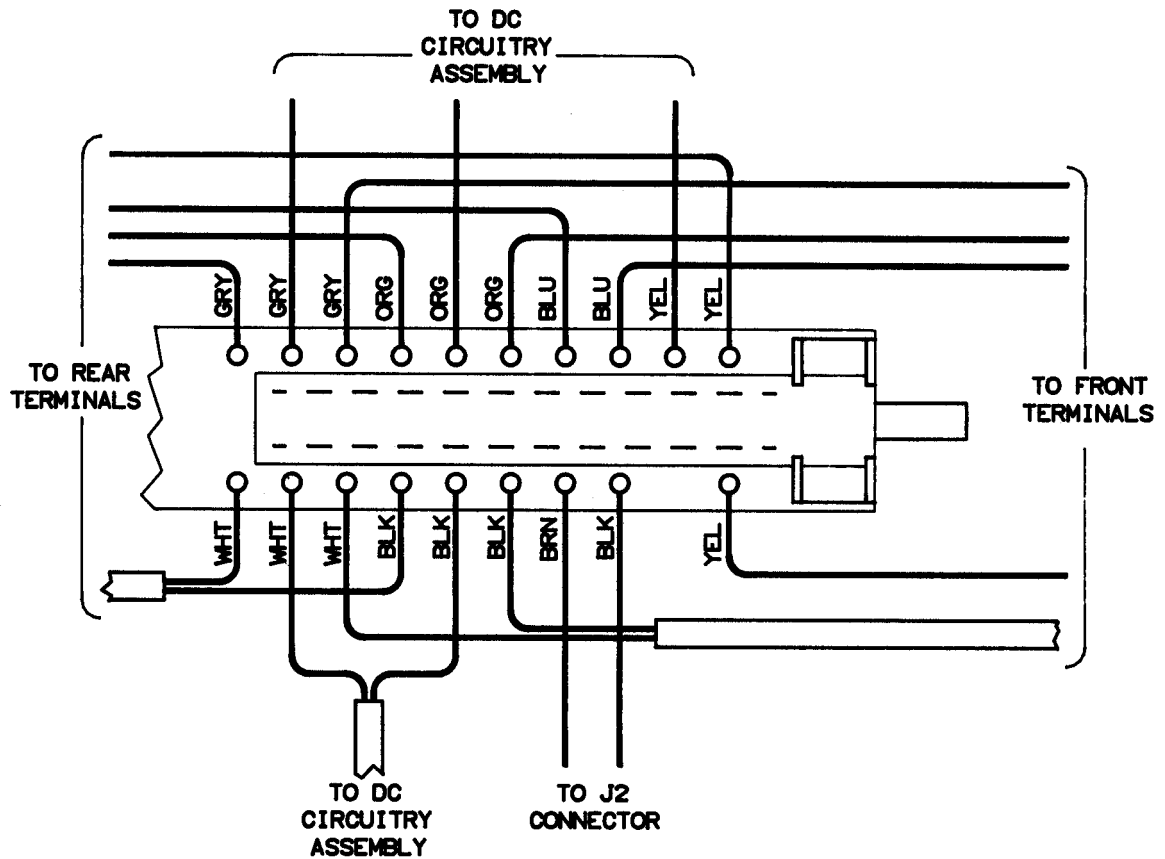

Figure 27. Wire/Cable Locations on Front/Rear Terminals Switch

4. Use the #TX10 Torx driver to remove the four screws from the Front/Rear Terminals switch assembly.
5. On the Front/Rear Terminals switch assembly, note for future reference the location of the wires connected to the assembly. These locations are also shown in Figure 27. Then unplug and lay aside all wires from the assembly.

Installation Procedure

1. Refer to Figure 27. Plug in all wires to the Front/Rear Terminals switch assembly. Use the wire locations noted in the previous procedure.
2. Line up the mounting holes of the assembly with the standoffs on the inguard chassis. Use the #TX10 Torx driver to install the four screws on the assembly.
3. Guide the Front/Rear Terminals switch pushrod through the rear of the front panel's access hole. Then align the pushrod with the Front/Rear Terminals switch shaft and push it all the way onto the shaft.

4. Use the Covers Installation Procedure in this section of the manual to install the 3458A top cover and top shield.

Replaceable Parts

Ordering Information

To order a part in the replaceable parts table, quote the Agilent part number, the check digit (abbreviated CD), and the quantity desired. Address the order to the nearest Agilent Technologies Sales Office.

Direct Mail Ordering

Within the U.S.A., Agilent Technologies can supply parts to your location through a direct mail order system. Mail order forms and specific ordering information are available through your local Agilent Technologies Sales Office.

Telephone Ordering

Within the U.S.A., Agilent Technologies can supply parts to your location by calling the following telephone number: 1-800-227-8164. The calling times are from 6 am to 5 pm, Pacific Time, Monday through Friday. After hours and holidays, call (415) 968-2347. Be sure you have the correct part number available before calling. Visa and MasterCard are accepted.

A hotline service is available by calling the above telephone numbers. The service is available 24 hours a day, 365 days/year. This allows you to receive a replacement part the next business day. To cover the cost of freight and special handling, there will be a hotline charge of \$100.00 per order (three items maximum).

Replaceable Parts List

The 3458A replaceable parts are listed in Table 7. Also listed are the 3458A printed circuit board assemblies. The column for "New Case Colors" applies to instrument serial numbers greater than 2823A21100.

Table 7. 3458A Replaceable Parts

Ref Desig	Agilent Part Number for Old Case Colors	Agilent Part Number for New Case Colors	C D	Qty	Description	Mfr Code	Mfr Part Number
A1	03458-66501		8	1	PC Assy-DC circuitry	28480	03458-66501
	0515-0372		2	8	Screw-machine assembly M3 x 0.5 8MM-LG	93907	Order by Description
	03458-43701		2	1	Push rod 186.2 LG	28480	03458-43701
	5041-0267	03458-40214		2	Key cap Grey	28480	
	5041-0564	03458-40215		1	Key cap White	28480	
A2	03458-66502		9	1	PC Assy-AC converter	28480	03458-66502
	0515-0372		2	4	Screw-machine assembly M3 x 0.5 8MM-LG	93907	Order by Description
	03458-00603		3	1	Shield-AC converter	28480	03458-00603
	0515-1410		1	1	Screw-machine assembly M3 x 0.5 20MM-LG	83486	Order by Description
	03458-43702		3	1	Push rod 177.6 LG	28480	03458-43702
A3	03458-66513		0	1	PC Assy-A/D converter and inguard logic	28480	03458-66513
	0515-0372		2	5	Screw-machine assembly M3 x 0.5 8MM-LG	93907	Order by Description
	03458-00607		7	1	Shield-A/D Converter	28480	03458-00607
	0515-1410		1	3	Screw-machine assembly M3 x 0.5 20MM-LG	83486	Order by Description
A4	03458-66504		1	1	PC Assy-inguard power supply	28480	03458-66504
	0515-0372		2	3	Screw-machine assembly M3 x 0.5 8MM-LG	93907	Order by Description
A5	03458-66505		2	1	PC Assy-outguard controller	28480	03458-66505
A5	03458-66515		4	1	PC Assy-outguard controller (OPT 001)	28480	03458-66515
	0515-0372		2	3	Screw-machine assembly M3 x 0.5 8MM-LG	93907	Order by Description
A6	03458-66516		3	1	PC Assy-outguard power supply	28480	03458-66516
	0515-0372		2	4	Screw-machine assembly M3 x 0.5 8MM-LG	93907	Order by Description
	03458-43701		2	1	Push rod- 186.2 LG	28480	03458-43701
	03458-44103	03458-44113		1	Locking Cap	28480	
A7	03458-66507		4	1	PC Assy-display logic	28480	03458-66507
	0624-0681		7	1	Screw-TPG 4-20 .25-IN-LG PAN-HD-TORX T10	93907	225-05813-890BE112 TXPNPLOZ
A9	03458-66509		6	1	PC Assy-DC reference	28480	03458-66509
A9	03458-66519		8	1	PC Assy-DC reference (OPT 002)	28480	03458-66519
	0515-1410		1	2	Screw-machine assembly M3 x 0.5 20MM-LG	83486	Order by Description
A10	03458-66510		9	1	PC Assy-front/rear switch	28480	03458-66510
	0515-0372		2	4	Screw-machine assembly M3 x 0.5 8MM-LG	93907	Order by Description
T1	9100-4715		5	1	Transformer-power	05216	Order by Description

Table 7. 3458A Replaceable Parts

Ref Desig	Agilent Part Number for Old Case Colors	Agilent Part Number for New Case Colors	C D	Qty	Description	Mfr Code	Mfr Part Number
	0515-1404		3	4	Screw-mach M4 x 0.7 55MM-LG PAN-HD	93907	Order by Description
MP1	03458-60201	03458-40211		1	Assembly-front panel	28480	
	03458-40202	03458-40212		1	Panel (front)	28480	
	03458-69302	03458-69312		1	Window	28480	
	03458-81902	03458-81912		1	Keypad	28480	
MP2	5041-8802	5041-9176		1	Trim (top front bezel)	28480	
MP3	03458-04101	03458-04111		1	Cover-top	28480	
MP4	0515-0372		2	1	Screw-machine assembly M3 x 0.5 8MM-LG	93907	Order by Description
MP5	5001-0538	5041-9170		2	Trim strip	28480	
MP6	5062-3704	5063-9210		2	Strap-handle	28480	
MP7	5041-8819	5041-9186		2	Cap, strap handle (front)	28480	
MP8	5041-8820	5041-9187		2	Cap, strap handle (rear)	28480	
MP9	0515-1132		4	4	Screw-mach M5 x 0.8 10MM-LG	N/A	Order by Description
MP10	03458-00601		1	1	Shield-top	28480	03458-00601
MP11	0515-1604		5	2	Screw-mach M3.5 x 0.6 6MM-LG	93907	Order by Description
MP12	03458-00106		1	1	Chassis-mainframe	28480	03458-00106
MP13	03458-47901	03458-47911		1	Bezel-rear	28480	
MP14	1390-0793		6	4	Fastener-captive screw M4X 0.7 THD 9.0	N/A	Order by Description
B1	03458-68501		2	1	Assembly-fan	28480	03458-68501
MP15	0624-0530		5	2	Screw-TPG 8-16 .375-IN-L6 PAN-HD-TORX	93907	Order by Description
MP16	3150-0300		5	1	Filter-air nylon 2.3-IN-OD .75-IN-LG	N/A	Order by Description
MP17	0515-0372		2	2	Screw-machine assembly M3 x 0.5 8MM-LG	93907	Order by Description
MP18	03458-00602		2	1	Shield-bottom	28480	03458-00602
MP19	0515-1604		5	2	Screw-mach M3.5 x 0.6 6MM-LG	93907	Order by Description
MP20	03458-04102	03458-04112		1	Cover-bottom	28480	
MP21	0515-0372		2	1	Screw-machine assembly M3 x 0.5 8MM-LG	93907	Order by Description
MP22	5041-8801	5041-9167		4	Foot	28480	
MP23	1460-1345		5	2	Tilt-stand SST	N/A	Order by Description
	03458-84302	03458-84312		1	Label (rear panel)	28480	
	03458-84303	03458-84313		1	Label (front panel)	28480	
	03458-67902	03458-67912		2	Fuseholder (current trmnl)	28480	
	03458-62101	03458-62111		2	Terminal block assy	28480	
	03458-44105	03458-44115		2	Terminal block assy insulator cover	28480	

Introduction

This section provides a technical description and assembly level troubleshooting procedures for the 3458A Multimeter.

WARNING Only personnel with knowledge of electronic circuitry and an awareness with the hazards involved should test and troubleshoot the instrument.

Caution To prevent electrostatic discharge (ESD) damage to ICs, always observe anti-static techniques when assemblies are handled or serviced. Refer to Chapter 3 of this manual for more information on ESD.

Test Equipment Required

You need the following equipment:

1. A 4 1/2 digit digital multimeter that can measure +5 V, +18 V, and -18 V DC. This is only used to check and troubleshoot the power supplies.
2. A computer with GPIB capability to check the 3458A's GPIB operation. This is only required for an GPIB failure.
3. An oscilloscope or logic probe. This is only required for an Ext Out failure.

3458A Adjustments/Calibration

Instrument adjustments/calibration must be performed whenever a printed circuit board assembly has been replaced or removed from the instrument. Removal or replacement of some assemblies only requires internal calibration (by executing the "ACAL ALL" command). Others need complete adjustments (for example, Offset, DC Gain, etc.). It is also good practice to execute the "ACAL ALL" command after the covers have been removed and replaced on the instrument.

Table 8 lists the 3458A assemblies and the required adjustments/calibration after assembly replacement. For information on how to adjust/calibrate the 3458A, refer to the 3458A Calibration Manual.

Table 8. Adjustments/Calibration Needed after Assembly Replacement

Ref Desig	Agilent Part Number	Assembly Description	Adjustments Needed
A1	03458-66501	DC circuitry	Offset, DC Gain, Resistance, and DC Current Adjustments
A2	03458-66502	AC converter	AC Adjustment
A3	03458-66503	A/D converter and inguard logic	Offset, DC Gain, Resistance, DC Current, and AC Adjustments
A4	03458-66504	Inguard power supply	ACAL ALL
A5	03458-66505	Outguard Controller	Offset, DC Gain, Resistance, DC Current and AC Adjustments
A5	03458-66515	Outguard Controller (Opt 001)	Offset, DC Gain, Resistance, DC Current, and AC Adjustments
A6	03458-66506	Outguard power supply	ACAL ALL
A7	03458-66507	Display logic	ACAL ALL
A9	03458-66509	DC reference	Offset, DC Gain, Resistance, and DC Current Adjustments
A9	03458-66519	DC reference (Opt 002)	Offset, DC Gain, Resistance, and DC Current Adjustments
A10	03458-66510	Front/rear switch	Offset Adjustments, ACAL ALL

Assemblies Removal/Installation Procedures

The procedures to replace the 3458A printed circuit board assemblies are found in Chapter 3 of this manual.

3458A Technical Description

General Description

The 3458A is a very high precision digital multimeter that can measure AC or DC volts, AC or DC current, AC+DC volts, AC+DC current, resistance, period, and frequency.

The 3458A can also perform complex math calculations. Its maximum reading rate is 100,000 readings/sec. The maximum input voltage is 1000 V peak with 4 1/2 to 8 1/2 digit resolution.

The multimeter has a digitizing function that converts continuous analog

signals into discrete samples.

Technical Description

Refer to Figure 28 for the following description.

The 3458A is composed of two major sections: Inguard and Outguard. The outguard controls instrument operation. The inguard does the actual measurements and also controls the measurement process.

Both the outguard and inguard sections have their own power supplies. The outguard section is referenced to chassis ground. The inguard section is referenced to its own common which is isolated from the outguard section and chassis ground. Communication between the two sections is provided through the Isolation Logic Circuitry.

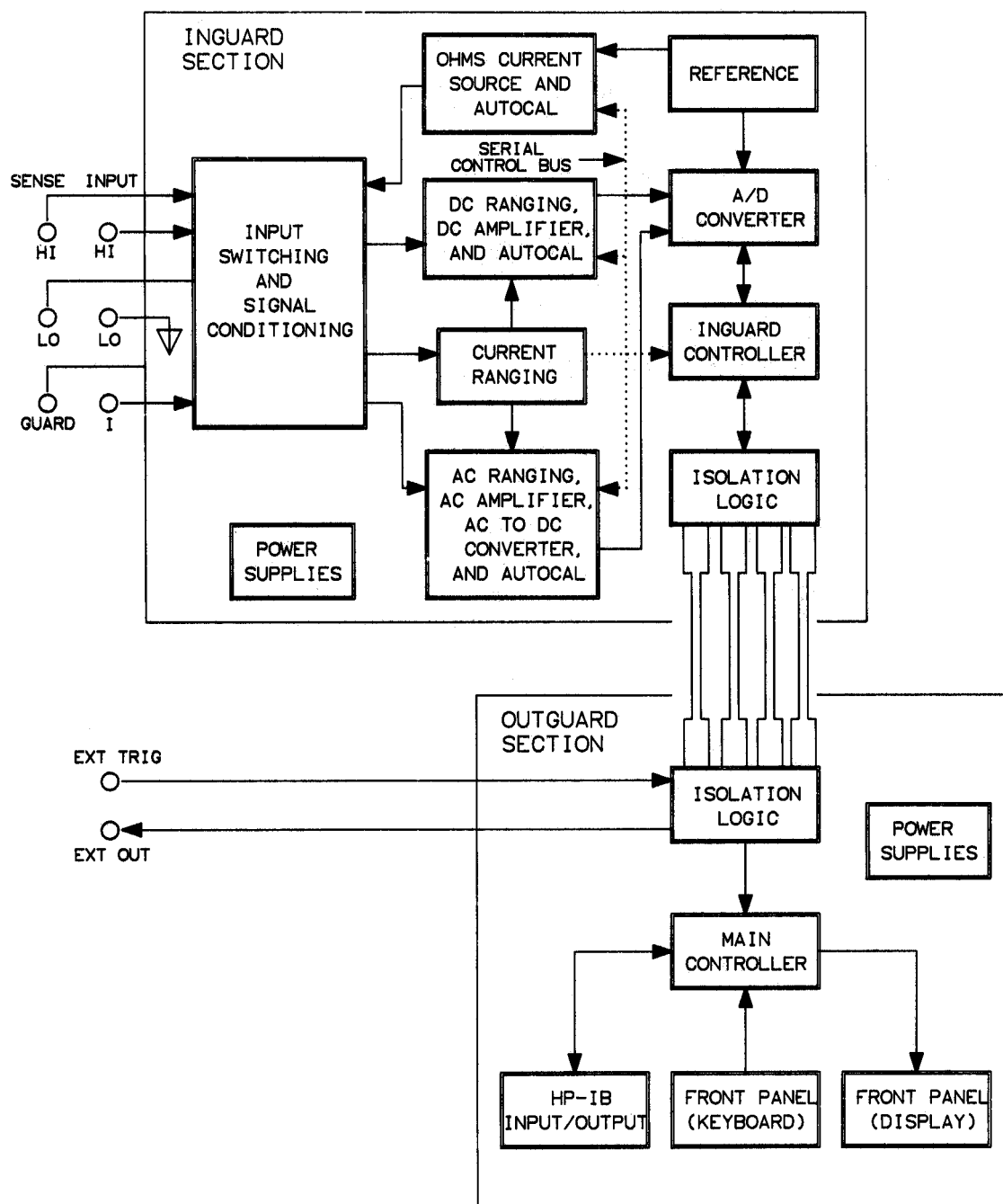

Figure 28. 3458A Simplified Block Diagram

Outguard Section

The outguard circuitry consists of the main controller, GPIB circuitry, front panel circuitry (keyboard and display), isolation circuitry, and power supply. The outguard section controls the instrument through the isolation logic, provides the interface between the keyboard and display in the front panel, and communicates with instruments and controllers connected to the General

Purpose Interface Bus (GPIB). The outguard circuitry is explained as follows.

Main Controller The Main Controller consists of a microprocessor, program ROMs, storage RAMs, calibration RAMs, and other associated circuitry. It controls the measurement operation of the instrument, communicates with the front panel (keyboard and display) and GPIB circuitry, performs the math operations, and calculates for the correct measurements. The correct measurements are calculated using the calibration constants in the calibration RAM which were stored during instrument adjustment.

GPIB Circuitry The GPIB circuitry provides communication between the 3458A and other instruments and controllers connected to the GPIB. Instrument control commands are transferred to the main controller and measurement data is transferred from the main controller through the GPIB circuitry.

Front Panel Circuitry The front panel circuitry consists of keyboard and display circuitry. The main controller sends display data to the display circuitry to be displayed on the front panel. The keyboard circuitry interrupts the main controller when a key is pressed. The keyboard circuitry also sends data to the main controller that determines which key is pressed to perform the appropriate action.

Isolation Logic Since both the outguard and inguard circuitry are referenced to two different circuit grounds, they must be isolated from each other. To maintain this isolation, direct connections for communications cannot be used. The isolation logic is used to provide communication between the two circuits, while keeping them isolated from each other. The isolation logic uses fiber optic cables to transfer data between the inguard and outguard.

Inguard Section The inguard circuitry consists of all the analog, measurement circuitry (DC circuitry, AC converter, etc.), analog-to-digital (A/D) converter, inguard controller, and power supply. The inguard circuitry performs all instrument measurements and converts the analog measurement data into digital measurement data. This digital measurement data is transferred to the outguard circuitry through the isolation logic. The inguard circuitry is explained as follows.

Input Switching and Signal Conditioning This circuitry connects the signal path from the front/rear input terminals to the appropriate DC, AC, or Ohms circuitry. The circuitry also provides the means for an Autozero measurement. In an Autozero measurement, the input of the DC and AC amplifiers is connected to ground for an offset measurement. This measurement is stored in memory and subtracted from the subsequent measurement taken at the front/rear terminals.

DC Ranging, DC Amplifier, and Autocal The A/D converter requires the same full-scale input voltage for full-scale inputs on all ranges. For example, a 10 V full scale input is required for all full scale inputs on the 0.1 V, 1 V, 100 V, and 1000 V ranges. This requirement is met by the DC circuitry (DC amplifier in conjunction with the DC ranging circuitry). For the lower 1 V and 0.1 V ranges, the circuitry amplifies the input voltage by a gain of X10 and X100, respectively. For the 10 V range, the gain is 1. For the higher 100 V and 1000 V ranges, the circuitry attenuates the inputs by 100. This results in full-scale voltages of

1 V and 10 V for the 100 V and 1000 V ranges, respectively. The 1 V and 10 V amplifier gains will then be used for these ranges.

The DC autocal constants are also generated by the Autocal circuitry in conjunction with the DC ranging and DC amplifier circuitry.

AC Ranging, AC Amplifier, AC to DC Converter, and Autocal

The A/D converter also requires the same full-scale input voltage for full-scale inputs on all AC volts and AC + DC volts ranges. In addition, the inputs to the A/D converter must be DC volts and not AC volts. Both of these requirements are met using the AC circuitry (AC ranging, AC amplifier, and AC to DC converter). The AC and AC + DC volts to DC volts conversion method used is True RMS. This method is used since the converter must convert both DC and AC voltages.

The AC autocal constants are also generated by the Autocal circuitry in conjunction with the AC ranging, AC amplifier, and AC to DC converter circuitry.

The AC circuitry is also used for track/hold measurements. Although these measurements are DC volts measurements, the AC circuitry is used due to its higher bandwidth. Track/hold requires a higher bandwidth than the DC circuitry provides.

Current Ranging

The 3458A measures current by measuring the voltage across a shunt resistor. This voltage and the shunt resistor value are then used to calculate the current. The outguard circuitry calculates the correct current value.

The current ranging circuitry is composed of the shunt resistors for the different current ranges and the switches to select the ranges. Depending on the type of current measured (AC or DC current), the circuit is also used to apply the measured voltage to the appropriate circuitry (AC or DC circuitry).

Ohms Current Source and Autocal

Resistance measurements are made by applying a known current to the unknown resistor and then measuring the voltage drop across it. From this the correct resistance is then calculated by the outguard.

The ohms current source circuitry generates the different currents for resistance measurement ranges. The DC voltage measurement across the unknown resistance is made by the DC ranging and DC amplifier circuitry.

The ohms autocal constants are also generated by the Autocal circuitry in conjunction with the ohms current source.

Reference

The reference circuit serves two functions. It provides a very stable reference voltage for the A/D converter and the Ohms current source. This voltage is necessary for accurate analog-to-digital conversion and to generate accurate currents for resistance measurements. The reference voltage is generated by a diode selected at the factory for excellent long-term stability.

Analog-to-Digital (A/D) Converter

The A/D converter converts the applied DC voltage to digital data. It uses a multi-slope conversion process to convert analog voltages to digital data. The digital data is sent to the outguard through the isolation logic circuitry.

Inguard Controller The inguard controller controls the measurement process. It receives function and range data from the outguard and then sets the appropriate switches in the inguard. The inguard controller also controls the operation of the A/D converter.

Assembly Level Troubleshooting

3458A Failures To troubleshoot the 3458A, first determine what the failure is. Then use the information in the following paragraphs to determine the defective assembly.

Failures can show up in a variety of ways. Some failures are obvious, like a completely inoperative instrument or a self-test failure. Other failures may only show up during the performance tests. Others yet will only show up under certain conditions, like the instrument working from the front panel but not from remote. In most cases, the 3458A failures can be separated into the following major categories.

1. Turn-On Failures - these failures are as follows:
 - a. 3458A Inoperative with Blank Display
 - b. 3458A Inoperative with Unintelligible Messages in Display
 - c. Isolator Failure
 - d. RAM Failure
2. Self-Test Failures - these are detected during the 3458A's self-test.
3. Performance Tests Failures - these are detected during the 3458A's performance test,
4. Miscellaneous Failures - these failures are as follows:
 - a. GPIB Failure (Self-Test passes)
 - b. Ext Out Failure
 - c. Ext Trig Failure
 - d. Fan Inoperative
 - e. Long Term Stability Failure

Turn-On Failures These failures normally show up when the instrument is first turned on and it attempts to go through its power-on self-test. The following paragraphs explain these failures and how to troubleshoot them.

3458A Inoperative with Blank Display

A blank display can indicate two things: either the instrument is completely inoperative or the display is defective. Do the following:

1. Turn the instrument on. The instrument should beep once and then go through its power-on self-test. During this time, you should hear some relays switching. When completed, the instrument will beep once again. This indicates that the instrument has completed its power-on self-test.
2. If the above power-on self-test sequence takes place (i.e., a beep is output and the relays switch), the Display Logic (A7) assembly is most likely defective. Go to the Assemblies Removal/Installation Procedures in Chapter 3 of this manual to replace the Display Logic (A7) assembly.
3. If the power-on self-test sequence does not take place, first check for a defective outguard power supply. Go to the Power Supplies troubleshooting procedures in this chapter of the manual to check the supplies.
4. If the outguard power supplies are defective, go to the Assemblies Removal/Installation Procedures in Chapter 3 of this manual to replace the Outguard Power Supply (A6) assembly.
5. If the outguard power supplies check good, the Outguard Controller (A5) assembly may be defective. Go to the Assemblies Removal/Installation Procedures in Chapter 3 of this manual to replace the Outguard Controller (A5) assembly.
6. If after replacement of the Outguard Controller (A5) assembly the instrument is still inoperative, the logic circuitry on the Outguard Power Supply (A6) assembly may be causing the failure. Go to the Assemblies Removal/Installation Procedures in Chapter 3 of this manual to replace the Outguard Power Supply (A6) assembly.

3458A Inoperative with Unintelligible Messages in Display

This normally indicates that the Display Logic is probably working but that the Outguard Logic may be inoperative. Do the following:

1. First check for a defective outguard power supply. Go to the Power Supplies troubleshooting procedures in this section of the manual to check the supplies.
2. If the outguard power supplies check good, the Outguard Controller (A5) assembly may be defective. Go to the Assemblies Removal/Installation Procedures in Chapter 3 of this manual to replace the (A5) Outguard Controller assembly.

3. If after replacement of the (A5) Outguard Controller assembly the instrument is still inoperative, the logic circuitry on the Outguard Power Supply (A6) assembly may be causing the failure. Go to the Assemblies Removal/Installation Procedures in Chapter 3 of this manual to replace the Outguard Power Supply (A6) assembly.

Isolator Failure

For isolation logic failures, the message "ISOLATOR FAILURE" will be displayed after the power-on self-test is completed. The instrument then locks up and no front panel/remote control is possible. Either the inguard or outguard isolation logic can cause the failure. Do the following:

1. Use the Covers Removal/Installation procedures in Chapter 3 of this manual to remove the instrument's bottom cover and bottom shield.
2. Turn the instrument on. Go to the Power Supplies troubleshooting procedures in this chapter of the manual to check both the inguard and outguard power supplies.
3. If the power supplies check good, the failure can either be on the Outguard Power Supply (A6) assembly or the A/D Converter and Inguard Logic (A3) assembly. These assemblies can cause the failure since the isolation logic circuitry is on both assemblies and the self-test is unable to differentiate between the failures on the two assemblies. In addition to these, the (A5) Outguard Controller assembly could also cause the failure. However, most failures will most be caused by the A3 or A6 assemblies.
4. Try replacing the Outguard Power Supply (A6) assembly first. Go to the Assemblies Removal/Installation Procedures in Chapter 3 of this manual to replace the assembly.
5. If after replacing the Outguard Power Supply (A6) assembly the test still fails, try replacing the A/D Converter and Inguard Logic (A3) assembly. Go to the Assemblies Removal/Installation Procedures in Chapter 3 of this manual to replace the assembly.
6. If after replacing the Outguard Power Supply (A6) assembly the test still fails, try replacing the (A5) Outguard Controller assembly. Go to the Assemblies Removal/Installation Procedures in Chapter 3 of this manual to replace the assembly.

RAM Failures

These failures show up when the checksum of either the RAM or the Calibration RAM is incorrect. If a failure occurs, a message indicating that the checksum is incorrect will be displayed. Since both RAMs are located on the Outguard Controller (A5) assembly, replace that assembly for any RAM failure. Use the Assemblies Removal/Installation Procedures in

Chapter 3 of this manual to replace the assembly.

Self-Test Failures General

The 3458A self-tests perform very extensive tests on the instrument circuitry so that most hardware or calibration self-test failures will be detected by these tests.

Self-test failures can show up either during the power-on self-test or during the front panel selectable self-test. The power-on self-test is automatically performed after the instrument is turned on. The complete self-test must be selected from the front panel. To select this test, press the blue "SHIFT" key and then the "Test" (left arrow) key.

Self-Test Failure Indication

The power-on and selectable self-tests use two different ways to indicate failures. With the power-on test, the "ERR" annunciator in the display normally turns on to indicate that a test has failed. In addition to the "ERR" annunciator, the message 'SELF TEST FAILED' will also be displayed.

Self-Test Error Messages

Any time the 3458A detects a self-test failure; a corresponding error message is stored into the auxiliary error registers. To determine what failed, this error message must be retrieved from the registers and displayed. To display the message, press the blue "SHIFT" key and then the "Error" key (on the NUMERIC/USER keyboard). Once the message is displayed, it is then erased from the registers. Because of this, make sure you note the complete message before continuing. Use the right arrow key to view the complete message.

An error message is composed of two different parts, a number and a corresponding message that explains the failure. For example, the error message for an AC board failure looks like the following:

202, "HARDWARE FAILURE -- SLAVE TEST: AC BOARD"

Note Remember, you need to use the left and right arrow keys to view the complete message.

The first number (2) in the message shows that this is a "200" series message. All hardware errors are stored as "200" series numbers. The other two numbers (02) show in what auxiliary error register the message is located. In the example, this is auxiliary register 2 (as in number 02).

This number also determines in which order the error messages are to be stored and displayed. This is done since more than one error message can be detected and stored into the registers. The lowest number is always stored and displayed first. Once it is displayed, the next lowest number can then be displayed, and so on. Use the blue "SHIFT" and "Error" keys combination

to display the other messages.

Self-Test Failure Troubleshooting

Before doing any self-test failure troubleshooting, go to the Power Supplies Troubleshooting procedures in this chapter of the manual to check the Outguard and Inguard Power Supplies.

If the power supplies check good, use the procedure in the previous paragraph to display the error messages. Then refer to Table 9 to determine the most likely cause of the self-test failure. Do this for all error messages recorded in the error registers. Refer to the Assemblies Removal/Installation Procedures in Chapter 3 of this manual to replace a defective assembly.

"TEST VALUE OUT OF RANGE" Error Message

This error message indicates that a test did not meet certain pre-defined limits. The number displayed next to the message indicates the test limit that was exceeded during the test.

The number can be used to determine the assembly that caused the test to fail. Numbers from 62 through 189 indicate a failure on the DC Circuitry (A1) assembly. Numbers from 190 and above indicate a failure on the AC Converter (A2) assembly. Refer to the Assemblies Removal/Installation Procedures in Chapter 3 of this manual to replace a defective assembly.

Performance Test Failures

Performance test failures are failures that may not be detected during the self-test but are detected during the performance tests. These failures may not be detected by the self-test due to the high accuracy of the 3458A.

Before assuming that a performance test has failed, you must make sure your test equipment and performance test methods have sufficient accuracy to check the 3458A. The 3458A is very accurate and needs very accurate standards to determine if a performance test has failed or not. Be sure to read the accuracy requirements in the 3458A Calibration Manual before troubleshooting performance test failures.

If you are sure that the 3458A fails a performance test, determine what function is inaccurate and then replace the appropriate assembly. The following lists the functions and probable corresponding assemblies.

1. DC Volts Function Failure -- DC Circuitry (A1) assembly.
2. DC Current Function Failure -- DC Circuitry (A1) assembly.
3. OHMS Function Failure -- DC Circuitry (A1) assembly.
4. AC Volts Function Failure -- AC Converter (A2) assembly.

5. AC Current Function Failure -- AC Converter (A2) assembly.

Table 9. Self-Test Error Messages and Probable Causes

Error Number	Error Message	Probable Cause	Ref Desig	Assembly Part Number
200	Isolator (Recovered)	A/D Converter and Inguard Logic	A3	03458-66503
		Outguard Controller	A5	03458-66505
			A5	03458-66515
200	Isolator Does Not Respond	A/D Converter and Inguard Logic	A3	03458-66503
		Outguard Logic	A5	03458-66505
			A5	03458-66515
200	Unexpected Slave Processor Reset	A/D Converter and Inguard Logic	A3	03458-66503
201	Nonvolatile RAM DTACK	Outguard Controller	A5	03458-66505
			A5	03458-66515
201	HPIB DTACK	Outguard Controller	A5	03458-66505
			A5	03458-66515
201	Timer DTACK	Outguard Controller	A5	03458-66505
			A5	03458-66515
201	Isolator DTACK	Outguard Controller	A5	03458-66505
			A5	03458-66515
202	Slave Self Test	A/D Converter and Inguard Logic	A3	03458-66503
202	Slave Test: Isolator Date	A/D Converter and Inguard Logic	A3	03458-66503
202	Slave Test: Intr Data	AC Converter	A2	03458-66502
202	Slave Test: DC Board	DC Circuitry	A1	03458-66501
202	Slave Test: AC Board	AC Converter	A2	03458-66502
202	Slave Test: Overload	DC Circuitry	A1	03458-66501
		A/D Converter and Inguard Logic	A3	03458-66503
202	Slave Test: Gate Array	A/D Converter and Inguard Logic	A3	03458-66503
202	Slave Test: Convergence	DC Circuitry	A1	03458-66501
		A/D Converter and Inguard Logic	A3	03458-66503
202	Slave Test: Interpolator	DC Circuitry	A1	03458-66501
		A/D Converter and Inguard Logic	A3	03458-66503
204	DC VOS DAC Convergence	DC Circuitry	A1	03458-66501
204	Precharge DAC Convergence	DC Circuitry	A1	03458-66501
204	MC DAC Convergence	AC Converter	A2	03458-66502
204	Flatness DAC Convergence	AC Converter	A2	03458-66502
204	Level DAC Convergence	AC Converter	A2	03458-66502
204	AC VOS DAC Convergence	AC Converter	A2	03458-66502

Table 9. Self-Test Error Messages and Probable Causes

Error Number	Error Message	Probable Cause	Ref Desig	Assembly Part Number
204	Atten HF DAC Convergence	AC Converter	A2	03458-66502
204	AC AMP HF DAC Convergence	AC Converter	A2	03458-66502
204	Interpolator Level Seek	A/D Converter and Inguard Logic	A3	03458-66503
204	Interpolator DAC Convergence	A/D Converter and Inguard Logic	A3	03458-66503
204	Reference Control Loop Failure	A/D Converter and Inguard Logic	A3	03458-66503
205	Test Value Out of Range	See text		
206	HPIB	Outguard Controller	A5	03458-66505
			A5	03458-66515
206	HPIB ASM	Outguard Controller	A5	03458-66505
			A5	03458-66515
207	UART	Outguard Controller	A5	03458-66505
			A5	03458-66515
207	UART INTR	Outguard Controller	A5	03458-66505
			A5	03458-66515
208	Timer	Outguard Controller	A5	03458-66505
			A5	03458-66515
208	Timer INTR	Outguard Controller	A5	03458-66505
			A5	03458-66515
210	ROM 0 LOW CHECKSUM	Outguard Controller	A5	03458-66505
			A5	03458-66515
210	ROM 1 LOW CHECKSUM	Outguard Controller	A5	03458-66505
			A5	03458-66515
210	ROM 2 LOW CHECKSUM	Outguard Controller	A5	03458-66505
			A5	03458-66515
211	ROM 0 HIGH CHECKSUM	Outguard Controller	A5	03458-66505
			A5	03458-66515
211	ROM 1 HIGH CHECKSUM	Outguard Controller	A5	03458-66505
			A5	03458-66515
211	ROM 2 HIGH CHECKSUM	Outguard Controller	A5	03458-66505
			A5	03458-66515
212	NONVOLATILE RAM HIGH	Outguard Controller	A5	03458-66505
			A5	03458-66515
212	NONVOLATILE RAM LOW	Outguard Controller	A5	03458-66505
			A5	03458-66515
213	Optional RAM 0 High	Outguard Controller	A5	03458-66505
			A5	03458-66515
214	Optional RAM 0 Low	Outguard Controller	A5	03458-66505
			A5	03458-66515
214	Optional RAM 1 High	Outguard Controller	A5	03458-66505

Table 9. Self-Test Error Messages and Probable Causes

Error Number	Error Message	Probable Cause	Ref Desig	Assembly Part Number
			A5	03458-66515
214	Optional RAM 1 Low	Outguard Controller	A5	03458-66505
			A5	03458-66515

Refer to the Assemblies Removal/Installation Procedures in Chapter 3 of this manual to replace a defective assembly.

Miscellaneous Failures

The following failures are those that are not detected by either the self-tests or the performance tests.

GPIB Failure (Self-Test passes)

This failure is normally caused by a defective GPIB Connector. Try cleaning the connector. If still inoperative, try replacing the Outguard Controller (A5) assembly. Go to the Assemblies Removal/Installation Procedures in Chapter 3 of this manual to replace the assembly.

Ext Out Failure

This failure can be caused by a defective cable or an inoperative isolation logic circuitry. Note that the Ext Out function can be disabled by the "EXTOUT 0" command. Be sure the function is enabled before troubleshooting the failure. To enable the function, reset the instrument.

To troubleshoot an Ext Out failure, do the following:

1. Use the Covers Removal/Installation Procedures in Chapter 3 of this manual to remove the instrument's bottom cover.
2. Refer to Figure 29 to locate the Ext Out/Ext Trig cable plugged in on the Outguard Power Supply (A6) assembly. Unplug the cable from socket P301.
3. Connect an oscilloscope (a logic probe can also be used) to the Ext Out connection on the Ext Out/Ext Trig connector (P301). The Ext Out connection is on the connector's outside pin facing the inguard.
4. Turn the instrument on and wait until it completes its self-test. When the instrument starts to trigger, a 1 μ S negative going pulse should be detected by the oscilloscope (or logic probe) at each trigger.
5. If a pulse is detected, check the cable going to the Ext Out connector on the rear panel.
6. If no pulse is detected, the isolation logic circuitry or the A/D Converter and Inguard Logic (A3) assembly may be defective. Try replacing the A/D Converter and Inguard Logic (A3) assembly first, then, if still inoperative, try replacing the Outguard Power Supply

(A6) assembly. Refer to the Assemblies Removal/Installation Procedures in Chapter 3 of this manual to replace the assemblies.

Ext Trig Failure

These failures can be caused by a defective cable or an inoperative isolation logic circuitry.

To troubleshoot an Ext Trig failure, do the following:

1. Use the Covers Removal/Installation Procedures in Chapter 3 of this manual to remove the instrument's bottom cover.
2. Refer to Figure 29 to locate the Ext Out/Ext Trig cable plugged in on the Outguard Power Supply (A6) assembly. Unplug the cable from socket P301.
3. Turn the instrument on and wait until it completes its self-test. Then select the EXT TRIG mode by executing the following:
 - a. Press the "Trig" key on the MENU keyboard. "TRIG" should now be displayed with a flashing cursor next to it.
 - b. Press the "UP ARROW" key on the FUNCTION/RANGE keyboard three times. "TRIG EXT" should now be displayed.
 - c. Press the "Enter" key on the NUMERIC/USER keyboard. The instrument should now be in the external trigger mode.
4. While viewing the 3458A display, temporarily connect a cliplead between chassis ground and the Ext Trig connection on the Ext Out/Ext Trig connector (P301). The Ext Trig connection is on the connector's outside pin facing the instrument's outside edge.
5. The instrument should now trigger each time the pin is connected to ground.
6. If triggering occurs, check the cable going to the Ext Trig connector on the rear panel.
7. If no triggering occurs, the isolation logic circuitry or the A/D Converter and Inguard Logic (A3) assembly may be defective. Try replacing the A/D Converter and Inguard Logic (A3) assembly first, then if still inoperative, try replacing the Outguard Power Supply (A6) assembly. Refer to the Assemblies Removal/Installation Procedures in Chapter 3 of this manual to replace the assemblies.

Fan Inoperative

This failure can be caused by the fan power supply, the fan cable, or by the

fan itself. The fan uses a +15 V power supply to operate. This power supply is on the Outguard Power Supply (A6) assembly. Do the following:

1. Use to the Covers Removal/Installation Procedures in Chapter 3 of this manual to remove the instrument's bottom cover.
2. Refer to Figure 29. Unplug the 2-pin cable from socket P3. The cable is connected to the fan.
3. Turn the instrument on. Use a digital multimeter to measure for approximately +15 V at socket P3, as shown in Figure 29.
4. If the voltage is good, the fan or fan cable may be defective. Since the fan and cable are considered one assembly, replace the complete fan assembly.
5. If the voltage is wrong, go to the Assemblies Removal/Installation Procedures in Chapter 3 of this manual to replace the Outguard Power Supply (A6) assembly.

Long Term Stability Failure

A Long Term Stability failure is normally detected during a DC voltage performance test. If for instance, the instrument fails the DC performance test before the completion of the calibration period (for example. 24 hours to 2 years) corresponding to the test limits against which the instrument is tested. This failure may be because of the 3458A's long-term stability. A defective DC Reference (A9) assembly causes this failure. Go to the Assemblies Removal/Installation Procedures in Chapter 3 of this manual to replace the assembly.

Power Supplies Troubleshooting

Before troubleshooting the power supplies, do the following:

1. Make sure the power line voltage select switches are in the correct position. Also make sure the correct power fuse is installed and that the fuse is good. Refer to Chapter 2, Table 1 for the correct switch positions and fuses.

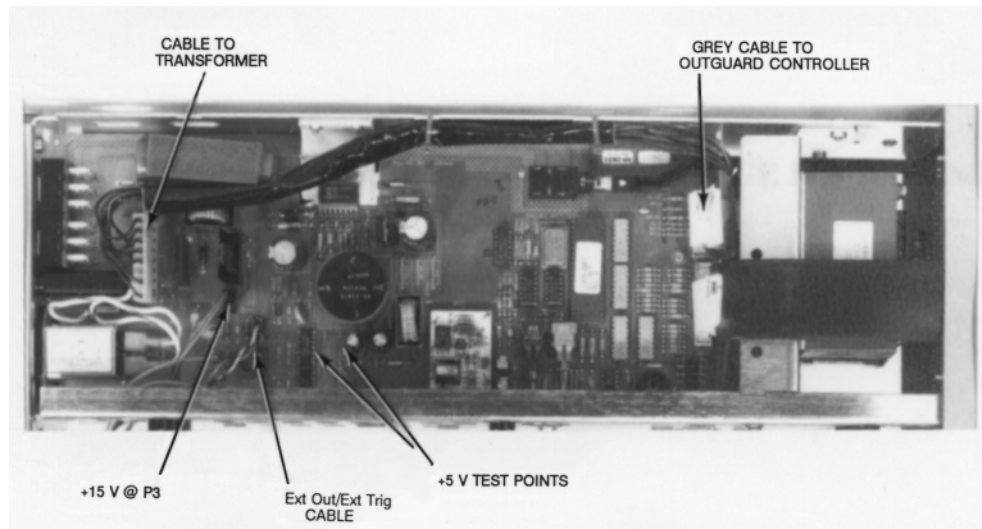

Figure 29. Outguard Power Supply

2. If the switch positions are correct and the fuse is good, go to the appropriate procedures to troubleshoot the suspect power supply.
3. If the ac power fuse is blown, try replacing the fuse first. If the fuse still blows, do the following:
 - a. Use the Covers Removal/Installation Procedures in Chapter 3 of this manual to remove the instrument's top/bottom cover and bottom shield.
 - b. Refer to Figure 29 to locate the 8-pin cable that connects the Outguard Power Supply (A6) assembly to the power transformer. Unplug the cable at the power supply assembly.
 - c. Locate the 5-pin cable that connects the Inguard Power Supply (A4) assembly to the power transformer. Unplug the cable at the power supply assembly.
 - d. Replace the ac power fuse with a new one. Apply AC power to the 3458A and turn it on.
 - e. If the fuse still blows, replace the power transformer.
 - f. If the fuse remains good, either the Outguard Power Supply (A6) or the Inguard Power Supply (A4) is defective. Continue with the next step.
 - g. Turn the instrument off. Locate the 5-pin cable connected to the power transformer. Line up the cable with the socket on the Inguard Power Supply (A4) assembly. Then plug it in.

- h. Turn the instrument on.
- i. If the fuse blows again, use the Assemblies Removal/Installation Procedures in Chapter 3 of this manual to replace the Inguard Power Supply (A4) assembly.
- j. If the fuse is good, use the Assemblies Removal/Installation Procedures in Chapter 3 of this manual to replace the Outguard Power Supply (A6) assembly.

Outguard Power Supplies Troubleshooting

Do the following:

1. Use the Covers Removal/Installation Procedures in Chapter 3 of this manual to remove the instrument's bottom cover, if not previously removed.
2. Refer to Figure 29. With the test digital multimeter, check for +5 V (± 0.25 V) at the test points shown in the figure.
3. If the voltages are good, the Outguard Power Supply assembly is good.
4. If a voltage is high, the Outguard Power Supply (A6) assembly is defective. Go to the Assemblies Removal/Installation Procedures in Chapter 3 of this manual to replace the assembly.
5. If any voltage is low, the Outguard Controller (A5) assembly may be loading down the power supply. Continue with the next step.
6. Refer to Figure 29. Unplug the grey 20 pin cable connected to the Outguard Controller (A5) assembly.
7. If the power supply voltages are now good, the Outguard Controller (A5) assembly is defective. Go to the Assemblies Removal/Installation Procedures in Chapter 3 of this manual to replace the assembly.
8. If the voltage is still low, the Outguard Power Supply (A6) assembly is defective. Go to the Assemblies Removal/Installation Procedures in Chapter 3 of this manual to replace the assembly.

Inguard Power Supplies Troubleshooting

Do the following:

1. Use the Covers Removal/Installation Procedures in Chapter 3 of this manual to remove the instrument's bottom cover and bottom shield, if not previously removed.
2. Refer to Figure 30. With the test digital multimeter, check for +5 V (± 0.13 V), +18 V (± 1.8 V), and - 18 V (± 1.8 V) at the test points shown in the figure.

3. If all voltages are good, the power supply assembly is good.
4. If a voltage is high, the Inguard Power Supply (A4) assembly is defective. Go to the Assemblies Removal/Installation Procedures in Chapter 3 of this manual to replace the assembly.
5. If a voltage is low, other assemblies in the inguard may be loading down the power supply. Continue with the next step.
6. Refer to Figure 30 to locate the grey 20-pin cable that connects the Inguard Power Supply (A4) assembly to the DC Circuitry (A1) assembly. Unplug the cable at the power supply assembly.
7. If the power supply voltage that was low is now good, the DC Circuitry (A1) assembly is defective. Go to the Assemblies Removal/Installation Procedures in Chapter 3 of this manual to replace the assembly.

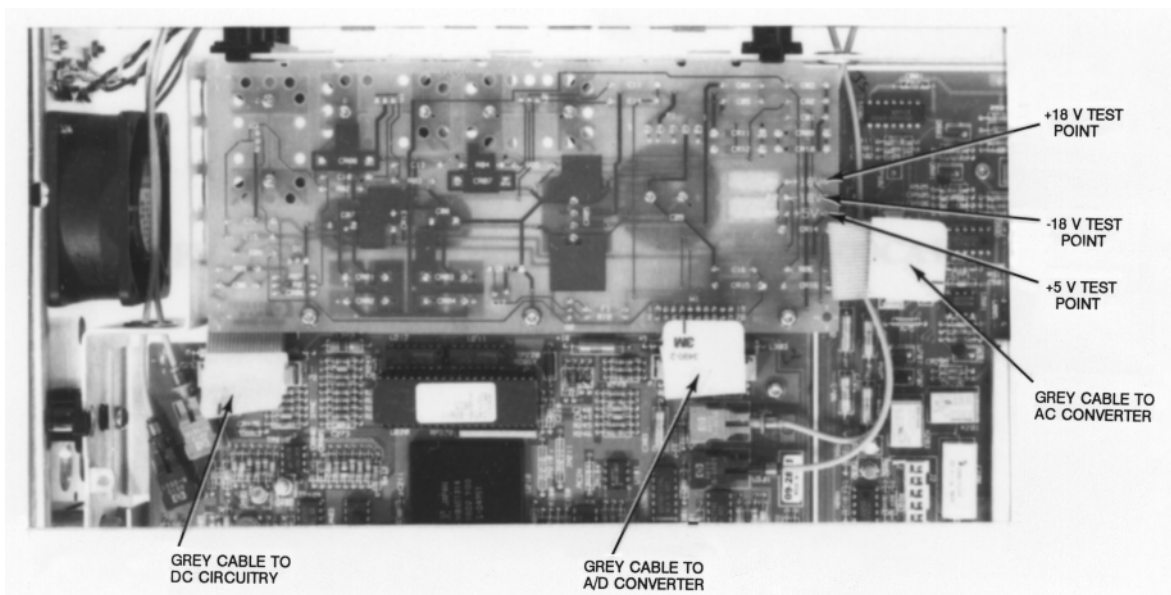

Figure 30. Inguard Power Supply

8. If the power supply voltage is still low, locate the grey 20-pin cable that connects the Inguard power Supply (A4) assembly to the AC Converter (A2) assembly. Unplug the cable at the power supply assembly.
9. If the power supply voltage is now good, the AC Converter (A2) assembly is defective. Go to the Assemblies Removal/Installation Procedures in Chapter 3 of this manual to replace the assembly.
10. If the power supply voltage is still low, locate the grey 20 pin cable

that connects the Inguard Power Supply (A4) assembly to the A/D Converter and Inguard Logic (A3) assembly. Unplug the cable at the power supply assembly.

11. If the power supply voltage is now good, the A/D Converter and Inguard Logic (A3) assembly is defective. Go to the Assemblies Removal/Installation Procedures in Chapter 3 of this manual to replace the assembly.
12. If the power supply voltage is still low, the Inguard Power Supply (A4) assembly is defective. Go to the Assemblies Removal/Installation Procedures in Chapter 3 of this manual to replace the assembly.