

PROGRAMMABLE DC POWER SUPPLY MODEL 62000E SERIES

Chroma 62000E Series of Programmable DC Power Supplies provide single-channel output of 1.7kW, 3.4kW, and 5kW, as well as three-channel of 1.7kW output each configured in an industry-leading high power density 1U chassis. The 28 models offer fixed- and auto-range output with current ratings up to 22.5A and voltage ratings up to 1200V.

The 62000E series provides constant voltage (CV) and constant current (CC) modes so that users may switch the output priority based on testing requirements. Along with its high precision measurement output, its high-speed transient response and low noise satisfies a variety of devices and test applications in both labs and automated test system integration.

These power supplies serve both single- and multi-channel test applications, such as D2D power system ATEs, automotive component systems, reliability of aerospace satellite power systems, long-term durability of active and passive components, industrial and medical system integrated power supplies, supply and aging of semiconductor power components, LED and laser diode, production and aging of solar modules, etc.

Compared with traditional power supplies, the Chroma 62000E series saves room by expanding usable rack space, decreases energy consumption, and simplifies testing at a competitive price.

The 62000E series DC power supply has 100 programmable sequence settings. Through List Mode, users can customize the desired output waveforms and set the dwell time between 10ms and 65535s to meet various test requirements. These functions apply to voltage drop testing of DC/DC converters and inverters, life cycle testing of components, aviation testing of aircraft, etc.

The 62000E series DC power supply has 1-phase/3-phase 200~240Vac and 3-phase 380~400Vac input with active PFC and 92% high efficiency. This helps customers to save electricity costs and power capacity distribution when performing high power testing, and adapt to a range of power systems around the world. In addition, the power supply can be controlled by the supported digital USB/LAN/CAN FD/GPIB and analog APG interfaces based on integration requirements of the DUT system.

MODEL 62000E SERIES

KEY FEATURES

- Voltage rating: Up to 1200V
Current rating: 22.5A max.
- Single output models:
1.7kW, 3.4kW, 5kW
- Multiple output models:
3x1.7kW channels in 1U
- Master/slave parallel up to a max of 20kW
- Fixed or Auto-ranging output models
- Auto sequence programming
- CV/CC modes priority
- High-precision measurement
- High speed transient response <1ms
- Low output ripple & noise
- Intuitive and user-friendly touch screen
- Standard USB, LAN interfaces
- Optional APG, CAN FD, GPIB, and master/slave parallel control interfaces
- AC input: 1-phase/3-phase 200~240Vac or 3-phase 380~400Vac

APPLICATIONS

- Electric vehicles component testing
- Semiconductor testing and burn-in
- Medical equipment power supply
- Aerospace and aviation testing
- Test & measurement ATE and manufacturing
- Industrial and system integrated power supply
- Equipment manufacturing and system integration
- Suitable for multi-channel power supply applications such as simulation for aviation, aerospace and satellite systems, and burn-in & processing for active/passive components, D2D modules, batteries, accelerator magnets, evaporation heating sources, etc.



HIGH POWER DENSITY 1.7KW X 3CH IN 1U

The industry-leading high power density design enables 3 channels of 1.7kW output in a 1U chassis. Each channel is isolated for independent voltage/current control and measurement that saves cabinet space for system integration and simplifies cable configuration. For example, take a system integration manufacturer who requires nine channels of programmable DC power. Other 1U supplies would require 9 single-channel power supplies stacked at a height of 9U, while the 62000E series power supply can do the job with only 3 units at 3U height (using 3-channel models).

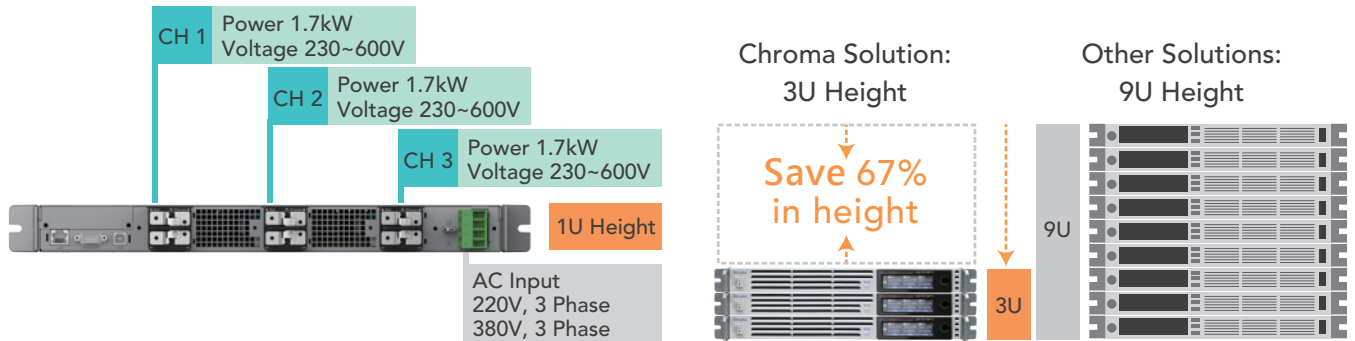

| Channel | 1 | 2 | 3 | 4 | 5 | 6 | 7 | 8 | 9 |
|---------|-------|-------|-------|-------|-------|-------|-------|-------|-------|
| Voltage | 285V | 380V | 400V | 450V | 450V | 500V | 500V | 550V | 600V |
| Current | 5.6A | 3.8A | 3A | 3A | 3.6A | 2.8A | 2.8A | 2.8A | 2.8A |
| Power | 1600W | 1444W | 1200W | 1350W | 1620W | 1400W | 1400W | 1540W | 1680W |

* Configuration case: Using 3 units of 3-channel models to be a 9-channel output configuration.

AUTO-RANGE AND FIXED-RANGE OUTPUT

The 62000E series has auto-range output and fixed-range output power supply options available for selection based on the customer's application, specification, and budget. For example, the 62050E-600P is an auto-range model with output specifications of 5kW/600V/22.5A that can be flexibly operated in different combinations (as shown in the figure on the left). It provides a 22.5A large current when outputting 223V low voltage and a small current of 8.4A at 600V high voltage. This means a customer with DUTs that need to be tested by both low voltage/high current and high voltage/low current can choose an auto-range DC power supply. The 62050E-600P can be used in an ATE for test & measurement to replace multiple DC power supplies, saving cost and space.

The 62050E-600 model is an economical fixed-range power supply designed with an output of 5kW/600V/8.4A DC source (as shown on the right). This fixed-range supply can provide power for manufacturing, giving the equipment supplier a cost-effective power source for integration when producing DUTs with fixed specifications.

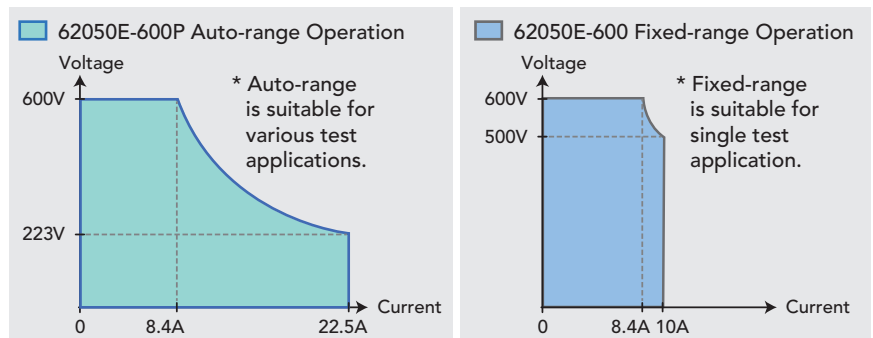

UP TO 20KW MASTER/SLAVE PARALLEL OPERATION

Users must consider compact size, light weight, high utilization, flexibility of assembling/disassembling multiple power systems, as well as system failure maintenance time, since each of these factors will affect the R&D and production line. The 62000E series DC power supply has a master/slave control mode to parallel up to 4 devices with a maximum of 20kW. The easy-to-operate parallel operation mode is convenient for R&D labs, verification units, and production lines to use. In this mode, the master will download the setting values to the slave units allowing users to operate it like a standalone unit. The parallel system adopts a digital current sharing design with high stability and anti-noise interference.

* Only available for single-channel output models.

* Requires optional A620042 interface.



AUTO SEQUENCE PROGRAMMING

The 62000E series DC power supply has built-in List and Step modes for users to program the sequence and timing. The software provides 100 steps of dwell time ranging from 10ms to 65535s, voltage and current control, as well as I/O signal output for automated testing. These functions are applicable for voltage drop testing of DC converters and inverters, auto battery charging, life cycle testing of components, aircraft aviation testing, etc.

| Seq.Edit CH:1 Prog:1 | | | |
|----------------------|----------|-----|-----|
| + | SEQ NO. | 1 | 2 |
| | V[V] | 600 | 200 |
| < | I[A] | 1 | 1 |
| | Dwell[s] | 12 | 5 |

| V_Step Mode | | |
|-------------|----------|----------|
| < | Start | End |
| | 000.00V | 000.00V |
| | Run time | 00:00:00 |

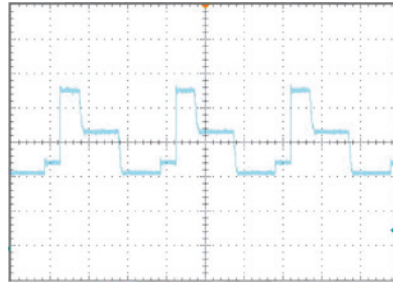

Life Cycle Test

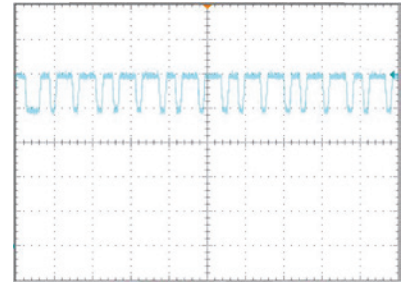

Input Disturbance Test

USER-FRIENDLY INTUITIVE CONTROL INTERFACE

The 62000E series DC power supply contains a state-of-the-art user control interface. The intuitive touch panel and user-friendly interface aid easy operation, similar to using a smartphone. Through the icons on the touch panel, users can conveniently complete all voltage/current settings and measurements, program sequence control settings, etc.



Rotary knob Control Function



Digital Keyboard

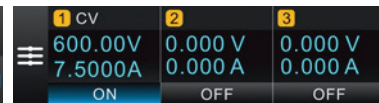

Measurement Display

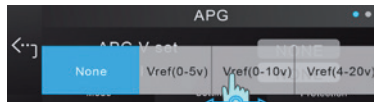

Analog Control Function

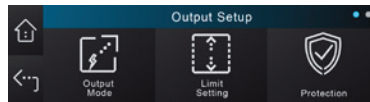

Function Page

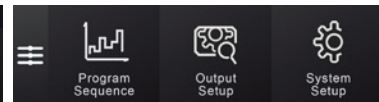

Advanced Function

REMOTE WEB CONTROL INTERFACE

The 62000E series displays a standard LAN interface compliant with the Ethernet/LXI standards. The remote web control interface provides remote operation functions, allowing users to enter their account and control the power supply via smartphone, tablet, and PC monitoring equipment. This increases convenience for long-term product aging life cycle testing and DC power supply status monitoring of the DUT anytime and anywhere (patent no.: CN111796982A).

- * The 62000E series provides Foldback functionality, which allows the equipment to set the output state as continuous or off when the output mode is switched (CV to CC or CC to CV). A delay off time can be set to protect the DUT.
- * When the power supply is abnormal, besides a warning message on the control panel, the remote control interface will also give a voice alarm.
- * Through SCPI command programming, users can perform program control (e.g. loop/pause/delay) and save/reload the control program to the computer.
- * The web software is for monitoring only and offers password-protected control authority for safe remote control.
- * The web software enables log in through a QR code for quick connection and control.
- * Requires a wireless LAN router to connect smartphones and tablets.



BUILT-IN VNC SERVER FOR REMOTE CONTROL

The 62000E series DC power supply is equipped with a VNC server. Users can readily operate and monitor remote instruments through mobile devices such as smartphones and tablets via the VNC viewer, which also offers password-protected management of user functions and permissions.

* VNC Viewer is the third party application.

* Requires a wireless LAN router to connect smartphones and tablets.

[SCENARIO 1]

When the 62000E Series DC power supply is integrated into an ATE, users can perform sequence control through the GPIB interface. This eliminates the need to visit the laboratory for checking the readings and status on the device panel. The VNC function allows remote reading of the power supply output and operating status easily through the LAN interface.



[SCENARIO 2]

When the power supply is used for long-term burn-in and aging tests on the DUT, the engineer can quickly connect to the power supply at any time. For example, view the test status of the device in the laboratory remotely from the office and greatly save on inspection time and effort.

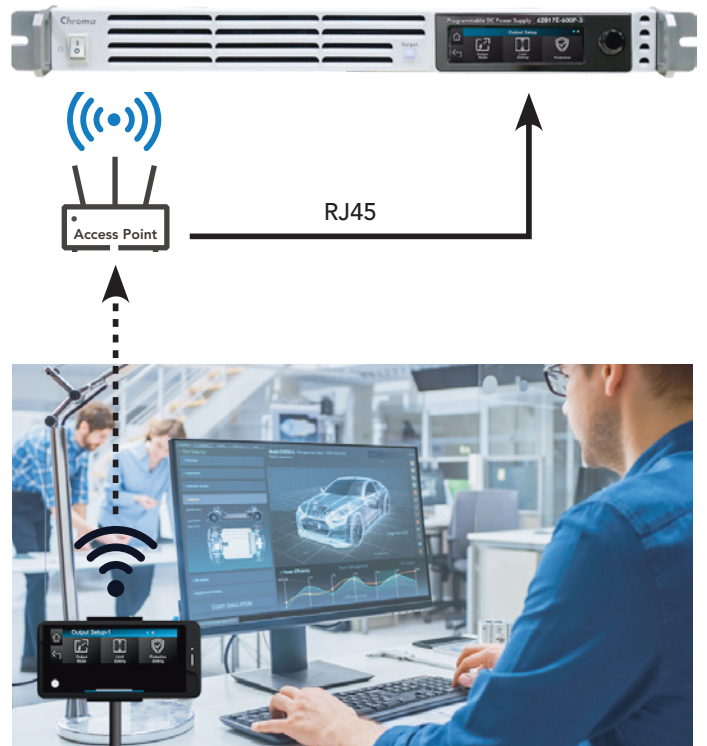

[SCENARIO 3]

When the power supply is placed on a test bench, desk, or rack (depending on the space available), having to manually operate the power supply and on-line adjust or monitor the output would be inconvenient for the engineer. Through the VNC function, a mobile device can act as a remote control keypad which greatly benefits such tasks. To keep safe, the remote control authority is protected with a password.



PANEL DESCRIPTION

Front Panel

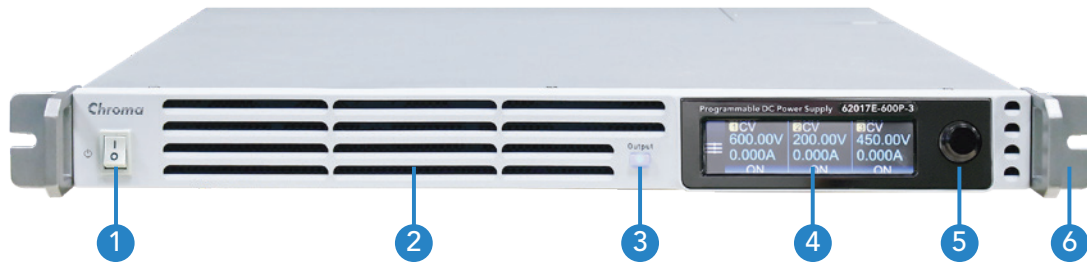

Rear Panel: 3 Channels Model

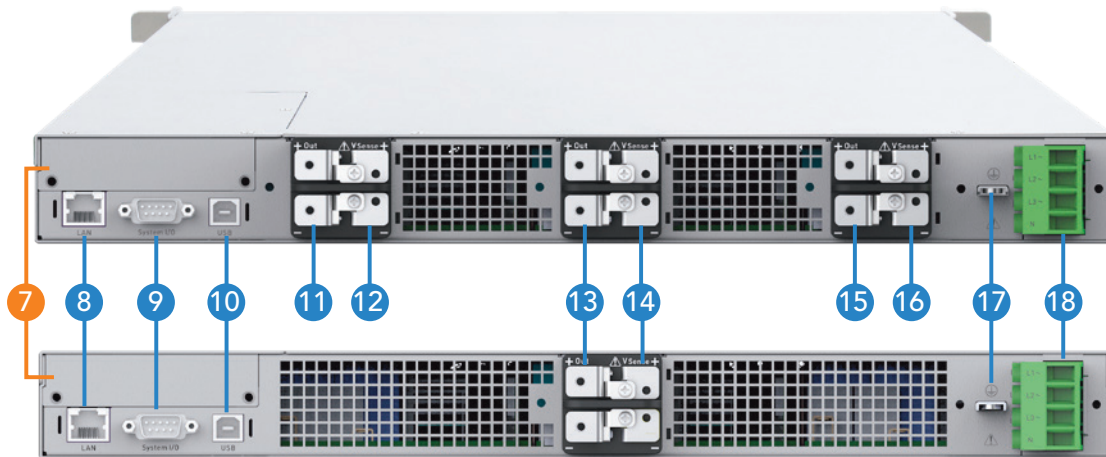

Rear Panel: Single Channel Model 1.7kW/3.4kW/5kW

- | | |
|--|--|
| <ol style="list-style-type: none"> 1. AC Power Switch 2. Air Cooling Vents 3. Output ON/OFF Key 4. TFT Color Touch Panel (3 channels) 5. Output Voltage & Current Rotary Switch 6. Rack Mounting Kit (optional) 7. GPIB/APG/CAN FD/Master-Slave Parallel Interface (Four options, choose one) 8. LAN Standard Interface 9. System I/O Interface | <ol style="list-style-type: none"> 10. USB Standard Interface 11. DC Output Terminal (channel 3) 12. Remote Sense Terminal (channel 3) 13. DC Output Terminal (channel 2) 14. Remote Sense Terminal (channel 2) 15. DC Output Terminal (channel 1) 16. Remote Sense Terminal (channel 1) 17. GND Terminal 18. AC Input Terminal |
|--|--|

DIMENSIONS

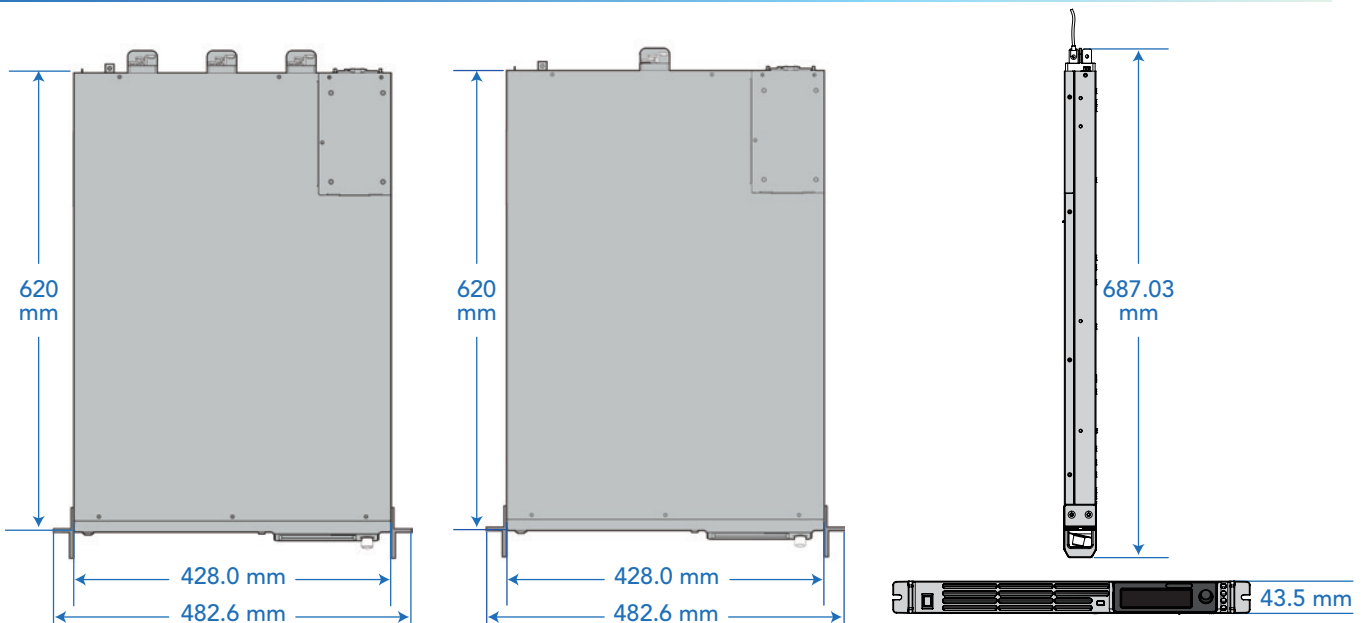

SPECIFICATIONS

Auto-range Output Models

| Model | 62017E-600P-3 | 62017E-600P | 62034E-600P | 62034E-1200P | 62050E-600P | 62050E-1200P |
|-----------------------|---------------|-------------|-------------|--------------|-------------|--------------|
| Number of Channels | 3 | 1 | 1 | 1 | 1 | 1 |
| Output Ratings | | | | | | |
| Output Voltage (V) | 0~600 | 0~600 | 0~600 | 0~1200 | 0~600 | 0~1200 |
| Output Current (A) | 0~7.5 | 0~7.5 | 0~15 | 0~7.5 | 0~22.5 | 0~7.5 |
| Output Power (W) | 1700 | 1700 | 3400 | 3400 | 5000 | 5000 |
| Efficiency (Typical) | 92% | 91% | 91% | 92% | 91% | 92% |
| Output Noise & Ripple | | | | | | |
| Voltage P-P (mV) | 375 | 375 | 375 | 750 | 375 | 1125 |
| Voltage rms (mV) | 75 | 75 | 75 | 150 | 75 | 225 |
| Current rms (mA) | 35 | 35 | 70 | 35 | 105 | 35 |

Fixed-range Output Models

| Model | 62017E-230-3 | 62017E-300-3 | 62017E-450-3 | 62017E-600-3 | 62017E-230 | 62017E-300 | 62017E-450 | 62017E-600 |
|-----------------------|--------------|--------------|--------------|--------------|------------|------------|------------|------------|
| Number of Channels | 3 | 3 | 3 | 3 | 1 | 1 | 1 | 1 |
| Output Ratings | | | | | | | | |
| Output Voltage (V) | 0~230 | 0~300 | 0~450 | 0~600 | 0~230 | 0~300 | 0~450 | 0~600 |
| Output Current (A) | 0~7.5 | 0~6.8 | 0~4.5 | 0~3.4 | 0~7.5 | 0~6.8 | 0~4.5 | 0~3.4 |
| Output Power (W) | 1700 | 1700 | 1700 | 1700 | 1700 | 1700 | 1700 | 1700 |
| Efficiency (Typical) | 89% | 91% | 91% | 92% | 89% | 90% | 90% | 91% |
| Output Noise & Ripple | | | | | | | | |
| Voltage P-P (mV) | 215 | 280 | 320 | 375 | 215 | 280 | 320 | 375 |
| Voltage rms (mV) | 30 | 37.5 | 50 | 75 | 30 | 37.5 | 50 | 75 |
| Current rms (mA) | 35 | 25 | 18 | 12 | 35 | 25 | 18 | 12 |

| Model | 62034E-230 | 62034E-300 | 62034E-450 | 62034E-600 | 62034E-800 | 62034E-1000 | 62034E-1200 |
|-----------------------|------------|------------|------------|------------|------------|-------------|-------------|
| Number of Channels | 1 | 1 | 1 | 1 | 1 | 1 | 1 |
| Output Ratings | | | | | | | |
| Output Voltage (V) | 0~230 | 0~300 | 0~450 | 0~600 | 0~800 | 0~1000 | 0~1200 |
| Output Current (A) | 0~15 | 0~13.6 | 0~9 | 0~6.8 | 0~5.1 | 0~4.1 | 0~3.4 |
| Output Power (W) | 3400 | 3400 | 3400 | 3400 | 3400 | 3400 | 3400 |
| Efficiency (Typical) | 89% | 90% | 90% | 91% | 91% | 91% | 92% |
| Output Noise & Ripple | | | | | | | |
| Voltage P-P (mV) | 215 | 280 | 320 | 375 | 750 | 750 | 750 |
| Voltage rms (mV) | 30 | 37.5 | 50 | 75 | 150 | 150 | 150 |
| Current rms (mA) | 70 | 50 | 36 | 24 | 35 | 35 | 35 |

| Model | 62050E-230 | 62050E-300 | 62050E-450 | 62050E-600 | 62050E-800 | 62050E-1000 | 62050E-1200 |
|-----------------------|------------|------------|------------|------------|------------|-------------|-------------|
| Number of Channels | 1 | 1 | 1 | 1 | 1 | 1 | 1 |
| Output Ratings | | | | | | | |
| Output Voltage (V) | 0~230 | 0~300 | 0~450 | 0~600 | 0~800 | 0~1000 | 0~1200 |
| Output Current (A) | 0~22.5 | 0~20 | 0~13.3 | 0~10 | 0~7.5 | 0~6 | 0~5 |
| Output Power (W) | 5000 | 5000 | 5000 | 5000 | 5000 | 5000 | 5000 |
| Efficiency (Typical) | 89% | 90% | 90% | 91% | 90% | 91% | 92% |
| Output Noise & Ripple | | | | | | | |
| Voltage P-P (mV) | 215 | 280 | 320 | 375 | 1125 | 1125 | 1125 |
| Voltage rms (mV) | 30 | 37.5 | 50 | 75 | 225 | 225 | 225 |
| Current rms (mA) | 105 | 75 | 54 | 36 | 35 | 35 | 35 |

ELECTRICAL SPECIFICATIONS

| Output Specifications | | | |
|-------------------------------------|--|------------------|-------------------------------------|
| | Constant Voltage Mode | | Constant Current Mode |
| Line Regulation | 0.01% + 30mV | | 0.01% + 7.5mA |
| Load Regulation | 0.01% + 60mV | | 0.01% + 7.5mA |
| Drift(30 minutes) | 0.05% of Vmax | | 0.1% of Imax |
| Drift(8 hours) | 0.05% of Vmax | | 0.05% of Imax |
| Temperature Coefficient | 0.04% of Vmax/°C | | 0.04% of Imax/°C |
| Programming Accuracy | 0.05% + 0.05%FS | | 0.1% + 0.1%FS |
| Measurement Accuracy | 0.05% + 0.05%FS | | 0.1% + 0.1%FS |
| OVP Adjustment Range | 0-110% programmable | | |
| Accuracy | ± 1% of full-scale output | | |
| Programming Response Time | Rise time(No/Full Load)<100ms & Fall time(No Load)<3s | | |
| Transient Response time (CV mode) | Recovers within 1ms to ±0.75% of steady-state output for a 50% to 100% or 100% to 50% load change (1A/us) | | |
| Input Specifications | | | |
| AC Input Voltage Operating Range *1 | 1Ø 200~240Vac ± 10% V _{LN} / 3Ø 200~240Vac ± 10% V _{LL} (3 phase 4 wire Delta connection) / 3Ø 380~400Vac ± 10% V _{LL} (3 phase 5 wire, Y connection) | | |
| AC Frequency Range | 47~63Hz | | |
| Power Factor | 0.98 | | |
| Max. AC Current (each phase) | 1Ø3W 200~240Vac | 1.7kW model: 10A | 3.4kW model: 20A |
| | 3Ø4W 200~240Vac | -- | 3.4kW model L1, L3: 10A ; L2: 17A |
| | 3Ø5W 380~400Vac | -- | 3.4kW model L1, L2, N: 10A ; L3: 0A |
| | | | 5kW/1.7kWx3CH model: 29A |
| | | | 5kW/1.7kWx3CH model: 17A |
| | | | 5kW/1.7kWx3CH model: 10A |
| General Specifications | | | |
| Remote Interface | Standard Ethernet, USB interfaces Optional GPIB, CAN FD/RS232, APG and master/slave parallel & series interfaces | | |
| Program Sequences Function | Program: 10 ; Sequences: 100 ; Dwell time: 10ms~65535s | | |
| Remote Sense Compensation/line | 5V (Output voltage: 230V~600V) ; 10V (Output voltage: 800V~1200V) | | |
| Operating Temperature Range | 0~40°C, output power is a full 100% (41~50°C, output power rate derates to 85%) | | |
| Dimension (H x W x D) | 43.5 x 428 x 620 mm / 1.71 x 16.85 x 24.41 inch | | |
| Weight | <8.5 kgs / 18.7 lbs (Model 1.7kW) | | |
| | <11 kgs / 24.3 lbs (Model 3.4kW) | | |
| | <13.5 kgs / 29.8 lbs (Model 5kW/1.7kWx3ch) | | |

| Analog Programming Interface | | | |
|---|--|--|------------------------------|
| | Constant Voltage Mode | | Constant Current Mode |
| Analog Programming Input | 0~5V or 0~10V or 0~5V/10kohm | | 0~5V or 0~10V or 0~5V/10kohm |
| Analog Programming Accuracy | 0.2% of Vmax | | 0.3% of Imax |
| Analog Monitoring Output | 0~5V or 0~10V | | 0~5V or 0~10V |
| Analog Monitoring Accuracy | 0.5% of Vmax | | 0.75% of Imax |
| Remote Inhibit (I/P) | 0~0.6V (output OFF) 2~15V (output ON) | | |
| Power OK Signal (O/P) | TTL: Active High | | |
| CV/CC Indicator (O/P) | CV: TTL high, CC: TTL low Max. voltage 30V, Sink current 10mA | | |
| External ON/OFF (I/P) | 0~0.6V(output OFF) 2~15V(output ON) | | |
| Local/remote Analog Control (I/P) | By electrical signal TTL or open/short: 0~0.6V or short: Remote, 4-5V or open: Local | | |
| Local/remote Analog Control Indicator (O/P) | Open collector, Local: open, Remote: ON, Max. voltage: 30V, Max. sink current: 5mA | | |
| Auxiliary Outputs (O/P) | 15V ± 5%, 0.2A Max. load, Ripple & noise: 50mVp-p | | |

*1 When input voltage at <200Vac, output power derating to 85%.

| Master/Slave Series and Parallel Function | | |
|---|------------------------------|--------------------------------|
| | Series Function (Max. units) | Parallel Function (Max. units) |
| 62017E-230/300/450/600/600P-3 (3CH) | None | None |
| 62017E/34E/50E-230/300/450/600/600P (1CH) | Yes (2 units) * | Yes (4 units)* |
| 62017E/34E/50E-800/1000/1200/1200P (1CH) | None | Yes (4 units)* |

* Series and parallel functions work only under the same model.

* Each single unit must be equipped with a master-slave control interface card A620042.

* All specifications are subject to change without notice.

ORDERING INFORMATION

| Programmable DC Power Supply 62000E Series | | | | |
|--|------------|------------|------------|-----------------|
| Fixed-range Output Models | | | | |
| Model | Output (W) | Output (V) | Output (A) | Output Channels |
| 62017E-230-3 | 1700 | 230 | 7.5 | 3 |
| 62017E-300-3 | | 300 | 6.8 | |
| 62017E-450-3 | | 450 | 4.5 | |
| 62017E-600-3 | | 600 | 3.4 | |
| 62017E-230 | | 230 | 7.5 | |
| 62017E-300 | | 300 | 6.8 | |
| 62017E-450 | | 450 | 4.5 | |
| 62017E-600 | | 600 | 3.4 | |
| 62034E-230 | 3400 | 230 | 15 | 1 |
| 62034E-300 | | 300 | 13.6 | |
| 62034E-450 | | 450 | 9 | |
| 62034E-600 | | 600 | 6.8 | |
| 62034E-800 | | 800 | 5.1 | |
| 62034E-1000 | | 1000 | 4.1 | |
| 62034E-1200 | | 1200 | 3.4 | |
| 62050E-230 | | 5000 | 230 | |
| 62050E-300 | 300 | | 20 | |
| 62050E-450 | 450 | | 13.3 | |
| 62050E-600 | 600 | | 10 | |
| 62050E-800 | 800 | | 7.5 | |
| 62050E-1000 | 1000 | | 6 | |
| 62050E-1200 | 1200 | | 5 | |

* Please specify the AC input voltage range for 3.4kW/5kW/1.7kWx3CH at time of order (factory installation).

| Programmable DC Power Supply 62000E Series | | | | |
|--|------------|------------|------------|-----------------|
| Auto-range Output Models | | | | |
| Model | Output (W) | Output (V) | Output (A) | Output Channels |
| 62017E-600P-3 | 1700 | 600 | 7.5 | 3 |
| 62017E-600P | | 600 | 7.5 | |
| 62034E-600P | 3400 | 600 | 15 | 1 |
| 62034E-1200P | | 1200 | 7.5 | |
| 62050E-600P | 5000 | 600 | 22.5 | 1 |
| 62050E-1200P | | 1200 | 7.5 | |

| Options | |
|---------|---|
| A620040 | GPIB Interface |
| A620041 | Analog Programming interface for single channel |
| A620042 | Master/Slave control interface for single channel |
| A620043 | Analog Programming interface for 3 channels |
| A620044 | CAN FD/RS232 Interface |

* Choose one of the above 4 options to install in the power supply.

Optional Interfaces:

A620040



A620041/A620043



A620042



A620044



Get more product & global distributor information in Chroma ATE APP



iOS



Android

Search Keyword

62000E

HEADQUARTERS
CHROMA ATE INC.
88 Wenmao Rd.,
Guishan Dist.,
Taoyuan City
333001, Taiwan
T +886-3-327-9999
F +886-3-327-8898
www.chromaate.com
info@chromaate.com

U.S.A.
CHROMA SYSTEMS
SOLUTIONS, INC.
19772 Pauling,
Foothill Ranch,
CA 92610
T +1-949-600-6400
F +1-949-600-6401
www.chromausa.com
sales@chromausa.com

EUROPE
CHROMA ATE EUROPE B.V.
Morsestraat 32, 6716 AH
Ede, The Netherlands
T +31-318-648282
F +31-318-648288
www.chromaeu.com
salesnl@chromaeu.com

CHROMA GERMANY GMBH
Südtiroler Str. 9, 86165,
Augsburg, Germany
T +49-821-790967-0
F +49-821-790967-600
www.chromaeu.com
salesde@chromaeu.com

JAPAN
CHROMA JAPAN
CORP.
888 Nippa-cho,
Kouhoku-ku,
Yokohama-shi,
Kanagawa,
223-0057 Japan
T +81-45-542-1118
F +81-45-542-1080
www.chroma.co.jp
info@chroma.co.jp

KOREA
CHROMA ATE
KOREA BRANCH
3F Richtogether
Center, 14,
Pangyoyeok-ro 192,
Bundang-gu,
Seongnam-si,
Gyeonggi-do
13524, Korea
T +82-31-781-1025
F +82-31-8017-6614
www.chromaate.co.kr
info@chromaate.com

CHINA
CHROMA ELECTRONICS
(SHENZHEN) CO., LTD.
8F, No.4, Nanyou Tian
An Industrial Estate,
Shenzhen, China
T +86-755-2664-4598
F +86-755-2641-9620
www.chroma.com.cn
info@chromaate.com

SOUTHEAST ASIA
QUANTEL PTE LTD.
(A company of Chroma Group)
25 Kallang Avenue #05-02
Singapore 339416
T +65-6745-3200
F +65-6745-9764
www.quantel-global.com
sales@quantel-global.com