



Anritsu Advancing beyond

Technical Data Sheet

VNA Master™

Affordable Handheld Vector Network +
Spectrum Analyzer for Cable, Antenna, and
Signal Analysis Anytime, Anywhere

MS2024B, MS2025B

500 kHz to 4 GHz, 6 GHz, Vector Network Analyzer

MS2034B, MS2035B

500 kHz to 4 GHz, 6 GHz, Vector Network Analyzer

9 kHz to 4 GHz, 6 GHz, Spectrum Analyzer

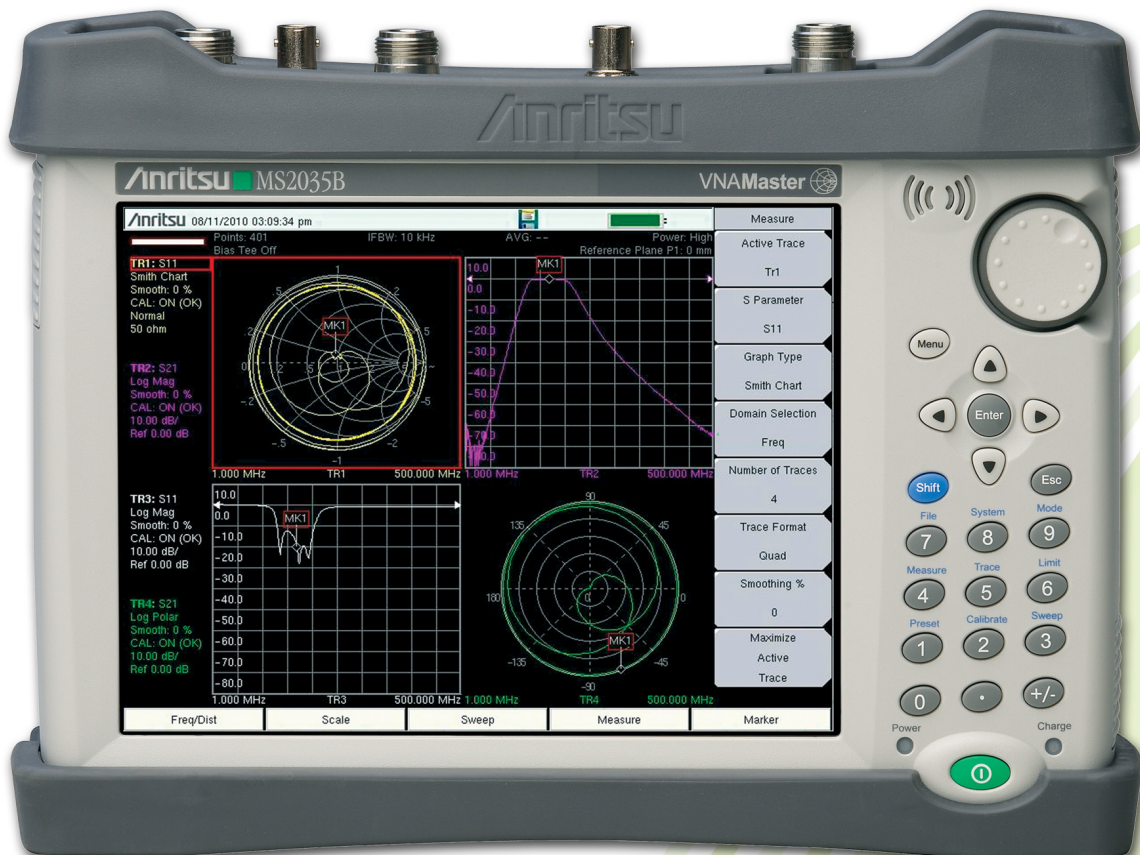

Introduction

Anritsu proudly offers the MS202xB/MS203xB VNA Master + Spectrum Analyzer, the industry's most affordable and compact handheld solution to address cable, antenna, component, and signal analysis needs in the field. All MS202xB/3xB VNA Master models offer benchtop accuracy and high performance S-parameter measurements in portable form. With frequency coverage from 500 kHz up to 4 or 6 GHz in a truly handheld, battery-operated, rugged, multi-function instrument, the VNA Master also provides a field-friendly touchscreen user interface.

MS2034B/35B models include a powerful spectrum analyzer which multiplies user convenience by combining both a VNA and a separate spectrum analyzer into a single measurement powerhouse for the harsh RF and physical environments of field test. Whether it is for spectrum monitoring, broadcast proofing, interference analysis, RF and microwave measurements, regulatory compliance, 3G/4G, Land Mobile Radio, or wireless data network measurements, this VNA/Spectrum Analyzer combination is the ideal instrument for making fast and reliable measurements in the field.

Vector Network Analyzer Performance and Functional Highlights (all models)

- Broadband coverage of 500 kHz to 4/6 GHz
- 1-path, 2-port Vector Network Analyzer
- Intuitive Graphical User Interface (GUI) with convenient Touch Screen
- VNA-quality error correction for directivity and source match
- 2-port Transmission Measurements: High/Default/Low Power
- Outstanding calibration stability, minimal drift error
- Calibration Interpolation feature adds flexibility
- User-defined overlays for viewing multiple S-Parameters
- Arbitrary data points up to 4001
- IF Bandwidth selections of 10 Hz to 100 kHz
- 100 dB Transmission Dynamic Range
- 850 μ s/data point sweep speed
- Greater than 3 hour battery life
- USB and Ethernet for data transfer and instrument control
- User-selectable menu options: Choose either VNA or Field Mode for simplified Cable & Antenna analysis
- Field upgradable firmware
- Internal Flash Memory: 2 GB — Store more than 4000 traces and setups in memory
- Portable: 3.5 kg (7.6 lb)
- Full Speed USB Memory support
- Automate repetitive tasks via Ethernet and USB
- High resolution daylight-viewable TFT color display
- "Glove Friendly" Resistive Touchscreen Display
- Distance Domain (Standard with firmware V1.20 and above)
- Internal Bias Tee Option
- Vector Voltmeter Option, ideal for cable phase matching
- High Accuracy Power Meter Option
- GPS Receiver Option
- Polar Format Impedance Display
- Complies with MIL-PRF-28800F Class 2.
- Certified for use in Explosive Atmosphere per MIL-PRF-28800F and MIL-STD-810G

Spectrum Analyzer Performance and Functional Highlights (MS203xB models only)

- Measure: Occupied Bandwidth, Channel Power, ACPR, C/I
- Interference Analyzer: Spectrogram, Signal Strength, RSSI, Signal ID
- Dynamic Range: > 95 dB in 10 Hz RBW
- DANL: -162 dBm in 1 Hz RBW (normalized)
- Phase Noise: -100 dBc/Hz max @ 10 kHz offset at 1 GHz
- Frequency Accuracy: ± 50 ppb 3 minutes after GPS lock
- Traces: Normal, Max Hold, Min Hold, Average, # of Averages
- Detectors: Peak, Negative, Sample, Quasi-peak, and RMS
- Markers: 6, each with a Delta Marker, or 1 Reference Marker with 6 Delta Markers
- Trace Save-on-Event: crossing limit line or sweep complete
- PIM Hunting
- Limit Lines: up to 41 segments with one-button envelope creation
- AM/FM/SSB Audio-only Demodulation
- Optional AM/FM/PM Demodulation Analyzer
- Store thousands of traces internally
- Channel Scanner Option
- GPS tagging of stored traces
- Internal Preamp standard
- High Accuracy Power Meter Option
- Coverage Mapping Option

Table of Contents

Definitions 3

VNA Performance Specifications 4

VNA Functional Specifications 5

Corrected System Performance and Uncertainties — High Port Power, N-Type 6

Corrected System Performance and Uncertainties — High Port Power, K-Type 7

Spectrum Analyzer Performance Specifications 8

Spectrum Analyzer Functional Specifications 9

Bias Tee (Option 10) 10

Vector Voltmeter (Option 15) 10

Distance Domain 10

High Accuracy Power Meter (Option 19) 11

Interference Analyzer (Option 25) 11

Channel Scanner (Option 27) 11

GPS (Option 31) 12

Coverage Mapping (Option 431) 12

Ethernet Connectivity 12

AM/FM/PM Demodulation Analyzer (Option 509) 13

General Specifications 14

Line Sweep Tools 16

Master Software Tools 16

Web Remote Control 17

Programmable Remote Control 17

Ordering Information 18

Standard Accessories 19

USB Power Sensors 19

Optional Accessories 20

Related Literature, Application Notes, Manuals 30

Definitions

| | |
|---------------------|--|
| Specifications | All specifications and characteristics apply to Revision 2 instruments under the following conditions, unless otherwise stated: |
| Temperature Range | Over the 23 °C ± 5 °C temperature range. |
| Warm-Up Time | After 10 minutes of warm-up time in VNA mode, where the instrument is left in the ON state. |
| Mode | Sweep Mode set to Performance. |
| Reference Signal | When using internal reference signal. |
| Typical Performance | Typical specifications that are not in parenthesis are not tested and not warranted. They are generally representative of characteristic performance. Typical specifications in parenthesis () represent the mean value of measured units and do not include any guard-bands or uncertainties. They are not warranted. |
| Uncertainty | A coverage factor of x1 is applied to the measurement uncertainties to facilitate comparison with other industry handheld analyzers. |
| Time Base Error | Input Frequency × Frequency Reference Error |
| Calibration Cycle | Calibration is within the recommended 12 month period (residual specifications also require calibration kit calibration cycle adherence.) All specifications subject to change without notice. For the most current data sheet, please visit the Anritsu web site: www.anritsu.com |



VNA Performance Specifications

Block Diagram

As shown in the following block diagram, the VNA Master has a 2-port, 1-path architecture that automatically measures 2 S-parameters with error-correction precision inherent to VNA operation. The above illustration is a simplified block diagram of the VNA Master 2-port, 1-path architecture. The magnitude AND phase information gained from Vector Network data enables the VNA Master to provide improved field measurements with greater accuracy.

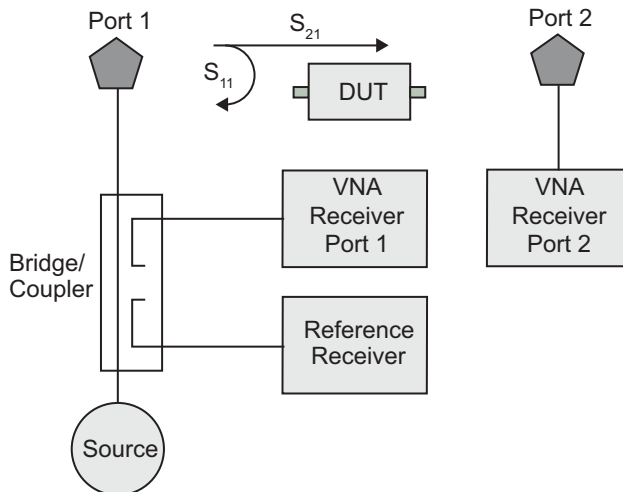

Frequency

| | |
|----------------------|------------------|
| MS2024/34B | 500 kHz to 4 GHz |
| MS2025/35B | 500 kHz to 6 GHz |
| Frequency Accuracy | 2.5 ppm |
| Frequency Resolution | 1 Hz |

Test Port Power (Typical)

VNA Master supports selection of High, Default, or Low test port power. Changing power after calibration can degrade the calibrated performance. Typical power by bands:

| Frequency Range | High Port Power (dBm) | Default Port Power (dBm) | Low Port Power (dBm) |
|--------------------|-----------------------|--------------------------|----------------------|
| 500 kHz to < 3 GHz | +3 | -5 | -25 |
| 3 GHz to 6 GHz | 0 | -5 | -25 |

Transmission Dynamic Range

The transmission dynamic range (the difference between test port power and noise floor) using 10 Hz IF Bandwidth and High Port Power:

| | |
|------------------|--------|
| 2 MHz to ≤ 4 GHz | 100 dB |
| 4 GHz to ≤ 6 GHz | 90 dB |

Sweep Speed (Typical)

Sweep speed in μs/point for IF Bandwidth of 100 kHz, 1001 data points, and single display. The two-receiver architecture will simultaneously collect S₂₁ and S₁₁ in a single sweep.

| | |
|------------------|--------------|
| 500 kHz to 6 GHz | 850 μs/point |
|------------------|--------------|

Noise Floor

| Frequency | Noise Floor (typical) |
|------------------|-----------------------|
| 500 kHz to 3 GHz | -100 dBm |
| 3 GHz to 4 GHz | -103 dBm |
| 4 GHz to 6 GHz | -93 dBm |

Temperature Stability (S₁₁ or S₂₁, Short, 23 °C ± 5 °C)

| Frequency Range | Magnitude (typical) | Phase (typical) |
|--------------------|---------------------|-----------------|
| 500 kHz to < 6 GHz | 0.020 dB/°C | 0.200 deg/°C |

Interference Immunity

| | |
|--------------|--|
| On-Channel | +17 dBm at > 1.0 MHz from carrier frequency |
| On-Frequency | 0 dBm within ± 10 kHz of the carrier frequency |



VNA Functional Specifications

Measurements

| | |
|-------------------------------------|---|
| Measurement Parameters | S_{11}, S_{21} |
| Number of Traces | Four: TR1, TR2, TR3, TR4 |
| Trace Format | Single, Dual, Tri, Quad. When used with Number of Traces, overlays are possible including a Single Format with Four trace overlays. |
| Graph Types | Log Magnitude, SWR, Phase, Real, Imaginary, Group Delay, Smith Chart, Log Mag/2 (1-Port Cable Loss), Linear Polar, Log Polar, Real Impedance, Imaginary Impedance |
| Domains | Frequency Domain, Distance Domain |
| Frequency | Start Frequency, Stop Frequency, Center Frequency, Span |
| Distance | Start Distance, Stop Distance |
| Frequency Sweep Type: Linear | Single Sweep, Continuous |
| Data Points | 2 to 4001 (arbitrary setting); data points can be reduced without recalibration. |
| Limit Lines | Upper, Lower, 10 segmented Upper, 10 segmented Lower |
| Test Limits | Pass/Fail for Upper, Pass/Fail for Lower, Limit Audible Alarm |
| Data Averaging | Sweep-by-sweep |
| Smoothing | 0 to 20 % |
| IF Bandwidth | 10, 20, 50, 100, 200, 500, 1 k, 2 k, 5 k, 10 k, 20 k, 50 k, 100 k (Hz) |
| Reference Plane | The reference planes of a calibration (or other normalization) can be changed by entering a line length. Assumes no loss, flat magnitude, linear phase, and constant impedance. |
| Auto Reference Plane Extension | Instead of manually entering a line length, this feature automatically adjusts phase shift from the current calibration (or other normalization) to compensate for external cables (or test fixtures). Assumes no loss, flat magnitude, linear phase, and constant impedance. |
| Frequency Range | Frequency range of the measurement can be narrowed (reduces number of data points) within the calibration range without recalibration. When Interpolation is On, narrowed frequency range will retain original number of data points. |
| Group Delay Aperture | Defined as the frequency span over which the phase change is computed at a given frequency point. The aperture can be changed without recalibration. The minimum aperture is the frequency range divided by the number of points in calibration and can be increased to 20% of the frequency range. |
| Group Delay Range | < 180° of phase change within the aperture |
| Trace Memory | A separate memory for each trace can be used to store measurement data for later display. The trace data can be saved and recalled. |
| Trace Math | Complex trace math operations of subtraction, addition, multiplication, or division are provided. |
| Number of Markers | 12, arbitrary assignments to any trace |
| Marker Types | Reference, Delta |
| Marker Readout Styles | Log Mag, Cable Loss (Log Mag/2), Log Mag and Phase, Phase, Real and Imaginary, SWR, Impedance, Admittance, Normalized Impedance, Normalized Admittance, Polar Impedance, and Group Delay |
| Marker Search | Peak Search, Valley Search, Find Marker Value |
| Calibration Type | Full S_{11} , 1-Path, 2-Port (S_{11} and S_{21}), Response S_{11} , Response S_{21} |
| Calibration Methods | Short-Open-Load-Through (SOLT) |
| Calibration Standards' Coefficients | Coax: N-Connector, K-Connector, 7/16, TNC, SMA, and four User Defined |
| Cal Correction Toggle | On/Off |
| Interpolation | On/Off (Interpolation may be activated before or after calibration) |
| Impedance Conversion (Smith Chart) | Support for 50 Ω and 75 Ω are provided. |
| Units | Meters, Feet |
| Bias Tee Settings | Internal, Off |
| Timebase Reference | Internal |
| File Storage Types | Measurement, Setup (with CAL), Setup (without CAL), S2P (Real/Imag), S2P (Lin Mag/Phase), S2P (Log Mag/Phase), JPEG |
| Ethernet Configuration | DHCP or Manual (Static); IP, Gateway, Subnet entries |
| Languages | English, French, German, Spanish, Chinese, Japanese, Korean, Italian, Russian plus one User Defined |

Corrected System Performance and Uncertainties — High Port Power, N-Type

Measurement Accuracy¹ OSLN50A-8 or OSLNF50A-8, TOSLN50A-8 or TOSLNF50A-8.

| Frequency Range | Directivity (dB) | Source Match (dB) | Reflection Tracking (dB) | Transmission Tracking (dB) |
|-------------------|------------------|-------------------|--------------------------|----------------------------|
| < 20 MHz | ≥ 42 | ≥ 30 | ± 0.01 | ± 0.01 |
| 20 MHz to < 3 GHz | ≥ 42 | ≥ 30 | ± 0.05 | ± 0.01 |
| 3 GHz to 6 GHz | ≥ 42 | ≥ 30 | ± 0.05 | ± 0.01 |

Corrected Measurement Uncertainty (Transmission from Port 1 to Port 2)

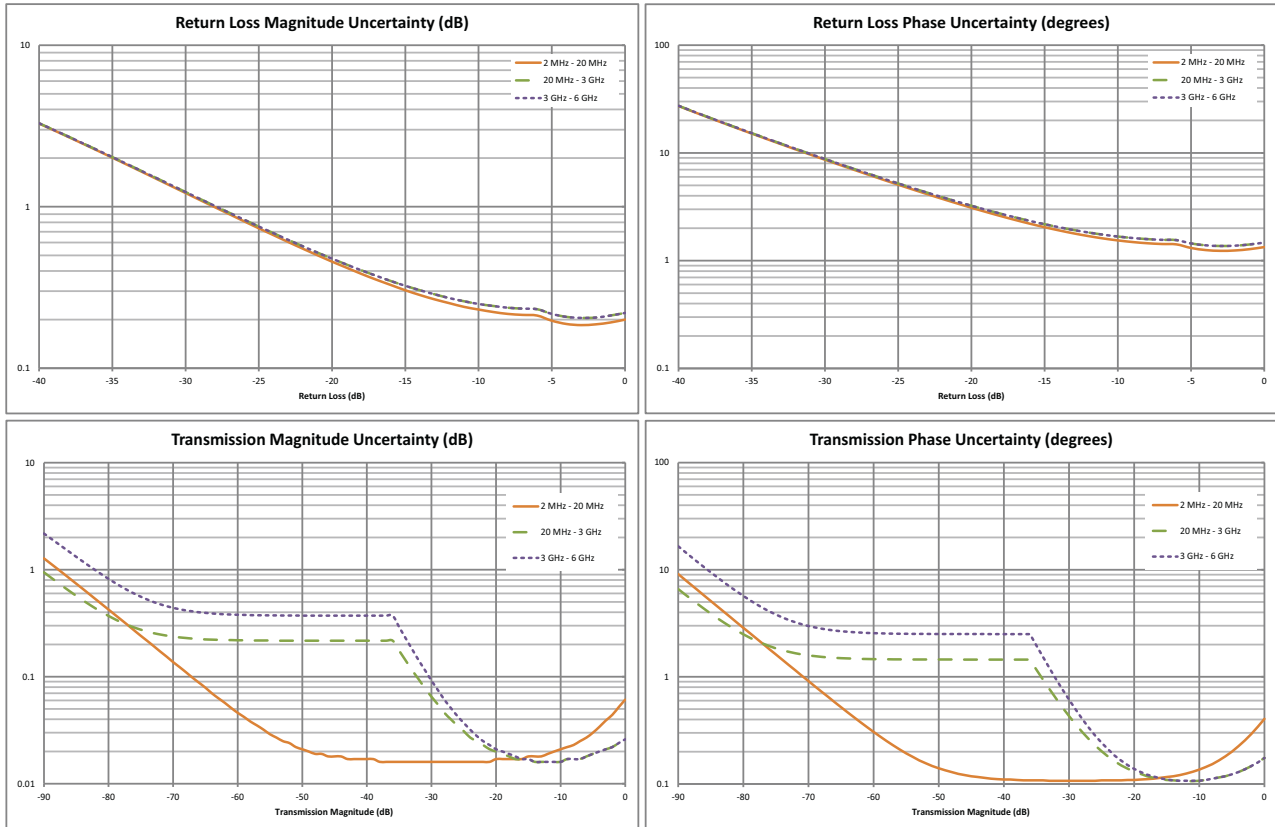

1. Full 1-path, 2-port forward path calibration with isolation, high power, 10 Hz IFBW, no averaging, 10 minute warm-up. OSLN50A-8, OSLNF50A-8, TOSLN50A-8, or TOSLNF50A-8 calibration kit. Reflection and Transmission Tracking are typical.

Corrected System Performance and Uncertainties — High Port Power, K-Type

Measurement Accuracy¹ TOSLK50A-20 or TOSLKF50A-20. Compatible with 3.5 mm and SMA connectors.

| Frequency Range | Directivity (dB) | Source Match (dB) | Reflection Tracking (dB) | Transmission Tracking (dB) |
|-------------------|------------------|-------------------|--------------------------|----------------------------|
| < 20 MHz | ≥ 42 | ≥ 33 | ± 0.01 | ± 0.01 |
| 20 MHz to < 3 GHz | ≥ 42 | ≥ 33 | ± 0.05 | ± 0.01 |
| 3 GHz to 6 GHz | ≥ 42 | ≥ 33 | ± 0.05 | ± 0.01 |

Corrected Measurement Uncertainty (Transmission from Port 1 to Port 2)

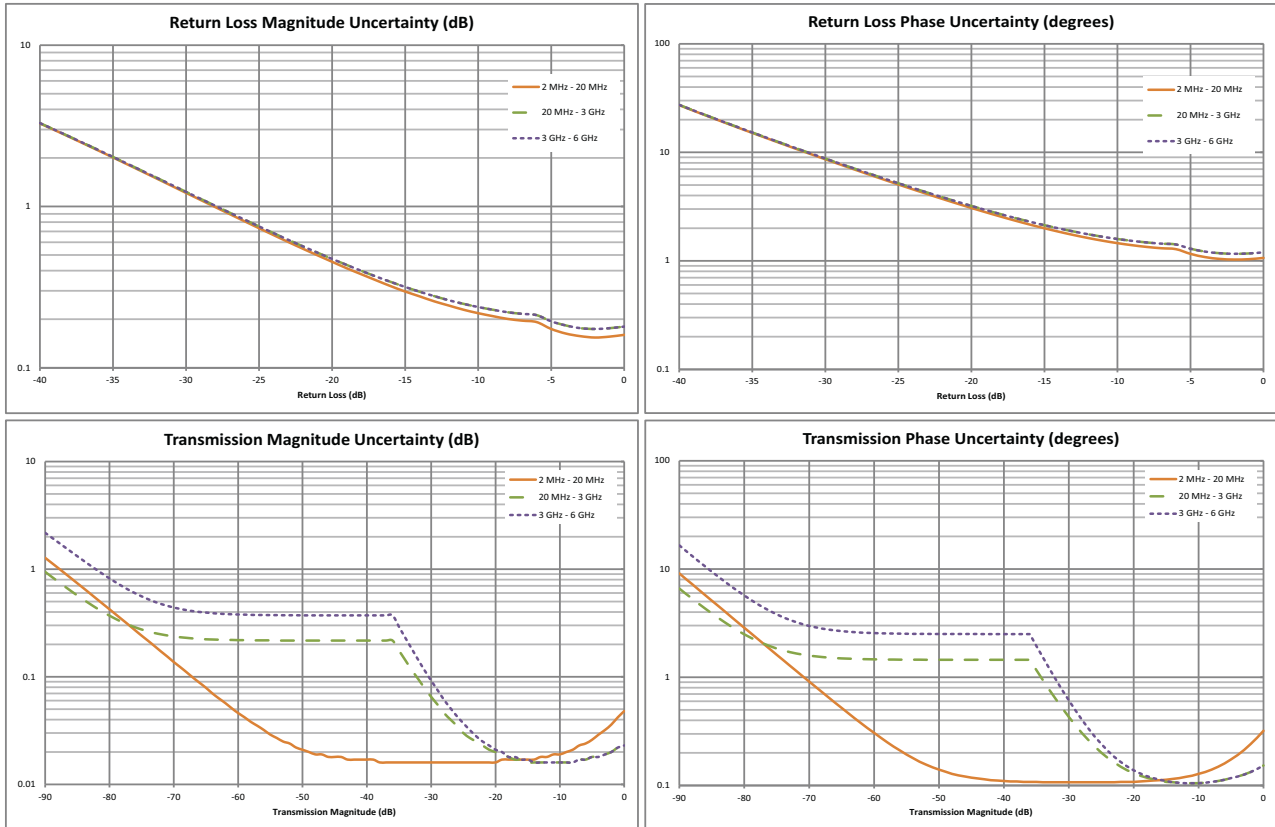

1. Full 1-path, 2-port forward path calibration with isolation, high power, 10 Hz IFBW, no averaging, 10 minute warm-up. TOSLK50A-20, TOSLKF50A-20 calibration kit. Reflection and Transmission Tracking are typical.



Spectrum Analyzer Performance Specifications (Models MS203xB only)

Measurements

| | |
|--------------------|---|
| Smart Measurements | Field Strength (Uses antenna calibration tables to measure dBm/m ² , dBmV/m, dBV/m, dBμV/m, Volt/m, Watt/m ² , dBW/m ² , A/m, dBA/m and Watt/cm ²) Occupied Bandwidth (Measures 99 % to 1 % power channel of a signal) Channel Power (Measures the total power in a specified bandwidth) ACPR (Adjacent Channel Power Ratio) AM/FM/SSB Demodulation (Wide/narrow FM, USB and LSB), (audio out only) C/I (Carrier-to-interference ratio) Emission Mask Coverage Mapping (requires Option 431) PIM Alert Application (Available for download) PIM Hunting |
|--------------------|---|

Setup Parameters

| | |
|---------------------|--|
| Frequency | Center/Start/Stop, Span, Frequency Step, Signal Standard, Channel #, Channel Increment |
| Amplitude | Reference Level (RL), Scale, Attenuation Auto/Level, RL Offset, Pre-Amp On/Off, Detection |
| Span | Span, Span Up/Down (1-2-5), Full Span, Zero Span, Last Span |
| Bandwidth | RBW, Auto RBW, VBW, Auto VBW, RBW/VBW, Span/RBW |
| File | Save, Save-on-Event, Recall, Copy, Delete |
| Save-on-Event | Save, Measurements, Screen Shots (JPEG), Limit Lines, Spurious Emission Mask |
| Recall | Crossing Limit Line, Sweep Complete, Save-then-Stop, Clear All |
| Copy | Setups, Measurements, Limit Lines, Spurious Emission Mask |
| Delete | Selected file or files to internal/external memory (USB) |
| Application Options | Selected file or files from internal/external memory (USB) Bias-Tee (On/Off), Impedance (50 Ω, 75 Ω, Other) |

Sweep Functions

| | |
|-----------|--|
| Sweep | Single/Continuous, Sweep Mode (Fast, Performance, No FFT), Reset, Detection, Minimum Sweep Time, Trigger Type, Gated Sweep (see Option 90) |
| Detection | Peak, RMS, Negative, Sample, Quasi-peak |
| Triggers | Free Run, External, Video, Change Position, Manual |

Trace Functions

| | |
|--------------------|--|
| Traces | Up to three Traces (A, B, C), View/Blank, Write/Hold, Trace A/B/C Operations |
| Trace A Operations | Normal, Max Hold, Min Hold, Average, # of Averages, (always the live trace) |
| Trace B Operations | A → B, B ↔ C, Max Hold, Min Hold |
| Trace C Operations | A → C, B ↔ C, Max Hold, Min Hold, A - B → C, B - A → C, Relative Reference (dB), Scale |

Marker Functions

| | |
|----------------------|---|
| Markers | Markers 1-6 each with a Delta Marker, or Marker 1 Reference with Six Delta Markers, Marker Table (On/Off), All Markers Off |
| Marker Types | Style (Fixed/Tracking), Noise Marker, Frequency Counter Marker |
| Marker Auto-Position | Peak Search, Next Peak (Right/Left), Peak Threshold %, Set Marker to Channel, Marker Frequency to Center, Delta Marker to Span, Marker to Reference Level |
| Marker Table | 1-6 markers frequency and amplitude plus delta markers frequency amplitude and offset |

Limit Line Functions

| | |
|---------------------|--|
| Limit Lines | Upper/Lower, On/Off, Edit, Move, Envelope, Advanced, Limit Alarm, Default Limit |
| Limit Line Edit | Frequency, Amplitude, Add Point, Add Vertical, Delete Point, Next Point Left/Right |
| Limit Line Move | To Current Center Frequency, By dB or Hz, To Marker 1, Offset from Marker 1 |
| Limit Line Envelope | Create Envelope, Update Amplitude, Points (41 max), Offset, Shape Square/Slope |
| Limit Line Advanced | Type (Absolute/Relative), Mirror, Save/Recall |

Frequency

| | |
|---------------------|--|
| Frequency Range | 9 kHz to 4 GHz (MS2034B), 9 kHz to 6 GHz (MS2035B) (tunable to 0 Hz) |
| Tuning Resolution | 1 Hz |
| Frequency Reference | Aging: ± 1.0 ppm/year Accuracy: ± 1.5 ppm (25 °C ± 25 °C) + aging, < ± 50 ppb with GPS On |
| Frequency Span | 10 Hz to 4 GHz including zero span (MS2034B), 10 Hz to 6 GHz including zero span (MS2035B) |
| Sweep Time | Minimum 100 ms, 7 μs to 3600 s in zero span |
| Sweep Time Accuracy | ± 2 % in zero span |

Bandwidth

| | |
|-------------------------------|---|
| Resolution Bandwidth (RBW) | 10 Hz to 3 MHz in 1-3 sequence ± 10% (1 MHz max in zero-span) (-3 dB bandwidth) |
| Video Bandwidth (VBW) | 1 Hz to 3 MHz in 1-3 sequence (-3 dB bandwidth) (auto or manually selectable) |
| RBW with Quasi-Peak Detection | 200 Hz, 9 kHz, 120 kHz (-6 dB bandwidth) |
| VBW with Quasi-Peak Detection | Auto VBW is On, RBW/VBW = 1 |



Spectrum Analyzer Functional Specifications (Models MS203xB only)

Spectral Purity

SSB Phase Noise @ 1 GHz -100 dBc/Hz, -110 dBc/Hz typical @ 10 kHz offset
 -105 dBc/Hz, -112 dBc/Hz typical @ 100 kHz offset
 -115 dBc/Hz, -121 dBc/Hz typical @ 1 MHz offset

Amplitude Ranges

Dynamic Range > 102 dB (2.4 GHz), 2/3 (TOI-DANL) in 1 Hz RBW
 Measurement Range DANL to +26 dBm (≥ 50 MHz)
 DANL to 0 dBm (< 50 MHz)
 Display Range 1 dB to 15 dB/div in 1 dB steps, ten divisions displayed
 Reference Level Range -150 dBm to +30 dBm
 Attenuator Range 0 dB to 55 dB in 5 dB steps
 Maximum Continuous Input +30 dBm
 Amplitude Units Log Scale Modes: dBW, dBm, dBμW, dBV, dBmV, dBμV, dBA, dBmA, dBμA
 Linear Scale Modes: nV, μV, mV, V, kV, nW, μW, mW, W, kW, nA, μA, mA, A

Amplitude Accuracy

9 kHz to 100 kHz ± 2.0 dB typical (Preamp Off)
 100 kHz to 4.0 GHz ± 1.25 dB, ± 0.5 dB typical
 > 4.0 GHz to 6 GHz ± 1.50 dB, ± 0.5 dB typical

Displayed Average Noise Level (DANL)

| (RBW Normalized to 1 Hz, 0 dB attenuation) | Preamp Off (Reference Level -20 dBm) | | Preamp On (Reference Level -50 dBm) | |
|--|---|----------|--|----------|
| | Maximum | Typical | Maximum | Typical |
| 10 MHz to 2.4 GHz | -141 dBm | -146 dBm | -157 dBm | -162 dBm |
| > 2.4 GHz to 4 GHz | -137 dBm | -141 dBm | -154 dBm | -159 dBm |
| > 4 GHz to 5 GHz | -134 dBm | -138 dBm | -150 dBm | -155 dBm |
| > 5 GHz to 6 GHz | -126 dBm | -131 dBm | -143 dBm | -150 dBm |

Spurs

Residual Spurious < -90 dBm (RF input terminated, 0 dB input attenuation, > 10 MHz)
 Input-Related Spurious < -75 dBc (0 dB attenuation, -30 dBm input, span < 1.7 GHz, carrier offset > 4.5 MHz)
 Exceptions, typical < -70 dBc @ <2.5 GHz, with 2072.5 MHz Input
 < -68 dBc @ F1 - 280 MHz with F1 Input
 < -70 dBc @ F1 + 190.5 MHz with F1 Input
 < -52 dBc @ 7349 - (2F2) MHz, with F2 Input, where F2 < 2437.5 MHz
 < -55 dBc @ 190.5 ± (F1/2) MHz, F1 < 1 GHz

Third-Order Intercept (TOI)

Preamp Off (-20 dBm tones 100 kHz apart, 10 dB attenuation)
 800 MHz +16 dBm
 2400 MHz +20 dBm
 200-2200 MHz +25 dBm, typical
 > 2.2 GHz to 5.0 GHz +28 dBm, typical
 > 5.0 GHz to 6.0 GHz +33 dBm, typical

Second Harmonic Distortion

Preamp Off, 0 dB input attenuation, -30 dBm input
 50 MHz -56 dBc
 > 50 MHz to 200 MHz -60 dBc, typical
 > 200 MHz to 3000 MHz -70 dBc, typical

VSWR

2:1, typical



Bias Tee (Option 10)

Bias Tee Measurements

For tower mounted amplifier tests, the MS202xB/MS203xB series with optional internal bias tees can supply both DC and RF signals on the center conductor of the cable during measurements. For frequency sweeps in excess of 2 MHz, the VNA Master can supply internal voltage control from +12 to +32 V in 0.1 V steps up to 450 mA. Bias can be directed to VNA Port 2 or to the Spectrum Analyzer Input Port (MS203xB).

Bias Tee Specifications

| | |
|--------------------------|---|
| Frequency Range | |
| MS20x4B | 2 MHz to 4 GHz |
| MS20x5B | 2 MHz to 6 GHz |
| Internal Voltage/Current | +12 V to +32 V at 450 mA (1 A surge for 100 ms) |
| Internal Resolution | 0.1 V |
| Bias Tee Selections | Internal, Off |

The Compact VNA Master offers optional integrated bias tee for supplying DC plus RF to the DUT as shown in this simplified block diagram.

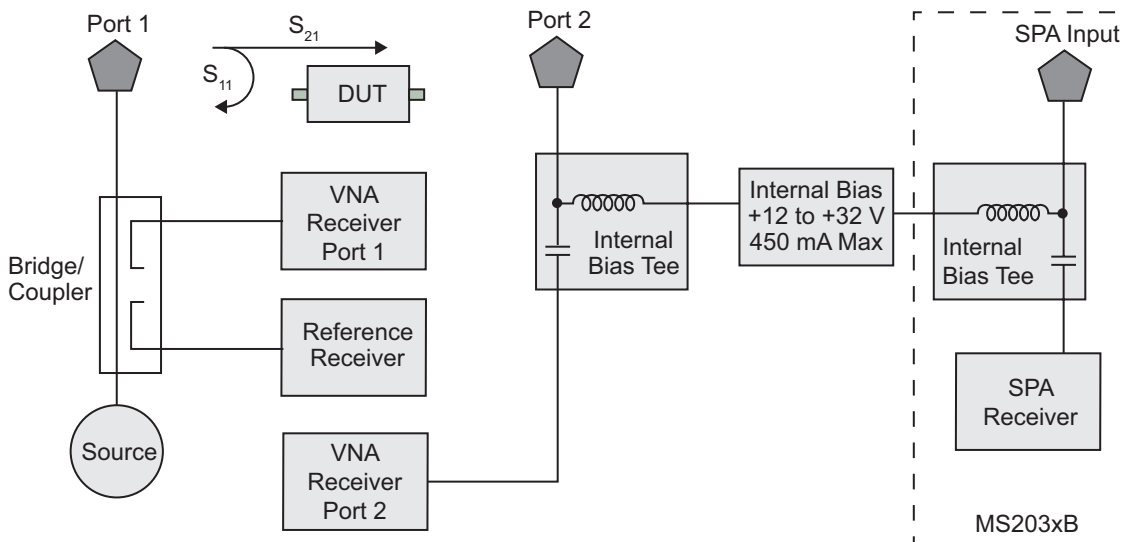

Vector Voltmeter (Option 15)

A phased array system relies on phase matched cables for nominal performance. For this class of application, the VNA Master offers this special software mode to simplify phase matching cables at a single frequency. The similarity between the popular vector voltmeter and this software mode ensures minimal training is required to phase match cables. Operation is as simple as configuring the display for absolute or relative measurements. The easy-to-read large fonts show either reflection or transmission measurements using impedance, magnitude, or VSWR readouts. For instrument landing system (ILS) or VHF Omnidirectional Range (VOR) applications, a table view improves operator efficiency when phase matching up to twelve cables. The MS202xB/MS203xB solution is superior because the signal source is included internally, precluding the need for an external signal generator.

VVM Specifications

| | |
|---------------------|--|
| CW Frequency Range | 500 kHz to 4/6 GHz |
| Source Power | High, Default, Low |
| IFBW | 10 Hz to 100 kHz in 1-2-5 sequence |
| Measurement Display | CW, Table (twelve entries, plus reference) |
| Measurement Types | Return Loss, Insertion |
| Measurement Format | dB/VSWR/Impedance |



Distance Domain (Formerly Option 501, now standard with firmware v1.20 or greater)

Distance-to-Fault Analysis (standard with firmware v1.20 and above) is a powerful field test tool to analyze cables for faults, including minor discontinuities that may occur due to a loose connection, corrosion, or other aging effects. By using Frequency Domain Reflectometry (FDR), the Compact VNA Master exploits a user-specified band of full power operational frequencies (instead of DC pulses from TDR approaches) to more precisely identify discontinuities. The Compact VNA Master converts S-parameters from frequency domain into distance domain on the horizontal display axis, using a mathematical computation called Inverse Fourier Transform. Connect a reflection at the opposite end of the cable, and the discontinuities appear versus distance to reveal any potential maintenance issues. When access to both ends of the cable is convenient, a similar distance domain analysis is available on transmission measurements.

Distance Domain, will improve your productivity with displays of the cable in terms of discontinuities versus distance. This readout can then be compared against previous measurements (from stored data) to determine whether any degradations have occurred since installation (or the last maintenance activity). More importantly, you will know precisely where to go to fix the problem and so minimize or prevent downtime of the system.



High Accuracy Power Meter (Option 19) (Requires external USB power sensor, sold separately)

| | | | | | |
|--|--|---------------------------------------|--|---|---|
| Amplitude | Maximum, Minimum, Offset, Relative On/Off, Units, Auto Scale | | | | |
| Average | # of Running Averages, Max Hold | | | | |
| Zero/Cal | Zero On/Off, Cal Factor (Center Frequency, Signal Standard) | | | | |
| Limits | Limit On/Off, Limit Upper/Lower | | | | |
| Power Sensor Model | MA24105A | MA24106A | MA24108A/18A/26A | MA24208A/18A | MA24330A/40A/50A |
| Description | Inline High Power Sensor | High Accuracy RF Power Sensor | Microwave USB Power Sensor | Microwave Universal USB Power Sensor | Microwave CW USB Power Sensor |
| Frequency Range | 350 MHz to 4 GHz | 50 MHz to 6 GHz | 10 MHz to 8/18/26 GHz | 10 MHz to 8/18 GHz | 10 MHz to 33/40/50 GHz |
| Connector | Type N(f), 50 Ω | Type N(m), 50 Ω | Type N(m), 50 Ω (8/18 GHz) Type K(m), 50 Ω (26 GHz) | Type N(m), 50 Ω | Type K(m), 50 Ω (33/40 GHz) Type V(m), 50 Ω (50 GHz) |
| Dynamic Range | +3 dBm to +51.76 dBm (2 mW to 150 W) | -40 dBm to +23 dBm (0.1 μW to 200 mW) | -40 dBm to +20 dBm (0.1 μW to 100 mW) | -60 dBm to +20 dBm (1 nW to 100 mW) | -70 dBm to +20 dBm (0.1 nW to 100 mW) |
| Measurand | True-RMS | True-RMS | True-RMS, Slot Power, Burst Average Power | True-RMS, Slot Power, Burst Average Power | Average Power |
| Measurement Uncertainty | ± 0.17 dB ^a | ± 0.16 dB ^b | ± 0.18 dB ^c | ± 0.17 dB ^d | ± 0.17 dB ^e |
| Data sheet (for complete specifications) | 11410-00621 | 11410-00424 | 11410-00504 | 11410-00841 | 11410-00906 |

- Notes:
- a. Expanded uncertainty with K=2 for power measurements of a CW signal greater than +20 dBm with a matched load. Measurement results referenced to the input side of the sensor.
 - b. Total RSS measurement uncertainty (0 °C to 50 °C) for power measurements of a CW signal greater than -20 dBm with zero mismatch errors.
 - c. Expanded uncertainty with K=2 for power measurements of a CW signal greater than -20 dBm with zero mismatch errors.
 - d. Power uncertainty expressed with two sigma confidence level for CW measurement after zero operation. Includes calibration factor and linearity over temperature uncertainties, but not the effects of mismatch, zero set and drift, or noise.
 - e. Includes linearity over temperature uncertainties, but not the effects of calibration factor, mismatch, zero set and drift, and noise.



Interference Analyzer (Option 25) (Models MS203xB only, GPS Option 31 recommended)

Measurements

| | |
|---|--|
| Spectrum | Field Strength Occupied Bandwidth Channel Power Adjacent Channel Power (ACPR) AM/FM/SSB Demodulation (Wide/Narrow FM, Upper/Lower SSB - audio out only) Carrier-to-Interference ratio (C/I) |
| Spectrogram | Collect data up 72 hours |
| Signal Strength | Gives visual and aural indication of signal strength |
| Received Signal Strength Indicator (RSSI) | Collect data up to 168 hours (one week) |
| Signal ID | Up to 12 signals Center Frequency Bandwidth Signal Type: FM, GSM, W-CDMA, CDMA, Wi-Fi Closest Channel Number Number of Carriers |
| Signal-to-Nose Ratio (SNR) | > 10 dB |
| Interference Mapping | Triangulate location of interference with on-display maps |
| Application Options | Bias-Tee (On/Off), Impedance (50 Ω, 75 Ω, Other) |



Channel Scanner (Option 27) (Models MS203xB only, GPS Option 31 recommended)

General

| | |
|---------------------|--|
| Number of Channels | 1 to 20 Channels |
| Measurements | Graph/Table, Max Hold (On/5 s/Off), Freq/Channel, Current/Max, Single/Dual Color |
| Scanner | Scan Channels, Scan Frequencies, Scan Customer List, Scan Script Master™ |
| Amplitude | Reference Level, Scale |
| Custom Scan | Signal Standard, Channel, # of Channels, Channel Step Size, Custom Scan |
| Frequency Range | 9 kHz to 4 GHz (MS2034B), 9 kHz to 6 GHz (MS2035B) |
| Frequency Accuracy | ± 10 Hz + Time base error |
| Measurement Range | -110 dBm to +26 dBm |
| Application Options | Bias-Tee (On/Off), Impedance (50 Ω, 75 Ω, Other) |



GPS (Option 31) (requires external GPS antenna, sold separately)

Built-in GPS provides location information (latitude, longitude, altitude) and Universal Time (UT) information for storage along with trace data so that you can later verify that measurements were taken at the right location. The GPS option requires a separately ordered Anritsu GPS antenna. Frequency accuracy is enhanced for the Spectrum Analyzer (on MS203xB models) when GPS is active and has achieved satellite lock.

GPS Specifications

| | |
|-----------------------------|---|
| Setup | On/Off, Antenna Voltage 3.3/5.0 V, GPS Info |
| GPS Time/Location Indicator | Time, Latitude, Longitude and Altitude on display Time, Latitude, Longitude and Altitude with trace storage |
| High Frequency Accuracy | Spectrum Analyzer, Interference Analyzer, CW Signal Analyzers < ± 50 ppb with GPS On, GPS antenna connected, 3 minutes after satellite lock in selected mode |
| Connector | SMA, Female |



Coverage Mapping (Option 431) (Models MS203xB only. Requires GPS)

Measurements

| | |
|-----------------|---------------|
| Indoor Mapping | RSSI and ACPR |
| Outdoor Mapping | RSSI and ACPR |

Setup Parameters

| | |
|-----------------------------|---|
| Frequency | Center/Start/Stop, Span, Freq Step, Signal Standard, Channel #, Channel Increment |
| Amplitude | Reference Level (RL), Scale, Attenuation Auto/Level, RL Offset, Pre-Amp On/Off, Detection |
| Span | Span, Span Up/Down (1-2-5), Full Span, Zero Span, Last Span |
| BW | RBW, Auto RBW, VBW, Auto VBW, RBW/VBW, Span/VBW |
| Measurement Setup | ACPR, RSSI |
| Point Distance / Time Setup | Repeat Type Time Distance |
| Save Points Map | Save KML, JPEG, Tab Delimited |
| Recall Points Map | Recall Map, Recall KML Points only, Recall KML Points with Map, Recall Default Grid |

Ethernet Connectivity

(Formerly Option 411)

| | |
|--------------------|--|
| Connector | RJ45 |
| LAN Speed | 10 Mbps |
| Mode | Static, DHCP |
| Static IP settings | IP address, Subnet Mask, IP Gateway |
| Remote Control | Fully remote programmable via SCPI commands and/or remote access utility provided with Master Software Tools |
| Data Upload | With Line Sweep Tools or Master Software Tools through a LAN connection |



AM/FM/PM Demodulation Analyzer (Option 509) (Models MS203xB only)

Measurements

| Display Type | RF Spectrum (AM/FM/PM) | Audio Spectrum (AM) | Audio Spectrum (FM/PM) | Audio Waveform (AM) | Audio Waveform (FM/PM) | Summary (AM) | Summary (FM/PM) |
|--------------------|---|---|--|---|--|--|---|
| Graphic Display | Power (dBm) vs. Frequency | Depth (%) vs. Modulation Frequency | Deviation (kHz/rad) vs. Modulation Frequency | Depth (%) vs. Time | Deviation (kHz/rad) vs. Time | None | None |
| Numerical Displays | Carrier Power Carrier Frequency Occupied BW | AM Rate RMS Depth (Pk-Pk)/2 Depth SINAD* THD* Distortion/Total Vrms* | FM/PM Rate RMS Deviation (Pk-Pk)/2 Deviation SINAD* THD* Distortion/Total Vrms* | AM Rate RMS Depth (Pk-Pk)/2 Depth SINAD* THD* Distortion/Total Vrms* | FM/PM Rate RMS Deviation (Pk-Pk)/2 Deviation SINAD* THD* Distortion/Total Vrms* | RMS Depth (AM) Peak + Depth Peak - Depth (Pk-Pk)/2 Depth Carrier Power Carrier Frequency Occupied Bandwidth AM Rate SINAD* THD* Distortion/Total Vrms* | RMS Deviation (FM/PM) Peak + Depth Peak - Depth (Pk-Pk)/2 Depth Carrier Power Carrier Frequency Occupied Bandwidth AM Rate SINAD* THD* Distortion/Total Vrms* |

* Requires Sinewave modulation

Setup Parameters

| | |
|--------------|---|
| Frequency | Center Freq, Span, Freq Step, Signal Standard, Channel, Channel Increment, Set Carrier Freq |
| Amplitude | Scale, Power Offset, Adjust Range |
| Setup | Demod Type (AM, FM, PM), IFBW, Auto IFBW |
| Measurements | RF Spectrum AM/FM/PM, Audio Spectrum (AM/FM/PM), Audio Waveform (AM/FM/PM), Summary (AM/FM/PM), Average |
| Marker | On/Off, Delta, Peak Search, Marker Freq to Center, Marker to Ref Lvl, Marker Table, All Markers Off |

Specifications

| | |
|----------------|---|
| AM | Modulation Rate: ± 1 Hz (< 100 Hz); ± 2 % (> 100 Hz) Depth: ± 5 % for (Modulation rates 10 Hz to 100 kHz) |
| FM | Modulation Rate: ± 1 Hz (< 100 Hz); ± 2 % (100 Hz to 100 kHz) Deviation Accuracy: ± 5 % (100 Hz to 100 kHz)** |
| PM | Modulation Rate: ± 1 Hz (< 100 Hz); ± 2 % (100 Hz to 100 kHz) Deviation Accuracy: ± 5 % (deviation 0 to 93 rad, rate 10 Hz to 5 kHz)** |
| IF bandwidth | 1 kHz to 300 kHz in 1-3 sequence |
| Frequency Span | RF Spectrum: 10 kHz to 10 MHz Audio Spectrum: 2 kHz, 5 kHz, 10 kHz, 20 kHz, 70 kHz, 140 kHz |
| RBW/VBW | 30 |
| Span/RBW | 100 |
| Sweep time | 50 μ s to 50 ms (Audio Waveform) |
| ** | IFBW must be greater than 95 % occupied BW |



General Specifications

| | | |
|-----------------------------|--|--|
| Maximum Input | | (Damage Level) |
| VNA Port 1 or 2 | | +23 dBm, \pm 50 VDC |
| Spectrum Analyzer Port | | +30 dBm peak, \pm 50 VDC, Maximum Continuous Input, \geq 10 dB attenuation (Models MS203xB, spectrum analyzer input port only) |
| System Parameters | | |
| System | | Status (Temperature, Battery Info, Serial Number, Firmware Version, Options Installed) Self Test, Application Self Test GPS (see Option 31) |
| System Options | | Name, Date and Time, Ethernet Configuration, Brightness, Volume, Language (English, French, German, Spanish, Chinese, Japanese, Korean, Italian, Russian, Portuguese), Reset (Factory Defaults, Master Reset, Update Firmware) |
| Internal Trace/Setup Memory | | 2000 traces, 2000 setups |
| External Trace/Setup Memory | | Limited by size of USB Flash drive |
| Mode Switching | | Auto-Stores/Recalls most recently used Setup Parameters in the Mode |
| File Management | | |
| File Types | | Vary with measurement mode |
| File | | Save, Recall, Copy, Delete |
| Save | | Setups, Measurements, Screen Shots (JPEG) |
| Recall | | Setups, Measurements |
| Copy | | Selected file or files to internal/external memory (USB) |
| Delete | | Selected file or files from internal/external memory (USB) |
| File Sort Method | | By Name/Date/Type, Ascend/Descend |
| Connectors | | |
| VNA Port 1 or 2 | | Type N, female, 50 Ω |
| Spectrum Analyzer Port | | Type N, female, 50 Ω (MS203xB only) |
| GPS | | SMA, female |
| External Power | | 5.5 mm barrel connector, 12.5 VDC to 15 VDC, < 4.0 Amps |
| USB Interface (2) | | Type A, Connect Flash Drive and Power Sensor |
| USB Interface | | 5-pin mini-B, Connect to PC for data transfer |
| Headset Jack | | 3.5 mm barrel connector |
| External Reference In | | BNC, female, Maximum Input \pm 5 VDC 1 MHz, 5 MHz, 10 MHz, 13 MHz |
| External Trigger | | BNC, female, Maximum Input \pm 5 VDC |
| Ethernet | | RJ45 connector for Ethernet 10/100-BaseT |
| Display | | |
| Type | | Resistive Touch Screen |
| Size | | 8.4 in, daylight viewable color LCD |
| Resolution | | 800 x 600 |
| Pixel Defects | | No more than five defective pixels (99.9989% good pixels) |
| Power | | |
| Field replaceable battery | | Li-Ion, 633-75, 7500 mAh 40 W on battery power only |
| DC Power | | Universal 110/220 V AC/DC Adapter 55 W running off AC/DC adaptor while charging battery |
| Life time charging cycles | | > 300 (80 % of initial capacity) |
| Battery Operation | | 3.6 hours, typical |
| Battery Charging Limits | | 0 $^{\circ}$ C to +45 $^{\circ}$ C, Relative Humidity \leq 80 % |



General Specifications (continued)

Regulatory Compliance

| | |
|---------------------------|--|
| European Union | EMC 2014/30/EU, EN 61326-1:2013 CISPR 11/EN 55011, IEC/EN 61000-4-2/3/4/5/6/8/11 Low Voltage Directive 2014/35/EU Safety EN 61010-1:2010 RoHS Directive 2011/65/EU + 2015/863 |
| United Kingdom | EMC SI 2016/1091; BS EN 55011 & BS 61000-4-2/3/4/5/6/8/11 Consumer Protection (Safety) SI 2016/1101; BS EN 61010-1:2010 Environmental Protection SI 2012/3032; 2011/65/EU & 2015/863 |
| Australia and New Zealand | RCM AS/NZS 4417:2012 |
| South Korea | KCC-REM-A21+-0004 |
| Canada | ICES-1(A)/NMB-1(A) |

Environmental

| | |
|-----------------------------|---|
| | MIL-PRF-28800F Class 2 |
| Operating Temperature Range | -10 °C to 55 °C |
| Storage Temperature Range | -51 °C to 71 °C |
| Maximum Relative Humidity | 95 % RH at 30 °C, non-condensing |
| Vibration, Sinusoidal | 5 Hz to 55 Hz |
| Vibration, Random | 10 Hz to 500 Hz |
| Half Sine Shock | 30 g _n |
| Altitude | 4600 meters, operating and non-operating |
| Explosive Atmosphere | MIL-PRF-28800F Section 4.5.6.3 MIL-STD-810G, Method 511.5, Procedure 1 |

Size and Weight

| | |
|---------------------------|---|
| Dimensions | 273 mm x 199 mm x 91 mm (10.7 in x 7.8 in x 3.6 in) |
| Weight, Including Battery | 3.5 kg (7.6 lb) |

Warranty

| | |
|----------|--|
| Duration | Standard three-year warranty (battery one-year warranty) |
|----------|--|



Line Sweep Tools (for your PC)

| | | |
|--------------------------|--|---|
| Trace Capture | | |
| Browse to Instrument | | View and copy traces from the test equipment to your PC using Windows Explorer |
| Open Legacy Files | | Open DAT files captured with Hand Held Software Tools v6.61 |
| Open Current Files | | Open VNA or DAT files |
| Capture plots To | | The Line Sweep Tools screen, DAT files, Database, or JPEG |
| Traces | | |
| Trace Types | | Return Loss, VSWR, DTF-RL, DTF-VSWR, Cable Loss, and Smith Chart |
| Trace Formats | | DAT, VNA, CSV, PNG, BMP, JPG, HTML, Data Base, and PDF |
| Report Generation | | |
| Report Generator | | Includes GPS location along with measurements |
| Report Format | | Create reports in HTML or PDF format |
| Report Setup | | Report Title, Company, Prepared for, Location, Date and Time, Filename, Company logo |
| Trace Setup | | 1 trace Portrait Mode, 2 Trace Portrait Mode, 1 Trace Landscape Mode |
| Trace Validation | | |
| Presets | | 7 presets allow "one click" setting of up to 6 markers and one limit line |
| Marker Controls | | 6 regular Markers, Marker Peak, Marker valley, Marker between, and frequency entry |
| Delta Markers | | 6 Delta markers |
| Limit Line | | Enable and drag or value entry. Also works with presets |
| Next Trace Button | | Next Trace and Previous trace arrow keys allow quick switching between traces |
| Tools | | |
| Cable Editor | | Allows creation of custom cable parameters |
| Distance to Fault | | Converts a Return Loss trace to a Distance to Fault trace |
| Measurement Calculator | | Converts Real, Imaginary, Magnitude, Phase, RL, VSWR, Rho, and Transmit power |
| Signal Standard Editor | | Creates new band and channel tables |
| Renaming Grid | | 36 user definable phrases for creation of file names, trace titles, and trace subtitles |
| Connectivity | | |
| Connections | | Ethernet, USB cable, USB Memory Stick |



Master Software Tools (for your PC)

| | | |
|---|--|---|
| Measurement Viewing | | |
| Display | | Modify display settings, including scale |
| Spectrum Traces | | Add, delete, and modify limit lines and markers. Overlay traces. |
| Spectrum Analyzer Measurements | | Field Strength, Occupied Bandwidth, Channel Power, ACPR, Emission Mask, C/I ¹ |
| Interference Analyzer Measurements | | Spectrograms, Signal Strength Meter, RSSI ² |
| Non-Spectrum Measurements | | Hi Accuracy Power Meter, Channel Scanner, GSM, WCDMA/HSPA, LTE, TD-LTE, TD-SCDMA, CDMA, EV-DO, Fixed WiMAX, Mobile WiMAX, Screen captures (JPEGs) |
| | | <ol style="list-style-type: none"> Spurious Emissions results viewable in a browser Coverage Mapping and Interference Mapping files viewable in spreadsheet, Google Earth, or Google Maps |
| Database Management | | |
| Full Trace Retrieval | | Retrieve all traces from instrument into one PC directory (limited to approximately 15,000 files) |
| Trace Catalog | | Index all traces in selected folder & subfolder on PC into one catalog |
| Trace Rename Utility | | Rename measurement traces |
| Group Edit | | Titles, subtitles, plot scaling, markers and limit lines, simultaneously on similar files |
| Data Analysis | | |
| Trace Math and Smoothing | | Compare multiple traces |
| Measurement Calculator | | Translate into other units |
| Report Generation | | |
| Report Generator | | Includes GPS, power level, and measurements |
| Edit Graph | | Change scale, limit lines, and markers |
| Report Format | | Create reports in HTML |
| Export Measurements | | Export measurements or entire folders to *.jpg or *.csv format |
| Notes | | Annotate measurements |
| Mapping (GPS required on instrument) | | |
| Spectrum Analyzer Mode | | MapInfo, MapPoint |
| Mobile WiMAX OTA, LTE OTA Options | | Google Earth, Google Maps, MapInfo |

Spectrogram (Spectrum Monitoring for Interference Analysis and Spectrum Clearing)

| | |
|-----------------------------|---|
| Source | Recorded Spectrogram or multiple spectrum traces |
| Folder Spectrogram | 2D View creates a composite file of multiple traces |
| Available Displays | Spectrogram, Peak Power vs. Time, Variation in Total Power vs. Time, Peak Frequency vs. Time, Number of Traces Saved vs. Time (useful with Save on Limit Exceeded), Maximum/Average/Minimum Power vs. Time File Filter (Violations over limit lines or deviations from averages) Playback |
| Display Functions per Trace | Markers, GPS location altitude and time (when recorded), instrument time Filename per trace for Folder Spectrogram |
| Export to Video | Create AVI file of 2D Spectrogram for management review/reports |
| Export to 3D Spectrogram | Views (Set Threshold, Markers) - 3D (Rotate X, Y, Z Axis, Level Scale, Signal ID) - 2D (Frequency or Time Domain, Signal ID) - Top Down Playback (Frequency and/or Time Domain) |

List/Parameter Editors

| | |
|------------------------------------|--|
| Antennas, Cables, Signal Standards | Modify instrument's Antenna, Cable, and Signal Standard List |
| Pass/Fail | Create, download, or edit Signal Analysis Pass/Fail Limits |
| Script Master | Create Script Master files for GSM/WCDMA or Channel Scanner |
| Languages | Modify non-English language menus |
| Mobile WIMAX | DL-MAP Parameters |

Connectivity

| | |
|----------------|--|
| Connections | Connect to PC using USB, LAN, or Direct Ethernet connection |
| Network Search | Find all Anritsu handheld instruments on local network |
| Download | Download measurements and live traces to PC for storage and analysis |
| Upload | Upload measurements and other files from PC to instrument |
| Export | Measurements can be saved in various formats, depending on the measurement type, including JPEG, CSV, and Anritsu DAT format |
| Printing | Print individual or all measurement screens |

Web Remote Control









| | |
|-------------------|---|
| Control | Full instrument control through a browser – all instrument functions except power switch and rotary knob |
| Connections | RJ45 Ethernet jack Third party Wi-Fi router |
| Protocol | HTTP/TCP/IP |
| Physical Layer | Cat 5 Cable, Wi-Fi router compatible |
| Software Required | HTML 5-compliant browser – Google Chrome, Mozilla Firefox |
| Operating System | iOS, Windows, Linux, Android operating systems that can host the HTML 5-compliant browser |
| Remote Hardware | PCs, tablets, and smart phones with Ethernet or Wi-Fi connection and an HTML 5-compliant browser |
| Download | Individual instrument files downloaded via browser Multiple instrument files and directories zipped and downloaded via browser File downloads are not supported by iOS Screen capture capability |
| Display Modes | Normal: All modes & displays supported Fast: Spectrogram traces update faster (up to 5 updates per second) |
| Password | The instrument can be password protected Passwords may be used to manage who is controlling the instrument |
| Users/Instruments | One user/device can view and control many instruments |

Programmable Remote Control

| | |
|----------------------|---|
| Functionality | Many instrument functions are programmable. See the Programming Manual for details. |
| Programming Language | Standard Commands for Programmable Instruments (SCPI) |
| Interfaces | USB, Ethernet |
| Available Drivers | LabView. Visit NI.com for driver |

Ordering Information

VNA Master Handheld Vector Network Analyzer + Spectrum Analyzer

| | MS2024B | MS2025B | MS2034B | MS2035B | Description |
|---|------------------|------------------|------------------------------------|------------------------------------|--|
|  | 500 kHz to 4 GHz | 500 kHz to 6 GHz | 500 kHz to 4 GHz 9 kHz to 4 GHz | 500 kHz to 6 GHz 9 kHz to 6 GHz | Vector Network Analyzer Spectrum Analyzer |
|  | MS2024B-0010 | MS2025B-0010 | MS2034B-0010 | MS2035B-0010 | Built-in Bias-Tee, +12 V to +32 V variable |
|  | MS2024B-0015 | MS2025B-0015 | MS2034B-0015 | MS2035B-0015 | Vector Voltmeter |
|  | MS2024B-0019 | MS2025B-0019 | MS2034B-0019 | MS2035B-0019 | High Accuracy Power Meter (requires external USB sensor, sold separately) |
|  | | | MS2034B-0025 | MS2035B-0025 | Interference Analyzer ^a |
|  | | | MS2034B-0027 | MS2035B-0027 | Channel Scanner ^a |
| | MS2024B-0031 | MS2025B-0031 | MS2034B-0031 | MS2035B-0031 | GPS Receiver ^b |
| | MS2024B-0098 | MS2025B-0098 | MS2034B-0098 | MS2035B-0098 | Standard Calibration to ISO17025 and ANSI/NCSL Z540-1. Includes calibration certificate. |
| | MS2024B-0099 | MS2025B-0099 | MS2034B-0099 | MS2035B-0099 | Premium Calibration to ISO17025 and ANSI/NCSL Z540-1. Includes calibration certificate, test report, and uncertainty data. |
|  | | | MS2034B-0431 | MS2035B-0431 | Coverage Mapping ^c |
|  | | | MS2034B-0509 | MS2035B-0509 | AM/FM/PM Demodulation Analyzer |

a. GPS Option 31 recommended.

b. Requires external GPS antenna (sold separately).



c. Requires GPS Option 31.



Standard Accessories (included with instrument)

| Accessory | Description |
|---|--|
|  | 2000-1654-R Soft Carrying Case |
|  | 2000-1691-R Stylus with Coiled Tether |
|  | 633-75 Li-Ion Battery |
|  | 40-187-R AC-DC Adapter with AC power cord (country dependent) |
| Certificate of Calibration and Conformance | |











| Accessory | Description |
|---|---|
|  | 2000-1371-R Ethernet Cable, 2.1 m (7 ft) |
|  | 3-2000-1498 USB A/5-pin mini-B Cable, 10 ft |
|  | 806-141-R Automotive Power Adapter, 12 VDC, 60 W |
|  | 2000-1797-R Screen Protector Film (x2, one factory installed, one spare) |

USB Power Sensors (for complete ordering information, see the respective data sheets of each sensor)





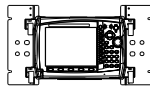





| Accessory | Description |
|---|--|
|  | MA24330A Microwave CW USB Power Sensor, 10 MHz to 33 GHz, +20 dBm |
| | MA24340A Microwave CW USB Power Sensor, 10 MHz to 40 GHz, +20 dBm |
| | MA24350A Microwave CW USB Power Sensor, 10 MHz to 50 GHz, +20 dBm |
|  | MA24208A Microwave Universal USB Power Sensor, 10 MHz to 8 GHz, +20 dBm to -60 dBm |
| | MA24218A Microwave Universal USB Power Sensor, 10 MHz to 18 GHz, +20 dBm to -60 dBm |
|  | MA24106A High Accuracy RF Power Sensor, 50 MHz to 6 GHz, +23 dBm to -40 dBm |

| Accessory | Description |
|---|---|
|  | MA24108A Microwave USB Power Sensor, 10 MHz to 8 GHz, +20 dBm to -40 dBm |
| | MA24118A Microwave USB Power Sensor, 10 MHz to 18 GHz, +20 dBm to -40 dBm |
| | MA24126A Microwave USB Power Sensor, 10 MHz to 26 GHz, +20 dBm to -40 dBm |
|  | MA24105A Inline Dual Directional High Power Sensor, 350 MHz to 4 GHz, +3 dBm to +51.76 dBm |
|  | MA25100A RF Power Indicator |

Optional Accessories

| Backpack and Transit Case | | Accessory | Description |
|---|--|---|--|
|  | 67135 Anritsu Backpack (for Handheld Instrument and PC) |  | 760-261-R Large Transit Case with Wheels and Handle 63.1 cm x 50 cm x 30 cm (24.83" x 19.69" x 11.88"), space for MA2700A, antennas, filters, instrument inside soft case, and other interference hunting accessories/tools |
|  | 760-243-R Large Transit Case with Wheels and Handle 56 cm x 45.5 cm x 26.5 cm (22.07" x 17.92" x 10.42") |  | 760-262-R Transit Case for MA2700A, holds several Yagi antennas and filters/port extender 96.8 x 40.6 x 15.5 cm (38.12" x 16.00" x 6.12") |
|  | 760-286-R Compact Transit Case with Wheels and Handle 55.6 cm x 35.5 cm x 22.9 cm (21.89" x 13.98" x 9.01") |  | 760-271-R Transit Case for Portable Directional Antennas and Port Extender 52.4 cm x 42.8 cm x 20.6 cm (20.62" x 16.87" x 8.12") (for 2000-1777-R, 2000-1778-R, 2000-1779-R, 2000-1798-R) |
| Miscellaneous Accessories | | Accessory | Description |
|  | MA2700A Handheld Interference Hunter (For full specifications, refer to the MA2700A Technical Data Sheet 11410-00692) |  | 3-806-152 Cat 5e Crossover Patch Cable, 2.1 m (7 ft) |
|  | 2000-1374-R External Dual Charger for Li-Ion Batteries |  | 66864 Rack Mount Kit, Master Platform |
|  | 2000-1689-R EMI Near Field Probe Kit | | |

Full Temperature Coaxial Calibration Kits -10 °C to +55 °C, K Type is compatible with 3.5 mm and SMA connectors see individual data sheets on www.anritsu.com)

| Accessory | Description | Accessory | Description |
|--|--|--|---|
|  | OSLN50A-8 High Performance Type N(m), DC to 8 GHz, 50 Ω |  | OSLNF50A-8 High Performance Type N(f), DC to 8 GHz, 50 Ω |
|  | OSLN50A-18 High Performance Type N(m), DC to 18 GHz, 50 Ω |  | OSLNF50A-18 High Performance Type N(f), DC to 18 GHz, 50 Ω |
|  | TOSLN50A-8 High Performance with Through Type N(m), DC to 8 GHz, 50 Ω |  | TOSLNF50A-8 High Performance with Through Type N(f), DC to 8 GHz, 50 Ω |
|  | TOSLN50A-18 High Performance with Through Type N(m), DC to 18 GHz, 50 Ω |  | TOSLNF50A-18 High Performance with Through Type N(f), DC to 18 GHz, 50 Ω |
|  | TOSLK50A-20 High Performance with Through Type K(m), DC to 20 GHz, 50 Ω |  | TOSLKF50A-20 High Performance with Through Type K(f), DC to 20 GHz, 50 Ω |

Coaxial Calibration Components, N Type 50 Ω, K Type 50 Ω (K Type is compatible with 3.5 mm and SMA connectors)

| Accessory | Description | Accessory | Description |
|---|---|---|--|
|  | 22N50 Open/Short, N(m), DC to 18 GHz, 50 Ω |  | 22NF50 Open/Short, N(f), DC to 18 GHz, 50 Ω |
|  | 28N50-2 Precision Load, N(m), DC to 8 GHz, 50 Ω |  | 28NF50-2 Precision Load, N(f), DC to 18 GHz, 50 Ω |
|  | 22K50 Precision Open/Short, K(m), DC to 40 GHz, 50 Ω |  | 22KF50 Precision Open/Short, K(f), DC to 40 GHz, 50 Ω |
|  | 28K50 Precision Load, K(m), DC to 40 GHz, 50 Ω |  | 28KF50 Precision Load, K(f), DC to 40 GHz, 50 Ω |

Coaxial Calibration Components, Other 50 Ω, 75 Ω

| Accessory | Description |
|---|--|
|  | 22N75 Open/Short, N(m), DC to 3 GHz, 75 Ω |
|  | 26N75A Precision Termination, N(m), DC to 3 GHz, 75 Ω |
|  | 12N50-75B Matching Pad, DC to 3 GHz, 50 Ω to 75 Ω |
|  | 2000-1619-R Precision Open/Short/Load, 7/16 DIN(f), DC to 6.0 GHz, 50 Ω |
|  | 2000-1915-R Precision Open/Short/Load, 4.3-10(m), DC to 6 GHz, 50 Ω |
|  | SM/PLNF-1 Precision N(f) Load, 42 dB, 6 GHz |
| | 1091-53-R Open, TNC(m), DC to 18 GHz |
| | 1091-54-R Short, TNC(m), DC to 18 GHz |
| | 1015-55-R Termination, TNC(m), DC to 18 GHz |

| Accessory | Description |
|---|--|
|  | 22NF75 Open/Short, N(f), DC to 3 GHz, 75 Ω |
|  | 26NF75A Precision Termination, N(f), DC to 3 GHz, 75 Ω |
|  | 2000-1618-R Precision Open/Short/Load, 7/16 DIN(m), DC to 6.0 GHz, 50 Ω |
|  | 2000-1914-R Precision Open/Short/Load, 4.3-10(f), DC to 6 GHz, 50 Ω |
|  | SM/PL-1 Precision N(m) Load, 42 dB, 6 GHz |
| | 1091-55-R Open, TNC(f), DC to 18 GHz |
| | 1091-56-R Short, TNC(f), DC to 18 GHz |
| | 1015-54-R Termination, TNC(f), DC to 18 GHz |

| Precision Adapters | | Accessory | |
|---|---|---|---|
| Accessory | Description | Accessory | Description |
|  | 34NN50A N(m) to N(m), DC to 18 GHz, 50 Ω |  | 34NFnF50 N(f) to N(f), DC to 18 GHz, 50 Ω |
|  | 34NK50 Precision Adapter, DC to 18 GHz, N(m) to K(m), 50 Ω |  | 34NFKF50 Precision Adapter, DC to 18 GHz, N(m) to K(f), 50 Ω |
|  | K220B Precision Adapter, DC to 40 GHz, K(m) to K(m), 50 Ω |  | K222B Precision Adapter, DC to 40 GHz, K(f) to K(f), 50 Ω |
|  | K224B Precision Adapter, DC to 40 GHz, K(m) to K(f), 50 Ω | | |

| Adapters | | Accessory | |
|---|---|---|---|
| Accessory | Description | Accessory | Description |
|  | 1091-26-R SMA(m) to N(m), DC to 18 GHz, 50 Ω |  | 510-102-R N(m) to N(m), DC to 11 GHz, 50 Ω, 90 degrees right angle |
|  | 1091-27-R SMA(f) to N(m), DC to 18 GHz, 50 Ω |  | 510-90-R 7/16 DIN(f) to N(m), DC to 7.5 GHz, 50 Ω |
|  | 1091-80-R SMA(m) to N(f), DC to 18 GHz, 50 Ω |  | 510-91-R 7/16 DIN(f) to N(f), DC to 7.5 GHz, 50 Ω |
|  | 1091-81-R SMA(f) to N(f), DC to 18 GHz, 50 Ω |  | 510-92-R 7/16 DIN(m) to N(m), DC to 7.5 GHz, 50 Ω |
|  | 1091-172-R BNC(f) to N(m), DC to 1.3 GHz, 50 Ω |  | 510-93-R 7/16 DIN(m) to N(f), DC to 7.5 GHz, 50 Ω |
|  | 1091-465-R Adapter, DC to 6 GHz, 4.3-10(f) to N(f), 50 Ω |  | 1091-467-R Adapter, DC to 6 GHz, 4.3-10(m) to N(f), 50 Ω |
|  | 510-96-R 7/16 DIN(m) to 7/16 DIN(m), DC to 7.5 GHz, 50 Ω |  | 510-97-R 7/16 DIN(f) to 7/16 DIN(f), DC to 7.5 GHz, 50 Ω |
| | 1091-315-R DC to 18 GHz, TNC(m) to N(f), 50 Ω | | 1091-323-R DC to 18 GHz, TNC(f) to TNC(f), 50 Ω |
| | 1091-324-R DC to 18 GHz, TNC(f) to N(m), 50 Ω | | 1091-326-R DC to 18 GHz, TNC(m) to TNC(m), 50 Ω |
| | 1091-317-R DC to 18 GHz, TNC(m) to SMA(f), 50 Ω |  | 34RKNF50 DC to 18 GHz, Ruggedized K(m) to N(f), 50 Ω |
| | 1091-318-R DC to 18 GHz, TNC(m) to SMA(m), 50 Ω | | |

Attenuators N Type (up to 18 GHz)











| Accessory | Description |
|---|---|
|  | 1010-121-R 40 dB, 100 W, DC to 18 GHz, N(f) to N(m), Uni-directional |
|  | 3-1010-122 20 dB, 5 W, DC to 12.4 GHz, N(m) to N(f) |
|  | 3-1010-123 30 dB, 50 W, DC to 8.5 GHz, N(m) to N(f) |
|  | 3-1010-124 40 dB, 100 W, DC to 8.5 GHz, N(f) to N(m), Uni-directional |

| Accessory | Description |
|---|---|
|  | 42N50-20 20 dB, 5 W, DC to 18 GHz, N(m) to N(f) |
|  | 42N50A-30 30 dB, 50 W, DC to 18 GHz, N(m) to N(f) |
|  | 1010-127-R 30 dB, 150 W, DC to 3 GHz, N(m) to N(f) |
|  | 1010-128-R 40 dB, 150 W, DC to 3 GHz, N(m) to N(f) |



Attenuators K Type (up to 40 GHz)

| Accessory | Description |
|---|---|
|  | 41KB-3 Precision, K(m) to K(f), 3 dB, DC to 26.5 GHz, 50 Ω |
|  | 41KB-6 Precision, K(m) to K(f), 6 dB, DC to 26.5 GHz, 50 Ω |
|  | 41KB-10 Precision, K(m) to K(f), 10 dB, DC to 26.5 GHz, 50 Ω |
|  | 41KB-20 Precision, K(m) to K(f), 20 dB, DC to 26.5 GHz, 50 Ω |

| Accessory | Description |
|---|---|
|  | 41KC-3 Precision, K(m) to K(f), 3 dB, DC to 40 GHz, 50 Ω |
|  | 41KC-6 Precision, K(m) to K(f), 6 dB, DC to 40 GHz, 50 Ω |
|  | 41KC-10 Precision, K(m) to K(f), 10 dB, DC to 40 GHz, 50 Ω |
|  | 41KC-20 Precision, K(m) to K(f), 20 dB, DC to 40 GHz, 50 Ω |

| Phase-Stable Test Port Cables (Armored and Flexible) | | Accessory | Description |
|---|--|--|--|
| | 14KFK50-0.6 1.0 m (39in), DC to 40 GHz, K(f) to K(m), 50 Ω |  | 15NNF50-1.0B 1.0 m (39in), DC to 18 GHz, N(m) to N(f), 50 Ω |
| | 14KFK50-0.6 1.0 m (39in), DC to 40 GHz, K(f) to K(m), 50 Ω |  | 15LL50-1.0A 1.0 m (39in), DC to 20 GHz, 3.5 mm(m) to 3.5 mm(m), 50 Ω |
| | 14KFKF50-1.0 1.0 m (39in), DC to 40 GHz, K(f) to K(f), 50 Ω |  | 15LLF50-1.0A 1.0 m (39in), DC to 20 GHz, 3.5 mm(m) to 3.5 mm(f), 50 Ω |
|  | 14KFK50-1.0 1.0 m (39in), DC to 40 GHz, K(f) to K(m), 50 Ω |  | 15KK50-1.0A 1.0 m (39in), DC to 26.5 GHz, K(m) to K(m), 50 Ω |
|  | 15NN50-1.0B 1.0 m (39in), DC to 18 GHz, N(m) to N(m), 50 Ω |  | 15KKF50-1.0A 1.0 m (39in), DC to 26.5 GHz, K(m) to K(f), 50 Ω |
| Phase-Stable Test Port Cables, Armored | | Accessory | Description |
| | 15NNF50-1.5C 1.5 m, DC to 6 GHz, N(m) to N(f), 50 Ω |  | 15NDF50-1.5C 1.5 m, DC to 6 GHz, N(m) to 7/16 DIN(f), 50 Ω |
|  | 15NN50-1.5C 1.5 m, DC to 6 GHz, N(m) to N(m), 50 Ω | | 15ND50-1.5C 1.5 m, DC to 6 GHz, N(m) to 7/16 DIN(m), 50 Ω |
| | 15NNF50-3.0C 3.0 m, DC to 6 GHz, N(m) to N(f), 50 Ω | | 15N43M50-1.5C Test Port Extension Cable, Armored, 1.5 m, DC to 6 GHz, N(m) to 4.3-10(m) |
| | 15NN50-3.0C 3.0 m, DC to 6 GHz, N(m) to N(m), 50 Ω | | 15N43F50-1.5C Test Port Extension Cable, Armored, 1.5 m, DC to 6 GHz, N(m) to 4.3-10(f) |
| | 15NNF50-5.0C 5.0 m, DC to 6 GHz, N(m) to N(f), 50 Ω | | 15N43M50-3.0C Test Port Extension Cable, Armored, 3 m, DC to 6 GHz, N(m) to 4.3-10(m) |
| | 15NN50-5.0C 5.0 m, DC to 6 GHz, N(m) to N(m), 50 Ω | | 15N43F50-3.0C Test Port Extension Cable, Armored, 3 m, DC to 6 GHz, N(m) to 4.3-10(f) |
| Phase-Stable 18 GHz and 40 GHz Semi-Rigid Cables (Armored) | | Accessory | Description |
|  | 3670K50A-1 0.3 m (12 in), DC to 40 GHz, K(f) to K(m), 50 Ω | | 3670N50-1 0.3 m (12 in), DC to 18 GHz, N(f) to N(m), 50 Ω |
| | 3670K50A-2 0.6 m (24 in), DC to 40 GHz, K(f) to K(m), 50 Ω | | 3670N50-2 0.6 m (24 in), DC to 18 GHz, N(f) to N(m), 50 Ω |
| | 3670NN50-1 0.3 m (12 in), DC to 18 GHz, N(m) to N(m), 50 Ω | | |
| | 3670NN50-2 0.6 m (24 in), DC to 18 GHz, N(m) to N(m), 50 Ω | | |









GPS Antennas (active)

| Accessory | Description |
|---|--|
|  | 2000-1528-R Magnet Mount, SMA(m) with 5 m (16.4 ft) cable, requires 5 VDC |
|  | 2000-1652-R Magnet Mount, SMA(m) with 0.3 m (1 ft) cable, requires 3.3 VDC or 5 VDC |









Accessory **Description**

| | |
|---|---|
|  | 2000-1760-R Miniature Antenna, SMA(m), requires 2.5 VDC to 3.7 VDC |
|---|---|

Directional Antennas

| Accessory | Description |
|---|--|
|  | 2000-1411-R 824 MHz to 896 MHz, N(f), 12.3 dBi, Yagi |
|  | 2000-1412-R 885 MHz to 975 MHz, N(f), 12.6 dBi, Yagi |
|  | 2000-1413-R 1710 MHz to 1880 MHz, N(f), 12.3 dBi, Yagi |
|  | 2000-1414-R 1850 MHz to 1990 MHz, N(f), 11.4 dBi, Yagi |
|  | 2000-1415-R 2400 MHz to 2500 MHz, N(f), 14.1 dBi, Yagi |
|  | 2000-1416-R 1920 MHz to 2170 MHz, N(f), 14.3 dBi, Yagi |
|  | 2000-1659-R 698 MHz to 787 MHz, N(f), 10.1 dBi, Yagi |
|  | 2000-1660-R 1425 MHz to 1535 MHz, N(f), 14.3 dBi, Yagi |
|  | 2000-1715-R 698 MHz to 2500 MHz, N(f), gain of 2 dBi to 10 dBi, typical |

Accessory **Description**



| | |
|---|--|
|  | 2000-1726-R 2500 MHz to 2700 MHz, N(f), 14.1 dBi, Yagi |
|  | 2000-1747-R Log Periodic, 300 MHz to 7000 MHz, N(f), 5.1 dBi, typical |
|  | 2000-1748-R Log Periodic, 1 GHz to 18 GHz, N(f), 6 dBi, typical |
|  | 2000-1777-R 9 kHz to 20 MHz, N(f) (requires port extender 2000-1798-R when used with MA2700A) |
|  | 2000-1778-R 20 MHz to 200 MHz, N(f) (requires port extender 2000-1798-R when used with MA2700A) |
|  | 2000-1779-R 200 MHz to 500 MHz, N(f) (requires port extender 2000-1798-R when used with MA2700A) |
|  | 2000-1812-R Portable Yagi Antenna, 450 MHz to 512 MHz, N(f), 7.1 dBi |
|  | 2000-1825-R Portable Yagi Antenna, 380 MHz to 430 MHz, N(f), 7.1 dBi |
|  | 2000-1798-R Port Extender, DC to 6 GHz |



Portable Antennas (requires 1091-27-R SMA(f) to N(m) or 1091-172-R BNC(f) to N(m) adapter)

| Accessory | Description |
|---|---|
|  | 2000-1200-R 806 MHz to 866 MHz, SMA(m), 50 Ω |
|  | 2000-1473-R 870 MHz to 960 MHz, SMA(m), 50 Ω |
|  | 2000-1035-R 896 MHz to 941 MHz, SMA(m), 50 Ω (1/2 wave) |
|  | 2000-1030-R 1710 MHz to 1880 MHz, SMA(m), 50 Ω (1/2 wave) |
|  | 2000-1474-R 1710 MHz to 1880 MHz with knuckle elbow (1/2 wave) |
|  | 2000-1031-R 1850 MHz to 1990 MHz, SMA(m), 50 Ω (1/2 wave) |

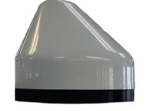
| Accessory | Description |
|---|--|
|  | 2000-1475-R 1920 MHz to 1980 MHz and 2110 MHz to 2170 MHz, SMA(m), 50 Ω |
|  | 2000-1032-R 2400 MHz to 2500 MHz, SMA(m), 50 Ω (1/2 wave) |
|  | 2000-1751-R 698 MHz to 960 MHz, 1710 MHz to 2100 MHz, 2500 MHz to 2700 MHz, SMA(m), 2 dB, typical, 50 Ω |
|  | 2000-1361-R 2400 MHz to 2500 MHz, 5000 MHz to 6000 MHz, SMA(m), 50 Ω |
|  | 2000-1636-R Antenna Kit (Consists of: 2000-1030-R, 2000-1031-R, 2000-1032-R, 2000-1200-R, 2000-1035-R, 2000-1361-R, and carrying pouch) |
|  | 2000-1487-R Telescoping Whip Antenna, BNC |

Mag Mount and Broadband Antennas

| Accessory | Description |
|---|---|
|  | 2000-1616-R 20 MHz to 21000 MHz, N(f), 50 Ω |
|  | 2000-1647-R Cable 1: 698 MHz to 1200 MHz, 2 dBi peak gain, 1700 MHz to 2700 MHz, 5 dBi peak gain, N(m), 50 Ω, 10 ft Cable 2: 3000 MHz to 6000 MHz, 5 dBi peak gain, N(m), 50 Ω, 10 ft Cable 3: GPS 26 dB gain, SMA(m), 50 Ω, 10 ft |
|  | 2000-1645-R 694 MHz to 894 MHz, 3 dBi peak gain 1700 MHz to 2700 MHz, 3 dBi peak gain, N(m), 50 Ω, 10 ft |

| Accessory | Description |
|---|--|
|  | 2000-1646-R 750 MHz to 1250 MHz, 3 dBi peak gain, 1650 MHz to 2000 MHz, 5 dBi peak gain, 2100 MHz to 2700 MHz, 5 dBi peak gain, N(m), 50 Ω, 10 ft |
|  | 2000-1946-R Cable 1: 617 MHz to 960 MHz, 3 dBi peak gain, 1710 MHz to 3700 MHz, 4 dBi peak gain, N(m), 50 Ω, 10 ft Cable 2: 3000 MHz to 6000 MHz, 5 dBi peak gain, N(m), 50 Ω, 10 ft Cable 3: GPS 26 dB gain, SMA(m), 50 Ω, 10 ft |
|  | 2000-1648-R 1700 MHz to 6000 MHz, 3 dBi peak gain, N(m), 50 Ω, 10 ft |



Bandpass Filters

| Accessory | Description |
|---|--|
| | 1030-114-R 806 MHz to 869 MHz, N(m) to SMA(f), 50 Ω |
| | 1030-109-R 824 MHz to 849 MHz, N(m) to SMA(f), 50 Ω |
| | 1030-110-R 880 MHz to 915 MHz, N(m) to SMA(f), 50 Ω |
| | 1030-111-R 1850 MHz to 1910 MHz, N(m) to SMA(f), 50 Ω |
| | 1030-112-R 2400 MHz to 2484 MHz, N(m) to SMA(f), 50 Ω |
| | 1030-105-R 890 MHz to 915 MHz, N(m) to N(f), 50 Ω |
| | 1030-106-R 1710 MHz to 1790 MHz, N(m) to N(f), 50 Ω |
| | 1030-107-R 1910 MHz to 1990 MHz, N(m) to N(f), 50 Ω |
|  | 1030-149-R High Pass, 150 MHz, N(m) to N(f), 50 Ω |
| | 1030-150-R High Pass, 400 MHz, N(m) to N(f), 50 Ω |
| | 1030-151-R High Pass, 700 MHz, N(m) to N(f), 50 Ω |
| | 1030-152-R Low Pass, 200 MHz, N(m) to N(f), 50 Ω |
| | 1030-153-R Low Pass, 550 MHz, N(m) to N(f), 50 Ω |
| | 1030-155-R 2500 MHz to 2700 MHz, N(m) to N(f), 50 Ω |
| | 1030-178-R 1920 MHz to 1980 MHz, N(m) to N(f), 50 Ω |
| | 1030-179-R 777 MHz to 798 MHz, N(m) to N(f), 50 Ω |
| | 1030-180-R 2500 MHz to 2570 MHz, N(m) to N(f), 50 Ω |

Accessory **Description**

| | |
|---|--|
| | 2000-1734-R 699 MHz to 715 MHz, N(m) and N(f), 50 Ω |
| | 2000-1735-R 776 MHz to 788 MHz, N(m) and N(f), 50 Ω |
| | 2000-1736-R 815 MHz to 850 MHz, N(m) and N(f), 50 Ω |
| | 2000-1737-R 1711 MHz to 1756 MHz, N(m) and N(f), 50 Ω |
| | 2000-1738-R 1850 MHz to 1910 MHz, N(m) and N(f), 50 Ω |
| | 2000-1739-R 880 MHz to 915 MHz, N(m) and N(f), 50 Ω |
| | 2000-1740-R 1710 MHz to 1785 MHz, N(m) and N(f), 50 Ω |
|  | 2000-1741-R 1920 MHz to 1980 MHz, N(m) and N(f), 50 Ω |
| | 2000-1742-R 832 MHz to 862 MHz, N(m) and N(f), 50 Ω |
| | 2000-1743-R 2500 MHz to 2570 MHz, N(m) and N(f), 50 Ω |
| | 2000-1799-R 2305 MHz to 2320 MHz, N(m) and N(f), 50 Ω |
| | 2000-1911-R 703 MHz to 748 MHz, N(m) and N(f), 50 Ω |
| | 2000-1912-R 788 MHz to 798 MHz, N(m) and N(f), 50 Ω |
| | 2000-1925-R 663 MHz to 698 MHz, N(m) and N(f), 50 Ω |
| | 2000-1926-R 776 MHz to 806 MHz, N(m) and N(f), 50 Ω |
|  | 2000-1684-R 791 MHz to 821 MHz, N(m) to N(f), 50 Ω |

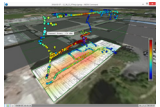
NEON® MA8100A Signal Mapper

| Accessory | Description | Accessory | Description |
|--|--|-----------|---|
| | MA8100A-000 NEON Signal Mapper with Anritsu Integration and Tracking Unit. Includes 3 months NEON Software License with 3 months of maintenance and support and 3 months of Cloud Service (PN: 2300-607). | | 2300-606 Perpetual NEON Software License with 3 years of maintenance and support and 3 years of Cloud Service. Part number can also be used to order a perpetual license after a limited term license has expired. |
| | MA8100A-001 NEON Signal Mapper with Anritsu Integration and Tracking Unit. Includes 1 year NEON Software License with 1 year of maintenance and support and 1 year of Cloud Service (PN: 2300-574). | | 2300-612 Renewal of 1 year NEON Software License with 1 year of maintenance and support and 1 year of Cloud Service. |
|  | MA8100A-003 NEON Signal Mapper with Anritsu Integration and Tracking Unit. Includes 3 year NEON Software License with 3 years of maintenance and support and 3 years of Cloud Service (PN: 2300-575). | | 2300-613 Renewal of 3 year NEON Software License with 3 years of maintenance and support and 3 years of Cloud Service. |
| | MA8100A-005 NEON Signal Mapper with Anritsu Integration and Tracking Unit. Includes 5 year NEON Software License with 5 years of maintenance and support and 5 years of Cloud Service (PN: 2300-576). | | 2300-614 Renewal of 5 year NEON Software License with 5 years of maintenance and support and 5 years of Cloud Service. |
| | MA8100A-100 NEON Signal Mapper with Anritsu Integration and Tracking Unit. Includes Perpetual NEON Software License with 3 years of maintenance and support and 3 years of Cloud Service (PN: 2300-606). | | |
|  | 2000-1852-R NEON Tracking Unit (includes USB cable and belt clip, Worldwide version) | | |
| | 2000-2015-R NEON Tracking Unit (includes USB cable and belt clip, Japan version) | | |
| | 2000-1853-R Belt clip (for NEON Tracking Unit) | | |

Manuals

| Part Number | Description |
|-------------|---|
| 10100-00065 | Product Information, Compliance, and Safety |
| 10580-00349 | Spectrum Analyzer Measurement Guide |
| 10580-00240 | Power Meter Measurement Guide |
| 10580-00289 | VNA Measurement Guide |
| 10580-00301 | VNA Master User Guide |
| 10580-00302 | VNA Master Programming Manual |
| 10580-00303 | VNA Master Maintenance Manual |
| 11410-00424 | USB Power Sensor MA24106A |
| 11410-00472 | Measuring Interference |
| 11410-00504 | Microwave USB Power Sensor MA241x8A |
| 11410-00531 | Practical Tips on Making "Vector Voltmeter (VVM)" Phase Measurements using VNA Master (Option 15) |
| 11410-00545 | VNA Master + Spectrum Analyzer Brochure |
| 11410-00549 | VNA Master + Spectrum Analyzer Technical Data Sheet |

Training at Anritsu

Anritsu has designed courses to help you stay up to date with technologies important to your job. For available training courses, visit: www.anritsu.com/training, and search for training and education.



• United States

Anritsu Americas Sales Company
450 Century Parkway, Suite 190,
Allen, TX 75013, U.S.A.
Phone: +1-800-Anritsu (1-800-267-4878)

• Canada

Anritsu Electronics Ltd.
700 Silver Seven Road, Suite 120,
Kanata, Ontario K2V 1C3, Canada
Phone: +1-613-591-2003
Fax: +1-613-591-1006

• Brazil

Anritsu Eletronica Ltda.
Praça Amadeu Amaral, 27 - 1 Andar
01327-010 - Bela Vista - Sao Paulo - SP, Brazil
Phone: +55-11-3283-2511
Fax: +55-11-3288-6940

• Mexico

Anritsu Company, S.A. de C.V.
Blvd Miguel de Cervantes Saavedra #169 Piso 1,
Col. Granada, Mexico, Ciudad de Mexico,
11520, MEXICO
Phone: +52-55-4169-7104

• United Kingdom

Anritsu EMEA Ltd.
200 Capability Green,
Luton, Bedfordshire, LU1 3LU, U.K.
Phone: +44-1582-433200
Fax: +44-1582-731303

• France

Anritsu S.A.
12 avenue du Québec, Immeuble Goyave,
91140 VILLEBON SUR YVETTE, France
Phone: +33-1-60-92-15-50

• Germany

Anritsu GmbH
Nemetschek Haus, Konrad-Zuse-Platz 1,
81829 München, Germany
Phone: +49-89-442308-0
Fax: +49-89-442308-55

• Italy

Anritsu S.r.l.
Spaces Eur Arte, Viale dell'Arte 25, 00144 Roma, Italy
Phone: +39-6-509-9711

• Sweden

Anritsu AB
Kistagången 20 B, 2 tr, 164 40 Kista, Sweden
Phone: +46-8-534-707-00

• Finland

Anritsu AB
Technopolis Aviapolis, Teknobulevardi 3-5 (D208.5),
FI-01530 Vantaa, Finland
Phone: +358-20-741-8100

• Denmark

Anritsu A/S
c/o Regus Winghouse, Ørestads Boulevard 73, 4th
floor,
2300 Copenhagen S, Denmark
Phone: +45-7211-2200

• Russia

Anritsu EMEA Ltd.
Representation Office in Russia
Tverskaya str. 16/2, bld. 1, 7th floor,
Moscow 125009, Russia
Phone: +7-495-363-1694
Fax: +7-495-935-8962

• Spain

Anritsu EMEA Ltd.
Representation Office in Spain
Paseo de la Castellana, 141.
Planta 5, Edificio Cuzco IV
28046, Madrid, Spain
Phone: +34-91-572-6761

• Austria

Anritsu EMEA GmbH
Am Belvedere 10, A-1100 Vienna, Austria
Phone: +43-(0)1-717-28-710

• United Arab Emirates

Anritsu EMEA Ltd.
Anritsu A/S
Office No. 164, Building 17, Dubai Internet City
P. O. Box - 501901, Dubai, United Arab Emirates
Phone: +971-4-3758479

• India

Anritsu India Private Limited
6th Floor, Indiqube ETA, No.38/4, Adjacent to EMC2,
Doddanekundi, Outer Ring Road,
Bengaluru - 560048, India
Phone: +91-80-6728-1300
Fax: +91-80-6728-1301

• Singapore

Anritsu Pte. Ltd.
11 Chang Charn Road, #04-01, Shriro House
Singapore 159640
Phone: +65-6282-2400
Fax: +65-6282-2533

• Vietnam

Anritsu Company Limited
16th Floor, Peakview Tower, 36 Hoang Cau Street,
O Cho Dua Ward, Dong Da District, Hanoi, Vietnam
Phone: +84-24-3201-2730

• P.R. China (Shanghai)

Anritsu (China) Co., Ltd.
Room 2701-2705, Tower A, New Caohejing
International Business Center No. 391 Gui Ping Road
Shanghai, 200233, P.R. China
Phone: +86-21-6237-0898
Fax: +86-21-6237-0899

• P.R. China (Hong Kong)

Anritsu Company Ltd.
Unit 1006-7, 10/F., Greenfield Tower, Concordia Plaza,
No. 1 Science Museum Road, Tsim Sha Tsui East,
Kowloon, Hong Kong, P.R. China
Phone: +852-2301-4980
Fax: +852-2301-3545

• Japan

Anritsu Corporation
8-5, Tamura-cho, Atsugi-shi, Kanagawa, 243-0016
Japan
Phone: +81-46-296-6509
Fax: +81-46-225-8352

• South Korea

Anritsu Corporation, Ltd.
5FL, 235 Pangyoyeok-ro, Bundang-gu, Seongnam-si,
Gyeonggi-do 13494, South Korea
Phone: +82-31-696-7750
Fax: +82-31-696-7751

• Australia

Anritsu Pty. Ltd.
Unit 20, 21-35 Ricketts Road,
Mount Waverley, Victoria 3149, Australia
Phone: +61-3-9558-8177
Fax: +61-3-9558-8255

• Taiwan

Anritsu Company Inc.
7F, No. 316, Sec. 1, NeiHu Rd., Taipei 114, Taiwan
Phone: +886-2-8751-1816
Fax: +886-2-8751-1817

List Revision Date: 20210610