

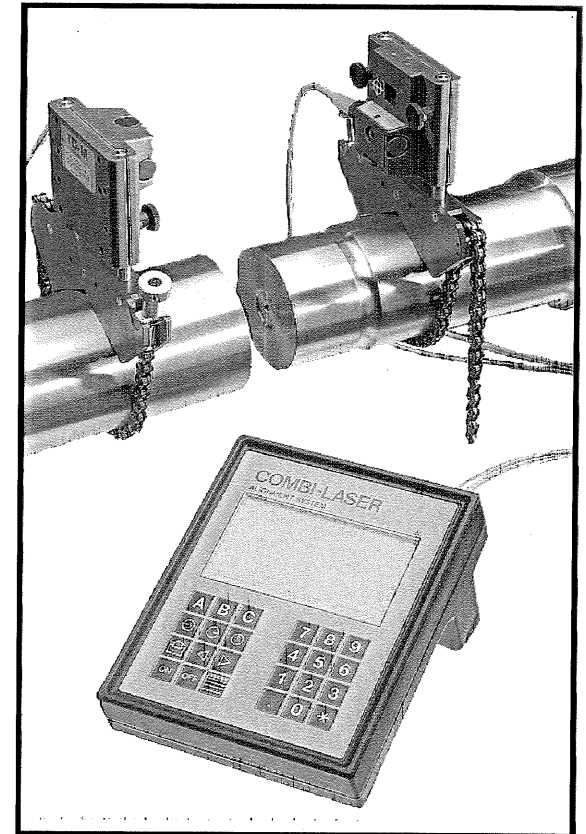

Advanced Test Equipment Rentals
www.atecorp.com 800-404-ATEC (2832)

COMBI-LASER M



User's Manual for
COMBI-LASER M
alignment system

User's Manual for
COMBI-LASER M
alignment system

Publication no: P-0005-US
January 1995



CONTENTS

Introduction	7	Perpendicularity	
Checklist	8	With the FL51	
Description of		Attachment.....	41
System	9	Procedure	42
Carrying case	10	With the Angular prism	
Display unit.....	11	Attachment.....	44
TD-S / TD-M.....	12	Procedure	45
Inside the TD	13	Parallelism	
Universal shaft fixtures.....	14	Attachment.....	47
Combi attachment	15	Procedure	48
Connections	16	Spindle alignment	
Main menu	17	Attachment.....	50
Program summary	18	Procedure	51
Guide to the Keypad	20	Signal transmission	52
Shaft alignment		User settings	54
Introduction	22	Memory function	
TD attachment	24	Saving measurement values ...	57
Horizontal machines		Displaying measurement	
Entering distances	25	values	59
Display	26	Printing	61
Attachment.....	28	Data transmission	63
Procedure	28	Charging	65
Rough alignment	30	Additional information	66
Soft Foot	31	What is a laser ?	67
Vertical machines		Safety precautions	68
Attachment.....	33	Labels	70
Procedure	34	Technical data.	71
Further information	36	License agreement	72
Straightness measurement			
Attachment.....	37		
Procedure	39		
Levelling			
With FL51 and TD-M.....	40		

INTRODUCTION

COMBI-LASER M is much more than a shaft alignment system. Combi-Laser M is a universal measurement system based on laser and microprocessor technologies for measurement and alignment of:

- Rotating Machinery - Shafts - Couplings
- Cardan shafts / Offset machines
- Straightness
- Flatness
- Perpendicularity
- Parallelism
- Spindle Alignment
- Thermal Growth
- Continuous Monitoring.

The unique Combi-Laser M system uses two Transmitter/Detector (TD) units and universal fixtures. The display unit is supplied with 6 programs for alignment. The measurement values can be displayed, stored and transmitted to printer and computer.

Developed specifically for demanding industrial environments. Withstands water, dust and rough handling.

This manual will provide a step to step guide on how to use the Combi-Laser M system. It will also provide valuable information about the various aspects of machinery measurement and alignment.

The measurement applications are limited only by your imagination!

CHECKLIST

Standard components

System 1-0074 and charger.

Check that all components listed below are provided.

NO.	ITEM	DESCRIPTION	Q' TY
1-0088	Carrying case	Dim. 400x350x160 (16"x14"x6")	1
1-0075	Display unit	Dim. 222x178x118 (9"x7"x4½")	1
1-0076	TD-S unit	Stationary Transmitter/Detector	1
1-0077	TD-M unit	Movable Transmitter/Detector	1
2-0137	V-Bracket	Red anodized aluminium	2
3-0310	Rod 200 mm	∅ 10 (8" ∅ ½")	4
3-0290	Rod 100 mm	∅ 10 (4" ∅ ½")	4
3-0343	Rod holder	Black plastic	1
2-0135	Chain 1	L=900 mm (3')	2
2-0136	Chain	L=500 mm (1'8")	2
3-0302	Bracket	Stainless steel	2
3-0304	Nut	Stainless steel	2
3-0305	Tool	Stainless steel	1
3-0289	Fixture	Red anodized aluminium	2
1-0083	Magnetic base	Dim. 62x50x54 (2 ½"x2½"x2½")	2
SK-MCS8X20	Screws	M8x20	2
ÖM-LN27M5x25	Screws	M5x25	4
OM-PLASTBOX	Plastic box	Dim. 130x75x35 (5"x3"x1")	3
KO-300578-66	Cable 3 m	Cable Display unit-TD	2
OM-30-054	Measuring tape	L=2 meter (6 ft.)	1
1-0144	Charger EUR	220 VAC - 6VDC	
1-0150	Charger USA	115 VAC - 6 VDC	1 of 3
1-0151	Charger UK	240 VAC - 6 VDC	

SYSTEM

1-0074 and charger

1-0144 or
1-0150 or
1-0151

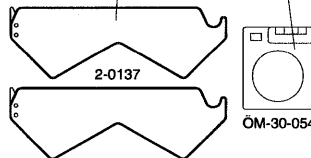
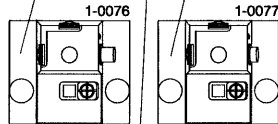
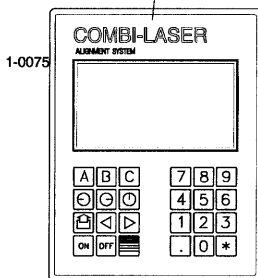
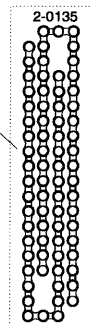
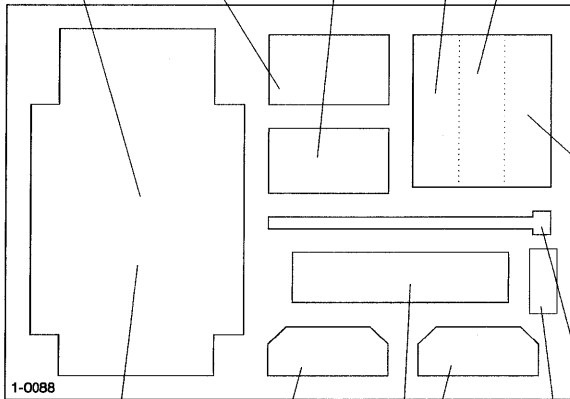
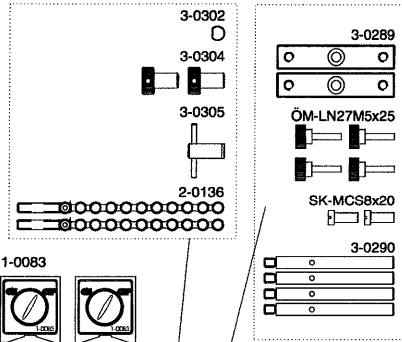
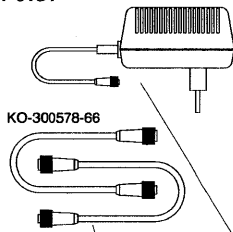

CARRYING CASE

1-0088

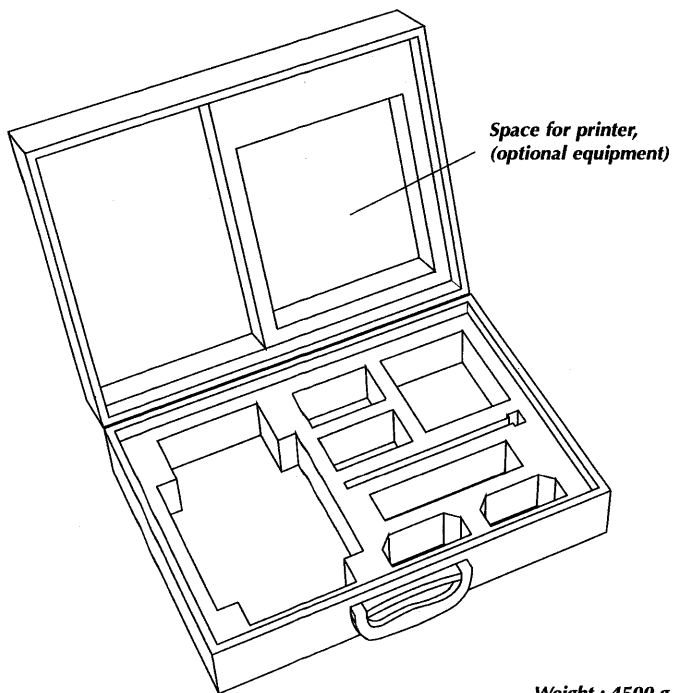

Weight : 4500 g (10 lb.)

DISPLAY UNIT

1-0075

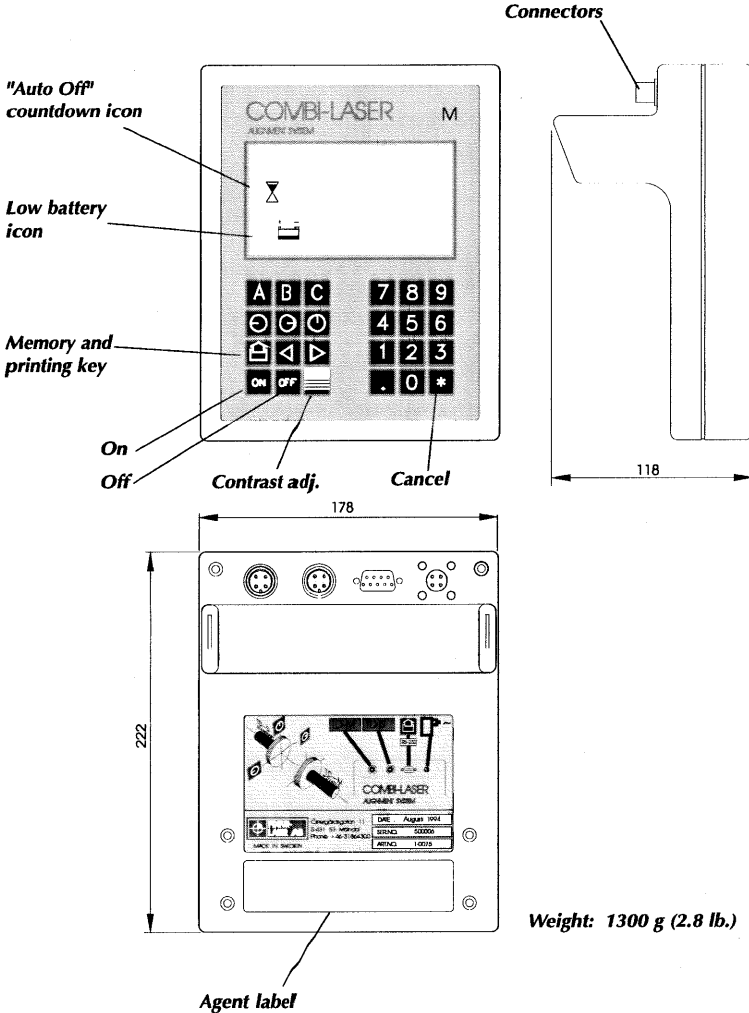

Connectors

"Auto Off" countdown icon

Low battery icon

Memory and printing key

On

Off

Contrast adj.

Cancel

118

178

222

Weight: 1300 g (2.8 lb.)

Agent label



TD-S / TD-M

1-0076/ 1-0077

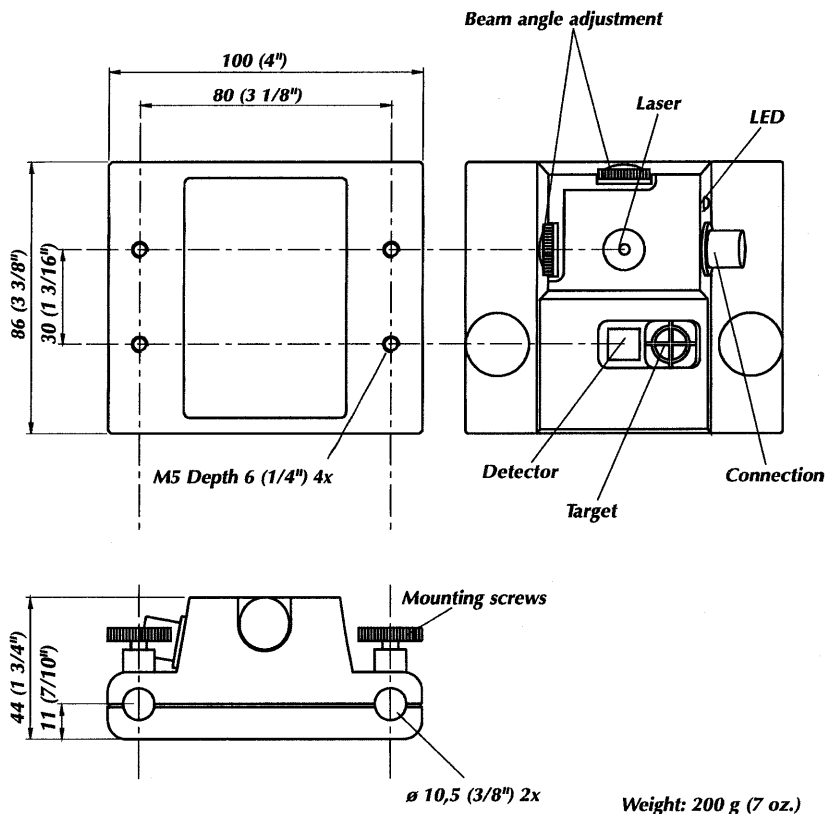

INSIDE THE TD-units

Laser and Detector

The unique Transmitter/Detector (TD) units are the heart of the Combi-Laser M system. Each TD-unit houses a diode laser and a detector.

Laser

The Laser is a low power semiconductor diode laser with collimating lenses. The Laser is modulated in order to avoid interference from other light sources.

Filter

An optical filter is mounted on the front of the PSD to filter some of the ambient light sources. The filter also serves to protect the PSD from dust and moisture.

Detector

The detector used in the Combi-Laser M is a single axis PSD (Position Sensitive Detector). The PSD responds to the laser beam moving over its surface in only one axis (line). The photoelectric current generated by the incident laser light beam flows through the device and can be seen as an input current divided into two output currents (I_1 and I_2). The distribution of the output currents is used to determine the position of the laser beam on the detector surface.

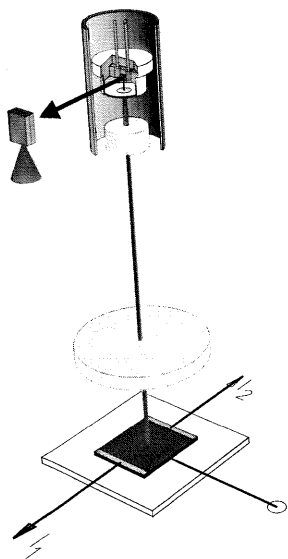

UNIVERSAL SHAFT FIXTURES

2-00104

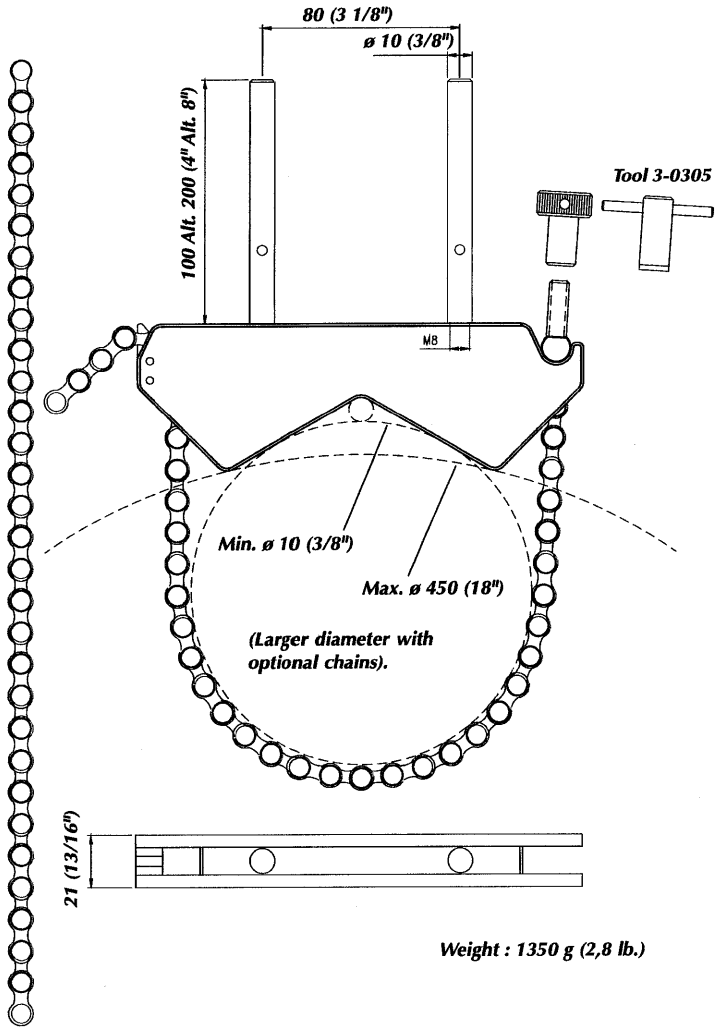

Weight : 1350 g (2,8 lb.)

COMBI ATTACHMENT

2-0128

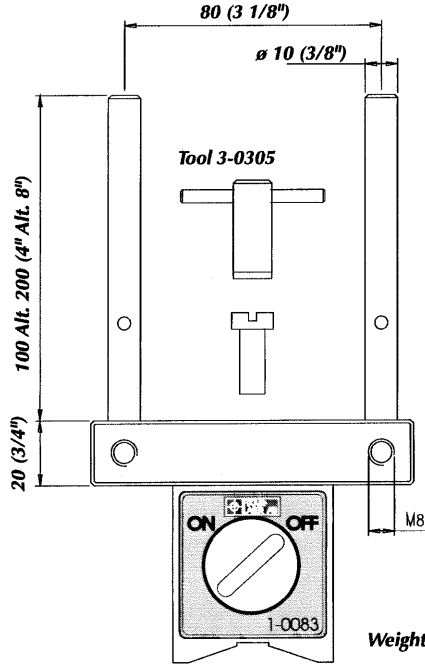

Weight : 1100 g (2.4 lb.)

Example :

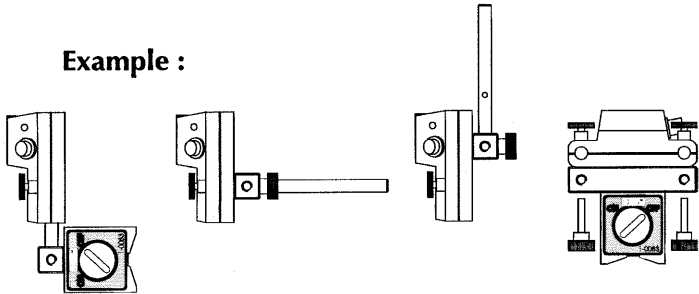

CONNECTIONS

System 1-0074

**Movable unit
(Female connector)**

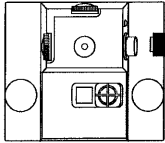

**Stationary unit
(Male connector)**

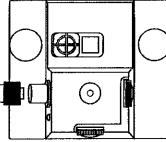

Each of the TD cables has a male and a female end. In addition, each of the TD units has a different type port, one is male and the other female. The Display unit also has one male and one female port. This design makes it impossible to connect the system components improperly.

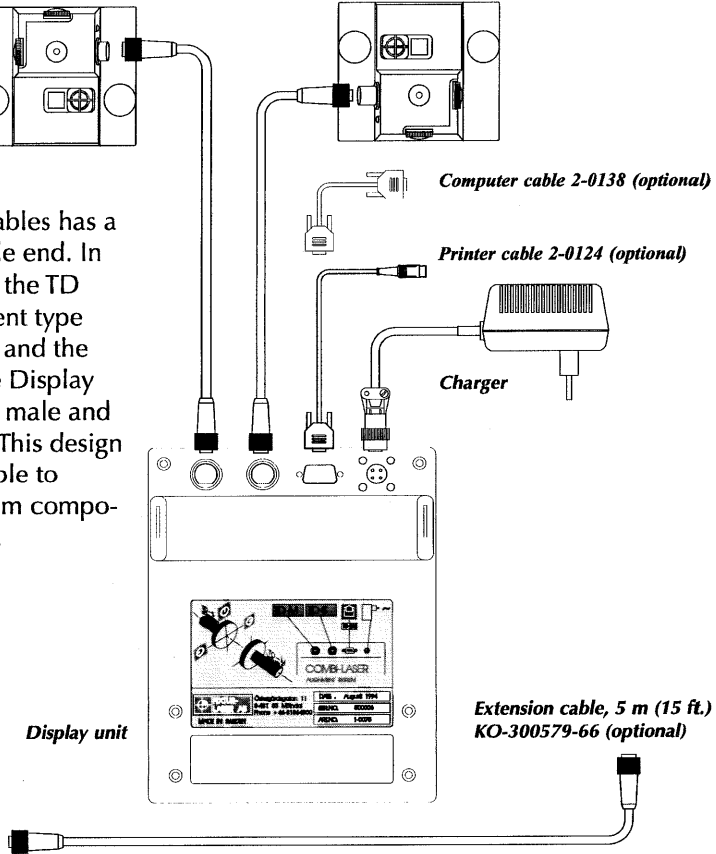

Display unit

Extension cable, 5 m (15 ft.)
KO-300579-66 (optional)

MAIN MENU

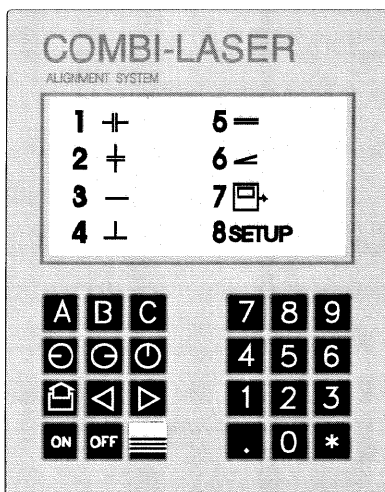

All measurement procedures start from the MAIN MENU.

Press **ON** for MAIN MENU. (Hold the button pressed down for a couple of seconds.)

then press 1 for: Shaft alignment - horizontal machines

2 for: Shaft alignment - vertical machines

3 for: Straightness

4 for: Perpendicularity

5 for: Parallelism

6 for: Spindle alignment

7 for: Signal transmission

8 for: User setup

 for: List menu (see Memory function).

The appropriate laser(s) turns on after you have made your choice.

Press **OFF** to end each program.

PROGRAM SUMMARY

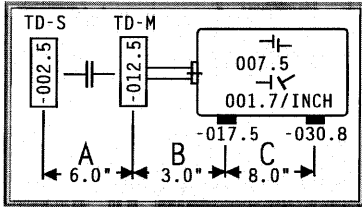

1

**Shaft alignment
horizontal machines**

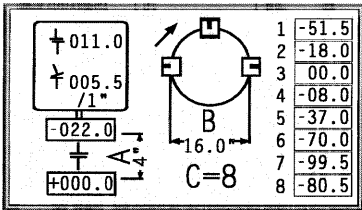

2

**Shaft alignment vertical
machines**

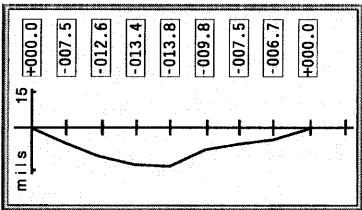

3

Straightness

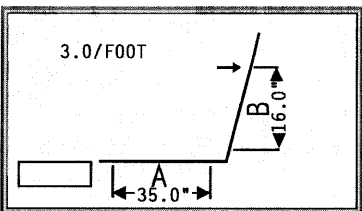

4

Perpendicularity

5

Parallelism

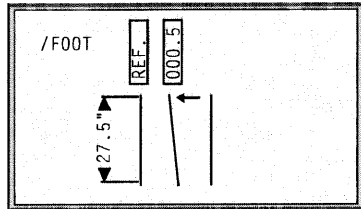

6

Spindle alignment

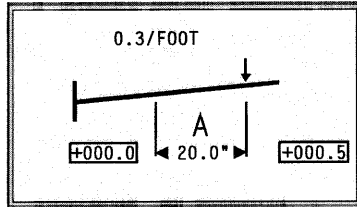

7

Signal transmission

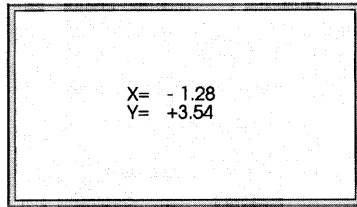

8

User setup

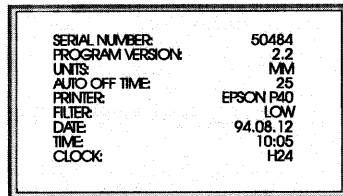

GUIDE TO THE KEYPAD

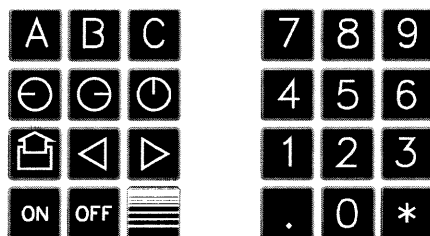

A B C

These keys are used for entering the dimensions you have measured and for storing the measured values. When entering A, B and C measurements, first enter the value using the numeric keypad, and then press the key to which the measurement corresponds, either A, B or C. You can enter dimension values up to 999.9. The Combi-Laser M will accept only one value after the decimal.

A powerful advantage of the Combi-Laser M system is that you do not have to enter the dimensions in any particular order. It is also possible to change the values whenever and however you wish during the measurement procedure. This allows you to change incorrect values or to calculate the position of machines with more than 2 pairs of mounting feet or several different bolt circle diameters without having to retake alignment readings.



The keys that have "clock" symbols are used to store measurements in the 9:00, 3:00 and 12:00 positions.



This key gives a printout of the display on the connected printer and saves measurement values for later print out or transmission to connected computer.



This key is used for negative B measurements in shaft alignment or for deleting measurements.



This key takes you row-by-row through the User setup program.



This key adjusts the contrast on the display. Each time you press the key the contrast changes, cycling through the contrast levels, one step at a time.



This key restarts the current program and cancels printings and data transmissions.

The numeric keypad is used for selecting programs and entering measured dimensions.

SHAFT ALIGNMENT

Introduction

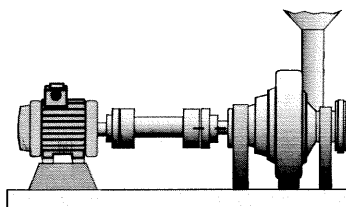

Shaft alignment - correction of the relative position of two machines that are connected such as a motor and a pump, so that the centre lines of the shafts form a straight line when the machines are working at normal operating temperatures. Shaft alignment means moving the front and the rear pair of feet of one machine, vertically and horizontally, until the shafts are aligned to within given tolerances.

Combi-Laser M method - Reverse method

Combi-Laser M works with the principle of the reverse method where two dial indicators are used. With the Combi-Laser M the rods are replaced with laser beams and the dial indicator with detectors.

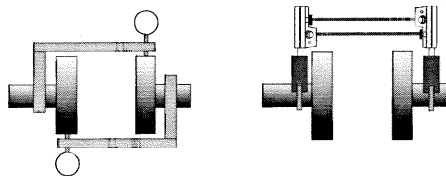
**The principle :**

Two Transmitter-Detector units (TD-S on Stationary and TD-M on Movable machine) attached on separate fixtures on opposite sides of the coupling measure parallel offset of the shafts. The measurements are taken when the shafts are rotated between the 9:00, 3:00 and 12:00 positions. When the shafts are rotated 180° the laserbeams and the detectors will describe two half circles. The centre of these half circles always represent the rotational centres of the shafts. The detectors measure the relative position of the two half circles. The Display unit calculates the angularity from the distance between the two TD units and the difference between the measured values. Measurement values will be represented as parallel offsets and angular error on the display. The Display unit also shows the position of the movable machine's feet. The values on the display update in real time. You can use the values to perform other calculations or measurements.

The Combi-Laser M is not affected by axial float, and only slightly by backlash, and there is no sag in the laser beam.

Carefully follow TD-attachment on the following page during the measurement procedure.

TD-attachment

Always face the Stationary machine from the Movable machine

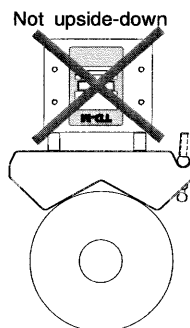
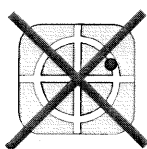
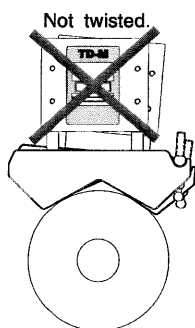
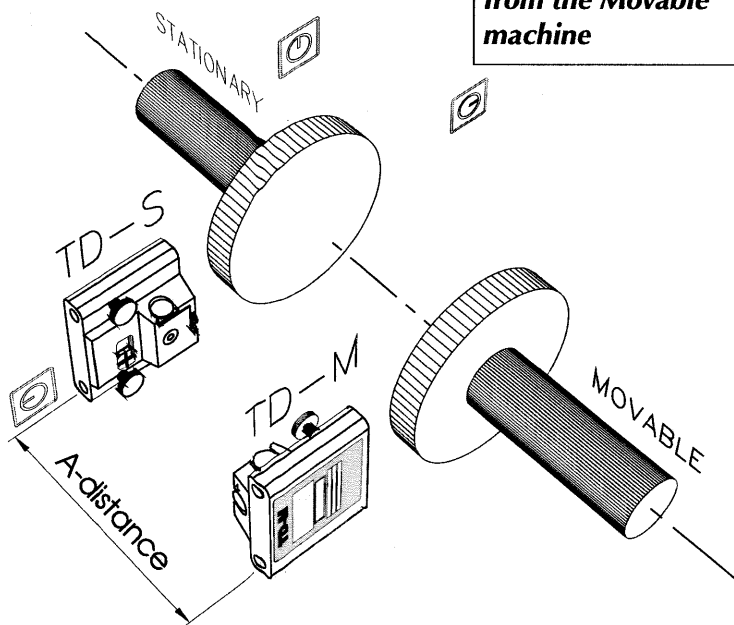

The laser spot must be inside the circle of the target, for proper measurement.

SHAFT ALIGNMENT

Horizontal machines

Entering A, B and C measurements

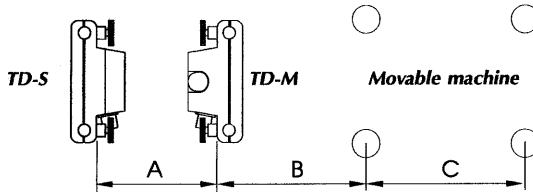
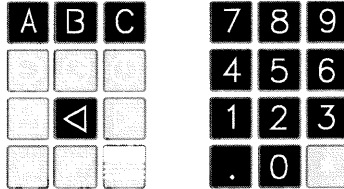

Distance A:
Distance between TD-S and TD-M measured from the front surface of the housings.

Distance B:
Distance measured from the front surface of the TD-M unit's housing to the centre line of the bolts in the front pair of feet on the movable machine.

Distance C:
Distance between the centre lines of the bolts in the front and rear pairs of feet.

When the front pair of feet lie "forward" of the TD-M, this negative dimension is entered by pressing ◀ before or after the B measurement. I. e. ◀ B-measurement **B** or B-measurement ◀ **B**. See paragraph 3, Display.

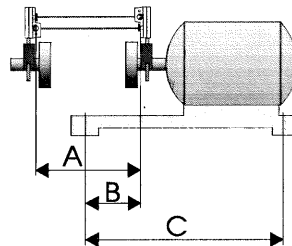

Display

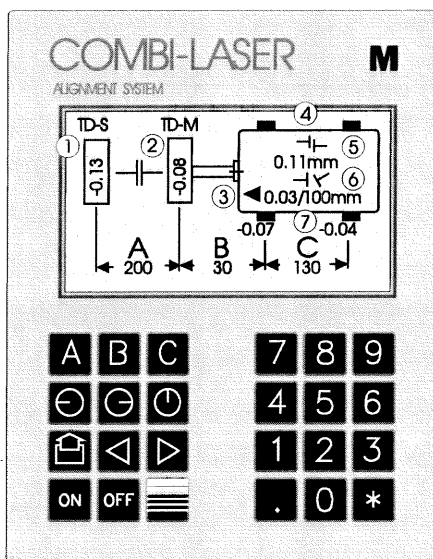

1 Value of TD-S:

The value is the actual displacement of the laser beam measured at the stationary detector. This value is compared with the TD-M value in order to calculate the angle of the movable shaft.

2 Value of TD-M:

This is the actual displacement of the movable detector measured to the reference laser beam. The value is representative of the parallel offset of the movable machine at the position of the TD-M unit on the shaft.

In the vertical position, + means high, - low.

In the horizontal position, + means right, - left.

3 Foot position icon:

The icon is shown if you have indicated with  that the front pair of feet are positioned to the left of TD-M.

4 Four or two feet:

In the 3:00 position, the horizontal position is shown with four feet. In the 12:00 position,  turns off these two feet to show the vertical position of the machine.

5 Parallel offset:

Icon and value of the parallel offset, calculated at a point midway between the TD units. The icon shows when the movable machine is displaced more than 0.0005, in the vertical position high/low, or in the horizontal position left/right.

6 Angular error:

Icon and value of the calculated angularity. The icon shows the direction of the angular error of the movable machine. In the vertical position, this will be up/down. In the horizontal position, this is left/right.

7 Position of the movable machine:

Combi-Laser M always calculates the position of the movable machine. Thus these values represent the calculated position of the front and rear pairs of feet on the movable machine. By observing the size and sign of this value, you can make a correction (shimming/adjustment).

In the vertical position, + means high, - low.

In the horizontal position, + means right, - left.

Application examples

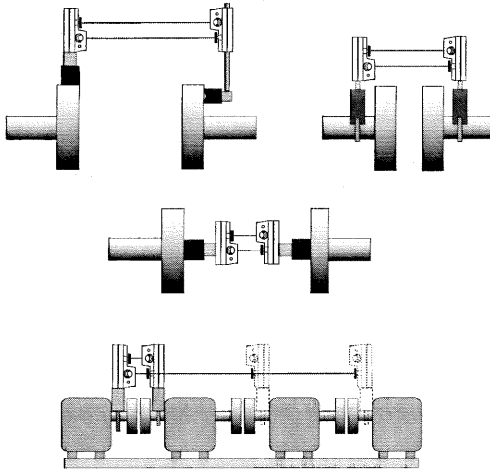
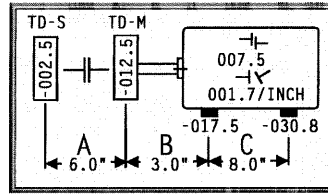

***Always face the Stationary machine
from the Movable machine.***

Procedure:

- 1 Mount the fixtures on the shaft and attach the TD-units. Connect the cables between the TD-units and the Display unit.
- 2 Turn on the Display unit. At the Main Menu, start by pressing **1**.

- 3 Measure and enter the **A**, **B** and **C** distances.
- 4 Turn the shafts to the 9:00 position and move the targets so that they cover the detectors.
- 5 Use the thumbscrews on the TD units to position both lasers in the centre of the opposing targets.
- 6 Move the targets from in front of the detectors and press **⊖**.
- 7 Turn the shafts to the 3:00 position and press **⊕**. The Display unit now shows how the Movable machine is positioned horizontally.
- 8 Turn the shafts to the 12:00 position and press **⊖**. Now you can view how the Movable machine is positioned vertically. You can now adjust/shim if needed.
- 9 You can return to the horizontal position if desired by turning the shafts to the 3:00 position and pressing **⊕**.

Adjustment of the shafts in the horizontal direction is easy with the Combi-Laser M live display. After you have positioned the shafts at 3:00 and pressed **⊕**, simply start moving the machine and watch the values displayed at the feet. The display will guide you to a perfect alignment, as the values drop to 0.

Rough alignment with visible beams

The fact that Combi-Laser M uses two beams and two targets makes it easy to do a rough alignment or installation simply by watching the laser dots on the targets.

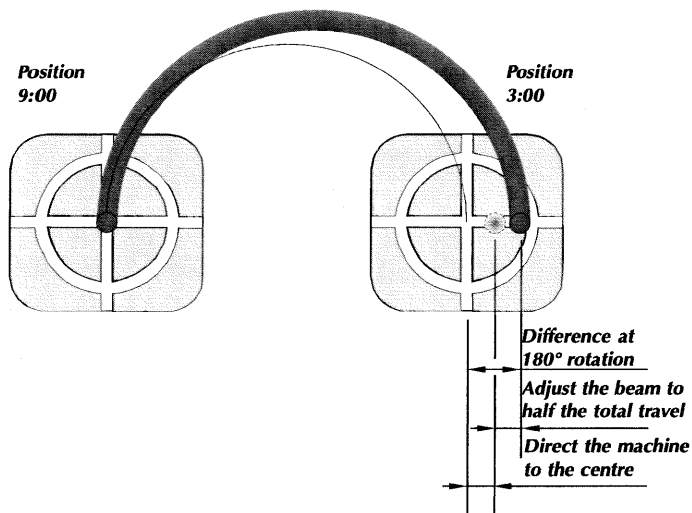

Procedure:

- 1 Mount the fixtures on the shafts and attach the TD units.
Connect the cables between the TD units and the display unit.
- 2 Start shaft alignment by choosing **1** in the Main Menu.
- 3 Turn the shafts to the 9:00 position and move the targets in front of the detectors.

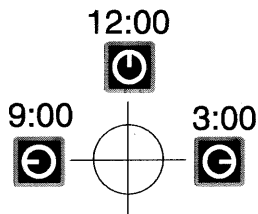



- 4 Use the thumb screws on the TD units to position both beams in the centre of the opposing targets.
- 5 Turn the shafts to the 3:00 position. If the stationary and the movable machines do not have the same rotating direction, the laser dots will move on the targets. Adjust the beams with the thumb screws on both TD-S and TD-M to half the difference.
- 6 Move the movable machine so that the two laser dots hit the centre of the targets.

Soft foot

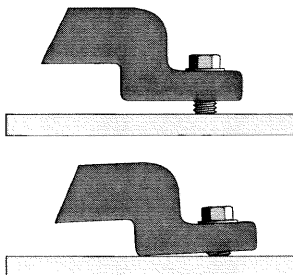
This is a condition wherein one or more feet of the machine does not lie in the same plane as the base or foundation; the foot does not rest flat. A soft foot must be corrected before starting the alignment process.



Procedure:

- 1 Mount the fixtures of the shafts and attach the TD units. Connect the cables between the TD units and the display unit.
- 2 Check in the User Setup program that FILTER: is set to LOW.
- 3 Start the alignment program by choosing **1** in the Main Menu.
- 4 Measure and enter the A, B and C dimensions.
- 5 Rotate the shafts to the 12:00 position.
- 6 Zero the display by pressing  ,  and  . Note: Wait for the detector values and display to update between pressing each key.
- 7 Loosen and tighten each of the mounting bolts, noting the value displayed at the feet when each bolt is loosened. These values represent the amount of soft foot present and what adjustments must be made.

SHAFT ALIGNMENT

Vertical machines

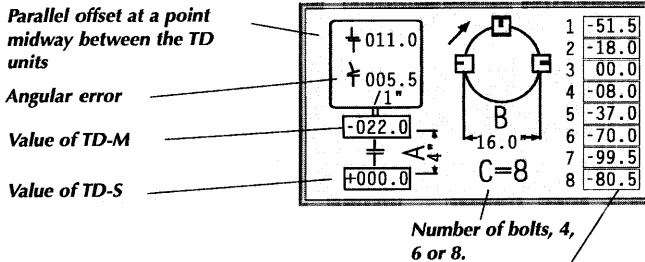

The table shows the position at each bolt, from bolt no. 1 and proceeding in a clockwise direction.

When reading the display: Always position yourself so that the TD units position is to the right of the machine

After shaft measurement, a table is shown in which the position at each bolt is calculated. The highest bolt is set at 000.0 and the others must be shimmed up to this level.

Use the value of the parallel offset to move the machine in a sideways direction.

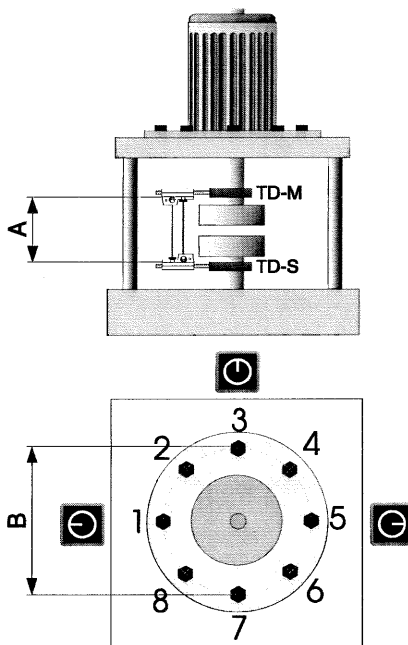

Procedure:

- 1 Mount the fixtures on the shaft and attach the TD units. Connect the cables between the TD units and the display unit.
- 2 Start the program by choosing **2** from the Main Menu.
- 3 Measure and enter the A and B dimensions and the number of bolts, 4, 6 or 8, on C.
- 4 Rotate the shafts so that the TD units are positioned in the middle of bolt No. 1 (9:00 position).
- 5 Move the targets in front of the detectors. Use the thumb screws on the TD units to direct the beams towards the centre of the opposing targets.
- 6 Move the targets away from the detectors and press **⏻**.



- 7 Rotate the shaft to the 3:00 position and press . The display will now show how the movable machine is standing in the 9:00 - 3:00 position.

- 8 Rotate the shafts to the 12:00 position and press . The display will now show how the movable machine is standing in the 6:00-12:00 position, as well as the position (shim value) of each bolt, calculated from bolt No. 1 and proceeding in a clockwise direction.

Each time you press , the shim values are calculated. Any change in the bolt circle diameter (B) and the number of bolts (C) must be ended by  so that new shim values are calculated.

Note: The TD units must be in the 12:00 position when this calculation is made.

Changing the A measurement requires redoing the measurement procedure from point 4 in order to show correct shim values.

Further Information

When the A dimension is significantly smaller than the B and C dimensions (perhaps only a tenth as large), there will be in most cases, and for very natural reasons, great variations in the "foot values". Even the smallest change in the measurement value in any of the TD units is enlarged by factors of B/A and $(B+C)/A$, see below. The most important factor in and of itself is not the position of the machine feet but the measurement values at the coupling. The measured values at the front and rear pairs of feet must thus be seen as an aid in alignment

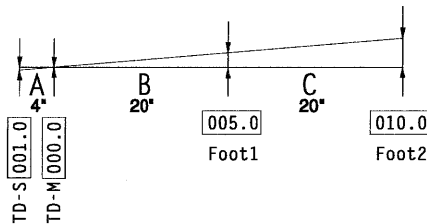

In shaft alignment, the shafts are rotated 180° (9:00 position - 3:00 position) in order to be able to determine with great precision the rotation centre and direction in relation to one another. It is possible to make measurements even when it is not possible to position the TD units in the 9:00 or 3:00 positions, e.g. from the 6:00 position to the 12:00 position instead. Use the level in the measuring tape as an aid in the positioning of the TD units.

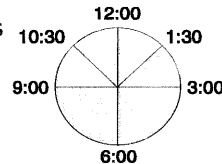

Measurements can also be made when the rotation is less than 180° when necessary down to 90° (10:30 position - 1:30 position). However, this requires repeated measurements and adjustments to reach a perfectly aligned machine.

STRAIGHTNESS MEASUREMENT

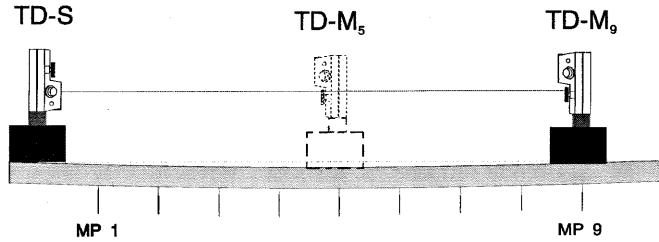

At the final measurement point press **B** = 2 zero points.

The scale changes automatically in proportion to the max value of the measurements.

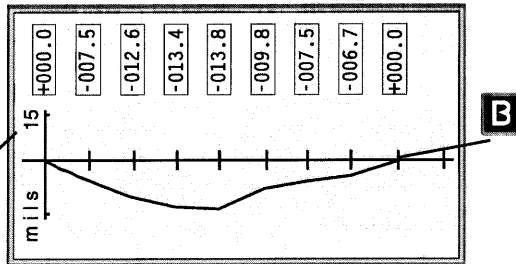

At the final measurement point press **C** = 1 zero point.

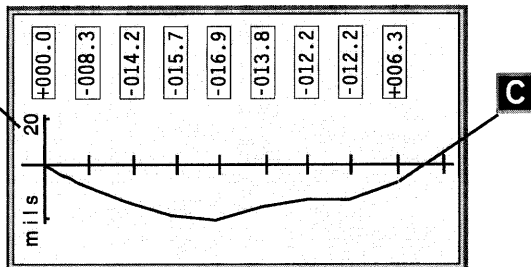

The Combi-Laser M straightness program will process up to 10 measurement points. The measurements are represented digitally in mm (mills) as well as graphically. In addition, the program gives you two options for the representation of the measurements. You have the choice of establishing one or two reference points.

Procedure:

- 1 Mount the TD unit on the magnetic base or use the Combi attachment for mounting on an alternate fixture. Connect the cables between the TD units and the Display unit. Place the TD-S at one end of the object to be measured.
- 2 Turn on the Combi-Laser M. At the Main Menu press **3**.
- 3 Place the TD-M at the far end of the object to be measured and move the target so it covers the detector.
- 4 Use the thumbscrews on the TD-S unit to position the laser in the centre of the target on the movable TD-M unit.
- 5 Divide the object to be measured into equal segments. The Combi-Laser M will allow you to take up to 10 straightness measurement points.
- 6 Place the TD-M at the first measurement point and press **A**. This initializes the system (establishes this first measurement point as a reference).
- 7 Move the TD-M to each successive measurement point. The measurement value is taken by pressing **A** each time.

- 8 To end the measurement and display the values press either the **B** or **C** at the final measurement point. By ending the measurement with **C** the display and values will reflect only the first measurement point as a zero point.

If the measurements are ended with the **B** then the first and last measurement points will both be used as zero points.

While taking the measurements you can delete values one at a time by pressing  , and then retake the measurements

The program can be restarted by pressing .

LEVELLING

With FL51 and TD-M

FL51's laser beam levelled as reference.

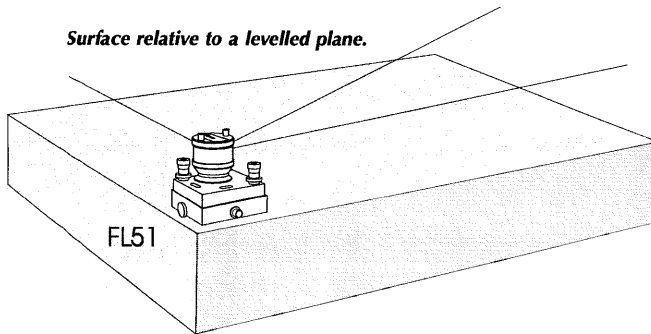
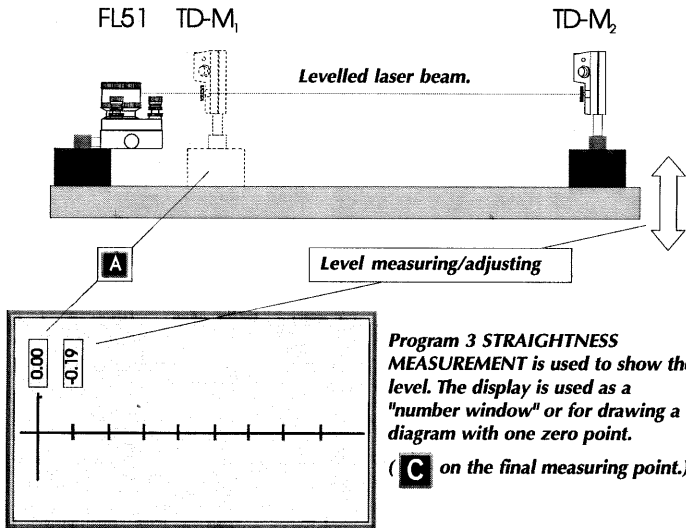

PERPENDICULARITY

With FL51

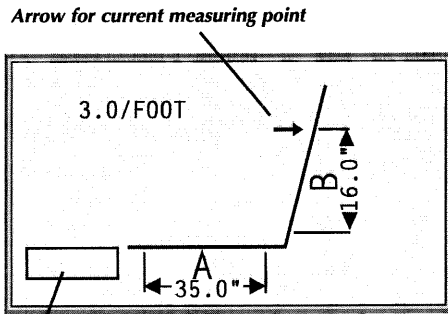

Detector values during measurement

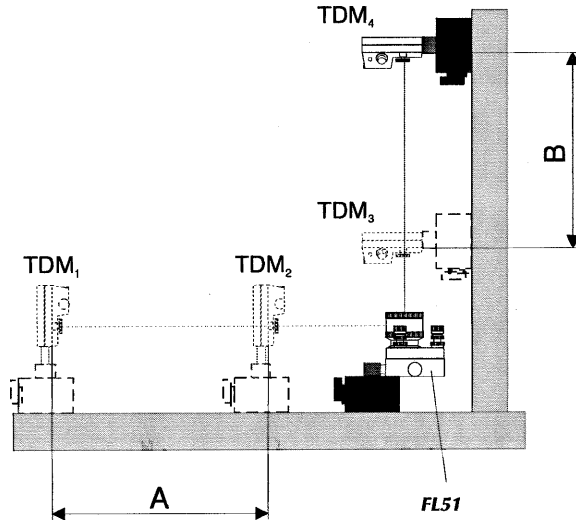

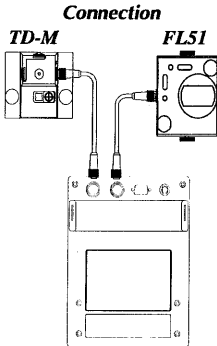

When the Combi-Laser M standard equipment has been supplied with the extra equipment Laser FL51 (1-0153), perpendicularity can be measured using program 4 PERPENDICULARITY.

Principle :

A laser beam through an angular prism constitutes an absolute 90° reference angle. Two measuring points towards the beam on the one side of the angle are compared with two measuring points on the other, and any differences between the two are shown by the angle of the object to be measured.

Procedure with FL51 :

- 1 Mount TD-M and FL51 on the magnetic base or use the combination attachment for mounting on alternative fixtures. Connect the cable between TD-M and the display unit and between FL51 and the display unit. Mark four measuring points for TD-M according to the picture.
- 2 Start the perpendicularity measurement by choosing **4** in the Main Menu.
- 3 Measure and enter A and B dimensions.

- 4 Place TD-M in measuring point 1 and move the target in front of the detector. Use the adjustment screws on FL51 to direct the laser beam to the centre of the target.
- 5 Move the target away from the detector and press **C** to store the measurement value.
- 6 Move TD-M to measuring point 2 according to the arrow and press **C**.
- 7 Remove the angular prism part so that the beam lies in a line with measuring points 3 and 4.
- 8 Move TD-M in the proper order to measuring points 3 and 4 according to the arrow and store the measurement values with **C**.

After the final measuring point, any deviation from a 90° angle is presented, expressed in mils/foot (mm/m), and the icon graphically shows whether the angle is narrower or wider.

When measuring, incorrect values can be deleted by using . Note the movement of the arrow on the display and place TD-M on the measuring point in question.

The program can be restarted by pressing .

PERPENDICULARITY

With the Angular prism

Arrow for current measuring point

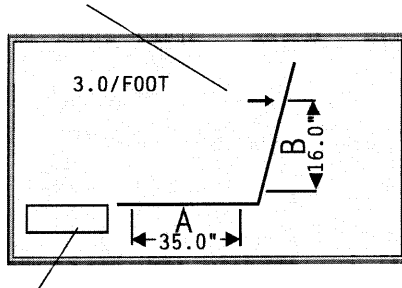

Detector values during measurement

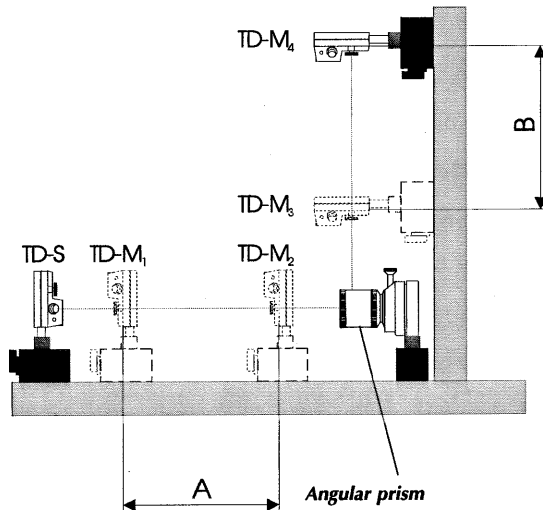

When the Combi-Laser M standard equipment has been supplied with the extra equipment Angular prism (1-0105), perpendicularity can be measured using program 4 PERPENDICULARITY.

Principle :

A laser beam through an angular prism constitutes an absolute 90° reference angle. Two measuring points towards the beam on the one side of the angle are compared with two measuring points on the other, and any differences between the two are shown by the angle of the object to be measured.

Procedure with FL51:

- 1 Mount TD units and the Angular prism on magnetic bases or use the combination attachment for mounting on alternative fixtures. Connect the cables between TD units and the display unit. Position the TD-S unit at one end of the measurement object. Mark four measuring points for TD-M according to the picture.
- 2 Start the perpendicularity measurement by choosing **4** in the Main Menu.
- 3 Measure and enter A and B dimensions.
- 4 Place TD-M in measuring point 2 and move the target in front of the detector. Use the adjustment screws to adjust the laser beam to the centre of the target.
- 5 Remove the TD-M unit and position the Angular prism as shown in the illustration. The beam should now fall in the aperture of

the Angular prism and the deflected beam aligned with the measuring points 3 and 4.

- 6 Position the TD-M unit at measurement point 1. Move the target away from the detector and press **C** to store the measurement value.
- 7 Move TD-M to each following measuring point according to the arrow and press **C** to store the value.

After the final measuring point, any deviation from a 90° angle is presented, expressed in mils/foot (mm/m), and the icon graphically shows whether the angle is narrower or wider.

When measuring, incorrect values can be deleted by using . Note the movement of the arrow on the display and place TD-M on the measuring point in question.

The program can be restarted by pressing .

PARALLELISM

Arrow for current measuring point

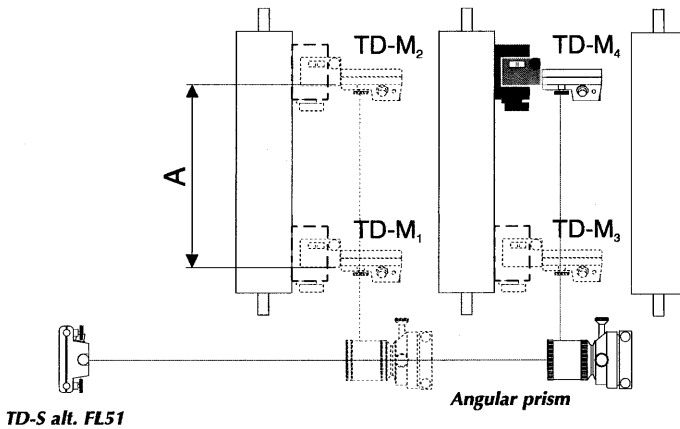
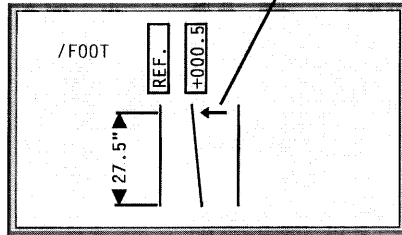

When the Combi-Laser M standard equipment has been supplied with 2 tripods (OM-STATIV 851), the Angular prism (1-0105) and a Magnetic base with level (2-0157), parallelism can be measured, e.g. between rolls, using program 5, Parallelism.

Principle for rolls:

A laser beam in the longitudinal direction of the machine is divided by the Angular prism into a number of absolute parallel laser beams along the rolls. Two measuring points towards the beam per roll are compared with each other and any differences between them are shown in the deviation from parallelism with the reference roll.

Procedure:

- 1 Mount TD-S with the combination attachment on the support. TD-M with magnetic base is placed on the reference roll in measuring point 1. Move the target in front of the detector and connect the cables between the TD units and the display unit.
- 2 Start the Parallelism program by choosing 5 in the Main Menu.
- 3 Measure and enter the A dimension.
- 4 Place TD-S and the angular prism on tripods, so that the beam can be directed in towards the target on TD-M.
- 5 Move the target away from the detector and press **C** to store the measurement value.

- 6 Move TD-M to measuring point 2 (measurement A) and store the measurement value using **C**.
- 7 Any deviation from the reference roll is presented, expressed as mm/m, (mils/foot) and the icon graphically shows the direction of the roll.
- 8 Move the angular prism and TD-M to the other rolls in the proper order according to the arrow and store the measurement values with **C**.

Up to 5 rolls can be presented simultaneously. The measuring point can be backed up one roll at a time using .

The program can be restarted by pressing .

NOTE!

When it is necessary to place TD-M on the "back" of a roll, the order must be changed for that roll so that the farthest end is measured before the closest. This must be done for the direction to be presented correctly.

SPINDLE ALIGNMENT

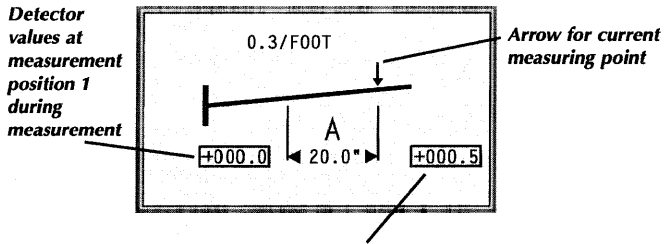

Detector values at measuring position 2 during measurement. When you have finished measuring, the absolute value at the A distance is shown here.

Mounting TD-M when measuring vertically

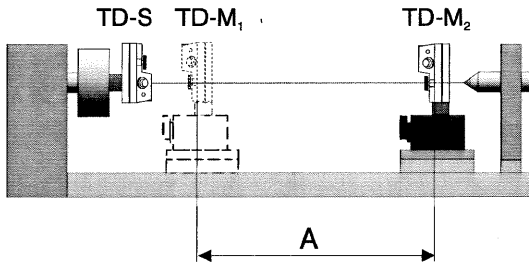

Mounting TD-M when measuring horizontally

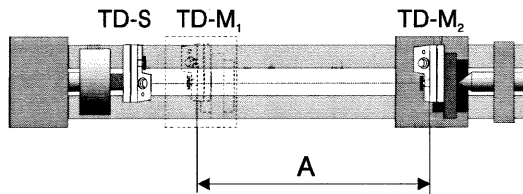





Principle:

By rotation, a laser beam functions as an extension of the centre shaft of the spindle. Two measuring points towards the laser beam along the machine bed are compared with each other and any difference is shown by the direction of the spindle.

Procedure for lathe:

- 1 Mount TD-S with the Combi attachment in the chuck. Connect the cables between the TD units and the display unit.
- 2 Start the program for measuring spindle alignment by choosing **6** in the Main Menu.
- 3 Use the thumb screws on TD-S to direct the laser beam parallel to the machine bed (e.g. toward the turning centre).
- 4 Mount TD-M with the magnetic base on the tool slide, about 100 mm from TD-S (measuring point 1).
- 5 Move the target in front of the detector and move TD-M to the side and upwards so that the beam is directed toward the centre of the target.
- 6 Move the target away from the detector. Measure and enter the A value.

- 7 Press , turn the chuck 180° and press .
- 8 Move the tool slide according to distance A (to measuring point 2). Press , turn the chuck 180° and press .
- 9 The display now shows the spindle's direction in relation to the machine bed in mm/m (mils/foot) and the graphical icon shows, depending on the orientation of TD-M, whether the spindle is pointing upwards or downwards or to the right or left.

The program can be restarted by pressing .

SIGNAL TRANSMISSION

The program number 7 included in your Combi-Laser M is for signal transmission to a computer. With this program the values from the TD units are transferred to a computer as they are updated. This can be useful for storing and analysing a large number of readings. A possible use of this option would be to record or study the dynamic movement of equipment. Since it is known that equipment changes its position when placed in operation due to the thermal process and other forces. By monitoring the sum total of these forces, the true dynamic change can be determined.

Procedure

- 1 Mount the TD units on the equipment or objects to be measured and make the usual cable connections.
- 2 Connect a computer to the COMBI-LASER with optional computer cable 2-0138. If not connected prior to starting the communication program the Combi-Laser M will timeout (terminate the communication) after a few seconds and return to the Main Menu.
- 3 Press **7** in the Main Menu and the COMBI-LASER will start sending absolute readings from the detectors on the serial port (RS 232). If one of the lasers is not striking the detector, the system will show an over-range from that TD unit by sending a series of 99,99. Terminate the Signal transmission by pressing *****.

TRANSFER PROTOCOL :

String length: 12 chr + CR + LF (example below)
 Number of decimals: 2 true (last 2 digits is always 0)
 End of line: CR + LF (chr\$ (13) + chr\$ (10))

Example :

X- readings from TD-M

Y- readings from TD-S

┌ 3 space (chr\$ (32)

X=	┐#.##00	CR LF
Y=	+#.##00	CR LF
X=	-#.##00	CR LF
Y=	+#.##00	CR LF

Over-range
from TD-M

X=	99.9900	CR LF
Y=	-#.##00	CR LF
X=	99.9900	CR LF
Y=	+#.##00	CR LF

USER SETTINGS

Principle

In the Main menu press **3**. Move with **▶** the cursor to the field that you wish to change. Enter the desired parameters and then shut down the display unit using **OFF** so that the new values are stored and will apply for the next measurement.

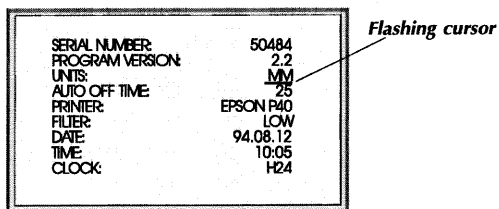

Serial number

This field cannot be changed. The number is found on the bottom of the computer unit and on the TD units with which it is calibrated.

Program version

This field cannot be changed.

Units

MM or INCH - This can be changed back and forth using *****. This indicates the unit in which the measurement program is to be expressed, MM for metric and INCH for Imperial.

Auto Off time

Settings from 01 to 99 - Press ***** and give a value from the keypad. Automatic shutdown is provided in programs 1 to 6 in order to prevent undesired battery discharge. The time is given in min-

utes. Values below 10 must be started with a zero. The value 99 or power from the charger allows continuous operation. An "hourglass" Σ on the display in the measurement programs shows a time countdown until automatic shutdown. The icon is emptied at the same pace as the time used. When about 2 minutes remain, the icon flashes. Press any of the keys to refill the hourglass and restart the countdown.

Printer

OTHER or EPSON P40 - This can be changed back and forth using \star . It adapts the printing function to the connected printer. In the case of connection to an Epson-compatible printer other than Epson P40, the OTHER position can be chosen to speed up the printout.



Filter

LOW or HIGH - This can be changed back and forth using \star . It sets the level of filtering of incoming measurement values. Filtering is included to give stable measurement values on the display, even when the TD units' surrounding environment would have caused undesired variations. LOW gives filtering for a period of about 2 seconds. This is sufficient for a normal measurement environment. HIGH gives filtering for a period of about 12 seconds for difficult measurement environments, great temperature differences or long measurement distances. During the entire period, the measurement values are read in, which is indicated by ***** , instead of the detector values. Do not move the TD units until the detector values have returned on the display. Note that in shaft alignment (programs 1 and 2), the measurement values remain locked between the measurement positions when filtering is set to HIGH.

Date

Date for the system clock. Set the date by pressing  and then enter the appropriate date, YYMMDD when using 24 hs. display or MMDDYY when using 12 hs. display.

Time

The time for the system clock. Set the time by pressing  and then enter the appropriate time. HH,MM. AM/PM is set by pressing  and .

Clock





Sets the display format of the time, 12 or 24 hs. Selected by pressing . Changes the format of date and time on screen and print out.

MEMORY FUNCTION

Saving measurement values



In the shaft alignment programs, program 1 and 2, there is a function for saving the measurement values to an internal memory. The values is not erased or lost when the displaybox is shut off. With this function the measurement values can be printed out or transferred to a computer another time and at an other location. The saved values are stored as a list for up to ten complete measurements. The different measurements are separated by:

- 1 The serial number.
- 2 The letter **H** for horizontal and **V** for vertical shaft alignment.
- 3 The date and time for the actual measurement.

The measurement values concerned is all the data displayed on the screen at position 3 and position 12 after pressing the  and  for storing. These values represents the vertical and horizontal position of the moveable machine. The saving can be performed after a complete measurement or after a measuring a certain direction. (I.e. vertical.) If the measurement proceeds with horizontal direction these values can be saved either as a complement to the previous measurement or as a new measurement with a new serial number in the list. The values, stored with  and  during the measurement process, replaces the previous saved values at the serial number chosen for saving.

To display the Save menu from the shaft alignment programs, press .



1: Prints all the saved values to a connected printer.

2: Displays the measurement values from one of the measurements. Choose measurement by pressing  and .

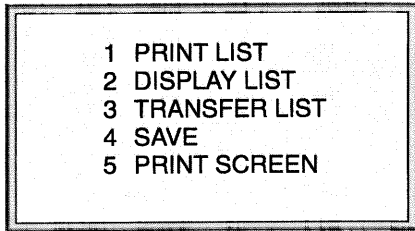
3: Transfers all saved measurement values to a connected and prepared computer.



The screen displayed while pressing .

4: Press **4** to decide on which line, numbered 0-9, the values are to be saved. The arrow shows the current choice and can be moved to another line by pressing  or .

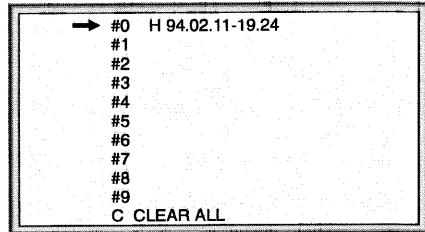

The screen displayed while pressing **4**.

Save the values by pressing the number of the chosen line on the keypad. Previous values in the chosen line are replaced by the new values. Measurement direction, date and time is now displayed on the screen as a confirmation of the new saving. To delete all the saved values position the arrow at C and then press **C**.

5: Prints the graphic display of actual measurement.

Return to the previous screen by pressing .

Displaying of the measurement values

From the Main menu, press  to display the List menu.

From the List menu the saved measurement values can be displayed on the screen or transferred as a list to a connected printer or computer. Previously saved values can also be deleted from this menu.

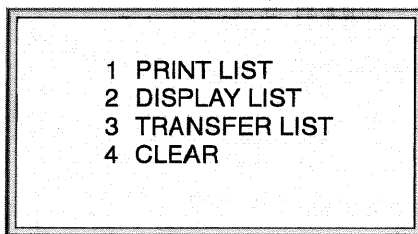

The menu displayed when pressing  from the Main menu

- 1-3 Menu choices 1-3 are the same as those in the Save menu.
- 4 Deletes chosen measurement values.

By pressing **2** the measurement values are displayed one at a time.

By pressing **◀** and **▶** each of the saved measurements are displayed.

Return to the previous screen by pressing **✱**.

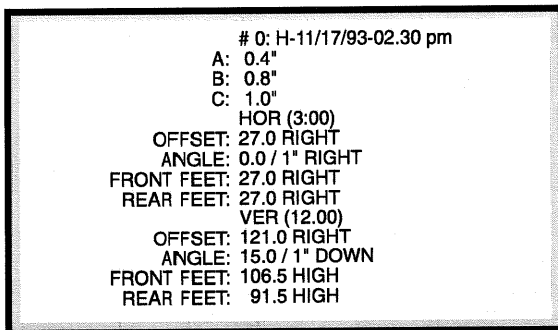

0: H-11/17/93-02.30 pm
A: 0.4"
B: 0.8"
C: 1.0"
HOR (3:00)
OFFSET: 27.0 RIGHT
ANGLE: 0.0 / 1" RIGHT
FRONT FEET: 27.0 RIGHT
REAR FEET: 27.0 RIGHT
VER (12:00)
OFFSET: 121.0 RIGHT
ANGLE: 15.0 / 1" DOWN
FRONT FEET: 106.5 HIGH
REAR FEET: 91.5 HIGH



The display showing the measurement values.

PRINTING

Printing list and screen

The Combi-Laser can be connected to an optional printer for screen dumps and list printing. First connect a printer to the Combi-Laser with optional printer cable 2-0124.

Press  from the Main menu or the Save menu. Press **1** to print all the saved values in form of a list. From the shaft alignment programs press **5** to print the current measurement screen (screen dump).

In the other programs (3 - 6) press  to print the current measurement screen (screen dump). The printing process is canceled by pressing .

Return to the previous menu by pressing .

Printer setup:

Mode: Epson
Baudrate: 9600 Bd
Parity: None
Databits: 8
Stopbit: 1
Auto LF: Off

0: H-11/17/93-02.30 pm
 A: 0.4"
 B: 0.8"
 C: 1.0"
 HOR (3:00)
 OFFSET: 27.0 RIGHT
 ANGLE: 0.0 / 1" RIGHT
 FRONT FEET: 27.0 RIGHT
 REAR FEET: 27.0 RIGHT
 VER (12:00)
 OFFSET: 121.0 RIGHT
 ANGLE: 15.0 / 1" DOWN
 FRONT FEET: 106.5 HIGH
 REAR FEET: 91.5 HIGH

2: V-11/17/93-06.30 pm
 A: 3.9
 B: 9.8
 C: 8
 (3.00)
 OFFSET: 4.5 RIGHT
 ANGLE: 0.0 / 1" RIGHT
 (12.00)
 OFFSET: 19.0 LEFT
 ANGLE: 0.0 / 1" RIGHT
 1: 1.0 LOW
 2: 1.5 LOW
 3: 2.0 LOW
 4: 1.5 LOW
 5: 1.0 LOW
 6: 0.5 LOW
 7: 0.0
 8: 0.5 LOW

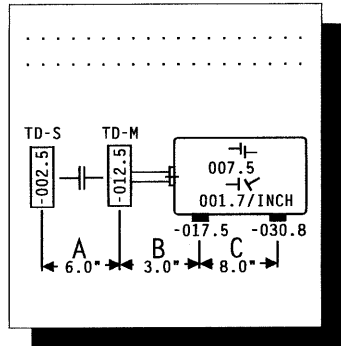



Print out using the screen dump.

Print out using the print list.

DATA TRANSMISSION

Connect the Combi-Laser M to a prepared computer with the optional cable 2-0138.

From the Main menu or the shaft alignment programs (1 or 2) press  to display the List menu (Save menu).

Press  for transmission of all the saved values. The values will now be transferred to the computer separated with semicolons (not with CR as shown below). The order of the values is as follows:

ASCII(02) STX

Serial number of the measurement

Sign for measurement type (V or H)

Timestamp

A measurement value

B measurement value

C measurement value

TD-S value

TD-M value

Offset value

Angular error value

Front foot value

Rear foot value

TD-S value

TD-M value

Offset value

Angular error value

Front foot value

Rear foot value

Hereafter comes the next measurement saved.

.....

ASCII(04) EOT

Horizontal position, 3 o'clock

Vertical position, 12 o'clock

In the measurement program 2 (shaft alignment vertical machines) the shimming values follows after Angular error value pos. 12 o'clock.

Compare with Printing, List and screen.

Parameters

Electrical parameters:

RS 232 C, DTE, 9 pin D-sub male connector

Limited handshake (RTS / CTS) .

Time out : 8 sec.

Connections

*Internal
connection*

Pin	Sign	Description
1		No connection
2	RX	Serial receive data
3	TX	Serial transmit data
4	DTR	Data terminal ready
5	GND	Signal ground
6	DSR	Data set ready
7	RTS	Request to send
8	CTS	Clear to send
9		No connection

Connector D-sub.

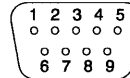

Communication parameters:

Baudrate: 9600 Bd

Parity : None

Databits: 8

Stopbit: 1

CHARGING

Display unit

Battery:

Power can be supplied during operation either by the internal battery or by the battery charger. The battery is a chargeable sealed lead battery which allows the system a continuous operation time of 20 hours. A battery icon  is lit when about 30 minutes of operation time remains. If the system will not be used for a longer time period, it should be stored with a fully-charged battery and be recharged every second month.

Battery charger:

Plug the charger into a 220 / 115 VAC outlet, connect the other end to the charging port on the back of the display unit. Charging occurs only if necessary and is indicated by a LED on the charger activated during the charging. The battery will be fully charged after 5 hours. Note that the chargers are different in different countries. This is shown in the CHECK LIST. Use the correct charger when charging the battery. Never use any other type of charger than the one supplied with the system.

Connection:

Charger port on the display unit. 4-pin. For charging and AC operation.

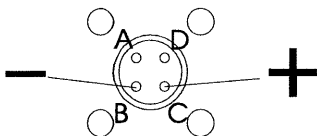

ADDITIONAL INFORMATION

Ambient light

Normal ambient light will not disturb the detector reading in such way that it will affect the measuring result. However, direct sunlight on the detector surface can make the system momentarily inoperable. The best way to get rid of this problem is to shade the detector.

Password

Some specific key combinations in the Main menu may result in a screen that shows:

PASSWORD _____

This is only for use by FIXTURLASER AB , but if this should happen: Turn off the system by pressing  nine times.

Cleaning

For cleaning any part in the Combi-Laser M system use only a cloth damped in alcohol or in a mild detergent.

The Combi-Laser M system is not intrinsically safe.

WHAT IS LASER ?

LASER is an acronym of the technical description of the process of Light Amplification by Stimulated Emission of Radiation.

Light is the visible part of the electromagnetic spectrum, which also includes UV, IR, microwaves etc. The optical wave length range consists of radiation with wave length of between 200 nm and 1 mm. Within this range radiation with wave lengths of between 400 nm and 780 nm is called light. In principle laser radiation is of the same kind as other types of light but with the difference that it only consists of light of one wave length. The risk of injury to eyes or skin from laser light is a result of the intensity of the light and not of its physical characteristics. This risk is the same as if a person stares into the sun for a short period of time. From the safety perspective it is therefore important to know which laser class which is used and the potential for injury.

The colours are from left to right:

*Red
Orange
Yellow
Green
Blue
Indigo
Violet*

*Diode laser in
Combi-Laser M system ~ 670 nm*

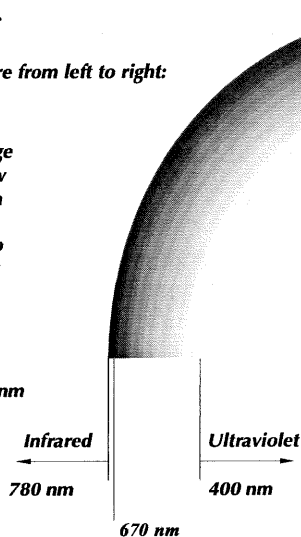

SAFETY PRECAUTIONS

The light source in the COMBI-LASER M's laser transmitter is a diode type laser with a wavelength of 670 nm and an output effect of < 0.5 mW. This diode type laser has a classification of Class II. As a Class II laser device this laser is considered a very safe laser for its intended uses with only minor precautions required.

- * **You should never stare directly into the laser transmitter.**

- * **Never aim the laser directly into anyone's eyes.**

The Combi-Laser M system is provided with several warning labels which serve several purposes :

- certification
- identification
- laser warning
- laser light aperture
- non-interlocked protective housing

Under no circumstances should the protective housings be opened or removed. The Combi-Laser M laser transmitter should be returned in their entirety to the company listed on the last page in this manual for service and repair. The unit contains no user serviceable parts, nor can the laser radiation be regulated by the user.

CAUTION: Opening the housing and tampering with the laser or unauthorized servicing of the laser transmitters may result in hazardous radiation exposure.

In USA the Combi-Laser M system complies with
21 CFR 1040.10 and 1040.11

The Combi-Laser M system is not intrinsically safe.

WARNING LABELS

TD-S and TD-M

Inside TD-Unit on laser.

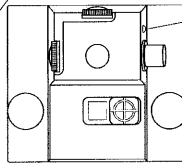
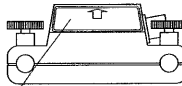
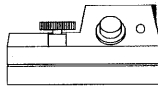
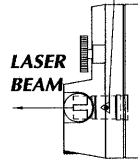
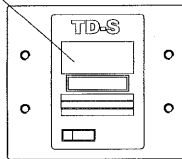
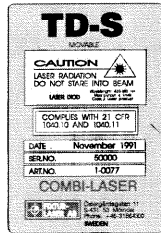

A green LED (Light Emitting Diode) on each TD unit shows when the laser is on.



TECHNICAL DATA

Transmitter / Detector Unit (TD-S / TD-M)

Laser Diode	Al-Ga-In-P
Wave length	670 nm
Laser class	2
Output power	< 0.5 mW
Beam size	ø 2 mm (3/32") at aperture
Divergence	0,3 mrad
Safety precautions	" Do not stare into beam "
Measurement distance	Up to 10 m (33 ft.)
Detector type	Single-Axis PSD
Detector area	10 x 10 mm (3/8" x 3/8")
Resolution	0.01 mm (0.0005")
Linearity	Linearized to ± 1% + 1 digit over full range.
Temperature range	0° - 50° C (32° - 122° F)
Light stabilization	No interference from ambient light
Relative humidity	10% - 95%

Display unit

Display	LCD dot matrix
Operating time	20 hours of continuously operation per charging
Charging time	5 hours
Contact	9-p D-sub pin
Output signal	Serial (RS 232) for printer or computer
Charger	220 Volts / 6 VDC, 110 Volts / 6 VDC

Carrying case with shock absorbing padding

Weight complete	11 kg (25 lb.)
-----------------	----------------

LICENSE AGREEMENT

Special Conditions for the licensing of software forming part of THE COMBI-LASER ALIGNMENT SYSTEM.

1. A P Fixturlaser AB ("Fixturlaser") grants the buyer of a specimen of THE COMBI-LASER M ALIGNMENT SYSTEM ("the Buyer") a nonexclusive licence to use the software of THE COMBI-LASER M ALIGNMENT SYSTEM ("the Software") in order to be able to use the acquired specimen of THE COMBI-LASER M ALIGNMENT SYSTEM as an alignment instrument.
2. All proprietary rights of and in the Software is the property of Fixturlaser. The Buyer may not copy, analyse or modify the Software.
3. The Buyer may not assign, transfer or sublicense the Software or in any other way make the Software available to a third party. Nor may the Buyer assign or transfer his rights and obligations according to these Special Conditions for the licensing of software to a third party. The Buyer may however, assign or let a specimen of THE COMBI-LASER M ALIGNMENT SYSTEM to a third party, provided however that such a third party agrees to these Special Conditions for the licensing of software.
4. Should the Buyer not observe these special Conditions for the licensing of software, this licence is automatically terminated and the Buyer is obliged to return to Fixturlaser, at his own costs, all copies of the Software, including the documentation belonging to it, which are in his possession.
5. Fixturlaser's responsibility for the Software is limited in accordance with ECE 188 and Addendum of 1987 to General Conditions for the Supply of Plant and Machinery for Export.

COMBI-LASER M

ALIGNMENT SYSTEM

Developed and manufactured by
FIXTURLASER AB

Fixturlaser AB
Östergårdsgatan 11
S-431 53 Mölndal SWEDEN
Phone: +46 31 86 43 00
Fax: +46 31 87 34 50

Fixturlaser AB reserves the right to make technical
modifications without giving prior notice.

Authorized sales and service agency :

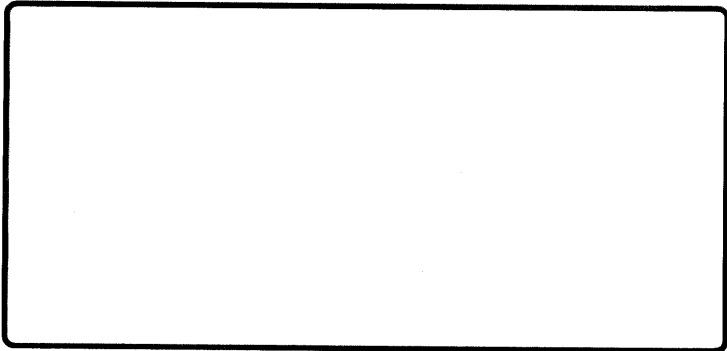

Publication no: P-0005-US

