



Advanced Test Equipment Corp.
www.atecorp.com 800-404-ATEC (2832)

Product Brochure

Anritsu envision:ensure

Vector Signal Generator

MG3710A

- 100 kHz to 2.7 GHz
- 100 kHz to 4.0 GHz
- 100 kHz to 6.0 GHz



Multi-Band Multi-System Multi-Channel

Cut Costs for New Wireless Tests



Dual Waveform Memory

One RF output supports two waveform memories!
Combine wanted and interference signals in baseband and output at one RF.

Dual RF

One unit supports two RF outputs!
Ideal for Multi-band, MIMO and MSR evaluations.

RF Modulation Bandwidth: 160 MHz*/120 MHz

Can generate and output signals for 160-MHz bandwidth max. wireless LAN (IEEE802.11ac) and for 120-MHz bandwidth.

The MG3710A is a vector signal generator with 6-GHz upper frequency limit and 160-MHz*/120-MHz wide RF modulation baseband generator. It outputs various radio systems signals for cellular communications, such as 5G, LTE FDD/TDD, W-CDMA, GSM as well as narrowband communications, such as WLAN, WiMAX, Bluetooth and GPS.

Cuts Equipment Costs

The dual waveform memory cuts equipment costs for tests, such as ACS, Blocking and IM, which require two modulation signal sources.
The dual RF cuts MIMO equipment costs and reduces workloads for phase synchronization between equipment. It is important for tests using separate signals, such as MSR and multi-band.

*: Supports firmware version 2.00.00 and later. Can generate 160-MHz bandwidth signals (Wireless LAN IEEE802.11ac) only when using MX370111A WLAN IQproducer and MX370111A-002 802.11ac (160 MHz) option. The latest version can be downloaded from the Anritsu homepage. <<https://www1.anritsu.co.jp/Download/MService/Login.asp>>

Improves Yield

The excellent signal generator ACLR and SSB phase noise reduces the effect on wideband and narrow-band measurements to improve test margins and yields.

-71 dBc @W-CDMA, TestModel1, 64DPCH, 2 GHz
<-140 dBc/Hz (nom.) @100 MHz, 20 kHz offset, CW

Cuts Tact Time

The List/Sweep mode switches the frequency and level faster than 600 μ s. Moreover, the 4-GB waveform memory upgrade can load many waveform patterns while instantaneous switching eliminates time wasted reloading waveform patterns.

MG3710A Vector Signal Generator

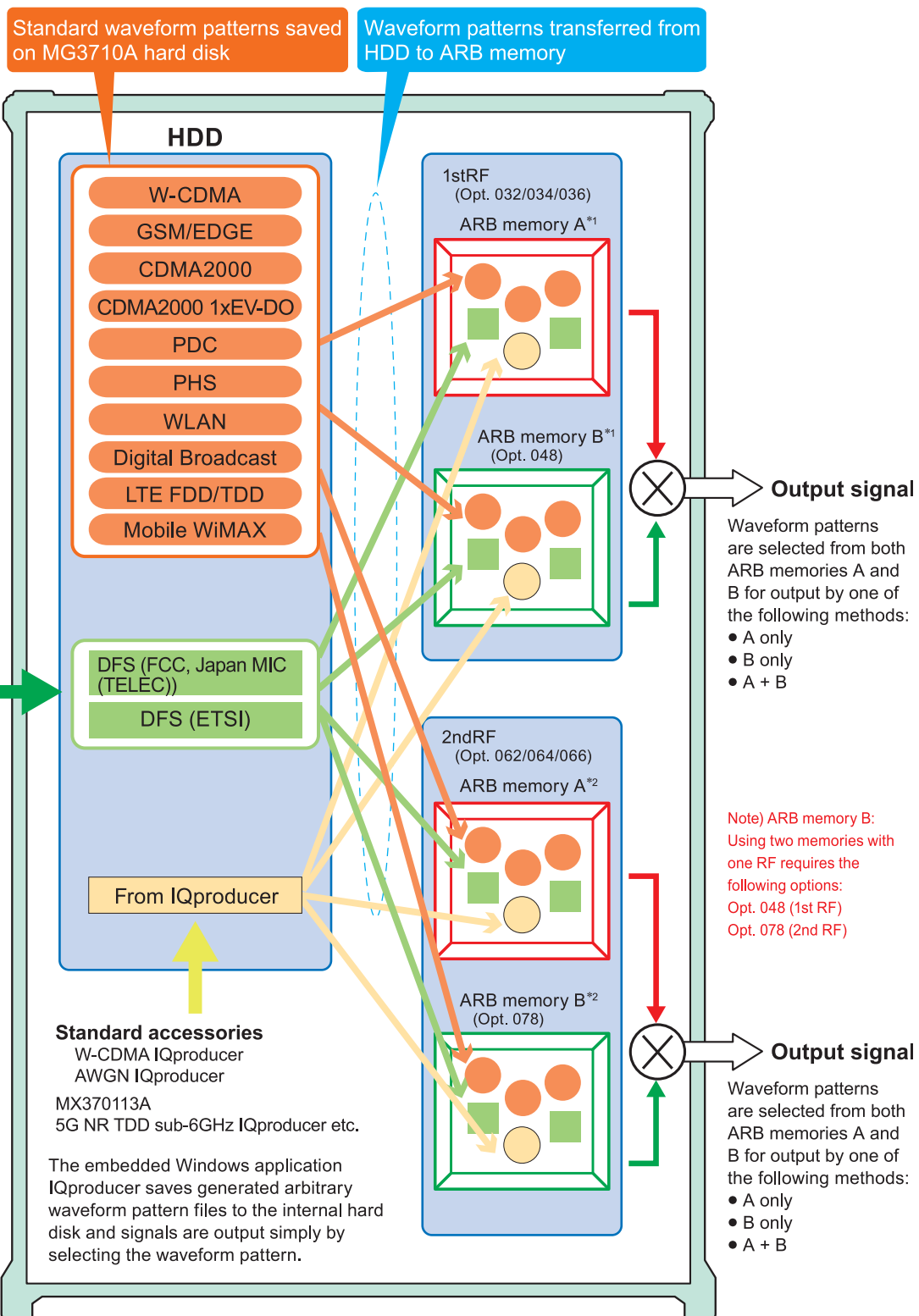

*1: 1stRF ARB memory size
 256 MB × 1 pc = 64 Msamples (Std.)
 1 GB × 1 pc = 256 Msamples × 1 pc (Opt. 045)
 1 GB × 2 pcs = 256 Msamples × 2 pcs (Opt. 045 + Opt. 048)
 4 GB × 1 pc = 1024 Msamples × 1 pc (Opt. 046)
 4 GB × 2 pcs = 1024 Msamples × 2 pcs (Opt. 046 + Opt. 048)

*2: 2ndRF ARB memory size
 256 MB × 1 pc = 64 Msamples (Std.)
 1 GB × 1 pc = 256 Msamples × 1 pc (Opt. 075)
 1 GB × 2 pcs = 256 Msamples × 2 pcs (Opt. 075 + Opt. 078)
 4 GB × 1 pc = 1024 Msamples × 1 pc (Opt. 076)
 4 GB × 2 pcs = 1024 Msamples × 2 pcs (Opt. 076 + Opt. 078)

Key Features

Dual RF & Dual Waveform Memory

- **One Unit Supports Two RF Outputs Max.**
- **Frequency Range**
1stRF: 100 kHz to 2.7/4.0/6.0 GHz [Opt. 032/034/036]
2ndRF: 100 kHz to 2.7/4.0/6.0 GHz [Opt. 062/064/066]
- **Independent Baseband and RF Outputs**
- **Output Two Signals from One RF Out [Opt. 048/078]**
The baseband signal combine option installs two waveform memories for either the 1stRF (or 2ndRF) SG to combine two waveform patterns as the baseband for output, eliminating the need for two separate and expensive vector signal generators.

Wanted Signal + Interfere Signal
Wanted Signal + Delayed Signal, etc.

Basic Performance

- **ACLR Performance**
-71 dBc @W-CDMA, TestModel1, 64 DPCH, 2 GHz



W-CDMA ACLR (1 Carrier)
Waveform Pattern (TestModel1, 64DPCH)

- **High-power Output [Opt. 041/071]**
+23 dBm @CW, 400 MHz to 3 GHz
- **High-speed Switching**
< 600 μ s @List/Sweep mode
- **High Level Accuracy**
Absolute Level Accuracy: ± 0.5 dB
Linearity: ± 0.2 dB (typ.)
- **Choice of Reference Oscillators**
- Standard
Aging rate $\pm 1 \times 10^{-6}$ /year, $\pm 1 \times 10^{-7}$ /day
- High Stability Reference Oscillator [Opt. 002]
Aging rate $\pm 1 \times 10^{-7}$ /year, $\pm 1 \times 10^{-8}$ /day
- Rubidium Reference Oscillator [Opt. 001]
Aging rate $\pm 1 \times 10^{-10}$ /month

SSB Phase Noise Performance

- <-140 dBc/Hz (nom.) @100 MHz, 20-kHz offset, CW
- <-131 dBc/Hz (typ.) @1 GHz, 20-kHz offset, CW
- <-125 dBc/Hz (typ.) @2 GHz, 20-kHz offset, CW

Single sideband phase noise

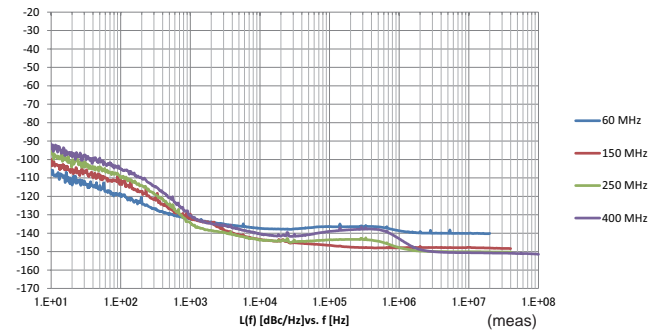

High All-purpose Baseband Performance

- **Wide Vector Modulation Bandwidth**
160 MHz*/120 MHz (using Internal baseband signal generator)
160 MHz (using External IQ input)
*: Supports firmware version 2.00.00 and later. Can generate 160-MHz bandwidth signals (Wireless LAN IEEE802.11ac) only when using MX370111A WLAN IQproducer and MX370111A-002 802.11ac (160 MHz) option.
- **Large-capacity Waveform Memory**
64 Msamples [with 1stRF, 2ndRF]
256 Msamples [Opt. 045/075]
1024 Msamples [Opt. 046/076]
- **Arbitrary Waveform Generation**
ASCII IQ sample data created using general-purpose signal generation software (such as MATLAB) can be converted to waveform patterns for the MG3710A. Data produced during R&D simulations can be converted using IQproducer.

Expandability

- **BER Test Function [Opt. 021]**
This option measures BER using Data/Clock/Enable demodulated at the DUT to display the results on the MG3710A screen.
 - Input bit rate: 100 bps to 40 Mbps
- **Analog/Pulse Modulation Functions [Standard]**
*: Supports built-in analog modulation (AM/FM/ Φ M) functions and pulse modulation (PM) functions.
Adding additional analog modulation input options (Opt. 050/080) supports modulation by external signal input.
- **AWGN Generator [Opt. 049/079]**
This options generates AWGN internally for the required waveform.
 - Absolute CN Ratio: ≤ 40 dB
- **USB Power Sensors [Sold separately]**
Up to two USB power sensors can be connected to the MG3710A and the results are displayed on the MG3710A screen.
 - Frequency Range: 50 MHz to 6 GHz [MA24106A]
10 MHz to 18 GHz [MA24118A]
10 MHz to 26 GHz [MA24126A] etc.
- **Local Signal I/O for MIMO Signal Source [Opt. 017]**
Local signals, baseband clocks and trigger signals can be shared between up to four MG3710A units to output phase coherency signals with synchronized signal output timing for configuring even 8x8 MIMO systems.

Operability

- **Simple Touch-panel Operation**

Touching the easy-to-use GUI with hierarchical menus fetches related function and numeric input keys for simple fast settings.

- **Signal Flowcharts with Signal Block Diagrams**

Two intuitive Hardware Block Chart and ARB Info screens make it easy to grasp settings, data and signal paths at a glance.

- **Frequency Channel Table**

A built-in channel table with presets for popular communications systems simplifies frequency settings by using channel numbers.

Connections with External Equipment

- **Remote Control Interfaces**

GPIO, Ethernet (1000BASE-T), and USB (Type B) interfaces on the rear panel offer versatile choices for operation by remote control.

- **USB Connections**

Two Type A USB2.0 connectors on each of the front and rear panels offer convenient connections for keyboard, mouse and USB memory.

- **Analog IQ Input/Output [Opt. 018]**

This option installs analog IQ input and output connectors on the front and rear panels, respectively.

Input: I Input, Q Input

Output: I Output, \bar{I} Output, Q Output, \bar{Q} Output,

- **Trigger Input**

Start and Frame trigger connectors are built-in in as standard for outputting waveform patterns synchronized with externally input trigger signals.

- **Marker Output Editing**

Marker 1 output [Standard]

Marker 2 and 3 output

[Requires J1539A AUX Conversion Adapter]

This standard function outputs trigger signals at specific positions in the waveform pattern (Frame header, Burst header, etc.) for synchronizing and measuring signal generator waveform patterns with external equipment. Preset markers can be set at both the pre-installed waveform patterns and waveforms generated using IQproducer and any set markers can be output with the MG3710A marker editing function.

Security

The standard OS in MG3710A units ordered after June 2018 is Windows 7 (WES7).

- **Upgrade MG3710A Windows XP OS to Windows 7 [Opt. 181]**

The standard OS in MG3710A units ordered until May 2018 is Windows XP. (A few MG3710A units with Opt. 029 (sales discontinued) have Windows7 (Professional) installed.) The OS of these MG3710A units can be upgraded to Windows 7 (WES7) using Opt. 181. Moreover, changing to a faster CPU at the same time as using Opt. 181 also shortens the time required to generate waveform patterns using IQproducer installed in the MG3710A.

- **User Data Storage on 2ndary HDD [Opt. 011]**

This option is useful for saving sensitive waveform pattern data, etc., used at evaluation that cannot be allowed to leave the laboratory, workplace, factory, etc. The 2ndary HDD can be removed from/installed in the rear-panel slot when wanting to keep this saved data secure when the MG3710A is sent for service, used by third parties, etc.

Pre-installed Key Waveform Patterns

- **Waveform Patterns [Pre-installed]**

Waveform patterns for the world's main communications systems (below) are pre-installed in the MG3710A for license-free use.

- LTE FDD (E-TM1.1 to E-TM3.3)
- LTE TDD (E-TM1.1 to E-TM3.3)
- W-CDMA/HSDPA
- GSM/EDGE
- CDMA2000 1X/1xEV-DO
- Bluetooth® • GPS • PDC • PHS
- Digital Broadcast (ISDB-T/BS/CS/CATV)
- WLAN (IEEE802.11a/11b/11g)

Waveform Pattern Options and Generation

- **Optional Waveform Pattern [Optional License]**

- DFS Radar Pattern (For FCC & Japan MIC (TELEC))
- DFS (ETSI) Waveform Pattern
- ISDB-Tmm Waveform Pattern

- **IQproducer Waveform Generation Software [Optional License]**

- 5G NR TDD sub-6GHz
- LTE FDD/LTE-Advanced FDD
- LTE TDD/LTE-Advanced TDD
- HSDPA/HSUPA/W-CDMA
- TD-SCDMA
- CDMA2000 1xEV-DO
- Mobile WiMAX
- WLAN 11a/b/g/n/j/p/ac
- TDMA (PDC, PHS, Public Radio System.)
- DVB-T/H
- Multi-carrier
- Fading

Dual RF & Dual Waveform Memory

Dual VSG: Two RF Outputs

The MG3710A supports two RF outputs (1stRF/2ndRF) max. in one unit. Moreover, different frequencies can be set independently at 1stRF and 2ndRF.

Not only different frequencies but also different levels and waveform patterns can be set independently at each SG while each is tracking the other. This is convenient in the R&D phase for evaluating interference between two different systems using different frequency bands.

Notes: Supported frequency bands cannot be changed after shipment.
IQ input is supported only by SG1 (1stRF) and requires Opt. 017.

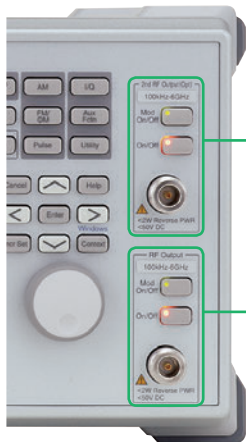

- 2ndRF**
Frequency Range:
2ndRF 100 kHz to 2.7 GHz [Opt. 062]
2ndRF 100 kHz to 4.0 GHz [Opt. 064]
2ndRF 100 kHz to 6.0 GHz [Opt. 066]
* Whether or not install and the frequency model can be selected at any time.
- 1stRF**
Frequency Range:
1stRF 100 kHz to 2.7 GHz [Opt. 032]
1stRF 100 kHz to 4.0 GHz [Opt. 034]
1stRF 100 kHz to 6.0 GHz [Opt. 036]
* Must install any one of these.

Dual Waveform Memory: Four Waveform Outputs Max.

In the standard configuration, one VSG (1stRF or 2ndRF) has one waveform memory. However, adding the baseband signal combine option (Opt. 048/078) upgrades to two memories for one VSG. In other words, models with two VSGs (1stRF and 2ndRF) installed can have a maximum of four waveform memories. Two waveform patterns can be set easily on-screen for one VSG, each with different frequency offset, level offset and delay time settings to output a combined baseband RF signal. With this setup, one MG3710A supports the following test environment — a setup that previously required two expensive signal generators:

- Wanted Signal + Interference Signal
- Wanted Signal + Delayed Signal

Synthesizing Signals with Different Sampling Rates ~ Rate Matching Function ~

When signals with different sampling rates are set in memory A and memory B, a synthesized signal maintaining each of the different sampling rates can be output. This is useful when synthesizing signals for standards with different rates, such as multi-standard signals.

However, depending on the combination of waveform sampling rates, sometimes it may not be possible to match rates due to internal operation clock limitations. The Mismatch warning dialog is displayed in this case.

Waveform Pattern A
Example: Wanted Signal

Waveform Pattern B
Example: Interference Signal, Delayed Signal

Level Setting
Setting Range: -80 to +80 dB
Resolution: 0.01 dB

Frequency Offset Setting
Setting Range: -100 to +100 MHz
Resolution: 1 Hz

Center Frequency Selection
A: Pattern A center
B: Pattern B center
Baseband DC: Centered at baseband DC position

Time Offset Setting
Setting Range: 0 ~ pattern B sampling data count - 1

Baseband Signal Combine Example

Example of Baseband Signal Combine Output



Wanted + Modulated Interference Signals

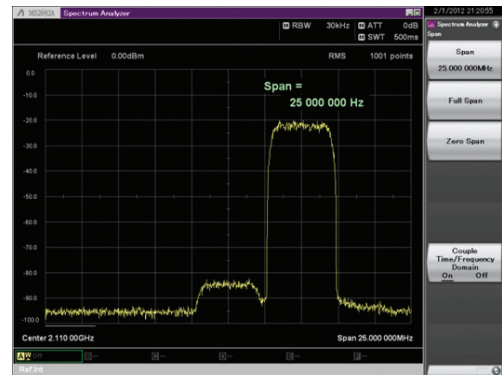
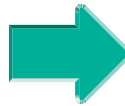

Spectrum of
Wanted + Modulated Interference Signals



Wanted + Delayed Signals

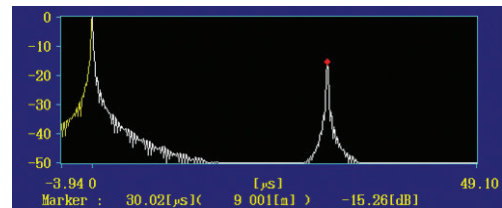

Delay Profile of
Wanted + Delayed Signals

Basic Performance

ACLR Performance

-71 dBc/3.84 MHz @W-CDMA, TestModel1, 64DPCH, 2 GHz

Evaluation of base station amplifiers, etc., requires excellent adjacent channel leakage power (ACLR) performance. Normally, the signal from the vector signal generator is inserted to an amplifier, and the amplifier output signal ACLR characteristics, etc., are measured with a spectrum analyzer. Instruments for these measurements require high ACLR performance.

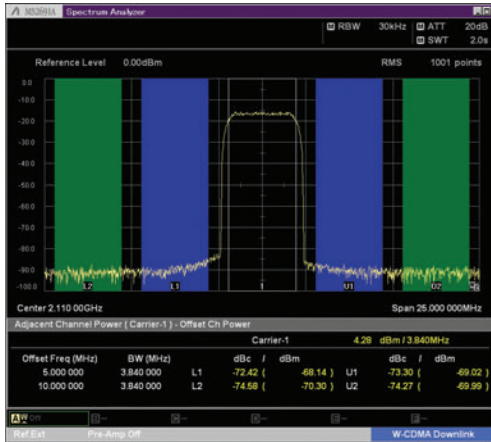

W-CDMA ACLR, 1 Carrier
(TestModel1, 64DPCH)



W-CDMA ACLR, 4 Carrier
(TestModel1, 64DPCH, 4 Carrier)



LTE FDD ACLR, 1 Carrier
(E-TM1.1, Bandwidth 20 MHz)

High-power Output [Opt. 041*1/071*2]

- *1: High Power Extension for 1stRF [Opt. 041]
- *2: High Power Extension for 2ndRF [Opt. 071]

Level Accuracy is assured at high levels (CW)

Frequency Range	Standard	Opt. 041/071
100 kHz ≤ f < 10 MHz	+5 dBm	+5 dBm
10 MHz ≤ f < 50 MHz	+10 dBm	+10 dBm
50 MHz ≤ f < 400 MHz	+13 dBm	+20 dBm
400 MHz ≤ f ≤ 3 GHz		+23 dBm
3 GHz < f ≤ 4 GHz	+13 dBm	+20 dBm
4 GHz < f ≤ 5 GHz		+13 dBm
5 GHz < f ≤ 6 GHz	+11 dBm	+11 dBm

These options expand the MG3710A RF output upper limit. They are used when compensating for level losses of parts in the measurement path.

Maximum output power

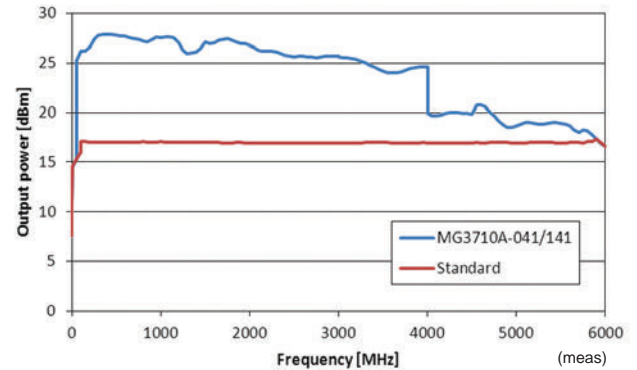

SSB Phase Noise

- <-140 dBc/Hz (nom.) @100 MHz, 20-kHz offset, CW
- <-131 dBc/Hz (typ.) @1 GHz, 20-kHz offset, CW
- <-125 dBc/Hz (typ.) @2 GHz, 20-kHz offset, CW

SSB phase noise is an important performance index for signal generators. For example, when using a signal generator for the following purposes, it is important to pre-confirm that the signal generator performance satisfies the measurement specifications.

- Communications with narrow bandwidth of several kHz
- OFDM Signals with narrow subcarrier gap
- CW interference waveforms

Single sideband phase noise

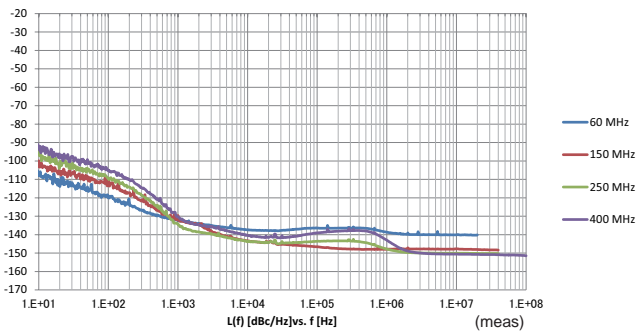

Single sideband phase noise

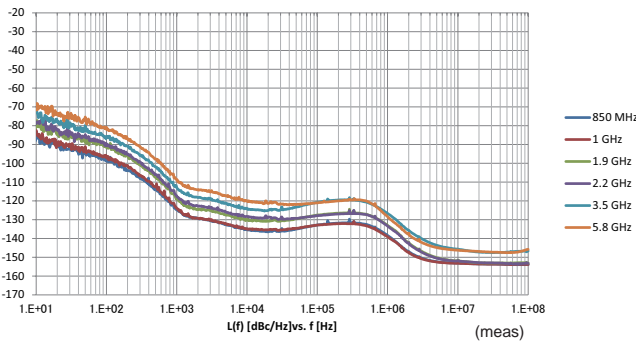

SSB Phase Noise

(Phase Noise Optimization <200 kHz, CW, Optimize S/N Off, with Opt. 002)

High-speed Switching

<600 μs @List/Sweep mode

To shorten tact times on production lines the MG3710A supports two standard modes each with high-speed frequency and level switching.

• Sweep Mode

In this mode, the dwell time per point or number of points is split between the frequency range and level range (Start/Stop). This mode is used when matching dwell time per point and frequency/level steps.



• List Mode

In this mode, the frequency, level and dwell time can be set for each of up to 500 points. This mode is used when wanting to set any dwell time, and frequency/level step per point.

High Level Accuracy

Absolute Level Accuracy: ± 0.5 dB^{*1}

Linearity: ± 0.2 dB (typ.)^{*2}

*1: 400 MHz to 3 GHz, -110 to +10 dBm

*2: 50 MHz to 3 GHz, -110 to -1 dBm

Excellent level accuracy and linearity are key factors with a large impact on measurement accuracy.

Level accuracy at -112 dBm

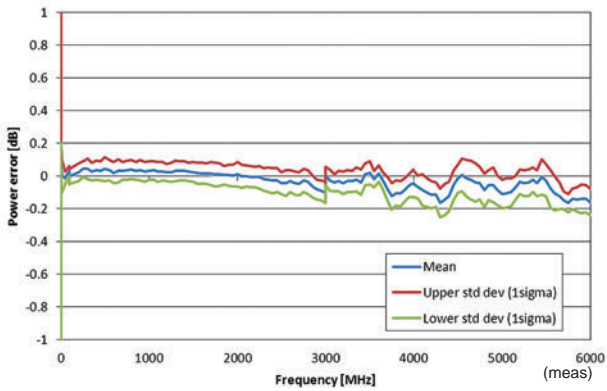

Frequency Characteristic

Relative level accuracy at 850 MHz initial power +10 dBm

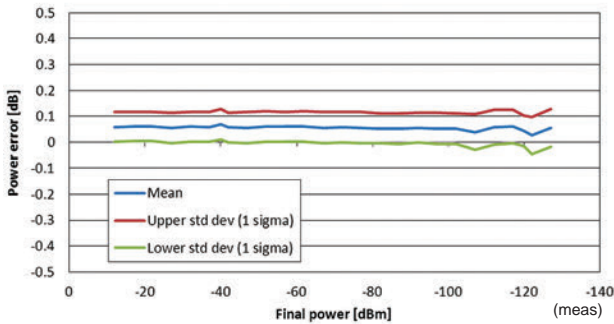

Linearity

Amplitude repeatability +5 dBm ALC on

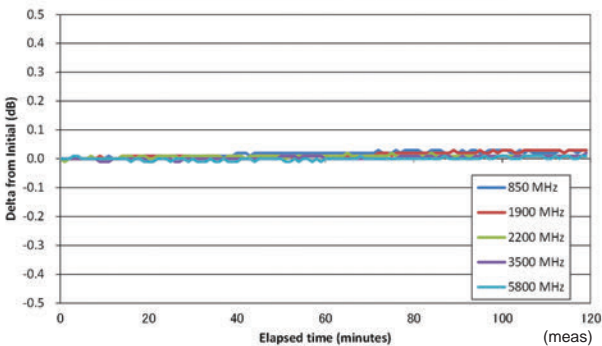

Aging

Supports Rubidium Reference Oscillator (Option)

Three reference oscillator options are supported. Select the high-stability reference oscillator option [Opt. 002] when requiring high accuracy depending on the measurement conditions; for even higher accuracy, select the rubidium reference oscillator [Opt. 001]. However, if external high-accuracy reference signals are available, selecting the standard reference oscillator option helps reduce unnecessary costs.

• Reference Oscillator

• Standard

Aging Rate: $\pm 1 \times 10^{-6}$ /year, $\pm 1 \times 10^{-7}$ /day

Temperature Stability: $\pm 2.5 \times 10^{-6}$ (5° to 45°C)

• High Stability Reference Oscillator [Opt. 002]

Aging Rate: $\pm 1 \times 10^{-7}$ /year, $\pm 1 \times 10^{-8}$ /day

Temperature Stability: $\pm 2 \times 10^{-6}$ (5° to 45°C)

Start-up Characteristics*: $\pm 5 \times 10^{-7}$ (2 minutes after power-on)

$\pm 5 \times 10^{-8}$ (5 minutes after power-on)

• Rubidium Reference Oscillator [Opt. 001]

Aging Rate: $\pm 1 \times 10^{-10}$ /month

Temperature Stability: $\pm 2 \times 10^{-9}$ (5° to 45°C)

Start-up Characteristics*: $\pm 1 \times 10^{-9}$ (7.5 minutes after power-on)

*: Compared to frequency after 24-h warm-up at 23°C

High All-purpose Baseband Performance

Wide Vector Modulation Bandwidth

160 MHz*/120 MHz (using Internal baseband signal generator)
160 MHz (using External IQ input)

Using the standard internal baseband signal generator offers a wide vector modulation bandwidth of 160 MHz.

*: Supports firmware version 2.00.00 and later. Can generate 160-MHz bandwidth signals (Wireless LAN IEEE802.11ac) only when using MX370111A WLAN IQproducer and MX370111A-002 802.11ac (160 MHz) option.
The latest version can be downloaded from the Anritsu homepage.
<<https://www1.anritsu.co.jp/Download/MService/Login.asp>>

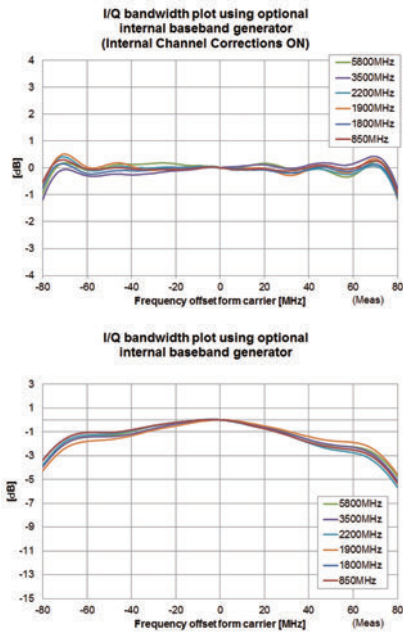

Point:

- One unit supports WLAN IEEE802.11ac signal generation and output !
- Upper Frequency Limit: 6 GHz
- RF Modulation Bandwidth: 160 MHz
- Dual RF: Two RF Outputs
- Waveform Generation Software
- WLAN IQproducer (MX370111A & MX370111A-002)

The MG3710A supports output from 160-MHz bandwidth signals to non-contiguous 80 MHz + 80 MHz signals in one unit, which generally requires two signal generators.

Example: Support IEEE802.11ac signal generation and output

11ac Bandwidth	20/40/80/160 MHz	80 MHz + 80 MHz (non-contiguous)
MG3710A*1	✓	✓*2

*1: MX370111A WLAN IQproducer and MX370111A-002 802.11ac (160 MHz) option installed. For detail, refer to the IQproducer catalog.

*2: 2ndRF option MG3710A-062 (2.7 GHz)/064 (4 GHz)/066 (6 GHz) installed.

Free Waveform Generation

ASCII-format IQ sample data files created by other general-purpose EDA tools, such as MATLAB, can be converted into MG3710A waveform pattern files. Support for customer waveform pattern file creation makes the MG3710A ideal for R&D simulation applications too.

Large-capacity Waveform Memory

64 Msamples (256 MB) [with 1stRF, 2ndRF]

256 Msamples (1 GB) [Opt. 045*1/075*2]

1024 Msamples (4 GB) [Opt. 046*1/076*2]

*1: ARB Memory Upgrade 256 Msample for 1stRF [Opt. 045]
ARB Memory Upgrade 1024 Msample for 1stRF [Opt. 046]

*2: ARB Memory Upgrade 256 Msample for 2ndRF [Opt. 075]
ARB Memory Upgrade 1024 Msample for 2ndRF [Opt. 076]

Memory size is the most important specification for arbitrary waveform memory. If the memory is small, large waveform patterns cannot be handled and the number of cases when multiple waveform patterns cannot be loaded increases. When this happens, the time to reload another waveform pattern wastes evaluation time and lowers efficiency. The MG3710A has a large 64 Msamples memory as standard and this can be upgraded to either 4 times (256 Msamples) or 16 times (1024 Msamples) by adding these options.

Point:

Adding the baseband signal combine function (Opt. 048/078) supports waveform memories which can either be used separately or linked to multiply the memory size.

*: When attempting to load a waveform pattern exceeding the size of one memory, the memories are linked automatically to load the large pattern. However, in this case, other waveform patterns cannot be loaded into any remaining free space.

When dealing with many waveform patterns, we recommend upgrading the ARB memory size. If the waveform pattern can be handled by one memory, other waveform patterns can be loaded into the remaining free space and the other memory.

The maximum size per waveform pattern supported by the MG3710A varies with the IQproducer version.

Maximum Waveform Pattern Size and Required Options for Simultaneous Use

1stRF (Opt. 032/034/036)

Combination of Baseband Signal (Opt. 048)	ARB Memory Upgrade 256 Msample (Opt. 045) ARB Memory Upgrade 1024 Msample (Opt. 046)		
	W/O	With Opt. 045	With Opt. 046
W/O	64 Msamples x 1 pc	256 Msamples x 1 pc	1024 Msamples x 1 pc*1
With Opt. 048*2	64 Msamples x 2 pcs 128 Msamples x 1 pc	256 Msamples x 2 pcs 512 Msamples x 1 pc	1024 Msamples x 2 pcs*1

2ndRF (Opt. 062/064/066)

Combination of Baseband Signal (Opt. 078)	ARB Memory Upgrade 256 Msample (Opt. 075) ARB Memory Upgrade 1024 Msample (Opt. 076)		
	W/O	With Opt. 075	With Opt. 076
W/O	64 Msamples x 1 pc	256 Msamples x 1 pc	1024 Msamples x 1 pc*1
With Opt. 078*2	64 Msamples x 2 pcs 128 Msamples x 1 pc	256 Msamples x 2 pcs 512 Msamples x 1 pc	1024 Msamples x 2 pcs*1

*1: The maximum size per waveform pattern supported by the MG3710A varies with the IQproducer version.

*2: The Baseband Signal Combine option supports two ARB memories and can either set two different waveform patterns or combine them as one memory to support one large waveform pattern.

Expandability

BER Test Function [Opt. 021]

This option installs a BER measurement function for measuring error rates between 100 bps and 40 Mbps using the DUT demodulated Data/Clock/Enable signals. The results are displayed on the MG3710A screen.

- **Input Bit Rate: 100 bps to 40 Mbps**
- **Input Signal: Data, Clock, Enable**
(Polarity reversal supported)
- **Input Level: TTL**
- **Measured Patterns:**
PN9/11/15/20/23, ALL1, ALL0, Alternate (0101...), User Data, PN9fix/11fix/15fix/20fix/23fix
- **Count Mode**
Data: Measures until specified Data count
Error: Measures until specified Error count
- **Measurable Bit Count: $\leq 2^{32} - 1$ (4,294,967,295 bits)**
- **Measurement Mode**
Single: Measures specified measurement bit count once
Continuous: Repeats Single measurement
Endless: Continues measurement to upper limit of measurement bits

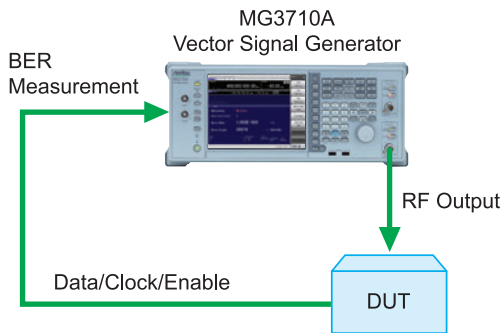

The BER can be measured using the DUT-demodulated Data/Clock/Enable.

• BER Measurement Upper Limit

The table below shows one example of a BER measurement that indicates SyncLoss. Actual results depend on the specific communication systems and data rate, and will not necessarily match the measurement values below.

Error Rate	PN9	PN11	PN15	PN20	PN23
6.0%	–	–	–	–	–
5.0%	ok	–	–	–	–
4.0%	ok	ok	–	–	–
3.0%	ok	ok	ok	–	–
2.5%	ok	ok	ok	–	–
2.0%	ok	ok	ok	ok	ok
1.0%	ok	ok	ok	ok	ok

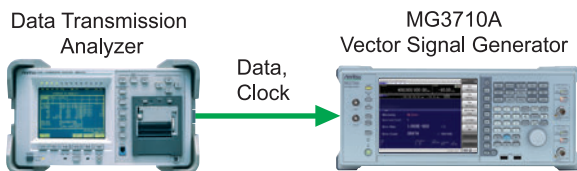

AM/FM/ΦM/PM Function

This option supports the following modulation functions as standard. Analog modulations (AM/FM/ΦM) are performed on CW signals or arbitrary (ARB) waveform pattern signals. Pulse modulation can be performed at any cycle or timing and also supports modulation using an external input signal.

- **Amplitude Modulation (Internal Modulation Source)**
 - Depth: 0 to 100% (Linear)
0 to 10 dB (Exponential)
 - Modulation Frequency: 0.1 Hz to 50 MHz
 - **Frequency Modulation (Internal Modulation Source)**
 - Deviation: 0 to 40 MHz
 - Modulation Frequency: 0.1 Hz to 40 MHz, or (50 MHz-FM Rate), whichever smaller
 - **Φ-Modulation (Internal Modulation Source)**
 - Deviation angle: 0 to 160 rad.
or (40 MHz/ΦM Rate) rad., whichever smaller
 - Modulation Frequency: 0.1 Hz to 40 MHz, or (40 MHz/ΦM Deviation), whichever smaller
 - **Pulse Modulation (Internal Modulation Source)**
 - Modulation Frequency: 0.1 Hz to 10 MHz
 - Modulation Period: 10 ns to 20 s
 - **Additional Analog Modulation Input [Opt. 050/080]**
Adding additional analog modulation input options (Opt. 050/080) extends to two internal modulation sources (AM/FM/ΦM) and one external modulation source supporting simultaneous two-signal modulation.
 - AM + FM
 - AM + ΦM
 - Internal 1 + Internal 2
 - Internal + External
- *: FM + ΦM does not support.

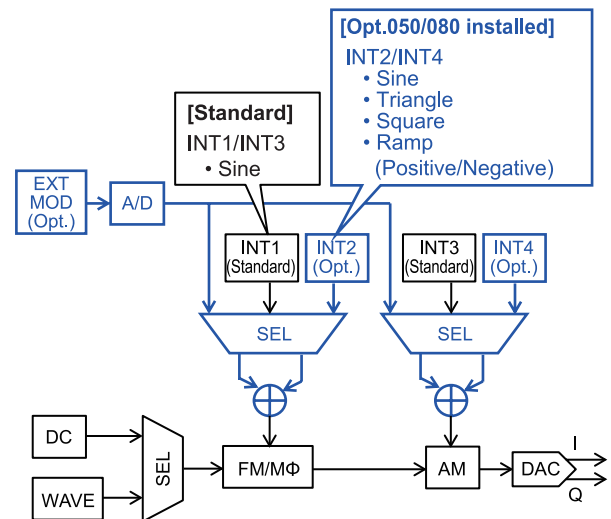

AWGN Generator [Opt. 049*1/079*2]

- *1: AWGN for 1stRF [Opt. 049]
- *2: AWGN for 2ndRF [Opt. 079]

This option adds internally generated AWGN to the wanted signal. The AWGN output is switched on and off just by pressing the On/Off button.

- **Absolute C/N Ratio: ≤40 dB**

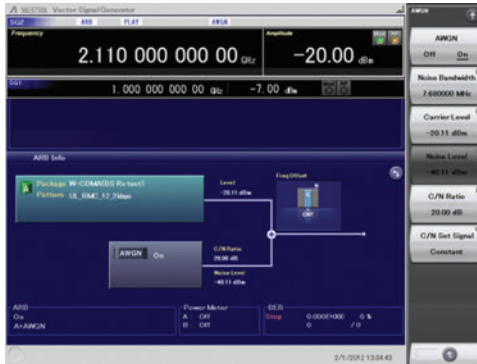

AWGN Signal Addition Screen

USB Power Sensors [Sold separately]

Up to two USB power sensors can be connected to the MG3710A to display the measurement results on the MG3710A screen.

- **USB Power Sensor**

Model	Frequency Range	Dynamic Range
MA24104A*	600 MHz to 4 GHz	+3 to +51.76 dBm
MA24105A	350 MHz to 4 GHz	+3 to +51.76 dBm
MA24106A	50 MHz to 6 GHz	-40 to +23 dBm
MA24108A	10 MHz to 8 GHz	-40 to +20 dBm
MA24118A	10 MHz to 18 GHz	-40 to +20 dBm
MA24126A	10 MHz to 26 GHz	-40 to +20 dBm

*: MA24104A has been discontinued. Replacement model is MA24105A.

Level Offset: -100 to +100 dB

Average: 1 to 2048

Unit: dBm, W

COM Port: 2 to 8

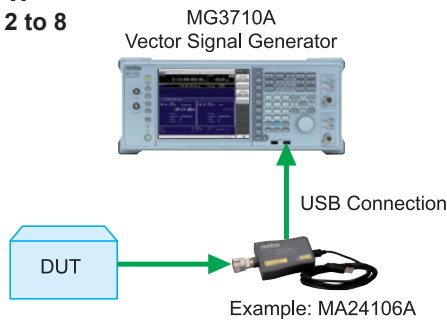

Power Meter Measurement Screen

Checking Com Port:

1. Display Windows
Press [Shift] + [Context (Windows)] or Right-click mouse > Show Desktop
2. Display Device Manager
Start > My Computer > Properties > Hardware > Device Manager
3. Check Ports (COM & LPT)

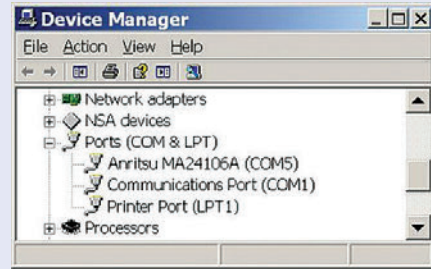

Local Signal I/O for MIMO Signal Source [Opt. 017]

The Sync Multi SG function shares local, baseband and trigger signals between multiple MG3710A units to output phase coherency signals synchronized with the signal output timing. An 8x8 MIMO test system is configured easily from four MG3710A units composed of one master and three slaves.

Synchronization mode: Master, Slave, SG1 & 2

Number of Slaves: 1 to 3

Slave Position: 1 to 3

Local Synchronization: On/Off

IQ Phase Adjustment: -360 deg. to +360 deg., Resolution 0.01 deg.

IQ Delay: -400 ns to +400 ns, Resolution 1 ps

Common Setting
Number of Slaves: 3
LO Sync: On

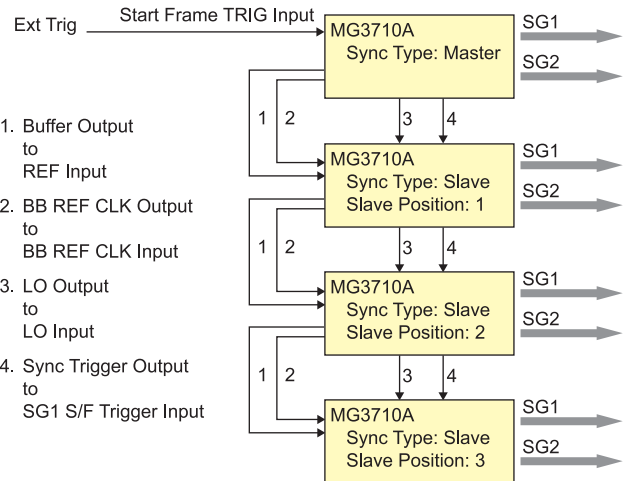

Note: Option-017 is not required when synchronizing the local signal and baseband clock of SG1 (1stRF) and SG2 (2ndRF) installed in one MG3710A unit.

Operability

Easy Touch-panel Operation

Simply touching parts of the screen display with a finger fetches related function keys and numeric inputs, offering a fast and easy way of navigating through multilayer menus.

Modulation Screen (Mode)

Frequency Setting

Level Setting

Waveform Pattern Selection

Power Meter Function

BER Function

Two Signal Flowcharts

Pressing the on-screen  button toggles instantly between the Hardware Block Chart and the ARB Info screens. The Hardware Block Chart is a quick-and-easy way to grasp the status of each block (ARB, AWGN, I/Q, Analog Mod, Pulse Mod, Local) at a glance. The ARB Info screen displays more details about the ARB/AWGN block showing the baseband signal combine status of memory A + memory B, memory A + AWGN, etc.









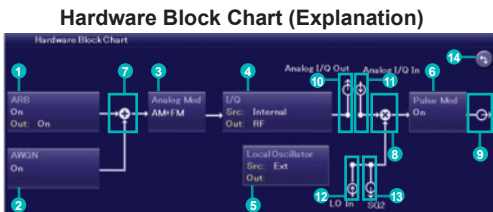









ARB Info Screen



Hardware Block Chart Screen



Hardware Block Chart Display Contents (Explanation)

No.	Display Example	Display	Description
1		ARB	ARB block
		On/Off	Indicates On/Off of ARB (function to generate modulated signals with arbitrary waveform patterns)
		Out	Indicates On/Off of the arbitrary waveform pattern output
2		AWGN	AWGN block
		On/Off	Indicates On/Off of AWGN addition
3		Analog Mod	Analog Modulation block
		AM/FM/ΦM	Indicates the analog modulation (AM/FM/ΦM) during modulation
4		I/Q	I/Q block
		Src: Internal/ Analog I/Q In	Indicates the I/Q signal source
4		Out: RF/Analog I/Q Out	Indicates the output destination for baseband signals
5		Local Oscillator	Local Oscillator block
		Src: Int/Ext/Sync	Indicates the Local signal source
5		Out: -/On/Off	Indicates On/Off of the Local signal external output
6		Pulse Mod	Pulse Modulation block
6		On/Off	Indicates On/Off of Pulse modulation
7		-	Indicates that inputs from two function blocks of the left side and bottom side are combined and output to the function block of the right side
8		-	Indicates that the input Local signal from the bottom side is modulated with the input signal from the left side and output to the function block of the right side
9		-	Indicates the RF Output is On
10		Analog I/Q Out	Indicates the Analog I/Q signal is set to the external output
11		Analog I/Q In	Indicates the Analog I/Q signal is set to the external input
12		LO In (For SG1)	Indicates the SG1 Local signal source is set to Ext (input from the rear LO Input connector)
		SG1 (For SG2)	Indicates the SG2 Local signal source is set to Sync and the signal is input from SG1
13		SG2 (For SG1)	Indicates the SG1 Local signal external output setting is On and the signal is output to SG2. If SG2 is not installed, "LO Out" (output from the rear LO Output connector) is displayed
		LO Out (For SG2)	Indicates the Local signal external output setting (output from the rear LO Output connector) is On
14		-	Click to switch Hardware Block Chart and ARB Info display

Frequency Channel Table

Sometimes frequencies need setting by Channel No. The built-in frequency channel table where frequencies are set by channel number is ideal for this application. Once set and saved, these pre-settings can be read whenever needed.

Channel Table Setting

- Group: 1 to 19
- Start Channel: 0 to 20000
- End Channel: (Start Channel) to 20000
- Start Frequency
- Channel Spacing



Channel Table Setting Screen

Connection with External Equipment

Remote Control Interfaces

The MG3710A has GPIB, Ethernet and USB interfaces as standard, supporting the following functions:

- Control all functions, except power switch
- Read all status conditions and settings
- Interrupts and serial polls

While in the Local status, the interface is determined automatically by the communication start command from the external controller (PC). To change the interface, put the MG3710A into the Local status again by pressing the Local key on the front panel and then send a command via the desired interface.

- **GPIB: Conforms to IEEE488.1/IEEE488.2 standards**
SH1, AH1, T6, L4, SR1, RL1, PP0, DC1, DT0, C0, E2
- **Ethernet: Conforms to VXI-11 protocol using TCP/IP**
Control programs
SH1, AH1, T6, L4, SR1, RL1, PP0, DC1, DT0, C0
- **USB: Conforms to USBTMC-USB488 protocols**
SH1, AH1, T6, L4, SR1, RL1, PP0, DC1, DT0, C0n

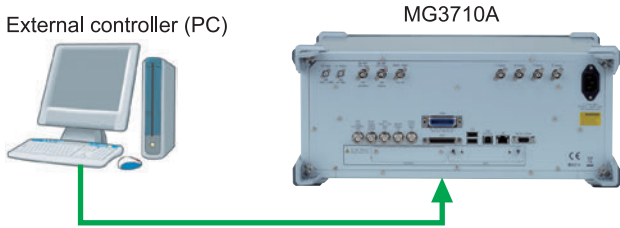

Connect to GPIB, Ethernet or USB port

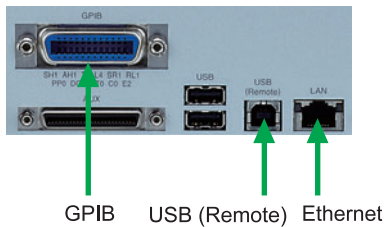

GPIB USB (Remote) Ethernet

To remotely control the MG3710A, either select the SCPI mode command format defined by the SCPI Consortium, or select backwards compatible modes supporting earlier MG3700A, MS269xA, and MS2830A commands

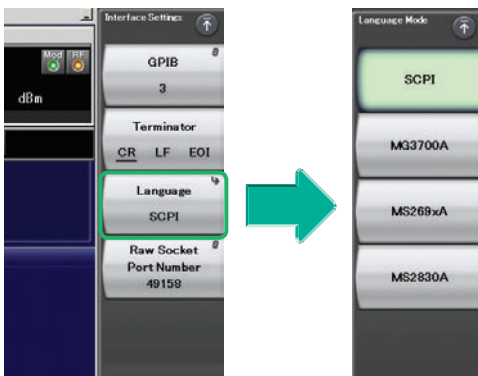

Command Format Setting Example

USB Connections

The two type-A USB2.0 connectors on the front and rear panels support keyboard, mouse and USB memory connections. Supported USB power sensors can be connected too.

- **USB Power Sensor [Sold separately]**
Frequency Range: 600 MHz to 4 GHz [MA24104A]*
350 MHz to 4 GHz [MA24105A]
50 MHz to 6 GHz [MA24106A]
10 MHz to 8 GHz [MA24108A]
10 MHz to 18 GHz [MA24118A]
10 MHz to 26 GHz [MA24126A]

*: MA24104A has been discontinued. Replacement model is MA24105A.

Analog IQ Input/Output [Opt. 018]

This option adds analog IQ input and output connectors to the front and rear panels, respectively. It only supports SG1 (1stRF).

Input: I Input, Q Input
Output: I Output, \bar{I} Output, Q Output, \bar{Q} Output,

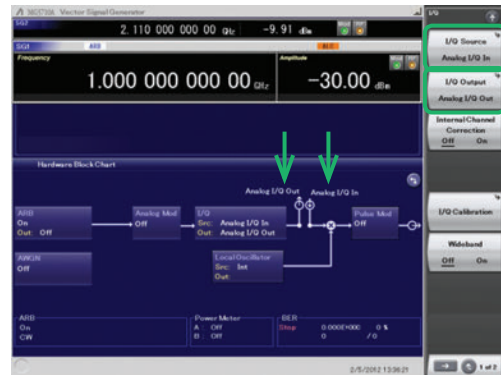

Analog IQ I/O Setting Screen

- **Analog IQ Input Adjustment**
Setting Range: -100 mV to +100 mV
- **Analog IQ Output Adjustment**
Output Voltage: 0.0 to 120.0%
In-phase DC offset: -2.5 V to +5.0 V
Differential DC offset: -50 mV to +50 mV

Trigger Input

Start and Frame triggers are installed as standard for outputting waveform patterns synchronized with externally input trigger signals.

• Start Trigger Operation

At Start Trigger operation, after the waveform pattern is selected, output is started and continued by the rise timing of the first external trigger signal. Second and subsequent input external trigger signals are disabled. This is used when receiving a Start Trigger signal and reference frequency signal from the DUT at the MG3710A.

• Frame Trigger Operation

At Frame Trigger operation, one frame of the waveform pattern is output at the rise timing of the external trigger signal. When frame output is finished, the trigger wait state is returned. This is used when receiving a Frame Trigger signal from the DUT at the MG3710A.

Frame Trigger supports three operations as follows:

(1) No Retrigger

Ignores triggers received during pattern output (default setting)

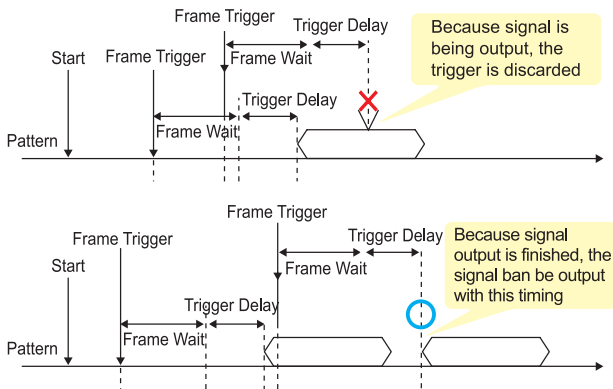

(2) Buffered Trig

Holds triggers received during pattern output until current pattern output completed and then outputs next frame

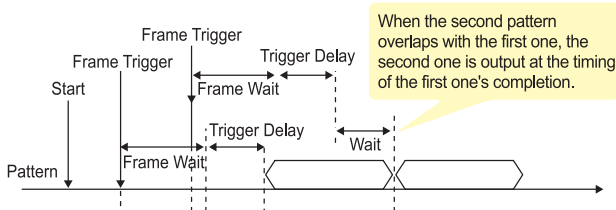

(3) Restart on Trig

Immediately restarts pattern when trigger received during pattern output

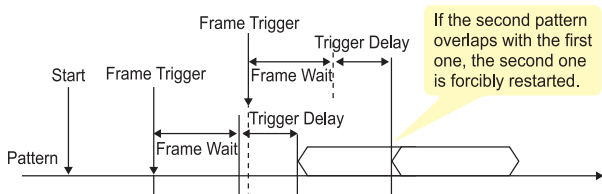

Marker Output Editing

Marker 1 Output [Standard]

Marker 2 & Marker 3 Output

[Requires J1539A AUX Conversion Adapter]

When the Marker Setup function Edit Mode is Off, a marker signal combining the preset waveform pattern with marker information is output. When the Edit Mode is On, any marker for output can be set at the MG3710A screen. Up to 12 markers can be set for SG1/SG2, memory A/B and Marker 1 to 3.

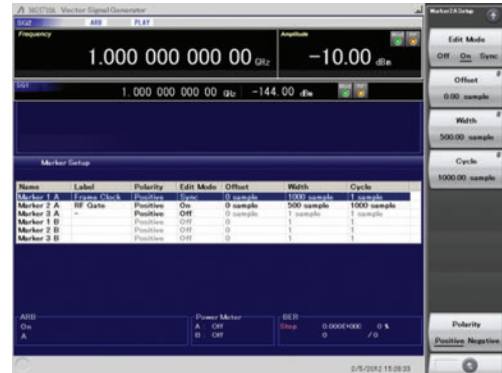

SG2 Marker Setup Screen

Memory A (1A/2A/3A), Memory B (1B/2B/3B)

There are three output connectors: Marker 1 Output on the rear panel and the AUX connector (Marker 2 Output and Marker 3 Output). The connector output signal layout can be selected freely.

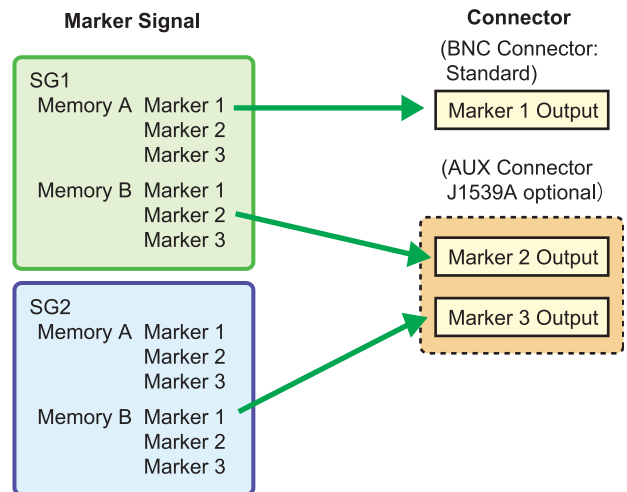

The defaults are as follows:

Marker Signal

SG1/Memory A/Marker 1
SG1/Memory A/Marker 2
SG1/Memory A/Marker 3

Connector

Marker 1 Output
Marker 2 (@AUX)
Marker 3 (@AUX)

IQproducer Waveform Generation Software

Waveform Generation Software (Separate license)

The IQproducer system provides an easy-to-use GUI for setting parameters according to each communications method. The parameter setting results file can be saved as a file for easy recall later.

* For detail, refer to the IQproducer catalog.

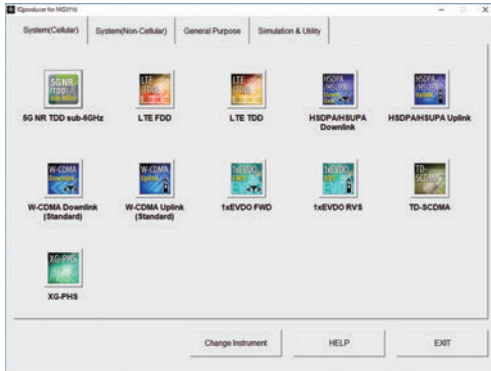

IQproducer Main Screen
System (Cellular)

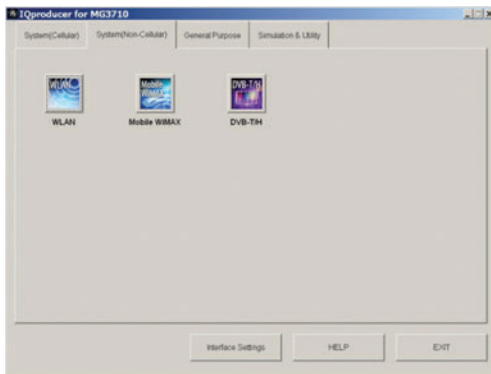

IQproducer Main Screen
System (Non-Cellular)

If a license is not installed in the MG3710A, characters are displayed in red. Without a license, the IQproducer functions can still be tested but a license must be installed to actually output created waveform patterns.

IQproducer Options

- MX370101A HSDPA/HSUPA IQproducer
- MX370102A TDMA IQproducer
- MX370103A CDMA2000 1xEV-DO IQproducer
- MX370104A Multi-carrier IQproducer
- MX370105A Mobile WiMAX IQproducer
- MX370106A DVB-T/H IQproducer
- MX370107A Fading IQproducer
- MX370108A LTE IQproducer
- MX370108A-001*1 LTE-Advanced FDD Option
- MX370110A LTE TDD IQproducer
- MX370110A-001*2 LTE-Advanced TDD Option
- MX370111A WLAN IQproducer
- MX370111A-002*3 802.11ac (160 MHz) Option
- MX370112A TD-SCDMA IQproducer
- MX370113A 5G NR TDD sub-6GHz IQproducer

*1: Requires MX370108A

*2: Requires MX370110A

*3: Requires MX370111A. Only for MG3710A

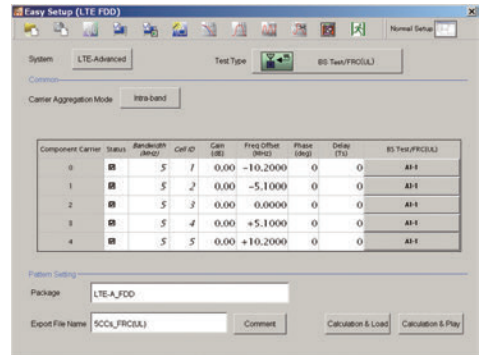

MX370108A LTE IQproducer/MX370108A-001 LTE-Advanced FDD Option
LTE-Advanced Easy Setup Screen

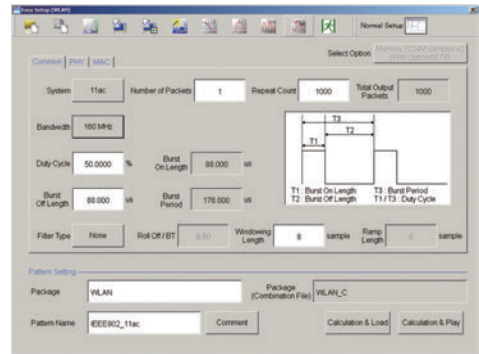

MX370111A WLAN IQproducer/MX370111A-002 802.11ac (160 MHz) Option
WLAN IEEE802.11ac Easy Setup Screen

The following table shows the [maximum size](#) for each waveform pattern generated using IQproducer. The maximum usable size (load) depends on the ARB memory expansion option installed in the main frame.

IQproducer Model/Name	MG3710A	MG3700A	MS269xA	MS2830A	MG3740A	
***01A HSDPA/HSUPA	512 Msamples	512 Msamples	256 Msamples	256 Msamples	—	
***02A TDMA					512 Msamples	
***03A CDMA2000 1xEV-DO					—	
***04A Multi-carrier	1024 Msamples		256 Msamples	256 Msamples	—	
***05A Mobile WiMAX	512 Msamples				—	
***06A DVB-T/H					—	
***07A Fading	1024 Msamples		—	—	—	
***08A LTE	512 Msamples		—	256 Msamples	256 Msamples	512 Msamples
***10A LTE TDD						—
***11A WLAN						—
***12A TD-SCDMA	—	—	—	—	—	
***13A 5G NR TDD sub-6GHz	—	—	—	—	—	

****: MX3701_ or MX2699_

IQproducer

IQproducer supports the following functions free-of-charge as secondary waveform pattern creation functions.

- Convert
- AWGN
- Clipping
- CCDF/FFT/Time Domain
- Transfer & Setting/Transfer & Setting Wizard Combination File Edit

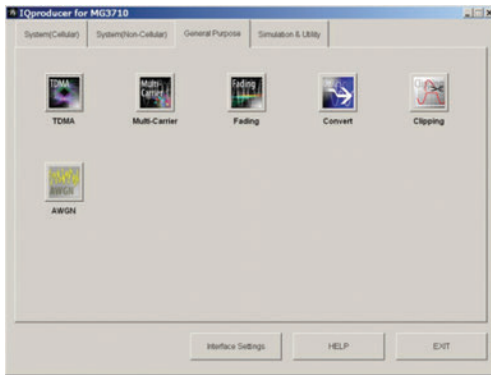

IQproducer Main Screen
General Purpose

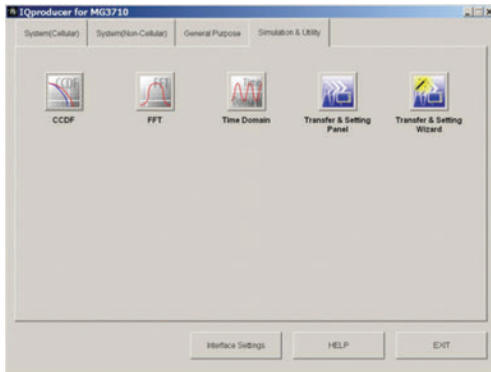

IQproducer Main Screen
Simulation & Utility

Operating Environment

PC	
OS	Windows 2000 Professional*1, Windows XP*2, Windows Vista*3, Windows 7 Enterprise (32-bit)*2, Windows 7 Professional (32-bit/64-bit)*2, Windows 10*4
CPU	Pentium III 1 GHz equivalent or faster
Memory	512 MB or more
Hard Disk	5 GB or more free space on the drive where this software is to be installed.
Peripheral Device	
Display	Displays with a resolution of 1024 × 768 pixels are best viewed using a small font setting

- *1: Does not support IQproducer Version 13.00 and later
- *2: Supports IQproducer Version 12.00 and later
- *3: Support IQproducer Version 12.00 to Version 16.01
- *4: Supports IQproducer Version 17.00 and later

Convert: Data Format Conversion

- (1) ASCII-format IQ data created with other software, such as simulation software, can be converted to waveform pattern files used by the MG3710A.

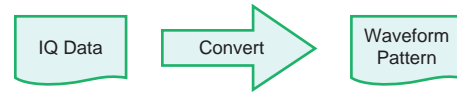

- (2) Data files captured with Anritsu MS269xA Signal Analyzers and the capture function of the MS2830A Signal Analyzer can be converted to waveform pattern files used by the MG3710A.

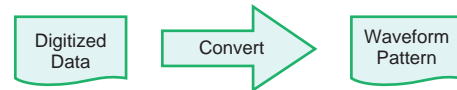

- (3) Waveform patterns created by other Anritsu vector signal generators (MG3700A, MS269xA-020, MS2830A-020/021) can be converted to waveform pattern files used by the MG3710A and vice versa.

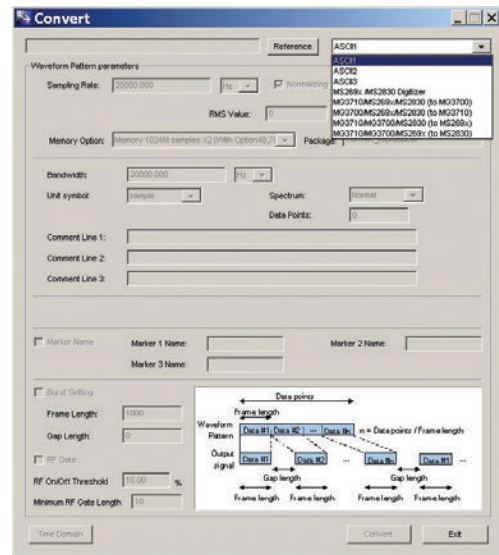
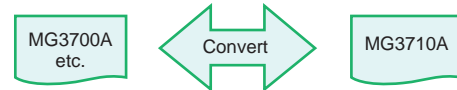

Convert Screen

Clipping

This function clips each type of waveform pattern. The clipped waveform pattern is created by setting the filter, bandwidth, and repetition times.

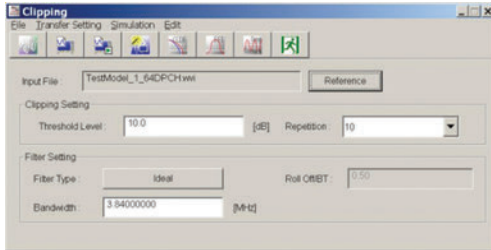

Clipping Screen

AWGN Waveform Generation

This function establishes the sampling rate and bandwidth, allowing any AWGN waveform pattern to be created. In addition, when the first combined waveform pattern (Wanted Signal) is selected, the Wanted Signal bandwidth and sampling rate are set automatically. The resulting AWGN waveform pattern can be combined with an existing waveform pattern, which is useful for base-station dynamic-range measurements.

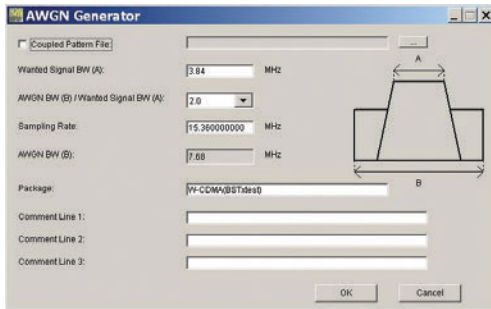

AWGN Screen

Main setting parameters

- (1) Wanted Signal Bandwidth:
Setting range: 0.0010 MHz to 120.0000 MHz
- (2) AWGN BW (B)/Wanted Signal BW (A):
Magnification of AWGN to Wanted Signal
Setting range: 1.0, 1.5, 2.0, 2.5
- (3) Sampling Rate:
Setting range: 0.0200 MHz to 160.0000 MHz
Note: Same value as wanted signal
- (4) AWGN Bandwidth (B):
Calculated automatically from (1) and (2) under following items:
Limit range:
0.001 MHz to 20.000 MHz: Sampling rate/2 max.
20.001 MHz to 120.000 MHz: Sampling rate max.

CCDF/FFT/Time Domain Graphical Displays

- **CCDF (Complementary Cumulative Distribution Function)**
Up to 8 created waveform patterns are read and displayed simultaneously as CCDF graphs.

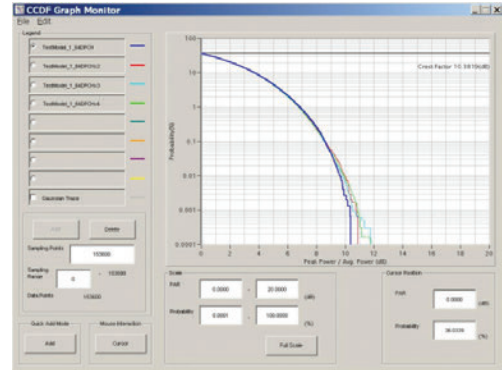

CCDF Screen

- **FFT (Fast Fourier Transform)**

Up to 4 created waveform patterns are read, FFT-processed and displayed simultaneously as FFT graphs.

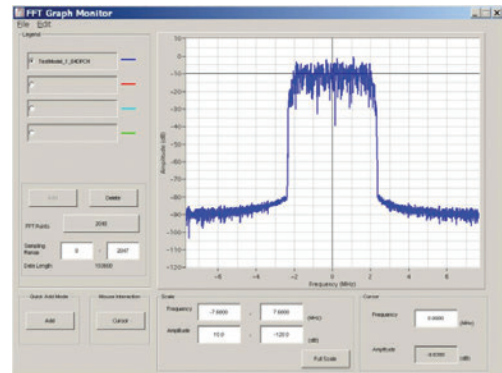

FFT Screen

- **Time Domain**

Up to 4 created waveform patterns are read, and displayed simultaneously as Time Domain graphs.

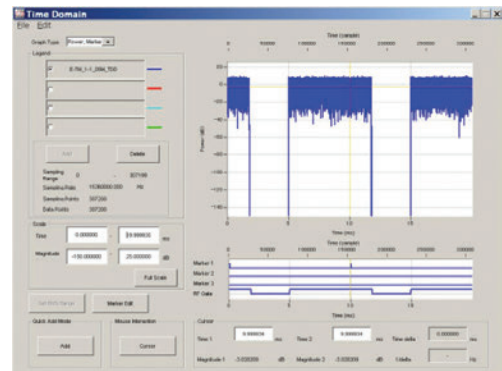

Time Domain Screen

Transfer and Settings: Data Transfer

Waveform pattern files, graphics files, firmware version upgrades, etc., can be moved between a LAN-connected PC and MG3710A. When several MG3710A units are connected via LAN, waveform patterns can be transferred by a single operation, helping cut work times. Moreover, waveform pattern files saved on the hard disk of a remote-controlled MG3710A can be opened in arbitrary waveform memory to select and output the waveform pattern.

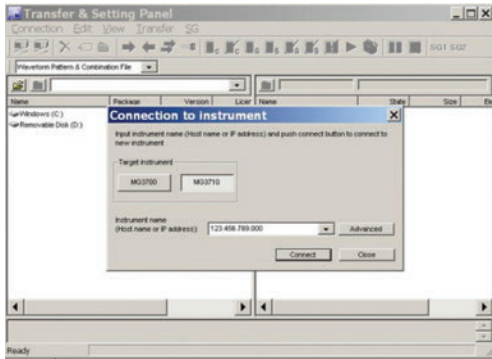

Transfer & Setting Screen

• Combination File Edit Function

The Combination File Edit function is a Transfer & Setting Edit function. The following parameters are set automatically by selecting the Combination File:

- Waveform pattern
- Repetition times
- Interference waveform pattern (memory B)
- Frequency offset used when memory A and B are added
- Level ratio (This value represents CN when memory A and B are added, or the relative level between elements when using only memory A.)

Using Combination Files that place the wanted and interference waveforms in separate memories makes it easy to measure receiver characteristics.

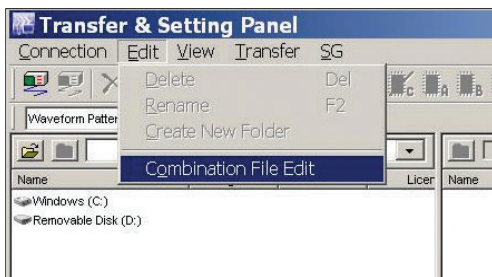

Transfer & Setting Screen
Combination File Edit Selection

Combination files can also be used to create waveform sequences. Receive signal status transitions can be verified by using Sequence Mode Combination files defining switching and repetition times for multiple waveform patterns.

Required waveform patterns and combination are saved to memory. Moreover, external triggers can be used to repeat each waveform pattern any number of times.

- ⇒ Efficient memory use
- ⇒ Validate response status transitions
- ⇒ Manual control of sequences

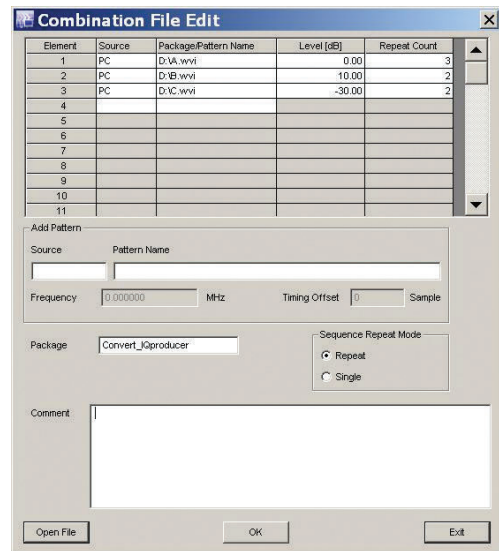

Combination File Edit Screen

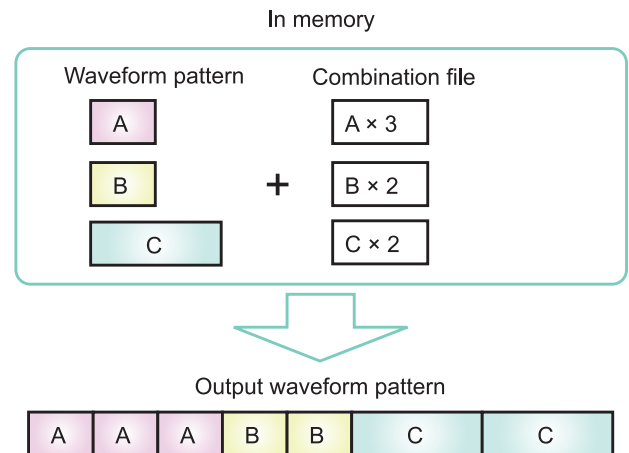

Options (Hardware)

Hardware (Common)

MG3710A-001 Rubidium Reference Oscillator

MG3710A-101 Rubidium Reference Oscillator Retrofit

Installs 10 MHz reference crystal oscillator with excellent frequency stability startup characteristics of $\pm 1 \times 10^{-9}$ at 7.5 minutes after power-on.

Aging Rate: $\pm 1 \times 10^{-10}$ /month

Temperature stability: $\pm 2 \times 10^{-9}$ (5° to 45°C)

Start-up characteristics*: $\pm 1 \times 10^{-9}$ (7.5 minutes after power-on)

*: at 23°C, compared to frequency after 24 h warm-up

MG3710A-002 High Stability Reference Oscillator

MG3710A-102 High Stability Reference Oscillator Retrofit

Installs 10 MHz reference oscillator with better frequency stability as follows:

Aging Rate: $\pm 1 \times 10^{-7}$ /year, $\pm 1 \times 10^{-8}$ /day

Temperature stability: $\pm 2 \times 10^{-8}$ (5° to 45°C)

Start-up characteristics*: $\pm 5 \times 10^{-7}$ (2 minutes after power-on)

$\pm 5 \times 10^{-8}$ (5 minutes after power-on)

*: at 23°C, compared to frequency after 24 h warm-up

MG3710A-011 2ndary HDD

MG3710A-111 2ndary HDD Retrofit

User installable/removable HDD

MG3710A-017 Universal Input/Output

MG3710A-117 Universal Input/Output Retrofit

Installs following signal I/O connectors on rear panel of main frame. Required for local frequency sync for MIMO applications

Baseband Reference Clock Input/Output

Sweep Output (only supports SG1)

Local Signal Input/Output

* Also provides J1539A AUX Conversion Adapter for Opt. 017/117 to use rear-panel AUX connector

MG3710A-021 BER Test Function

MG3710A-121 BER Test Function Retrofit

Installs BER measurement function

* Also provides J1539A AUX Conversion Adapter for Opt. 021/121 to use rear-panel AUX connector

MG3710A-181 CPU/Windows7 Upgrade Retrofit

This option is for MG3710A units ordered until May 2018. The OS in these MG3710A units is either Windows XP or Windows 7 (Professional) if the Opt. 029 (sales discontinued) is installed. This option upgrades the currently installed standard CPU and OS of these target units to a faster CPU and the Windows 7 (WES7) OS. The faster CPU shortens the time required to generate waveform patterns using IQproducer installed in the MG3710A.

* Due to license restrictions, this option cannot be installed in MG3710A units with the Opt. 313 Removable HDD (sales discontinued) installed.

Hardware (For 1stRF)

MG3710A-032 1stRF 100 kHz to 2.7 GHz

MG3710A-034 1stRF 100 kHz to 4 GHz

MG3710A-036 1stRF 100 kHz to 6 GHz

Selects 1stRF frequency range

The frequency range cannot be changed after installation.

MG3710A-018 Analog IQ Input/Output

MG3710A-118 Analog IQ Input/Output Retrofit

Installs analog I/Q input connector on front panel and output connector on rear panel of main unit

MG3710A-041 High Power Extension for 1stRF

MG3710A-141 High Power Extension for 1stRF Retrofit

Extends signal output setting range upper limit

Opt. 041/141 installed and Opt. 043/143 not installed

Level setting range: Hi limit +30 dBm (Standard +17 dBm)

Opt. 041/141 not installed and Opt. 043/143 not installed

Level setting range: Hi limit +25 dBm (Standard +17 dBm)

MG3710A-042 Low Power Extension for 1stRF

MG3710A-142 Low Power Extension for 1stRF Retrofit

Extends signal output setting range lower limit

Level setting range: Lo limit -144 dBm (Standard -110 dBm)

MG3710A-043 Reverse Power Protection for 1stRF

MG3710A-143 Reverse Power Protection for 1stRF Retrofit

Protects signal output connector against reverse input power (Standard: 2 W nom.)

Max reverse input: 20 W (nom.) (1 MHz < f ≤ 2 GHz)

10 W (nom.) (2 GHz < f ≤ 6 GHz)

MG3710A-045 ARB Memory Upgrade 256 Msample for 1stRF

MG3710A-145 ARB Memory Upgrade 256 Msample for 1stRF Retrofit

Upgrades ARB size to 256 Msamples (1 GB)

(standard is 64 Msamples/256 MB)

With Opt. 048/148 not installed, installs 1 × 256 Msamples

With Opt. 048/148 installed, installs 2 × 256 Msamples

MG3710A-046 ARB Memory Upgrade 1024 Msample for 1stRF

MG3710A-146 ARB Memory Upgrade 1024 Msample for 1stRF Retrofit

Upgrades ARB size to 1024 Msamples (4 GB)

(standard is 64 Msamples/256 MB)

With Opt. 048/148 not installed, installs 1 × 1024 Msamples

With Opt. 048/148 installed, installs 2 × 1024 Msamples

MG3710A-048 Combination of Baseband Signal for 1stRF

MG3710A-148 Combination of Baseband Signal for 1stRF Retrofit

Two internal waveform memories. Selects two waveform patterns per one RF output for setting mutual frequency offset, level offset, delay time, etc., to output 2 signals from 1 RF connector

MG3710A-049 AWGN for 1stRF

MG3710A-149 AWGN for 1stRF Retrofit

Internal AWGN addition function. Adjusts AWGN bandwidth range setting as follows for selected waveform pattern:

Band limit: waveform pattern sampling rate × 0.2

to waveform pattern sampling rate × 0.8

CN: ≤40 dB

MG3710A-050 Additional Analog Modulation Input for 1st RF

MG3710A-150 Additional Analog Modulation Input for 1st RF Retrofit

Adds additional analog modulation inputs function for 1stRF. Extends to two internal modulation sources (AM/FM/ΦM), and one external modulation source supporting simultaneous two-signal modulation. Installs external signal input connector on rear panel of main unit.

Hardware (For 2ndRF)

MG3710A-062 2ndRF 100 kHz to 2.7 GHz
MG3710A-064 2ndRF 100 kHz to 4 GHz
MG3710A-066 2ndRF 100 kHz to 6 GHz
MG3710A-162 2ndRF 100 kHz to 2.7 GHz Retrofit
MG3710A-164 2ndRF 100 kHz to 4 GHz Retrofit
MG3710A-166 2ndRF 100 kHz to 6 GHz Retrofit

Selects 2ndRF frequency range
The frequency range cannot be changed after installation.
Can only be retrofitted when 2ndRF not installed.

MG3710A-071 High Power Extension for 2ndRF
MG3710A-171 High Power Extension for 2ndRF Retrofit

Extends signal output setting range upper limit
Opt. 071/171 installed and Opt. 073/173 not installed
Level setting range: Hi limit +30 dBm (Standard +17 dBm)
Opt. 071/171 not installed and Opt. 073/173 not installed
Level setting range: Hi limit +25 dBm (Standard +17 dBm)

MG3710A-072 Low Power Extension for 2ndRF
MG3710A-172 Low Power Extension for 2ndRF Retrofit

Extends signal output setting range lower limit
Level setting range: Lo limit -144 dBm (Standard -110 dBm)

MG3710A-073 Reverse Power Protection for 2ndRF
MG3710A-173 Reverse Power Protection for 2ndRF Retrofit

Protects signal output connector against reverse input power
(Standard: 2 W nom.)
Max reverse input: 20 W (nom.) (1 MHz < f ≤ 2 GHz),
10 W (nom.) (2 GHz < f ≤ 6 GHz)

MG3710A-075 ARB Memory Upgrade 256 Msample for 2ndRF
MG3710A-175 ARB Memory Upgrade 256 Msample for 2ndRF Retrofit

Upgrades ARB size to 256 Msamples (1 GB)
(standard is 64 Msamples/256 MB)
With Opt. 078/178 not installed, installs 1 × 256 Msamples
With Opt. 078/178 installed, installs 2 × 256 Msamples

MG3710A-076 ARB Memory Upgrade 1024 Msample for 2ndRF
MG3710A-176 ARB Memory Upgrade 1024 Msample for 2ndRF Retrofit

Upgrades ARB size to 1024 Msamples (4 GB)
(standard is 64 Msamples/256 MB)
With Opt. 078/178 not installed, installs 1 × 1024 Msamples
With Opt. 078/178 installed, installs 2 × 1024 Msamples

MG3710A-078 Combination of Baseband Signal for 2ndRF
MG3710A-178 Combination of Baseband Signal for 2ndRF Retrofit

Two internal waveform memories. Selects two waveform patterns per one RF output for setting mutual frequency offset, level offset, delay time, etc., to output 2 signals from 1 RF connector

MG3710A-079 AWGN for 2ndRF
MG3710A-179 AWGN for 2ndRF Retrofit

Internal AWGN addition function. Adjusts AWGN bandwidth range setting as follows for selected waveform pattern:
Band limit: waveform pattern sampling rate × 0.2
to waveform pattern sampling rate × 0.8
CN: ≤40 dB

MG3710A-080 Additional Analog Modulation Input for 2nd RF
MG3710A-180 Additional Analog Modulation Input for 2nd RF Retrofit

Adds additional analog modulation inputs function for 2ndRF. Extends to two internal modulation sources (AM/FM/ΦM), and one external modulation source supporting simultaneous two-signal modulation.
Installs external signal input connector on rear panel of main unit.

Options (Software)

Waveform Patterns & License

Model: MX370073A (to be discontinued in May 2019)
MX370073B

Name: DFS Radar Pattern

Sets pulse signals for testing 5-GHz band WLAN DFS functions. The MX370073B supports the waveform patterns for the FCC and Japan MIC (TELEC) test specifications. Pulse signals are output simply by selecting the pattern.

Model: MX370075A

Name: DFS (ETSI) Waveform Pattern

Sets pulse signals for testing 5-GHz band WLAN DFS functions. The MX370075A supports the waveform patterns for the ETSI specifications. Pulse signals are output simply by selecting the pattern.

What is DFS?

5-GHz band wireless LAN devices like meteorological radar, marine radar, etc., have a Dynamic Frequency Selection (DFS) function for switching to an empty channel when detecting a radio wave. At testing, pulse, chirping and hopping signals like those used by radar are output from the SG to the WLAN equipment to check that it does not output signals in that channel.

Model: MX370084A

Name: ISDB-Tmm Waveform Pattern

Archive of ARIB STD-B46 waveform patterns. Supports MER and spectrum evaluation of Tx characteristics tests and sensitivity/simple BER tests at Rx characteristics tests.

IQproducer License

IQproducer is PC application software for generating waveform patterns. The parameters are set using IQproducer and the waveform pattern is created to output the signal by selection at the MG3710A. This one software application includes all the following systems.

Since it runs on any PC, the supported functions and parameter range can be verified before purchase.

When outputting a waveform pattern from the MG3710A, no signal is output unless a license for that system is installed in the main frame.

* Read the "IQproducer catalog" for details.

Model: MX370101A

Name: HSDPA/HSUPA IQproducer

Sets parameters according to HSDPA/HSUPA (Uplink and Downlink) specifications, and generates HSDPA/HSUPA waveform patterns including Fixed Reference Channel (3GPP TS 25.101 Annex A.7).

Model: MX370102A

Name: TDMA IQproducer

Sets required parameters for TDMA waveform patterns and generates various waveform patterns. Setting parameters include Modulation, Frame, Slot, Data, Filter, etc. Supports wide application range including public wireless.

Model: MX370103A

Name: CDMA2000 1xEV-DO IQproducer

Sets parameters according to CDMA2000 1xEV-DO Forward/Reverse specifications and generates 1xEV-DO waveform patterns.

Model: MX370104A

Name: Multi-carrier IQproducer

Generates multi-carrier waveform patterns combination files using MG3710A Baseband Signal Combine function (requires Opt. 048/078).

Model: MX370105A

Name: Mobile WiMAX IQproducer

Sets parameters according to IEEE 802.16e-2005, IEEE P802.16Rev2/D3 WirelessMAN-OFDMA MAC, PHY specifications and generates waveform patterns. Supports WirelessMAN-OFDMA specification used by 802.16e mobile standard.

Model: MX370106A

Name: DVB-T/H IQproducer

Sets parameters according to ETSI EN 300 744 V1.5.1 (2004-11) physical layer standard and generates DVB-T/H waveform patterns. Generated waveform patterns can be used for device TRx characteristics evaluation tests (Error Correction, BER graphics).

Model: MX370107A**Name: Fading IQproducer**

Performs IQ channel fading processing, correlation matrix calculation, AWGN combination. Input data file created by selecting waveform pattern file created with other IQproducer software, and IQ data (ASCII) created with other general-purpose simulation tools.

Model: MX370108A**Name: LTE IQproducer**

Generates wanted waveform patterns with parameters modified according to 3GPP TS 36.211, TS 36.212, TS 36.213 LTE FDD specifications.

Model: MX370108A-001**Name: LTE-Advanced FDD Option**

Installing in the MX370108A supports simple generation of carrier aggregation signals added by 3GPP Rel. 10. Additionally, clustered SC-FDMA signals can be generated at Uplink.

*: Requires MX370108A

Model: MX370110A**Name: LTE TDD IQproducer**

Generates wanted waveform patterns with parameters modified according to 3GPP TS 36.211, TS 36.212, TS 36.213 LTE TDD specifications.

Model: MX370110A-001**Name: LTE-Advanced TDD Option**

Installing in the MX370110A supports simple generation of carrier aggregation signals added by 3GPP Rel. 10. Additionally, clustered SC-FDMA signals can be generated at Uplink.

*: Requires MX370110A

Model: MX370111A**Name: WLAN IQproducer**

Generates waveform patterns for IEEE Std 802.11-2007 and IEEE Std 802.11n-2009 IEEE 802.11a/b/g/j/n/p specifications.

Model: MX370111A-002**Name: 802.11ac (160 MHz) Option**

Installing in the MX370111A supports waveform patterns generation compliant with IEEE802.11ac specifications.

*: Requires MX370111A. Only for MG3710A.

Model: MX370112A**Name: TD-SCDMA IQproducer**

Generates wanted waveform patterns with parameters modified according to TD-SCDMA specifications standardized by TRx characteristics evaluation tests (excluding performance tests) for 3GPP TS 25.221, TS 25.222, TS 25.223, TS 25.105, TS 25.142

Model: MX370113A**Name: 5G NR TDD sub-6GHz IQproducer**

Generates 3GPP TS 38.211, TS 38.212, and TS 38.213 defined waveform patterns in compliance with the 5G NR FR1 (sub-6 GHz) specifications.

• Vector Signal Generator series**Supported LTE-Advanced Carrier Aggregation Modes**

Carrier Aggregation Mode	Vector Signal Generator Series		Vector Signal Generator Option for Signal Analyzer	
	MG3710A*1	MG3700A*1	MS2690A series Opt. 020*2	MS2830A Opt. 020/021*2
Intra-band contiguous Carrier Aggregation, Intra-band non-contiguous Carrier Aggregation	✓ (1 unit)	✓ (1 unit)	✓ (1 unit)	✓ (1 unit)
Inter-band non-contiguous Carrier Aggregation	✓ (2 RF 1 unit*3, or 1 RF 2 units)	✓ (2 units)	✓ (2 units)	✓ (2 units)

*1: MX370108A LTE IQproducer and MX370108A-001 LTE-Advanced FDD Option installed.

MX370110A LTE TDD IQproducer and MX370110A-001 LTE-Advanced TDD Option installed.

*2: MX269908A LTE IQproducer and MX269908A-001 LTE-Advanced FDD Option installed.

MX269910A LTE TDD IQproducer and MX269910A-001 LTE-Advanced TDD Option installed.

*3: MG3710A-062 (2.7 GHz)/064 (4 GHz)/066 (6 GHz) 2ndRF Option installed.

• Vector Signal Generator series**Supported WLAN IEEE802.11ac Signal Bandwidth**

IEEE802.11ac Signal Bandwidth	Vector Signal Generator Series		Vector Signal Generator Option for Signal Analyzer	
	MG3710A*1	MG3700A*2	MS2690A series Opt. 020*3	MS2830A Opt. 020/021*3
20 MHz/40 MHz/80 MHz	✓ (1 unit)	✓ (1 unit)	✓ (1 unit)	✓ (1 unit)
160 MHz	✓ (1 unit)	—	—	—
80 MHz + 80 MHz (non-contiguous)	✓ (2 RF 1 unit*4, or 1 RF 2 units)	✓ (2 units)	✓ (2 units)	✓ (2 units)

*1: MX370111A WLAN IQproducer and MX370111A-002 802.11ac (160 MHz) Option installed.

*2: MX370111A WLAN IQproducer and MX370111A-001 802.11ac (80 MHz) Option installed.

*3: MX269911A WLAN IQproducer and MX269911A-001 802.11ac (80 MHz) Option installed.

*4: MG3710A-062 (2.7 GHz)/064 (4 GHz)/066 (6 GHz) 2ndRF Option installed.

Reference Signal Source for Tx Characteristics Tests of Amplifiers, etc.

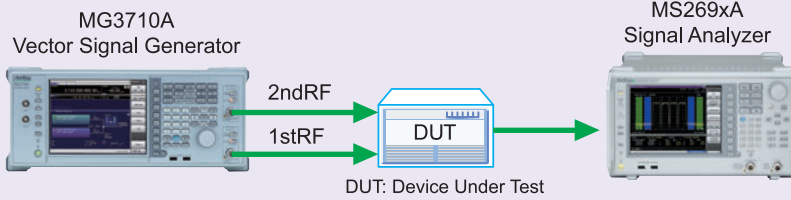

Tx Characteristics Tests

Adjacent Channel Leakage Power (ACLR)
Modulation Accuracy (EVM)
IM3, IP3, etc.

Large Measurement Margin



Stable Measurements
Improves Yield

No External Amp



Stable Level Accuracy
Cuts Risk of Damage to DUT

- **Supports -71 dBc* ACLR Performance**
High ACLR performance increases specification margin and improves stable measurement and yield.
*: W-CDMA, TestModel1, 64DPCH, 2 GHz

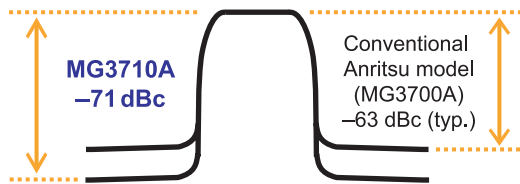

Dual RF Outputs



Cuts Costs
Cuts Workload

Pre-installed Waveform Patterns



Cuts Costs

- **Supports Maximum Two RF Outputs**
In general, two signal generators are required to output CW x 2 waveforms with IM3 or modulation signals with different communication methods. Not only is the cost for two signal generators high, but two separate software licenses are required to output modulation signals. In addition, setting two separate signal generators doubles the workload.
The MG3710A supports two signal generators (RF output) in one unit cutting equipment costs. And only one license is required to use modulation signals at two RF outputs.
Moreover, the frequency and level synchronization function cuts work loads.

- **High-power Output Option (Opt. 041/071) Supports CW Levels of +23 dBm**
In general, an external amp is required when the output of a signal generator is insufficient, such as covering the measurement system transmission path loss and inputting high-level modulation signals for amp distortion characteristics tests. Since the output of an external amp cannot be assured, it must be checked with a power meter each time the frequency and level are changed. Moreover, when using an external amp, sometimes the DUT may be damaged by mishandling errors. The MG3710A high-power output supports signals required for measuring path loss. In addition, stable measurement is assured when used within the guaranteed setting range. And the risk of mistakenly damaging the DUT is reduced, even at the output limit.

- **License-free Pre-installed Waveform Patterns**
LTE FDD/TDD (E-TM1.1 to E-TM3.3), W-CDMA/HSPA, GSM, CDMA2000/1xEV-DO, WLAN 11a/b/g, Mobile WiMAX, etc.
- Optional waveform generation tools are also available (license sold separately):
- | | |
|-------------------------------|--------------------|
| LTE FDD | (MX370108A) |
| LTE-Advanced FDD | (MX370108A-001) |
| LTE TDD | (MX370110A) |
| LTE-Advanced TDD | (MX370110A-001) |
| Mobile WiMAX | (MX370105A) |
| WLAN 11a/b/g/n/j/p | (MX370111A) |
| WLAN 11ac | (MX370111A-002) |
| TD-SCDMA | (MX370112A) |
| 5G NR TDD sub-6GHz IQproducer | (MX370113A) (etc.) |

USB Power Sensor



Efficient Equipment Investment

Up to two USB power sensors (separately sold) can be connected to the MG3710A.
USB connectors to display the measurement results on the MG3710A screen.

- **USB Power Sensor**
Frequency Range: 600 MHz to 4 GHz [MA24104A]*
350 MHz to 4 GHz [MA24105A]
50 MHz to 6 GHz [MA24106A]
10 MHz to 8 GHz [MA24108A]
10 MHz to 18 GHz [MA24118A]
10 MHz to 26 GHz [MA24126A]

*: MA24104A has been discontinued. Replacement model is MA24105A.

Wanted and Interference Waveforms for Rx Characteristics Evaluations of Cellular Base Station, etc.

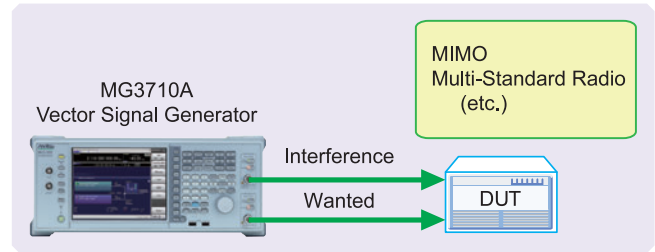
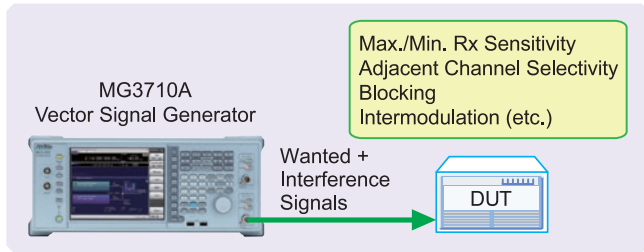

Two modulation signals can be output from one RF output using the baseband signal combine function (Opt. 048/078). The level ratio (CN = 80 dB) and the frequency offset (± 80 MHz max.) can be set as well.

Tests using two modulation signals, such as Adjacent Channel Selectivity (ACS), Blocking, and Intermodulation (IM), etc., require two separate signal generators and a license for each, greatly increasing equipment costs and setting work loads.

The MG3710A has two waveform memories for each RF output for setting and outputting different waveform data. One RF outputs the combined wanted + interference signals for a baseband bandwidth. Not only are equipment costs greatly reduced, but fewer external equipment, such as couplers, level adjusters, etc., as well as less setup time are required. In comparison to previous Anritsu instruments, frequency offsets can be set for both memory A and B, and the sampling rate for memory A and B can be adjusted automatically.

Two RF outputs can be installed as an option.

A different frequency, level and waveform pattern/CW can be set for each RF output, which is ideal for Rx tests using two signals for frequency offset that cannot be set using the baseband combine function. For example, sometimes at MSR, multiple signals must be output simultaneously in the 200-MHz band, requiring two RF outputs.

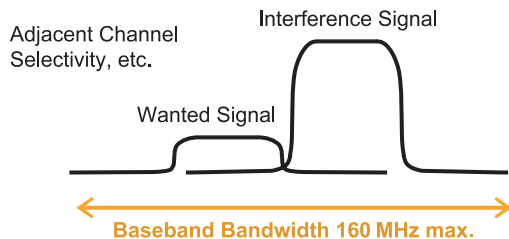

Installing the BER measurement (Opt. 021) and AWGN Generation (Opt. 049/079) options supports the extra functions required for Rx tests of each type of communications system.

Multi-Standard Radio Rx Characteristics Tests

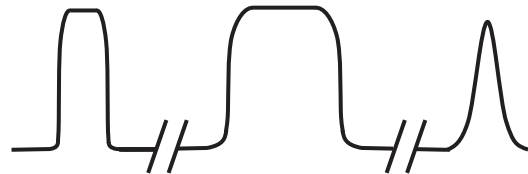

Installing two RF units in one MG3710A unit makes it easy to synchronize between channels. And adding the Universal Input/Output option (Opt. 017) supports Local Signal I/O for synchronizing with other MG3710A units.

The IQproducer waveform generation software can be used with one license when two RF units are installed. For example, for LTE 2x2 MIMO tests, LTE IQproducer can generate two patterns for the Tx antenna signals and Fading IQproducer can generate two patterns with spatial multiplexing for the Rx antennas.

Previously, using two signal generators required two separate licenses for LTE and fading, but now only one license is required to use IQproducer with the MG3710A with two RF units installed, helping cut software costs too.

Rx Sensitivity Tests for Multi-system Mobile Terminals, etc.

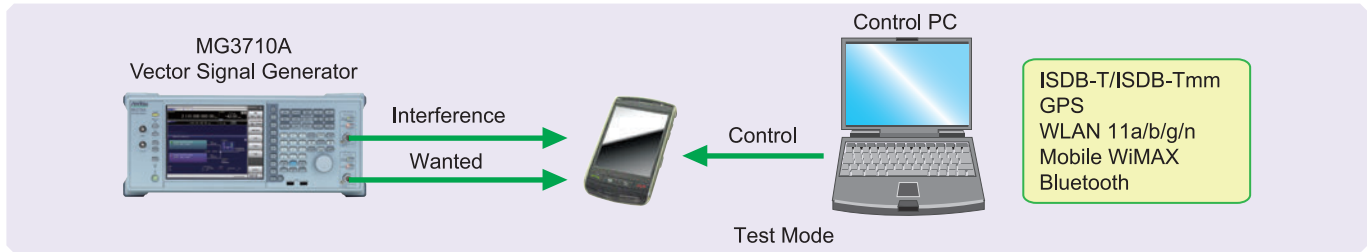

Large 4-GB Memory Max.



Reduces Reload Times

Cuts Test Times

Dual RF outputs



Cuts Costs

The MG3710A can save up to 1024 Msamples (4 GB) per RF. Memory size is one of the most important specifications for an arbitrary waveform signal generator. Small memory cannot save multiple waveform data and requires time-wasting reloading and measurement to output different signals each time.

With large waveform memory

- Switch loaded waveform data instantaneously
 - Load multiple test waveforms
- ⇒ Reduce number of reloads ⇒ Cuts times

Two RF outputs can be installed as an option.

Additionally, two RF output models with different frequencies can be installed. For example, if WLAN 11b/g are the wanted waveforms, mobile signals for LTE FDD, LTE TDD, W-CDMA, GSM, etc., are considered interference signals. Generally, these tests have high hardware and software costs because two separate signal generators are required. Using the MG3710A, the total investment costs for interference tests under simulated service conditions, such as WLAN + LTE FDD, or ISDB-T + W-CDMA, are reduced by selecting models with different frequencies for the 1stRF and 2ndRF outputs.

Pre-installed Waveform Patterns



Cuts Costs

License-free Pre-installed Waveform Patterns

WLAN 11a/b/g, Bluetooth, GPS, etc.

The following waveform patterns are available as options.

ISDB-Tmm (MX370084A)

Optional waveform generation tools are also available (license separately sold):

DVB-T/H	(MX370106A)
Mobile WiMAX	(MX370105A)
WLAN 11a/b/g/n/j/p	(MX370111A)
WLAN 11ac	(MX370111A-002)

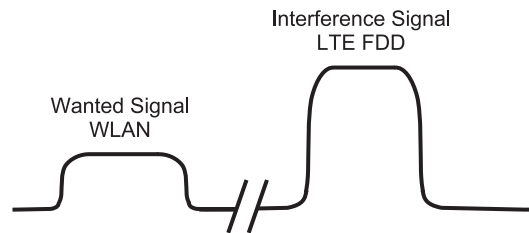

Rx Characteristics Evaluation Tests for Digital Narrowband Communications, Public Safety, etc.

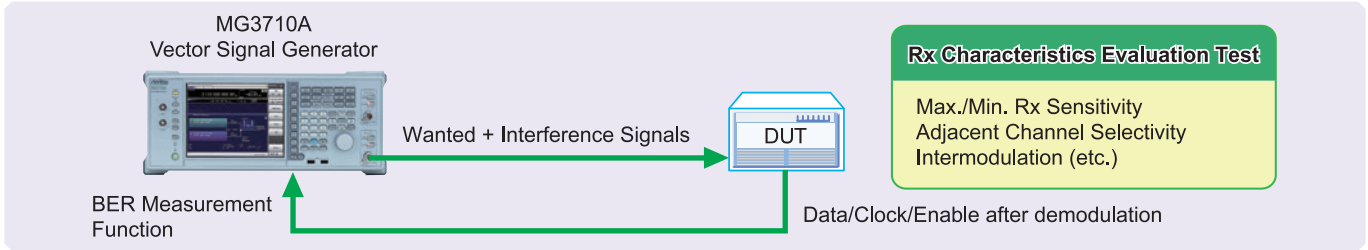

• Supports SSB Phase Noise Performance -140 dBc/Hz nom. (@100 MHz)

Phase noise performance affects measurement results at narrow bandwidths of several kHz. In particular, high phase-noise performance is required for interference waveforms. Improved SSB phase noise supports wider specification margins and stable measurements to improve yields.

- -140 dBc/Hz (nom.) @100 MHz, 20-kHz offset, CW
- -131 dBc/Hz (typ.) @1 GHz, 20-kHz offset, CW
- -125 dBc/Hz (typ.) @2 GHz, 20-kHz offset, CW



• TDMA IQproducer [MX370102A] Supports Following Modulation Methods

- BPSK, DBPSK, PI/2DBPSK, QPSK, DQPSK, PI/4DQPSK, 8PSK, D8PSK, 16QAM, 32QAM, 256QAM, ASK, 2FSK, 4FSK,

The TDMA IQproducer PC software generates waveform patterns with any frame format or filter settings. One software package supports various narrowband digital communications.

Two modulation signals can be output from one RF output using the baseband signal combine function (Opt. 048/078). The level ratio (CN = 80 dB) and the frequency offset (± 80 MHz max.) can be set as well. Usually, tests using two modulation signals, such as adjacent channel selectivity (ACS) and intermodulation characteristics (IM) require two signal generators as well as a software license for each signal generator. The MG3710A has two waveform memories for each RF output for setting and outputting different waveform data. One RF outputs the combined wanted + interference signals for a baseband bandwidth. Not only are equipment costs greatly reduced, but fewer external equipment, such as couplers, level adjusters, etc., as well as less setup time are required.

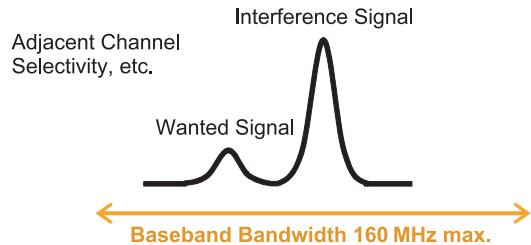

• Supports BER Measurement Function [Opt. 021]

The BER can be measured using the DUT-demodulated Data/Clock/Enable. The measurement results are displayed on the MG3710A screen.

- Input Bit Rate: 100 bps to 40 Mbps

Easy-to-use Panel

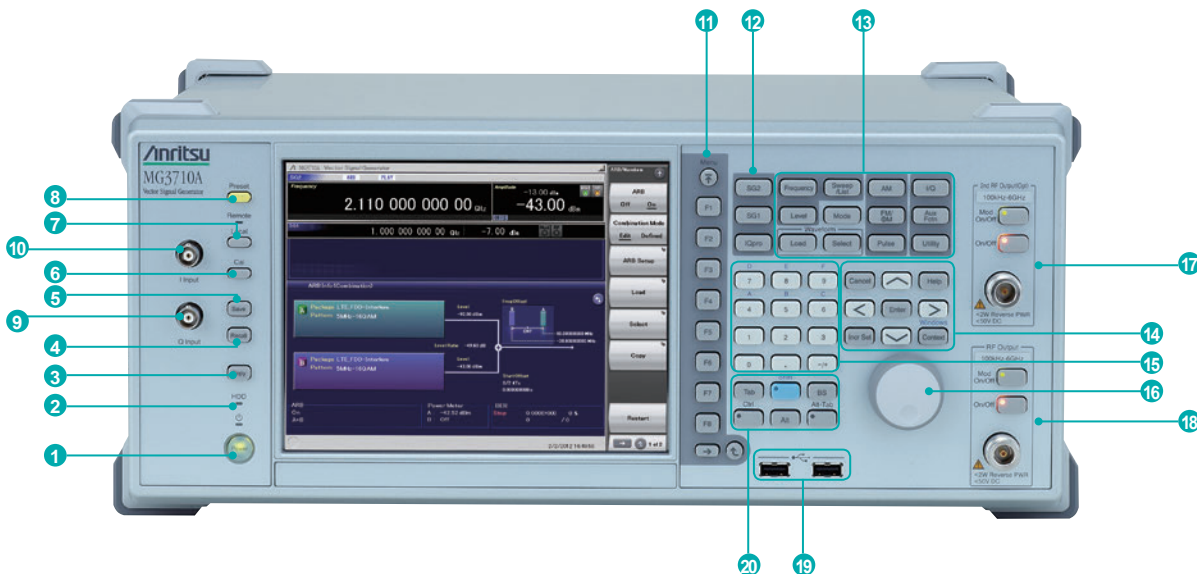

1 Power Switch

Switches between standby status in which AC power is supplied, and operating power-on status. At standby the key lamp is orange; at power-on it is green. To supply power press the switch for 2 seconds or more.

2 HDD Lamp

Lit when internal hard disk being accessed.

3 Copy Key

Copies screen display to file.

4 Recall Key

Displays menu for recalling parameter files.

5 Save Key

Displays menu for saving parameter files.

6 Cal Key

Displays menu for performing calibration.

7 Local Key/Remote Lamp

Local Key: Return remote control via GPIB, Ethernet, USB (B) to local control and enables panel setting.

Remote Lamp: Lit while MG3710A under remote control.

8 Preset Key

Displays Preset menu to initialize parameter settings.

9 Q Input Connector

Input for external Q phase signal. Requires Opt. 018 and only supports SG1 (1stRF); does not support SG2 (2ndRF).

10 I Input Connector

Input for external I phase signal. Requires Opt. 018 and only supports SG1 (1stRF); does not support SG2 (2ndRF).

11 Function Keys

Select and execute functions displayed at right edge of display. Displayed functions menus are multi-level with page hierarchy.

12 SG1/SG2/IQpro Keys

SG1: Switches setting target to SG1

SG2: Switches setting target to SG2

IQpro: Starts IQproducer on main frame. IQproducer may not start running for a few seconds to minutes after pressing this key.

13 Main Function Keys

Displays menus for setting and executing main functions: [Frequency], [Level], [Sweep/List], [Mode], [AM], [FM/ΦM], [Pulse], [I/Q], [Load], [Select], [AUX Fctn], [Utility]

14 Arrow/Enter/Cancel/Help/Incr Set/Context/Windows Keys

Help: Pressing function key after Help key displays help for pressed function key

Incr Set: Sets increment/decrement steps for each parameter

Context: Performs same operation and right mouse click

Windows: Performs same operation as Windows key

15 Ten Key Pad

Input numeric values for each parameter setting screen.

16 Rotary Knob

Selects and sets displayed items.

17 2nd RF Output [Opt. 062/064/066]

Mod On/Off: Switched 1stRF/2ndRF modulation On/Off. Lamp lit during modulation.

On/Off: Switches RF output On/Off.

18 RF Output [Opt. 032/034/036]

19 USB Connector (Type A)

20 Tab/Alt/BS/Ctrl/Shift/Alt-Tab Key

Shift key: Executes panel operation indicated by blue characters. Press Shift key and then required key.

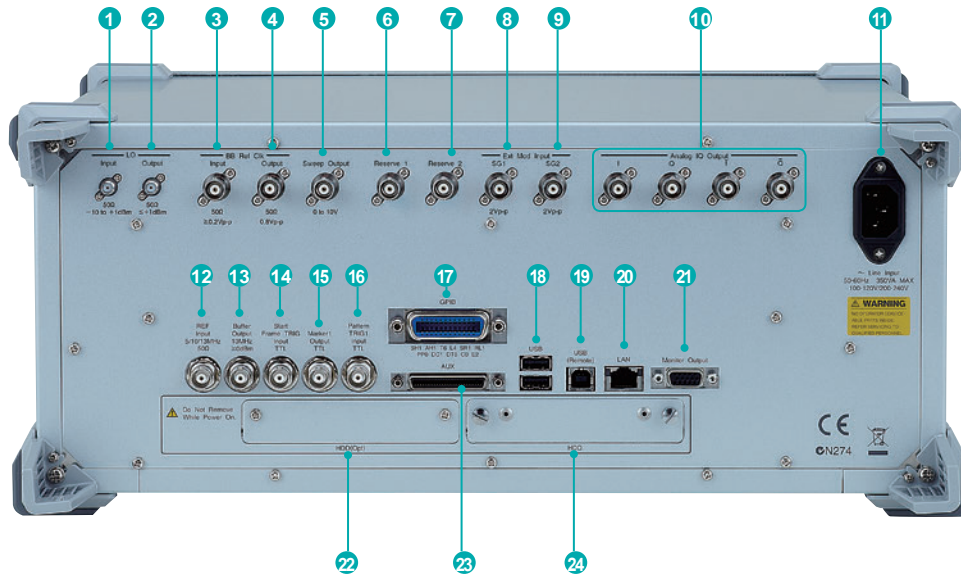

1 LO Input

Connector for inputting external Local signal.
Requires Opt. 017.

2 LO Output

Outputs Local signal. Requires Opt. 017.

3 BB REF CLK Input

Connector for inputting reference clock signal for sampling clock of built-in arbitrary waveform generator.
Requires Opt. 017.

4 BB REF CLK Output

Connector for outputting arbitrary waveform generator sampling clock signal. Requires Opt. 017.

5 Sweep Output

Connector for outputting either 10 V Sweep Signal synchronized with Sweep or Sweep Status signal.
Requires Opt. 017.

6 Reserve 1

Terminal for future extension.

7 Reserve 2

Terminal for future extension.

8 Ext Mod Input SG1

Option connector for inputting external signal for additional analog modulation input for the SG1.
Requires Opt. 050.

9 Ext Mod Input SG2

Option connector for inputting external signal for additional analog modulation input for the SG2.
Requires Opt. 080.

10 I Output/Q Output/I-bar Output/Q-bar Output

Connector for outputting internal baseband I/Q signal or inverse I/Q signal. Requires Opt. 018.

11 AC Inlet

12 REF Input

Connector for inputting external reference frequency signal (5/10/13 MHz).

13 Buffer Output

Connector for outputting built-in reference frequency signal (10 MHz).

14 Start Frame TRIG Input

Connector (pulled up internally) for inputting external trigger signal.

15 Marker 1 Output

Connector for outputting Marker 1 signal. (Marker 2/3 output from AUX connector).
Requires J1539A AUX Conversion Adapter.

16 Pattern TRIG 1 Input

Connector (pulled up internally) for inputting external trigger signal.

17 GPIB

Connector Connector used for remote control via GPIB.

18 USB Connector (Type A)

Connector for USB memory, keyboard, mouse, etc.

19 USB Connector (Type B)

Connector used for remote control via USB.

20 LAN

Connector for personal computer and network.

21 Monitor Output

RGB connector for external display.

22 HDD (Opt)

Slot for hard disk option. Requires Opt. 011.

23 AUX

Connector for following I/O signals.
Requires J1539A AUX Conversion Adapter.

- BER Measurement Signal (Input): Data, CLK, Enable
- Marker Signal (Output): Marker 2, Marker 3
- Pulse Signal for external Pulse Modulation (Input): Pulse Mod
- Signal synchronized with Pulse Modulation signal at PM (Output): Pulse Sync, Pulse Video Out
- Trigger signal at timing of internal Baseband Ref Clock based on Start/Frame trigger (Out): Sync Trigger Out

24 HDD

Hard disk slot

Specifications

Refer to the Data Sheet for specification details such as guaranteed setting ranges, etc.

● Frequency Setting Range

- 1stRF
 - MG3710A-032 9 kHz to 2.7 GHz
 - MG3710A-034 9 kHz to 4 GHz
 - MG3710A-036 9 kHz to 6 GHz

● 2ndRF

- MG3710A-062 9 kHz to 2.7 GHz
- MG3710A-064 9 kHz to 4 GHz
- MG3710A-066 9 kHz to 6 GHz

● Switching Speed (List Mode)

- Frequency ≤600 μs
- Level ≤600 μs

● Amplitude Setting Range

Options	Setting Range [dBm]	
	without Reverse Power Protection	with Reverse Power Protection
Standard	-110 to +17	-110 to +17
with High-power Extension	-110 to +30	-110 to +25
with Low-power Extension	-144 to +17	-144 to +17
with High-power Extension and Low-power Extension	-144 to +30	-144 to +25

Level Accuracy is assured at high levels (CW)

Frequency Range	Standard	Opt. 041/071
100 kHz ≤ f < 10 MHz	+5 dBm	+5 dBm
10 MHz ≤ f < 50 MHz	+10 dBm	+10 dBm
50 MHz ≤ f < 400 MHz	+13 dBm	+20 dBm
400 MHz ≤ f ≤ 3 GHz		+23 dBm
3 GHz < f ≤ 4 GHz		+20 dBm
4 GHz < f ≤ 5 GHz		+13 dBm
5 GHz < f ≤ 6 GHz	+11 dBm	+11 dBm

● Absolute Level Accuracy

(at CW, 18° to 28°C, -110 to +5 dBm)

- ±0.5 dB (typ.) (100 kHz ≤ f < 50 MHz)
- ±0.5 dB (50 MHz ≤ f ≤ 3 GHz)
- ±0.7 dB (3 GHz < f ≤ 4 GHz)
- ±0.8 dB (4 GHz < f ≤ 6 GHz)

● Harmonics

<-30 dBc

● Non-Harmonics

Output level ≤+5 dBm, CW, Frequency offset ≥10 kHz

- <-62 dBc (100 kHz ≤ f ≤ 187.5 MHz)
- <-68 dBc (187.5 MHz < f ≤ 750 MHz)
- <-62 dBc (750 MHz < f ≤ 1.5 GHz)
- <-56 dBc (1.5 GHz < f ≤ 3 GHz)
- <-50 dBc (3 GHz < f ≤ 6 GHz)

● Single Sideband Phase Noise (at CW, 20 kHz offset)

- <-140 dBc/Hz (nom.) (100 MHz)
- <-131 dBc/Hz (typ.) (1 GHz)
- <-125 dBc/Hz (typ.) (2 GHz)

● Analog Modulation

- Amplitude Modulation (Internal Modulation Source)
 - Depth: 0 to 100% (Linear)
 - 0 to 10 dB (Log)
 - Modulation Frequency: 0.1 Hz to 50 MHz
- Frequency Modulation (Internal Modulation Source)
 - Deviation: 0 Hz to 40 MHz
 - Modulation Frequency: 0.1 Hz to 40 MHz, or (50-MHz FM Rate), whichever smaller
- Φ-Modulation (Internal Modulation Source)
 - Deviation angle: 0 to 160 rad., or (40 MHz/ΦM Rate) rad., whichever smaller
 - Modulation Frequency: 0.1 Hz to 40 MHz, or (40 MHz/ΦM Deviation), whichever smaller
- Pulse Modulation (Internal Modulation Source)
 - Modulation Frequency: 0.1 Hz to 10 MHz
 - Modulation Period: 10 ns to 20 s

● Baseband Performance

- RF Modulation Bandwidth
 - 160 MHz*/120 MHz (using Internal baseband signal generator)
- ARB Memory Size
 - 64 Msamples (256 MB) [with 1stRF, 2ndRF]
 - 256 Msamples (1 GB) [Opt. 045/075]
 - 1024 Msamples (4 GB) [Opt. 046/076]

● Sampling Rate

20 kHz to 200 MHz*/160 MHz

● DAC Resolution

14/15/16 bits

*: Supports firmware version 2.00.00 and later. Only when using MX370111A WLAN IQproducer and MX370111A-002 802.11ac (160 MHz) option.

● EVM Performance

18° to 28°C, after CAL

W-CDMA (Test Model 4):

Output Frequency: 800 MHz to 900 MHz, 1.8 GHz to 2.2 GHz
 ≤0.62%(rms)
 ≤0.6%(rms) (typ.)

GSM:

Output Frequency: 800 MHz to 900 MHz, 1.8 GHz to 1.9 GHz
 ≤0.84%(rms)
 ≤0.8%(rms) (typ.)

EDGE:

Output Frequency: 800 MHz to 900 MHz, 1.8 GHz to 1.9 GHz
 ≤0.84%(rms)
 ≤0.8%(rms) (typ.)

LTE (20 MHz Test Model 3.1):

Output Frequency: 600 MHz to 2.7 GHz
 ≤0.82%(rms)
 ≤0.8%(rms) (typ.)

● Dimensions, Weight

177 (H) × 426 (W) × 390 (D) mm
 ≤13.7 kg (with 1stRF, excluding other option)

● Power Requirements

100 V(ac) to 120 V(ac), 200 V(ac) to 240 V(ac)
 50 Hz to 60 Hz

● EU Standards (CE Marking)

EMC: 2014/30/EU, EN61326-1, EN61000-3-2
 LVD: 2014/35/EU, EN61010-1
 RoHS: 2011/65/EU, EN50581

Options Configuration Guide

The following table shows the recommended option combinations.

Type	Opt. No	Retrofit	Name	032	034	036	018	041	042	043	045	046	048	049	050	062	064	066	071	072	073	075	076	078	079	080	001	002	011	017	021	
1stRF	MG3710A-032		1stRF 100 kHz to 2.7 GHz		*1	*1																										
1stRF	MG3710A-034		1stRF 100 kHz to 4 GHz	*1		*1																										
1stRF	MG3710A-036		1stRF 100 kHz to 6 GHz	*1	*1																											
1stRF	MG3710A-018	118	Analog IQ Input/Output																													
1stRF	MG3710A-041	141	High Power Extension for 1stRF																													
1stRF	MG3710A-042	142	Low Power Extension for 1stRF																													
1stRF	MG3710A-043	143	Reverse Power Protection for 1stRF																													
1stRF	MG3710A-045	145	ARB Memory Upgrade 256 Msample for 1stRF									*3																				
1stRF	MG3710A-046	146	ARB Memory Upgrade 1024 Msample for 1stRF								*3																					
1stRF	MG3710A-048	148	Combination of Baseband Signal for 1stRF																													
1stRF	MG3710A-049	149	AWGN for 1stRF																													
1stRF	MG3710A-050	150	Additional Analog Modulation Input for 1stRF																													
2ndRF	MG3710A-062	162	2ndRF 100 kHz to 2.7 GHz														*2	*2														
2ndRF	MG3710A-064	164	2ndRF 100 kHz to 4 GHz														*2	*2														
2ndRF	MG3710A-066	166	2ndRF 100 kHz to 6 GHz														*2	*2														
2ndRF	MG3710A-071	171	High Power Extension for 2ndRF																													
2ndRF	MG3710A-072	172	Low Power Extension for 2ndRF																													
2ndRF	MG3710A-073	173	Reverse Power Protection for 2ndRF																													
2ndRF	MG3710A-075	175	ARB Memory Upgrade 256 Msample for 2ndRF																													
2ndRF	MG3710A-076	176	ARB Memory Upgrade 1024 Msample for 2ndRF																													
2ndRF	MG3710A-078	178	Combination of Baseband Signal for 2ndRF																													
2ndRF	MG3710A-079	179	AWGN for 2ndRF																													
2ndRF	MG3710A-080	180	Additional Analog Modulation Input for 2ndRF																													
Common	MG3710A-001	101	Rubidium Reference Oscillator																													
Common	MG3710A-002	102	High Stability Reference Oscillator																													
Common	MG3710A-011	111	2ndary HDD																													
Common	MG3710A-017	117	Universal Input/Output																													
Common	MG3710A-021	121	BER Test Function																													

*1: Only one of 2.7 GHz, 4 GHz, and 6 GHz options. Retrofitting one of these options disables previously installed option.

*2: Only one of 2.7 GHz, 4 GHz, and 6 GHz options. Retrofitting one of these options disables previously installed option. Install any one 2ndRF option. Can be retrofitted only when 2ndRF not installed.

*3: Select any one. Selected memory size enabled and all others disabled.

Ordering Information

Please specify the model/order number, name and quantity when ordering.

The names listed in the chart below are Order Names. The actual name of the item may differ from the Order Name.

Model/Order No.	Name	Remarks
MG3710A	- Main frame - Vector Signal Generator	
P0031A	- Standard accessories - Power Cord: USB Memory Install CD-ROM	1 pc USB2.0 Flash Driver, ≥256 MB Operation manual (PDF) and application software (IQproducer)
MG3710A-001 MG3710A-002 MG3710A-011 MG3710A-017	- Options - (Common Parts) Rubidium Reference Oscillator High Stability Reference Oscillator 2ndary HDD Universal Input/Output	Select when ordering main frame, aging rate: $\pm 1 \times 10^{-10}$ /month Select when ordering main frame, aging rate: $\pm 1 \times 10^{-7}$ /year Select when ordering main frame, spare HDD for saving user data without Windows OS Select when ordering main frame, Adds BNC connectors for following signals to rear panel of main frame, includes J1539A AUX Conversion Adapter (Baseband Reference Clock Input/Output, Sweep Output, Local Signal Input/Output) Select when ordering main frame, Built-in BER measurement, Bit Rate: 100 bps to 40 Mbps J1539A AUX Conversion Adapter required for Data/Clock/Enable signal input
MG3710A-021	BER Test Function	Retrofitted to shipped MG3710A
MG3710A-101 MG3710A-102 MG3710A-111 MG3710A-117 MG3710A-121 MG3710A-181	Rubidium Reference Oscillator Retrofit High Stability Reference Oscillator Retrofit 2ndary HDD Retrofit Universal Input/Output Retrofit BER Test Function Retrofit CPU/Windows7 Upgrade Retrofit	Retrofitted to shipped MG3710A Retrofitted to shipped MG3710A Retrofitted to shipped MG3710A Retrofitted to shipped MG3710A Retrofitted to shipped MG3710A Retrofitted to shipped MG3710A This option is for MG3710A units ordered until May 2018. It upgrades the currently installed CPU to a faster CPU and the OS to Windows 7 (WES7). Due to OS license restrictions, this option is not applicable to MG3710A units in which Opt. 313 Removable HDD (sales discontinued) is installed.
MG3710A-032	(For 1stRF) 1stRF 100 kHz to 2.7 GHz	Select when ordering main frame, select 1stRF frequency range, frequency cannot be changed after installation
MG3710A-034	1stRF 100 kHz to 4 GHz	Select when ordering main frame, select 1stRF frequency range, frequency cannot be changed after installation
MG3710A-036	1stRF 100 kHz to 6 GHz	Select when ordering main frame, select 1stRF frequency range, frequency cannot be changed after installation
MG3710A-041 MG3710A-042 MG3710A-043	High Power Extension for 1stRF Low Power Extension for 1stRF Reverse Power Protection for 1stRF	Select when ordering main frame, increases upper limit of output signal power setting range Select when ordering main frame, increases lower limit of output signal power setting range Select when ordering main frame, prevents damage caused by reverse input to output connector
MG3710A-045 MG3710A-046 MG3710A-048 MG3710A-049 MG3710A-050	ARB Memory Upgrade 256 Msample for 1stRF ARB Memory Upgrade 1024 Msample for 1stRF Combination of Baseband Signal for 1stRF AWGN for 1stRF Additional Analog Modulation Input for 1stRF	Select when ordering main frame, expands ARB memory capacity Select when ordering main frame, expands ARB memory capacity Select when ordering main frame, adds baseband combine function Select when ordering main frame, adds AWGN combine function Select when ordering main frame, Adds BNC connector for inputting external signals to rear panel of mainframe.
MG3710A-018 MG3710A-141 MG3710A-142 MG3710A-143 MG3710A-145 MG3710A-146 MG3710A-148 MG3710A-149 MG3710A-150 MG3710A-118	Analog IQ Input/Output High Power Extension for 1stRF Retrofit Low Power Extension for 1stRF Retrofit Reverse Power Protection for 1stRF Retrofit ARB Memory Upgrade 256 Msample for 1stRF Retrofit ARB Memory Upgrade 1024 Msample for 1stRF Retrofit Combination of Baseband Signal for 1stRF Retrofit AWGN for 1stRF Retrofit Additional Analog Modulation Input for 1stRF Retrofit Analog IQ Input/Output Retrofit	Select when ordering main frame, installs IQ input/output BNC connector in main frame Retrofitted to shipped MG3710A Retrofitted to shipped MG3710A Retrofitted to shipped MG3710A Retrofitted to shipped MG3710A Retrofitted to shipped MG3710A Retrofitted to shipped MG3710A Retrofitted to shipped MG3710A Retrofitted to shipped MG3710A Retrofitted to shipped MG3710A Retrofitted to shipped MG3710A
MG3710A-062	(For 2ndRF) 2ndRF 100 kHz to 2.7 GHz	Select when ordering main frame, select 2ndRF frequency range, frequency cannot be changed after installation
MG3710A-064	2ndRF 100 kHz to 4 GHz	Select when ordering main frame, select 2ndRF frequency range, frequency cannot be changed after installation
MG3710A-066	2ndRF 100 kHz to 6 GHz	Select when ordering main frame, select 2ndRF frequency range, frequency cannot be changed after installation
MG3710A-071 MG3710A-072 MG3710A-073 MG3710A-075 MG3710A-076 MG3710A-078 MG3710A-079 MG3710A-080	High Power Extension for 2ndRF Low Power Extension for 2ndRF Reverse Power Protection for 2ndRF ARB Memory Upgrade 256 Msample for 2ndRF ARB Memory Upgrade 1024 Msample for 2ndRF Combination of Baseband Signal for 2ndRF AWGN for 2ndRF Additional Analog Modulation Input for 2ndRF	Select when ordering main frame, increases upper limit of output signal power setting range Select when ordering main frame, increases lower limit of output signal power setting range Select when ordering main frame, prevents damage caused by reverse input to output connector Select when ordering main frame, expands ARB memory capacity Select when ordering main frame, expands ARB memory capacity Select when ordering main frame, adds baseband combine function Select when ordering main frame, adds AWGN combine function Select when ordering main frame, Adds BNC connector for inputting external signals to rear panel of mainframe.
MG3710A-162 MG3710A-164 MG3710A-166 MG3710A-171 MG3710A-172 MG3710A-173 MG3710A-175 MG3710A-176 MG3710A-178 MG3710A-179 MG3710A-180	2ndRF 100 kHz to 2.7 GHz Retrofit 2ndRF 100 kHz to 4 GHz Retrofit 2ndRF 100 kHz to 6 GHz Retrofit High Power Extension for 2ndRF Retrofit Low Power Extension for 2ndRF Retrofit Reverse Power Protection for 2ndRF Retrofit ARB Memory Upgrade 256 Msample for 2ndRF Retrofit ARB Memory Upgrade 1024 Msample for 2ndRF Retrofit Combination of Baseband Signal for 2ndRF Retrofit AWGN for 2ndRF Retrofit Additional Analog Modulation Input for 2ndRF Retrofit	Retrofitted to shipped MG3710A when 2ndRF not installed Retrofitted to shipped MG3710A when 2ndRF not installed Retrofitted to shipped MG3710A when 2ndRF not installed Retrofitted to shipped MG3710A Retrofitted to shipped MG3710A Retrofitted to shipped MG3710A Retrofitted to shipped MG3710A Retrofitted to shipped MG3710A Retrofitted to shipped MG3710A Retrofitted to shipped MG3710A Retrofitted to shipped MG3710A Retrofitted to shipped MG3710A
MG3710A-ES210 MG3710A-ES310 MG3710A-ES510	- Maintenance service - 2 Years Extended Warranty Service 3 Years Extended Warranty Service 5 Years Extended Warranty Service	
MX370073A MX370073B MX370075A MX370084A	- Softwares - (Waveform pattern) DFS Radar Pattern DFS Radar Pattern DFS (ETSI) Waveform Pattern ISDB-Tmm Waveform Pattern	(License for waveform patterns) [to be discontinued in May 2019] WLAN 5.3/5.6 GHz band DFS tests (for FCC and Japan MIC (TELECOM)) waveform pattern, license for main frame, manual (PDF) WLAN 5.3/5.6 GHz band DFS tests (for FCC and Japan MIC (TELECOM)) waveform pattern, license for main frame, manual (PDF) WLAN 5.3/5.6 GHz DFS test (ETSI) waveform pattern, license for main frame, manual (PDF) ISDB-Tmm Waveform Patterns, license for main frame, manual (PDF)

Model/Order No.	Name	Remarks
	- Softwares - (IQproducer)	(License for IQproducer)
MX370101A	HSDPA/HSUPA IQproducer	IQproducer software, license for main frame, manual (PDF)
MX370102A	TDMA IQproducer	IQproducer software, license for main frame, manual (PDF)
MX370103A	CDMA2000 1xEV-DO IQproducer	IQproducer software, license for main frame, manual (PDF)
MX370104A	Multi-carrier IQproducer	IQproducer software, license for main frame, manual (PDF)
MX370105A	Mobile WiMAX IQproducer	IQproducer software, license for main frame, manual (PDF)
MX370106A	DVB-T/H IQproducer	IQproducer software, license for main frame, manual (PDF)
MX370107A	Fading IQproducer	IQproducer software, license for main frame, manual (PDF)
MX370108A	LTE IQproducer	IQproducer software, license for main frame, manual (PDF)
MX370108A-001	LTE-Advanced FDD Option	IQproducer software, license for main frame, manual (PDF). Requires MX370108A.
MX370110A	LTE TDD IQproducer	IQproducer software, license for main frame, manual (PDF)
MX370110A-001	LTE-Advanced TDD Option	IQproducer software, license for main frame, manual (PDF). Requires MX370110A.
MX370111A	WLAN IQproducer	IQproducer software, license for main frame, manual (PDF)
MX370111A-002	802.11ac (160 MHz) Option	IQproducer software, license for main frame, manual (PDF). Only for MG3710A. Requires MX370111A
MX370112A	TD-SCDMA IQproducer	IQproducer software, license for main frame, manual (PDF)
MX370113A	5G NR TDD sub-6GHz IQproducer	IQproducer software, license for main frame, manual (PDF)
	- Optional accessories -	
W3580AE	MG3710A/MG3740A Operation Manual (Main Unit)	Booklet, for MG3710A/MG3740A Main Frame (Operation, Remote Control)
W2496AE	MG3710A/MG3740A Operation Manual (IQproducer)	Booklet, for IQproducer (Operation for Common Parts)
W3581AE	MG3710A Operation Manual (Pre-installed Waveform Patterns)	Booklet, for Pre-installed Waveform Patterns (Usage, Detailed Parameters)
W3596AE	MX370073A Operation Manual	Booklet, for DFS (for FCC and Japan MIC (TELEC)) Waveform Patterns
W3986AE	MX370073B Operation Manual	Booklet, for DFS (for FCC and Japan MIC (TELEC)) Waveform Patterns
W3597AE	MX370075A Operation Manual	Booklet, for DFS (ETSI) Waveform Patterns
W3508AE	MX370084A Operation Manual	Booklet, for ISDB-Tmm Waveform Patterns
W2915AE	MX370101A Operation Manual	Booklet, for HSDPA/HSUPA IQproducer
W2916AE	MX370102A Operation Manual	Booklet, for TDMA IQproducer
W2505AE	MX370103A Operation Manual	Booklet, for CDMA2000 1xEV-DO IQproducer
W2917AE	MX370104A Operation Manual	Booklet, for Multi-carrier IQproducer
W2918AE	MX370105A Operation Manual	Booklet, for Mobile WiMAX IQproducer
W2798AE	MX370106A Operation Manual	Booklet, for DVB-T/H IQproducer
W2995AE	MX370107A Operation Manual	Booklet, for Fading IQproducer
W3023AE	MX370108A Operation Manual	Booklet, for LTE IQproducer/LTE-Advanced FDD Option
W3221AE	MX370110A Operation Manual	Booklet, for LTE TDD IQproducer/LTE-Advanced TDD Option
W3488AE	MX370111A Operation Manual	Booklet, for WLAN IQproducer/802.11ac Option
W3582AE	MX370112A Operation Manual	Booklet, for TD-SCDMA IQproducer
W3984AE	MX370113A Operation Manual	Booklet, for 5G NR TDD sub-6GHz IQproducer
J1539A	AUX Conversion Adapter	Converts MG3710A rear-panel AUX connector to BNC connector
Z1572A	Installation Kit	Required when retrofitting hardware options or installing IQproducer (MX3701xxA)
Z1594A	Standard Waveform Pattern for Backup	Latest MG3710A Pre-installed waveform pattern set for backup
MA24105A	Inline Peak Power Sensor	350 MHz to 4 GHz, Inline type, with USB A to micro-B Cable
MA24106A	USB Power Sensor	50 MHz to 6 GHz, with USB A to mini-B Cable
MA24108A	Microwave USB Power Sensor	10 MHz to 8 GHz, with USB A to micro-B Cable
MA24118A	Microwave USB Power Sensor	10 MHz to 18 GHz, with USB A to micro-B Cable
MA24126A	Microwave USB Power Sensor	10 MHz to 26 GHz, with USB A to micro-B Cable
K240B	Power Divider (K connector)	DC to 26.5 GHz, K-J, 50Ω, 1 Wmax
MA1612A	Four-Port Junction Pad	5 MHz to 3 GHz, N-J
J0576B	Coaxial Cord, 1.0 m	N-P · 5D-2W · N-P
J0576D	Coaxial Cord, 2.0 m	N-P · 5D-2W · N-P
J0127A	Coaxial Cord, 1.0 m	BNC-P · RG-58A/U · BNC-P
J0127B	Coaxial Cord, 2.0 m	BNC-P · RG-58A/U · BNC-P
J0127C	Coaxial Cord, 0.5 m	BNC-P · RG-58A/U · BNC-P
J0322A	Coaxial Cord, 0.5 m	SMA-P · SMA-P, DC to 18 GHz, 50Ω
J0322B	Coaxial Cord, 1.0 m	SMA-P · SMA-P, DC to 18 GHz, 50Ω
J0322C	Coaxial Cord, 1.5 m	SMA-P · SMA-P, DC to 18 GHz, 50Ω
J0322D	Coaxial Cord, 2.0 m	SMA-P · SMA-P, DC to 18 GHz, 50Ω
J0004	Coaxial Adapter	N-P · SMA-J Conversion Adapter, DC to 12.4 GHz
J1261B	Ethernet Cable (Shield Type)	Straight-through, 3 m
J1261D	Ethernet Cable (Shield Type)	Crossover, 3 m
J0008	GPIB Cable, 2.0 m	
B0635A	Rack Mount Kit	EIA
B0657A	Rack Mount Kit (JIS)	JIS
B0636C	Carrying Case	Hard Type. With Casters and B0671A Front Cover
B0671A	Front Cover for 1MW4U	
Z0975A	Keyboard (USB)	
Z0541A	USB Mouse	

The following option is installed as standard when ordering the MG3710A. It does not require a separate order.
MX371099A MG3710A Standard Waveform Pattern

Typical (typ.): Performance not warranted. Must products meet typical performance.

Nominal (nom.): Values not warranted. Included to facilitate application of product.

Measured (meas): Performance not warranted. Data actually measured by randomly selected measuring instruments.

Trademarks:

- IQproducer™ is a registered trademark of Anritsu Corporation.
- MATLAB® is a registered trademark of The MathWorks, Inc.
- CDMA2000® is a registered trademark of the Telecommunications Industry Association (TIA-USA).
- The Bluetooth® mark and logos are owned by Bluetooth SIG, Inc. and are used by Anritsu under license.
- Pentium® is registered trademarks of Intel Corporation or its subsidiaries in the USA and other countries.
- Windows® is a registered trademark of Microsoft Corporation in the USA and other countries.
- WiMAX® is a trademark or registered trademark of WiMAX Forum.
- Other companies, product names and service names are registered trademarks of their respective companies.



J1539A AUX Conversion Adapter



MA24106A USB Power Sensor



**B0636C Carrying Case
(Hard type, with casters)**



B0671A Front Cover for 1MW4U

Anritsu envision : ensure

Specifications are subject to change without notice.

● **United States**

Anritsu Americas Sales Company

450 Century Parkway, Suite 190, Allen,
TX 75013, U.S.A.
Phone: +1-800-Anritsu (1-800-267-4878)

● **Canada**

Anritsu Electronics Ltd.

700 Silver Seven Road, Suite 120, Kanata,
Ontario K2V 1C3, Canada
Phone: +1-613-591-2003
Fax: +1-613-591-1006

● **Brazil**

Anritsu Elettronica Ltda.

Praça Amadeu Amaral, 27 - 1 Andar
01327-010 - Bela Vista - Sao Paulo - SP
Brazil
Phone: +55-11-3283-2511
Fax: +55-11-3288-6940

● **Mexico**

Anritsu Company, S.A. de C.V.

Bldv Miguel de Cervantes Saavedra #169 Piso 1, Col. Granada
Mexico, Ciudad de Mexico, 11520, MEXICO
Phone: +52-55-4169-7104

● **United Kingdom**

Anritsu EMEA Ltd.

200 Capability Green, Luton, Bedfordshire, LU1 3LU, U.K.
Phone: +44-1582-433200
Fax: +44-1582-731303

● **France**

Anritsu S.A.

12 avenue du Québec, Bâtiment Iris 1-Silic 612,
91140 VILLEBON SUR YVETTE, France
Phone: +33-1-60-92-15-50
Fax: +33-1-64-46-10-65

● **Germany**

Anritsu GmbH

Nemetschek Haus, Konrad-Zuse-Platz 1
81829 München, Germany
Phone: +49-89-442308-0
Fax: +49-89-442308-55

● **Italy**

Anritsu S.r.l.

Via Elio Vittorini 129, 00144 Roma, Italy
Phone: +39-6-509-9711
Fax: +39-6-502-2425

● **Sweden**

Anritsu AB

Isafjordsgatan 32C, 164 40 KISTA, Sweden
Phone: +46-8-534-707-00

● **Finland**

Anritsu AB

Teknobulevardi 3-5, FI-01530 VANTAA, Finland
Phone: +358-20-741-8100
Fax: +358-20-741-8111

● **Denmark**

Anritsu A/S

Torveporten 2, 2500 Valby, Denmark
Phone: +45-7211-2200
Fax: +45-7211-2210

● **Russia**

Anritsu EMEA Ltd.

Representation Office in Russia

Tverskaya str. 16/2, bld. 1, 7th floor.
Moscow, 125009, Russia
Phone: +7-495-363-1694
Fax: +7-495-935-8962

● **Spain**

Anritsu EMEA Ltd.

Representation Office in Spain

Edificio Cuzco IV, Po. de la Castellana, 141, Pta. 5
28046, Madrid, Spain
Phone: +34-915-726-761
Fax: +34-915-726-621

● **United Arab Emirates**

Anritsu EMEA Ltd.

Dubai Liaison Office

902, Aurora Tower,
P O Box: 500311 - Dubai Internet City
Dubai, United Arab Emirates
Phone: +971-4-3758479
Fax: +971-4-4249036

● **India**

Anritsu India Private Limited

6th Floor, Indigube ETA, No.38/4, Adjacent to EMC2,
Doddanekundi, Outer Ring Road, Bengaluru - 560048, India
Phone: +91-80-6728-1300
Fax: +91-80-6728-1301

● **Singapore**

Anritsu Pte. Ltd.

11 Chang Charn Road, #04-01, Shriro House
Singapore 159640
Phone: +65-6282-2400
Fax: +65-6282-2533

● **P.R. China (Shanghai)**

Anritsu (China) Co., Ltd.

Room 2701-2705, Tower A,
New Caohejing International Business Center
No. 391 Gui Ping Road Shanghai, 200233, P.R. China
Phone: +86-21-6237-0898
Fax: +86-21-6237-0899

● **P.R. China (Hong Kong)**

Anritsu Company Ltd.

Unit 1006-7, 10/F., Greenfield Tower, Concordia Plaza,
No. 1 Science Museum Road, Tsim Sha Tsui East,
Kowloon, Hong Kong, P.R. China
Phone: +852-2301-4980
Fax: +852-2301-3545

● **Japan**

Anritsu Corporation

8-5, Tamura-cho, Atsugi-shi, Kanagawa, 243-0016 Japan
Phone: +81-46-296-6509
Fax: +81-46-225-8352

● **Korea**

Anritsu Corporation, Ltd.

5FL, 235 Pangyoyeok-ro, Bundang-gu, Seongnam-si,
Gyeonggi-do, 13494 Korea
Phone: +82-31-696-7750
Fax: +82-31-696-7751

● **Australia**

Anritsu Pty. Ltd.

Unit 20, 21-35 Ricketts Road,
Mount Waverley, Victoria 3149, Australia
Phone: +61-3-9558-8177
Fax: +61-3-9558-8255

● **Taiwan**

Anritsu Company Inc.

7F, No. 316, Sec. 1, NeiHu Rd., Taipei 114, Taiwan
Phone: +886-2-8751-1816
Fax: +886-2-8751-1817