



Table of Contents

1	General Information	7
1.1	Notes on the Use of this Handbook	7
1.1.1	Safety Symbols	7
1.1.2	Indications	8
1.1.3	Symbols of Vacuum Technology	8
1.1.4	Definiton of Terms	8
1.2	Support from INFICON Service	10
1.2.1	Service Centers	11
1.3	Introduction	13
1.3.1	Purpose	13
1.3.2	Technical Data	15
1.3.2.1	Physical Data	15
1.3.2.2	Electrical Data	15
1.3.2.3	Other Data	16
1.3.2.4	Ambient Conditions	16
1.4	Unpacking	16
1.4.1	Supplied Equipment	17
1.4.2	Accessories and Options	18
1.4.2.1	Sniffer line SL200	18
1.4.2.2	Toolbox	18
1.4.2.3	Helium Bottle Holder	18
1.4.2.4	ESD Mat	18
1.4.2.5	RC1000 Remote control	19
1.4.2.6	Test chamber TC1000	20
2	Installation	21
2.1	Transportation	21
2.2	Working Location	23
2.3	Electrical Connections	25
2.3.1	Mains Power	25
2.3.2	Connections for the Data Acquisition Systems	27
2.3.2.1	Accessories	28
2.3.2.2	Digital Out	28
2.3.2.3	Digital In	29
2.3.2.4	Recorder	30
2.3.2.5	RS232	31
2.3.2.6	Remote Control	31
2.4	Vaccum Connections	32
2.4.1	Inlet Port	32
2.4.2	Exhaust	32
2.4.3	Vent	32
2.4.4	Purge-connection (UL1000 Fab) / Gas ballast (UL1000)	32
2.5	Default parameters	33

Technical Handbook

(1111)

iina70e content.fm

3	First Operation Check	34
3.1	Needed Equipment	34
3.2	Description of the Initial Operation	34
3.2.1	Start up and Measure	34
3.2.2	Internal Calibration	37
3.2.3	Verification	37
4	Description and Working Principle	38
4.1	Introduction	38
4.2	Components of the UL1000 and UL1000 Fab	38
4.2.1	Vacuum System	39
4.2.2	Control Panel	40
4.2.2.1	LC Display	41
4.2.2.2	START Button	41
4.2.2.3	STOP Button	41
4.2.2.4	ZERO Button	41
4.2.2.5	MENU Button	43
4.2.2.6	Soft Keys	43
4.2.2.7	Numerical Entries	43
4.3	Working Modes	45
4.3.1	Vacuum Mode	45
4.3.2	Sniffer Mode	47
4.3.3	Auto Leak Test Mode	47
5	Operation of the UL1000 and UL1000 Fab	48
5.1	Display	48
5.2	The Screen in Run-Up Mode	48
5.3	Display in stand-by mode	49
5.3.1	Purging	49
5.4	The Screen in Measurement Mode	49
5.4.1	Call for Calibration	49
5.4.2	Speaker Volume	50
5.4.3	Status Line in the Display	50
5.4.4	Numerical Display Mode	51
5.4.5	Trend Mode	51
6	Description of the Menu	52
6.1	Main Menu	52
6.2	View	54
6.2.1	Scale linear/logarithmic	55
6.2.2	Display-range auto/manual	55
6.2.3	Time axis	56
6.2.4	Contrast	56
6.2.5	Background in Stand-by	57
6.2.6	Decimal places	57
6.2.7	Lower display limit	58
6.3	Mode	58
6.3.1	Auto Leak Test	59

6.4	Trigger & Alarms	61
6.4.1	Trigger Level 1	61
6.4.2	Trigger Level 2	62
6.4.3	Volume	62
6.4.4	Units	63
6.4.5	Alarm delay	63
6.4.6	Audio alarm type	64
6.4.6.1	Pinpoint	64
6.4.6.2	Leak rate prop.	64
6.4.6.3	Setpoint	65
6.4.6.4	Trigger alarm	65
6.5	Calibration	65
6.6	Settings	66
6.6.1	Vacuum settings	67
6.6.1.1	Automatic purge (UL1000 Fab only)	67
6.6.1.2	Vent delay	67
6.6.1.3	Vacuum ranges	68
6.6.1.4	Leak rate internal test leak	69
6.6.1.5	Machine factor	69
6.6.1.6	Auto Leak Test adjustments	69
6.6.2	Zero & Background	73
6.6.2.1	Background Suppression	73
6.6.2.2	Zero	73
6.6.3	Mass	74
6.6.4	Interfaces	74
6.6.4.1	Control Location	75
6.6.4.2	RS232 Protocol	76
6.6.4.3	Recorder output	77
6.6.4.4	Scaling Recorder Output	78
6.6.5	Miscellaneous	79
6.6.5.1	Time&Date	79
6.6.5.2	Language	79
6.6.5.3	Leak rate filter	80
6.6.5.4	Mains Frequency	80
6.6.5.5	Service interval exhaust filter	80
6.6.5.6	Service message exhaust filter	81
6.6.6	Parameter save / load	81
6.6.6.1	Load parameter set	81
6.6.6.2	Save parameter set	82
6.6.7	Monitoring functions	82
6.7	Information	85
6.7.1	Service	85
6.8	Access Control	86
6.8.1	Access to CAL function	86
6.8.2	Change Device PIN	87
6.8.3	Change Menu-PIN	87
7	Calibration	88
7.1	Introduction	88
7.2	The calibration routines	88

7.2.1	Internal Calibration	89
7.2.1.1	Automatic Internal Calibration	89
7.2.1.2	Manual Internal Calibration	89
7.2.2	External Calibration	89
7.3	Factor of Calibration - Range of Values	93
8	Error And Warning Messages	94
8.1	Hints	94
8.2	List of Errors & Warnings	95
9	Maintenance Work	99
9.1	General Information	99
9.2	Maintenance or Service at INFICON	100
9.3	Key to the Maintenance Plan	100
9.4	Maintenance Plan	101
9.5	Maintenance Groups	102
9.5.1	1500 Hours Maintenance	102
9.5.2	4000 Hours Maintenance	102
9.5.3	8000 Hours Maintenance	103
9.5.4	16000 Hours Maintenance	103
9.5.5	Notes referring the maintenance of the SplitFlow 80	104
9.6	Description of the Maintenance Work	104
9.6.1	Opening the Instrument for Maintenance Purposes	105
9.7	Checking and Replacing the Filter Insert	106
9.8	Replacing the Exhaust Silencer	108
9.9	Checking/Emptying the Exhaust Filter	109
9.9.1	Replacing the Filter Insert	109
9.10	Monitoring the Oil Level of the D16 B and Topping up the Oil	111
9.11	Oil Change for the D16B	112
9.12	Scroll Pumps (UL1000 and UL1000 Fab only)	114
<hr/>		
	Appendix	115
A	Diagram	115
B	Index	116
C	Declaration of Conformity	118

1 General Information

Notice: We recommend that you carefully read this technical handbook to ensure optimum operating conditions right from the start.

This technical handbook contains important informations on the functions, installation, start-up and operation of the UL1000 and UL1000 Fab.

General

We reserve the right to modify the design and the specified data. The illustrations are not binding.

1.1 Notes on the Use of this Handbook

1.1.1 Safety Symbols

Important remarks concerning operational safety and protection are emphasised as follows:



Caution

Information on correct handling or use. Disregard can lead to malfunctions or minor equipment damage.



Warning

Information on preventing extensive equipment and environmental damage.



Danger

Information on preventing any kind of physical injury.



Skilled personnel

Indicates procedures that must be performed by skilled personnel only.

1.1.2 Indications

Tip Information on helpful procedures.

Notice: Information on special technical requirements that the user must comply with.

The references to diagrams consists of the chapter number, figure number and the item number in this order. For example: Fig. 2-4/7 refers to item 7 in the figure 4 of chapter 2.

1.1.3 Symbols of Vacuum Technology

Given in the following are some important vacuum symbols which are used in this manual.

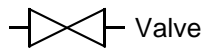
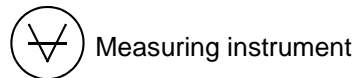
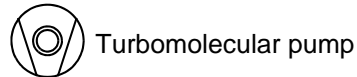
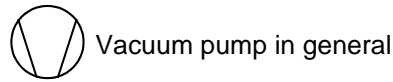

1.1.4 Definiton of Terms

Autoranging

The range of the preamplifier and the vacuum ranges are selected automatically.

The autoranging feature of the UL1000 Fab covers the entire range or leak rates depending on the selected operating mode. Not only the leak rate signal, but also the pressure in the test sample (inlet pressure P1) and the forevacuum pressure (P2) are used for control purposes. Range switching between the main ranges is performed via valves. Fine range switching within the main ranges is implemented by switching over the gain factor of the preamplifier.

Autotune Mass alignment

This function automatically aligns the mass spectrometer so that a maximum leak rate is displayed. The control processor changes the voltage which erates the ions in the selected mass range until a maximum ion current is detected by the ion detector. During each calibration the mass alignment is run automatically.

Auto zero

Measurement and automatic adaptation to the helium background.

This function determines the internal ZERO level of the unit which is then deducted from the currently measured leak rate signal. This function is enabled by pressing the Start key provided the UL1000 or UL1000 Fab have run at least 20 s in "Standby" mode or in "Ventilation" mode.

If the before suppressed helium background further decreases and only the display limit appears, the ZERO-level will be adjusted automatically

Menu

The menu allows the user to program the UL1000 and UL1000 Fab according to his requirements. The menu has a tree architecture.

Default

Status of the UL1000 and UL1000 Fab when supplied by the factory.

GROSS

GROSS is a measurement mode which allows high inlet pressure (1 to 15 mbar). The smallest detectable leak rate is 1×10^{-6} mbar l/s.

FINE

FINE is the medium measurement mode with inlet pressure between 2 and 0,4 mbar. Detection limit is 1×10^{-10} mbar l/s.

ULTRA

ULTRA is the most sensitive measuring range with inlet pressures below 0,4 mbar. The minimum detectable leak rate is 5×10^{-12} mbar l/s.

Foreline pressure

Pressure in the foreline between Turbo pump and scroll pump.

Minimum detectable leak rate

The smallest leak rate the UL1000 and UL1000 Fab is able to detect ($\leq 5 \times 10^{-12}$ mbar l/s).

Internal helium background

The existing helium partial pressure in the measurement system. The level of the internal helium background is measured in the Stand-by mode and subtracted from the measured signal.

Measure Measurement mode

The UL1000 and UL1000 Fab measures the leak rate of the test sample.

1.2 Support from INFICON Service

If an instrument is returned to INFICON or an authorised representative of INFICON, please indicate whether the instrument is free of substances damaging to health or whether it is contaminated. If it is contaminated also indicate the nature of the hazard. INFICON must return any appliances without a *Declaration of Contamination* to the sender's address. A form for stating details as to the type of contamination is reproduced in Fig. 1-1.

A maintenance and service contract is recommended.



Declaration of Contamination

The service, repair, and/or disposal of vacuum equipment and components will only be carried out if a correctly completed declaration has been submitted. Non-completion will result in delay.
This declaration may only be completed (in block letters) and signed by authorized and qualified staff.

1 Description of product

Type _____
Article Number _____
Serial Number _____

2 Reason for return

3 Operating fluid(s) used (Must be drained before shipping.)

4 Process related contamination of product

toxic	no <input type="checkbox"/> 1)	yes <input type="checkbox"/>		
caustic	no <input type="checkbox"/> 1)	yes <input type="checkbox"/>		
biological hazard	no <input type="checkbox"/>	yes <input type="checkbox"/> 2)		
explosive	no <input type="checkbox"/>	yes <input type="checkbox"/> 2)		
radioactive	no <input type="checkbox"/>	yes <input type="checkbox"/> 2)		
other harmful substances	no <input type="checkbox"/> 1)	yes <input type="checkbox"/>		

The product is free of any substances which are damaging to health

1) or not containing any amount of hazardous residues that exceed the permissible exposure limits

2) Products thus contaminated will not be accepted without written evidence of decontamination!

5 Harmful substances, gases and/or by-products

Please list all substances, gases, and by-products which the product may have come into contact with:

Trade/product name	Chemical name (or symbol)	Precautions associated with substance	Action if human contact

6 Legally binding declaration:

I/we hereby declare that the information on this form is complete and accurate and that I/we will assume any further costs that may arise. The contaminated product will be dispatched in accordance with the applicable regulations.

Organization/company _____

Address _____ Post code, place _____

Phone _____ Fax _____

Email _____

Name _____

Date and legally binding signature _____ Company stamp _____

This form can be downloaded from our website. Copies: Original for addressee - 1 copy for accompanying documents - 1 copy for file of sender

INFICON GmbH

Bonner Str. 498, 50968 Cologne, Germany
Tel: +49 221 3474 2222 Fax: +49 221 3474 2221
www.inficon.com leakdetection.service@inficon.com zisa01e1-a

Fig. 1-1: Declaration of Contamination form

1.2.1 Service Centers

In case you urgently need assistance please get in touch with the local INFICON Service in your country or the service hotline in Cologne, Germany:

Algeria Agramkow Sonderborg	jhj@agramkow.dk Phone: +45 741 236 36 Fax: +45 744 336 46	Finland Agramkow Sonderborg	jhj@agramkow.dk Phone: +45 741 236 36 Fax: +45 744 336 46
Belarus INFICON GmbH Cologne	leakdetection.service@inficon.com Phone: +49 221 56788-112 Fax: +49 221 56788-9112	France OLV France Orsay	Christophe.Zaffanella@oerlikon.com Phone: +33 476 351 584 Fax: +33 476 351 584
Belgium INFICON GmbH Cologne	leakdetection.service@inficon.com Phone: +49 221 56788-112 Fax: +49 221 56788-9112	Germany INFICON GmbH Cologne	leakdetection.service@inficon.com Phone: +49 221 56788-112 Fax: +49 221 56788-9112
Brazil PV Pest Vácuo Ltda. Santa de Parnaíba	fernandoz@prestvacuo.com.br Phone: +55 114 154 4888 Fax: +55 114 154 4888	Hungary Kontrade Budaörs	adam.lovics@kon-trade.hu Phone: +36 23 50 38 80 Fax: +36 23 50 38 96
Bulgaria INFICON GmbH Cologne	leakdetection.service@inficon.com Phone: +49 221 56788-112 Fax: +49 221 56788-9112	India Dashpute 400 064	asdash@hotmail.com Phone: +91 22 888 0324 Fax: +91 22 888 0324
Canada Vacuum Products Canada Ltd. Ontario	reachus@vpcinc.ca Phone: +905.672.7704 Fax: +905.672.2249	Ireland INFICON Blackburn	reach.unitedkingdom@inficon.com Phone: +44 1254 678 250 Fax: +44 1254 698 577
Central America MEISA S.a. de C.V. Querétaro	infoqro@meisa.com Phone: +52 44 22 25 42 80 Fax: +52 44 22 25 41 57	Italy INFICON GmbH Castelnuovo	davide.giovanetti@inficon.com Phone: +39 045 6 40 25 56 Fax: +39 045 6 40 24 21
China INFICON LTD Hong Kong INFICON LTD Beijing INFICON LTD Guangzhou INFICON LTD Shanghai	reach.china@inficon.com Phone: +852.2862.8863 Fax: +852.2865.6883 Phone: +86.10.6590.0164 Fax: +86.10.6590.0521 Phone: +86.20.8723.6889 Fax: +86.20.8723.6003 Phone: +86.21.6209.3094 Fax: +86.21.6295.2852	Israel Mark Technologies Ltd. Kiriát Ono Japan INFICON Co. Ltd. Yokohama	urimark@mark-tec.co.il Phone: +972 35 34 68 22 Fax: +972 35 34 25 89 reach.japan@inficon.com Phone: +81.45.471.3396 Fax: +81.45.471.3387
Czech Republic INFICON GmbH Pilsen	filip.lisec@inficon.com Phone +420 734 331 758 Fax: +420 604 203 037	Korea INFICON Ltd. Sungnam city INFICON Ltd. Suwon City INFICON Ltd. Cheonan City	reach.korea@inficon.com Phone: +82 312 062 890 Fax: +82 312 063 058 Phone: +82 312 062 890 Fax: +82 312 063 058 Phone: +82 312 062 890 Fax: +82 312 063 058
Denmark Agramkow Sonderborg	jhj@agramkow.dk Phone: +45 744 336 36 Fax: +45 744 336 46	Latvia INFICON GmbH Cologne	leakdetection.service@inficon.com Phone: +49 221 56788-112 Fax: +49 221 56788-9112
Egypt Agramkow Sonderborg	jhj@agramkow.dk Phone: +45 741 236 36 Fax: +45 744 336 46	Lithuania INFICON GmbH Cologne	leakdetection.service@inficon.com Phone: +49 221 56788-112 Fax: +49 221 56788-9112

Mexico MEISA S.a. de C.V. Querétaro	infoqro@meisa.com Phone: +52 442 225 42 80 Fax: +52 442 225 41 57	Spain Leybold Optics Ibérica Barcelona	richard.cunill@leyboldoptics.com Phone: +34 93 66 60 778 Fax: +34 93 66 64 612
Netherlands INFICON GmbH Cologne	leakdetection.service@inficon.com Phone: +49 221 56788-112 Fax: +49 221 56788-9112	Sweden Agramkow Sonderborg	jhj@agramkow.dk Phone: +45 741 236 36 Fax: +45 744 336 46
Norway Agramkow Sonderborg	jhj@agramkow.dk Phone: +45 741 236 36 Fax: +45 744 336 46	Syria INFICON GmbH Cologne	leakdetection.service@inficon.com Phone: +49 221 56788-112 Fax: +49 221 56788-9112
Poland VAK-POL & GAZ Sp. zo.o Pulawy	kamola@vakpol.com Phone: +48 60 23 15 212 Fax: +48 60 23 15 212	Taiwan INFICON Company Limited Chupei City, HsinChu Hsien	Susan.Chang@inficon.com Phone: +886.3.5525.828 Fax: +886.3.5525.829
Portugal INFICON GmbH Cologne	leakdetection.service@inficon.com Phone: +49 221 56788-112 Fax: +49 221 56788-9112	Tunisia INFICON GmbH Cologne	leakdetection.service@inficon.com Phone: +49 221 56788-112 Fax: +49 221 56788-9112
Republic of South Africa Vacuquip Randburg	vacuquip@hotmail.com Phone: +27 73 15 78 355	Turkey Agramkow Sonderborg	jhj@agramkow.dk Phone: +45 741 236 36 Fax: +45 744 336 46
Russia INFICON GmbH Cologne	leakdetection.service@inficon.com Phone: +49 221 56788-112 Fax: +49 221 56788-9112	Ukraine INFICON GmbH Cologne	leakdetection.service@inficon.com Phone: +49 221 56788-112 Fax: +49 221 56788-9112
Singapore INFICON PTE LTD. Singapur	reach.singapore@inficon.com Phone: +65.890.6250 Fax: +65.890.6266	United Kingdom INFICON Blackburn	reach.unitedkingdom@inficon.com Phone: +44 1254 678 250 Fax: +44 1254 698 577
Slovakia INFICON GmbH Pilsen	filip.lisec@inficon.com Phone +420 734 331 758 Fax: +420 604 203 037	United Arab Emirates INFICON GmbH Cologne	leakdetection.service@inficon.com Phone: +49 221 56788-112 Fax: +49 221 56788-9112
Slovenia Medivac Ljubljani	medivak@siol.net Phone: +386 15 63 91 50 Fax: +386 17 22 04 51	USA Inficon Inc. East Syracuse, NY	service.usa@inficon.com Phone: +1.315.434.1167 Fax: +1.315.434.2551
South America except Brazil MEISA S.a. de C.V. Querétaro	infoqro@meisa.com Phone: +52 44 22 12 36 15 Fax: +52 44 22 12 19 40	Inficon Inc. San Jose, CA Inficon Inc. Austin, TX	Phone: +1.408.361.1200 Fax: +1.408.362.1556 Phone: +1.512.448.0488 Fax: +1.512.448.0398

1.3 Introduction

1.3.1 Purpose

The UL1000 and UL1000 Fab are helium leak detectors. These instruments may be used to detect the location and the size of leaks on objects under test in two different ways:

- when the test sample has been evacuated first and is sprayed with helium on the outside. It is required that a vacuum connection is provided between the UL1000 and UL1000 Fab and the test sample (vacuum mode).

or

- when a helium overpressure is provided in the test sample and the test sample is searched from the outside with a sniffer probe which is attached to the inlet port (sniffer mode).



Danger

Caution: Danger of explosion

Hydrogen forms a highly explosive gas mixture with air.

Great caution is necessary when using hydrogen! No smoking, no naked flames, avoid sparks.



Caution

The UL1000/UL1000 Fab is only allowed to be used as a leak detector. It may not be used as a pump system (especially not for pumping off aggressive or humid gasses)

For UL1000 use only:

Notice: Pumping condensable gases and steams: When pumping test sample water vapour that is inside can attain to the fore pump. With the water vapor that is in the air - especially in humid areas or when using humid or wet test samples - the acceptable compatibility of water vapor or capacity of water vapor respectively can be exceeded.

The steam in the oil of the pump condenses when the water vapor rises over the acceptable value. So the attribute of the oil changes and danger of corrosion occurs for the pump.

While using the leak detector with condensable gases and steams the oil of the fore pump has to be controlled regularly. So you can recognize a condensation of water vapor in the pump. Usually the oil is light and lucent. When water vapor is inside it gets bler and milky at operating state temperature.

When turning the pump off water vapor condensates and raises the part of water in the oil.



Warning

The leak detector must not directly be switched off after the process, in which condensable gases or steams are pumped, is finished. It must be running (at least 20 minutes) with open gas ballast valve (see Chapter 5.3.1) until the oil of the pump is free from detached steams.

When not taking care of this instruction there can be a corrosion within the pump. So damages will occur.

The height of the oil of the pump has to be controlled regularly.

The normal intervalls of changing the oil from the producer have to be taken care of. See instructions of the rotary vane pump.



Caution

Gases that contain halogen molecules (i.e. fluorine, chlorine), i.e. refrigerants and SF₆, should not be pumped by the leak detector in higher contact ratios and over a longer time period.

The coating layer of the cathodes (at the ion source) can be affected. This could cause a burn out of the cathodes.

For UL1000 Fab use only:



Caution

Condensable gases and steams can attain the inside of the leak detector and destruct the fore pump.

With the water vapor that is in the air - especially in humid areas or when using humid or wet test samples - the acceptable compatibility of water vapor or capacity of water vapor respectively can be exceeded.



Danger

Dangerous gases pollute the machine.

So you must not use the machine for detecting toxical, acidity, microbiological, explosive, radioactive or other noxious matters.

If you plan to detect noxious matters please contact the manufacturer. Rules for decontamination will be developed then. If the leak detector already has been in contact with dangerous gases please fill the declaration of contamination, too, and send it to INFICON **before** you send the parts.

1.3.2 Technical Data

1.3.2.1 Physical Data

Max. inlet pressure	15 mbar
Minimum detectable Helium leak rates	
• in vacuum mode (ULTRA)	$<5 \times 10^{-12}$ mbar l/s
limit of detection in sniffer mode	$<5 \times 10^{-8}$ mbar l/s
Maximum displayable helium leak rate in ULTRA	0.1 mbar l/s
Measurement range	12 decades
Time constant of the leak rate signal (blanked off, 63% of the final value)	<1 s
Pumping speed (Helium) at the inlet	
Max. roughing capability	25 m ³ /h (50 Hz) 17.6 cfm (50 Hz) 30 m ³ /h (60 Hz) 21.1 cfm (60 Hz)
• in vacuum mode	
– GROSS mode	8 l/s
– FINE mode	7 l/s
– ULTRA mode	2.5 l/s
Detectable masses	2, 3 and 4
Mass spectrometer	180° magnetic sector field
Ion source	2 filaments; Iridium/Yttria-oxide
Inlet port	DN 25 KF
Run-up time (after starting)	≤ 3 min

Hinweis To get down to the minimum detected leak rate range some conditions must be fulfilled:

- UL1000 and UL1000 Fab has fully warmed up
- Ambient conditions must be stable (temperature, no vibration/accelerations.)
- The part under test has been evacuated long enough (background is no longer decreasing)
- ZERO must be active

1.3.2.2 Electrical Data

Part no. 550 - 000A, 550 - 100A	230 V 50 Hz
Part no. 550 - 001A, 550 - 101A	115 V 60 Hz
Part no. 550 - 002A	100 V 50/60 Hz
Power consumption	1100 VA
Type of protection	IP20
Power cords (EU, USA, UK)	3 m

1.3.2.3 Other Data

Valves	solenoid
Dimensions (L x W x H) incl. handle in mm	1068 x 525 x 850
Dimensions (L x W x H) incl. handle in inches	42 x 21 x 33
Weight in kg	110
Weight in lbs	242
Noise level dB (A)	< 70
Noise level dB (A) 0.5m distance	< 56
Audio alarm dB (A)	90
Contamination level (to IEC 60664-1)	2
Overvoltage category (to IEC 60664-1)	II

1.3.2.4 Ambient Conditions

For use within buildings	
Permissible ambient temperature (during operation)	+10 °C ... +40 °C
Permissible storage temperature	0 °C ... +60 °C
Max. rel. humidity	80% non condensing
Max. permissible height above sea level (during operation)	2000 m

1.4 Unpacking

Unpack the UL1000 and UL1000 Fab immediately after delivery, even if it will be installed later on.

Examine the shipping container for any external damage. Completely remove the packaging materials.

Check if the UL1000 and UL1000 Fab is complete (See Chapter 1.4.1) and carefully examine the leak detector visually.

If any damage is discovered, report it immediately to the forwarding agent and insurer. If the damaged part has to be replaced, please contact the orders department.

Notice: Before starting up make sure that the transportation fixing is loosened. (Please refer to chapter 2.1)

Tipp Retain the packaging materials in the event of complaints about damage.

Tipp For unpacking please use the wedge which is part of the packaging.

1.4.1 Supplied Equipment

- Helium Leak Detector UL1000 or UL1000 Fab
- Exhaust hose adapter with clamps (see arrow 1)
- power cord fixture
- Set of fuses (see arrow 2)
- Set of tools (see arrow 7)
- Bellow Clips (2 + 2) (see arrow 5)
- Folder with documents
 - Technical Handbook UL1000 and UL1000 Fab
 - Spare Parts List UL1000 and UL1000 Fab
- hooks to wrap power cord (with screws) (see arrow 6)
- Tool to open the UL1000 and UL1000 Fab (see arrow 7)
- O-Ring with filter (for use at applications with particles)

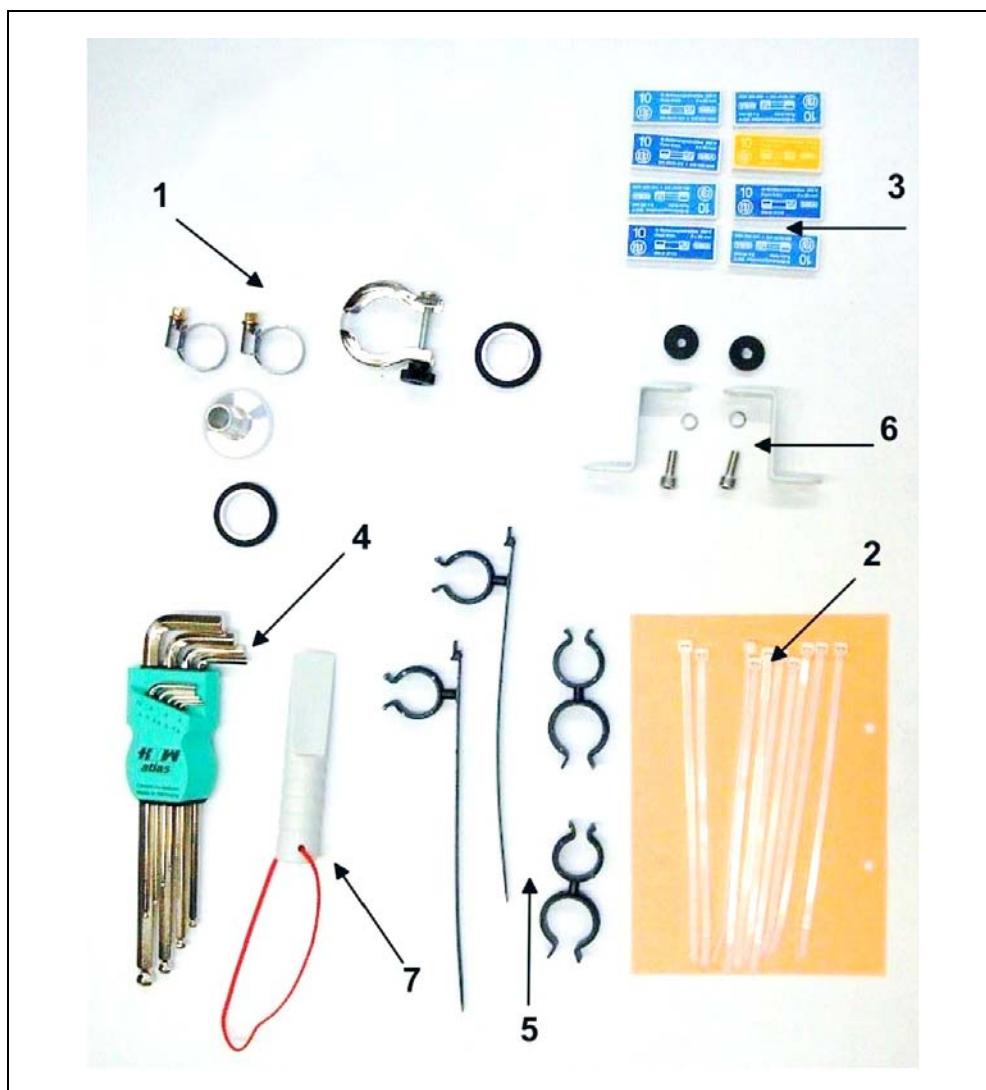

Fig. 1-2

1.4.2 Accessories and Options

The following parts can be ordered additionally:

• Sniffer Line SL200	14005
• Leak Ware	14090
• Helium Sniffer QUICK-TEST QT100	15594
• Tool Box (detachable)	551-000
• Helium Bottle Holder	551-001
• ESD Mat	551-002
• RC1000 Remote control	
– RC1000WL wireless version	551-015
– RC1000C cable version	551-010
– Extension Cable, 8 m	14022
• Test chamber TC1000	551-005
• spray gun with hose	16555
• set of plugs	20099024
• LeakWare (software package)	14090

1.4.2.1 Sniffer line SL200

By use of the sniffer line the UL1000 and UL1000 Fab can easily be converted to a sniffer leak detector. The length of the sniffer line is 4m (i.e. 12 feet).

1.4.2.2 Toolbox

The toolbox is a detachable compartment with a lockable lid. Fittings and small fixtures can be stored plus the hand set (Please refer to Chapter 1.4.2.5). The storage volume is approximately 5 l.

The toolbox is placed on the working surface and jammed by the handle.

1.4.2.3 Helium Bottle Holder

The helium bottle holder allows you to carry a helium reservoir and a spray gun with the UL1000 and UL1000 Fab. Only small and midsize bottles (max 10 l, 200 bar) will fit without influencing the stability of the UL1000 and UL1000 Fab.

1.4.2.4 ESD Mat

This mat is put on the working surface of the UL1000 and UL1000 Fab and is clamped and grounded by the inlet port ring. It avoids electrical discharges between the working surface and sensitive test parts.

1.4.2.5 RC1000 Remote control

The RC1000 is a wireless remote control that allows to operate the UL1000 and UL1000 Fab from distance up to 100 m. It provides the functions START, STOP/VENT, ZERO and speaker volume, and displays leak rate in bargraph or in chart mode. (see also Technical Handbook RC1000.)

Measured values can be stored in an internal memory for up to 24 hours of recording time. The data can easily be downloaded to a USB stick to save it.

An internal trigger can be set to provide a warning if the limit leak rates are exceeded. An optical warning is shown on the display and an acoustic warning signal is sounded on the integrated loudspeaker or the connected headphones.

The RC1000 remote control is housed in a robust housing to enable ergonomic working. Magnets on the underside of the unit enable it to be attached to horizontal or vertical metal surfaces.

The RC1000 also enables remote operation of the leak test device in question using a connection cable of up to 28 metres in length.

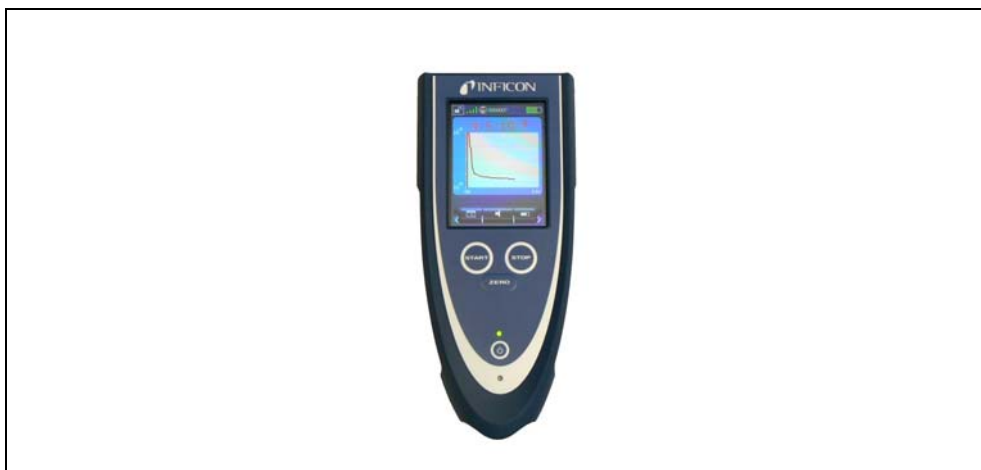

Fig. 1-3 RC1000 wireless remote control

1.4.2.6 Test chamber TC1000

This test chamber turns the UL1000 / UL1000 Fab into a workstation to test hermetically sealed components.

Testing according to MIL-STD 883 can be done easily, fast and accurate. The test starts automatically when the chamber lid is closed, test parameters like cycle time and rejectant level can be set in the menu Auto Leak Test (see 6.6.1.6). The test cycle runs automatically, the test result is also displayed by red / green LEDs directly at the chamber.



Fig. 1-4 Test chamber TC1000

2 Installation

2.1 Transportation



Caution

The UL1000 and UL1000 Fab is not equipped with any crane eyes and must therefore not be transported using lifting equipment.



Warning

The UL1000 and UL1000 Fab must only be pushed or pulled along using the handle provided for this purpose. Don't use the handle to lift.



Caution

Your feet can be pinched.
Keep your feet away from the rollers. .



Caution

Your feet can be run over.
Do not pull the unit, push it



Caution

When transporting over longer distances the original packaging must be used. The castors must not be fixed when the UL1000 and UL1000 Fab is shipped in a crate.

UL1000 Fab with Triscroll TS 620

For transportation the chassis plate where the pump is mounted on has to be secured by a transportation fixing.

This transportation fixing consists of 2 screws at chassis of the UL1000 Fab (one on each side).

To get access to these screws remove the side covers of the UL1000 Fab.

There are orange labels on the bottom part pointing to the screws:



Fig. 2-1

For transportation fixing the screws are tightened to the chassis plate. For operation of the UL1000 Fab the screws should be loosened.

To loosen the screws first loosen the counter nut that is accessible from underneath:

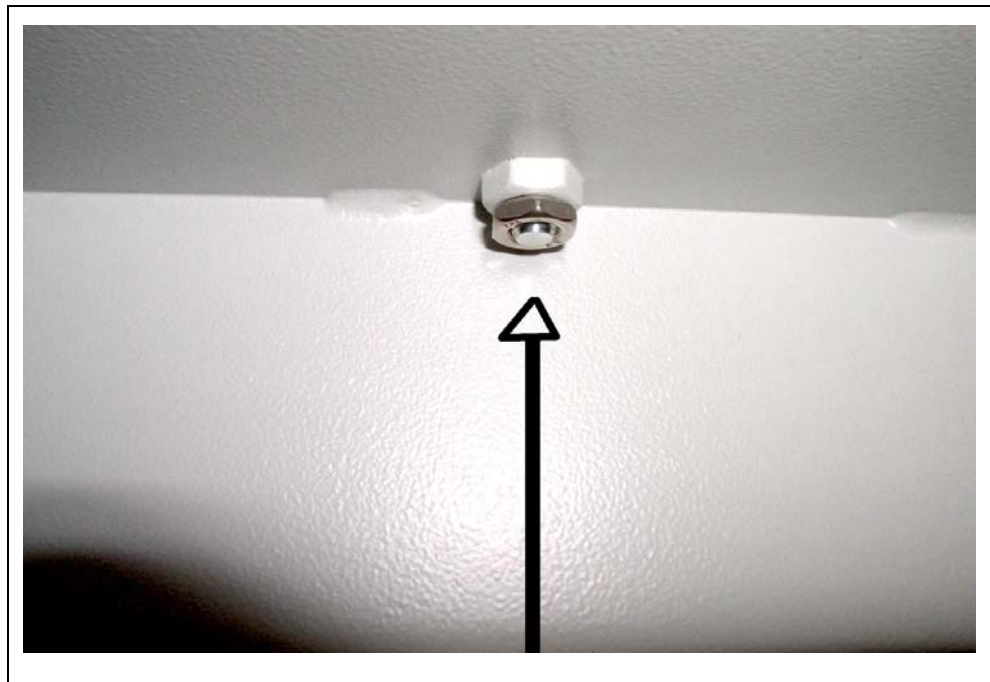

Fig. 2-2

Loosen the screws approximately 10 mm above the chassis plate and tighten then the counter nuts again:



Fig. 2-3

For transportation tighten the screws again and fix them by the counter nuts.

2.2 Working Location

Move the UL1000 and UL1000 Fab to the desired position and arrest the castors.



Danger

Caution: Exhaust gases and fumes:

Exhaust gases and fumes from oil-sealed pumps may be harmful to health.

For operation in poorly ventilated rooms, an exhaust pipe should be connected to exhaust connection 5 depending on the application and gases used.



Caution

Make sure that you can always reach the mains plug.



Warning

The UL1000 and UL1000 Fab must not be operated while standing in water or when exposed to drip water. The same applies to all other kinds of liquids.



Warning

Avoid contact with bases, acids or solvents as well as exposure to extreme climatic conditions.



Warning

The UL1000 and UL1000 Fab is designed for indoor use only.



Caution

Ensure a sufficient air cooling. The air inlet as well the air discharge openings must never be obstructed.



Caution

The UL1000 and UL1000 Fab can be locked by arresting the castors of the front wheels to avoid movements on skewness.

It is recommended that you check all major helium sources in the vicinity of the UL1000 and UL1000 Fab within a radius of about 10 m for the presence of any big leaks. You may use the sniffer probe for this.

2.3 Electrical Connections

2.3.1 Mains Power

Notice: Generally the local regulations for electrical connections must be observed.



Warning

Before connecting the UL1000 and UL1000 Fab to the mains you must make sure that the mains voltage rating of the UL1000 and UL1000 Fab coincides with the locally available mains voltage. The instrument must exclusively be connected to a single phase supply with fuses for installation (Circuit breaker 16A max. according to IEC/EN 60898 with tripping characteristic B).

The mains voltage rating for the UL1000 and UL1000 Fab can be read off from the name plate beneath the mains socket [Fig. 2-6/7](#) at the back side. This voltage is fixed and can not be changed.

A separate fuse for each of the mains conductors has been integrated into the mains switch.

The mains voltage is applied to the instrument via the detachable mains cable which is supplied with the instrument. A mains socket [Fig. 2-6/7](#) is available for this purpose at the back side of the instrument.



Danger

Caution: mains voltage:
Improperly grounded or fused products can lead to fatal injuries.
Only 3-core mains cables having a protection ground conductor must be used.
Operation of the UL1000 and UL1000 Fab where the ground conductor has been left unconnected is not permissible.

Notice: The cable can be secured like shown in the following Figure.



Fig. 2-4 secure fixture power cord

Notice: If the machine is not operating the cable can be stored at the cable holders.



Fig. 2-5 storing power cord

2.3.2 Connections for the Data Acquisition Systems

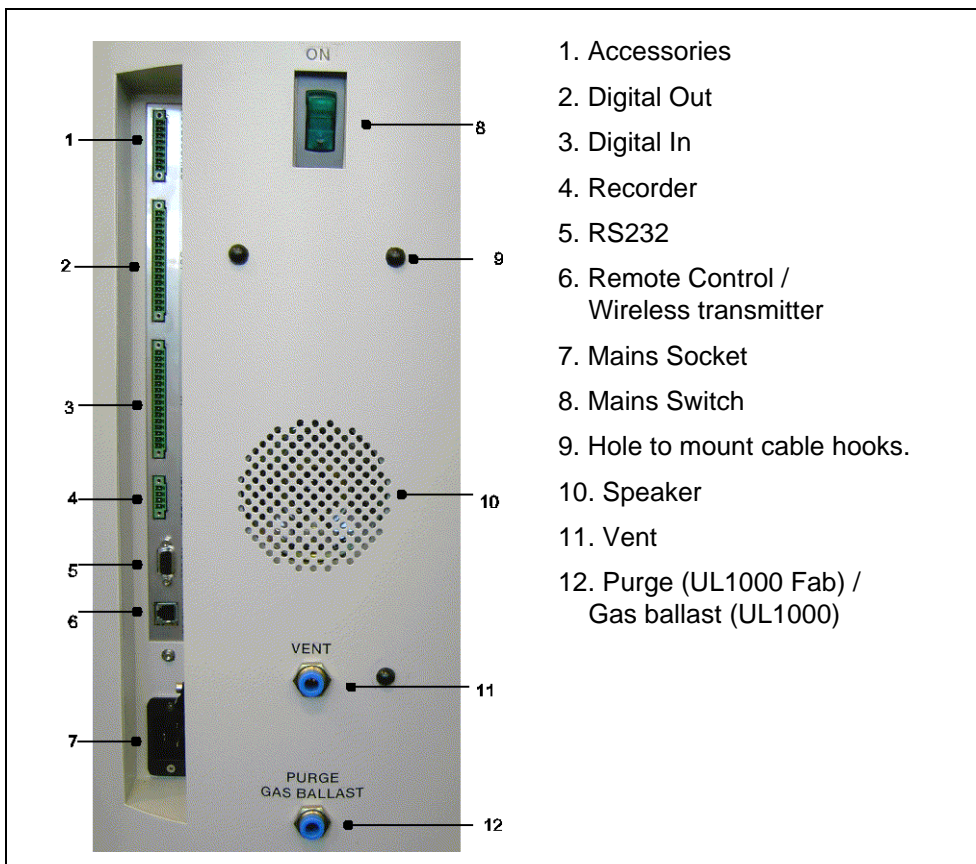

Fig. 2-6

Tip The sockets: Accessories, Digital Out, Digital In and Recorder have pin 1 on top. The pin numbers are counted downwards. The socket 2 and 3 are coded mechanically to avoid a confusion with the counter plug. For the connection with the counter plug (set of plugs 20099024) remove the plastic pins at the plug, accordingly the plug fits the socket.

Tip The connections for external devices are safely separated from the mains and safe low voltage.

Caution

The electronic of the device can be destroyed. So just connect devices to the leak detector that are separated from the mains.

Caution

Just connect devices that don't exceed 25V AC/Amp.

2.3.2.1 Accessories

The following accessories may be connected to the sniffer line SL200 (Please refer to Chapter Fig. 2-6/1) or the test chamber TC1000:

Contact pins 1 and 3 are fused with a 0.8 A slow-blow fuse. The amount of power which can be drawn is limited to 10 W. The contacts are numbered from top to bottom.

Pin	Assignment
1	+24 V, constantly applied, power supply for the sniffer line SL200.
2	GND24
3, 6	Input
4, 5, 7, 8	Output

2.3.2.2 Digital Out

The following relay outputs are available for further signal processing. The maximum rating for the relay contacts is 60V AC/1A.

Pin	Assignment
1	+24V, bridged with pin 1 of socket „Digital In“
2	GND_24V
3	Trigger 1
4	Trigger 2
5	Free
6	Zero active
7	Ready
8	CAL active
9	Cal request
10	Error
11	Warning
12	Purge
13	Measure
14	Recorder Strobe
15	Common dig. out
16	Free

Description of the operation mode of the Digital Out.

Trigger 1:

Is open in case Trigger Level 1 is exceeded or the machine is not in condition of measuring.

Trigger 2:

Is open in case Trigger Level 2 is exceeded or the machine is not in condition of measuring.

Zero active:

Is closed in case Zero function is running.

Ready:

Is closed in case machine is ready for measurement (Emission on, no error).

CAL active

Closed when machine is in calibrating routine.

CAL Request

Is open in case of calibration request. During external calibration a open output indicates that the external calibrated leak has to be closed.

Error

Open when an error is shown.

Warning

Open when a warning is shown.

Purge

Closed when purge is active.

Measure

Closed in case a machine is in measure mode.

Recorder Strobe

Closed in case recorder output is invalid. Only used when record output is set on „leak rate“.

2.3.2.3 Digital In

These inputs can be used to control the UL1000 and UL1000 Fab with a programmable logic control (PLC).

Pin	Assignment
1	+24V, bridged with pin 1 of socket „Digital Out“
2	GND_24V
3	Start
4	Stop
5	Zero
6	CAL
7	Clear
8	Purge
9	Free
10	Free
11	Common dig
12	Free
13	Free
14	Free
15	Free
16	Free

Description of operation mode of the Digital In.

Zero:

Change from low to high: activate zero

Change from high to low: deactivate zero

Start:

Change from low to high: activate START

Stop:

Change from low to high: activate STOP

When this inlet is longer high than announced in chapter [6.6.1.2](#) then ventilate it additionally.

Purge:

Change from low to high: activate purge

Change from high to low: deactivate purge

Clear:

Change from low to high: confirm error message

CAL:

Change from low to high:

When machine is in stand-by mode: start internal calibration. In case machine is in measurement mode: start external calibration. (Premise: external calibration test leak has to be open and leak rate signal is stable)

Change from high to low:

External calibration: approve that external test leak is closed and leak rate signal is stable.

High means: $U > 13 \text{ V}$ (approximately 7mA)

Low means: $U < 7 \text{ V}$

The level of the logic signals must not exceed 35V.

Notice: Signals at these inputs are only accepted if the location of control is set to „PLC“ or „Local and PLC“. Refer to Chapter 6.6.4.1

2.3.2.4 Recorder

The recorder output see Fig. 2-6/4 may be used to log the leak rate, the inlet pressure and the forevacuum pressure.

The measured values are provided by way of an analogue signal in the range of 0 V ... 10 V. The resolution is limited to 10 mV. The instrument which is connected to the recorder output (e. g. X(t) chart recorder) should have an input resistance of no less than 2.5 k Ω . The measured values are available through pins 1 and 4. The reference potential (GND) is available at pins 2 and 3. The contacts are numbered from top to bottom.

Tip A diagram showing pressures and leakrate versus voltage is attached in the appendix.

Notice: The chart recorder outputs are electrically isolated from other plugs. If, in spite of this, hum interference is apparent it is recommended to operate the UL1000 and UL1000 Fab and the chart recorder from the same mains phase. If this is not possible, you must make sure that the frame ground of both instruments is kept at the same potential.

Pin	Assignment
1	Analog 1
2	GND
3	GND
4	Analog 2

2.3.2.5 RS232

This RS232 C interface Fig. 2-6/5 is wired as data communication equipment (DCE) and permits the connection of a personal computer (PC) for monitoring and data logging. The connection is made through a 9 pin sub-D socket. For more information refer to the Interface Description.

Pin	Assignment
2	RXD
3	TXD
5	GND
7	RTS
8	CTS

2.3.2.6 Remote Control

This Remote Control interface Fig. 2-6/6 is a serial interface to control the UL1000 and UL1000 Fab by the RC1000. The RC1000 Remote Control can be connected via the wireless transmitter or via an extension cable with a RJ45 plug. Refer to the RC1000 Technical Handbook for more information.

Pin	Assignment
2	+24V (fuse 0.8 A time lag)
3	0 V
4	RXD (intern. RS232)
5	TXD (intern. RS232)

2.4 Vacuum Connections

2.4.1 Inlet Port

The inlet port is located on the top of the UL1000 and UL1000 Fab. The size of the flange is DN 25 KF.



Warning

Risk of injury due to sucking connection flange.
If the Vacuum-Mode of the UL1000 is activated, the connection flange may suck bodily parts around the connection flange. Keep bodily parts off the connection flange.

A test object or a test chamber has to be connected to the inlet port if the vacuum mode is chosen (See Chapter 6.3).

The inlet port is also used for the connection of the sniffer line.

2.4.2 Exhaust

The exhaust [Fig. 2-6/12](#) flange is located underneath the UL1000 and UL1000 Fab at the back side. The size of the flange is DN 16 KF.



Warning

Depending on the chamber the UL1000 and UL1000 Fab is attached to and the gas inside the chamber lethal gases can be spoiled into the air through the exhaust.

When shipped only the exhaust filter body is preassembled. The filter cartridge is supplied together with the leak detector and can be installed at the exhaust. Instead of this an exhaust line can be connected to the exhaust by the exhaust adapter.

2.4.3 Vent

Usually the parts under test are vented with ambient air when the test is finished. If it is required the parts can be vented with a different gas (i. e. fresh air, dry air, nitrogen, ...) at max. 1050 mbar pressure. In this case a vent hose has to be connected to the hose coupling [Fig. 2-6/10](#).

2.4.4 Purge-connection (UL1000 Fab) / Gas ballast (UL1000)

For purge modes it is recommended to use Helium-free gases at atmospheric pressure. Ambient air can be contaminated with Helium due to spraying or charging. In this case a gas supply line (i. e. nitrogen, fresh air, ...) should be connected to the hose coupling [Fig. 2-6/11](#). The pressure of these gas line must not exceed **1050 mbar**.

The connector 11 and 12 in [Fig. 2-6](#) are quick connectors for hose diameters of 8/6 mm.

2.5 Default parameters

The following parameters are set like shown when in the menu of the UL1000 and UL1000 Fab under Settings → Parameters load/save, „load default values“ is chosen.

Auto-scaling:	On
Scaling	logarithmic
Display range:	4 decades
Time axis:	32 seconds
LCD invers:	OFF
Background in stand by mode:	OFF
Automatic calibration request:	OFF
Mass:	4 (helium)
Recorder Output:	leak rate
Volume:	2
Leak rate unit:	mbar l/s
Mode:	Vacuum
Trigger level 1:	1E-9 mbar l/s
Trigger level 2:	1E-8 mbar l/s
Leak rate external test leak (Vacuum):	1E-7 mbar l/s
Leak rate external test leak (Sniffer):	1E-5 mbar l/s
Vent delay:	2 seconds
Automatic purge:	OFF
Pressure unit:	mbar
Minimum volume:	0
Beep:	ON
Maximum evacuation time:	30 minutes
Audio Alarm Typ:	Trigger Alarm
Maximum inlet pressure when sniffing:	1 mbar
Minimum Inlet pressure when sniffing:	0,1 mbar
Number of decimal place at leak rate displayed:	1
Scroll display:	On
Particle protection:	Off
Direct access to calibration:	On
Contamination protection:	Off
Switch off limit for contamination protection:	1E-3 mbar l/s
Control location:	Local
Alarm delay:	30 seconds
Leak rate filter:	l•Cal
Zero:	enabled

3 First Operation Check

The steps for an initial operation are described in this chapter. It is explained how to switch on the UL1000 and UL1000 Fab, how to measure and how to carry out an internal calibration.

Notice: If anything unexpected happens during the initial operation or the leak detector acts in a strange way the UL1000 and UL1000 Fab can be switched off by the mains switch at any time.

3.1 Needed Equipment

The following parts will be needed:

- A blind flange 25 KF (if not preassembled at the inlet port).
- A helium test leak with a DN 25 KF adapter (optional).

3.2 Description of the Initial Operation

Please proceed the following description step by step to start the initial operation. Refer to Chapter 5 [Operation of the UL1000 and UL1000 Fab](#) for a more detailed description.

3.2.1 Start up and Measure

- 1 Unpack the UL1000 and UL1000 Fab and inspect it for any external damage (Refer to Chapter 1.4 [Unpacking](#)).
- 2 Connect the instrument to the mains power (Refer to Chapter 2.3.1 [Mains Power](#)).
- 3 Switch on the leak detector by using the mains switch [Fig. 2-6/8](#).



Warning

Caution: Abrupt movements.
 Abrupt movements can damage the running turbo pump.
 Avoid abrupt movement and vibration of the instrument (e.g. running over cables, door sills) during operation and up to 4 minutes after switching off since the turbo pump can be damaged.



Caution

Don't switch the UL1000 and UL1000 Fab on when ambient temperature is below 10°C.

After power on a welcoming picture appears on the screen of the control panel Fig. 3-1/1, then status information on the speed of the turbo pump, the foreline pressure, the emission and the active filament are given.

The start up procedure takes about 3 minutes and the end is indicated by a beep. The UL1000 and UL1000 Fab is in Stand-by mode now.



Fig. 3-1: Top view of the Standards

Pos.	Description	Pos.	Description
1	Control Panel	2	Inlet Port

- 4** Check if the inlet port Fig. 3-1/2 is blanked off. If not, please mount a blind flange with O-Ring on the inlet port.
- 5** Press the **START Button** Fig. 3-2/6. The inlet will be evacuated and the measured leak rate will be displayed a moment later.

This is the measurement mode. If a test part was connected you would start spraying Helium to identify leaks.



Fig. 3-2: Control Panel

Pos.	Description	Pos.	Description
1	LC Display	8	Soft Key no. 5
2	Soft Key no. 1	9	Soft Key no. 6
3	Soft Key no. 2	10	Soft Key no. 7
4	Soft Key no. 3	11	Soft Key no. 8
5	Soft Key no. 4	12	MENU Button
6	START Button	13	STOP Button
7	Control Panel	14	ZERO Button

- 6** To correct for any background signal (residual Helium in the part under test) you may press the **ZERO Button** Fig. 3-2/14. To undo **ZERO** please press the **ZERO Button** for 2 ... 3 seconds.
- 7** Press the **STOP Button** Fig. 3-2/13, the Standards will go to Stand-by. If you press **STOP** a few seconds the inlet of the Standards will be vented.
- 8** To finish the startup procedure please proceed with #16. For calibration proceed with #9.

3.2.2 Internal Calibration

- 9** Proceed the internal calibration (Please refer to Chapter [7.2.1 Internal Calibration](#)). For better quantitative measurements please allow the unit to warm up (15 ... 20 minutes).
 - Press **Calibration** (Soft Key no. 5 [Fig. 3-2/8](#)) to get into the calibration menu.
 - Select *internal* (Soft Key no. 4 [Fig. 3-2/5](#)) to choose the internal calibration.
 - Select *automatic* (Soft Key no. 8 [Fig. 3-2/11](#)). The automatic procedure of the internal calibration is started and takes about 30 seconds.
- 10** Press the **STOP Button** [Fig. 3-2/13](#) until the message *STAND-BY/VENTED* appears on the display. The inlet is vented now.

3.2.3 Verification

To verify the accuracy please proceed through the following steps. A test leak is required. If a test leak is not available please continue with #16.

- 11** Remove the blind flange from the inlet port and connect the open helium test leak to the inlet port.
- 12** Press the **START Button** [Fig. 3-2/6](#) again. The inlet will be evacuated and the leak rate of the test leak will be measured and displayed.
- 13** Press the **STOP Button** [Fig. 3-2/13](#) to interrupt the measurement. The Stand-by mode will be displayed.
- 14** Press the **STOP Button** [Fig. 3-2/13](#) again until the message *STAND-BY vented* appears on the display. The inlet is vented now.
- 15** Remove the helium test leak from the inlet port and put a blind flange onto the inlet port again.
- 16** Switch off the leakdetector by using the mains switch [Fig. 2-6/8](#).
The first operation is finished.

4 Description and Working Principle

4.1 Introduction

The UL1000 and UL1000 Fab basically is a helium leak detector for vacuum applications, i.e. the part under test is evacuated while the test is performed. The vacuum is achieved with a pumping system that is part of the UL1000 and UL1000 Fab. In addition the vacuum can be generated by pumps with are set up in parallel to the leak detector.

Another operating mode of the UL1000 and UL1000 Fab is the Sniff mode which can only be used when a sniffer line (See Chapter [1.4.2 Accessories and Options](#)) is hooked up.

4.2 Components of the UL1000 and UL1000 Fab

The UL1000 and UL1000 Fab is a self-contained unit in a metal housing on wheels. This housing contains the entire vacuum system and the according power supplies. On top of the unit is the inlet port and the display.

4.2.1 Vacuum System

The vacuum diagram below shows the major components inside the UL1000 and UL1000 Fab:

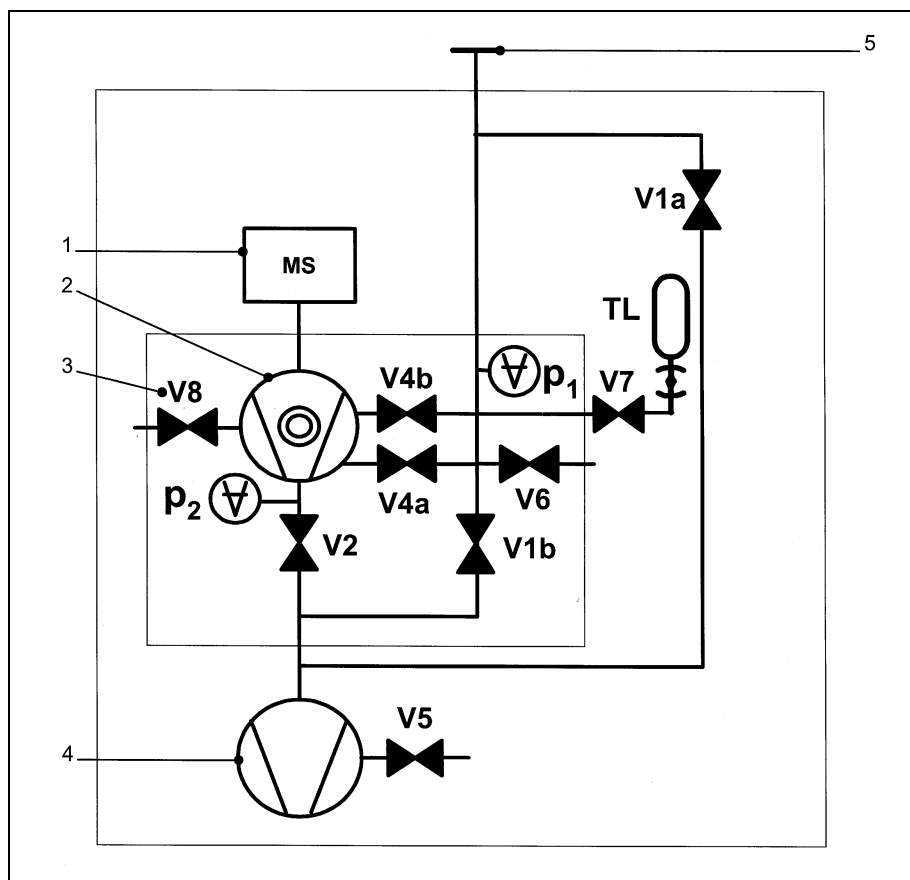

Fig. 4-1: Vacuum Diagram UL1000 and UL1000 Fab

Pos.	Description
1	MS: Mass Spectrometer, Helium sensor (180° magnetic field mass spectrometer)
2	Turbomolecular Pump (TMP, provides high vacuum conditions in the MS)
3	V1a ... V8: Electromagnetic Valves to control the gas flows
4	Scroll pump (provides the foreline pressure for the TMP and pumps down the parts under test)
5	Inlet Port

The mass spectrometer is mainly composed of the ion source, the magnetic separator and the ion collector.

Gas molecules getting into the mass spectrometer are ionized by the ion source. These positively charged particles are accelerated into the magnetic field following a circular path, the radius of which depends on the mass-to-charge ratio of the ions. Only helium ions can pass this filter and reach the ion collector where the stream of the ions is measured as a electrical current.

For operation the mass spectrometer requires a vacuum level in the range of 1×10^{-4} mbar and lower. This pressure is provided by the turbomolecular pump which in turn is backed up by a scroll pump.

Besides maintaining the pressure in the mass spectrometer the pump system is used to evacuate the test parts. It is made sure that the pressure in the mass spectrometer is low enough under all circumstances. The valves V1a, V1b, V2, V4a, V4b control the gas flows when measuring. Valves V5 (only UL1000), V6, and V8 are used to vent the system and the Turbo pump. Valve V7 opens and closes the internal test leak during calibration.

With the pressure in the test part being lower than ambient pressure sprayed helium can penetrate into the part in case of a leakage. As soon as the pressure conditions allow it one of the valves to the TMP opens. Now Helium can penetrate into the mass spectrometer contrary to the pumping direction of the TMP.

See Chapter 4.3 Working Modes for details.

4.2.2 Control Panel

The Control Panel Fig. 4-2/7 contains a liquid crystal display (LC Display), the *START*, *STOP*, *ZERO* and *MENU* buttons and also eight Soft Keys for the different menus and inputs.

The control panel itself is rotatable.



Fig. 4-2: Control Panel

Pos.	Description	Pos.	Description
1	LC Display	8	Soft Key no. 5
2	Soft Key no. 1	9	Soft Key no. 6
3	Soft Key no. 2	10	Soft Key no. 7
4	Soft Key no. 3	11	Soft Key no. 8
5	Soft Key no. 4	12	MENU Button
6	START Button	13	STOP Button
7	Control Panel	14	ZERO Button

4.2.2.1 LC Display

The [LC Display Fig. 4-2/1](#) is the communication interface to the operator. It displays the leak rates, the status report of the machine, messages, warnings and errors.

4.2.2.2 START Button

Pushing the [START Button Fig. 4-2/6](#) enables the UL1000 and UL1000 Fab to start the measure procedure. If the START button is pushed again in measurement mode, the maximum leak rate indicator („hold“ function) is activated. This indicator shows the maximum leak rate since „START“. By pressing the START-button again the „hold“ function will be started.

4.2.2.3 STOP Button

Pushing the [STOP Button Fig. 4-2/13](#) interrupts the measure procedure. If the button is pressed longer the inlet is vented according to the conditions defined in the menu [Vent delay](#). Please refer to chapter [6.6.1.2 Vent delay](#) to select the time parameters of the venting.

4.2.2.4 ZERO Button

Pushing the [ZERO Button Fig. 4-2/14](#) enables the zero mode.

When pressing ZERO the currently measured leak rate is taken as a background signal and is subtracted from all further measurements. As a result the displayed leak rate then is

- 1×10^{-6} in *GROSS*
- 1×10^{-10} in *FINE*
- 1×10^{-12} in *ULTRA*

To reverse the ZERO function please keep the button pressed for about 3 seconds.

After pressing ZERO the decreasing background is fitted to the course automatically. So it is possible to recognize leaks even when the signal is decreasing rapidly.

Please also refer to the pictures below.

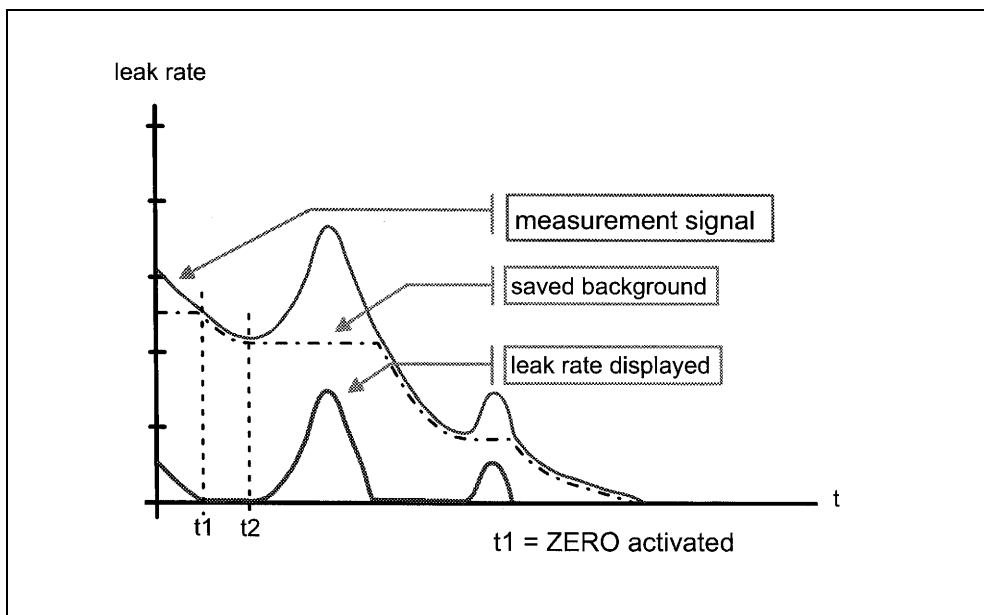

Fig. 4-3 decreasing background

When the measurement signal declines below the saved underground value the underground value will automatically be equated with the measurement signal. As soon as the measurement signal is increasing again the saved decreasing value remains constant. Increasing of the signal are displayed clearly as a leak.

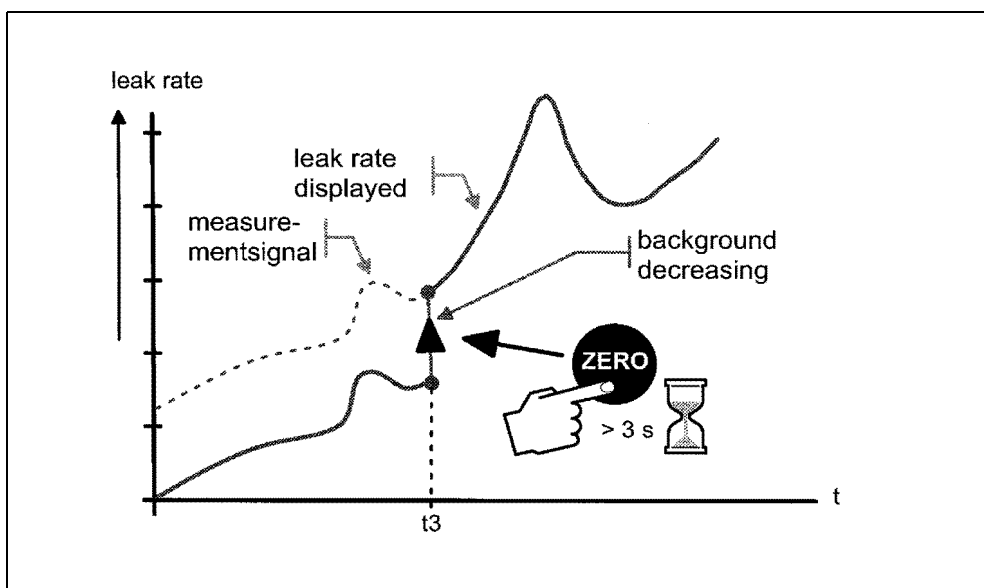

Fig. 4-4 undo ZERO

When you want to see the measurement signal (including underground) please press the ZERO button about 3 seconds. The saved value will be reset to zero. The underground signal will not be suppressed anymore.

Notice: The ZERO functions can be selected to a special mode that allows to use it only when the signal of the falling background becomes stable (see Chapter 6.6.2.2).

4.2.2.5 MENU Button

When pressing the MENU button (Fig. 4-2/12) the selecting menu is shown at the display. This function is not depending on the operating mode when calibrating.

If the menu is opened during the current session the operator will lead to the last screen before the menu was left.

Pushing the *MENU* button again leads back to the screen of the previous working mode. The software shows the last screen that was used before.

4.2.2.6 Soft Keys

The function of the eight Soft Keys Fig. 4-2/2 ... /5 and /8 ... /11 depends on the current menu. Only key 1 and 8 very often have the functions *Back/Cancel* (Softkey no. 1) and *OK* (Softkey no. 8.).

Special Functions

When inputs are allowed or when settings can be selected in a submenu two of the Soft Keys always have the same function:

- Soft Keys no. 1 Fig. 4-2/2 is *Cancel*.

It allows to escape from the submenu without any changes of the present settings and return to the previous menu page.

- Soft Keys no. 8 Fig. 4-2/11 is *OK*.

The selected settings or edited values will be stored and the previous menu page will be displayed again.

4.2.2.7 Numerical Entries

If you have opened a menu page where a number can be changed please proceed in the following way:

- If you don't want to change anything, press Soft Key no. 1 *Cancel*.
- The digit that can be changed is displayed inverted. With the arrows \rightarrow (Soft Key no. 8) and \leftarrow (Soft Key no. 4) you can choose which digit you need to change.
- To change a digit to a specific number press the corresponding pair of numbers. A submenu opens and the desired number can be selected. The submenu closes automatically and the next digit of the total number now is inverted.

Having reached the last digit all corrections have to be confirmed by *OK* (Soft Key no. 8).

Example

To change the trigger level 1.0×10^{-7} mbar l/s to 3×10^{-7} mbar l/s please press 2/3 (Soft Key no. 3) Fig. 4-5.

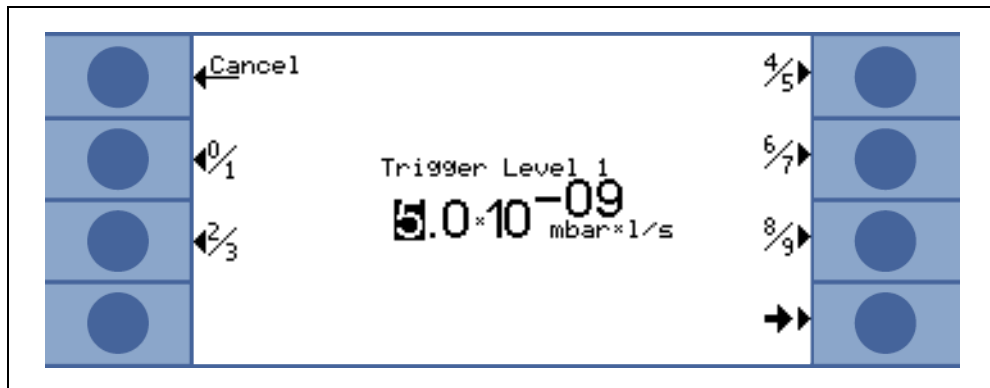

Fig. 4-5: Numerical entry of the [Trigger Level 1](#)

In the submenu press 3 (Soft Key no. 4) [Fig. 4-6](#).

4.3 Working Modes

4.3.1 Vacuum Mode

As mentioned (Please refer to Chapter 4.2.1 Vacuum System) the sample has to be evacuated to allow Helium which is sprayed on the outside to enter through any leaks due to the pressure difference.

When pressing the **START Button** Valves V1a and V1b open and the sample is pumped down by the roughing pump (UL1000) or scroll pump (UL1000 Fab). At the same time valve V2 is closed to avoid an unacceptable pressure increase in the turbo pump and the mass spectrometer. With valve V2 being closed the turbomolecular pump is operated without being backed up by the scroll pump. Since the mass spectrometer is already under vacuum no further gas is pumped. Thus the pressure p_2 remains constant or increases only slowly.

If the pressure p_2 even though increases (e.g because of a very long pumping down process), then the evacuation will be broken (V1a and V1b closed) at $p_2 > 10$ mbar and V2 will open shortly to restore an appropriate foreline ($p_2 < 1$ mbar).

The following diagrams show the gas flow during evacuation and during the modes GROSS, FINE and ULTRA.

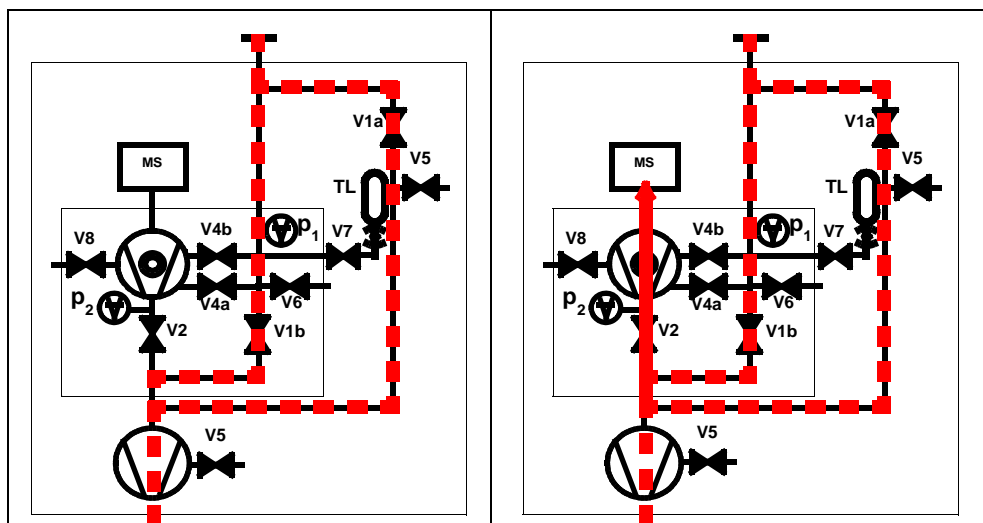

Fig. 4-6: left: Evacuation (no measurement), right: GROSS Mode

The condition for the evacuation process described is maintained until the inlet pressure p_1 has dropped below 15 mbar. Now valve V2 opens. Possibly present helium may now flow upstream against the pumping direction of the turbo molecular pump into the mass spectrometer where it is detected. This mode is called GROSS, the detection limit is 1×10^{-6} mbar l/s.

Since the scroll pump continues to evacuate the test sample the inlet pressure p_1 will continue to drop. Below 2 mbar the UL1000 and UL1000 Fab will switch to FINE mode, i.e. V4a will open and V1b will close. The gas stream enters the turbo pump at an intermediate level. The sensitivity of the system now is higher, the detection limit is 1×10^{-10} mbar l/s.

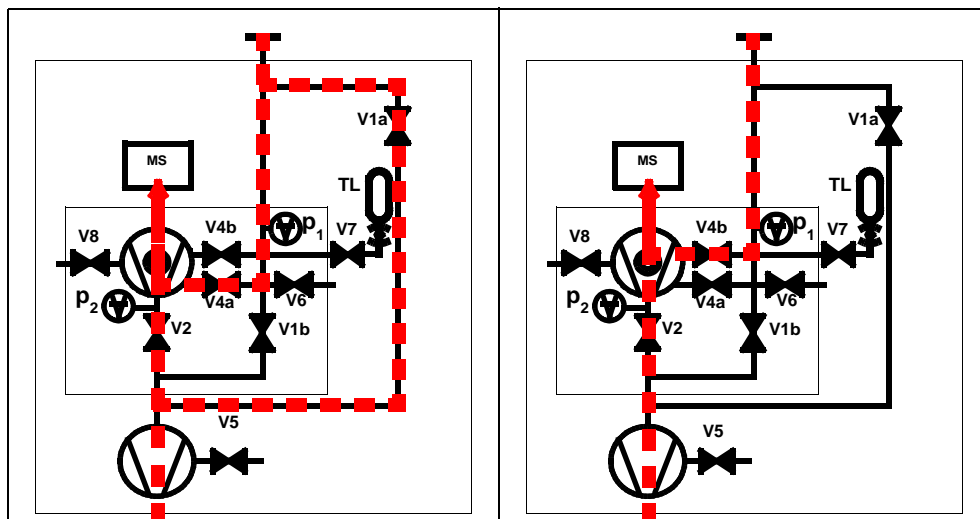

Fig. 4-7: left: FINE Mode, right: ULTRA Mode

Now the lower part of the turbo pump further evacuates the sample and after the pressure p_1 has reduced below 0.4 mbar the UL1000 and UL1000 Fab switches into ULTRA mode, i.e. V1a and V4a close and V4b opens. The entrance into the turbo pump is on a higher level now. The pumping speed at the inlet port is now 2.5 l/s, the detection limit is 5×10^{-12} mbar l/s.

Tipp A special set up of the UL1000 and UL1000 Fab stops the autoranging procedure as described above. With the mode *FINE ONLY* (Please refer to Chapter 6.3 Mode) the unit will stay in FINE Mode Fig. 4-7 (left) regardless the inlet pressure. The valve V1a is closed.

4.3.2 Sniffer Mode

In sniff mode a sniffer line (preferably the INFICON standard sniffer line 14005) is connected to the inlet port. When pressing the **START Button** the system starts to pump air through the sniffer line. Due to the constant gas flow through the sniffer line the software will range directly into FINE mode and stay there. The inlet pressure will not drop further down. By measuring the inlet pressure the system software makes sure that the flow through the sniffer line is at the right level. Otherwise warning messages are generated. The detection limit in sniff mode is $<1 \times 10^{-7}$ mbar l/s.

INFICON's sniffersystem QT100 may also be used to sniff. Since the QT100 provides a lower inlet pressure it is recommended to keep the system in vacuum mode to avoid a wrong generation of pressure warnings. The machine factor has to be adjusted to value 400.

4.3.3 Auto Leak Test Mode

In this mode the test of hermetically sealed testing objects can be performed automatically. By use of the optional test chamber TC1000 this test mode starts automatically when closing the chamber lid. Fast test results within seconds are achieved by using the internal test leak of the UL1000 or UL1000 Fab for a dynamic calibration, matched to the required test cycle. Leak rates in the 10^{-9} mbar l/s range can be detected within 5 seconds.

5 Operation of the UL1000 and UL1000 Fab

The UL1000 and UL1000 Fab is switched on by pushing the mains switch (Please refer to Chapter 3.2.1 [Start up and Measure](#)). After less than 3 minutes, the start up is completed; the leak detector is then ready to be used for measurements (Standby mode).

Please connect the part to be tested to the inlet port and press *START*. The UL1000 and UL1000 Fab starts to evacuate the part. The evacuation time depends on the volume of the test part. During evacuation the screen shows the inlet pressure online.

Once the pressure of 15 mbar (11 Torr or 1500 Pa) is reached the unit switches to measurement mode. The corresponding leak rate is displayed. For further explanations of the screen please refer to [Fig. 5-1](#).

The displayed leak rate corresponds to the helium background concentration in the part under test. Since the UL1000 and UL1000 Fab continues to pump down the part this background leak rate will further reduce. As soon as the leak rate is low enough in respect to your requirements you may start spraying Helium to search for possible leaks.

When you are finished please press *STOP* and hold the button a few seconds to vent the part under test.

5.1 Display

The display is used to either show leak rate signals or program specific set-ups and get information by means of the software menu (Please refer to Chapter 6 [Description of the Menu](#)). In addition messages and maintenance instructions are displayed on the screen (Please refer to Chapter 8 [Error And Warning Messages](#)).

5.2 The Screen in Run-Up Mode

In run-up mode the display shows:

- Speed of the number of revolutions
- Foreline pressure
- State of emission
- Active filament
- A bar graph which shows the run-up progress

Notice: If the display is too bright or too dark you can change the contrast. Please see Chapter 6.2.4. During run-up phase the menu button can be pushed (see Chapter 4.2.2.5) to get to the selection menu.

5.3 Display in stand-by mode

In stand by mode the states are shown in the lower edge of the display (see Chapter 5.4.3). Furthermore calibration (Please refer to Chapter 7) can also be started in stand by mode and purging, too (see Chapter 5.3.1)

5.3.1 Purging

Every time when the UL1000 Fab changes into stand by mode it can start purging automatically after 20 seconds. During this purging the scroll pump is flushed through purge connection (See Fig. 2-6/11).

When the machine is in stand by mode this operation also can be activated manually (Key 7). By pressing the key again the purging will be discontinued. By pressing START the activity will be discontinued, too.

5.4 The Screen in Measurement Mode

In measurement mode the leak rates can be displayed in two different modes:

- Numerically, combined with a bargraph Fig. 5-1
- Trend mode (leak rate versus time) Fig. 5-2

In the lower right corner of the display (next to the Soft Key no. 8) you will find a symbol that allows to switch between the display modes by pressing Soft Key no. 8. Please refer to chapters 5.4.4 Numerical Display Mode and 5.4.5 Trend Mode for explanations of the different display modes.

Access to calibration (Soft Key no. 5) and access to the speaker volume (Soft Keys no. 2 and no. 3) is the same in all modes. Also the status icons in the bottom line are in common in all display modes.

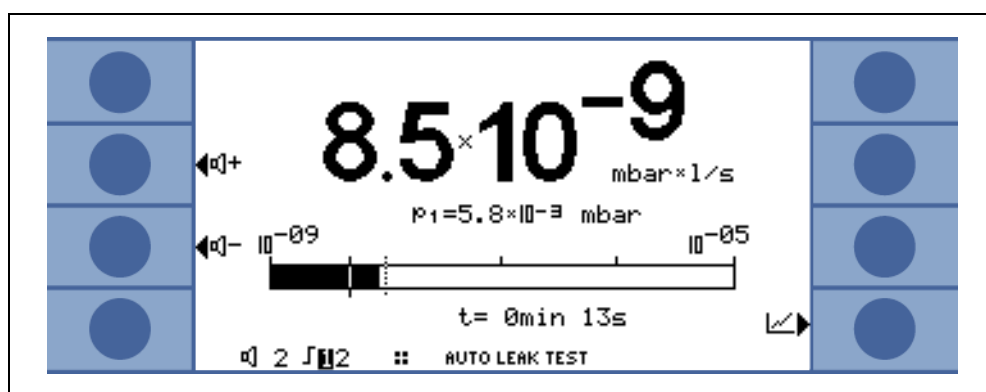

Fig. 5-1: Display, measurement mode

5.4.1 Call for Calibration

In all modes the Soft Key no. 5 is used to get to the calibration routine. Refer to Chapter 7 Calibration for further information regarding calibration.

5.4.2 Speaker Volume

Danger

The hearing can be harmed by the audio alarm.
The accoustic output can exceed a level of 85dB(A).
Do only expose to the audio alarm for a short time or use ear protection.

On the left hand side two loud speaker symbols are shown, combined with the signs + and -. By pressing the corresponding softkeys (Soft Keys no. 2 and no. 3) the volume can be adjusted for convenient loudness. In the bottom line of the display another loud speaker symbol is shown, combined with a number. This number indicates the level of the current loudness (ranges from 0 to 15).

Refer to Chapter 6.4.3 [Volume](#) for information on loudness, alarms, and sound tracks.

5.4.3 Status Line in the Display

The status line at the bottom of the display informs about (reading from left to right):

<i>Symbol of display</i>	<i>Meaning</i>	<i>Explanation</i>
	<ul style="list-style-type: none"> Volume level 	Please refer to Chapter 5.4.2 Speaker Volume .
S1	<ul style="list-style-type: none"> Trigger 1 	If the trigger values are exceeded these signs are inverted. (White on black background.)
S2	<ul style="list-style-type: none"> Trigger 2 	see: Trigger 1
••	<ul style="list-style-type: none"> Detected mass 	Number of dots indicates the mass number (4 dots = Helium, 2 dots = Hydrogen)
	<ul style="list-style-type: none"> Warning triangle 	Please refer to Chapter 8.1
VAC	<ul style="list-style-type: none"> Working mode 	VAC or SNIFF indicate which working mode was selected (Please refer to Chapter 6.3 Mode).
ULTRA	<ul style="list-style-type: none"> Vacuum area 	Depending on the inlet pressure the UL1000 and UL1000 Fab may be in GROSS, FINE or ULTRA, which is indicated here (Chapter 4.3 Working Modes)
ZERO	<ul style="list-style-type: none"> ZERO 	Indicates if ZERO-function is active.
COR	<ul style="list-style-type: none"> corrected leak rate 	Indicates if the leak rate is displayed as air equivalent.
Auto Leak Test	<ul style="list-style-type: none"> Auto Leak Test 	Indicates if this mode is active

5.4.4 Numerical Display Mode

The display shows the leak rate in big digital figures, see Fig. 5-1. The unit of the leak rate is shown, too. Underneath the leak rate the inlet pressure is displayed in smaller digits. The units of leak rate and pressure can be defined in the menu (See Chapter 6.4.4 Units).

Below this the same leak rate is shown graphically as a bar. The scale of this bar, i.e. the number of decades included in this bar can be defined in the menu (Please refer to Chapter 6.2.2 Display-range auto/manual). The programmed trigger levels (Please refer to Chapters 6.4.1 and 6.4.2) are indicated at the bar by short vertical lines: a straight line for trigger 1 and a dotted line for trigger 2.

In addition the inlet pressure is displayed in smaller figures above the bargraph.

5.4.5 Trend Mode

In trend mode the leak rates are displayed over time Fig. 5-2. In addition the actual leak rate and inlet pressure also are displayed digitally. The time axis can be defined in the menu (Please refer to Chapter 6.2.3 Time axis). The intensity axis (y-axis) is defined the same way as the bargraph (Please refer to Chapter 6.2.1 Scale linear/logarithmic ff).



Fig. 5-2: Display, trend mode

6 Description of the Menu

By pressing the MENU push button Fig. 6-1 the main menu will be displayed regardless of the current working mode.

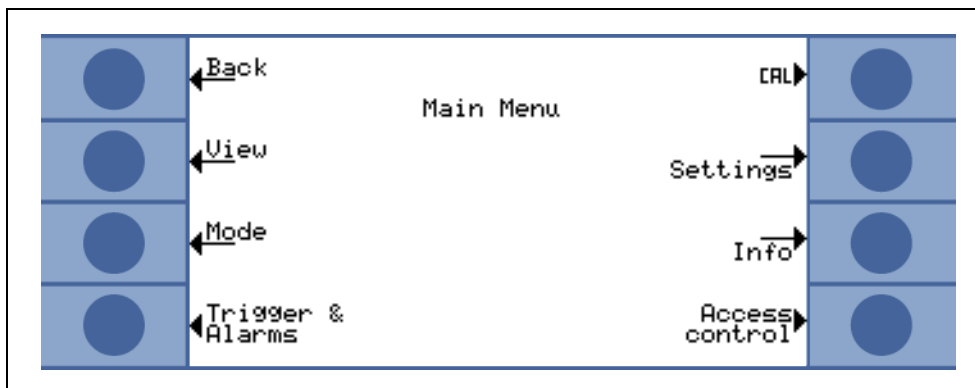

Fig. 6-1: The Main Menu

The main menu Fig. 6-1 leads the operator to several submenus described in the following chapters.

6.1 Main Menu

The main menu shows 7 sub-menus. In these sub-menus groups of technical features are put together logically. From here the next levels of the menu tree can be reached.

Tip All following chapters show the path to get to the described menu line right underneath the headline. This path is indicated by a dot (•).

Key No.	Name	Description
1	Back	Return to the previous screen.
2	View	Display settings like scaling, contrast, system background. Please refer to Chapter 6.2.
3	Mode	Selection of different working modes like Vacuum, Sniff Please refer to Chapter 6.3.
4	Trigger & Alarms	Settings of units, trigger levels and alarms. Please refer to Chapter 6.4.
5	Calibration	Calibration of the UL1000 and UL1000 Fab. Please refer to Chapter 6.5.
6	Settings	Settings of internal machine parameters. Please refer to Chapter 6.6.
7	Information	Information on the UL1000 and UL1000 Fab (electrical and vacuum data) and service menu. Please refer to Chapter 6.7.
8	Access Control	Access restrictions. Please refer to Chapter 6.8.

The next page gives an overview of the entire menu architecture Fig. 6-2.

	1. Level	2. Level	3. Level
Main Menu	View (See 6.2)	Scale linear/logarithmic	
		Display-range auto/manual	
		Time axis	
		Contrast	
		Background in Stand-by	
		Decimal places	
		Lower display limit	
	Mode (See 6.3)	Sniff/Vacuum / Auto Leak Test	
	Trigger & Alarms (See 6.4)	Trigger Level 1	
		Trigger Level 2	
		Volume	
		Units	
		Alarm delay	
	Calibration (See 6.5)	internal	manual
			automatic
		external	Edit leakrate
			Start
	Settings (See 6.6)	Vacuum settings	Automatic purge (UL1000 Fab only)
			Vent delay
			Vacuum ranges
			Leak rate internal test leak
			Machine factor
		Zero & Background	Background Suppression
			Zero
		Mass	
		Interfaces	Control Location
			RS232 Protocol
			Scaling Recorder Output
			Recorder output
		Miscellaneous	Time&Date
	Language		
	Leak rate filter		
Mains Frequency			
Service interval exhaust filter			
Parameter save / load	Service message exhaust filter		
	Load parameter set		
Monitoring functions	Save parameter set		
	Calibration request		
	Particle protection		
	Contamination protection		
	Pressure limits for vacuum ranges		
	Pressure limits for sniff mode		
Information (See 6.7)	Maximum evacuation time		
	View settings		
	View internal data		
	Vacuum diagram		
	View error list		
	Calibration history		
	Calibration factors		
Service			
Access Control (See 6.8)	Access to CAL function		
	Change Device PIN		
	Change Menu-PIN		

Fig. 6-2: Menu structure overview

6.2 View

- [Main Menu > View](#)

In this menu [Fig. 6-3](#) all features that influence the way data are displayed are put together.

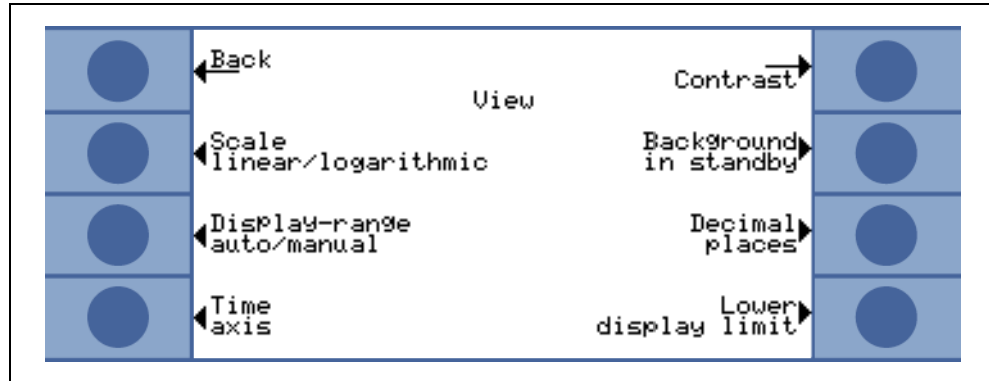

Fig. 6-3: The [View](#) Menu

Key No.	Name	Description
1	Back	Return to the main menu.
2	Scale linear/logarithmic	Settings for bargraph and trend mode. Please refer to Chapter 6.2.1 .
3	Display-range auto/manual	Manual or automatic scaling. Please refer to Chapter 6.2.2
4	Time axis	Time axis in trend. Please refer to Chapter 6.2.3
5	Contrast	Display contrast. Please refer to Chapter 6.2.4
6	Background in Stand-by	Background displayed or not. Please refer to Chapter 6.2.5
7	Decimal places	Number of decimal places. Please refer to Chapter 6.2.6
8	Lower display limit	Choice of electrical filters. Please refer to Chapter 6.6.2

6.2.1 Scale linear/logarithmic

- [Main Menu](#) > [View](#) > [Scale linear/logarithmic](#)

These settings apply to the bargraph (= bar underneath the digital figures in the measurement mode) and Y-axis in the trend mode.

The scale of the bargraph can either be linear or logarithmic. With the arrows (up and down) it can be determined how many decades the bargraph covers.

Usually a logarithmic scale is recommended because leak rates may change easily over several decades.

Softkey 2: Linear

Pressing this key switches the display to a linear scale, starting at zero.

Softkey 3: Arrow down (Number of decades)

Pressing this key reduces the number of displayed decades. The minimum value is 2 decades. Only available if *log* (softkey 6) was chosen.

Softkey 6: Logarithmic

The scaling will be displayed logarithmically.

Softkey 7: Arrow up (Number of decades)

Increase the number of displayed decades. Maximum value is 9 decades. Only available if *log* (softkey 6) was chosen.

6.2.2 Display-range auto/manual

- [Main Menu](#) > [View](#) > [Display-range auto/manual](#)

The upper limit of the displayed leak rate range can be set manually or automatically. These settings apply to the bargraph (=bar underneath the digital figures in the measurement mode and y-axis in the trend mode).

With the upper limit defined here the lower limit is set to a value based on the number of decades (See Chapter [6.2.1 Scale linear/logarithmic](#)).

Softkey 2: Manual

The upper limit of the displayed range can be set manually.

Softkey 3: Arrow down

.Decrease the upper limit if *manual* is chosen. The minimum value is 10^{-11} mbar l/s.

Softkey 6: Automatic

The limit of the displayed range will be chosen automatically.

Softkey 7: Arrow up

Increase the upper limit if *manual* is chosen. The maximum value is 10^{+3} mbar l/s.

Softkey 8:

Save the settings and return to the previous menu.

If linear scale is selected, the lower limit is always zero. The upper limit is only a default value. You can change this on the measurement screen with the Soft Key 6 and 7 if you have chosen manual display ranging.

6.2.3 Time axis

- [Main Menu](#) > [View](#) > [Time axis](#)

The length of the time axis in trend mode can be changed in steps of 16 ... 960 s.

Softkey 3: Arrow down

Decrease the length of the time axis. The minimum time value is 16 seconds.

The time slice is extended during the measurement mode. (Up to max. 960 s) It is displayed automatically during the AUTO mode.

Softkey 5: ?

Help

Softkey 7: Arrow up

Increase the length of the time axis. The maximum adjustable value is 960 seconds.

6.2.4 Contrast

- [Main Menu](#) > [View](#) > [Contrast](#)

The contrast of the display can be changed. The changes are applied synchronously. The recommended value under regular conditions is 50 (or close to it).

Tip If by accident the display has been set too bright or too dark so that it can not be read off, this may be changed as follows:
Switch off the UL1000 and UL1000 Fab and turn it on again. During the run-up phase press the key no. 3 or 7 so long until the display can be read properly again. This setting is saved to the EPROM only after confirming this through the contrast menu. If this setting is not confirmed, the former setting will be applied after switching on the instrument on again.

Softkey 3: Arrow down

Fade the contrast to dark. The minimum values is 0.

Softkey 4: Invert display

Invert the contrast of the screen.

Softkey 5: ?

Help

Softkey 7: Arrow up

Fade the contrast to light. The maximum value is 99.

6.2.5 Background in Stand-by

- [Main Menu](#) > [View](#) > [Background in Stand-by](#)

The internal background leak rate can be displayed in Stand-by mode (ON) or not (OFF). The default setting is OFF.

Softkey 3: Off

The background leak rate will not be shown.

Softkey 5: ?

Help

Softkey 7: ON

The background leak rate will be shown.

The internal background is generated by residual gas (e. g. helium) that has not been pumped away yet. Sources for residual gas are air or absorbed gases from the inner surfaces of the leak detector. This internal background will never disappear totally. Very clean systems which have been pumped for a long time will show a background in the 10^{-11} mbar l/s range. Under normal conditions the background level is in the 10^{-10} mbar l/s or low 10^{-9} mbar l/s range.

When pressing START the current internal background is subtracted from all further measured signals automatically. Thus it is made sure that only the net leak rate from the part under test is measured.

When switched to Stand-by / Vent again a new internal background is calculated after 25 s. The updated value is underlined. This means that if you press START when the value is underlined, the actual background signal will be subtracted. If you press START when the value is not underlined, the old background signal from the last Stand-by will be subtracted.

6.2.6 Decimal places

- [Main Menu](#) > [View](#) > [Decimal places](#)

The number of the decimal places of the displayed leak rate can be chosen. The default setting is 1.

Softkey 3: 1

The leak rate will be displayed with one decimal place.

Softkey 7: 2

The leak rate will be displayed with two decimal places.

Two decimals are especially usefull, when the I•CAL leak rate filter (Please refer to Chapter [6.6.5.3](#)) is used.

6.2.7 Lower display limit

- [Main Menu](#) > [View](#) > [Lower display limit](#)

This parameter defines the lower leak rate limit in the measurement ranges. This is valid for vacuum modes only.

Softkey 3, 7:

Changing of the lower detection limit between 1×10^{-5} and 1×10^{-12}

Softkey 5: ?

Help

6.3 Mode

- [Main Menu](#) > [Mode](#)

The mode menu [Fig. 6-4](#) enables the submenu to select the different working modes.

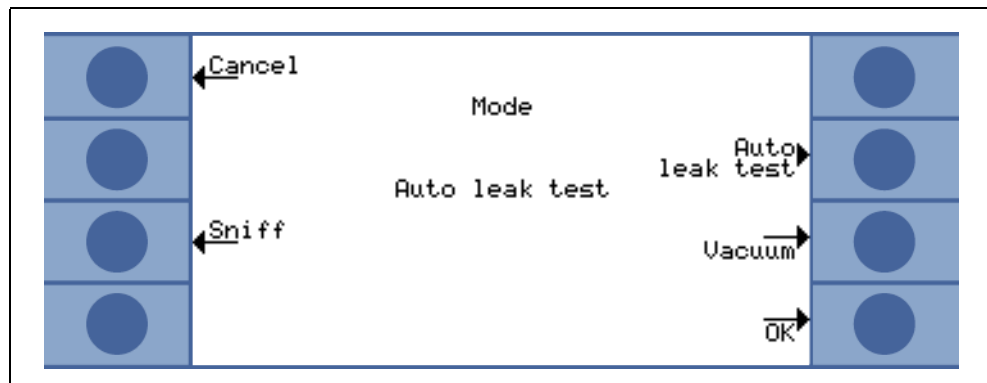

Fig. 6-4: The [Mode](#) Menu

Key No.	Name	Description
1	Cancel	Return to the main menu without any changes of the present settings.
3	Sniff	The normal vacuum mode will be used. See Chapter 4.3.2, sniffer mode.
4		Not used in this menu.
5	Auto Leak Test	See Chapter 4.3.3.
7	Vacuum	The normal vacuum mode is in use
8	OK	Save the settings and return to the previous menu.

6.3.1 Auto Leak Test

- Menu > Mode > Auto leak test

After selecting the Auto leak test mode this message pops up:

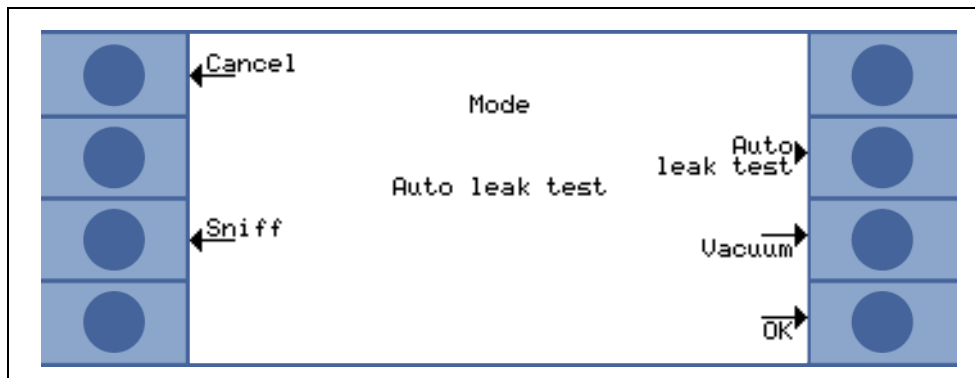

Fig. 6-5

By pressing OK button the settings menu is called (see 6.6.1.6)

Notice: If the UL1000 requests a calibration due to the mode change a calibration message will come up.

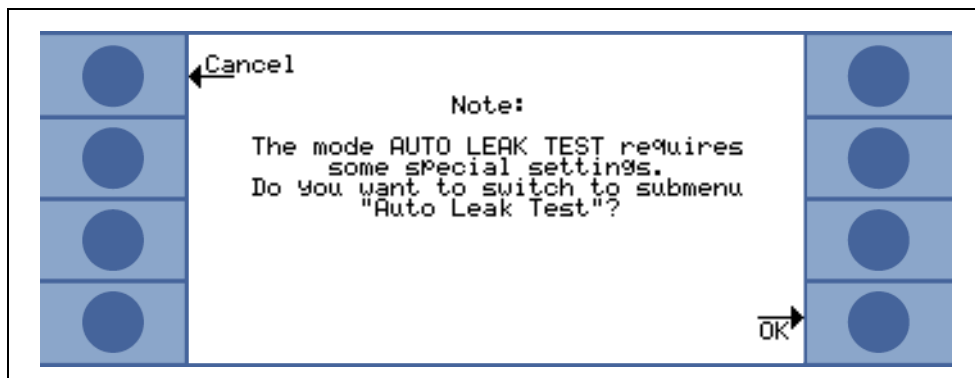

Fig. 6-6

After the settings the display screen shows in STAND-BY this picture:

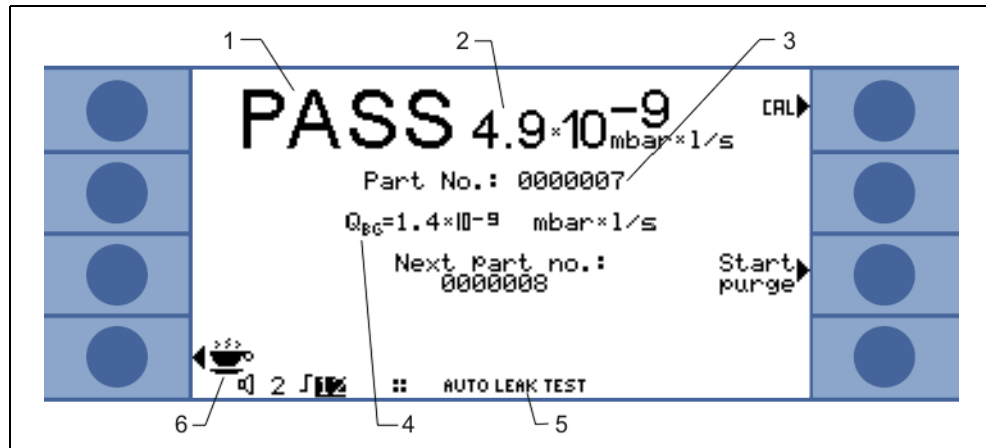

Fig. 6-7

- | | | | |
|---|---------------------|---|------------|
| 1 | Test result | 4 | Background |
| 2 | Measured leak rate | 5 | Mode |
| 3 | No. of tested parts | 6 | Standby |

Test of parts

The test can be started by START button. When using the test chamber TC1000, the test starts automatically when closing the chamber lid. After the setted cycle time is expired or the measured leak rate has gone below the trigger level the test stops and the chamber will be vented. The test can be stopped any time by STOP button.

After starting, the test procedure runs according to the setted measurement period:

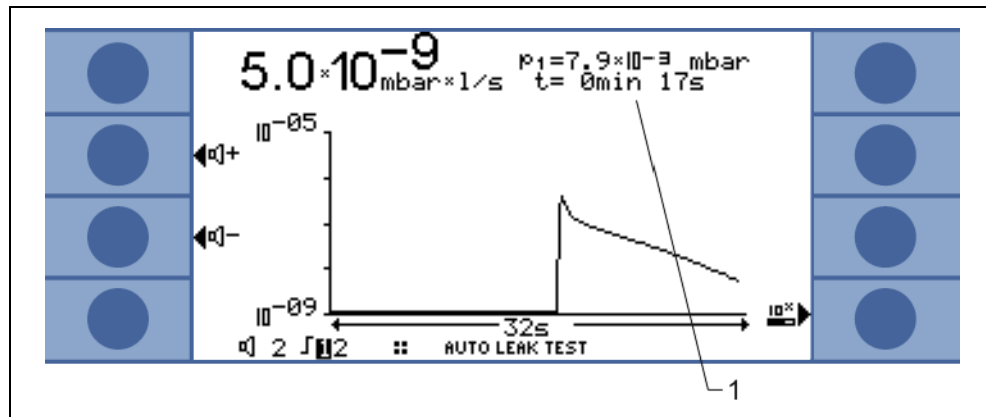

Fig. 6-8

- | | |
|---|----------------------------|
| 1 | Remaining measurement time |
|---|----------------------------|

Shut down

When the test chamber should remain under vacuum after switching off the UL1000 or UL1000 Fab, push the button (cup of coffee), follow the instruction on the display and switch off the leak detector.

This function can also be used when a test of parts should be interrupted due to a brake. You can start the measurement cycle again by pushing the button RESTART.

6.4 Trigger & Alarms

- [Main Menu > Trigger & Alarms](#)

The trigger levels, the volume of the loudspeaker and the units of leak rates and pressures can be set in this menu [Fig. 6-9](#).

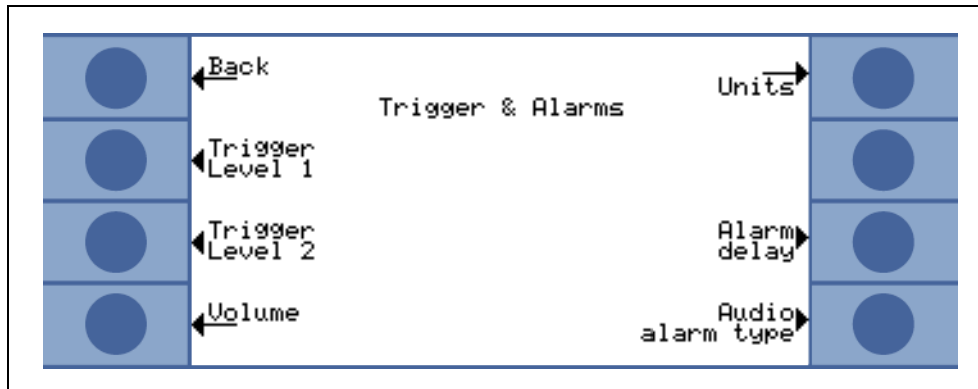

Fig. 6-9: The [Trigger & Alarms](#) Menu

Key No.	Name	Description
1	Back	Return to the main menu.
2	Trigger Level 1	Definition of Trigger level 1. See chapter 6.4.1
3	Trigger Level 2	Definition of Trigger level 2. See chapter 6.4.2
4	Volume	See chapter 6.4.3
5	Units	Selection of leak rate and pressure units. See chapter 6.4.4
6		Not used in this menu.
7	Alarm delay	See chapter 6.4.5
8	Audio alarm type	Choice of different alarm types. See chapter 6.4.6

6.4.1 Trigger Level 1

- [Main Menu > Trigger & Alarms > Trigger Level 1](#)

The value of the first trigger level can be set. See Chapter [4.2.2.7 Numerical Entries](#) for the description of the entry.

Trigger 1 and Trigger 2 are programmable switching thresholds. When these thresholds will be exceeded the UL1000 and UL1000 Fab reacts as follows:

Display

In the status line of the display the signs for Trigger 1 and Trigger 2 are displayed inverted if the leak rate exceeds (becomes higher than) the programmed value.

Relay Output

The trigger-relais of the digital out switches. Please refer to Chapter [2.3.2.2, Digital out](#), for further details.

Alarm/Loudspeaker

Additionally Trigger level 1 defines at which level the various alarm types react (See Chapter [6.4.6, Audio alarm type](#))

6.4.2 Trigger Level 2

- [Main Menu](#) > [Trigger & Alarms](#) > [Trigger Level 2](#)

The value of the second trigger level can be set. Please refer to Chapter [4.2.2.7 Numerical Entries](#) for the description of the entry.

If Trigger 2 is exceeded the corresponding relay will switch. This is also indicated at the display (see above).

6.4.3 Volume

- [Main Menu](#) > [Trigger & Alarms](#) > [Volume](#)

The minimum loudness and the regular volume of the loudspeaker can be adjusted.

The minimum loudness is the minimum speaker volume that cannot be exceeded to even lower values. Thus it is avoided that the actual volume is accidentally adjusted to a value that is below the noise level of the environment.

The actual volume can be adjusted between 15 (maximum) and the value defined as minimum loudness.

Softkey 2: Arrow down

Decrease the minimum loudness. The minimum value is 0.

Softkey 3: Arrow down

Decrease the actual volume. The minimum value is limited by the minimum volume.

Softkey 4: Beep off / Beep on

Softkey 5: ?

Help

Softkey 6: Arrow up

Increase the minimum volume. The maximum value is 15.

Softkey 7: Arrow up

Increase the regular volume. The maximum value is 15.

6.4.4 Units

- [Main Menu > Trigger & Alarms > Units](#)

The preferred leak rate unit can be selected. There is the choice of 4 (mbar, Pa, Torr, atm) pressure units and 5 leak rate units (mbar l/s, Pa m³/s-1, Torr l/s, atm cc/s).

Notice: In Sniff mode the following measuring units are selectable (Refer to chapter [6.3](#)): ppm, g/a eq (helium leak rate is equivalent with leak rate R134a), oz/gr eq (helium leak rate is equivalent with leak rate R134a).

Softkey 2: Arrow up

Scroll up to select a pressure unit.

Softkey 3: Arrow down

Scroll down to select a pressure unit.

Softkey 6: Arrow up

Scroll up to select a leak rate unit.

Softkey 7: Arrow down

Scroll down to select a leak rate unit.

6.4.5 Alarm delay

- [Main Menu > Trigger & Alarms > Alarm delay](#)

In some applications (for instance during pump down in a „chamber test system“) it might be necessary to block an alarm for some time after pressing START.

This delay time of the alarm can be changed.

Softkey 3: Arrow down

Decrease the delay time. The minimum value is 0 seconds.

Softkey 7: Arrow up

Increase the delay time. The maximum value is 10 minutes up to infinity.

After pressing START the loudspeaker is activated as soon as the leak rate drops below trigger level 1 or after the entered alarm delay time has elapsed. This setting is only active for the audio alarm types SETPOINT and TRIGGER ALARM (See Chapter [6.4.6](#)).

6.4.6 Audio alarm type

- [Main Menu](#) > [Trigger & Alarms](#) > [Audio alarm type](#)

The trigger of the audio alarm can be switched on or off.

Softkey 2: [Pinpoint](#)

Use this function to localize a leak with a well-known size. Please refer to Chapter [6.4.6.1](#)

Softkey 3: [Leak rate prop.](#)

The sound will be proportional to the leak rate signal. Please refer to Chapter [6.4.6.2](#)

Softkey 5: ?

Help

Softkey 6: [Setpoint](#)

Please refer to Chapter [6.4.6.3](#)

Softkey 7: [Trigger alarm](#)

An alarm sounds when the trigger 1 is exceeded. Please refer to Chapter [6.4.6.4](#)

6.4.6.1 Pinpoint

The tone of the acoustical signal changes its frequency only in a LR-window [Fig. 6-10](#) which ranges from one decade below the Trigger level 1 up to one decade above the Trigger level 1. Below the window the tone is constantly low, above the window it is constantly high.

Example: The Trigger level 1 is 4×10^{-7} mbar l/s. So the window where the tone changes reaches from 4×10^{-8} mbar l/s up to 4×10^{-6} mbar l/s.

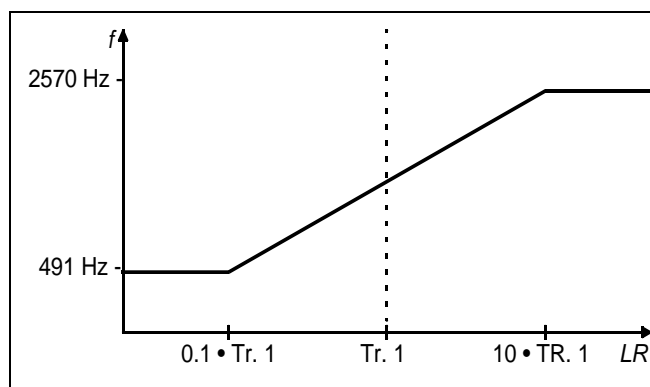

Fig. 6-10: Pinpoint

6.4.6.2 Leak rate prop.

The frequency of the acoustic output is proportional to the reading on the bargraph display. The frequency ranges from 300 Hz to 330 Hz. Please refer to Chapter [6.2.1 Scale linear/logarithmic](#) for the definition of the number of decades.

6.4.6.3 Setpoint

The tone is off as long as the leak rate is below the Trigger level 1. Above Trigger 1 the tone varies proportional to the leak rate [Fig. 6-11](#).

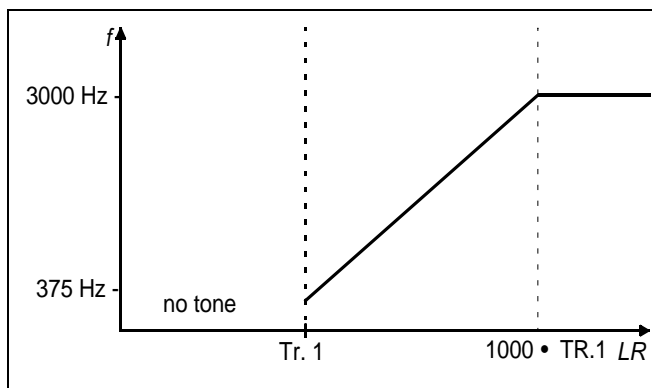

Fig. 6-11: Setpoint

6.4.6.4 Trigger alarm

As soon as the leak rate increases above trigger level 1, a multi-tone signal is generated. The tone does not vary with the leak rate.

6.5 Calibration

- [Main Menu > Calibration](#)

Please refer to [Chapter 7 Calibration](#) for a detailed description of the calibration.

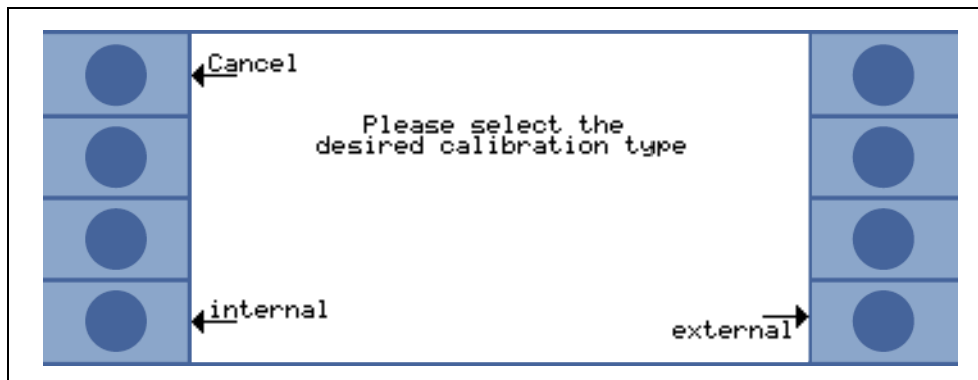

Fig. 6-12: The [Calibration Menu](#)

6.6 Settings

- [Main Menu > Settings](#)

This menu [Fig. 6-13](#) allows to observe and to change the settings of the internal machine controls.

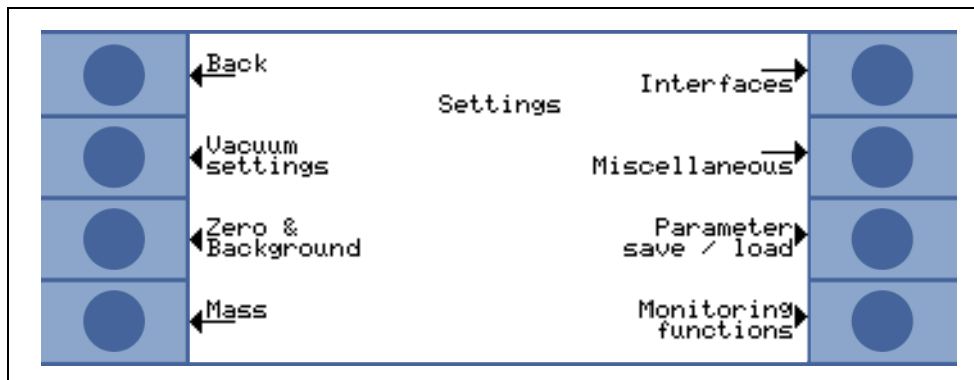

Fig. 6-13: The [Settings](#) Menu

Key No.	Name	Description
1	Back	Return to the main menu.
2	Vacuum settings	Settings of vacuum system related functions. See chapter 6.6.1
3	Zero & Background	See Chapter 6.6.2
4	Mass	Switching between helium and hydrogen. See Chapter 6.6.3
5	Interfaces	Define the recorder output (analog output) and choose the control location (local, RS232, PLC). See Chapter 6.6.4
6	Miscellaneous	Change rarely necessary settings (Date, language). See Chapter 6.6.5
7	Parameter save / load	See Chapter 6.6.6
8	Monitoring functions	Choose functions of protection of the UL1000 and UL1000 Fab. See Chapter 6.6.7

6.6.1 Vacuum settings

- [Main Menu](#) > [Settings](#) > [Vacuum settings](#)

This menu allows to observe and to change the settings belonging to the vacuum system.

Softkey 2: [Automatic purge \(UL1000 Fab only\)](#)

Refer to chapter [6.6.1.1](#)

Softkey 3: [Vent delay](#)

Refer to chapter [6.6.1.2](#)

Softkey 4: [Vacuum ranges](#)

Refer to chapter [6.6.1.3](#)

Softkey 5: [Auto Leak Test adjustments](#)

Refer to chapter [6.6.1.6](#)

Softkey 6: [Leak rate internal test leak](#)

Refer to chapter [6.6.1.4](#)

Softkey 7: [Machine factor](#)

Refer to chapter [6.6.1.5](#)

6.6.1.1 Automatic purge (UL1000 Fab only)

- [Main Menu](#) > [Settings](#) > [Vacuum settings](#) > [Automatic purge \(UL1000 Fab only\)](#)

Through this menu it is possible to program the automatic purge (Please refer to Chapter [5.3.1](#)) for 20 seconds when switching from measuring to standby mode.

Softkey 3: OFF

Automatic purge is switched off at standby mode.

Softkey 7: ON

Automatic purge is activated. When switching from measurement to STAND-BY the forepump is rinsed automatically for 20 seconds.

6.6.1.2 Vent delay

- [Main Menu](#) > [Settings](#) > [Vacuum settings](#) > [Vent delay](#)

Through this menu item it is possible to define the delay time until the inlet port is vented when operating the STOP button. When the STOP button is pressed for a period of time which is shorter than the delay time specified here, the UL1000 and UL1000 Fab will just change to Stand-by mode.

When the STOP button is pressed for a period of time which is longer than the delay time specified here, the UL1000 and UL1000 Fab will vent the inlet port.

Softkey 2: Immediately

The inlet port will be vented immediately after pressing the STOP button.

Softkey 3: After 1 second

The inlet port will be vented with a time delay of 1 second.

Softkey 4: After 1.5 seconds

The inlet port will be vented with a time delay of 1.5 seconds.

Softkey 5: ?

Help

Softkey 6: after 2 seconds

The inlet port will be vented with a time delay of 2 seconds.

Softkey 7: No vent

The inlet port cannot be vented with the STOP button.

6.6.1.3 Vacuum ranges

- [Main Menu](#) > [Settings](#) > [Vacuum settings](#) > [Vacuum ranges](#)

With this menu you can adjust different modes concerning the activity of leak detection. This setting is only active in mode vacuum (see Chapter 6.3).

Softkey No. 2: ULTRA ONLY

In this mode the UL1000 and UL1000 Fab remains in the area ULTRA after running under 0,4 mbar at the inlet flange (see Chapter 4.3.1). When showing the pressure at the inlet flange > 0,4 mbar the UL1000 and UL1000 Fab switches immediately into evacuation mode.

Softkey No. 3: FINE only

In this mode the UL1000 and UL1000 Fab remains after falling below 2 mbar at the inlet flange in FINE mode. Valve V1a will be closed. When the pressure at the inlet flange is increasing > 1 mbar the UL1000 and UL1000 Fab switches immediately into evacuation mode. The lower detection limit of FINE ONLY is 1×10^{-10} mbar l/s. The advantage of FINE ONLY is that while this mode is running no valve will switch.

Softkey No. 4: SOFTPUMP

In this mode the UL1000 and UL1000 Fab keeps the valve V1a closed when pumping down in GROSS and FINE mode. So the pumping speed at the inlet is reduced approx. by factor 2.

Softkey No. 5: ?

Help

Softkey No. 6: HIGHPUMP (only UL1000)

In this mode the UL1000 keeps the valve V1a open in ULTRA mode to increase the pumping speed at the inlet in this mode. This helps shortening the pump down time at bigger testing objects.

Softkey No. 7: NORMAL (default settings)

This is the default setting. The activity runs as explained in Chapter 4.3.1.

6.6.1.4 Leak rate internal test leak

- [Main Menu](#) > [Settings](#) > [Vacuum settings](#) > [Leak rate internal test leak](#)

The value of the internal test leak can be set. See Chapter [4.2.2.7 Numerical Entries](#) for the description of the entry.



Warning

Normally there is no reason to edit the leak rate of the internal test leak besides after a change of the internal test leak. A wrong leak rate of the internal test leak will lead to wrong leak rate readings!

6.6.1.5 Machine factor

- [Main Menu](#) > [Settings](#) > [Vacuum settings](#) > [Machine factor](#)

The machine factor takes into account that an additional external pump set is used. Based on an internal calibration only, all measured leak rate would be measured too small. The measured leak rate is multiplied with the machine factor and the result is displayed. This factor is only used for vacuum measurement modes (not for sniff mode). See Chapter [4.2.2.7 Numerical Entries](#) for the description of the entry.

The machine factor can be estimated by taking into consideration the Helium absorbing capability of the UL1000 and UL1000 Fab and the external pump.

Exactly, this is the result of the measured leak rate of an external test leak on the test sample once with and then without the external pump. The difference between the two results is the machine factor.

Adjust the machine factor to the value 400 when using the helium sniffer QUICK TEST.

The machine factor can be used to correct the leak rate indication to an air equivalent reading. By using this setting the display reads the leak rate equivalent to air. (The machine factor for this correction is $3,7 \times 10E-1$). When using this setting the status is indicated on the display by COR.

To return to standard indication of the leak rate, use the default settings (machine factor is 1.0).

6.6.1.6 Auto Leak Test adjustments

- [Menu](#) > [Settings](#) > [Vacuum Settings](#) > [Auto Leak Test settings](#)

All parameters for a test at hermetic sealed parts can be setted.

Measurement period

The Measurement period can be setted between a Minimum and a Maximum value (see [Fig. 6-14](#)).

Settings:	Interval:
time	
1 - 20 sec	1 sec steps
20 - 30 sec	2 sec steps
30 - 60 sec	5 sec steps
1 - 30 min	10 sec steps
3 - 10 min	30 sec steps
10 - 30 min	1 min steps

The measurement period (Maximum value) depends on the volume of the chamber, volume of the tested object and the rejectant leak rate.

If the measured leak rate has gone below the trigger level, the measurement period will be finished with the result PASS even if the maximum value of the measurement period is not reached.

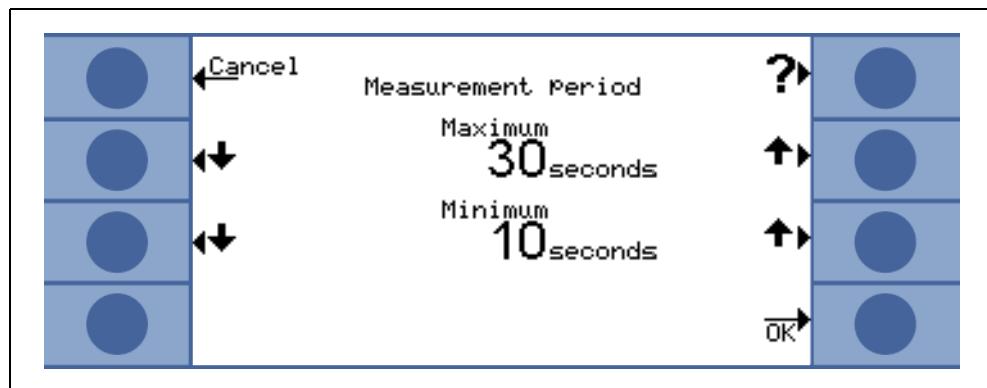

Fig. 6-14 Measurement period

Examples for time settings

(using the Inficon Test Chamber with a volume of 430 cm³):

Range of rejectant level	Measurement Period
10E-5	2 sec
10E-6	2 sec
10E-7	2 sec
10E-8	>5 sec
10E-9	>10 sec*

*external calibration with a 10E-9 test leak (i.e. TL 9) recommended

Notice: After changing the measurement time a calibration request could be asked.

Trigger level 1

The rejectant level for a part to be tested can be set in the range from 10^{-1} to 10^{-9} mbar l/s.

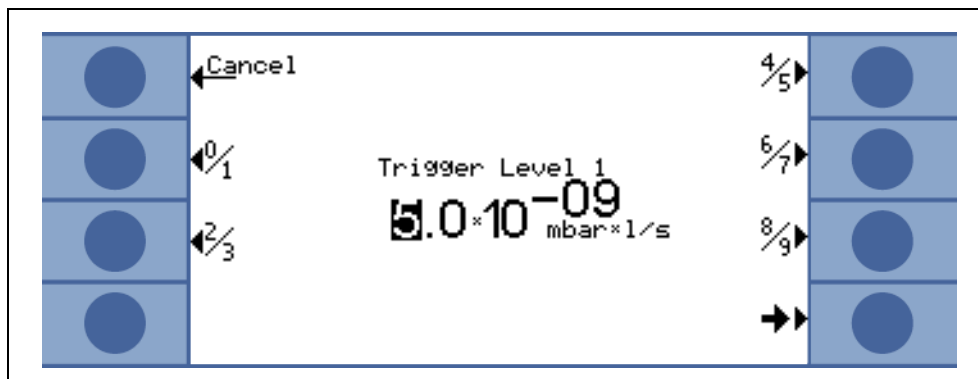

Fig. 6-15

Series error messages

The number of failed parts in series can be set from 1 to 9. In disable mode this function is switched off.

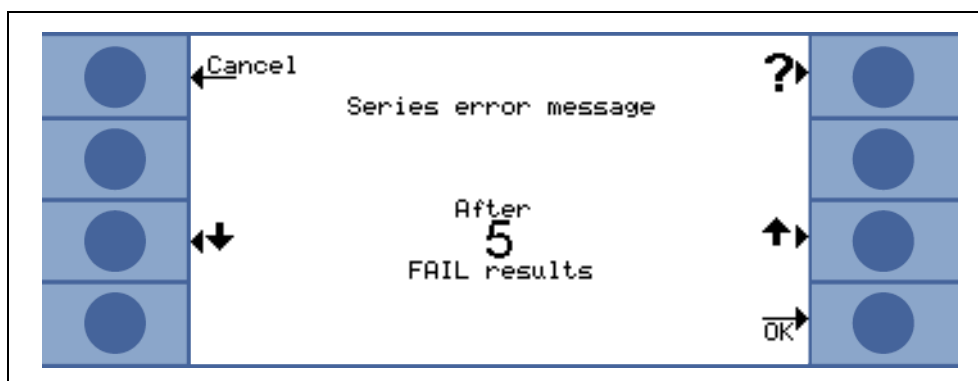

Fig. 6-16

Now a REFERENCE MEASUREMENT (see no. 1 in fig. 6-19) can be started to clean the test chamber and measure the background level that will be subtracted from the following measurements.

Part under test

The number of the first part to be tested can be entered. The number counts automatically up at the next test cycle. In disable mode this function is switched off.

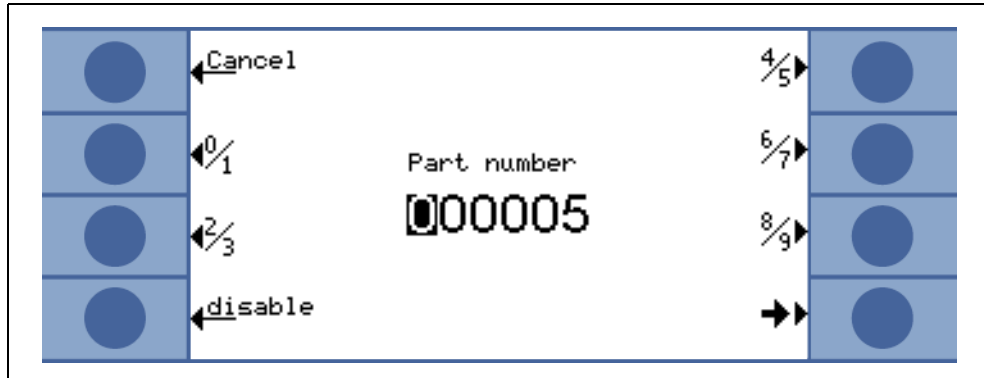

Fig. 6-17

Reference measurement

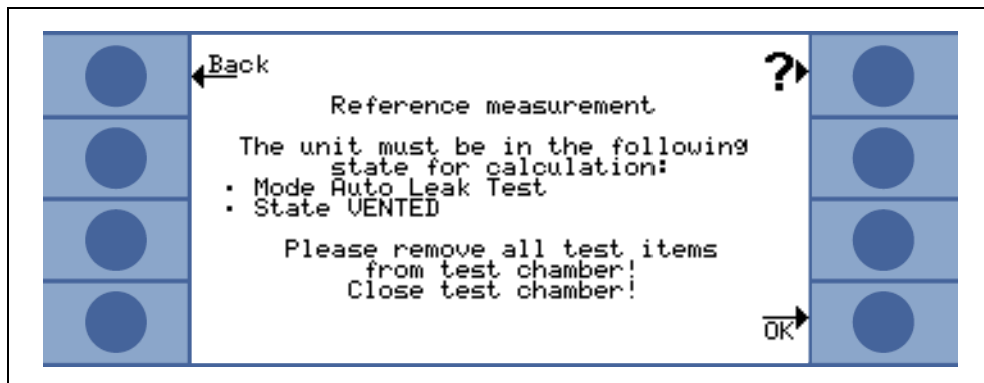

Fig. 6-18

This mode can be used to clean up the chamber after a helium contamination or after a series of failed parts. The chamber will be pumped down and vented 3 times.

The Reference measurement includes a calibration procedure with the internal test leak TL of UL1000. After this clean up the actual helium background is measured and will be subtracted from the following measurements.

The new values of the measured background will be saved automatically:

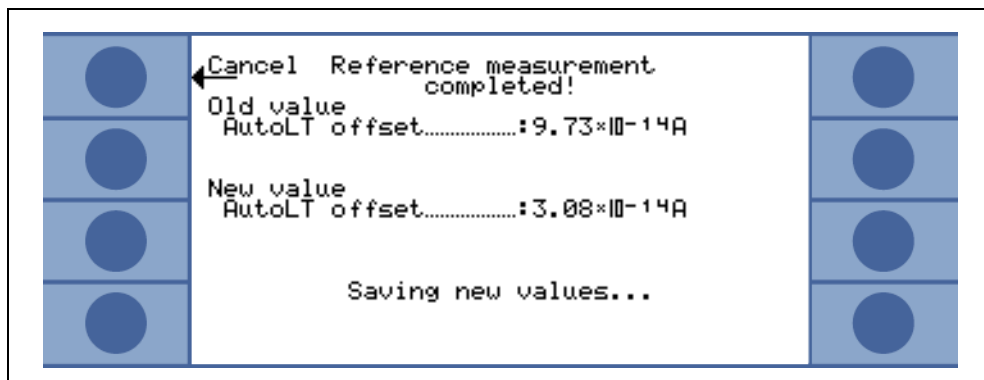

Fig. 6-19

6.6.2 Zero & Background

- [Main Menu > Settings > Zero & Background](#)

The kind of background suppression inside the UL1000 and UL1000 Fab and the function of the Zero button can be selected.

Softkey 3: Background suppression

Refer to Chapter [6.6.2.1](#)

Softkey 7: Zero

Refer to Chapter [6.6.2.2](#)

6.6.2.1 Background Suppression

- [Main Menu > Settings > Zero & Background > Background Suppression](#)

By this mode the internal helium background of the UL1000 and UL1000 Fab will be subtracted at every measurement after pressing START. This function helps to save clean up of the UL1000 and UL1000 Fab after a helium contamination.

Softkey 3: Off

Internal background suppression is switched off

Softkey 7 On

The internal background (see Chapter [6.2.5](#)) will be calculated when switching to STAND-BY mode. This value will be subtracted when pressing START.

6.6.2.2 Zero

- [Main Menu > Settings > Zero & Background > Zero](#)

This setting enables (respectively disables) the ZERO button at the control panel.

Softkey 2: Zero at ULTRA

With "Zero at ULTRA" the ZERO function executes automatically as soon as the measuring range ULTRA is reached for the first time after START. In this mode the ZERO function also can be executed manually via the ZERO button.

Softkey 3: Disable: ZERO function

Softkey 5: Help

Softkey 6: I•Zero

The Zero function is locked as long as the leak rate signal is not stable enough to detect a leak of the programmed value of Trigger 1.

The function „I-Zero“ enables the ZERO button only at stable leak rate signals. By the standard Zero function the actual background value will be subtracted when pressing ZERO. At falling background signals smaller leaks could be missed because the subtracted background value is higher than the leak rate signal at the moment of measuring.

By „I-Zero“ the drift of the falling background signal is checked, if it is higher than 0.5 x trigger value 1 (adjusted to the desired rejection level).

Softkey 7: Enable: ZERO function

6.6.3 Mass

- [Main Menu](#) > [Settings](#) > [Mass](#)

The requested mass of the measured gas can be selected. The UL1000 and UL1000 Fab must be in Stand-by.

Softkey 2: H₂ (2 amu)

Hydrogen with the mass of 2 amu will be measured.

Softkey 3: ³He (3 amu)

Isotop of helium with the mass of 3 amu will be measured.

Softkey 7: ⁴He (4 amu)

Helium with the mass of 4 amu will be measured.

6.6.4 Interfaces

- [Main Menu](#) > [Settings](#) > [Interfaces](#)

The parameters of the interface can be set.

Softkey 3: [Control Location](#)

Please refer to Chapter [6.6.4.1](#)

Softkey 4: [RS232 Protocol](#)

Please refer to Chapter [6.6.4.2](#)

Softkey 7: [Recorder output](#)

Please refer to Chapter [6.6.4.3](#)

Softkey 8: [Scaling Recorder Output](#)

Please refer to Chapter [6.6.4.4](#)

6.6.4.1 Control Location

- [Main Menu](#) > [Settings](#) > [Interfaces](#) > [Control Location](#)

Softkey 2: PLC

The UL1000 and UL1000 Fab is controlled via the Digital In connector (See Chapter 2.3.2.3). The START, STOP and ZERO buttons at the control panel are locked.

Softkey 3: RS232

The UL1000 and UL1000 Fab is controlled via RS232 interface by an external computer. In this mode the UL1000 and UL1000 Fab can not be controlled via keyboard. The START, STOP and ZERO button at the machine are deactivated.

Taste Nr. 4 All

UL1000 and UL1000 Fab can be operated via the digital input, the RS232-interface and the keyboard.

Softkey 5: Local & PLC

The UL1000 and UL1000 Fab is controlled via the Digital In connector or the START, STOP and ZERO buttons at the control panel.

Softkey 6: Local & RS232

The UL1000 and UL1000 Fab is controlled via the Digital In connector or the START, STOP and ZERO buttons at the control panel.

Softkey 7: Local

The UL1000 and UL1000 Fab is controlled via the START, STOP and ZERO buttons at the control panel. The Digital In connector is not used.

6.6.4.2 RS232 Protocol

- [Main Menu](#) > [Settings](#) > [Interfaces](#) > [RS232 Protocol](#)

Softkey 3: Diagnostics

Gives the chance to read parameters, e.g. during maintenance.

Softkey 4: Printer Manual

Leak rates measured by this function can be sent to RS232 printers or PC. The measured value can be displayed via hyperterminal programs. The baudrate of this printer function is set to 9600, 8N1. Connected data loggers must be set to these parameters.

Format of the leak rate output:

LR = 1.00E-10 09:Apr.07 08:25 MEAS

LR: Leak rate

The measured value is equal to the number which then follows. In case of overflow or underflow the symbol < (leak rate is less than the stated value) or > (leak rate is greater than the stated value) is output accordingly.

1.00E-10: Output of the measured value in the unit set up, followed by date and time.

MEAS: The UL1000 / UL1000Fab is in the measure mode.

When pressing the START button once again in the measure mode or activation of the START input at the DIGITAL IN port the leak rate will be send out.

Softkey 5: ?

Help

Softkey 6: UL2xx Leak Ware

Gives the chance to control and read measurement values when connecting to a computer.

Notice: The calibration function of the Leak Ware is not appropriate to operate with the UL1000 and UL1000 Fab.

Please execute the function „STORE DATE“ in the operating mode „Single Part Measurement“ for starting the record of the measured values.

Softkey 7: ASCII

Gives the chance to use the UL1000 and UL1000 Fab via a RS232 terminal.

6.6.4.3 Recorder output

- [Main Menu](#) > [Settings](#) > [Interfaces](#) > [Recorder output](#)

The signals to be recorded can be selected in this submenu.

Softkey 1: Cancel

Return to the previous menu without any changes of the present settings.

Softkey 2: Arrow up

Address recorder output 1 or 2

Softkey 3: Arrow down

Address recorder output 1 or 2

Softkey 5: Help

Softkey 6: Arrow up

Behaviour recorder output. For further information see keywords below.

Softkey 7: Arrow down

Behaviour recorder output. For further information see keywords below.

Softkey 8: ok

Saving off chosen parameters

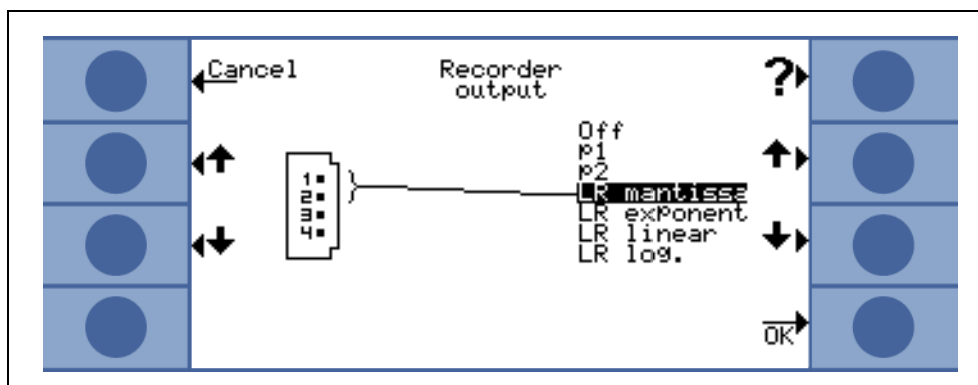

Fig. 6-20

Off

The recorder output is switched off.

p_1 / p_2

The fundamental output voltage is scaled logarithmic. The inlet pressure p_1 or the forevacuum pressure p_2 can be recorded.

The signals p_1 and p_2 have the characteristics of the Pirani gauge TPR265 (see chart in appendix).

LR lin

The leak rate output voltage is scaled linear. The fundamental voltage is 0-10 V in scalable steps from 0.5 to 10 volts per decade.

For information about scaling see chapter 6.6.4.4

LR log

The leakrate is recorded on a logarithmic scale. The voltage output ranges from 1 ... 10 V with steps of 0.5 V per decade.

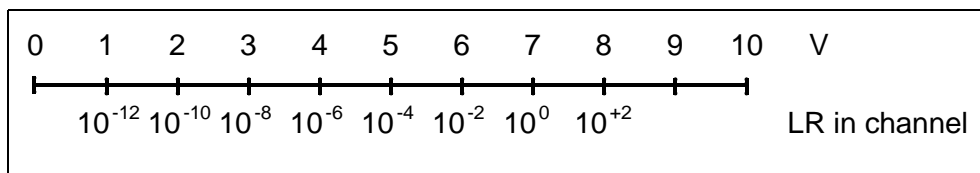

Fig. 6-21 Example of range of leak rate, log, 0.5 V/decade

For adjusting of scaling see chapter 6.6.4.4.

LR mantissa

The leak rate mantissa is recorded linearly from 1 ... 10 V.

LR exponent

The exponent is recorded like a step function: U = 1 ... 10 V with steps of 0.5 V per decade, starting with 1 V = 1×10^{-12} .

6.6.4.4 Scaling Recorder Output

- [Main Menu](#) > [Settings](#) > [Interfaces](#) > [Scaling Recorder Output](#)

Here the scaling of the recorder output can be adjusted. This adjustment is only valid for the setting "LR lin" or "LR log" (refer to Chapter 6.6.4.3 Recorder output).

Softkey 2: Arrow up

Adjust decade of the upper limit value

Softkey 3: Arrow down

Scaling of the previously adjusted value in steps of 0.5, 1, 2, 2.5, 5, 10 Volt/decade. The complete voltage range is 10 V. (Only for signal "LRlog")

Softkey 6: Arrow up

Adjust decade of the upper limit value

Softkey 7: Arrow down

Scaling of the previously adjusted value in steps of 0.5, 1, 2, 2.5, 5, 10 Volt/decade. The complete voltage range is 10 V. (Only for signal "LRlog")

Example:

Chart recorder output: "LRlog"

Upper limit value is adjusted to 10^{-5} (= 10V)

Scaled to 5 V/decade

Lower limit value consequently is 10^{-7} (= 0 V)

6.6.5 Miscellaneous

- [Main Menu](#) > [Settings](#) > [Miscellaneous](#)

The actual date and time, the preferred language and the mains frequency can be set in this submenu.

Softkey 2: [Time&Date](#)

Please refer to Chapter [6.6.5.1](#)

Softkey 3: [Language](#)

Please refer to Chapter [6.6.5.2](#)

Softkey 4: [Leak rate filter](#)

Please refer to Chapter [6.6.5.3](#)

Softkey 6: [Mains Frequency](#)

Please refer to Chapter [6.6.5.4](#)

Softkey 7:

Service interval exhaust filter.

Softkey 8:

Service message exhaust filter.

6.6.5.1 Time&Date

- [Main Menu](#) > [Settings](#) > [Miscellaneous](#) > [Time&Date](#)

Date and time can be changed on two subsequent pages. Please refer to Chapter [4.2.2.7 Numerical Entries](#) for the description of the entry.

6.6.5.2 Language

- [Main Menu](#) > [Settings](#) > [Miscellaneous](#) > [Language](#)

The preferred language can be selected by pressing Softkey 3 and 7. The default setting is English.

Selectable languages: English, German, French, Italian, Spanish, Polish, Chinese (Mandarin), Japanese (Katakana), Korean.

Notice: The default setting can be reset by pressing the softkey 2 and 6 simultaneously during run-up of the leak detector.

6.6.5.3 Leak rate filter

- [Main Menu](#) > [Settings](#) > [Miscellaneous](#) > [Leak rate filter](#)

The kind of the leak rate filter can be chosen. The default value is I•CAL.

Softkey 3: Fixed

A filter with a fixed time constant will be used.

Softkey 5: ?

Help

Softkey 7: I•CAL

I•CAL makes sure that the averaging time is optimal based on the leak rate level.

I•CAL stands for Intelligent Calculation Algorithm of leak rates. It makes sure that the signals are averaged in optimized time intervals, based on the leak rate intensity. I•CAL also eliminates noise peaks which are not related to leak rate signals and provides unexpected short response times for low leak rate signals.

The algorithm used provide excellent sensitivity and response time and is there for the recommended setting.

6.6.5.4 Mains Frequency

- [Main Menu](#) > [Settings](#) > [Miscellaneous](#) > [Mains Frequency](#)

The mains frequency takes the different pumping speed of the scroll pump into account. The frequency of the mains power supply can be selected. The default setting is 50 Hz for 230 V and 60 Hz for 115 V.

Softkey 3: 50 Hz

The UL1000 and UL1000 Fab will be run at a mains frequency of 50 Hz.

Softkey 6: 60 Hz

The UL1000 and UL1000 Fab will be run at a mains frequency of 60 Hz.

6.6.5.5 Service interval exhaust filter

Here you can enter the service intervall of the exhaust filter.

Softkey 3: Down

Decrease of the service intervall steps of within 500 hours.

Softkey 5: ?

Help

Softkey 7: Up

Increase of the service intervall within steps of 500 hours. The limit is 4000 hours.

6.6.5.6 Service message exhaust filter

The exhaust filter must be maintained at regular intervals to ensure the correct function of the UL1000 and UL1000 Fab. If the service message is activated, the UL1000 and UL1000 Fab reminds you of the required maintenance.

Softkey 3: Off

Softkey 5: Help

Softkey 7: On



Warning

If the service messages are ignored and the exhaust is not replaced a risk for overheating the pump motor exists.

6.6.6 Parameter save / load

- [Main Menu](#) > [Settings](#) > [Parameter save / load](#) > *Load*

Enables to save and load individual settings or reload the default settings.

Softkey 2 to 4: The names of the current values can be saved under a free choosable name. The saving of 3 different sets is possible.

Please refer to Chapter [6.6.6.1](#)

Softkey 5: load default values

The factory setting have to be loaded again.

Softkey 6 to 8: One of three saved parameter sets can be loaded.

Please refer to Chapter [6.6.1.3](#)

6.6.6.1 Load parameter set

- [Main Menu](#) > [Settings](#) > [Parameter save / load](#) > *Save*

Save the current parameter settings.

Softkey 4: Edit a file name

Rename the parameter set.

6.6.6.2 Save parameter set

- [Main Menu](#) > [Settings](#) > [Parameter save / load](#) > [Load parameter set](#)

The settings of the selected saved parameter set will be displayed and can be reloaded.

Softkey 6: Arrow up
Upward to the previous screen.

Softkey 7: Arrow down
Downward to the next screen.

6.6.7 Monitoring functions

- [Main Menu](#) > [Settings](#) > [Monitoring functions](#)

Calibration request

- [Main Menu](#) > [Settings](#) > [Monitoring functions](#) > Calibration request

It can be selected whether the operator is reminded of the fact that a calibration may have become necessary or not. The default value is off.

Softkey 3: Off
The calibration request will be switched off.

Softkey 7: ON
The calibration request will be switched on.

If the calibration request is switched on, a corresponding message will appear when 30 minutes have elapsed after power on or if the temperature of the UL1000 and UL1000 Fab has changed by more than 5 °C (9 °F) since the last calibration.

Particle protection

- [Main Menu](#) > [Settings](#) > [Monitoring functions](#) > Particle Protection

This mode can be switched on and off.

If switched on the UL1000 and UL1000 Fab will not start pumping down before the inlet has not dropped below 1 mbar. e.g. it is assumed that the part under test is pumped by another pump in parallel.

Purpose: When the leak detector does not pump at high pressures no gas stream, possibly carrying particles gets into the leak detector.

Softkey 3: Off

Softkey 5: Help

Softkey 7: ON

Contamination protection

- [Main Menu](#) > [Settings](#) > [Monitoring functions](#) > Contamination protection

If this mode is switched on the UL1000 and UL1000 Fab closes all inlet valves as soon as the measured leak rate exceeds the programmed leak rate. Thus no more Helium gets into the mass spectrometer. Helium that has gotten into the tool under test can be pumped away by the tool pump. If no extra pump is available it is recommended to vent the part before the test is continued.

Softkey 3: Off

Softkey 4: edit the limit value
Edit the limit value for switching off

Softkey 5: Help

Softkey 7: ON

Softkey 8: OK

Pressure limits for vacuum ranges

[Main Menu](#) > [Settings](#) > [Monitoring functions](#) > Pressure limits for vacuum ranges

With this function you can adjust the switching point between the modes GROSS-FINE-ULTRA. This can be essential when other gases than air are pumped with the UL1000 and UL1000 Fab. The control signal of the Pirani may vary at other gases than air. Therefore it may be necessary to adjust the switching points.

Softkey No. 2, 6: Change over threshold EVAC-GROSS
.15-3 mbar (Default value 15 mbar)

Softkey No. 3, 7: Change over threshold GROSS-FINE
2-0,5 mbar (Default value 2 mbar).

When changing this values the change over FINE-ULTRA threshold will automatically be retightend to 0,4 - 0,1 mbar.

Softkey No. 4 Adjustment for ARGON
Press again the softkey for default values for air.

Softkey No. 5: ?
Help

Pressure limits for sniff mode

- [Main Menu](#) > [Settings](#) > [Monitoring functions](#) > Pressure limits for sniff mode

This function is automatically activated in sniff mode. The pressure limits define an upper and lower limit of the inlet pressure. The upper limit is 2 mbar, the lower limit is 0.02 mbar. If the pressure is not in this range error messages are generated:

$P > upper\ limit$: Capillary broken

$P < lower\ limit$: Flow through capillary too low (Capillary blocked)

Softkey 3 and 6: Setting of the maximal pressure: upper limit 2 mbar

Softkey 4 and 7: Setting of the minimal pressure: lower limit 0.02 mba

Softkey 5: Help

Maximum evacuation time

- [Main Menu](#) > [Settings](#) > [Monitoring functions](#) > Maximun evacuation time

This menu item is used to define when the gross leak message is to occur. The gross leak detection process operates in two steps and the limits can be adapted as required.

This menu item is particularly useful in series testing under the same conditions at all times.

After pressing the start button the test sample is evacuated. If the pressure conditions ($p_1 < 100$ mbar) are not attained, or if the pressure does not drop low enough within the periods of time specified here, the pumpdown process is terminated and the display will indicate a message (see 8.2, W76).

The periods which are selected in each case depend firstly on the desired reaction time for the gross leak message, and secondly on the volume of the test sample and the effective pumping speed.

Caution: If the evacuation time was set to endless, the oil level of the mechanical pump should be checked more often.

Softkey No. 2: ↓

Decreasing maximum evacuation time until $p_1 < 100$ mbar. Within this period of time the inlet pressure at the test flange must have dropped below 100 mbar. The duration may be selected freely between 1 second and 9 minutes or can be set to endless. The default is 30 seconds.

Softkey No. 3: ↓

Decreasing maximum time until measurement Within the period of this time the status of measurement readiness must have been attained, i.e. the inlet pressure must have dropped below 15 mbar. The duration may be freely selected between 5 seconds and 30 minutes or can be set to endless.

Softkey No. 5: ?

Help text

Softkey No. 6: ↑

Increasing maximum evacuation time until $p_1 < 100$ mbar

Softkey No. 7 ↑

Increasing maximum time until measurement.

6.7 Information

- [Main Menu > Information](#)

The [Information](#) Menu [Fig. 6-22](#) enables submenus to select different kinds of information belonging to the UL1000 and UL1000 Fab.

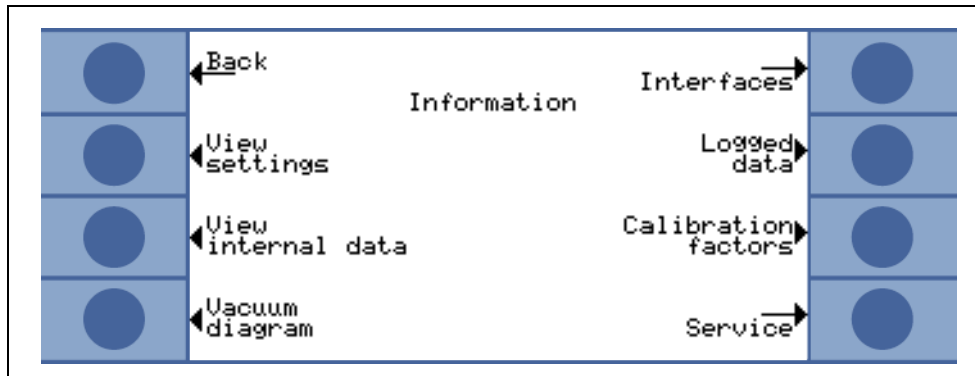

Fig. 6-22: The [Information](#) Menu

Softkey 2: View settings

The current settings will be displayed on 4 pages, e.g. trigger levels, test leak mass, date and time.

Softkey 3: View internal data

Information on measured internal data is provided on 4 screens.

Softkey 4: Vacuum diagram

The vacuum diagram of the UL1000 and UL1000 Fab is shown. Here you can see which valves are open or closed momentarily and more.

Softkey 5: View error list

The list of occurred errors and warnings will be displayed.

Softkey 6: Calibration history

The carried out calibrations will be listed.

Softkey 7: Calibration factors

The calibration factors for the different masses, the machine factor will be displayed.

Softkey 8: [Service](#)

Please refer to [Chapter 6.7.1](#)

6.7.1 Service

- [Main Menu > Information > Service](#)

With the main menu special functions can be accomplished (e. g. manual switching of the valves). The access to the service menu is protected by a PIN. This PIN is not communicated with the delivery of the leak detector but after an adequate service training. For more information concerning the service menu see instructions (iipa74e1).

6.8 Access Control

- [Main Menu > Access Control](#)

With this menu you can deny or allow access to specific functions of the UL1000 and UL1000 Fab.



Fig. 6-23: The [Access Control](#) Menu

Softkey 4: [Access to CAL function](#)

Please refer to Chapter [6.8.1](#)

Softkey 7: Change device-PIN

Please refer to Chapter [6.8.2](#)

Softkey 8: [Change Menu-PIN](#)

Please refer to Chapter [6.8.3](#)

6.8.1 Access to CAL function

- [Main Menu > Access Control > Access to CAL function](#)

It can be selected whether the access to the calibration menu is restricted or not.

Softkey 3: Off

The calibration function is only available at the main menu. If the Menu-PIN (See Chapter [6.8.3](#)) is activated you need this PIN to start a calibration.

Softkey 5: ?

Help

Softkey 7: ON

The calibration function is available at the main menu and in Stand-by and the measure mode.

Softkey 8: OK

Save the settings and return to the previous menu.

6.8.2 Change Device PIN

- [Main Menu](#) > [Access Control](#) > [Change Device PIN](#)

The access to the UL1000 and UL1000 Fab can be restricted by a Device-PIN. If the Device-PIN is not 0000 the UL1000 and UL1000 Fab will ask for this PIN directly after power on. Without device-PIN the UL1000 and UL1000 Fab does not even switch on the pumps.

Notice: Under all circumstances memorize the PINs! The PIN can only be reset by INFICON's service organization.

6.8.3 Change Menu-PIN

- [Main Menu](#) > [Access Control](#) > [Change Menu-PIN](#)

The access to the menu can be restricted by entering or changing the personal identification number (PIN). No PIN will be checked if 0000 is entered.

Please refer to Chapter [4.2.2.7 Numerical Entries](#) for the description of the entry.

Notice: Under all circumstances memorize the PINs! The PIN can only be reset by INFICON's service organization.

7 Calibration

7.1 Introduction

The UL1000 and UL1000 Fab can be calibrated in two different ways:

- Internal calibration by means of a built-in leak standard.
- External calibration by means of an additional leak standard which then is attached to the inlet port or the component under test.

During the calibration procedure the mass spectrometer is tuned to the maximum helium signal and this signal is referred to the known leak rate of the internal or external leak standard. Although the UL1000 and UL1000 Fab is a very stable instrument a calibration is recommended from time to time to make sure that ambient temperature changes or dirt or other impacts don't adulterate the measurements.

When the unit is used constantly the calibration should be performed at least once a day. Otherwise the frequency of calibration depends on the frequency of use.

Notice: To get an optimized calibration the machine has to warm up at least 20 minutes before use.

Test leaks for calibration should not have a range lower than 1×10^{-9} mbar l/s to ensure a stable calibration signal.

7.2 The calibration routines

The calibration routines can be started by pressing button CAL (Softkey 5) via 3 different locations:

- main menu
- Stand-by mode
- measurement mode

The access via Stand-by mode or measurement mode can possibly be not available. (Refer to chapter [Access to CAL function](#)). In this case there will be no inscription on the correspondingly Soft Key.

A calibration may be terminated at any time by pressing the **STOP Button** or using the Soft Key no. 1 (*Cancel*).

Once the calibration mode is activated the user must choose between an internal and an external calibration. Please press the corresponding Soft Key.

7.2.1 Internal Calibration

For internal calibrations the UL1000 and UL1000 Fab differentiates between two possibilities:

- If the unit is blanked off or disconnected from any chamber by a valve on the [Inlet Port](#) the automatic calibration can be chosen (Soft Key no. 8).
- If the unit is connected to a chamber or a bigger component the calibration has to be performed manually because the reaction times on opening or closing the internal leak standard vary depending on the volume of the chamber.

Notice: It is recommended to use the automatic calibration if possible.

7.2.1.1 Automatic Internal Calibration

Once this procedure is started the entire procedure is performed automatically. At the end (after about 25 s) a beep is released. Thereafter the unit is ready for further use.

7.2.1.2 Manual Internal Calibration

When [Manual Internal Calibration](#) is selected it is assumed that the UL1000 and UL1000 Fab is connected to a component under test (if not please go to [Automatic Internal Calibration](#)).

After starting the [Manual Internal Calibration](#) the UL1000 and UL1000 Fab pumps down the test part (if not already under vacuum) and opens the internal leak standard. Depending on the volume of the part it may take some time for the helium signal to stabilize. Therefore the user has to confirm that the signal has reached a stable level (Soft Key no. 8).

The unit now runs through the tuning process and closes the internal leak standard automatically. Again the volume of the test part determines how long it takes to pump down the helium and to reach a stable background level, which has to be confirmed by the user.

Thereafter the unit is calibrated.

7.2.2 External Calibration

For an external calibration a leak standard has to be attached to the part under test or the inlet port directly.

Notice: The shown leak rate can diverge of the printed values of the external calibrated leak because of uncertainties and temperature coefficients.

After [External Calibration](#) (Soft Key no. 8) has been chosen the following messages are displayed and the described actions are required:

- Make sure that the test leak is connected and opened.
- Check the leak rate printed on the test leak and compare it with the leak rate at the display. If the leak rates are not identical press *Edit leak rate* (Soft Key no. 4) and correct the value.
- If the leak rates are okay press *START* (Soft Key no. 8).

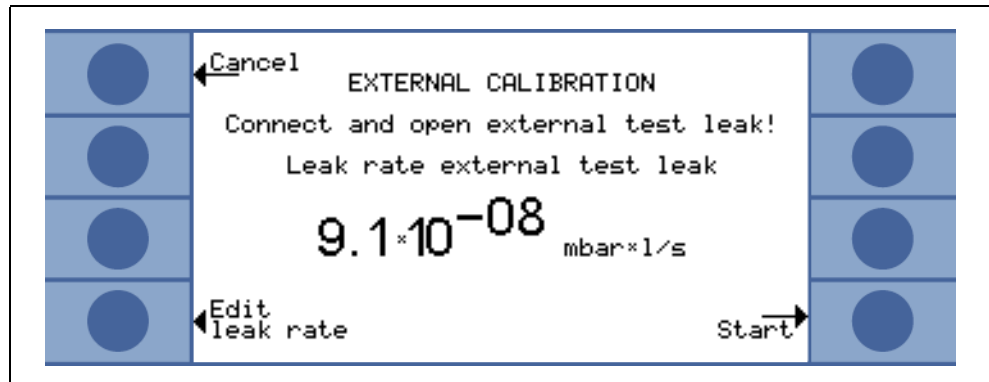

Fig. 7-1: External Calibration, Step 1

- No action required.

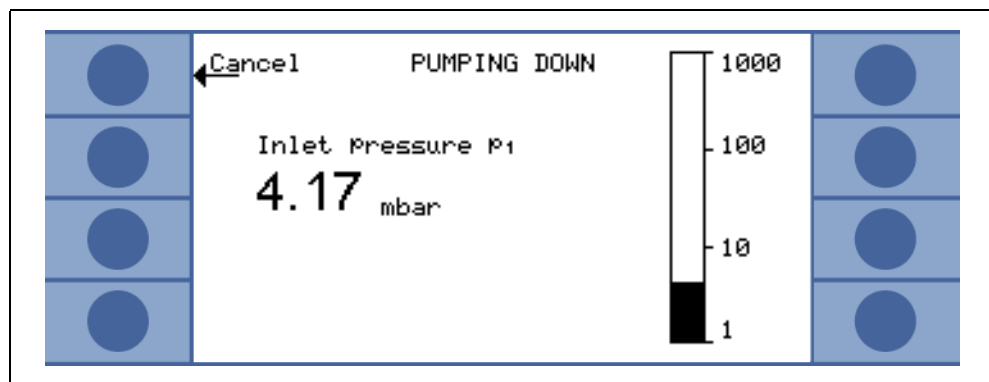

Fig. 7-2: External Calibration, Step 2

- The bargraph display shows a signal which must not vary much. If so please press *OK* (Soft Key no. 8).

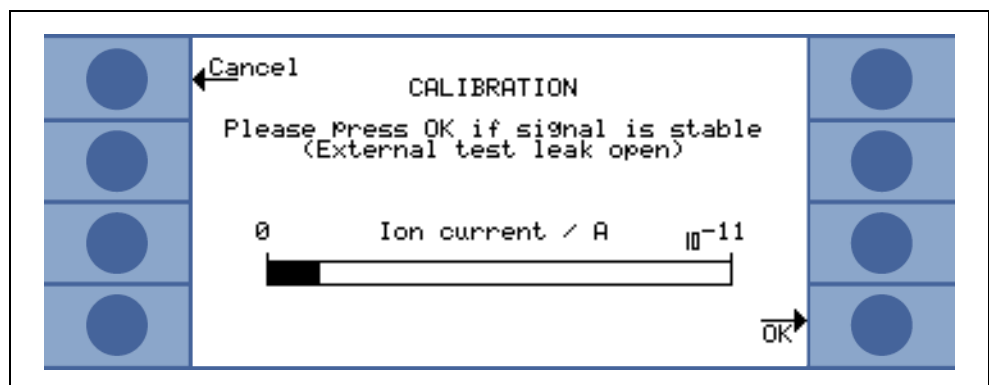

Fig. 7-3: External Calibration, Step 3

- No action required.

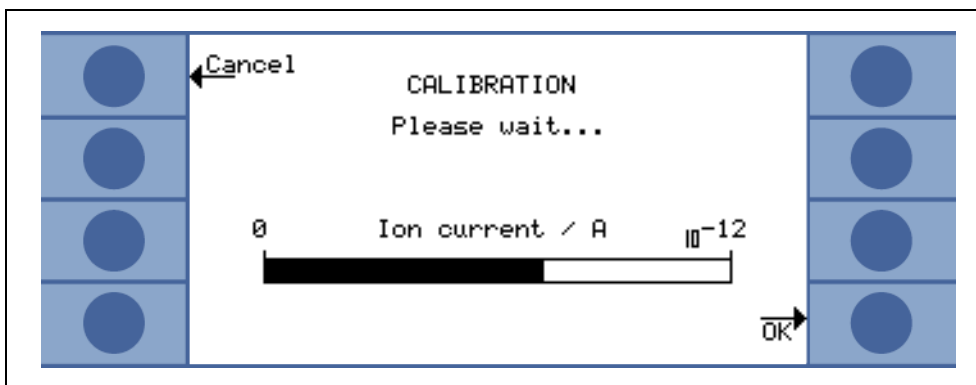

Fig. 7-4: External Calibration, Step 4

- No action required.

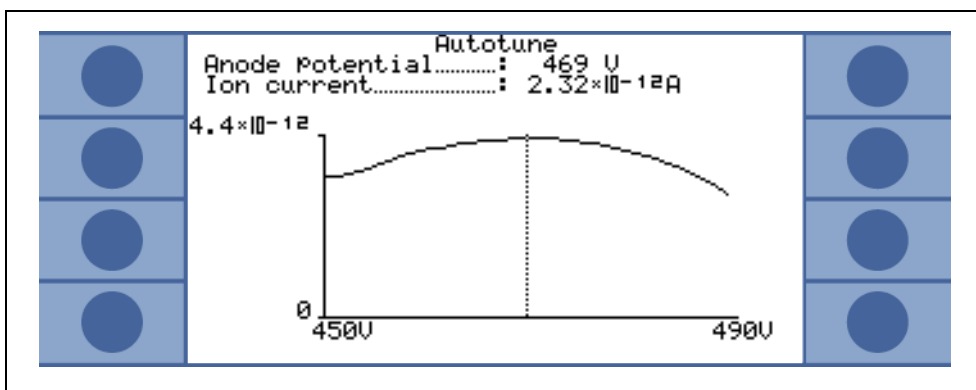

Fig. 7-5: External Calibration, Step 5

- Close the external leak standard and confirm with OK (Soft Key no. 8).

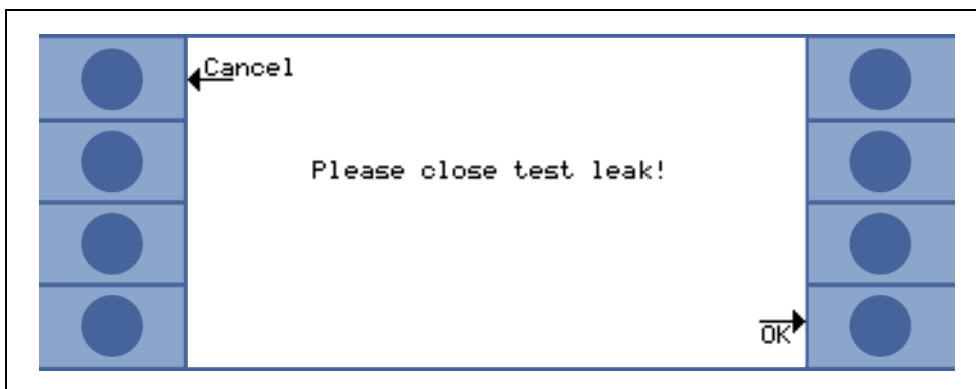

Fig. 7-6: External Calibration, Step 6

- The bargraph display shows a signal which must not decrease any more. There might be a small fluctuation which is okay. If so please press *OK* (Soft Key no. 8).

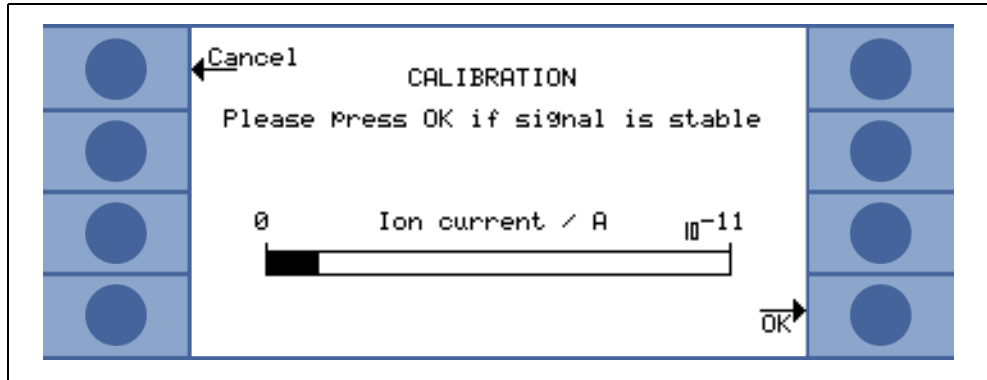

Fig. 7-7: External Calibration, Step 7

- The UL1000 and UL1000 Fab displays the old and the calculated new calibration factor.

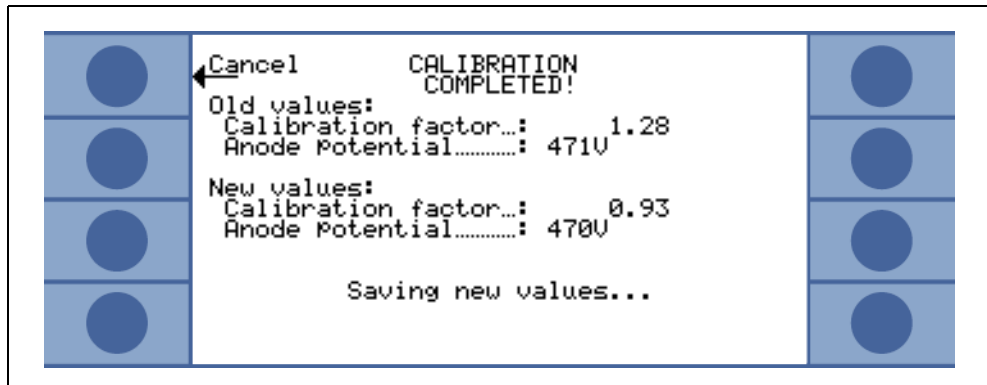

Fig. 7-8: External Calibration, Step 8

7.3 Factor of Calibration - Range of Values

To avoid a faulty calibration the factor of calibration is tested for plausibility at the end of the calibration routine:

When the new factor of calibration is not considerably higher or lower (< factor 2) than the previous factor of calibration the new factor will be accepted automatically. When the new factor of calibration diverges stronger from the previous factor the user can decide if he wants to accept it anyway (e. g. after changing the system configuration) or not (e. g. because of a maloperation).

Notice: When calibration is started via SPS or RS232 no testing for plausibility is occurring.

When calibrating internal it is also monitored if the newly calculated factor of calibration is higher than 10 or lower than 0.1. In this case a warning (see W81 resp. W82 in chapter Refer to chapter 8.2) is displayed and the calibration will be interrupted.

8 Error And Warning Messages

The UL1000 and UL1000 Fab is equipped with a comprehensive self-diagnostic facilities. If an error or warning condition is detected it is indicated via the LC display to the operator.

An audio signal is generated when an error or warning occurs. The frequency changes every 400 ms from 500 Hz to 1200 Hz and vice versa so that the signal stands out well from ambient noises normally encountered.

Error and warning messages are logged and can also be displayed at a later time through the menu information (6.7)

8.1 Hints

Warning Messages

Warnings will be indicated

- when the UL1000 and UL1000 Fab detects an abnormal condition or
- when it wants to remind the operator of something (e.g. a request for calibration or a service timer has expired).

The UL1000 and UL1000 Fab will indicate a message on the LC display and will remain in the Stand-by or the measurement mode.

Warning messages will remain on the LC display until the warning has been acknowledged by pressing „OK“ (Key no. 8). After that the UL1000 and UL1000 Fab can be used again (possibly with some restrictions). As long as a warning status exists the status line shows a warning triangle (See Chapter 5.4.3).

The warning messages can be displayed in STANDBY by pressing the button  (shows up when warning message occurred).

Error Messages

Errors are events which force the UL1000 and UL1000 Fab to interrupt its measurement operations. In this case the UL1000 and UL1000 Fab closes all valves (Stand-by mode).

Error messages remain on the LC display until the message has been acknowledged by pressing „Restart“ (key no. 8). After that, the UL1000 and UL1000 Fab restarts with a new run-up procedure. In some cases it may be helpful to check some settings or measured values before the UL1000 and UL1000 Fab restarts. Therefore it is also possible to press „Menu“ (key no. 4 or Menu key) to enter the UL1000 and UL1000 Fab menu. After leaving the menu the same error message will be displayed again.

Notice: Under extreme conditions (unknown software errors, excessively high electromagnetic interference levels) the built-in „watchdog“ circuit will prevent uncontrolled operation of the UL1000 and UL1000 Fab. This watchdog will cause the UL1000 and UL1000 Fab to restart. After having done so, the instrument will be running in the Stand-by mode. No error message will be output.

8.2 List of Errors & Warnings

The following pages contain a list of all errors and warnings displayed at the control panel. Warning messages are indicated by numbers with a leading W. Error messages are indicated by numbers with a leading E.

No.	Displayed Message	Description and possible solutions
E04	Temperature monitoring, turbo molecular pump is defect	Short circuit in the temperature sensor
E05	Temperature monitoring, turbo molecular pump is defect	Temperature sensor disconnected
W15	Leakrae is too high! Machine switched into stand-by to prevent contamination.	The survey function „contamination“ is activated. A leak rate higher than the adjusted value was detected. <ul style="list-style-type: none"> • Gross leak • Switch off limit is set too low • Alarm delay time too short
W16	Turbo molecular pump service interval expired!	The service intervall for the turbo molecular pump is expired.
W17	Forepump service interval expired!	The service intervall for the fore pump is expired.
W18	Exhaust filter service interval expired!	The service intervall for the exhaust filter is expired.
W21	EEPROM write time out	EEPROM defective MC 68 defective
W22	EEPROM parameter queue overflow	EEPROM defective MC 68 defective
E23	24V of the OPTION socket is too high	The tension 24V at socket OPTION is too high.
E24	24V at socket OPTION is too low.	• Fuse F2 on the I/O board has blown
E25	Receded valve voltage too low (< 7V).	• I/O board is faulty.
W28	Real time clock reset! Please enter date and time!	• Battery at MC68 is discharged or faulty. • MC68 had been replaced.
E29	24V supply for fans ist too low (< 20V).	• Fuse F1 on wiring backplane has blown.
E30	24 V of the remote control is too low (> 20V).	• Fuse F1 on the I/O-board has blown.
W31	The offset voltage of the preamplifier is too high (> 5mV).	• The preamplifier is faulty.
W32	Preamplifier temperatur is too high (> 60°C).	• Ambient temperature is too high. • Air filter dirty.
W33	Preamplifier temperature is too low (< 2°C).	• Ambient temperature is too low. • Temperature sensor is faulty.

No.	Displayed Message	Description and possible solutions
E34	24V voltage at MSV board is too low!	Signal MVPZN on the MSV board is active. 24 V signal voltage is too low, $U < 18.3$ V. <ul style="list-style-type: none"> Fuse F1 on the MSV board has blown. 24 V power supply voltage is missing. <i>Switch off the UL1000 and UL1000 Fab!</i> The missing voltage will cause the exhaust valve on the scroll pump to close which in turn can lead to a contamination of the vacuum system. Reference voltage UREF on the MSV board XT7/1 is too high, $U > 5$ V.
E35	Anode-cathode voltage is too high!	<ul style="list-style-type: none"> MSV board is faulty. Anode-cathode voltage is higher than 130 V.
E36	Anode-cathode voltage is too low.	<ul style="list-style-type: none"> MSV board is faulty. Anode-cathode voltage is lower than 130 V.
E37	Suppressor voltage reference value too high!	Signal MFSZH on MSV board is active. Suppressor signal command variable is too high. <ul style="list-style-type: none"> Suppressor voltage has a short circuit. MSV is faulty.
E38	Suppressor potential too high!	Suppressor potential is higher than 363V. <ul style="list-style-type: none"> MSV board is faulty.
E39	Suppressor potential is too low.	Suppressor potential is lower than 297V. <ul style="list-style-type: none"> MSV board is faulty.
E40	The anode potential exceeds its nominal value by over 10%!	The actual anode potential exceeds its nominal value by 10%. The nominal value can be displayed in the service menu. <ul style="list-style-type: none"> MSV is faulty.
E41	The anode potential has dropped below its nominal value by over 10%!	The actual anode potential has dropped below its nominal value by 10%. The nominal value can be displayed in the service menu. <ul style="list-style-type: none"> Air inrush. MSV is faulty.
E42	Nominal value of the anode potential is too high!	Signal MFAZH on MSV board is active. <ul style="list-style-type: none"> Anode voltage has been short circuited. Nominal value of the anode voltage is too high. Anode voltage is limited to about 1,200 V.
E43	Cathode current is too high!	<ul style="list-style-type: none"> Signal MPKZH on MSV board is active. Cathode current is too high, $I > 3.6$ A. MSV is faulty.
E44	Cathode current is too low!	<ul style="list-style-type: none"> Signal MPKZN on MSV board is active. Cathode current is too low, $I > 0.2$ A. MSV is faulty.
W45	Emission for cathode 1 can not be switched on!	Signal MSIBE on MSV board is not active. Emission for cathode 1 can not be switched on. UL1000 and UL1000 Fab switches to cathode 2. Please order a new ion source.
W46	Emission for cathode 2 can not be switched.	Signal MSIBE on MSV board is not active. Emission for cathode 2 can not be switched on. UL1000 and UL1000 Fab switches to cathode 1. Order a new ion source.

No.	Displayed Message	Description and possible solutions
E47	Emission for both cathodes can not be switched on!	Signal MSIBE on MSV board is not active. Emission can not be switched on. Exchange the cathode by changing the ion source. After having exchanged the ion source it must be possible to switch on both cathodes manually via the service menu.
E48	Anode heater is faulty!	Signal MSAFD on MSV board is active. Anode heater fuse has blown. Replace fuse F2 on the MSV board.
E50	No communication with turbo pump.	Clock from the frequency converter has failed. No communication to the frequency converter.
E52	TMP frequency is too low!	<ul style="list-style-type: none"> • TMP frequency is too low! • Frequency converter is faulty. • Turbomolecular pump is faulty.
W53	Temperature at electronic unit is too high (>55°C)	<ul style="list-style-type: none"> • Ambient temperature too high. • Ventilation failure. • Air filter dirty and have to be changed.
E54	Temperatur at electronic unit is too high (>60°C).	<ul style="list-style-type: none"> • Ambient temperature is too high. • Internal ventilation has failed. • Air filters are dirty and must be exchanged.
W55	Temperature at electronic unit is too low (< 2°C)	<ul style="list-style-type: none"> • The temperature sensor on the wiring plane indicates $T < 2\text{ °C}$. Run-up time for the forevacuum pump will be longer. • Temperature sensor is faulty.
E56	Inlet pressure p1 too low!	$U < 0,27\text{ V}$; Cathode faulty. Change thermovac-sensor that measures p1.
E58	Foreline pressure p2 too low!	$U < 0,27\text{ V}$; Cathode faulty. Change thermovac-sensor that measures p2.
E60	p2 > 10 mbar after 5 minutes since power on	PV > 3.8 mbar after $t > 5$ minutes since switching on. Run-up time of the forevacuum pump is too long. <ul style="list-style-type: none"> • Forepump is faulty. • Valve V2 does not open.
E61	Emission fail.	Emission should be switched on. MSV subassembly indicates a fault. MENB emission current not within range.
W62	Flow through capillary to low.	In the sniffer mode the intake pressure of the sniffer line is controlled. If the pressure falls below the minimum limit, the flow through the capillary is too low (contamination) or the capillary is blocked (foreign objects, particles). The minimum limit can be set by the menu. Default value is 0.1 mbar. 6.6.1.3.
W63	Capillary broken	In the sniffer mode the intake pressure of the sniffer line is controlled. If the pressure exceeds the maximum limit, the flow through the capillary is too high (no leak tightness, broken capillary). The maximum limit can be set by the menu. Default value is 1.0 mbar. 6.6.1.3.
E73	Emission off (p2 too high)	PV $\gg 0.2$ or 3 mbar due to an inrush, e. g. The UL1000 and UL1000 Fab will again try to resume the measurement mode.
W76	Maximum of evacuation time was exceeded.	<ul style="list-style-type: none"> • Test sample has got a GROSS leak. • False adjustments of the max. time of evacuation.

No.	Displayed Message	Description and possible solutions
W77	Peak not in Range	The signal maximum has shifted to mass range alignment limits. <ul style="list-style-type: none"> • Signal of leak rate was instable during mass adjustment. Calibrate again. • Check the basic setting for the anode voltage through the service menu. • Check calibrated leak.
W78	Differences of signal between test leak open and closed is too low.	The amplifier voltage difference between opened and closed calibrated leak is less than 10 mV. Calibrated leak has not been closed properly.
W79	Signal of test leak is too small	Calibrated leak is too small or has not been opened. Preamplifier voltage < 10 mV.
W80	Please calibrate machine newly	The automatic request of calibration is activated (7.2.1.1) and has fulfilled at least one of the conditions: <ul style="list-style-type: none"> • 30 minutes are passed since energizing. • Temperature of the pre-amplifier has changed more than 5°C since the last calibration. • Massadjustments were changed.
W81	CAL Factor too low	The calculated factor falls out of the valid range (< 0,1). The old factor is retained. Possible fault cause: <ul style="list-style-type: none"> • The conditions for calibration have not been maintained. • The leak rate of the internal calibrated leak which was entered is much too small. • The internal test leak is defect.
W82	CAL Factor too high	The calculated factor is out of the valid range (> 10). The old factor is retained. Possible fault cause: <ul style="list-style-type: none"> • The conditions for calibration have not been maintained. • The leak rate of the internal calibrated leak which was entered is much too high or much too small. • The internal test leak is defect or empty.
W83	All EEPROM parameter lost. Please check your settings.	<ul style="list-style-type: none"> • EEPROM on back plane is empty and was initialized with default valves. Enter all parameters again. • The EEPROM might be faulty when warning comes up again after power up.
W85	Lost EEPROM parameter! Please check your settings!	<ul style="list-style-type: none"> • Writing access was interrupted. Please check all adjustments. • An update of software was done. In this case the notice can be ignored. • When warning comes up again after powering up the EEPROM might be faulty.
W86	AC/DC factor too low	Calibration conditions not maintained Value of leak rate not entered correctly Test leak faulty
W87	AC/DC factor too high	Calibration conditions not maintained Value of leak rate not entered correctly Test leak faulty

9 Maintenance Work

9.1 General Information

Service level II and III maintenance work on the UL1000 Fab/UL1000 must only be performed by personnel expressly authorised for this work by INFICON GmbH Cologne.

Here note the corresponding service levels:

- Service level I Customer
- Service level II Customer with technical training
- Service level III Authorised INFICON service technician



Caution

Please note the corresponding safety information in this chapter.



Caution

During work on the vacuum system make sure that the work environment is clean and always use clean tools.



Danger

During all maintenance work on the UL1000 and UL1000 Fab/UL1000 be sure to disconnect the leak detector from the mains power!

Notice: Complying with the maintenance plan given in the following is mandatory for the UL1000 and UL1000 Fab/UL1000. If the corresponding maintenance intervals are not complied with, this will then void your warranty for this equipment.

Signing a maintenance contract for this equipment is recommended.

As soon as the different maintenance intervals are reached, a warning is displayed on the screen of the leak detector of the UL1000 and UL1000 Fab/UL1000 each time it is switched on. This message will remain on the display until the maintenance interval has been acknowledged.

Depending on the application the leak detector is used in, the 1500 hrs maintenance can be varied.

9.2 Maintenance or Service at INFICON

When returning equipment back to INFICON for repair or maintenance, please state whether the equipment is free of substances which pose a health hazard or if it is contaminated. If it is contaminated please state the type of hazard. For this you must use a form „Declaration of Contamination“ which we have prepared for you and which we will mail to you upon request. A copy of this form which you may copy is printed at the end of this manual.

Please affix the form to the equipment or enclose it!

The „Declaration of Contamination“ is required by us to comply with the laws and to protect our staff. Equipment received without a „Declaration of Contamination“ must be returned by INFICON to the sender.

9.3 Key to the Maintenance Plan

- I Service level I Customer
- II Service level II Customer with technical training
- III Service level III Authorised INFICON service technician
- X Run maintenance work after operating hours or period of time
- X₁ No time limitation, operating hours only
- X₂ No operating hours limitation only period of time
- 1 Depending on environment and usage
- 2 Process dependent

UL1000 only

As a preventive measure it is recommended to check in the case of the UL1000 once per month the oil level and the colour of the oil of the rotary vane pump. The oil change intervals for the oil of the D16B backing pump are recommendations and may vary depending on the way in which the leak detector is used.

The pump has been specified for use in the leak detector UL1000 with Arctic Oil and must for this reason be filled with Arctic Oil (Part No. 20099091) only.

When using any other kind of oil, INFICON GmbH Cologne must reject all warranty claims relating to the backing pump.

9.4 Maintenance Plan

Subassembly	Maintenance work UL1000 / UL1000 Fab	Operating hours/years					Service level	Spare part number
		1500	4000	8000	16000	24000		
		1/4	1	2	3	4		
Vacuum system								
Backing pump D16 B	Check oil level, if required exchange	X					I & II	
	Exchange the oil	2	X				II	20099091
	Refurbish backing pump				X		III	
Scroll pump Agilent TS 620	Exchange the tip seal			X ₁			III	200001671
	Exchange the scroll head				X		III	200001665R
SplitFlow 80	Exchange the operating agent reservoir				X ₂		II u. III	200003801
	Bearing exchange					X ₂	III	
Valve block	Clean the valves, replace valve seals		2	X			III	200000594
	Disassemble and clean the valve block			2	X		III	200000593
	Replace filter of vent and purge gas line		1	X ₁			I, II, III	200000683
	Align Pirani gauge			X			III	
Silencer UL1000 Fab	Replace	X ₁					I, II, III	20099183
Exhaust filter UL1000	Check, empty	X					I, II, III	
	Replace filter insert			X ₁			I, II, III	200000694
Electrical system								
Fan subassemblies	Blow out fan chassis wall and bottom	1	X ₁				I	
	Replace replacement filter cell for chassis wall fan	1	X ₁				I	200000685

9.5 Maintenance Groups

For better overview the maintenance plan for the UL1000 and UL1000 Fab/UL1000 can be subdivided in to 4 maintenance groups.

- 1500 hours maintenance
- 4000 hours maintenance, at least once a year
- 8000 hours maintenance
- 16000 hours maintenance

9.5.1 1500 Hours Maintenance

The 1500 hours maintenance can be performed by an operator or maintenance staff of the customer.

For performing the 1500 hrs maintenance, the filter cell in front of the fans must be checked and, if contaminated, replaced. When using the leak detector in a very dusty environment, the service intervals should be adapted to the shorter operating hours.

The silencer at the exhaust of the leak detector must be replaced.

Notice: Blocked silencers can result in further damage to the scroll pump.

Work to be done	Required materials	Part No.
Check/replace filter	Replacement filter cell for the fan	200000685
Replace silencer	Silencer for exhaust (UL1000 Fab only)	20099183

9.5.2 4000 Hours Maintenance

The 4000 hours maintenance work should be done by an INFICON service technician or a person authorised by INFICON, were by this work should be done once a year. The operating agent reservoir of the turbomolecular pump and the oil of the backing pump in the UL1000 must be exchanged at least once a year SplitFlow 80.

Notice: The internal helium calibrated leak has a certificate which is valid for 1 year after delivery of the leak detector. It is recommended to have this certificate renewed yearly by INFICON GmbH. Here the internal helium calibrated leak is checked as to all its functions and a new certificate is issued for a further year.

Work to be done	Required materials	Part No.
Exchange the oil of the D16 backing pump (UL1000 only)	Arctic Oil 1l	20099091
Check/replace the filter	Replacement filter cell for fan	200000685
	Replacement filter for venting and purge gas line	200000683
	Silencer for exhaust (UL1000 Fab only)	20099183
	Oil filter insert (10 pcs.) UL1000 only	200000694
Test and alignment		
Replace operating agent reservoir of SplitFlow 80 only in case a 3 year time period has elapsed. Please refer to 9.5.5 .	Operating agent reservoir for SplitFlow 80	200003801

Approximately 2.5 hours will be needed for this maintenance work, but will vary in case that operating agent reservoir is exchanged.

9.5.3 8000 Hours Maintenance

The 8000 hours maintenance work should be done by an INFICON service technician or a person authorised by INFICON.

For the scroll module of the Agilent scroll pump, the „tip seal“ must be replaced by an INFICON service technician as soon as 8000 operating hours are attained. If the „tip seal“ is not replaced, it will become necessary to replace the scroll module after 12000 operating hours.

Work to be done	Required materials	Part No.
Replace tip seal (Agilent TS 620)	Tip seal	200001671
Exchange oil for the D16 backing pump (UL1000)	Arctic Oil 1l	20099091
Replace valve seals	Seal kit for valves	200000594
Check/replace filter	Replacement filter cell for fan	200000685
	Replacement filter for venting and purge gas line	200000683
	Silencer for exhaust (UL1000 Fab only)	20099183
	Oil filter insert (10 pcs.) UL1000 only	200000694
Test and alignment		
Replace operating agent reservoir of SplitFlow 80 only in case if a 3 year time period has elapsed. Please refer to 9.5.5 .	Operating agent reservoir for SplitFlow 80	200003801

Approximately 6.0 hours will be needed for this maintenance work. For the replacement of the „Tip Seal“ additionally 3 hours are necessary.

9.5.4 16000 Hours Maintenance

The 16000 hours maintenance work should be done by an INFICON service technician or a person authorised by INFICON.

As soon as 16000 operating hours have been attained, the life expectancy of the various backing pump types has been reached.

Scroll module Agilent TS 620 will have to be replaced. For the D16 B in the UL1000 a refurbishment will be necessary.

Work to be done	Required materials	Part No.
Replace scroll head (Agilent TS 620)	Scroll head for Agilent TS 620	200001665R
Refurbish D16 backing pump (UL1000 only)	Refurbished D16 B backing pump	
Disassemble/clean the valve block	Seal kit for valve block	200000593
Replace the valve seals	Seal kit for valves	200000594
Check/replace filter	Replacement filter cell for fan	200000685
	Replacement filter for venting and purge gas line	200000683
	Silencer for exhaust (UL1000 Fab only)	20099183
	Oil filter insert (10 pcs.) UL1000 only	200000694
Preventive exchange of the SplitFlow 80 after 3 years, without limitation of operating hours. Please refer to 9.5.5	Refurbished turbopump SplitFlow 80.	200003800R
Test and alignment		

Approximately 10.0 hours will be needed for this maintenance work, in case that SplitFlow 80 was exchanged.

9.5.5 Notes referring the maintenance of the SplitFlow 80

To lubricate the ball bearings, the turbo molecular pump SplitFlow 80 is filled with and operating fluid. Replace the operating fluid every 3 years, no matter for how many operating hours the turbo pump has been operated. The operating fluid reservoir should be replaced by an INFICON authorized person or service technician.

Under high load operating conditions or when used in connection with processes involving contamination, shorter replacement intervals need to be selected.

If the turbopump should be shut down for longer than a year the operating fluid reservoir must be changed first.

The recommended bearing exchange of the SplitFlow 80 is 4 years, no matter for how many operating hours the pump has been used. The replacement of the pump is recommended for those customer, who has to guarantee a 100% up-time for the unit. In this case the turbopump SplitFlow 80 will be replaced by a refurbished pump.

9.6 Description of the Maintenance Work

Modifications to the UL1000 and UL1000 Fab/UL1000 which exceed the scope of normal maintenance work must only be performed by trained personnel.

Danger

The protective ground conductor distributor screw at the bottom of the chassis must not be loosened. If the protective ground conductor connection is not in place, the operator will not be protected against electric shock.

9.6.1 Opening the Instrument for Maintenance Purposes

Required tools

Side wall separator (Plastic wedge) from the accessories.

STOP
Danger

Before removing one of the covers of the UL1000 and UL1000 Fab/UL1000 the leak detector must be disconnected from the mains power!

- Vacuum components which are fitted to the inlet of the UL1000 and UL1000 Fab/UL1000 must be disconnected from the inlet system.
- As shown in Fig. 1-1, insert the side wall separator between cover and chassis and press it down until the cover disengages. Press the cover on both sides out of the holder. Slightly fold the cover outwards and lift it out of the guide pins in the bottom of the instrument.
- The correct position where to apply the side wall separator is marked by a dent on both the covers. For this refer to [Fig. 9-1/2](#).
- Open both covers in the same way.

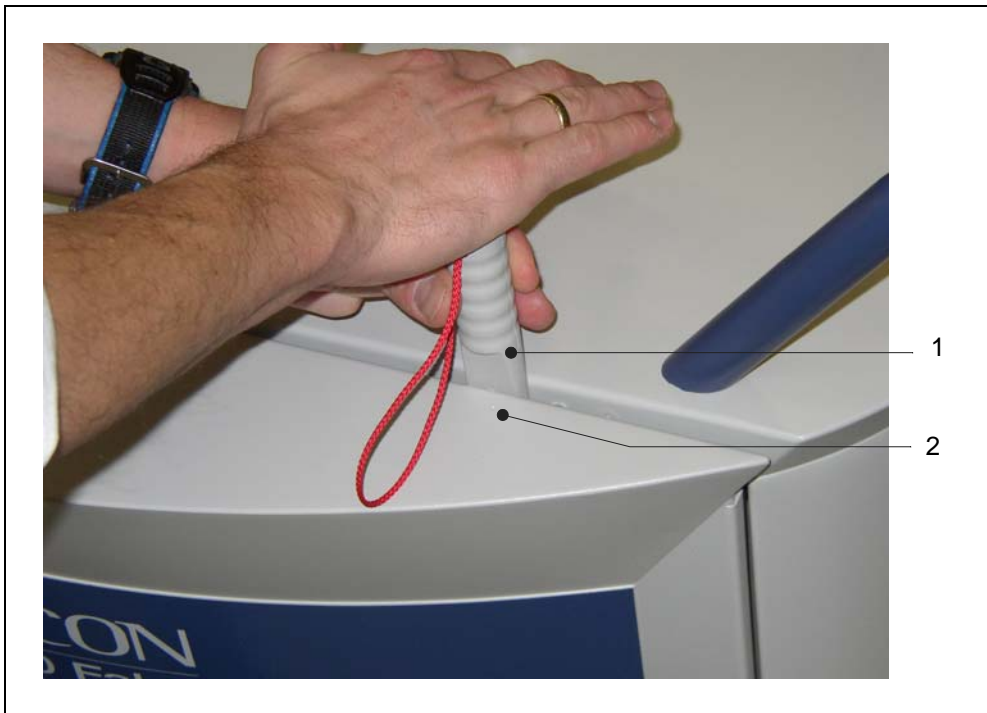

Fig. 9-1 Opening the UL1000 and UL1000 Fab/UL1000

Item	Description	Item	Description
1	Side wall separator	2	Dent in the side wall

9.7 Checking and Replacing the Filter Insert

The extent to which the air filter insert in front of the fans is contaminated should be checked every three months (under aggravated conditions, monthly). Contaminated filter inserts must be exchanged since under such circumstances the cooling performance for the turbomolecular pump and the instrument itself is reduced.

Required tools

Side wall separator from the accessories

Required material

Replacement filter insert P/N 200 000 685



Danger

Before removing one of the covers of the UL1000 and UL1000 Fab/UL1000 the leak detector must be disconnected from the mains power!

- To open the leak detector, refer to Chapter [1.6.1](#)
- Take hold of the filter insert with two fingers at the locations shown in Fig. 1-2/a and pull the filter insert out of the guide. Should this not be possible, use a tool to press the filter through the rear ejection bore [Fig. 9-2/3](#) to the front.

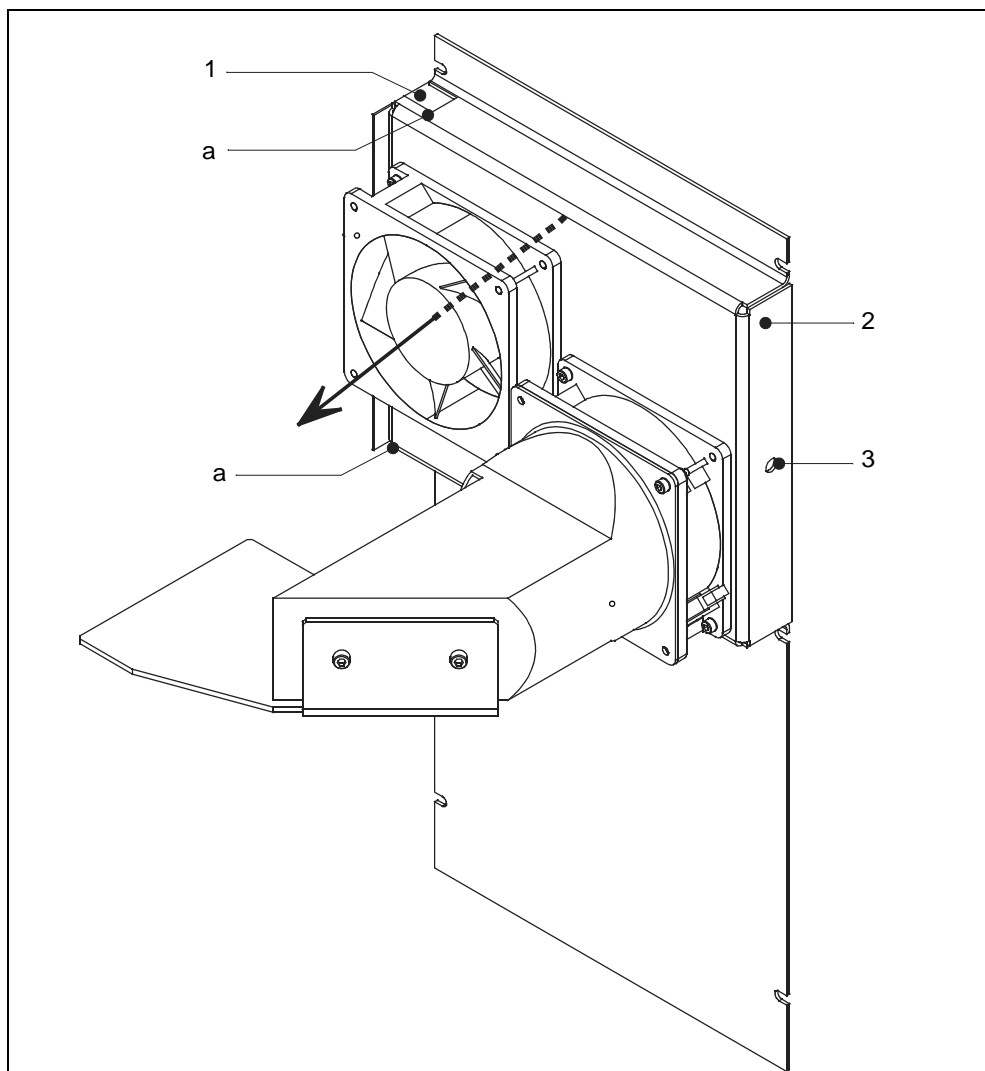

Fig. 9-2 Replacement of the air filter in the chassis wall

Item	Description	Item	Description
a	Air filter cut out	2	Air filter guide
1	Air filter insert	3	Ejection bore (rear)

- When inserting the new air filter insert, note the direction of the air flow. It is indicated in the figure above Fig. 9-2 by a black arrow.

Notice: The side of the filter insert marked „clean air side” or the white surface of the filter insert must point in the direction of the fans.

- Push the filter insert into the guide and place the covers back on. To close the instrument, insert the covers and press these on.

9.8 Replacing the Exhaust Silencer

Required material

Replacement silencer P/N 200 99 183

- Switch the UL1000 Fab leak detector off.
- Unscrew the silencer from the connection adapter and replace it by the new silencer and tighten it. For this refer to [Fig. 9-3/1](#).

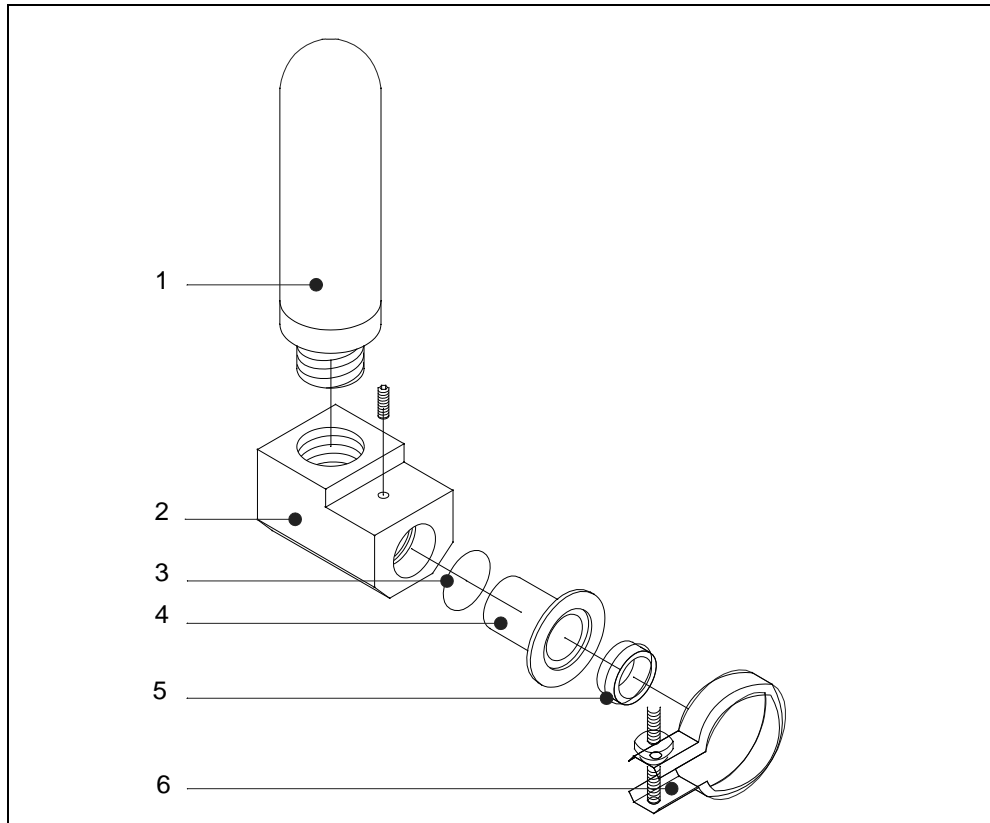

Fig. 9-3 Replacing the silencer

Item	Designation	Item	Designation
1	Silencer	4	Reducer
2	Adapter for silencer	5	Centering ring DN 25
3	O-ring 20 x 3	6	Clamping ring clip

9.9 Checking/Emptying the Exhaust Filter

Required tools

Ring/open jaw spanner, size 17 mm

It is the task of the exhaust filter to filter out the oil mists which are produced when taken in air is ejected during a pumpdown process. For safety reasons the exhaust filter is equipped with a valve which in the case of a blocked filter opens and passes the taken in air directly to the outside. This helps to prevent damage to the backing pump by a blocked exhaust line.



Danger

In the case of a blocked exhaust filter, toxic oil vapours are directly emitted into the environment!

The condition of the exhaust filter should, for this reason, be checked in regular intervals. As soon as the oil level in the oil reservoir vessel reaches approximately one third of the maximum filling quantity, the oil reservoir vessel needs to be emptied.

To empty the oil reservoir vessel proceed as follows:

- Switch the instrument off and remove the side covers. For this refer to Chapter 1.6.1.



Danger

Before removing one of the covers of the UL1000 and UL1000 Fab/UL1000 the leak detector must be disconnected from the mains power!

- Loosen the hexagon screw at the bottom of the reservoir vessel and drain the oil into a suitable vessel. For this refer to Fig. 1-5/5. Dispose of the oil in accordance with the local waste disposal regulations.
- Screw in the hexagon screw again and tighten it.
- Check the oil level of the D16 B rotary vane pump and top up oil as required.

9.9.1 Replacing the Filter Insert

Required tools

Side wall separator from accessories

Required material

Replacement filter insert: P/N 200 000 694 (10 pcs.)

The installation location for the exhaust filter is given in [Fig. 9-4](#) below.

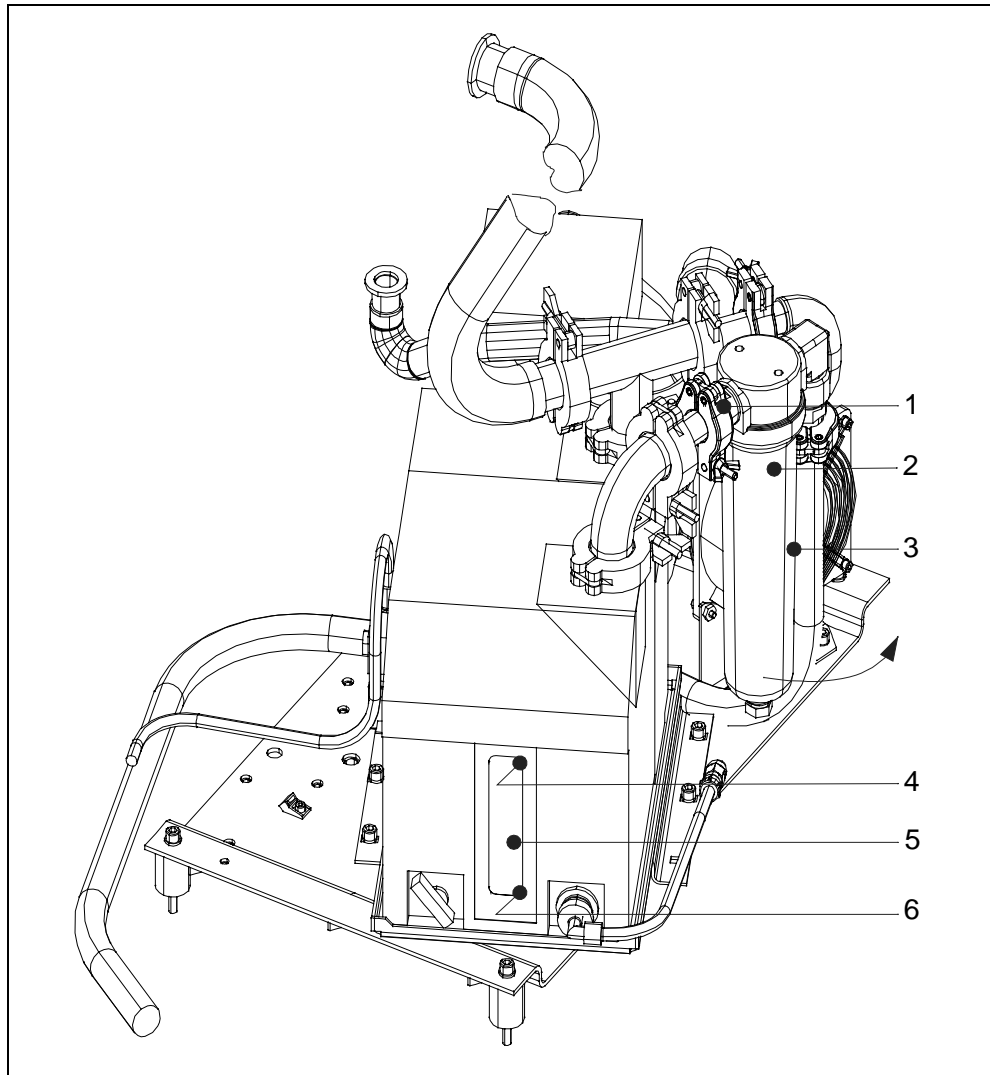

Fig. 9-4 Installation location of the exhaust filter

Item	Description	Item	Description
1	Clamping ring KF 16	4	Maximum oil level mark
2	Filter insert	5	Oil level viewing glass
3	Oil reservoir vessel	6	Maximum oil level mark

To exchange the filter insert proceed as follows:

- Loosen the clamping ring at the exhaust filter (Fig. 9-4/1) and swivel the complete filter in the direction of the arrow outwards to such an extent that the oil reservoir vessel can be removed.
- Turn out the oil reservoir vessel in the counter-clockwise direction and empty it. Dispose of the oil in accordance with the local regulations. Clean the reservoir vessel with a clean piece of cloth.
- Manually loosen the filter holding screw Fig. 9-5/3, take out the filter insert and properly dispose of it.



Fig. 9-5 Filter insert exhaust filter

Item	Description	Item	Description
1	Filter cover	4	Oil reservoir vessel
2	Filter insert	5	Oil drain plug
3	Filter holder		

- Push the new filter insert onto the holder and screw it into the filter cover. Manually tighten the holder using the knurling.
- Finally screw in the oil reservoir vessel and tighten it manually. Swivel the exhaust filter back in and affix it with the KF16 clamping ring at its original installation position.

9.10 Monitoring the Oil Level of the D16 B and Topping up the Oil

As a preventive measure it is recommended to check the oil level and the colour of the pump oil once a month.

To open the instrument, observe the instructions given in Chapter 1.6.1.

STOP
Danger

Before removing one of the covers of the UL1000 and UL1000 Fab/UL1000 the leak detector must be disconnected from the mains power!

Required tools

Side wall separator

Through the oil level viewing glass of the backing pump D16B the oil level and the colour of the oil can be checked visually. The oil level of the vacuum pump must be within the minimum and maximum marks. For this refer to [Fig. 9-6/3-5](#).

Notice: Check and top up oil only after the pump has been switched off!

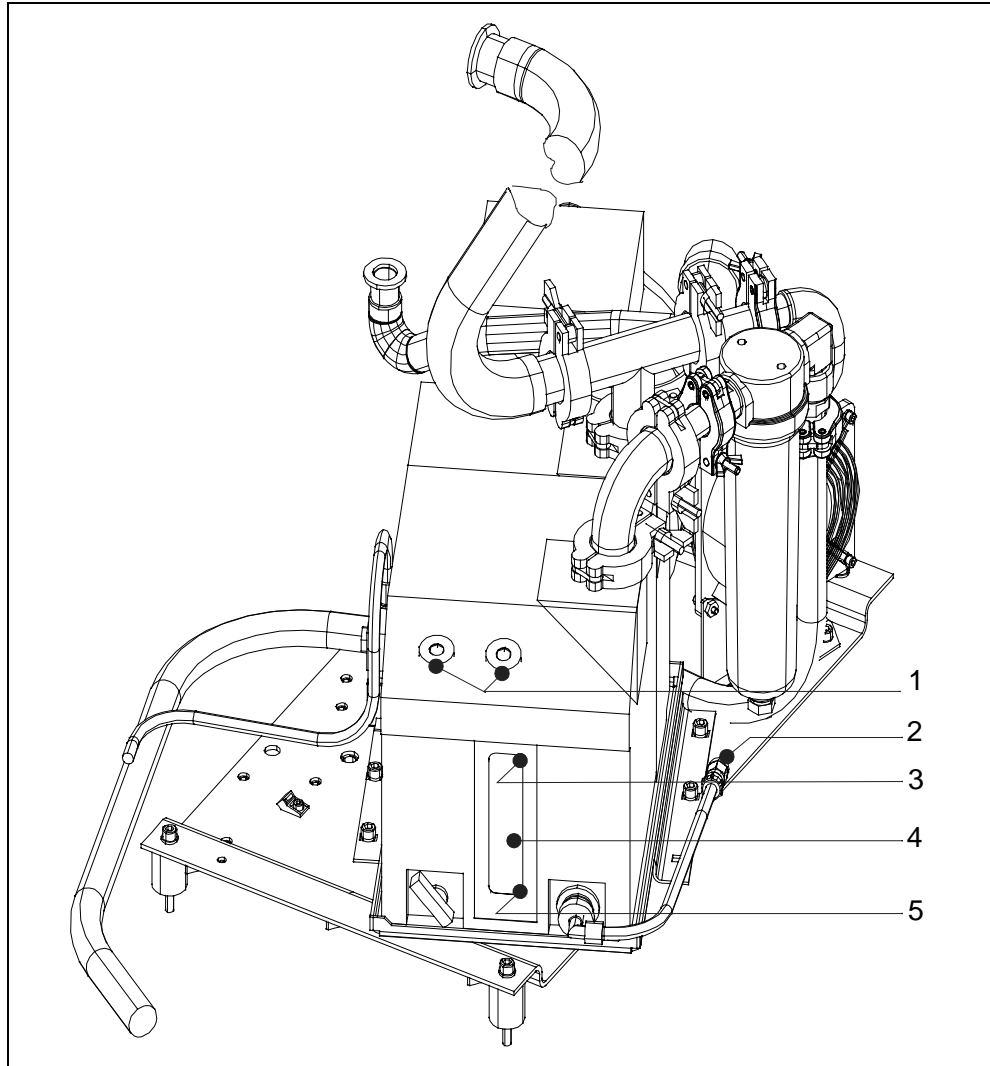

Fig. 9-6 Oil change for the D16 B

Item	Description	Item	Description
1	Oil fill opening	4	Oil level viewing glass
2	Oil drain plug	5	Minimum oil level mark
3	Maximum oil level mark		

- If the oil level is below the minimum mark, top up oil. For this note the instructions given in [9.11](#).

9.11 Oil Change for the D16B

The oil must be exchanged when it looks contaminated or is chemically or mechanically worn out.

Further oil changes should be done before and after storing the pump for a longer period of time.



Caution

Exchange the oil always while the vacuum pump is still warm and with the vacuum pump switched off!

Required tools

Side wall separator

Hexagon socket screw key, size 5 mm; 8 mm

Open jaw spanner, size 13 mm

Required material

Artic oil 1 l. P/N 200 99 091

- Switch the instrument off and remove the covers. To open the instrument, observe the instructions given in [9.6.1](#).
- Cut the cable straps for the oil drain hose and run the drain hose to the oil collection vessel.
- With a 5 mm hexagon socket screw key unscrew the oil drain plug at the hose end. Use the 13 mm open jaw spanner for counteracting.
- Drain the waste oil into a suitable vessel. As soon as the oil flow reduces, screw the oil drain plug back in.
- Switch the pump on briefly (10 s max.) and switch it off again. Remove the oil drain plug again and let the remaining oil drain out.



Caution

Oil may damage the environment! For this reason dispose of it properly and in line with the applicable environment regulations.

- Screw the oil drain plug back in again. Check the gasket and replace it if required. Affix the oil drain hose with a cable strap again.
- Unscrew oil fill plug [Fig. 9-6/1](#) from the oil fill opening and top up fresh oil up to the maximum level. The maximum amount of oil is 0.8 litres.
- Screw the oil fill plug back in again and tighten it.

Notice: After starting up, the fresh oil should be degassed. For this let the leak detector operate in the „STAND BY“ mode and leave the gas ballast open for approximately 20 minutes.

9.12 Scroll Pumps (UL1000 and UL1000 Fab only)

The maintenance intervals of the scroll pump (Agilent TS620) is given in the maintenance plan detailed in [9.4](#).

We recommend to have this maintenance work done by the INFICON Service or a service partner authorised by INFICON.

Appendix

A Diagram

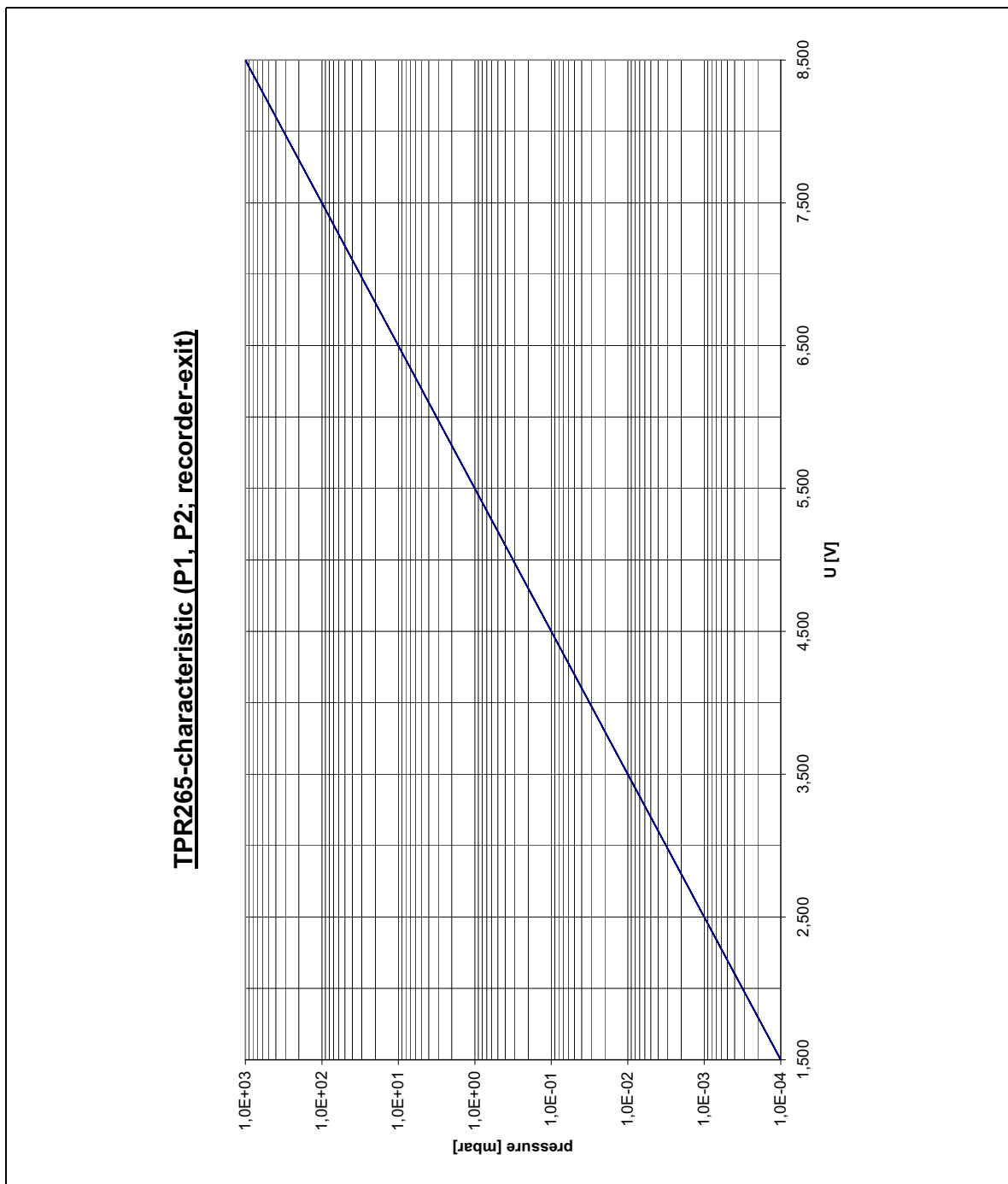

Fig. 10-1

technical handbook

(1111)

iina70e-appendix.fm

B Index

A		H	
Access Control	87	Hand Set	27, 31
Accessories	27–28	Helium leak rate	15
alarm	63	Humidity	16
Ambient temperature	16		
Audio alarm	16	I	
Automatic Internal Calibration	89	I CAL	80
		INFICON Service	11
		information	85
B		Inlet area background suppression	73
background	57	Inlet Port	32
built-in leak standard	88	Inlet port	15
		Inlet pressure	15
C		Installation	21
Calibration	65	Ion source	15
calibration	34	ion source	39
contract			
• maintenance and service	10	L	
contrast	56	language	79
Control Panel	40	Leak rate	15
		loud speaker	50
D			
Detectable masses	15	M	
Digital In	29	Machine factor	69
Digital Out	27–28	maintenance contract	10
Dimensions	16	Manual Internal Calibration	89
		Mass spectrometer	15
E		mass spectrometer	39
Electrical Connections	25	Measurement range	15
Exhaust	32	MENU	40
exhaust filter	79	Mode	
external calibration	89	• Sniffer	15
		• Vacuum	15
F			
FINE	45	N	
FINE only	68	Noise level	16
G		P	
Gas ballast	32	Pinpoint	64
GROSS	45		

Power		Trigger	50
• consumption	15	Trigger alarm	64
pressure	40	turbo pump	45
Protection		turbomolecular pump	39
• Type of	15	Type of protection	15
Pumping speed	15		
Purge	27, 32	U	
Purging	49	ULTRA	45
Purpose	13	ULTRA only	68
		V	
Q		Vacuum Diagramm	39
QT100	47	Vacuum mode	15
		Valves	16
R		Vent	27, 32
Recorder	27, 30	volume	62
Relay Output	61		
RS232	27, 31	W	
run-up mode	48	Weight	16
Run-up time	15		
		Z	
S		Zero	73
Safety Symbols	7	ZERO Button	36
scroll pump	45		
Service Center	11		
service contract	10		
Setpoint	64		
sniff mode	47		
sniffer line	38, 47		
Sniffer mode	15		
START Button	35		
Startup	34		
STOP Button	36		
Storage temperature	16		
T			
Temperature			
• ambient	16		
• storage	16		
time axis	51		
Time&Date	79		
Transportation	21		
trend mode	51		

C Declaration of Conformity



EC Declaration of Conformity

We – INFICON GmbH - herewith declare that the products defined below meet the basic requirements regarding safety and health of the relevant EC directives by design, type and the versions which are brought in to circulation by us.

In case of any products changes made without our approval, this declaration will be void.

Designation of the product:

Helium Leak Detector

Models: **UL 1000**
UL 1000 Fab

Catalogue numbers:

550-000A 550-100A
550-001A 550-101A
550-002A

The products meet the requirements of the following directives:

- **Directive on Low Voltage**
(2006/95/EC)
- **Directive on Electromagnetic Compatibility**
(2004/108/EC)
- **Directive on Machinery**
(2006/42/EC)

Applied harmonized standards:

- **EN 61010 - 1 : 2001**
- **EN 61000-6-4 : 2002 Part EN 55011 Class B**
- **EN 61000-6-3 : 2002 Part EN 61000-3-2**
- **EN 61000-6-2 : 2005 Parts EN 61000-4-2**
EN 61000-4-3
EN 61000-4-4
EN 61000-4-5
EN 61000-4-6
EN 61000-4-11
- **DIN EN ISO 12100-1 / DIN EN ISO 12100-2**

Cologne, June 07, 2011

Dr. Döbler, Manager

Cologne, June 07, 2011

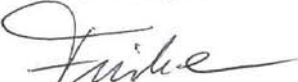
Finke, Research and Development

ul1000.07.06.2011.engl.doc

INFICON GmbH
Bonner Strasse 498
D-50968 Cologne
Tel.: +49 (0)221 56788-0
Fax: +49 (0)221 56788-90
www.inficon.com
E-mail: leakdetection@inficon.com



INFICON GmbH, Bonner Strasse 498, D-50968 Cologne, Germany

UNITED STATES TAIWAN JAPAN KOREA SINGAPORE GERMANY FRANCE UNITED KINGDOM HONG KONG

Visit our website for contact information and other sales offices worldwide. www.inficon.com

Dokument: iina70e1-I (1111)