



E505xA SSA-X Signal Source Analyzer

E5055A 1 MHz to 8 GHz

E5056A 1 MHz to 26.5 GHz

E5057A 1 MHz to 44 GHz

E5058A 1 MHz to 54 GHz



Table of Contents

Definition	3
Phase Noise Measurement.....	4
AM Noise Measurement.....	14
Residual Phase Noise/AM Noise Measurement.....	19
Source Output (available when option 15x/16x or 25x/26x).....	23
Baseband Noise Measurement.....	27
DC Voltage Output.....	28
VCO Characterization Measurements (required S96301xB SSA-X Signal Source Analyzer advanced features for E505xA).....	29
Transient Measurement (required S96301xB SSA-X Signal Source Analyzer advanced features for E505xA).....	31
Transient Measurement/Wideband Mode.....	33
Transient Measurement/Narrowband Mode.....	34
External Mixer Support.....	36
Spectrum Measurement (required S96301xB for Spectrum monitor capability and S96390xB for full span / capability of spectrum analysis).....	37
Precision clock jitter analysis (required S96302B Precision Clock Jitter Analysis for SSA-X Signal Source Analyzer).....	39
Pulsed-RF Phase Noise Measurements (required S96325B Pulsed-RF measurements for SSA-X Signal Source Analyzer).....	39
Vector Network Analyzer.....	41
Dynamic Range.....	41
Corrected System Performance.....	42
Uncorrected System Performance.....	50
Test Port Output	52
Test Port Input.....	55
Pulsed-RF Measurements	60
Internal Timebase	63
General Information	63
EMC, Safety, Environment and Compliance.....	66
Weight and Dimensions	67
Software on E505xA SSA-X Signal Source Analyzer.....	71
Web Sources.....	71
Confidently Covered by Keysight Services.....	72

Definition

Specification (spec.)¹

Warranted performance. Specifications include guardbands to account for the expected statistical performance distribution, measurement uncertainties, and changes in performance due to environmental conditions. All specifications and characteristics apply over a $25\text{ °C} \pm 5\text{ °C}$ range (unless otherwise stated).

The following conditions must be met:

- Instrument has been turned on for 90 minutes with SSA-X application running.
- Instrument is within its calibration cycle.
- Instrument remains at a stable surrounding environment temperature (between 0 °C to 40 °C) for 60 minutes prior to turn-on.

Characteristics (char.)

A performance parameter that the product is expected to meet before it leaves the factory, but that is not verified in the field and is not covered by the product warranty. A characteristic includes the same guardbands as a specification.

Typical (typ.)

Expected performance of an average unit at a stable temperature between $25\text{ °C} \pm 5\text{ °C}$ for 60 minutes prior to turn-on and during operation; does not include guardbands. It is not covered by the product warranty. The instrument must be within its calibration cycle.

Nominal (nom.)

A general, descriptive term or design parameter. It is not tested, and not covered by the product warranty.

Supplemental information

A performance parameter that is tested on sampled product during design validation. It does not include guardbands and is not covered by the product warranty.

Calibration

The process of measuring known standards to characterize an instrument's systematic (repeatable) errors.

Corrected (residual)

Indicates performance after error correction (calibration). It is determined by the quality of calibration standards and how well "known" they are, plus system repeatability, stability, and noise.

Uncorrected (raw)

Indicates instrument performance without error correction. The uncorrected performance affects the stability of a calibration.

1. For all tables in this data sheet, the specified performance at the exact frequency of a break is the better value of the two specifications at that frequency.

Phase Noise Measurement

Table 1. Phase noise measurement performance

Description	Specification (E5055A)	Specification (E5056A/57A/58A)
RF frequency range	1 MHz to 8 GHz (E5055A)	1 MHz to 26.5 GHz (E5056A) 1 MHz to 44 GHz (E5057A) 1 MHz to 54 GHz (E5058A)
Minimum offset frequency	1 mHz	
Maximum offset frequency ^{1,2}	<p>Max. offset extension mode: OFF (default)</p> <p>300 kHz: 1 MHz ≤ carrier ≤ 2 MHz 1 MHz: 2 MHz < carrier ≤ 7.6 MHz 3 MHz: 7.6 MHz < carrier ≤ 28 MHz (Offset is settable up to 5 MHz) 10 MHz: 28 MHz < carrier ≤ 41 MHz 30 MHz: 41 MHz < carrier ≤ 152 MHz 100 MHz: 152 MHz < carrier ≤ 502 MHz 300 MHz: 502 MHz < carrier ≤ 1.61 GHz 1 GHz: 1.61 GHz < carrier ≤ 7.19 GHz 300 MHz: 7.19 GHz < carrier < 7.89 GHz 100 MHz: 7.89 GHz ≤ carrier ≤ 8 GHz</p> <p>Max. offset extension mode: ON</p> <p>8 GHz: 51 MHz < carrier < 150 MHz 3 GHz: 150 MHz ≤ carrier < 5.19 GHz</p>	<p>Max. offset extension mode: OFF (default)</p> <p>300 kHz: 1 MHz ≤ carrier ≤ 2 MHz 1 MHz: 2 MHz < carrier ≤ 7.6 MHz 3 MHz: 7.6 MHz < carrier ≤ 28 MHz (Offset is settable up to 5 MHz) 10 MHz: 28 MHz < carrier ≤ 41 MHz 30 MHz: 41 MHz < carrier ≤ 152 MHz 100 MHz: 152 MHz < carrier ≤ 502 MHz 300 MHz: 502 MHz < carrier ≤ 1.61 GHz 1GHz: 1.61 GHz < carrier ≤ 54 GHz</p> <p>Max. offset extension mode: ON</p> <p>8 GHz: 51 MHz < carrier < 150 MHz 3 GHz: 150 MHz ≤ carrier < 54 GHz</p>
Offset setting resolution	1 – 3 steps + 5 MHz, 20 MHz + Arbitral frequency above 100 MHz offset	
Input power range	-20 dBm to +20 dBm -50 dBm to +20 dBm (typ.) (Enable search off)	<p>-20 to +20 dBm: 1 MHz ≤ carrier ≤ 8 GHz -15 to +20 dBm: 8 GHz < carrier ≤ 40 GHz -10 to +20 dBm: 40 GHz < carrier ≤ 50 GHz 0 to +20 dBm: 50 GHz < carrier ≤ 54 GHz</p> <p>-50 to +20 dBm : 1 MHz ≤ carrier ≤ 50 GHz (typ.) -40 to +20 dBm: 50 GHz < carrier ≤ 52 GHz (typ.) -25 to +20 dBm: 52 GHz < carrier ≤ 54 GHz (typ.) (Enable search off)</p>
Phase noise measurement accuracy ³	<p>Signal level -20 dBm to +20 dBm <1.5 dB: offset to 1 MHz <2 dB: offset 1 M to 30 MHz <3 dB: offset 30 M to 100 MHz⁴</p>	<p>Carrier 1 MHz to 26.5 GHz: signal level -20 dBm to +20 dBm < 1.5 dB: offset to 1 MHz < 2 dB: offset 1 M to 30 MHz < 3 dB: offset 30 M to 100 MHz⁴</p> <p>Carrier 26.5 GHz to 44 GHz: signal level -20 to +15 dBm < 1.5 dB: offset to 1 MHz < 2 dB: offset 1 M to 30 MHz < 3 dB: offset 30 M to 100 MHz⁴</p> <p>Carrier 44 GHz to 50 GHz: signal level -20 dBm to +5 dBm < 2 dB: offset to 1 MHz < 2.5 dB: offset 1 M to 30 MHz < 3.5 dB: offset 30 M to 100 MHz⁴</p> <p>Carrier 50 GHz to 54 GHz: signal level -20 dBm to +5 dBm < 2.5 dB: offset to 1 MHz < 3 dB: offset 1 M to 30 MHz < 4 dB: offset 30 M to 100 MHz⁴</p>
SSB phase noise sensitivity ⁵	See Table 2, Figure 1 and 3 See Table 4, Figure 2 and 4	See Table 3, Figure 5 and 7 See Table 5, Figure 6 and 8
Cross correlation factor	1 to 100,000 (required S96301xB for 2 to 100,000) (See Table 7)	
Residual spurious level	Offset frequency: 1 kHz to 100 MHz	

Description	Specification (E5055A)	Specification (E5056A/57A/58A)
	< -50 dBc: carrier <100 MHz (typ.) < -80 dBc: carrier ≥100 MHz (typ.)	
Level measurement uncertainty	<p>Input signal: sinusoidal wave, 1 MHz to 8 GHz ±1.2 dB: -20 dBm ≤ signal level < -10 dBm (spec.) ±1 dB: -10 dBm ≤ signal level ≤ +15 dBm (spec.) ±1.5 dB: +15 dBm < signal level ≤ +20 dBm (spec.)</p> <p>Input signal: sinusoidal wave, 1 MHz to 8 GHz ±0.5 dB: -20 dBm ≤ signal level ≤ +15 dBm (typ.) ±0.8 dB: +15 dBm < signal level ≤ +20 dBm (typ.)</p>	<p>Input signal: sinusoidal wave -20 dBm ≤ signal level < -10 dBm +/-2.5 dB: 1 M to 3 GHz +/-1.5 dB: 3 G to 8 GHz +/-2.5 dB: 8 G to 20 GHz +/-3dB: 20 G to 50 GHz +/-4.5dB: 50 G to 54 GHz</p> <p>-10 dBm ≤ signal level ≤ 0 dBm +/-1.5dB: 1 M to 8 GHz +/-2 dB: 8 G to 20 GHz +/-2.5dB: 20 G to 50 GHz +/-4 dB: 50 G to 54 GHz</p> <p>0 dBm < signal level ≤ +10 dBm +/-1.5 dB: 1M to 8 GHz +/-2dB: 8 G to 20 GHz +/-2.5dB: 20 G to 44 GHz</p> <p>+10dBm < signal level ≤ +20dBm +/-1.5dB: 1 M to 8 GHz</p> <p>Input signal : sinusoidal wave -20 dBm ≤ signal level < -10 dBm +/-1 dB: 1 M to 50 GHz (typ.) +/-1.5 dB: 50 G to 54 GHz (typ.)</p> <p>-10 dBm ≤ signal level ≤ 0 dBm +/-0.5 dB: 1 M to 8 GHz (typ.) +/-1 dB: 8 G to 50 GHz (typ.) +/-1.5 dB: 50 G to 54 GHz (typ.)</p> <p>0 dBm < signal level ≤ +10 dBm +/-0.5dB: 1 M to 8 GHz (typ.) +/-1dB: 8 G to 44 GHz (typ.)</p> <p>+10 dBm < signal level ≤ +20 dBm 1 M to 8 GHz: +/-0.8 dB (typ.)</p>
Measurement time	See Table 8	
Receiver ranging	Auto, Manual (0 dB to 30 dB, 1 dB step)	Auto, Manual (0 dB to 28 dB, 2 dB step)
Sweep type	Auto (one RBW for all segments) Segment sweep (unique RBW and cross-correlation factor settable for each segment)	
RBW setting	0.1% to 30% (1/2/3/5 step) (Start offset ≥10 mHz) 0.3% to 30% (1/2/3/5 step) (Start offset 3 mHz) 1% to 30% (1/2/3/5 step) (Start offset 1 mHz)	

1. Offset >30 MHz: AM + PM composite measurement.
2. Offset frequency on half decade (300 kHz, 3 MHz, etc.) do not have measurement point because measurement points are log spacing.
3. For carrier frequency ≤152 MHz, the accuracy is specified up to maximum offset frequency in the maximum offset extension mode OFF.
4. Specification is applied under the PM noise of the device under test (DUT) = AM noise and decomposition model (PM = AM model) for offset >30 MHz and the noise level of the lower/upper sidebands should be identical.
5. without spurious, decomposition model (PM = AM model) for offset >30 MHz

Table 2. SSB phase noise sensitivity (dBc/Hz) (E5055A Opt.2xx), Cross correlation factor = 1, signal level = +10 dBm, Auto range ON, start offset = 1 Hz ¹

RF input frequency		Offset frequency [Hz] from the carrier									
		1	10	100	1 k	10 k	100 k	1 M	10 M	30 M	100 M
1 MHz	specification	-124	-148	-158	-164	-170	-174	-	-	-	-
	typical	-138	-157	-164	-169	-175	-180	-	-	-	-
10 MHz	specification	-113	-138	-152	-162	-168	-173	-175	-	-	-
	typical	-119	-145	-159	-168	-174	-179	-181	-	-	-
100 MHz	specification	-93	-118	-140	-156	-163	-168	-170	-170	-170	-
	typical	-100	-130	-148	-161	-169	-174	-176	-176	-176	-
1 GHz	specification	-73	-98	-121	-150	-164	-169	-170	-170	-170	-168
	typical	-80	-111	-130	-156	-169	-175	-177	-177	-177	-176
3 GHz	specification	-63	-88	-111	-140	-159	-167	-170	-170	-170	-168
	typical	-70	-101	-120	-147	-165	-173	-177	-177	-177	-176
8 GHz	specification	-55	-80	-103	-132	-151	-160	-166	-166	-166	-164
	typical	-62	-93	-112	-139	-158	-167	-175	-175	-175	-174

1. decomposition model(PM = AM model) for offset >30 MHz

Table 3. SSB phase noise sensitivity (dBc/Hz) (E5056A/57A/58A Opt.2xx), Cross correlation factor = 1, signal level = +10 dBm (<44 GHz), +5 dBm (≥44 GHz), Auto range OFF, Max. input level = signal level + 3 dB for specification, Auto range ON for typical, start offset = 1 Hz ¹

RF input frequency		Offset frequency [Hz] from the carrier									
		1	10	100	1 k	10 k	100 k	1 M	10 M	30 M	100 M
1 MHz	specification	-124	-146	-154	-158	-164	-169	-	-	-	-
	typical	-138	-153	-162	-168	-172	-177	-	-	-	-
10 MHz	specification	-113	-138	-152	-158	-164	-169	-171	-	-	-
	typical	-119	-145	-158	-168	-173	-177	-179	-	-	-
100 MHz	specification	-93	-118	-140	-153	-159	-164	-166	-166	-166	-
	typical	-100	-130	-147	-160	-166	-171	-173	-173	-172	-
1 GHz	specification	-73	-98	-121	-148	-161	-166	-167	-167	-167	-165
	typical	-80	-111	-130	-156	-166	-173	-175	-175	-174	-173
3 GHz	specification	-63	-88	-111	-140	-157	-163	-165	-165	-165	-163
	typical	-70	-101	-120	-147	-164	-171	-175	-175	-174	-173
8 GHz	specification	-55	-80	-103	-132	-151	-158	-162	-162	-162	-160
	typical	-62	-93	-112	-139	-158	-165	-172	-172	-172	-171
10 GHz	specification	-53	-78	-101	-130	-149	-158	-165	-165	-162	-160
	typical	-60	-91	-110	-137	-157	-164	-173	-173	-170	-171
16 GHz	specification	-48	-73	-96	-125	-144	-152	-162	-161	-158	-156
	typical	-56	-87	-105	-132	-153	-160	-171	-171	-168	-169
26.5 GHz	specification	-44	-69	-92	-121	-140	-148	-156	-155	-153	-151
	typical	-52	-83	-101	-128	-148	-156	-165	-165	-163	-164
44 GHz	specification	-39	-64	-87	-116	-135	-143	-152	-151	-149	-147
	typical	-47	-78	-96	-123	-144	-151	-162	-162	-159	-158
50 GHz	specification	-38	-63	-86	-115	-134	-142	-151	-150	-149	-147
	typical	-46	-77	-95	-122	-143	-150	-159	-160	-157	-159
54 GHz	specification	-37	-62	-85	-112	-127	-131	-133	-133	-128	-129
	typical	-46	-77	-95	-122	-138	-143	-146	-146	-142	-146

1. decomposition model(PM = AM model) for offset >30 MHz

Table 4. SSB phase noise sensitivity (dBc/Hz) (E5055A Opt.1xx), Cross correlation factor = 1, signal level = +10 dBm, Auto range ON, start offset = 1 Hz ¹

RF input frequency		Offset frequency [Hz] from the carrier									
		1	10	100	1 k	10 k	100 k	1 M	10 M	30 M	100 M
1 MHz	specification	-124	-148	-158	-164	-170	-174	–	–	–	–
	typical	-132	-157	-164	-169	-175	-180	–	–	–	–
10 MHz	specification	-107	-137	-152	-162	-168	-173	-175	–	–	–
	typical	-115	-141	-159	-168	-174	-179	-181	–	–	–
100 MHz	specification	-87	-117	-137	-156	-163	-168	-170	-170	-170	–
	typical	-95	-121	-146	-161	-169	-174	-176	-176	-176	–
1 GHz	specification	-66	-97	-117	-146	-164	-169	-170	-170	-170	-168
	typical	-75	-101	-124	-152	-169	-175	-177	-177	-177	-176
3 GHz	specification	-56	-87	-107	-136	-159	-167	-170	-170	-170	-168
	typical	-65	-91	-114	-142	-165	-173	-177	-177	-177	-176
8 GHz	specification	-48	-79	-99	-128	-151	-160	-166	-166	-166	-164
	typical	-57	-83	-106	-134	-158	-167	-175	-175	-175	-174

1. decomposition model(PM = AM model) for offset >30 MHz

Table 5. SSB phase noise sensitivity (dBc/Hz) (E5056A/57A/58A Opt.1xx), Cross correlation factor = 1, signal level = +10 dBm (<44 GHz), +5 dBm (≥44 GHz), Auto range OFF, Max. input level = signal level +3 dB for specification, Auto range ON for typical, start offset = 1 Hz ¹

RF input frequency		Offset frequency [Hz] from the carrier									
		1	10	100	1 k	10 k	100 k	1 M	10 M	30 M	100 M
1 MHz	specification	-124	-146	-154	-158	-164	-169	–	–	–	–
	typical	-132	-153	-162	-168	-172	-177	–	–	–	–
10 MHz	specification	-107	-137	-152	-158	-164	-169	-171	–	–	–
	typical	-115	-141	-158	-168	-173	-177	-179	–	–	–
100 MHz	specification	-87	-117	-137	-153	-159	-164	-166	-166	-166	–
	typical	-95	-121	-144	-160	-166	-171	-173	-173	-172	–
1 GHz	specification	-66	-97	-117	-144	-161	-166	-167	-167	-167	-165
	typical	-75	-101	-124	-152	-166	-173	-175	-175	-174	-173
3 GHz	specification	-56	-87	-107	-136	-157	-163	-165	-165	-165	-163
	typical	-65	-91	-114	-142	-164	-171	-175	-175	-174	-173
8 GHz	specification	-48	-79	-99	-128	-151	-158	-162	-162	-162	-160
	typical	-57	-83	-106	-134	-158	-165	-172	-172	-172	-171
10 GHz	specification	-46	-77	-97	-126	-149	-158	-165	-165	-162	-160
	typical	-55	-81	-104	-132	-157	-164	-173	-173	-170	-171
16 GHz	specification	-41	-72	-92	-121	-144	-152	-162	-161	-158	-156
	typical	-51	-77	-99	-127	-153	-160	-171	-171	-168	-169
26.5 GHz	specification	-37	-68	-88	-117	-140	-148	-156	-155	-153	-151
	typical	-47	-73	-95	-123	-148	-156	-165	-165	-163	-164
44 GHz	specification	-32	-63	-83	-112	-135	-143	-152	-151	-149	-147
	typical	-42	-68	-90	-118	-144	-151	-162	-162	-159	-158
50 GHz	specification	-31	-62	-82	-111	-134	-142	-151	-150	-149	-147
	typical	-41	-67	-89	-117	-143	-150	-159	-160	-157	-159
54 GHz	specification	-30	-61	-81	-108	-127	-131	-133	-133	-128	-129
	typical	-41	-67	-89	-117	-138	-143	-146	-146	-142	-146

1. decomposition model(PM = AM model) for offset >30 MHz

Table 6. Allan variance

Description	Specification (E5055A)	Specification (E5056A/57A/58A)
Frequency range	1 MHz to 8 GHz	1 MHz to 26.5GHz (E5056A) 1 MHz to 44 GHz (E5057A) 1 MHz to 54 GHz (E5058A)
Measurement range	100 nsec to 1000 sec	
Allan deviation	4.0 x 10E-13 at tau(τ) = 1 sec (nominal data for Opt.200)	

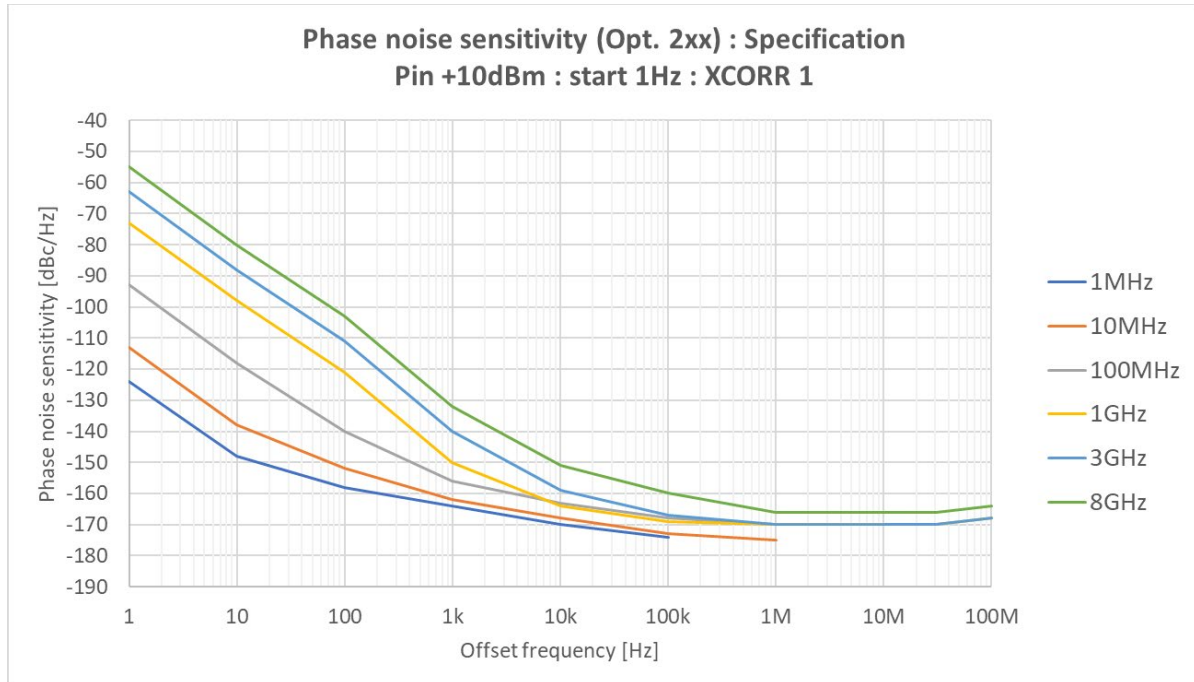

Figure 1. SSB Phase noise sensitivity (E5055A Option 2xx): Specification, +10 dBm input, Auto Range On, start offset frequency = 1 Hz, Cross correlation factor = 1)

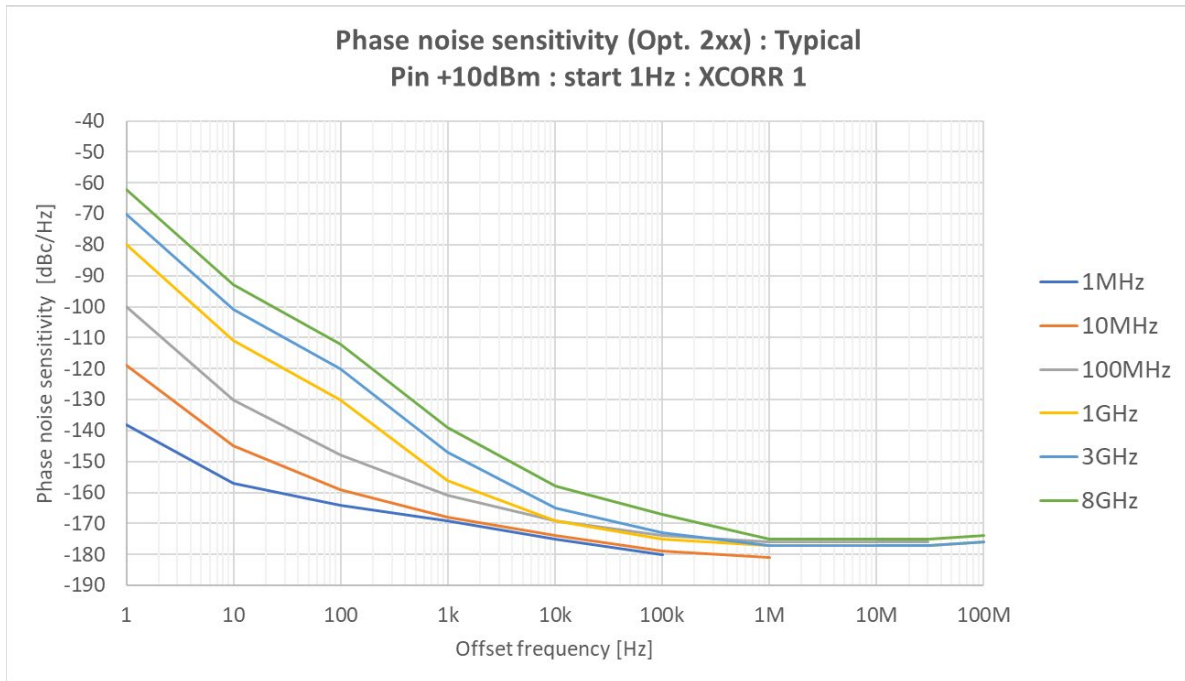

Figure 2. SSB Phase noise sensitivity (E5055A Option 2xx): Typical, +10 dBm input, Auto Range On, start offset frequency = 1 Hz, Cross correlation factor = 1)

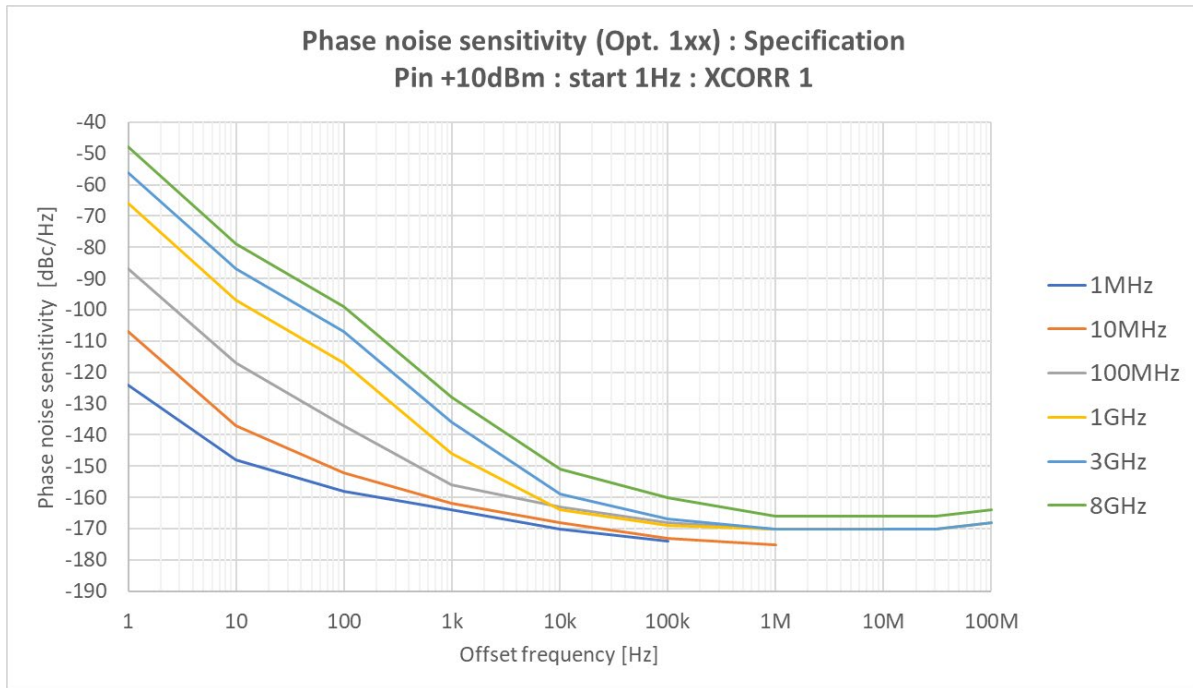

Figure 3. SSB Phase noise sensitivity (E5055A Option 1xx): Specification, +10 dBm input, Auto Range On, start offset frequency = 1 Hz, Cross correlation factor = 1)

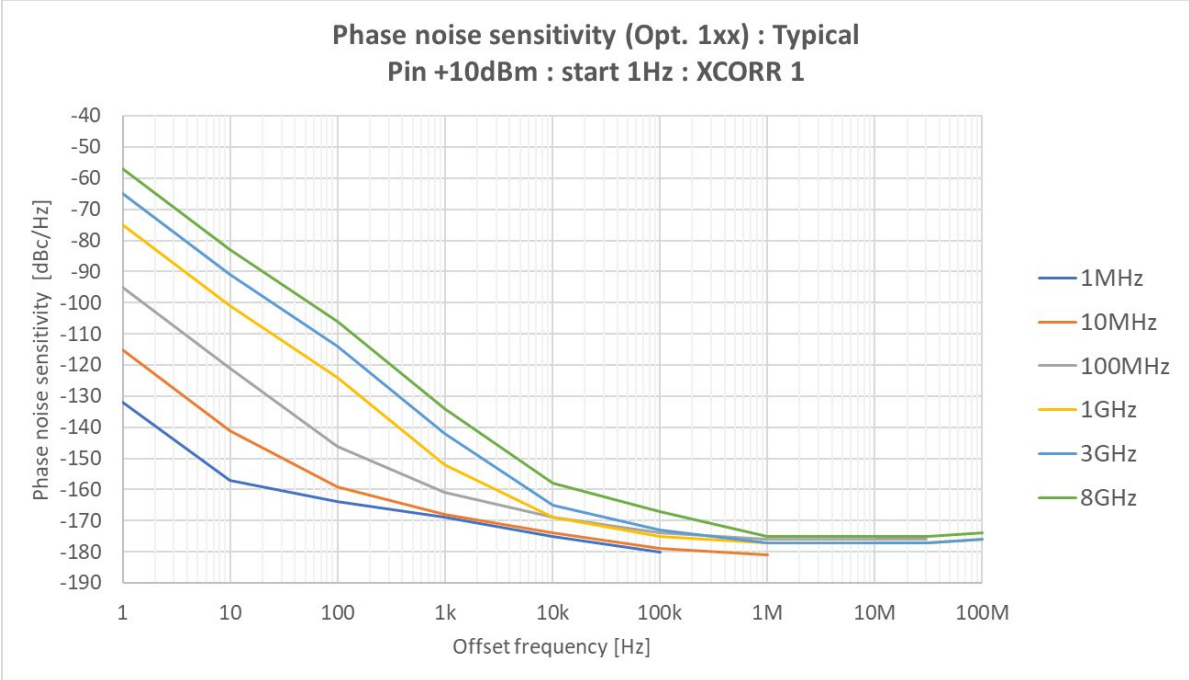

Figure 4. SSB Phase noise sensitivity (E5055A Option 1xx): Typical, +10 dBm input, Auto Range On, start offset frequency = 1 Hz, Cross correlation factor = 1)

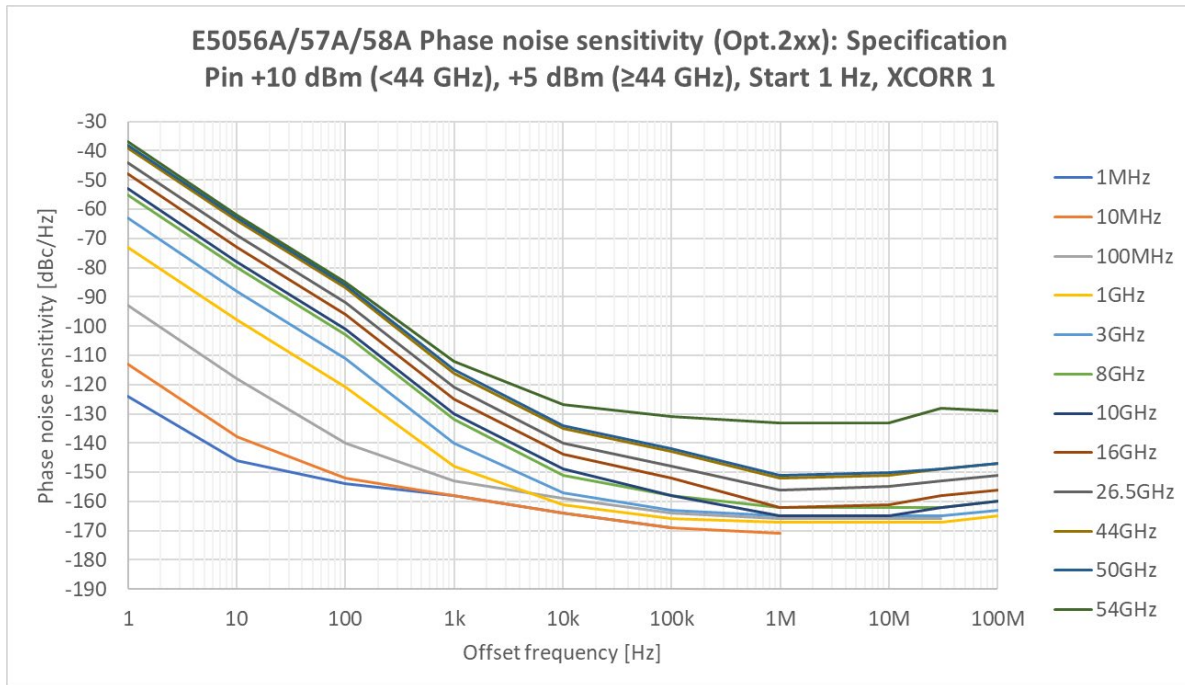

Figure 5. SSB Phase noise sensitivity (E5056A/57A/58A Option 2xx): Specification, +10 dBm (<44 GHz), +5 dBm (≥ 44 GHz) input, Auto Range OFF, Max. input level = signal level + 3 dB, start offset frequency = 1 Hz, Cross correlation factor = 1)

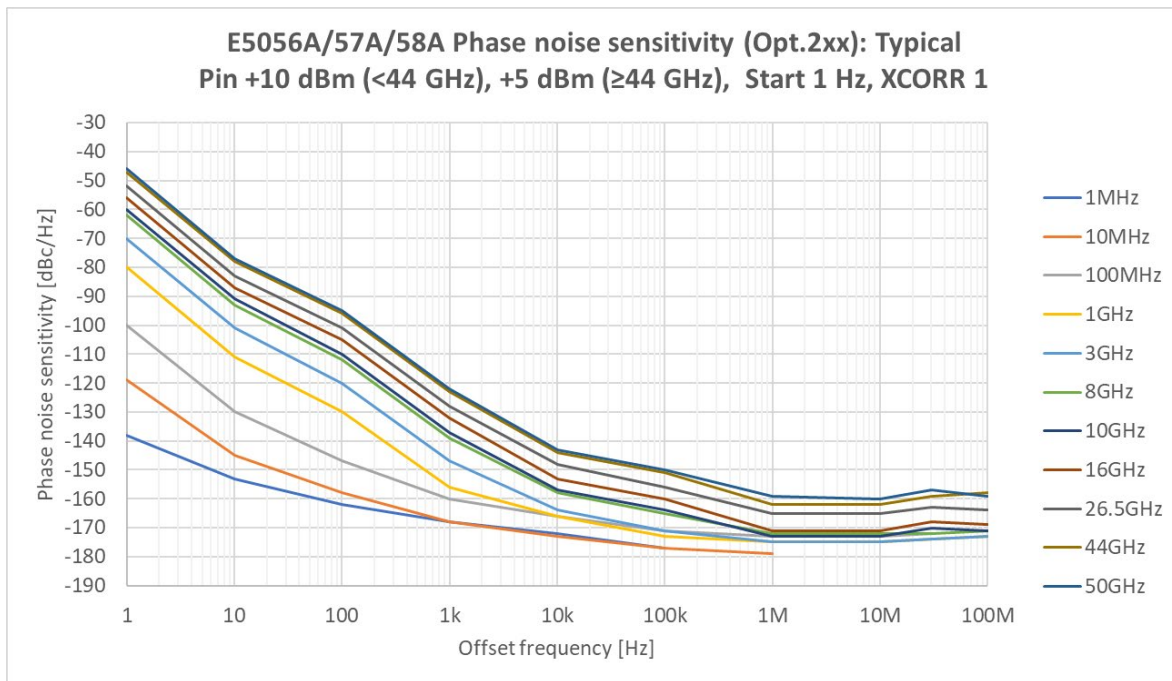

Figure 6. SSB Phase noise sensitivity (E5056A/57A/58A Option 2xx): Typical, +10 dBm (<44 GHz), +5 dBm (≥ 44 GHz) input, Auto Range On, start offset frequency = 1 Hz, Cross correlation factor = 1)

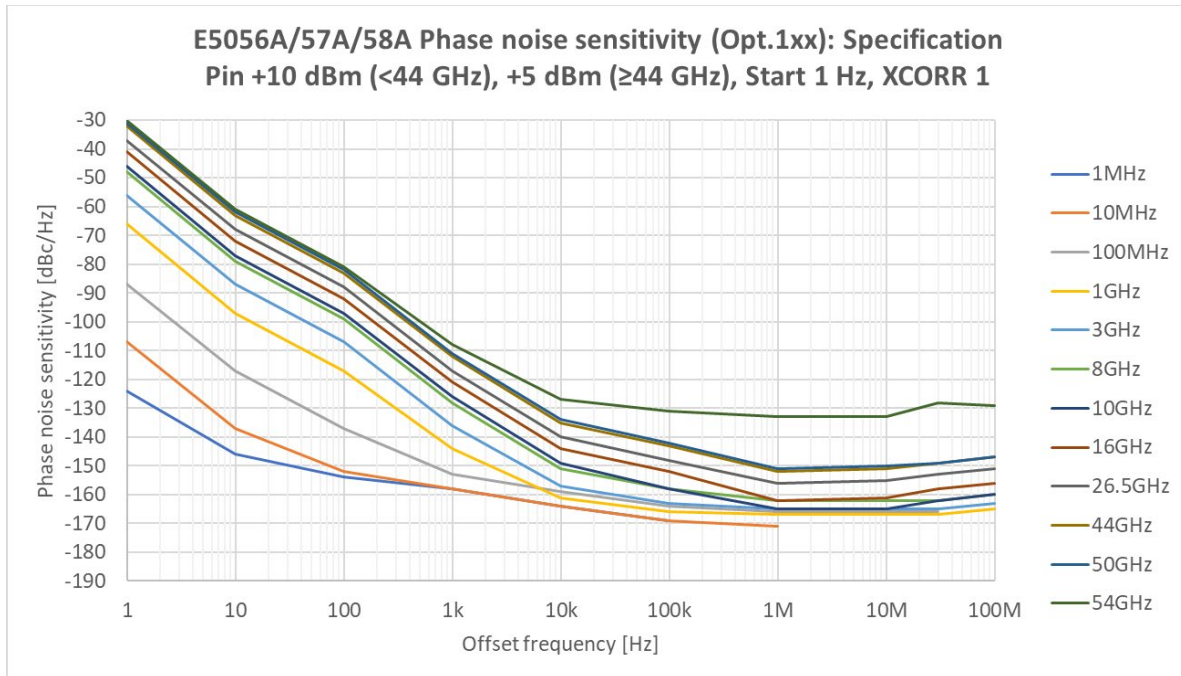

Figure 7. SSB Phase noise sensitivity (E5056A/57A/58A Option 1xx): Specification, +10 dBm (<44 GHz), +5 dBm (≥ 44 GHz) input, Auto Range OFF, Max. input level = signal level + 3 dB, Auto Range On, start offset frequency = 1 Hz, Cross correlation factor = 1)

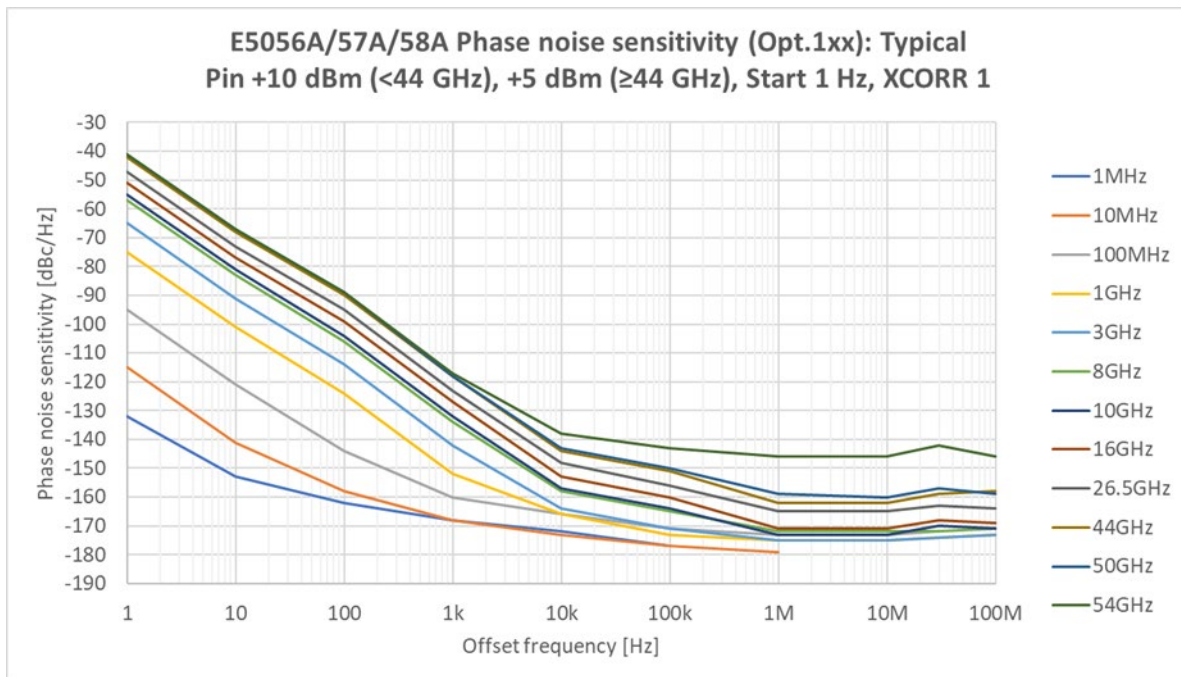

Figure 8. SSB Phase noise sensitivity (E5056A/57A/58A Option 1xx): Typical, +10 dBm (<44 GHz), +5 dBm (≥ 44 GHz) input, Auto Range On, start offset frequency = 1 Hz, Cross correlation factor = 1)

Table 7. SSB phase noise sensitivity improvement by correlation ^{1,2}

Number of correlations	10	100	1,000	10,000	100,000
Improvement factor	5 dB	10 dB	15 dB	20 dB	25 dB

1. Requires S96301xB Advanced Features for E505xA. These are the theoretical values and actual improvement is limited by the internal common noise and/or other factors.
2. In the "Fast XCORR Mode", the improvement factor may degrade.

Table 8. E505xA Typical measurement time (sec) for phase noise, Enable Search OFF, Sweep type = Log frequency, RBW 10%, Cross correlation factor ≥ 10 and measurement times ≥ 2 sec, Measurement times normalized to Cross correlation factor = 1

Stop frequency	Start frequency			
	1 Hz	10 Hz	100 Hz	1 kHz
100 kHz	5.96	0.79	0.09	0.05
1 MHz	5.96	0.79	0.09	0.05
10 MHz	5.96	0.84	0.11	0.05
30 MHz	8.25	1.23	0.17	0.07
100 MHz	9.56	1.44	0.20	0.07
1 GHz	25.19	3.99	0.51	0.11

AM Noise Measurement

Table 9. AM noise measurement performance

Description	Specification (E5055A)	Specification (E5056A/57A/58A)
RF frequency range	1 MHz to 8 GHz (E5055A)	1 MHz to 26.5 GHz (E5056A) 1 MHz to 44 GHz (E5057A) 1 MHz to 54 GHz (E5058A)
Minimum offset frequency	1 mHz	
Maximum offset frequency ¹	300 kHz (1 MHz ≤ carrier ≤ 2 MHz) 1 MHz (2 MHz < carrier ≤ 7.6 MHz) 3 MHz (7.6 MHz < carrier ≤ 28 MHz) (Offset is settable up to 5 MHz) 10 MHz (28 MHz < carrier ≤ 41 MHz) 30 MHz (41 MHz < carrier ≤ 8 GHz)	300 kHz (1 MHz ≤ carrier ≤ 2 MHz) 1 MHz (2 MHz < carrier ≤ 7.6 MHz) 3 MHz (7.6 MHz < carrier ≤ 28 MHz) (Offset is settable up to 5 MHz) 10 MHz (28 MHz < carrier ≤ 41 MHz) 30 MHz (41 MHz < carrier)
Offset setting resolution	1 – 3 steps + 5 MHz + 20 MHz	
Input power range	-20 dBm to +20 dBm (spec.) -50 dBm to +20 dBm (typ.) (Enable Search off)	-20 to +20 dBm: 1 MHz ≤ carrier ≤ 8 GHz -15 to +20 dBm: 8 GHz < carrier ≤ 40 GHz -10 to +20 dBm: 40 GHz < carrier ≤ 50 GHz 0 to +20 dBm: 50 GHz < carrier ≤ 54 GHz -50 to +20 dBm : 1 MHz ≤ carrier ≤ 50 GHz (typ.) -40 to +20 dBm: 50 GHz < carrier ≤ 52 GHz (typ.) -25 to +20 dBm: 52 GHz < carrier ≤ 54 GHz (typ.) (Enable search off)
AM noise sensitivity ²	See Table 10, Figure 9 and 10	See Table 11, Figure 11 and 12
AM noise measurement accuracy	Signal level: -20 dBm to +20 dBm < 2 dB: offset to 1 MHz < 2.5 dB: offset 1 MHz to 30 MHz	Carrier 1 MHz to 26.5 GHz: signal level -20 dBm to +20 dBm < 2 dB: offset to 1 MHz < 2.5 dB: offset 1 M to 30 MHz Carrier 26.5 GHz to 44 GHz: signal level -20 dBm to +15 dBm < 2 dB: offset to 1 MHz < 2.5 dB: offset 1 M to 30 MHz Carrier 44 GHz to 50 GHz: signal level -20 dBm to +5 dBm < 2.5 dB: offset to 1 MHz < 3 dB: offset 1 M to 30 MHz Carrier 50 GHz to 54 GHz: signal level -20 dBm to +5 dBm < 3 dB: offset to 1 MHz < 3.5 dB: offset 1 M to 30 MHz
Level measurement uncertainty	Input signal: sinusoidal wave, 1 MHz to 8 GHz ±1.2 dB: -20 dBm ≤ signal level < -10 dBm (spec.) ±1 dB: -10 dBm ≤ signal level ≤ +15 dBm (spec.) ±1.5 dB: +15 dBm < signal level ≤ +20 dBm (spec.) Input signal: sinusoidal wave, 1 MHz to 8 GHz ±0.5 dB: -20 dBm ≤ signal level ≤ +15 dBm (typ.) ±0.8 dB: +15 dBm < signal level ≤ +20 dBm (typ.)	Input signal: sinusoidal wave -20 dBm ≤ signal level < -10 dBm +/-2.5 dB: 1 M to 3 GHz +/-1.5 dB: 3 G to 8 GHz +/-2.5 dB: 8 G to 20 GHz +/-3dB: 20 G to 50 GHz +/-4.5dB: 50 G to 54 GHz -10 dBm ≤ signal level ≤ 0 dBm +/-1.5dB: 1 M to 8 GHz +/-2 dB: 8 G to 20 GHz +/-2.5dB: 20 G to 50 GHz +/-4 dB: 50 G to 54 GHz 0 dBm < signal level ≤ +10 dBm

Description	Specification (E5055A)	Specification (E5056A/57A/58A)
		+/-1.5 dB: 1M to 8 GHz +/-2dB: 8 G to 20 GHz +/-2.5dB: 20 G to 44 GHz +10dBm < signal level ≤ +20dBm +/-1.5dB: 1 M to 8 GHz Input signal : sinusoidal wave -20 dBm ≤ signal level < -10 dBm +/-1 dB: 1 M to 50 GHz (typ.) +/-1.5 dB: 50 G to 54 GHz (typ.) -10 dBm ≤ signal level ≤ 0 dBm +/-0.5 dB: 1 M to 8 GHz (typ.) +/-1 dB: 8 G to 50 GHz (typ.) +/-1.5 dB: 50 G to 54 GHz (typ.) 0 dBm < signal level ≤ +10 dBm +/-0.5dB: 1 M to 8 GHz (typ.) +/-1dB: 8 G to 44 GHz (typ.) +10 dBm < signal level ≤ +20 dBm 1 M to 8 GHz: +/-0.8 dB (typ.)
Residual spurious level	Offset: 1 kHz to 30 MHz < -50 dBc: carrier <100 MHz (typ.) < -80 dBc: carrier ≥100 MHz (typ.)	
Cross correlation factor	1 to 100,000 (required S96301xB for 2 to 100,000)	
Receiver ranging	Auto, Manual (0 dB to 30 dB, 1 dB step)	Auto, Manual (0 dB to 28 dB, 2 dB step)
RBW setting	0.1% to 30% (1/2/3/5 step) (Start offset ≥ 10 mHz) 0.3% to 30% (1/2/3/5 step) (Start offset 3 mHz) 1% to 30% (1/2/3/5 step) (Start offset 1 mHz)	

1. Offset frequency on half decade (300 kHz, 3 MHz, 30 MHz, etc.) do not have measurement point because measurement points are log spacing.
2. without spurious.

Table 10. AM noise sensitivity [dBc/Hz] (E5055A Option 100, 200), Cross correlation factor = 1, signal level = +10 dBm, Auto range ON, start offset = 1 Hz

RF input frequency		Offset frequency [Hz] from the carrier								
		1	10	100	1 k	10 k	100 k	1 M	10 M	30 M
1 MHz	specification	-100	-120	-135	-145	-158	-165	–	–	–
	typical	-113	-128	-142	-153	-168	-178	–	–	–
10 MHz	specification	-100	-120	-135	-145	-158	-165	-167	–	–
	typical	-113	-128	-142	-153	-168	-178	-181	–	–
100 MHz	specification	-100	-120	-135	-145	-158	-165	-167	-167	-167
	typical	-112	-127	-141	-152	-166	-174	-176	-176	-176
1 GHz	specification	-100	-120	-135	-145	-158	-165	-167	-167	-167
	typical	-112	-127	-142	-153	-167	-174	-176	-176	-176
3 GHz	specification	-100	-117	-132	-145	-157	-165	-167	-167	-167
	typical	-112	-127	-141	-152	-166	-174	-176	-176	-176
8 GHz	specification	-100	-117	-132	-145	-157	-165	-167	-167	-167
	typical	-112	-127	-141	-152	-166	-173	-175	-175	-175

Table 11. AM noise sensitivity [dBc/Hz] (E5056A/57A/58A Option 100, 200), Cross correlation factor = 1, signal level = +10 dBm (<44 GHz), +5 dBm (≥44 GHz), Auto range OFF, Max. input level = signal level +3 dB for specification, Auto range ON for typical, start offset = 1 Hz

RF input frequency		Offset frequency [Hz] from the carrier								
		1	10	100	1 k	10 k	100 k	1 M	10 M	30 M
1 MHz	specification	-100	-120	-135	-145	-156	-162	–	–	–
	typical	-113	-128	-142	-153	-168	-177	–	–	–
10 MHz	specification	-100	-120	-135	-145	-156	-162	-164	–	–
	typical	-113	-128	-142	-153	-167	-176	-178	–	–
100 MHz	specification	-100	-120	-135	-145	-156	-162	-164	-164	-164
	typical	-112	-127	-141	-152	-164	-171	-172	-172	-172
1 GHz	specification	-100	-120	-135	-145	-156	-162	-164	-164	-164
	typical	-112	-127	-141	-153	-165	-172	-174	-174	-174
3 GHz	specification	-100	-117	-132	-145	-155	-162	-164	-164	-164
	typical	-112	-127	-141	-152	-164	-172	-174	-174	-174
8 GHz	specification	-100	-117	-132	-143	-153	-160	-162	-162	-162
	typical	-112	-127	-140	-152	-162	-169	-171	-171	-171
10 GHz	specification	-100	-117	-132	-143	-156	-163	-167	-167	-161
	typical	-112	-125	-139	-152	-163	-172	-176	-176	-172
16 GHz	specification	-100	-117	-132	-143	-156	-163	-167	-167	-161
	typical	-112	-126	-139	-152	-163	-172	-175	-175	-170
26.5 GHz	specification	-100	-117	-132	-143	-155	-163	-167	-167	-161
	typical	-111	-125	-138	-151	-162	-171	-175	-175	-166
44 GHz	specification	-97	-113	-128	-139	-151	-158	-161	-161	-151
	typical	-110	-123	-136	-149	-160	-167	-171	-171	-160
50 GHz	specification	-97	-113	-128	-137	-147	-151	-153	-153	-148
	typical	-110	-123	-136	-147	-155	-161	-163	-163	-157
54 GHz	specification	-71	-85	-103	-118	-126	-130	-132	-132	-128
	typical	-92	-106	-120	-132	-138	-143	-145	-145	-142

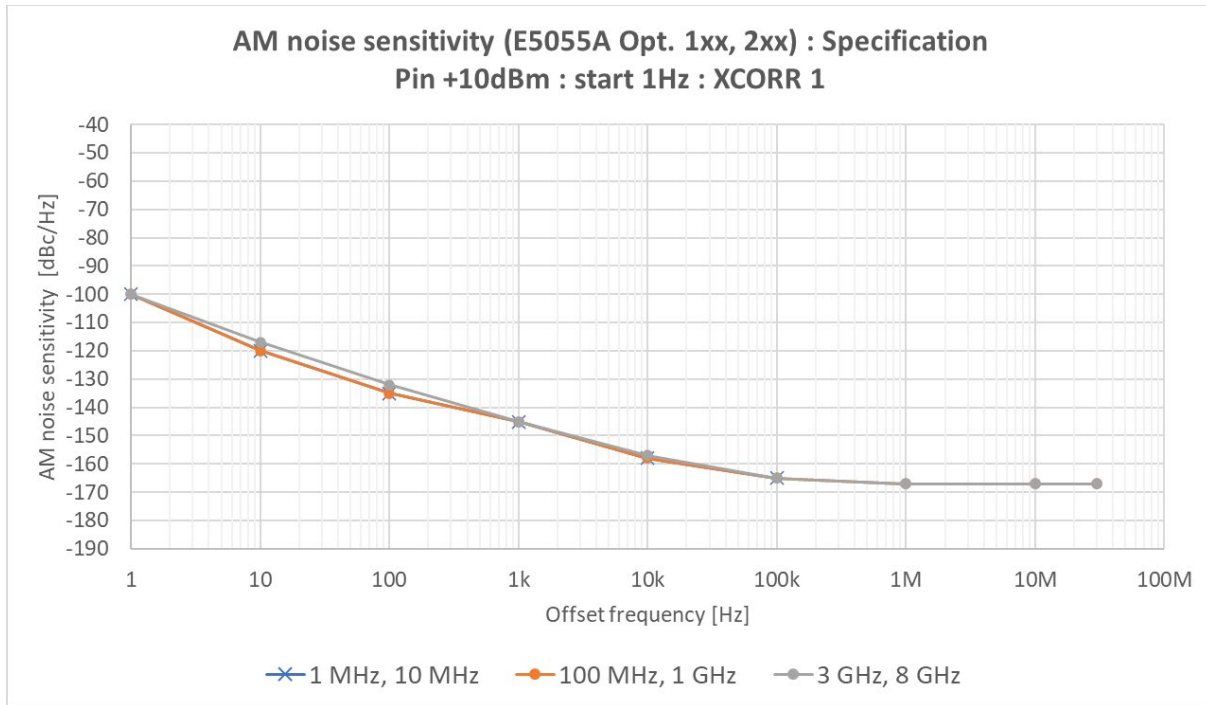

Figure 9. SSB AM noise sensitivity (E5055A Option 1xx, 2xx): Specification, +10 dBm input, Auto Range On, start offset frequency = 1 Hz, Cross correlation factor = 1

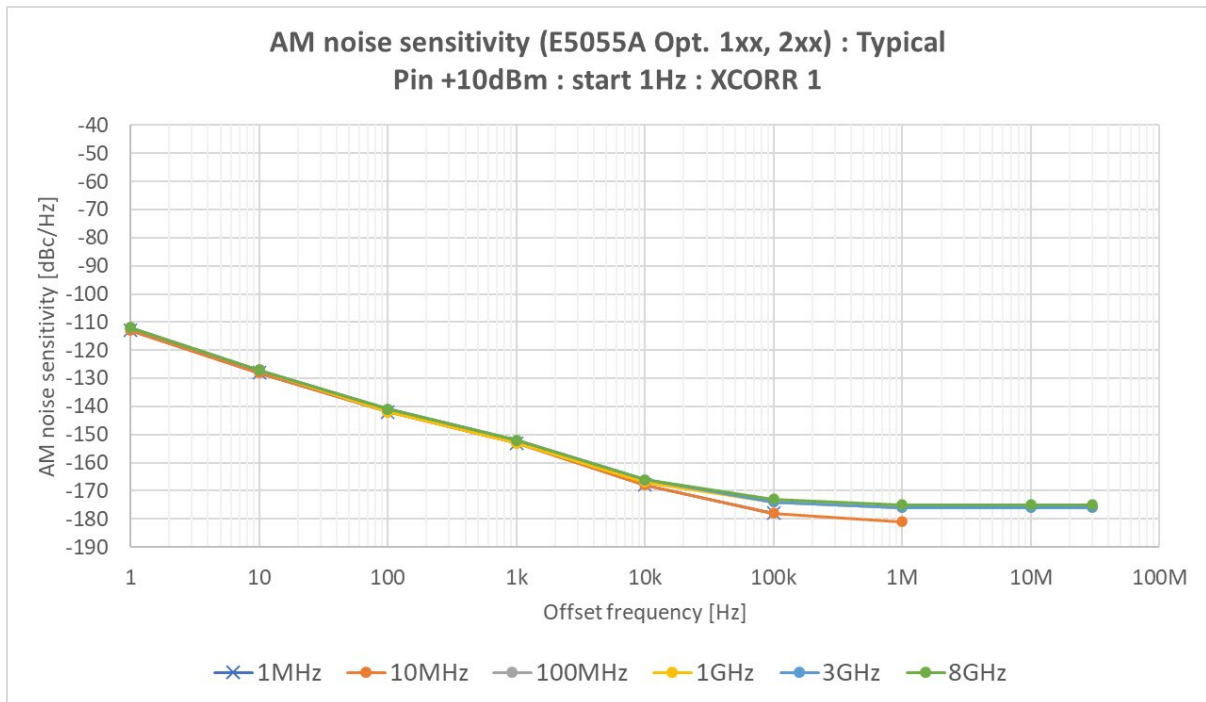

Figure 10. SSB AM noise sensitivity (E5055A Option 1xx, 2xx): Typical, +10 dBm input, Auto Range On, start offset frequency = 1 Hz, Cross correlation factor = 1

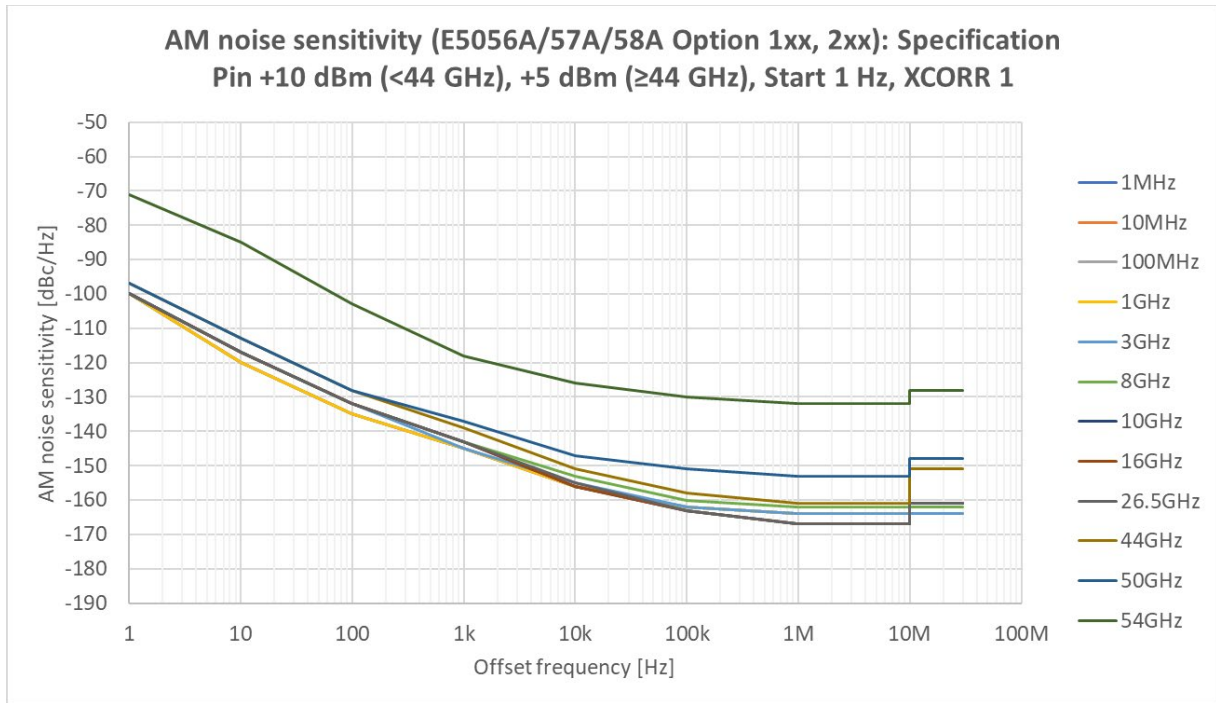

Figure 11. SSB AM noise sensitivity (E5056A/57A/58A Option 1xx, 2xx): Specification, +10 dBm (<44 GHz), +5 dBm (≥ 44 GHz) input, Auto Range OFF, Max. input level = signal level + 3 dB, start offset frequency = 1 Hz, Cross correlation factor = 1

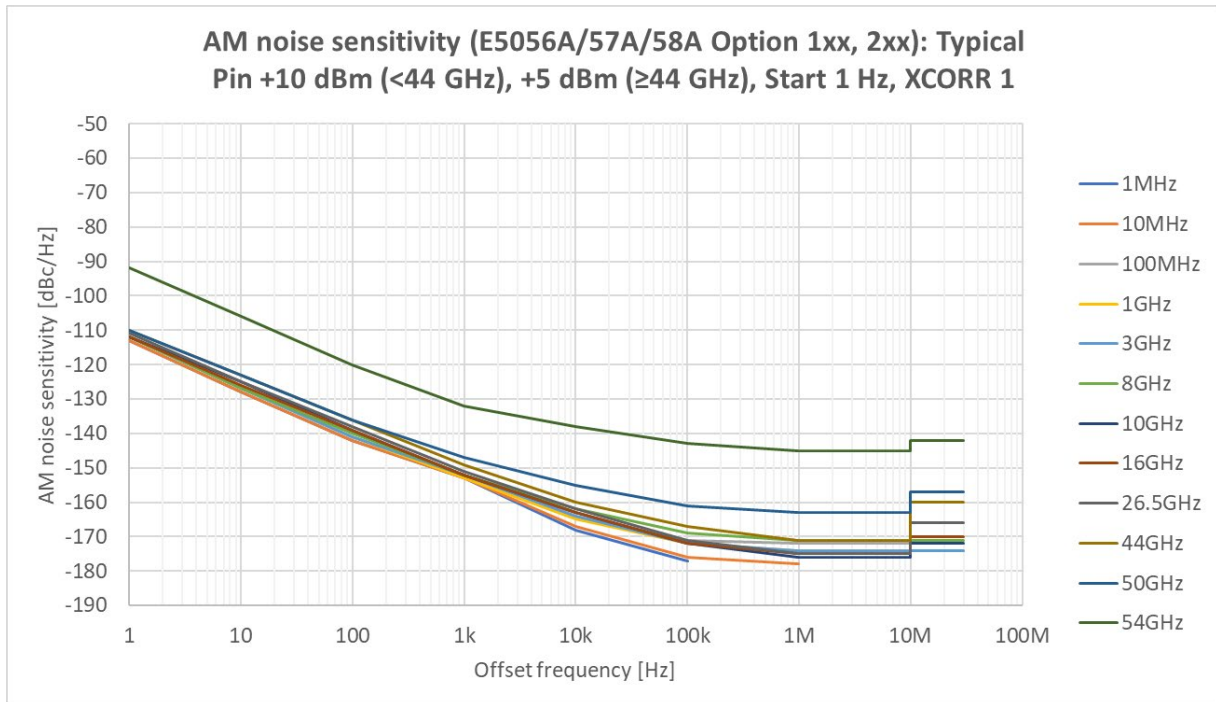

Figure 12. SSB AM noise sensitivity (E5056A/57A/58A Option 1xx, 2xx): Typical, +10 dBm (<44 GHz), +5 dBm (≥ 44 GHz) input, Auto Range On, start offset frequency = 1 Hz, Cross correlation factor = 1

Residual Phase Noise/AM Noise Measurement

Table 12. Residual Phase noise/AM noise measurement performance (E5055A/56A/57A/58A)

Description	Specification (E5055A)	Specification (E5056A/57A/58A)
RF frequency range	1 MHz to 8 GHz (E5055A)	1 MHz to 26.5 GHz (E5056A) 1 MHz to 44 GHz (E5057A) 1 MHz to 54 GHz (E5058A)
Minimum offset frequency	1 mHz	
Maximum offset frequency ^{1,2}	300 kHz: 1 MHz ≤ carrier ≤ 2 MHz 1 MHz: 2 MHz < carrier ≤ 7.6 MHz 3 MHz: 7.6 MHz < carrier ≤ 28 MHz 10 MHz: 28 MHz < carrier ≤ 41 MHz 30 MHz: 41 MHz < carrier ≤ 54 GHz	
Offset setting resolution	1 – 3 steps + 5 MHz, 20 MHz	
Input power range	Enable search OFF is only selectable. -20 dBm to +20 dBm -50 to +20 dBm : 1 MHz ≤ carrier ≤ 50 GHz (typ.) -40 to +20 dBm: 50 GHz < carrier ≤ 52 GHz (typ.) -25 to +20 dBm: 52 GHz < carrier ≤ 54 GHz (typ.)	
Residual Phase noise measurement accuracy ³	Carrier 1 MHz to 8 GHz < 1.5 dB: offset to 30 MHz(Typ.) Carrier 8GHz to 54GHz < 2 dB: offset to 30 MHz(Typ.)	
Residual AM noise measurement accuracy ³	Carrier 1 MHz to 8 GHz < 2 dB: offset to 30 MHz(Typ.) Carrier 8 GHz to 54 GHz < 2.5 dB offset to 30MHz(Typ.)	
SSB residual phase noise sensitivity ⁴ SSB residual AM noise sensitivity ⁴	See Table 13, Figure 13 and 14 See Table 14, Figure 15 and 16	
Cross correlation factor	1 to 100,000 (required S96301xB for 2 to 100,000) (See Table 5)	
Residual spurious level	Offset frequency: 1 kHz to 30 MHz < -50 dBc: carrier <100 MHz (typ.) < -80 dBc: carrier ≥100 MHz (typ.)	
Level measurement uncertainty	Input signal: sinusoidal wave, 1 MHz to 8 GHz ±1.2 dB: -20 dBm ≤ signal level < -10 dBm (spec.) ±1 dB: -10 dBm ≤ signal level ≤ +15 dBm (spec.) ±1.5 dB: +15 dBm < signal level ≤ +20 dBm (spec.) Input signal: sinusoidal wave, 1 MHz to 8 GHz ±0.5 dB: -20 dBm ≤ signal level ≤ +15 dBm (typ.) ±0.8 dB: +15 dBm < signal level ≤ +20 dBm (typ.)	Input signal: sinusoidal wave -20 dBm ≤ signal level < -10 dBm +/-2.5 dB: 1 M to 3 GHz +/-1.5 dB: 3 G to 8 GHz +/-2.5 dB: 8 G to 20 GHz +/-3dB: 20 G to 50 GHz +/-4.5dB: 50 G to 54 GHz -10 dBm ≤ signal level ≤ 0 dBm +/-1.5dB: 1 M to 8 GHz +/-2 dB: 8 G to 20 GHz +/-2.5dB: 20 G to 50 GHz +/-4 dB: 50 G to 54 GHz 0 dBm < signal level ≤ +10 dBm +/-1.5 dB: 1M to 8 GHz +/-2dB: 8 G to 20 GHz +/-2.5dB: 20 G to 44 GHz +10dBm < signal level ≤ +20dBm +/-1.5dB: 1 M to 8 GHz Input signal : sinusoidal wave -20 dBm ≤ signal level < -10 dBm

Description	Specification (E5055A)	Specification (E5056A/57A/58A)
		+/-1 dB: 1 M to 50 GHz (typ.) +/-1.5 dB: 50 G to 54 GHz (typ.) -10 dBm ≤ signal level ≤ 0 dBm +/-0.5 dB: 1 M to 8 GHz (typ.) +/-1 dB: 8 G to 50 GHz (typ.) +/-1.5 dB: 50 G to 54 GHz (typ.) 0 dBm < signal level ≤ +10 dBm +/-0.5dB: 1 M to 8 GHz (typ.) +/-1dB: 8 G to 44 GHz (typ.) +10 dBm < signal level ≤ +20 dBm 1 M to 8 GHz: +/-0.8 dB (typ.)
Receiver ranging	Auto, Manual (0 dB to 30 dB, 1 dB step)	Auto, Manual (0 dB to 28 dB, 2 dB step)
Sweep type	Auto (one RBW for all segments) Segment sweep (unique RBW and cross-correlation factor settable for each segment)	
RBW setting	0.1% to 30% (1/2/3/5 step) (Start offset ≥ 10 mHz) 0.3% to 30% (1/2/3/5 step) (Start offset 3 mHz) 1% to 30% (1/2/3/5 step) (Start offset 1 mHz)	

1. Offset >30 MHz: AM + PM composite measurement.
2. Offset frequency on half decade (300 kHz, 3 MHz, etc.) do not have measurement point because measurement points are log spacing.
3. For carrier frequency ≤ 152 MHz, the accuracy is specified up to maximum offset frequency in the maximum offset extension mode OFF.
4. without spurious

Table 13. Residual phase noise sensitivity (dBc/Hz) (E5055A/56/57/58A), Cross correlation factor = 10, Fast XCORR mode OFF, Source Out signal used, Signal level setting = +10 dBm (<44 GHz), +5 dBm(44 GHz), 0 dBm(50 GHz), -5 dBm(54 GHz), Auto range OFF, Max. input level = Signal level +3 dB for specification, Auto range ON for typical, Path delay compensation 0sec

RF input frequency		Offset frequency [Hz] from the carrier								
		1	10	100	1 k	10 k	100 k	1 M	10 M	30 M
10 MHz	specification	-122	-138	-150	-158	-163	-167	-169	–	–
	typical	-136	-149	-159	-167	-172	-178	-178	–	–
100 MHz	specification	-120	-134	-147	-155	-160	-164	-166	-166	-166
	typical	-130	-144	-155	-163	-169	-172	-173	-175	-174
1 GHz	specification	-117	-133	-146	-154	-160	-165	-166	-166	-166
	typical	-128	-142	-155	-162	-168	-172	-174	-175	-174
3 GHz	specification	-115	-128	-143	-152	-159	-165	-166	-166	-166
	typical	-123	-138	-151	-161	-167	-172	-173	-174	-174
8 GHz	specification	-105	-121	-136	-148	-156	-161	-163	-163	-163
	typical	-113	-131	-144	-157	-164	-168	-170	-172	-171
10 GHz	specification	-107	-124	-140	-152	-160	-166	-167	-165	-162
	typical	-123	-137	-149	-160	-168	-173	-174	-175	-172
16 GHz	specification	-107	-122	-136	-149	-159	-165	-168	-164	-160
	typical	-121	-134	-147	-158	-166	-173	-176	-174	-169
26.5 GHz	specification	-105	-119	-133	-146	-157	-163	-167	-159	-150
	typical	-117	-132	-143	-154	-165	-172	-175	-172	-166
44 GHz	specification	-96	-113	-127	-139	-149	-157	-162	-156	-147
	typical	-110	-125	-136	-149	-160	-167	-170	-168	-161

RF input frequency		Offset frequency [Hz] from the carrier									
50 GHz	specification	-95	-111	-125	-139	-149	-158	-161	-154	-146	
	typical	-111	-124	-135	-148	-160	-167	-168	-168	-164	
54 GHz	specification	-93	-103	-111	-116	-121	-126	-126	-124	-121	
	typical	-105	-116	-123	-129	-134	-139	-140	-140	-139	

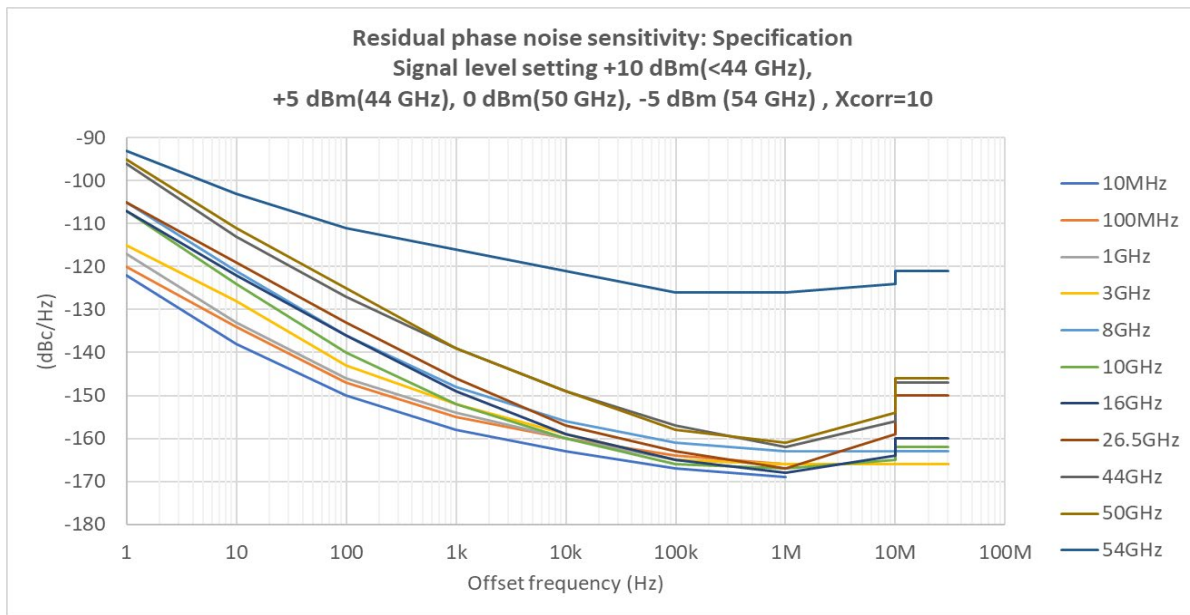

Figure 13. Residual phase noise sensitivity (dBc/Hz) (E5055A/56A/57A/58A): Specification, Cross correlation factor = 10, Fast XCORR mode OFF, signal level setting = +10 dBm(<44 GHz), +5 dBm(44 GHz), 0 dBm(50 GHz), -5 dBm(54 GHz), Auto range OFF, Max. input level = signal level + 3 dB, Path delay compensation 0 sec, start offset = 1 Hz¹

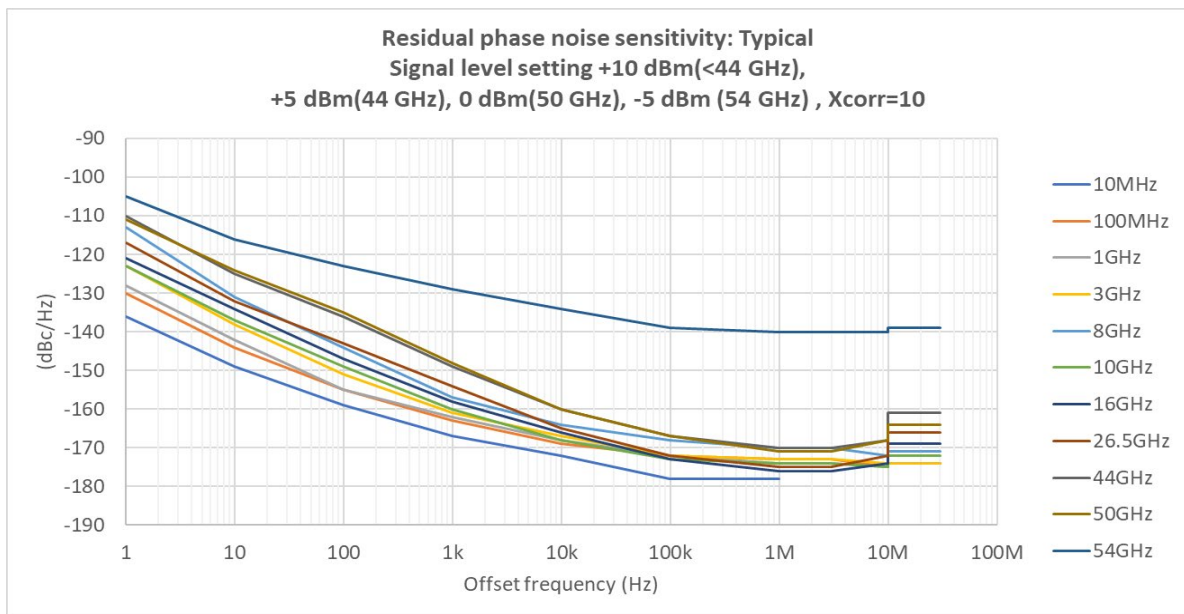

Figure 14. Residual phase noise sensitivity (dBc/Hz) (E5055A/56A/57A/58A): Typical, Cross correlation factor = 10, Fast XCORR mode OFF, signal level setting = +10 dBm(<44 GHz), +5 dBm(44 GHz), 0 dBm(50 GHz), -5 dBm(54 GHz), Auto range ON, Path delay compensation 0 sec, start offset = 1 Hz¹

Table 14. Residual AM noise sensitivity (dBc/Hz) (E5055A/56/57/58A), Cross correlation factor = 10, Fast XCORR mode OFF, Source Out signal used, signal level setting = +10 dBm (<44 GHz), +5 dBm(44 GHz), 0 dBm(50 GHz), -5 dBm(54 GHz), Auto range OFF, Max. input level = Signal level +3 dB for specification, Auto range ON for typical, Path delay compensation 0sec

RF input frequency		Offset frequency [Hz] from the carrier								
		1	10	100	1 k	10 k	100 k	1 M	10 M	30 M
10 MHz	specification	-102	-115	-131	-143	-156	-166	-166	–	–
	typical	-115	-128	-143	-156	-169	-176	-177	–	–
100 MHz	specification	-102	-115	-131	-143	-156	-163	-164	-164	-164
	typical	-114	-128	-143	-155	-166	-172	-173	-174	-174
1 GHz	specification	-102	-115	-131	-143	-156	-163	-164	-164	-164
	typical	-114	-128	-143	-155	-166	-172	-173	-174	-174
3 GHz	specification	-102	-115	-131	-143	-156	-163	-164	-164	-164
	typical	-114	-128	-143	-155	-165	-172	-173	-173	-173
8 GHz	specification	-102	-115	-131	-143	-153	-159	-160	-160	-160
	typical	-114	-128	-141	-153	-164	-168	-170	-171	-170
10 GHz	specification	-102	-115	-131	-143	-153	-161	-163	-161	-160
	typical	-114	-127	-141	-153	-164	-173	-174	-174	-172
16 GHz	specification	-102	-115	-131	-143	-153	-161	-163	-159	-156
	typical	-114	-127	-140	-153	-164	-173	-175	-172	-170
26.5 GHz	specification	-102	-115	-131	-143	-153	-161	-163	-159	-156
	typical	-112	-127	-140	-153	-163	-171	-174	-172	-165
44 GHz	specification	-102	-112	-127	-139	-151	-157	-161	-156	-151
	typical	-111	-125	-138	-150	-161	-168	-171	-167	-162
50 GHz	specification	-99	-112	-127	-139	-151	-157	-159	-155	-151
	typical	-111	-125	-138	-150	-161	-168	-168	-168	-163
54 GHz	specification	-93	-103	-111	-116	-121	-126	-126	-124	-121
	typical	-102	-116	-124	-132	-136	-140	-141	-140	-141

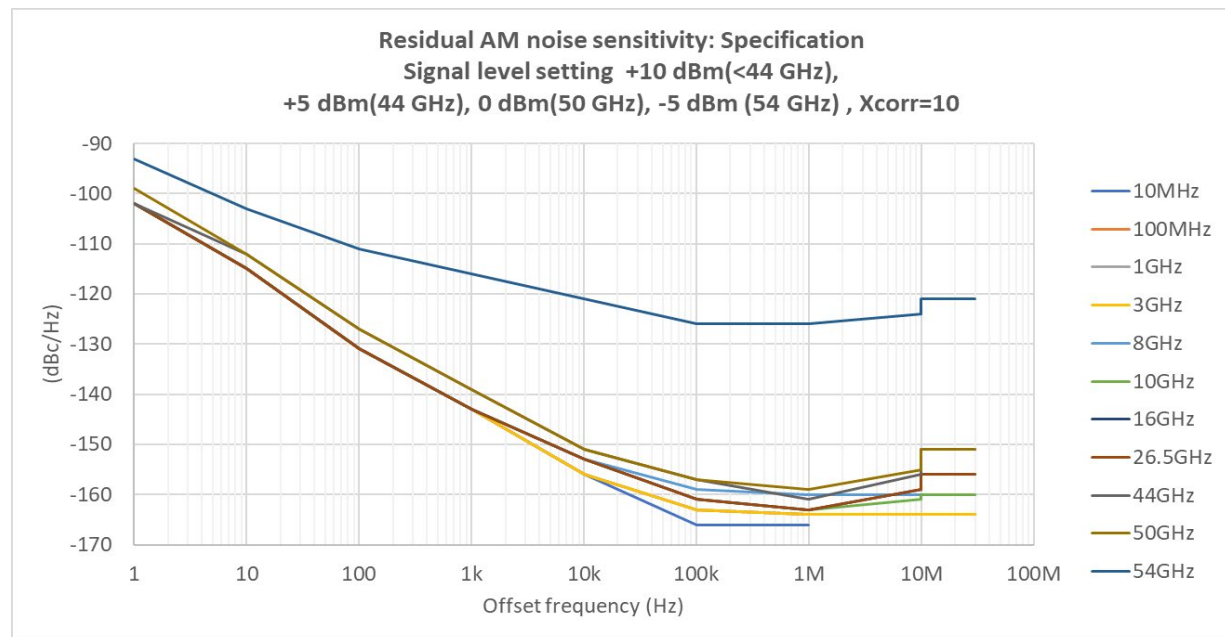

Figure 15. Residual AM phase noise sensitivity (dBc/Hz) (E5055A/56A/57A/58A): Specification, Cross correlation factor = 10, Fast XCORR mode OFF, signal level setting = +10 dBm(<44 GHz), +5 dBm(44 GHz), 0 dBm(50 GHz), -5 dBm(54 GHz), Auto range OFF, Max. input level = signal level + 3 dB, Path delay compensation 0 sec, start offset = 1 Hz ¹

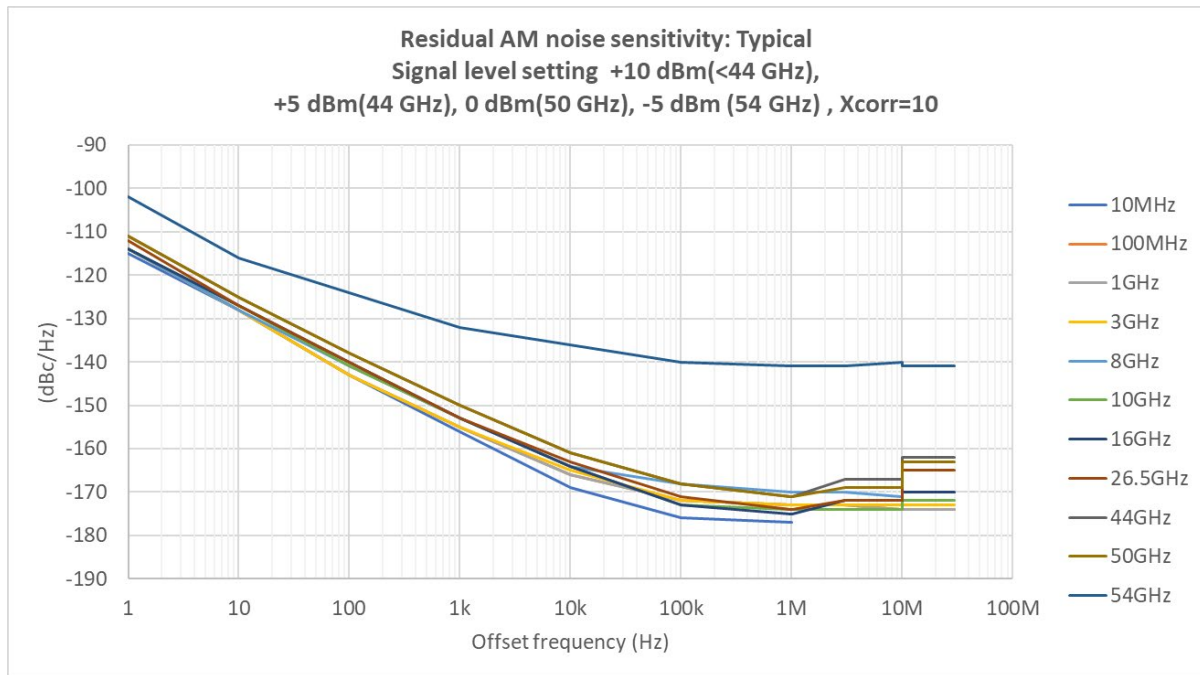

Figure 16. Residual AM phase noise sensitivity (dBc/Hz) (E5055A/56A/57A/58A): Typical, Cross correlation factor = 10, Fast XCORR mode OFF, signal level setting = +10 dBm(<44 GHz), +5 dBm(44 GHz), 0 dBm(50 GHz), -5 dBm (54 GHz), Auto range ON, Path delay compensation 0 sec, start offset = 1 Hz ¹

Source Output (available when option 15x/16x or 25x/26x)

Table 15. Source Output Performances (E5055A/56A/57A/58A)

Description	Specification (E5055A)	Specification (E5056A/57A/58A)
Frequency range	10 MHz to 8 GHz (E5055A)	10 MHz to 26.5 GHz (E5056A) 10 MHz to 44 GHz (E5057A) 10 MHz to 54 GHz (E5058A)
Frequency resolution	Spec. 1 Hz	
Max. output power	Spec. 10 M to 2.7 GHz: +8.5 dBm, +13 dBm (Typ.) 2.7 G to 10 GHz: +10 dBm, +16 dBm (Typ.) 10 GHz to 15 GHz: +10 dBm, +14 dBm (Typ.) 15 G to 18 GHz: +8 dBm, +13 dBm (Typ.) 18 G to 30 GHz: +3 dBm, +6 dBm (Typ.), 30 G to 50 GHz: 0 dBm, +3 dBm (Typ.) 50 G to 53 GHz: -10 dBm, -5 dBm (Typ.) 53 G to 54 GHz: -15 dBm, -10 dBm (Typ.)	
Output power range	Spec. Normal mode 10 M to 53 GHz : -20 dBm to max. output power Typ. Normal mode 10 M to 54 GHz: -30 dBm to max. output power High resolution mode 10 M to 54 GHz: -30 dBm to max. output power	
Power resolution	Typ. Normal mode: 0.5 dB (default) High resolution mode: 0.1 dB	
Output power accuracy	Spec. Normal mode, -10 dBm ≤ set power ≤ max. output power 10 M to 15 GHz: < 2.8 dB 15 G to 26.5 GHz: < 3.2 dB 26.5 G to 45 GHz: < 3.5 dB	

		<p>45 G to 53 GHz: <4 dB</p> <p>Normal mode, $-20 \text{ dBm} \leq \text{set power} < -10 \text{ dBm}$</p> <p>10 M to 15 GHz: <3.5 dB</p> <p>15 G to 26.5 GHz: < 4 dB</p> <p>26.5 G to 45 GHz: < 4.5 dB</p> <p>45 G to 53 GHz: <5 dB</p> <p>Normal mode, $-20 \text{ dBm} \leq \text{set power} \leq \text{max. output power}$</p> <p>53 G to 54 GHz : <5 dB</p>
	Typ.	<p>$-20 \text{ dBm} \leq \text{set power} \leq \text{max. output power}$ (Normal mode and high-resolution mode common)</p> <p>10M to 15 GHz: <1 dB</p> <p>15 G to 26.5 GHz: <1.2 dB</p> <p>26.5 G to 50 GHz: < 1.5 dB</p> <p>> 50 GHz: < 2 dB</p>
Phase noise	Typ.	<p>Clean source (cannot be shipped to export controlled countries) Option 151/161/251/261). See Table 16</p> <p>Standard (can be shipped to export controlled countries) (Option 150/160/250/260). See Table 17</p>
Return loss	Typ.	10 dB
Harmonics	Typ.	<p>Normal mode</p> <p>2nd Harmonic</p> <p>-15 dBc: 10 M to 3 GHz</p> <p>-20 dBc: > 3 GHz</p> <p>3rd Harmonics</p> <p>-10 dBc: 10 M to 10 GHz</p> <p>-30 dBc: >10 GHz</p>
Sub-harmonics	Typ.	<p>Normal mode</p> <p>< -25 dBc</p>

Table 16. Source output phase noise (Clean source, Max leveled power, Option 151/161/251/261) (Export Controlled options)

Output frequency	Typ.	Offset frequency [Hz] from the carrier									
		1	10	100	1 k	10 k	100 k	1 M	10 M	30 M	100 M
10 MHz		-118	-130	-138	-140	-140	-140	-140	-	-	-
100 MHz		-99	-125	-138	-145	-145	-145	-145	-145	-145	-
1 GHz		-79	-106	-120	-140	-153	-155	-155	-155	-155	-155
3 GHz		-69	-96	-110	-131	-145	-150	-157	-157	-157	-157
8 GHz		-61	-87	-101	-122	-137	-145	-152	-152	-152	-152
10 GHz		-58	-85	-99	-120	-135	-142	-150	-150	-150	-150
16 GHz		-54	-81	-95	-116	-131	-137	-145	-145	-145	-145
26.5 GHz		-50	-76	-91	-112	-126	-134	-140	-140	-140	-140
44 GHz		-46	-72	-86	-107	-121	-128	-135	-135	-135	-135
50 GHz		-45	-71	-85	-106	-120	-127	-135	-135	-135	-135
54 GHz		-44	-70	-84	-105	-119	-125	-130	-130	-130	-130

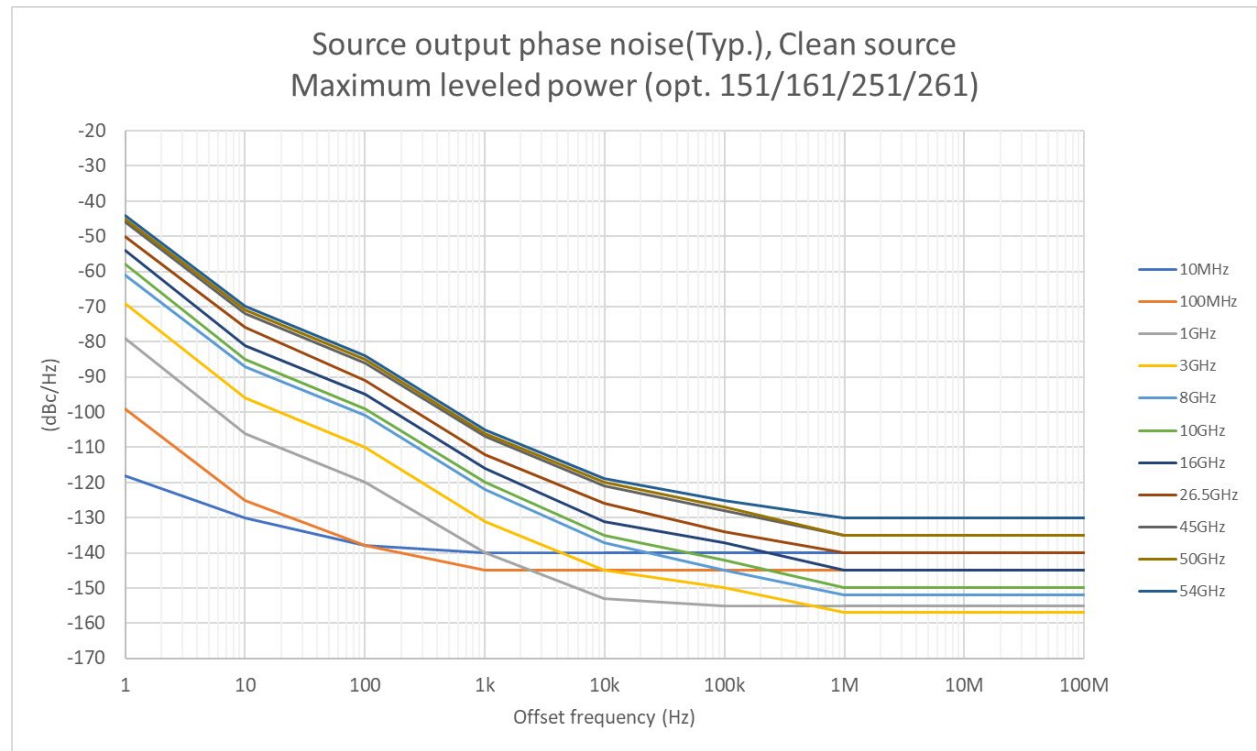
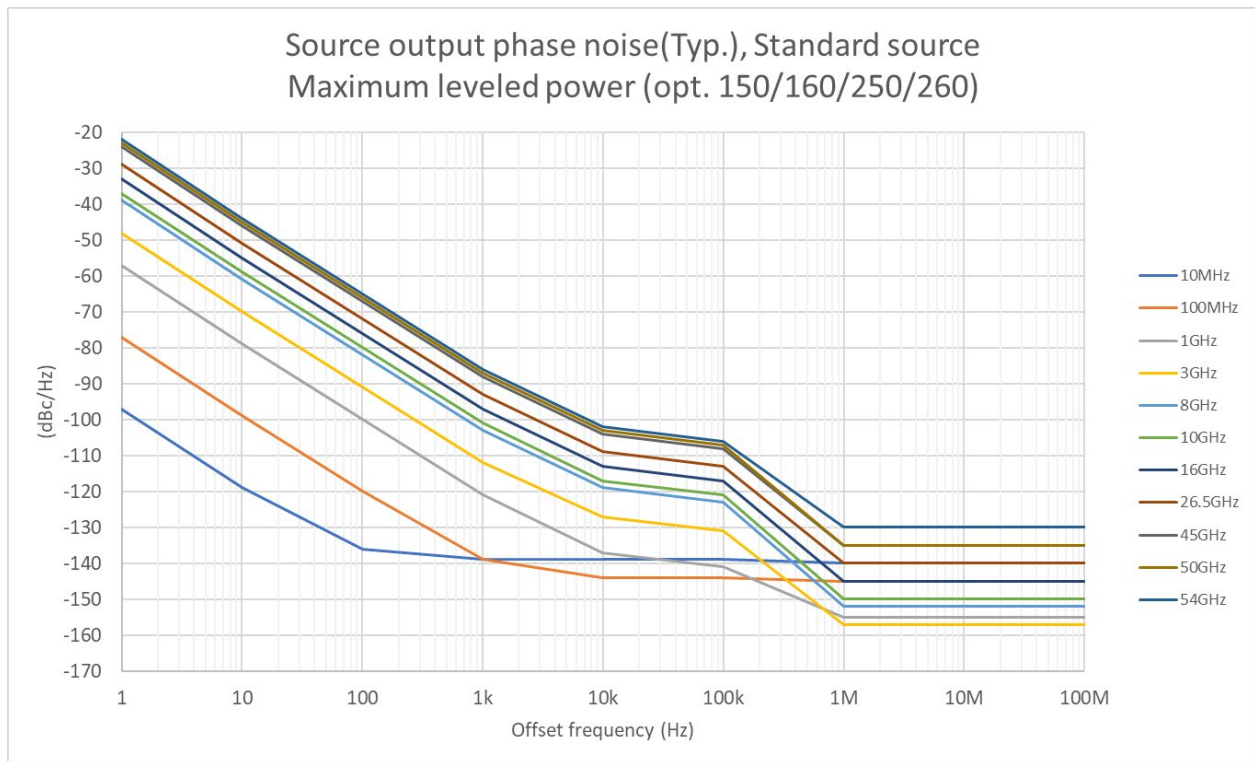

Table 17. Source output phase noise (Standard source, Option 150/160/250/260)

Output frequency		Offset frequency [Hz] from the carrier									
		1	10	100	1 k	10 k	100 k	1 M	10 M	30 M	100 M
10 MHz	Typ.	-97	-119	-136	-139	-139	-139	-140	–	–	–
100 MHz		-77	-99	-120	-139	-144	-144	-145	-145	-145	–
1 GHz		-57	-79	-100	-121	-137	-141	-155	-155	-155	-155
3 GHz		-48	-70	-91	-112	-127	-131	-157	-157	-157	-157
8 GHz		-39	-61	-82	-103	-119	-123	-152	-152	-152	-152
10 GHz		-37	-59	-80	-101	-117	-121	-150	-150	-150	-150
16 GHz		-33	-55	-76	-97	-113	-117	-145	-145	-145	-145
26.5 GHz		-29	-51	-72	-93	-109	-113	-140	-140	-140	-140
44 GHz		-24	-46	-67	-88	-104	-108	-135	-135	-135	-135
50 GHz		-23	-45	-66	-87	-103	-107	-135	-135	-135	-135
54 GHz		-22	-44	-65	-86	-102	-106	-130	-130	-130	-130



Baseband Noise Measurement

Table 18. Baseband noise measurement performance (E5055A/56A/57A/58A)

Description	Specification
Baseband input connector	BNC, 50 Ω nominal, AC coupled
Measurement frequency range	1 Hz to 100 MHz (AC(LF), DC block cutoff low) 1 kHz to 100 MHz (AC(HF), DC block cutoff high)
Measurement parameters	dBV/Hz, dBm/Hz, V/\sqrt{Hz}
Measurement level range	< +5 dBm @Gain 0 dB
Level measurement uncertainty (typ.)	DC block cutoff low: <3 dB (1 Hz to 100 Hz) <2 dB (100 Hz to 100 MHz) DC block cutoff high: <3 dB (1 kHz to 100 kHz) <2 dB (100 kHz to 100 MHz)
Gain setting	0 - 50 dB (10 dB step)
Cross correlation factor	1 to 100,000 (required S963015B for 2 to 100,000)
Noise floor level	See Table 19 (without spurious)

Table 19. Baseband noise floor [dBm/Hz], baseband input: 0 Ω terminated, Cross correlation factor = 1, Gain = 50 dB, Start offset = 1 Hz, DC block cutoff low, (without spurious)

	Offset Frequency [Hz]								
	1	10	100	1k	10k	100k	1M	10M	100M
Specification	-127	-139	-150	-159	-165	-167	-167	-167	-162
Typical	-134	-147	-154	-166	-172	-175	-175	-175	-166

DC Voltage Output

Table 20. DC supply and control voltage performances (E5055A/56A/57A/58A)

Description	Specification
DC supply (Vs) output	
Number of outputs	2
Floating/Grounded	Floating
Setting range	DC Supply1: 0 V to +16 V DC Supply2: -16 V to 0 V
Setting resolution	1 mV
Output voltage accuracy	$\pm(0.2\% \text{ of setting} + 2 \text{ mV})$
Current reading uncertainty	$\pm(0.2\% \text{ of reading} + 160 \mu\text{A})$ (0 to 100 mA) $\pm(0.5\% \text{ of reading} + 1.5 \text{ mA})$ (100 mA to 1 A)
Maximum output current	DC Supply1: 1 A [2 A] (0 V to 8 V) 0.3 A [0.6 A] (8 V to 16 V) DC Supply2: 0.3 A (-16 V to -8 V) 1 A (-8 V to 0 V) values in [] are the maximum current from DC Supply 1 in the VSupply Parallel mode (DC Supply 2 must be unconnected in the Parallel mode.).
Noise level (typical)	$<3 \text{ nVrms}/\sqrt{\text{Hz}}$ at 10 kHz
Output resistance (typical)	$<0.6 \Omega$
Output settling time (typical)	$<150 \text{ msec}$ @0.1% uncertainty
DC control voltage (VC) output	
Number of outputs	1
Floating/Grounded	Floating
Setting range	-35 V to +35 V
Setting resolution	0.1 mV
Output voltage accuracy	$\pm(0.1\% \text{ of setting} + 2 \text{ mV})$ (typ.)
Current reading uncertainty	$\pm(0.15\% \text{ of reading} + 50 \mu\text{A})$ (typ.)
Maximum output current	20 mA (typ.)
Noise level	$<1 \text{ nVrms}/\sqrt{\text{Hz}}$ at 10 kHz (Low noise mode: ON) (typ.)
Output resistance	$<30 \Omega$ (typ.)
Output settling time	$<20 \text{ msec}$ @0.1% uncertainty (Low noise mode: OFF) (typ.)
Tune VCO function	Available

VCO Characterization Measurements (required S96301xB SSA-X Signal Source Analyzer advanced features for E505xA)

Table 21. Frequency and RF power measurement performances in the VCO characterization measurements

Description	Specification (E5055A)	Specification (E5056A/57A/58A)
RF frequency range	1 MHz to 8 GHz (E5055A)	1 MHz to 26.5 GHz (E5056A) 1 MHz to 44 GHz (E5057A) 1 MHz to 54 GHz (E5058A)
Measurement frequency bands	1 MHz to 40 MHz, 10 MHz to 1.5 GHz, 250 MHz to 8 GHz	1M to 40MHz, 10M to 1.5GHz, 250M to 8GHz, Max. Freq. > 8 GHz
Sweep parameters	VControl(VC), VSupply1(VS1), VSupply2(VS2)	
Measurement parameters	Frequency, Frequency/V, Δfrequency, Power, CurrentVC, CurrentVS1, CurrentVS2	
Settable frequency resolution	0.1 Hz, 1 Hz, 10 Hz, 1 kHz, 64 kHz	
Frequency uncertainty	± (frequency setting resolution + time-base uncertainty)	
RF power measurement range	<p>Measurement frequency band: 250 MHz to 8 GHz -15 dBm to +20 dBm: 250 MHz ≤ signal frequency < 400 MHz -20 dBm to +20 dBm: 400 MHz ≤ signal frequency ≤ 8 GHz</p> <p>Measurement frequency band: other than 250 MHz to 8 GHz -20 dBm to +20 dBm</p>	<p>Measurement frequency band: 250 M to 8 GHz -15 dBm to +20 dBm: 250 MHz ≤ signal frequency < 400 MHz -20 dBm to +20 dBm: 400 MHz ≤ signal frequency ≤ 8 GHz</p> <p>Measurement frequency band: Max. Freq. >8 GHz -20 dBm to +20 dBm: signal frequency < 250 MHz -15 dBm to +20 dBm: 250 MHz ≤ signal frequency < 400 MHz -20 dBm to +20 dBm: 400 MHz ≤ signal frequency ≤ 8 GHz -15 dBm to +20 dBm: 8 GHz < signal frequency ≤ 40 GHz -10 dBm to +20 dBm: 40 GHz < signal frequency ≤ 50GHz 0 dBm to +20 dBm: 50 GHz < signal frequency ≤ 54 GHz</p> <p>Measurement frequency band: other than 250 M to 8 GHz and Max. Freq. > 8 GHz -20 dBm to +20 dBm</p>
RF power resolution	0.01 dB (typ.)	
RF power uncertainty (by peak detection)	<p>Input signal: sinusoidal wave, 1 MHz to 8 GHz ±1.2 dB: -20 dBm ≤ signal level < -10 dBm (spec.) ±1 dB: -10 dBm ≤ signal level ≤ +15 dBm (spec.) ±1.5 dB: +15 dBm < signal level ≤ +20 dBm (spec.)</p> <p>Input signal: sinusoidal wave, 1 MHz to 8 GHz ±0.5 dB: -20 dBm ≤ signal level ≤ +15 dBm (typ.) ±0.8 dB: +15 dBm < signal level ≤ +20 dBm (typ.)</p>	<p>Input signal: sinusoidal wave -20 dBm ≤ signal level < -10 dBm +/-2.5 dB: 1 M to 3 GHz +/-1.5 dB: 3 G to 8 GHz +/-2.5 dB: 8 G to 20 GHz +/-3dB: 20 G to 50 GHz +/-4.5dB: 50 G to 54 GHz</p> <p>-10 dBm ≤ signal level ≤ 0 dBm +/-1.5dB: 1 M to 8 GHz +/-2 dB: 8 G to 20 GHz +/-2.5dB: 20 G to 50 GHz +/-4 dB: 50 G to 54 GHz</p> <p>0 dBm < signal level ≤ +10 dBm +/-1.5 dB: 1M to 8 GHz +/-2dB: 8 G to 20 GHz +/-2.5dB: 20 G to 30 GHz</p>

Description	Specification (E5055A)	Specification (E5056A/57A/58A)
		<p>+10dBm < signal level ≤ +20dBm +/-1.5dB: 1 M to 8 GHz</p> <p>Input signal : sinusoidal wave -20 dBm ≤ signal level < -10 dBm +/-1 dB: 1 M to 50 GHz (typ.) +/-1.5 dB: 50 G to 54 GHz (typ.)</p> <p>-10 dBm ≤ signal level ≤ 0 dBm +/-0.5 dB: 1 M to 8 GHz (typ.) +/-1 dB: 8 G to 50 GHz (typ.) +/-1.5 dB: 50 G to 54 GHz (typ.)</p> <p>0 dBm < signal level ≤ +10 dBm +/-0.5dB: 1 M to 8 GHz (typ.) +/-1dB: 8 G to 30 GHz (typ.)</p> <p>+10 dBm < signal level ≤ +20 dBm 1 M to 8 GHz: +/-0.8 dB (typ.)</p>
Swept measurement points	1 to 100,003	

Transient Measurement (required S96301xB SSA-X Signal Source Analyzer advanced features for E505xA)

Table 22. Transient measurement performance

Description	Specification (E5055A)	Specification (E5056A/57A/58A)
Target frequency range	1 MHz to 8 GHz	
Input Power Range	<p>Wide mode: Measurement frequency band: 256 MHz to 8 GHz -15 dBm to +20 dBm: 256 MHz ≤ signal frequency <400 MHz -20 dBm to +20 dBm: 400 MHz ≤ signal frequency ≤8 GHz Measurement frequency band: other than 256 MHz to 8 GHz -20 dBm to +20 dBm</p> <p>Narrow mode: -20 dBm to +20 dBm</p>	<p>Wide mode: Measurement frequency band: 256 MHz to 8 GHz -15 dBm to +20 dBm: 256 MHz ≤ signal frequency <400 MHz -20 dBm to +20 dBm: 400 MHz ≤ signal frequency ≤8 GHz</p> <p>Measurement frequency band: Max. Freq. > 8 GHz Max. input level to the larger value of Max. input level -20dB and below -15 dBm: carrier 6G to 40GHz -10 dBm: carrier 40G to 50GHz 0 dBm: carrier 50G to 54GHz</p> <p>Measurement frequency band: other than 256 MHz to 8 GHz and Max. Freq. >8 GHz -20 dBm to +20 dBm</p> <p>Narrow mode: -20 to +20 dBm: 1M to 54GHz</p>
Measurement mode and parameters		
Measurement mode	Wideband - Narrowband (synchronous) Narrowband - Narrowband (synchronous)	
Measurement parameters	Wideband mode: Frequency Narrowband mode: Frequency, phase, power (Frequency span ≤ 30 MHz) Frequency, phase (Frequency span ≥ 80 MHz)	
Frequency transient bandwidth		
Wideband	1 M to 40 MHz 40 M to 160 MHz 80 M to 320 MHz 160 M to 640 MHz 320 M to 1.28 GHz 640 M to 2.56 GHz 1.28 G to 5.12 GHz 2.56 G to 8 GHz 256 M to 8 GHz	1M to 40MHz 40M to 160MHz 80M to 320MHz 160M to 640MHz 320M to 1.28GHz 640M to 2.56GHz 1.28G to 5.12GHz 2.56G to 8GHz 256M to 8GHz Max. Freq. > 8 GHz (Arbitrary 7 GHz bandwidth up to the user defined Max. Frequency. Max. Frequency range is 13 GHz to 54 GHz.)
Narrowband	320 MHz (carrier ≥ 800 MHz) 160 MHz (carrier ≥ 400 MHz) 80 MHz (carrier ≥ 200 MHz) 30 MHz (carrier ≥ 200 MHz) 10 MHz (carrier ≥ 100 MHz) 2.5 MHz (carrier ≥ 5 MHz) 312.5 kHz/25 kHz/3.125 kHz	
Frequency measurement		
Uncertainty	± (Resolution + Time-base uncertainty + Residual FM)	
Resolution ¹	See Table 23 (Wideband mode) and Table 24 (Narrowband mode)	
Time-base uncertainty	See Table 57 (for Internal Timebase)	

Description	Specification (E5055A)	Specification (E5056A/57A/58A)
Residual FM (Supplemental information) ²	Time span ≤10 sec, VBW auto 1 mHzrms/(Time span ^{1.5}) + 40 mHzrms/GHz	
RF power measurement (Narrow band mode only)		
Power level range	-20 dBm to +20 dBm	
Resolution	< 0.1 dB (typ.)	
Uncertainty	< 2 dB (typ.)	< 2 dB (1 MHz to 8 GHz) <3 dB (8 GHz to 54 GHz)
Phase measurement (Narrow band mode only, when DUT signal is locked to a target frequency)		
Uncertainty	±(Trace noise + stability) (typ.)	
Trace noise	Frequency span ≤ 30 MHz: 0.1 deg + 0.1 deg/GHz (typ.) Frequency span ≥ 80 MHz: 1 deg + 0.1 deg/GHz (typ.)	
Stability	Time span ≤10 sec 1 deg * TimeSpan + 0.02 deg * TimeSpan/GHz (typ.)	
Sweep measurement time		
Time span ³	10 μsec to 1,000 sec	
Time resolution ⁴	≥20 nsec	
Measurement trigger		
Trigger mode	Continuous / Single / Hold	
Trigger source	Internal / External / Manual / Bus	
Video trigger	Wide (Frequency), Narrow(Frequency, Power) Positive/Negative/Holdoff	

- Resolution is defined as minimum frequency difference of readings.
- Spurious response (ripple trace) may be observed depending on the measurement condition. Setting narrower VBW will improve the spurious response.
Wideband transient mode: <200 ppm of input signal frequency (VBW 3 MHz)
Narrowband transient mode: <100 kHzrms (frequency span ≤30 MHz, VBW 3 MHz)
<100 kHzrms (frequency span ≤80 MHz, input signal frequency ≥2 GHz, VBW 3 MHz)
<200 kHzrms (frequency span ≤80 MHz, input signal frequency <2 GHz, VBW 200 kHz)
- Minimum time span depends on frequency span or frequency range.
- Time resolution can change by VBW setting and minimum time resolution depends on frequency span and time span. See the table 23 and 24.

Transient Measurement/Wideband Mode

Table 23. Wideband mode frequency resolution vs. time span and frequency range

		Frequency Range																		
Time Span [sec]		10 μ	20 μ	50 μ	0.1 m	0.2 m	0.5 m	1 m	2 m	5 m	10 m	20 m	50 m	0.1	0.2	0.5	1	2	5	10
VBW (max) [Hz]	40 M - 160 MHz	3 M																		
VBW (min) [Hz]	80 M - 320 MHz	600 k	300 k	120 k	60 k	30 k	12 k	6 k	3 k	1.2 k	600	300	120	60	30	12	6	3	1.2	0.6
Time resolution (VBW max) [sec]	160 M - 640 MHz	20 n																		
Time resolution (VBW auto) [sec]	320 M - 1.28 GHz	20 n																		
Time resolution (VBW min) [sec]	640 M - 2.56 GHz	0.16 μ	0.32 μ	1.28 μ	2.56 μ	5.12 μ	10.2 μ	20.5 μ	41.0 μ	81.9 μ	164 μ	328 μ	1.31 m	2.62 m	5.24 m	10.5 m	21.0 m	41.9 m	83.9 m	168 m
Time resolution (VBW min) [sec]	1.28 G - 5.12 GHz	20 n																		
Time resolution (VBW min) [sec]	2.56 G - 8 GHz	20 n																		
Time resolution (VBW min) [sec]	Max. freq. >8 GHz	20 n																		
Frequency resolution (VBW auto) [Hz rms]	40 M - 160 MHz	6 k		5.1 k	1.8 k	450	160	57	14	5	1.8	0.8	0.8	0.8	0.8	0.8	0.8	0.8	0.8	0.8
	80 M - 320 MHz	12 k		6 k	2.1 k	530	190	67	17	6	2.5	1.6	1.6	1.6	1.6	1.6	1.6	1.6	1.6	1.6
	160 M - 640 MHz	24 k		12 k	4.2 k	1.1 k	380	140	34	12	5	3.2	3.2	3.2	3.2	3.2	3.2	3.2	3.2	3.2
	320 M - 1.28 MHz	48 k		24 k	8.4 k	2.2 k	750	270	70	24	9	6.4	6.4	6.4	6.4	6.4	6.4	6.4	6.4	6.4
	640 M - 2.56 GHz	96 k		48 k	16.8 k	4.3 k	1.5 k	540	140	50	17	13	13	13	13	13	13	13	13	13
	1.28 G - 5.12 GHz	192 k		95 k	34 k	8.5 k	3 k	1.1 k	270	95	34	26	26	26	26	26	26	26	26	26
	2.56 G - 8 GHz	384 k		190 k	67 k	17 k	6 k	2.2 k	540	190	67	26	26	26	26	26	26	26	26	26
Time Span [sec]		10 μ	20 μ	50 μ	0.1 m	0.2 m	0.5 m	1 m	2 m	5 m	10 m	20 m	50 m	0.1	0.2	0.5	1	2	5	10
VBW (max) [Hz]										150 k				130 k	65 k	32 k	16 k	8.1 k	2 k	1 k
VBW (min) [Hz]						30 k	12 k	6 k	3 k	1.2 k	600	300	120	60	30	12	6	3	1.2	0.6
Time resolution (VBW max) [sec]										0.32 μ			0.64 μ	1.28 μ	2.56 μ	5.12 μ	10.2 μ	20.5 μ	81.9 μ	164 μ
Time resolution (VBW auto) [sec]	1 M - 40 MHz					0.32 μ	1.28 μ	2.56 μ	5.12 μ	10.2 μ	20.5 μ	50.0 μ	81.9 μ	164 μ	655 μ	1.31 m	2.62 m	5.24 m	10.5 m	
Time resolution (VBW min) [sec]	256 M - 8 GHz					5.12 μ	10.2 μ	20.5 μ	41.0 μ	81.9 μ	164 μ	328 μ	1.31 m	2.62 m	5.24 m	10.5 m	21.0 m	41.9 m	83.9 m	168 m
Time resolution (VBW min) [sec]																				
Frequency resolution (VBW auto) [Hz rms]	1 M - 40 MHz					40	20	8	4	2	0.8	0.4	0.2	0.2	0.2	0.2	0.2	0.2	0.2	0.2
Frequency resolution (VBW auto) [Hz rms]	256 M - 8 GHz					2k			540	190	67	26	26	26	26	26	26	26	26	26

Transient Measurement/Narrowband Mode

Table 24. Narrowband mode frequency resolution vs. time span and frequency span

		Frequency Span																		
Time Span [sec]		10 μ	20 μ	50 μ	0.1 m	0.2 m	0.5 m	1 m	2 m	5 m	10 m	20 m	50 m	0.1	0.2	0.5	1	2	5	10
320 MHz	VBW (max) [Hz]	3 M																		
	VBW (min) [Hz]	600 k	300 k	120 k	60 k	30 k	12 k	6 k	3 k	1.2 k	600	300	120	60	30	12	6	3	1.2	0.6
	Time resolution (VBW max) [sec]	40 n																		
	Time resolution (VBW auto) [sec]	80 n																		
	Time resolution (VBW min) [sec]	160 n																		
	Frequency resolution (VBW auto) [Hz rms]	24 k																		
	Frequency resolution [Hz rms]	12 k																		
160 MHz	VBW (max) [Hz]	3 M																		
	VBW (min) [Hz]	600 k	300 k	120 k	60 k	30 k	12 k	6 k	3 k	1.2 k	600	300	120	60	30	12	6	3	1.2	0.6
	Time resolution (VBW max) [sec]	40 n																		
	Time resolution (VBW auto) [sec]	80 n																		
	Time resolution (VBW min) [sec]	160 n																		
	Frequency resolution (VBW auto) [Hz rms]	20.2 k																		
	Frequency resolution [Hz rms]	10.2 k																		
80 MHz	VBW (max) [Hz]	3 M																		
	VBW (min) [Hz]	600 k	300 k	120 k	60 k	30 k	12 k	6 k	3 k	1.2 k	600	300	120	60	30	12	6	3	1.2	0.6
	Time resolution (VBW max) [sec]	40 n																		
	Time resolution (VBW auto) [sec]	80 n																		
	Time resolution (VBW min) [sec]	160 n																		
	Frequency resolution (VBW auto) [Hz rms]	20.2 k																		
	Frequency resolution [Hz rms]	10.2 k																		
30 MHz	VBW (max) [Hz]	3 M																		
	VBW (min) [Hz]	600 k	300 k	120 k	60 k	30 k	12 k	6 k	3 k	1.2 k	600	300	120	60	30	12	6	3	1.2	0.6
	Time resolution (VBW max) [sec]	20 n																		
	Time resolution (VBW auto) [sec]	20 n																		
	Time resolution (VBW min) [sec]	160 n																		
	Frequency resolution (VBW auto) [Hz rms]	2000																		
	Frequency resolution [Hz rms]	2000																		
10 MHz	VBW (max) [Hz]	-	-	50 μ	0.1 m	0.2 m	0.5 m	1 m	2 m	5 m	10 m	20 m	50 m	0.1	0.2	0.5	1	2	5	10
	VBW (min) [Hz]	-	-	120 k	60 k	30 k	12 k	6 k	3 k	1.2 k	600	300	120	60	30	12	6	3	1.2	0.6
	Time resolution (VBW max) [sec]	80 n																		
	Time resolution (VBW auto) [sec]	80 n																		
	Time resolution (VBW min) [sec]	1.28 μ																		
	Frequency resolution (VBW auto) [Hz rms]	1260																		
	Frequency resolution [Hz rms]	450																		
2.5 MHz	VBW (max) [Hz]	-	-	-	0.1 m	0.2 m	0.5 m	1 m	2 m	5 m	10 m	20 m	50 m	0.1	0.2	0.5	1	2	5	10
	VBW (min) [Hz]	-	-	-	60 k	30 k	12 k	6 k	3 k	1.2 k	600	300	120	60	30	12	6	3	1.2	0.6
	Time resolution (VBW max) [sec]	320 n																		
	Time resolution (VBW auto) [sec]	320 n																		
	Time resolution (VBW min) [sec]	2.56 μ																		
	Frequency resolution (VBW auto) [Hz rms]	110																		
	Frequency resolution [Hz rms]	39																		

**Frequency
Span**

Time Span [sec]	-	-	-	-	-	-	1 m	2 m	5 m	10 m	20 m	50 m	0.1	0.2	0.5	1	2	5	10	
VBW (max) [Hz]	-	-	-	-	-	-	-	-	-	-	-	-	-	-	65 k	32 k	16 k	8.1 k	2 k	1 k
VBW (min) [Hz]	-	-	-	-	-	-	6 k	3 k	1.2 k	600	300	120	60	30	12	6	3	1.2	0.6	
Time resolution (VBW max) [sec]	-	-	-	-	-	-	2.56 μ								5.12 μ	10.2 μ	20.5 μ	81.9 μ	164 μ	
Time resolution (VBW auto) [sec]	-	-	-	-	-	-	2.56 μ	5.12 μ	10.2 μ	20.5 μ	41.0 μ	81.9 μ	164 μ	655 μ	1.31 m	2.62 m	5.24 m	10.5 m		
Time resolution (VBW min) [sec]	-	-	-	-	-	-	20.5 μ	41.0 μ	81.9 μ	164 μ	328 μ	1.31 m	2.62 m	5.24 m	10.5 m	21.0 m	41.9 m	83.9 m	168 m	
Frequency resolution (VBW auto) [Hz rms]	-	-	-	-	-	-	10	8	4	2	0.8	0.4	0.2	0.2	0.2	0.2	0.2	0.2	0.2	
Time Span [sec]	-	-	-	-	-	-	-	-	-	10 m	20 m	50 m	0.1	0.2	0.5	1	2	5	10	
VBW (max) [Hz]	-	-	-	-	-	-	-	-	-	-	-	-	-	-	8.1 k	-	-	-	2 k	1 k
VBW (min) [Hz]	-	-	-	-	-	-	-	-	-	600	300	120	60	30	12	6	3	1.2	0.6	
Time resolution (VBW max) [sec]	-	-	-	-	-	-	-	-	-	20.5 μ								81.9 μ	164 μ	
Time resolution (VBW auto) [sec]	-	-	-	-	-	-	-	-	-	20.5 μ	41.0 μ	81.9 μ	164 μ	655 μ	1.31 m	2.62 m	5.24 m	10.5 m		
Time resolution (VBW min) [sec]	-	-	-	-	-	-	-	-	-	164 μ	328 μ	1.31 m	2.62 m	5.24 m	10.5 m	21.0 m	41.9 m	83.9 m	168 m	
Frequency resolution (VBW auto) [Hz rms]	-	-	-	-	-	-	-	-	-	1	0.8	0.4	0.2	0.08	0.04	0.02	0.01	0.01		
Time Span [sec]	-	-	-	-	-	-	-	-	-	-	-	-	0.1	0.2	0.5	1	2	5	10	
VBW (max) [Hz]	-	-	-	-	-	-	-	-	-	-	-	-	-	-	1 k	-	-	-	-	-
VBW (min) [Hz]	-	-	-	-	-	-	-	-	-	-	-	-	60	30	12	6	3	1.2	0.6	
Time resolution (VBW max) [sec]	-	-	-	-	-	-	-	-	-	-	-	-	164 μ							
Time resolution (VBW auto) [sec]	-	-	-	-	-	-	-	-	-	-	-	-	164 μ	655 μ	1.31 m	2.62 m	5.24 m	10.5 m		
Time resolution (VBW min) [sec]	-	-	-	-	-	-	-	-	-	-	-	-	2.62 m	5.24 m	10.5 m	21.0 m	41.9 m	83.9 m	168 m	
Frequency resolution (VBW auto) [Hz rms]	-	-	-	-	-	-	-	-	-	-	-	-	0.2	0.08	0.04	0.02	0.01	0.01		

External Mixer Support (required E5056A/57A/58A option 401/400)

Table 25. Specifications of External Mixer Support (option 401/400 on E5056A/57A/58A)

Description	Specification (E5055A) ¹	Specification (E5056A/57A/58A)
LO Outputs		
LO out connector	Not Supported	SMA female, 50 Ω
LO signal	Not Supported	
Frequency range		3 GHz to 20 GHz
Maximum output power	Not Supported	+16dBm: 3 GHz to 10 GHz +13dBm: 10 GHz to 20 GHz
Output power range	Not Supported	-10dBm to max. output power
Output power accuracy	Not Supported	+/-2.8dB: 3 GHz to 15 GHz +/-3.2dB: 15 GHz to 20 GHz +/-1dB: 3 GHz to 15 GHz (typ.) +/-1.5dB: 15 GHz to 20 GHz (typ.)
Output power resolution	Not Supported	0.5 dB
Harmonics	Not Supported	< -20 dBc (typ.)
Sub-harmonics	Not Supported	< -40 dBc (typ.)
Damage level	Not Supported	+27 dBm RF, 35 VDC max.
IF Inputs		
IF In connector	Not Supported	SMA female, 50 Ω
Frequency range	Not Supported	1MHz to 8GHz
Input power range	Not Supported	1 dB compression level to -70 dBm (typ.)
1 dB compression level	Not supported	+4 dBm at IF gain 0 dB (typ.)
Noise floor	Not supported	-162 dBm/Hz @1 GHz, IF gain 36 dB (typ.)
IF gain	Not supported	0 dB to 36 dB in 1 dB step
Level uncertainty at IF frequency	Not Supported	+/- 2dB (typ.)
Damage level	Not Supported	+27 dBm RF, 0 VDC max.
Other support conditions		
Supported measurement classes	Not Supported	Phase Noise

Table 26. Phase noise sensitivity when using external mixers (Supplemental characteristics)

(To be added later)

Spectrum Measurement (required S96301xB for Spectrum monitor capability and S96390xB for full span / capability of spectrum analysis)

Table 27. Spectrum measurement performance (required S96390xB spectrum analysis for E505xA)

Description	Specification (E5055A)	Specification (E5056A/57A/58A)
Frequency specifications		
Frequency readout accuracy (nom.)	$\pm [(readout\ frequency * frequency\ reference\ accuracy) + (<1\% * RBW)]$	
Frequency span	8.0991 GHz(max.) (with S963905B) 15 MHz (max.) (spectrum monitor, with S963015B)	26.5 GHz(max.) (E5056A with S963906B) 44 GHz(max) (E5057A with S963907B) 54 GHz(max) (E5058A with S963908B) 15 MHz (max.) (spectrum monitor, with S96301xB)
Frequency resolution	1 Hz	
Sweep (Trace) point range	11 to 100,001	
Resolution bandwidth (RBW) range	10 Hz to 3 MHz in 10% steps (-3 dB bandwidth)	
Bandwidth range accuracy (Supplemental information)	$\pm 1\%$, all RBW, except below 100 MHz with 3 MHz RBW	
Selectivity (-60 dB / -3 dB) (Supplemental information)	Gaussian: 4.5: 1, Flat top: 2.47: 1, Kaiser: 3.82: 1, Blackman: 3.58: 1	
Video bandwidth (VBW) range	10 Hz to 3 MHz	
Time Specifications		
Sweep time and triggering range		
Sweep time range	Auto	
Trigger types	Continuous, Single, Group, Manual, External	
Trigger delay range	0 to 3 sec	
Trigger delay resolution	1 μ sec	
Measuring and display update rate (Supplemental information)	20 MHz Span, 3 kHz RBW, 3 kHz VBW: 60 msec 100 MHz Span, Auto RBW, Auto VBW: 66 msec 1 GHz Span, 3 kHz RBW, 3 kHz VBW: 370 msec 1 GHz Span, 300 kHz RBW, 300 kHz VBW: 320 msec 4 GHz Span, 3 kHz RBW, 3 kHz VBW: 1,300 msec 4 GHz Span, 300 kHz RBW, 300 kHz VBW: 1,000 msec 10 MHz to 8 GHz, RBW/VBW = 1 MHz: 1480 msec	To be added later
Amplitude accuracy and range		
Amplitude measurement range	DANL to maximum input level	
Receiver attenuation range	0 dB to 30 dB, 1 dB step	0 dB to 28 dB, 2 dB step
Display range	0.001 to 500 dB/div in 0.001 steps (log scale) 10 divisions (default) (linear scale) dBm, mW (Scale unit) Average, Sample, Peak, Negative peak, Peak sample, Peak average, Normal (Trace detector types)	
RBW switching uncertainty (Supplemental information)	0.02 dB	
Display scale fidelity (Supplemental information)	± 0.1 dB, -10 dBm to -70 dBm (Receiver attenuation 0 dB, IF Gain Auto)	
Absolute level uncertainty	< 1dB at 50MHz (at Receiver attenuation 10dB, Pin -10 dBm, IF Gain Auto)	
Frequency response	1 M to 1 GHz: < 2 dB 1 G to 3 GHz: < 1.5 dB 3 G to 8 GHz: < 2 dB (at Receiver attenuation 10 dB, Pin -10 dBm, reference to 50 MHz, IF Gain Auto)	1 M to 1 GHz: < 2 dB 1 G to 3 GHz: < 1.5 dB 3 G to 18 GHz: < 2 dB 18 G to 26.5 GHz: < 2.5 dB 26.5 G to 50 GHz: < 3 dB 50 G to 54 GHz: < 4 dB (at Receiver attenuation 10 dB, Pin -10 dBm, reference to 50 MHz, IF Gain Auto)
Input attenuator switching uncertainty	Receiver attenuation=0 dB to 30 dB relative to 10 dB, IF Gain Auto <0.8 dB (@50MHz,) <0.5 dB (@ other frequencies) (typ.)	Receiver attenuation=0 dB to 28 dB relative to 10 dB, IF Gain Auto <0.8 dB (@50MHz,) <0.5 dB (1 M to 26.5 GHz) (typ.) <0.8 dB (26.5 G to 50 GHz) (typ.)

Description	Specification (E5055A)	Specification (E5056A/57A/58A)
		<1.5 dB (50 G to 54 GHz) (typ.)
Total measurement uncertainty	± (Absolute level uncertainty + Input attenuator switching uncertainty) (@50 MHz, Pin=-10 dBm, IF Gain Auto) ± (Absolute level uncertainty + frequency response + Input attenuator switching uncertainty) (@other frequencies, Pin=-10 dBm, IF Gain Auto) (typical)	
Spurious response		
Image response	Mostly eliminated. Intermittent image response may be seen when making multi-tone or modulated signal measurements.	
LO related spurious	< -45 dBc @ +/-1.2 GHz offset from signal (typ.)	
Other spurious (typ.)	-70 dBm (100 MHz), -90 dBm (300 MHz), and < -100 dBm (500 MHz, 700 MHz)	< -100 dBm
Description	Specification (E5055A)	Specification (E5056A/57A/58A)
Sensitivity		
Displayed average noise level (DANL)	-139 dBm/Hz, -145 dBm/Hz (typ.) (1 MHz to 50 MHz) -148 dBm/Hz, -152 dBm/Hz (typ.) (50 MHz to 1 GHz) -148 dBm/Hz, -152 dBm/Hz (typ.) (1 GHz to 3 GHz) -146 dBm/Hz, -150 dBm/Hz (typ.) (3 GHz to 5 GHz) -145 dBm/Hz, -149 dBm/Hz (typ.) (5 GHz to 6.5 GHz) -143 dBm/Hz, -148 dBm/Hz (typ.) (6.5 GHz to 8 GHz) (Receiver attenuation=0 dB, Tested with RBW = 1 kHz up to 50 MHz, and 10 kHz for above 50 MHz, terminated, average detector, averaging type=log, IF gain=auto, image rejection normal, random LO=OFF, IF Gain Auto)	-139 dBm/Hz, -145 dBm/Hz (typ.) (1 MHz to 50 MHz) -143 dBm/Hz, -147 dBm/Hz (typ.) (50 MHz to 3 GHz) -141 dBm/Hz, -145 dBm/Hz (typ.) (3 GHz to 5 GHz) -139 dBm/Hz, -143 dBm/Hz (typ.) (5 GHz to 6.5 GHz) -135 dBm/Hz, -136 dBm/Hz (typ.) (6.5 GHz to ≤8.1 GHz) -140 dBm/Hz, -144 dBm/Hz (typ.) (>8.1 GHz to 25 GHz) -135 dBm/Hz, -140 dBm/Hz (typ.) (25 GHz to 40 GHz) -130 dBm/Hz, -135 dBm/Hz (typ.) (40 GHz to 50 GHz) -100 dBm/Hz, -105 dBm/Hz (typ.) (50 GHz to 54 GHz) (Receiver attenuation=0 dB, Tested with RBW = 10 kHz, terminated, average detector, averaging type=log, IF gain=auto, image rejection normal, random LO=OFF, IF Gain Auto)
Intermodulation		
2'nd harmonic intercept point (SHI)	≥ +17 dBm (1 MHz to 1 GHz) ≥ +20 dBm (1 GHz to 4 GHz) (RF attenuation=0 dB, RF in= -10 dBm, IF Gain Auto)	≥ +14 dBm (1 MHz to 1 GHz) ≥ +17 dBm (1 GHz to 3 GHz) ≥ +10 dBm (3 GHz to 5 GHz) ≥ +17 dBm (5 GHz to 18 GHz) ≥ +10 dBm (18 GHz to 25 GHz) ≥ +9 dBm (25 GHz to 27 GHz) (RF attenuation=0 dB, RF in= -10 dBm, IF Gain Auto)
3'rd order intercept point (TOI)	≥ +8 dBm, ≥ +11 dBm (typ.) (1 MHz to 50 MHz) ≥ +8 dBm, ≥ +11 dBm (typ.) (50 MHz to 1 GHz) ≥ +7 dBm, ≥ +10 dBm (typ.) (1 GHz to 3 GHz) ≥ +6 dBm, ≥ +9 dBm (typ.) (3 GHz to 8 GHz) (Receiver attenuation=0 dB, RF in= -10 dBm, 100 kHz tone separation, IF Gain Auto)	≥ +2 dBm, ≥ +5 dBm (typ.) (1 MHz to 1 GHz) ≥ +5 dBm, ≥ +7 dBm (typ.) (1 GHz to 8 GHz) ≥ +6 dBm, ≥ +9 dBm (typ.) (8 GHz to 54 GHz) (Receiver attenuation=0 dB, RF in= -10 dBm, 100 kHz tone separation, IF Gain Auto)
Spectrum purity		
Option 1xx standard phase noise (typ.)	Carrier frequency = 1 GHz -92 dBc/Hz (offset frequency: 10 Hz) -107 dBc/Hz (offset frequency: 100 Hz) -131 dBc/Hz (offset frequency: 1 kHz) -143 dBc/Hz (offset frequency: 10 kHz) -143 dBc/Hz (offset frequency: 100 kHz) -143 dBc/Hz (offset frequency: 1 MHz) -143 dBc/Hz (offset frequency: 10 MHz)	
Option 2xx Enhanced low phase noise (typ.)	Carrier frequency = 1 GHz -93 dBc/Hz (offset frequency: 10 Hz) -111 dBc/Hz (offset frequency: 100 Hz) -137 dBc/Hz (offset frequency: 1 kHz) -143 dBc/Hz (offset frequency: 10 kHz) -143 dBc/Hz (offset frequency: 100 kHz) -143 dBc/Hz (offset frequency: 1 MHz) -143 dBc/Hz (offset frequency: 10 MHz)	

Precision clock jitter analysis (required S96302B Precision Clock Jitter Analysis for SSA-X Signal Source Analyzer)

Table 28. Functions and performance of Precision clock jitter analysis

Clock jitter analysis	
Measurement functions	RJ (Random jitter), PJ (Periodic jitter) frequency, PJ decomposition with auto-trend correction
Measurement parameters	RJ: rms, PJ: frequency, rms, p-p (peak-to-peak), d-d (dual-dirac) TJ (Total jitter): p-p, jitter trend (phase deviation waveform), jitter histogram
Jitter spectrum analysis range	Same as phase noise measurement offset frequency range

Pulsed-RF Phase Noise Measurements (required S96325B Pulsed-RF measurements for SSA-X Signal Source Analyzer)

Table 29. Pulsed-RF phase noise measurement performance

Description	Specification (E5055A)	Specification (E5056A/57A/58A)
RF frequency range	1 MHz to 8 GHz (E5055A with S96325B)	1 MHz to 26.5 GHz (E5056A with S96325B) 1 MHz to 44 GHz (E5057A with S96325B) 1 MHz to 54 GHz (E5058A with S96325B)
Minimum offset frequency	1 mHz	
Maximum offset frequency	(Tp: pulse repetition interval) 3 MHz: 50 nsec ≤ Tp ≤ 139 nsec, carrier > 7.6 MHz 2.5 MHz: 139 nsec < Tp ≤ 279 nsec, carrier > 7.6 MHz 1 MHz: 279 nsec < Tp ≤ 559 nsec, carrier > 2 MHz 620 kHz: 559 nsec < Tp ≤ 1.1 usec, carrier > 2 MHz 300 kHz: 1.1 usec < Tp ≤ 2.2 usec 150 kHz: 2.2 usec < Tp ≤ 4.4 usec 78 kHz: 4.4 usec < Tp ≤ 8.9 usec 39 kHz: 8.9 usec < Tp ≤ 17 usec 19 kHz: 17 usec < Tp ≤ 35 usec 9.7 kHz: 35 usec < Tp ≤ 71 usec 4.8 kHz: 71 usec < Tp ≤ 140 usec 2.4 kHz: 140 usec < Tp ≤ 280 usec 1.2 kHz: 280 usec < Tp ≤ 570 usec 610 Hz: 570 usec < Tp ≤ 1.1 msec 300 Hz: 1.1 msec < Tp ≤ 2.2 msec 150 Hz: 2.2 msec < Tp ≤ 4.5 msec 76 Hz: 4.5 msec < Tp ≤ 9.1 msec 38 Hz: 9.1 msec < Tp ≤ 10 msec	
Pulse repetition interval	50 nsec to 10 msec (settable)	
Pulse duty cycle (typ.)	0.01% to 50%, pulse width > 100 nsec	
Phase noise/AM noise sensitivity (nom.)	The pulsed-RF phase noise/AM noise sensitivity is determined by the sum of the phase noise/AM noise sensitivity for CW signal (Table 2, 4, and 10 for E5055A, Table 3, 5, and 11 for E5056A/57A/58A) and the noise floor expressed by the following equations which depends on the duty cycle of the input pulse signal. Start offset = 1 Hz, Cross correlation factor = 1, Signal level = +10 dBm (< 44 GHz), +5 dBm (≥ 44 GHz), Receiver attenuation = 10 dB Offset frequency < 300 kHz 1 MHz ≤ carrier ≤ 3 GHz: -177 dBc/Hz – 20log ₁₀ (duty cycle) – 5log ₁₀ (Offset frequency/300 kHz) 3 GHz < carrier ≤ 6 GHz: -175 dBc/Hz – 20log ₁₀ (duty cycle) – 5log ₁₀ (Offset frequency/300 kHz) 6 GHz < carrier ≤ 8 GHz: -172 dBc/Hz – 20log ₁₀ (duty cycle) – 5log ₁₀ (Offset frequency/300 kHz) 8 GHz < carrier ≤ 26.5 GHz: -169 dBc/Hz – 20log ₁₀ (duty cycle) – 5log ₁₀ (Offset frequency/300 kHz) 26.5 GHz < carrier ≤ 44 GHz: -165 dBc/Hz – 20log ₁₀ (duty cycle) – 5log ₁₀ (Offset frequency/300 kHz)	

Description	Specification (E5055A)	Specification (E5056A/57A/58A)
	<p>44 GHz < carrier ≤ 50 GHz: -160 dBc/Hz – 20log₁₀(duty cycle) – 5log₁₀(Offset frequency/300 kHz) 50 GHz < carrier ≤ 54 GHz: -145 dBc/Hz – 20log₁₀(duty cycle) – 5log₁₀(Offset frequency/300 kHz)</p> <p>Offset frequency ≥ 300 kHz 1 MHz ≤ carrier ≤ 3 GHz: -177 dBc/Hz – 20log₁₀(duty cycle) 3 GHz < carrier ≤ 6 GHz: -175 dBc/Hz – 20log₁₀(duty cycle) 6 GHz < carrier ≤ 8 GHz: -172 dBc/Hz – 20log₁₀(duty cycle) 8 GHz < carrier ≤ 26.5 GHz: -169 dBc/Hz – 20log₁₀(duty cycle) 26.5 GHz < carrier ≤ 44 GHz: -165 dBc/Hz – 20log₁₀(duty cycle) 44 GHz < carrier ≤ 50 GHz: -160 dBc/Hz – 20log₁₀(duty cycle) 50 GHz < carrier ≤ 54 GHz: -145 dBc/Hz – 20log₁₀(duty cycle)</p>	
Phase noise/AM noise measurement accuracy (typ.)	<p>Phase noise: <1.5 dB: offset ≤ 1 MHz <2 dB: offset >1 MHz</p> <p>AM noise: <2 dB: offset ≤ 1 MHz <2.5 dB: offset >1 MHz</p>	<p>Phase noise Carrier 1 MHz to 26.5 GHz <1.5 dB: offset ≤ 1 MHz <2 dB: offset >1 MHz Carrier 26.5 GHz to 54 GHz <2.5dB: offset ≤ 1 MHz <3 dB: offset >1MHz</p> <p>AM noise Carrier 1 MHz to 26.5 GHz <2 dB: offset ≤ 1 MHz : <2.5 dB: offset >1 MHz Carrier 26.5 GHz to 54 GHz <3dB: offset ≤ 1 MHz <3.5 dB: offset > 1MHz</p>
Spurious level (typ.)	< -60 dBc with cross correlation >6 sec.	

Vector Network Analyzer (required E505xA-161/160/261/260)

Dynamic Range

The specifications in this section apply to measurements made with the Keysight E5055A/56A/57A/58A SSA-X Signal Source Analyzer option 160/161/260/261 under the following conditions:

- 10 Hz IF bandwidth
- No averaging applied to data
- Does not include crosstalk effects

Table 30. System dynamic range at test port (dB) ¹

E5055A option 160/161/260/261

Description	Specification	Typical
9 kHz to 100 kHz	101	111
100 kHz to 300 kHz	117	126
300 kHz to 1 MHz	125	136
1 MHz to 10 MHz	130	141
10 MHz to 50 MHz ²	137	147
50 MHz to 3 GHz	140	150
3 GHz to 5 GHz	140	149
5 GHz to 6.5 GHz	140	148
6.5 GHz to 9 GHz	136	146

E5056A/57A/58A option 160/161/260/261

Description	Specification	Typical
100 kHz to 300 kHz	95	106
300 kHz to 500 kHz	104	120
500 kHz to 1 MHz	117	130
1 MHz to 10 MHz	125	138
10 MHz to 50 MHz ²	137	147
50 MHz to 6.5 GHz	140	150
6.5 GHz to 8 GHz	137	150
8 GHz to 9 GHz	136	146
9 GHz to 16 GHz	136	146
16 GHz to 17 GHz	136	141
17 GHz to 20 GHz	130	141
20 GHz to 24 GHz	128	141
24 GHz to 25 GHz	128	139
25 GHz to 26 GHz	120	139
26 GHz to 30 GHz	120	135
30 GHz to 35 GHz	120	135
35 GHz to 40 GHz	120	132
40 GHz to 45 GHz	119	129

Description	Specification	Typical
45 GHz to 50 GHz	96	111
50 GHz to 53 GHz	68	97

1. System dynamic range = source maximum output power minus receiver noise floor.
2. It may typically be degraded at 25 MHz.

Corrected System Performance

This section provides specifications for the corrected performance of the E5055A/56A/57A/58A option x6x Vector Network Analyzer capabilities options using either of 85032F, 85052D, 85056A, 85058B Mechanical Calibration Kit or N4691D, N4693D, N4694D Electronic Calibration (ECal) Module. To determine transmission and reflection uncertainty curves with other calibration kits, please download the Uncertainty Calculator from http://www.keysight.com/find/na_calculator to generate the curves for your specific calibration kit.

Measured with 10 Hz IF bandwidth, no averaging applied to data, environmental temperature = 23 °C (± 3 °C) with < 1 °C deviation from calibration temperature.

Table 31. E5055A Option 160/161/260/261 with 85032F standard mechanical calibration kit

Corrected error terms (dB) – Specifications

Description	9 kHz to 50 MHz	50 MHz to 3 GHz	3 GHz to 6 GHz	6 GHz to 9 GHz
Directivity	49	46	40	38
Source match	41	40	36	35
Load match	47	46	40	38
Reflection tracking	± 0.011	± 0.021	± 0.032	± 0.054
Transmission tracking	± 0.082	± 0.021	± 0.063	± 0.074

Transmission uncertainty (magnitude and phase)

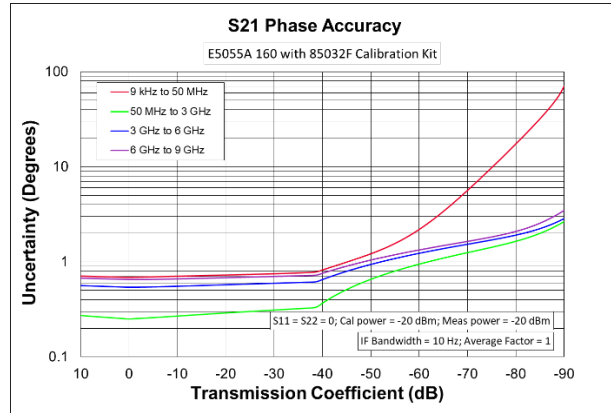
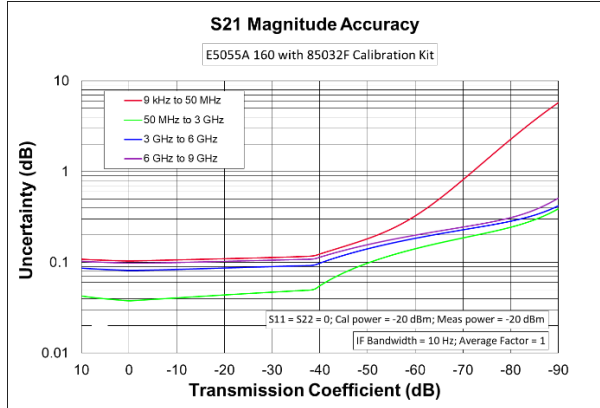

Reflection uncertainty (magnitude and phase)

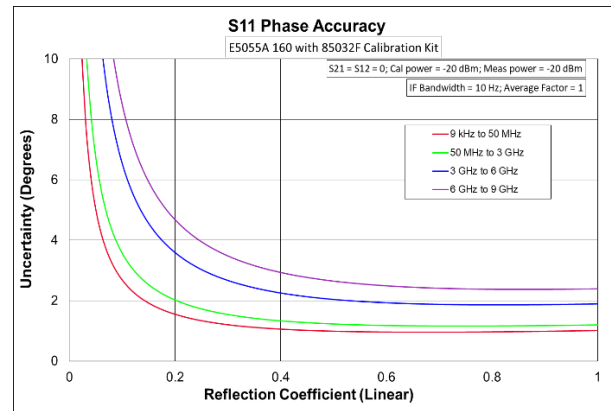
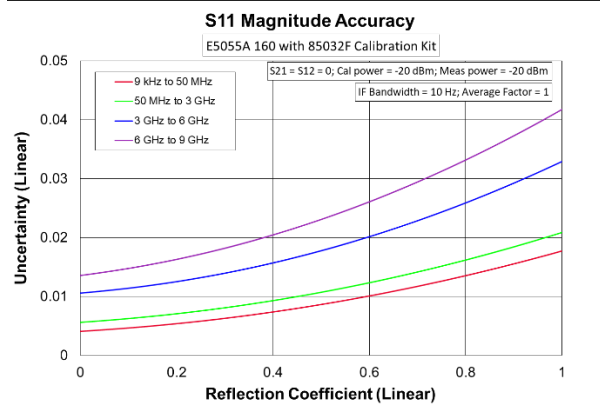
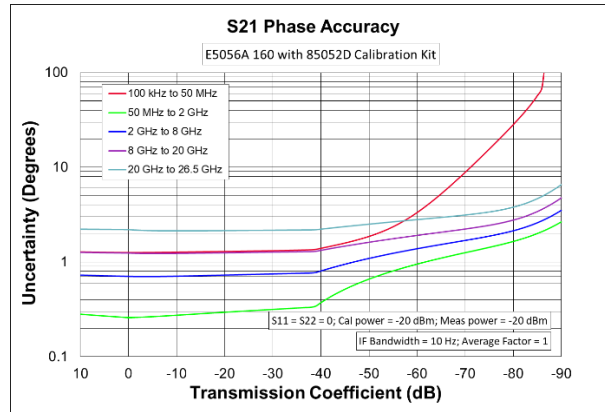
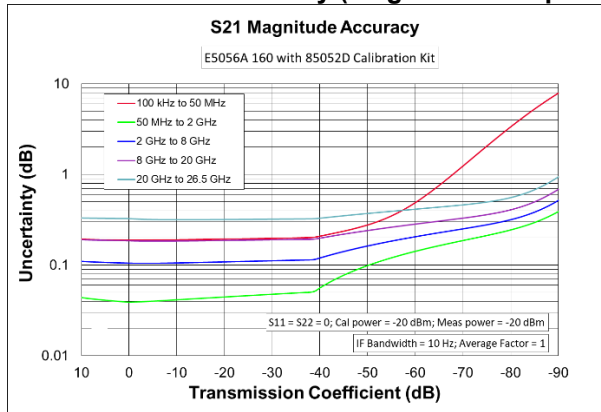

Table 32. E5056A Option 160/161/260/261 with 85052D economy mechanical calibration kit

Corrected error terms (dB) – Specifications

Description	9 kHz to 50 MHz	50 MHz to 2 GHz	2 GHz to 8 GHz	8 GHz to 20 GHz	20 GHz to 26.5 GHz
Directivity	42	42	38	36	30
Source match	37	37	31	28	25
Load match	42	42	38	36	30
Reflection tracking	± 0.003	± 0.003	± 0.004	± 0.008	± 0.011
Transmission tracking	± 0.136	± 0.03	± 0.1	± 0.185	± 0.292

Transmission uncertainty (magnitude and phase)



Reflection uncertainty (magnitude and phase)

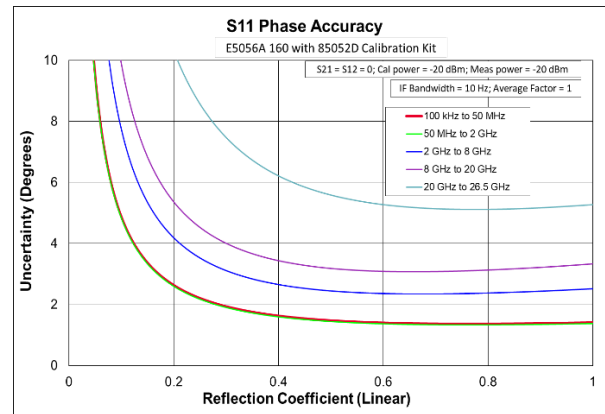
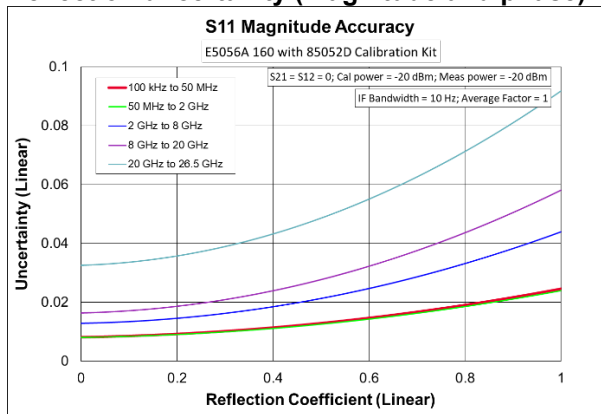
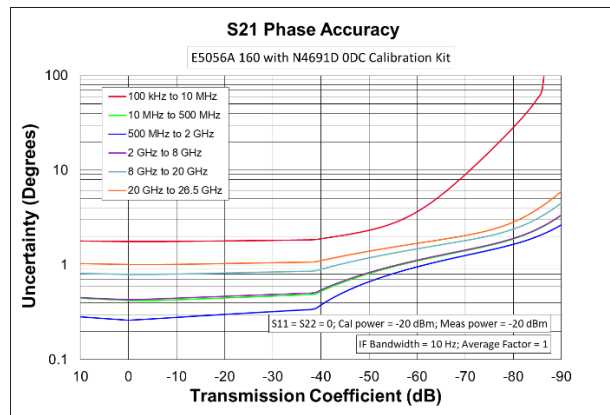
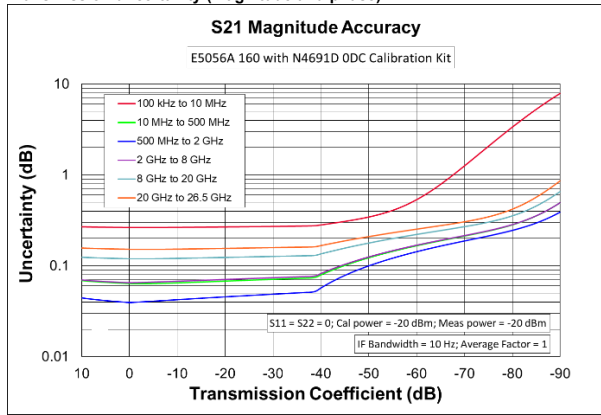

Table 33. E5056A Option 160/161/260/261 with N4691D Electronic Calibration (ECal) module with Option ODC

Corrected error terms (dB) – Specifications

Description	100 kHz to 10 MHz	10 MHz to 500 MHz	500 MHz to 2 GHz	2 GHz to 8 GHz	8 GHz to 20 GHz	20 GHz to 26.5 GHz
Directivity	46	46	47	46	43	41
Source match	41	41	47	45	42	40
Load match	34	42	44	41	37	36
Reflection tracking	± 0.05	± 0.05	± 0.02	± 0.03	± 0.04	± 0.05
Transmission tracking	± 0.246	± 0.045	± 0.028	± 0.051	± 0.101	± 0.127

Transmission uncertainty (magnitude and phase)



Reflection uncertainty (magnitude and phase)

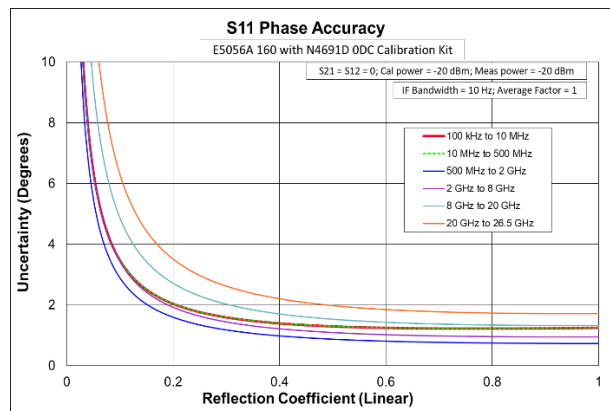
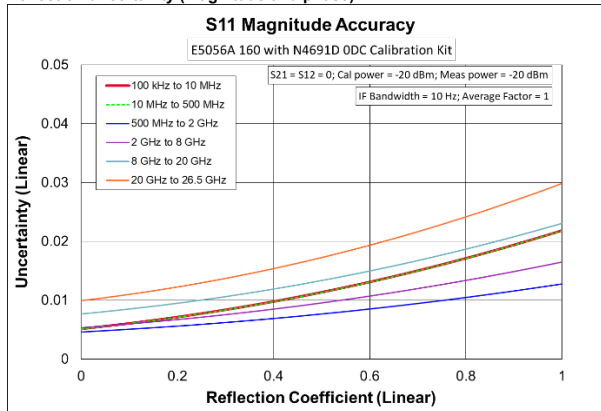
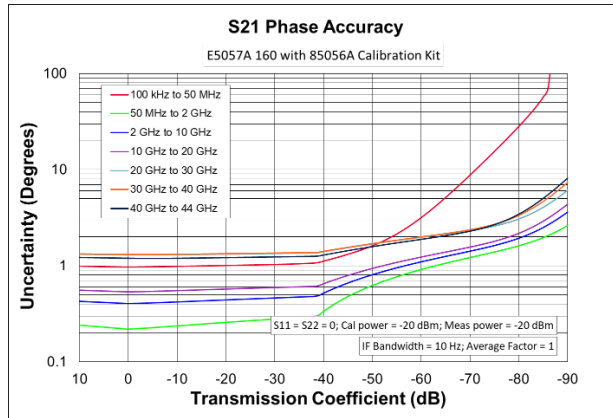
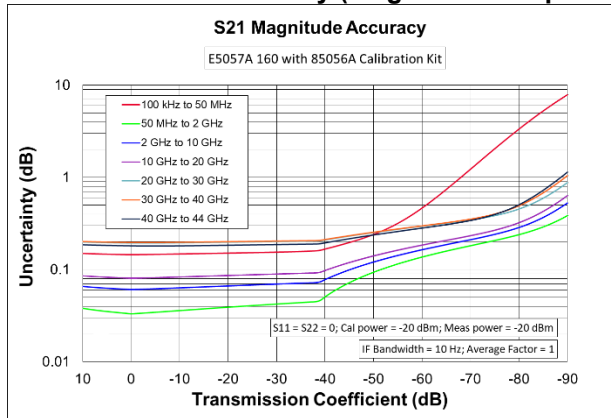

Table 34. E5057A Option 160/161/260/261 with 85056A standard mechanical calibration kit

Corrected error terms (dB) – Specifications

Description	100 kHz to 50 MHz	50 MHz to 2 GHz	2 GHz to 10 GHz	10 GHz to 20 GHz	20 MHz to 30 GHz	30 GHz to 40 GHz	40 GHz to 44 GHz
Directivity	42	42	42	42	38	38	36
Source match	41	41	38	38	33	33	31
Load match	42	42	42	42	37	37	35
Reflection tracking	± 0.001	± 0.001	± 0.008	± 0.008	± 0.02	± 0.02	± 0.027
Transmission tracking	± 0.128	± 0.02	± 0.045	± 0.065	± 0.175	± 0.175	± 0.155

Transmission uncertainty (magnitude and phase)



Reflection uncertainty (magnitude and phase)

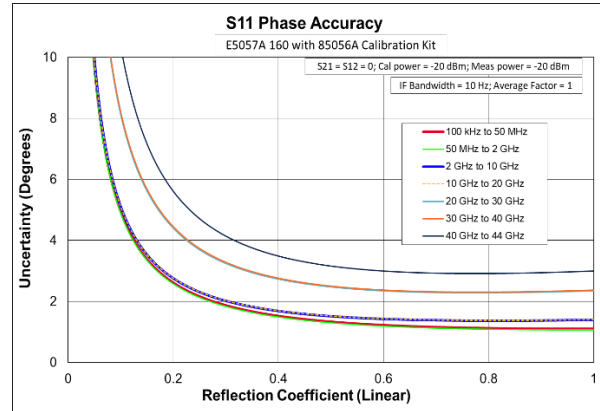
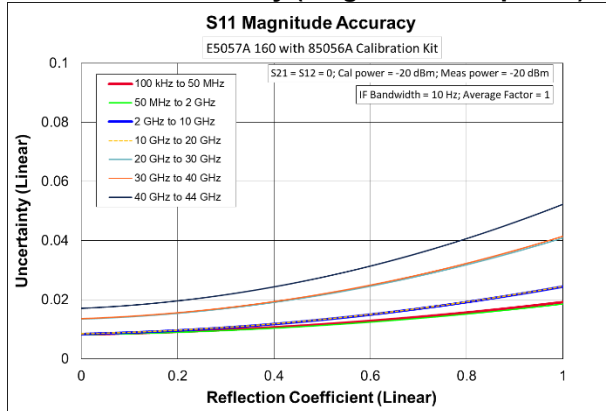
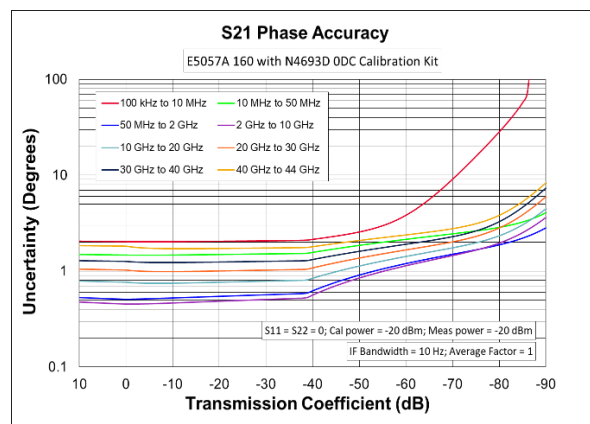
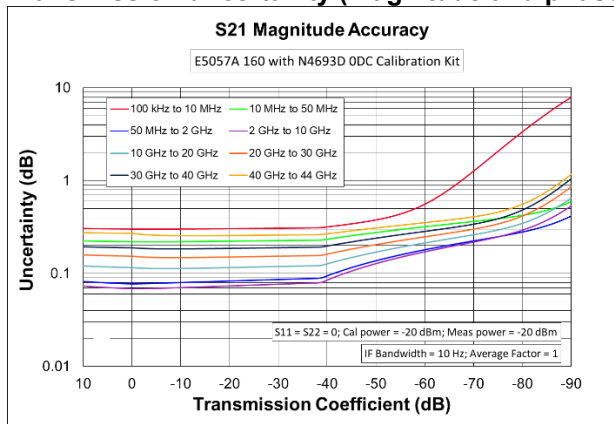

Table 35. E5057A Option 160/161/260/261 with N4693D Electronic Calibration (ECal) module with Option ODC

Corrected error terms (dB) – Specifications

Description	100 kHz to 10 MHz	10 MHz to 50 MHz	50 MHz to 2 GHz	2 GHz to 10 GHz	10 GHz to 20 GHz	20 GHz to 30 GHz	30 GHz to 40 GHz	40 GHz to 44 GHz
Directivity	40	40	40	47	44	38	38	34
Source match	38	38	44	42	37	35	35	32
Load match	32	33	37	42	39	34	33	30
Reflection tracking	± 0.05	± 0.05	± 0.05	± 0.04	± 0.05	± 0.06	± 0.06	± 0.08
Transmission tracking	± 0.282	± 0.201	± 0.064	± 0.052	± 0.094	± 0.126	± 0.162	± 0.229

Transmission uncertainty (magnitude and phase)



Reflection uncertainty (magnitude and phase)

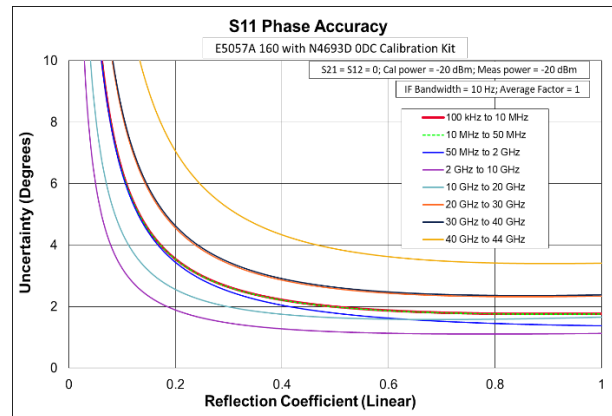
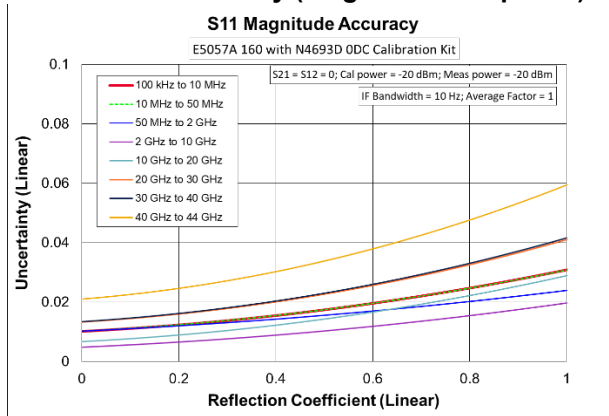
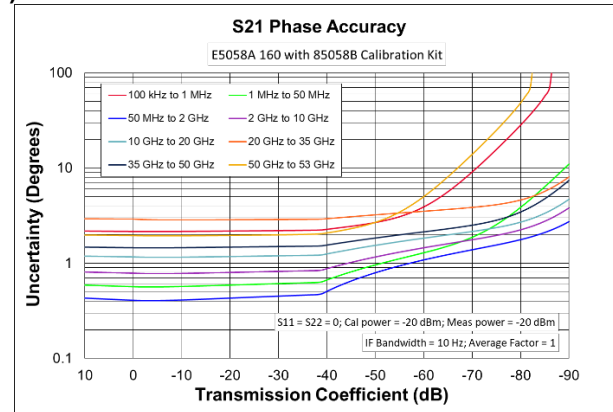
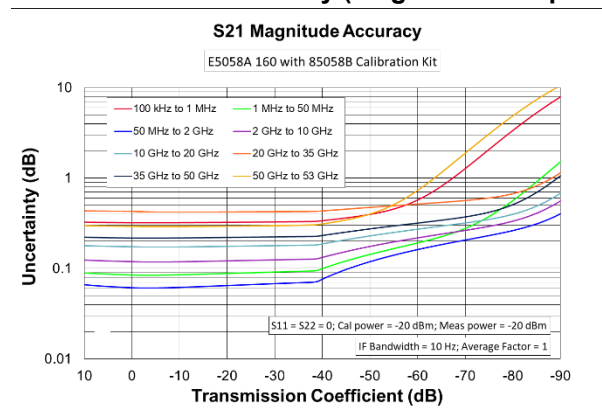

Table 36. E5058A Option 160/161/260/261 with 85058B standard mechanical calibration kit

Corrected error terms (dB) – Specifications

Description	100 kHz to 1 MHz	1 MHz to 50 MHz	50 MHz to 2 GHz	2 GHz to 10 GHz	10 GHz to 20 GHz	20 MHz to 35 GHz	35 GHz to 50 GHz	50 GHz to 53 GHz
Directivity	35	35	35	35	35	30	33	31
Source match	34	34	34	31	30	26	36	33
Load match	34	35	35	35	34	29	32	30
Reflection tracking	± 0.02	± 0.02	± 0.02	± 0.017	± 0.033	± 0.035	± 0.035	± 0.04
Transmission tracking	± 0.302	± 0.065	± 0.046	± 0.1	± 0.155	± 0.401	± 0.196	± 0.256

Transmission uncertainty (magnitude and phase)



Reflection uncertainty (magnitude and phase)

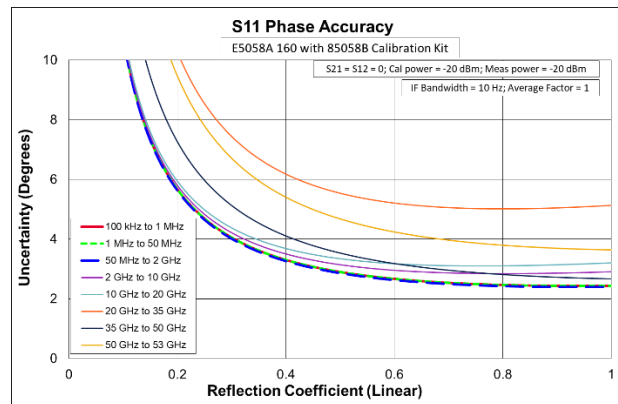
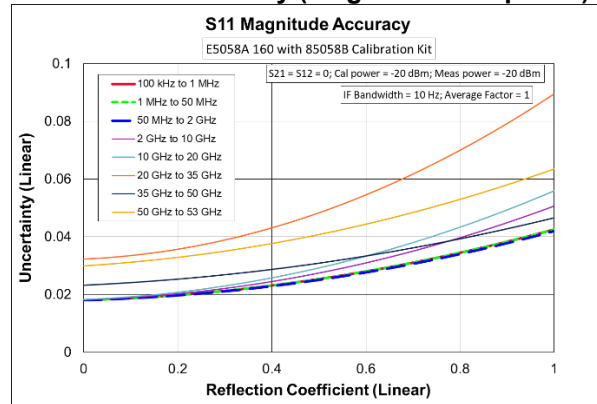
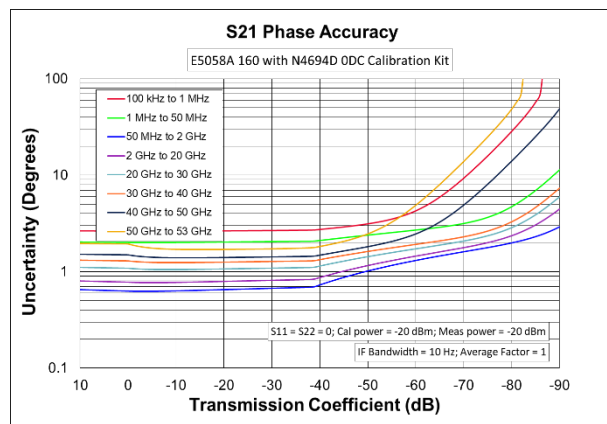
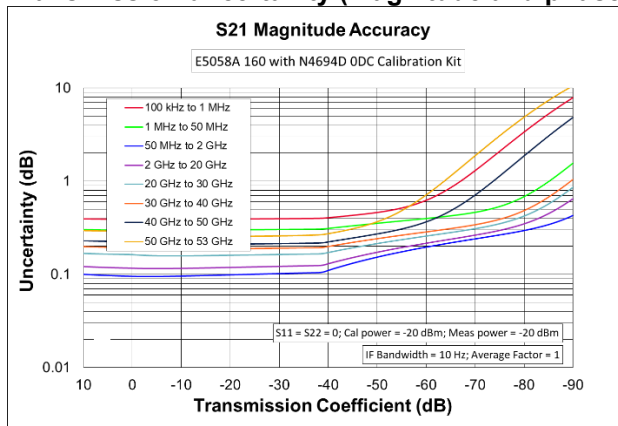

Table 37. E5058A Option 160/161/260/261 with N4694D Electronic Calibration (ECal) module with Option ODC

Corrected error terms (dB) – Specifications

Description	100 kHz to 1 MHz	1 MHz to 50 MHz	50 MHz to 2 GHz	2 GHz to 20 GHz	20 GHz to 30 GHz	30 MHz to 40 GHz	40 GHz to 50 GHz	50 GHz to 53 GHz
Directivity	41	41	41	42	41	40	38	35
Source match	38	38	38	39	35	34	33	30
Load match	30	32	37	37	34	33	32	30
Reflection tracking	± 0.08	± 0.08	± 0.04	± 0.04	± 0.05	± 0.06	± 0.08	± 0.08
Transmission tracking	± 0.369	± 0.279	± 0.08	± 0.098	± 0.137	± 0.163	± 0.182	± 0.217

Transmission uncertainty (magnitude and phase)



Reflection uncertainty (magnitude and phase)

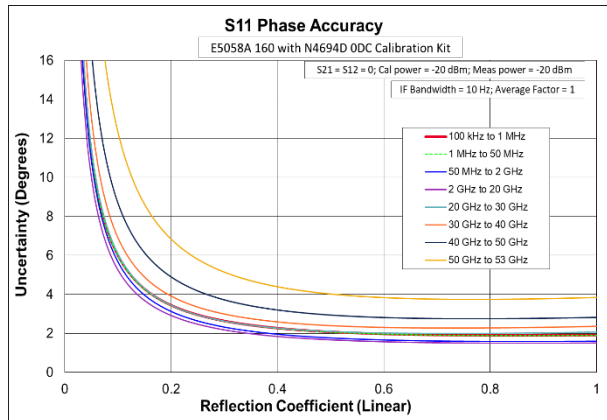
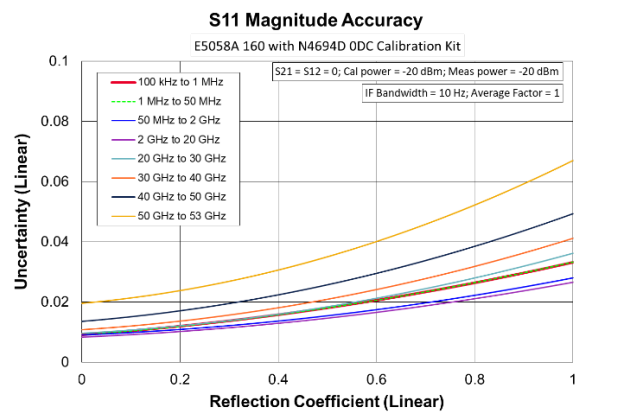

Uncorrected System Performance

Table 38. Uncorrelated error terms (dB)¹ – Specification

E5055A option 160/161/260/261

Description	Directivity	Source match	Load match	Transmission tracking	Reflection tracking	Crosstalk
300 kHz to 10 MHz	20	20	15	--	--	--
10 MHz to 1.5 GHz	25	25	17	--	--	--
1.5 GHz to 3 GHz	25	25	16	--	--	--
3 GHz to 6 GHz	25	25	11	--	--	--
6 GHz to 9 GHz	20	20	11	--	--	--

E5056A/57A/58A option 160/161/260/261

Description	Directivity	Source match	Load match	Transmission tracking	Reflection tracking	Crosstalk
300 kHz to 1 MHz	20	20	1	--	--	--
1 MHz to 3 MHz	20	20	14	--	--	--
3 MHz to 10 MHz	20	20	17	--	--	--
10 MHz to 4 GHz	25	25	17	--	--	--
4 GHz to 6 GHz	25	25	12	--	--	--
6 GHz to 10 GHz	20	20	12	--	--	--
10 GHz to 20 GHz	15	15	9	--	--	--
20 GHz to 27 GHz	15	15	8	--	--	--
27 GHz to 40 GHz	15	15	5	--	--	--
40 GHz to 50 GHz	15	15	8	--	--	--
50 GHz to 53 GHz	10	10	5	--	--	--

1. Specifications apply to following conditions: Factory correction is turned on. Cable loss not included in transmission tracking.

Table 39. Uncorrelated error terms (dB) – Typical
E5055A option 160/161/260/261

Description	Directivity	Source match	Load match	Transmission tracking	Reflection tracking	Crosstalk
9 kHz to 30 kHz	40	40	5	± 0.5	± 0.5	-110
30 kHz to 100 kHz	40	40	10	± 0.5	± 0.5	-110
100 kHz to 300 kHz	40	40	18	± 0.2	± 0.2	-120
300 kHz to 3 MHz	40	40	23	± 0.2	± 0.2	-120
3 MHz to 10 MHz	40	40	23	± 0.2	± 0.2	-139
10 MHz to 50 MHz	40	40	23	± 0.2	± 0.2	-147 ¹
50 MHz to 1.5 GHz	40	40	23	± 0.2	± 0.2	-150
1.5 GHz to 3 GHz	40	40	20	± 0.2	± 0.2	-150
3 GHz to 4.5 GHz	40	40	15	± 0.2	± 0.2	-149
4.5 GHz to 6 GHz	40	40	15	± 0.2	± 0.2	-147
6 GHz to 9 GHz	35	35	15	± 0.3	± 0.3	-146

1. It may typically be degraded at 25 MHz.

E5056A/57A/58A option 160/161/260/261

Description	Directivity	Source match	Load match	Transmission tracking	Reflection tracking	Crosstalk
100 kHz to 300 kHz	40	40	2	± 0.5	± 0.5	-106
300 kHz to 500 kHz	40	40	2	± 0.5	± 0.5	-120
500 kHz to 1 MHz	40	40	2	± 0.5	± 0.5	-130
1 MHz to 3 MHz	40	40	16	± 0.5	± 0.5	-130
3 MHz to 10 MHz	40	40	20	± 0.5	± 0.5	-138
10 MHz to 50 MHz	40	40	20	± 0.2	± 0.2	-147 ¹
50 MHz to 4 GHz	40	40	20	± 0.2	± 0.2	-150
4 GHz to 6 GHz	40	40	15	± 0.2	± 0.2	-150
6 GHz to 8 GHz	35	35	15	± 0.2	± 0.2	-150
8 GHz to 10 GHz	35	35	15	± 0.2	± 0.2	-147
10 GHz to 16 GHz	35	35	11	± 0.3	± 0.3	-147
16 GHz to 20 GHz	35	35	11	± 0.3	± 0.3	-143
20 GHz to 24 GHz	25	25	10	± 0.3	± 0.3	-143
24 GHz to 26 GHz	25	25	10	± 0.3	± 0.3	-141
26 GHz to 27 GHz	25	25	10	± 0.3	± 0.3	-137
27 GHz to 35 GHz	25	25	7	± 0.3	± 0.3	-137
35 GHz to 40 GHz	25	25	7	± 0.3	± 0.3	-134
40 GHz to 45 GHz	20	20	11	± 0.5	± 0.5	-132
45 GHz to 50 GHz	20	20	11	± 0.5	± 0.5	-115
50 GHz to 53 GHz	15	15	8	± 1	± 1	-101

1. It may typically be degraded at 25 MHz.

Test Port Output ¹

Table 40. Frequency resolution, accuracy, stability

Description	Specification	Typical
Number of sources	1	--
Frequency range	9 kHz to 9 GHz (E5055A) 100k to 26.5 GHz (E5056A) 100k to 44 GHz (E5057A) 100k to 53 GHz (settable 54 GHz) (E5058A)	
Frequency resolution	1 Hz	--
Frequency accuracy	± 0.45 ppm	--
Frequency stability	--	± 10 ppm ¹

1. 0 to 40 °C. Assumes no variation in time.

Table 41. Power Setting

Description	Specification	Typical
Maximum power setting (dBm)	--	+20 dBm
Minimum power setting (dBm)	--	-100 dBm
Power level resolution (dB)	--	0.01 dB
Power range, Power Sweep Range	--	(E5055A) -60 dBm to Pmax_typ (E5055A) (E5056A/57A/58A) -60 dBm to Pmax_typ @100 kHz to 20 GHz -50 dBm to Pmax_typ @20 GHz to 53 GHz
Preset power	0 dBm (E5055A) -15 dBm (E5056A/57A/58A)	--

Table 42. Maximum output port power - Pmax (dBm)

E5055A option 160/161/260/261

Description	Specification	Typical
9 kHz to 100 kHz	0	2
100 kHz to 10 MHz	5	7
10 MHz to 4.5 GHz	10	13
4.5 GHz to 6.5 GHz	10	12
6.5 GHz to 9 GHz	9	12

E5056A/57A/58A option 160/161/260/261

Description	Specification	Typical
100 kHz to 300 kHz	-2	1
300 kHz to 1 MHz	7	10
1 MHz to 17 GHz	10	13
17 GHz to 20 GHz	6	10
20 GHz to 24 GHz	4	10
24 GHz to 30 GHz	4	7
30 GHz to 38 GHz	1	7
38 GHz to 45 GHz	1	4
45 GHz to 50 GHz	-7	-2
50 GHz to 53 GHz	-25	-14

Table 43. Power level accuracy (dB)E5055A option 160/161/260/261 ^{1,2}

Description	Specification	Typical
9 kHz to 100 kHz	± 4.0	± 1.0
100 kHz to 9 GHz	± 1.5	± 0.2

E5056A/57A/58A option 160/161/260/261 ³

Description	Specification	Typical
100 kHz to 10 MHz	± 3.0	± 0.5
10 MHz to 15 GHz	± 1.5	± 0.2
15 GHz to 30 GHz	± 2.0	± 0.2
30 GHz to 40 GHz	± 2.5	± 0.3
40 GHz to 50 GHz ⁴	± 2.5	± 0.5
50 GHz to 53 GHz ⁴	--	± 1.0

1. At nominal power of 0 dBm, stepped sweep mode.

2. At nominal power of -1 dBm, stepped sweep mode with option 120 or 140 for 9 kHz to 100 kHz.

3. At nominal power of -15 dBm, stepped sweep mode.

4. If using a power sensor (wideband power detector) to measure or calibrate the power level above 45 GHz, an external filter is required to reduce sub-harmonics. Refer to SSA-X Helpfile for more details.

Table 44. Power level linearity (dB)E5055A option 160/161/260/261 ^{1, 2}

Description	Specification ³	Typical ^{4, 5}
9 kHz to 9 GHz	± 0.75	± 1.0

1. Level linearity given is relative to 0 dBm.

2. Level linearity given is relative to -1 dBm with option 120 or 140 for 9 kHz to 100 kHz.

3. Stepped sweep mode. -20 dBm ≤ P ≤ maximum specified power.

4. Swept sweep mode. -60 dBm ≤ P ≤ maximum specified power.

5. Stepped sweep mode. -60 dBm ≤ P < -20 dBm.

E5056A/57A/58A option 160/161/260/261 ⁶

Description	Specification ⁷	Typical
100 kHz to 10 GHz	± 0.75	± 1.0 ^{8, 9}
10 GHz to 20 GHz	± 1.0	± 1.0 ^{8, 9}
20 GHz to 50 GHz	± 2.0	± 1.0 ^{10, 11}

6. Level linearity given is relative to -15 dBm.

7. Stepped sweep mode. -20 dBm ≤ P ≤ maximum specified power.

8. Swept sweep mode. -60 dBm ≤ P ≤ maximum specified power.

9. Stepped sweep mode. -60 dBm ≤ P < -20 dBm.

10. Swept sweep mode. -65 dBm ≤ P ≤ maximum specified power.

11. Stepped sweep mode. -50 dBm ≤ P < -20 dBm.

Table 45. 2nd and 3rd harmonics (dBc)E5055A option 160/161/260/261 ¹

Description	Specification	Typical
30 kHz to 10 MHz	--	-20
10 MHz to 9 GHz	--	-25

E5056A/57A/58A option 160/161/260/261 ^{1, 2}

Description	Specification	Typical
300 kHz to 1 MHz	--	-20
1 MHz to 20 GHz	--	-25
20 GHz to 25 GHz	--	-17
25 GHz to 40 GHz	--	-20
40 GHz to 47 GHz	--	-15
47 GHz to 53 GHz	--	-17

1. Listed frequency is harmonic frequency. Tested at power of 0 dBm.

2. Listed frequency is harmonic frequency. Tested at power of -2 dBm at 100 kHz to 200 kHz.

Table 46. Sub-harmonics (dBc)E5055A option 160/161/260/261 ¹

Description	Specification	Typical
9 kHz to 9 GHz	--	-50

E5056A/57A/58A option 160/161/260/261 ²

Description	Specification	Typical
100 kHz to 10 GHz	--	-50
10 GHz to 20 GHz	--	-35
20 GHz to 40 GHz	--	-30
40 GHz to 47 GHz	--	-20
47 GHz to 50 GHz	--	-10
50 GHz to 53 GHz	--	-2

1. Listed frequency is fundamental frequency. Tested at power of 0 dBm.
 2. Listed frequency is fundamental frequency. Tested at power of -15 dBm.

Table 47. Non-harmonic spurs at nominal power (dBc) ¹

E5055A option 160/161/260/261

Description	Specification	Typical
9 kHz to 9 GHz	--	-50

E5056A/57A/58A option 160/161/260/261

Description	Specification	Typical
100 kHz to 10 GHz	--	-50
10 GHz to 20 GHz	--	-45
20 GHz to 53 GHz	--	-35

1. Listed frequency is fundamental frequency. Includes spurious related to LO signal and frac-N.

Test Port Input

Table 48. Test port noise floor (dBm) ¹

E5055A option 160/161/260/261

Description	Specification	Typical
9 kHz to 100 kHz	-101	-109
100 kHz to 300 kHz	-112	-119
300 kHz to 1 MHz	-120	-127
1 MHz to 10 MHz	-125	-132
10 MHz to 50 MHz ²	-127	-134
50 MHz to 3 GHz	-130	-137
3 GHz to 4.5 GHz	-130	-136
4.5 GHz to 6.5 GHz	-130	-135
6.5 GHz to 9 GHz	-127	-134

E5056A/57A/58A option 160/161/260/261

Description	Specification	Typical
100 kHz to 300 kHz	-97	-105
300 kHz to 500 kHz	-97	-110
500 kHz to 1 MHz	-110	-120
1 MHz to 10 MHz	-115	-124
10 MHz to 50 MHz ²	-127	-133
50 MHz to 200 MHz	-130	-133
200 MHz to 3 GHz	-130	-137
3 GHz to 6.5 GHz	-130	-135
6.5 GHz to 9 GHz	-126	-133
9 GHz to 17 GHz	-126	-132
17 GHz to 25 GHz	-124	-130
25 GHz to 30 GHz	-121	-128
30 GHz to 40 GHz	-119	-126
40 GHz to 45 GHz	-118	-125
45 GHz to 50 GHz	-103	-113
50 GHz to 53 GHz	-93	-111

1. Noise floor in a 10 Hz IF Bandwidth. Measured with 1 kHz IF bandwidth for 9 kHz to < 100 kHz, and 30 kHz IF bandwidth for 100 kHz to 53 GHz. Test port terminated.

2. It may typically be degraded at 25 MHz.

Table 49. Receiver compression at test port ¹

E5055A option 160/161/260/261

Description	Input power at test port (dBm)	Specification		Typical	
		Magnitude (dB)	Phase (°)	Magnitude (dB)	Phase (°)
9 kHz to 100 kHz	0	0.5	5	0.10	1.5
100 kHz to 10 MHz	+5	0.2	5	0.05	1.0
10 MHz to 6.5 GHz	+10	0.2	5	0.05	1.0
6.5 GHz to 9 GHz	+9	0.2	5	0.05	1.0

E5056A/57A/58A option 160/161/260/261

Description	Input power at test port (dBm)	Specification		Typical	
		Magnitude (dB)	Phase (°)	Magnitude (dB)	Phase (°)
100 kHz to 300 kHz	-2	0.2	5	0.10	1.0
300 kHz to 1 MHz	+7	0.2	5	0.10	1.0
1 MHz to 17 GHz	+10	0.2	5	0.05	1.0
17 GHz to 20 GHz	+6	0.2	5	0.05	1.0
20 GHz to 30 GHz	+4	0.2	5	0.05	1.0
30 GHz to 45 GHz	+1	0.2	5	0.05	1.0
45 GHz to 50 GHz	-7	0.2	5	0.05	1.0
50 GHz to 53 GHz	-25	0.2	5	0.05	1.0

1. Tested with receiver gain AUTO. (High receiver attenuator is selected for measurements).

Table 50. Trace noise magnitude (dB rms) ^{1, 2}

E5055A option 160/161/260/261

Description	Specification	Typical
9 kHz to 30 kHz	0.005	0.0025
30 kHz to 100 kHz	0.003	0.001
100 kHz to 6 GHz ³	0.0015	0.0005
6 GHz to 9 GHz	0.002	0.0006

E5056A/57A/58A option 160/161/260/261

Description	Specification	Typical
100 kHz to 300 kHz	0.005	0.002
300 kHz to 1 MHz	0.003	0.001
1 MHz to 4.5 GHz ³	0.0015	0.0005
4.5 GHz to 10 GHz	0.0015	0.0007
10 GHz to 17 GHz	0.002	0.001
17 GHz to 30 GHz	0.003	0.0013
30 GHz to 45 GHz	0.006	0.0022
45 GHz to 50 GHz	0.018	0.006

1. Transmission and reflection trace noise in a 1 kHz IF bandwidth for < 10 MHz, 10 kHz IF bandwidth ≥ 10 MHz.

2. At maximum specified power.

3. It may typically be degraded at particular frequencies such as 25 MHz, 54 MHz, 58.5 MHz, 108 MHz, 120 MHz, 132 MHz, or 156 MHz.

Table 51. Trace noise phase (degree rms) ^{1, 2}

E5055A option 160/161/260/261

Description	Specification	Typical
9 kHz to 30 kHz	0.07	0.025
30 kHz to 100 kHz	0.05	0.017
100 kHz to 300 kHz	0.035	0.006
300 kHz to 6 GHz ³	0.01	0.003
6 GHz to 9 GHz	0.02	0.006

E5056A/57A/58A option 160/161/260/261

Description	Specification	Typical
100 kHz to 300 kHz	0.07	0.015
300 kHz to 1 MHz	0.03	0.01
1 MHz to 6 GHz ³	0.02	0.003
6 GHz to 10 GHz	0.02	0.004
10 GHz to 17 GHz	0.02	0.006
17 GHz to 30 GHz	0.02	0.01
30 GHz to 45 GHz	0.046	0.027
45 GHz to 50 GHz	0.18	0.03

1. Transmission and reflection trace noise in a 1 kHz IF bandwidth for < 10 MHz, 10 kHz IF bandwidth ≥ 10 MHz.

2. At maximum specified power.

3. It may typically be degraded at particular frequencies such as 25 MHz, 54 MHz, 58.5 MHz, 108 MHz, 120 MHz, 132 MHz, or 156 MHz.

Table 52. Temperature stability – Typical

E5055A option 160/161/260/261

Description	Magnitude (dB/°C)	Phase (degree/°C)
9 kHz to 300 kHz	0.03	0.2
300 kHz to 4.5 GHz	0.005	0.1
4.5 GHz to 6 GHz	0.01	0.1
6 GHz to 6.5 GHz	0.01	0.2
6.5 GHz to 9 GHz	0.015	0.2

E5056A/57A/58A option 160/161/260/261

Description	Magnitude (dB/°C)	Phase (degree/°C)
100 kHz to 1 MHz	0.03	1.0
1 MHz to 10 MHz	0.005	0.2
10 MHz to 4.5 GHz	0.005	0.1
4.5 GHz to 10 GHz	0.01	0.1
10 GHz to 20 GHz	0.01	0.2
20 GHz to 30 GHz	0.01	0.25
30 GHz to 40 GHz	0.01	0.3
40 GHz to 50 GHz	0.03	0.8
50 GHz to 53 GHz	0.06	1.0

Table 53. Damage input level - Typical

Description	
Damage Input Level	+27 dBm or \pm 35 VDC (Warranted)

Dynamic Accuracy ^{1, 2}

Accuracy of the test port input power relative to the reference input power level. Measured with 10 Hz IF bandwidth.

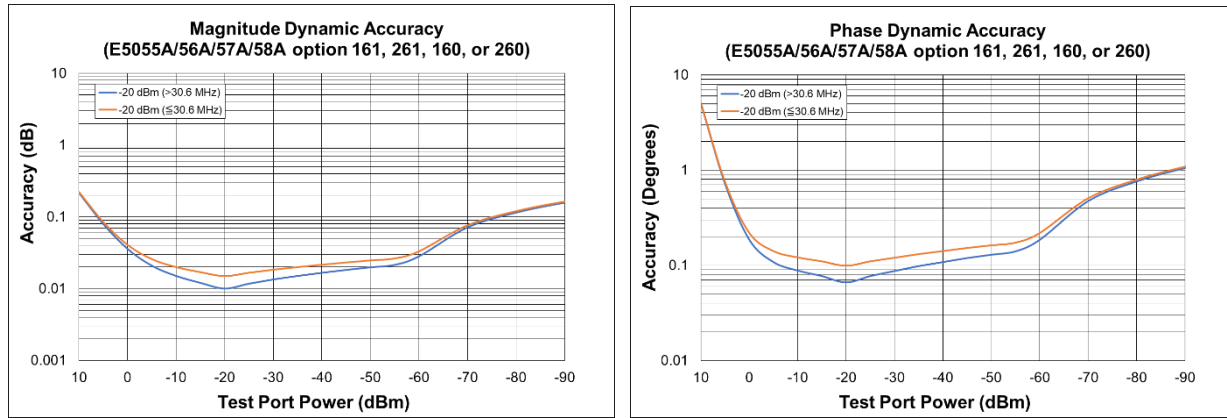

Figure 17. Dynamic Accuracy (Magnitude and Phase)

- Dynamic accuracy is verified with the following measurements:
 - Compression over frequency.
 - IF linearity using a reference level of -20 dBm for an input power range of 0 to -60 dBm. Tested at three single frequencies (30.6 MHz, 49.6 MHz and 99.6 MHz) to cover the whole frequency range. The VNA receiver is linear by design when signal levels are below -60 dBm. For more details, refer to [VNA Receiver Dynamic Accuracy Specifications and Uncertainties](#).
- Download Uncertainty Calculator from http://www.keysight.com/find/na_calculator to generate the curves of dynamic accuracy.

Table 54. Network Analyzer General Information

Description	Specification
System IF bandwidth range	1 Hz to 15 MHz, 1 – 1.5 – 2 – 3 – 4 – 5 – 7 step
Number of points	1 to 100,003
Test Port Connectors	Type N (F), 50 Ω 3.5mm (male), 50 Ω (E5056A) 2.4mm (male), 50 Ω (E5057A) 1.85mm (male), 50 Ω (E5058A)
Impedance	50 Ω (nominal)
Functions on the Rear Panel	Handler I/O, Device Test I/O, Application I/O, Measurement Trigger Delay, AUX Trigger Out, Measurement Trigger In
Available Measurement	S-parameter, wave, Balanced measurement (non true mode)
External Device Support	ECal, Power Meter

Pulsed-RF Measurements

This section provides specifications for the pulse modulation on the E505xA opt.160/161/260/261. The S96325B Software is required to enable pulsed-RF measurement.

Table 55. Pulse modulation On/Off ratio (dB) – Typical
E5055A option 160/161/260/261

Description	Normal mode ¹	Fast mode
9 kHz to 4.5 GHz	80	50
4.5 GHz to 9 GHz	70	40

E5056A/57A/58A option 160/161/260/261

Description	Normal mode ¹	Fast mode
100 kHz to 3 GHz	80	50
3 GHz to 8 GHz	80	40
8 GHz to 20 GHz	80	38
20 GHz to 40 GHz	70	30
40 GHz to 50 GHz	70	25

1. At power of > -20 dBm.

Pulse modulation shape examples

E5055A with S96325B:

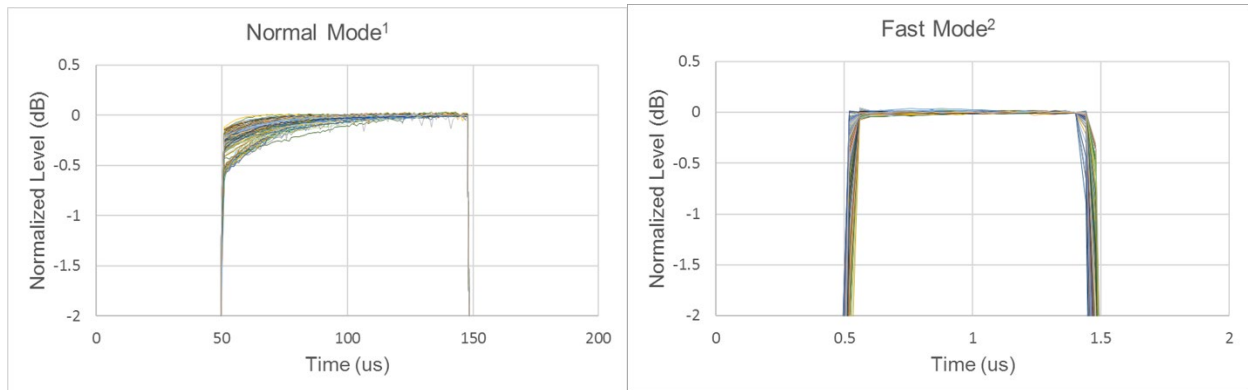

Figure 18. Pulse modulation shape (Normal mode and Fast mode) on E5055A with S96325B

1. Measured with a 500 kHz IF bandwidth, no averaging. With 100 µs pulse width setting.

2. Measured with a 15 MHz IF bandwidth, averaging factor of 16 (Average Type = Point). With 1 µs pulse width setting.

E5056A/57A/58A with S96325B:

1 GHz to 26.5 GHz

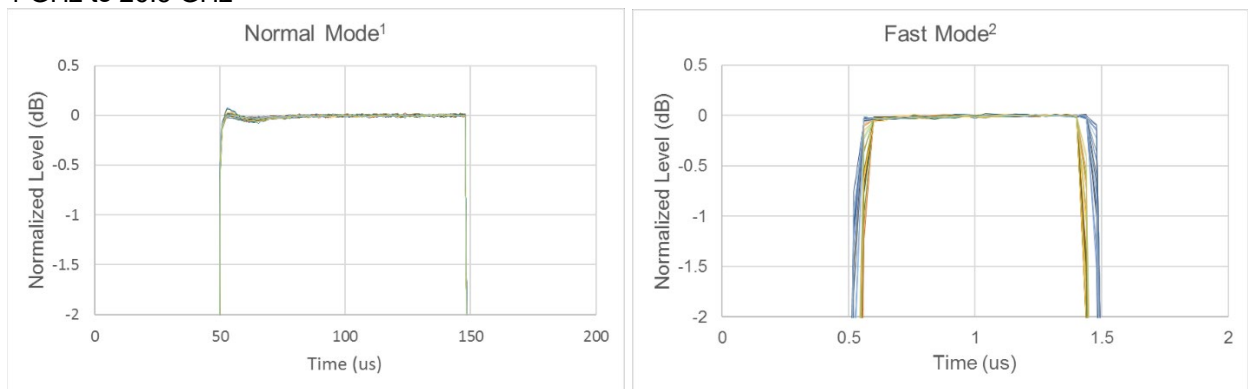

Figure 19. Pulse modulation shape (Normal mode and Fast mode) on E5056A/57A/58A with S96325B, 1 GHz to 26.5 GHz

32 GHz

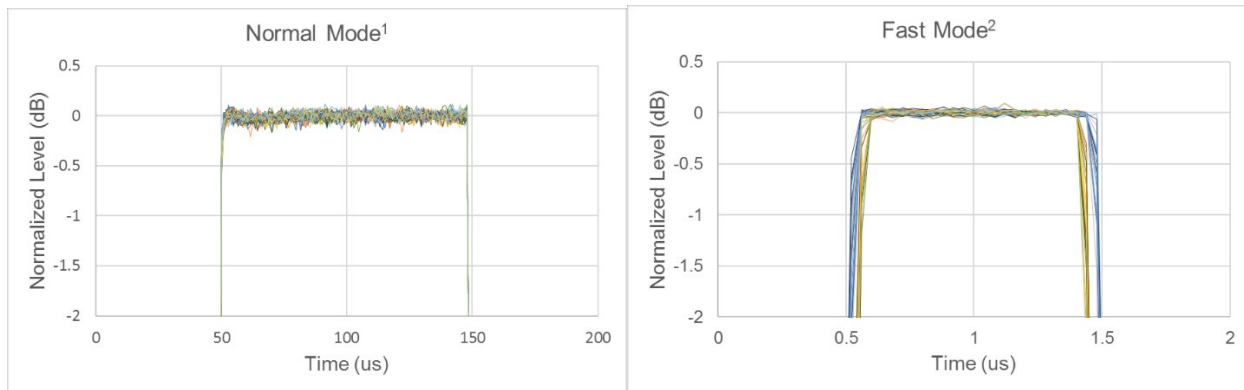

Figure 20. Pulse modulation shape (Normal mode and Fast mode) on E5056A/57A/58A with S96325B, 32 GHz

44 GHz

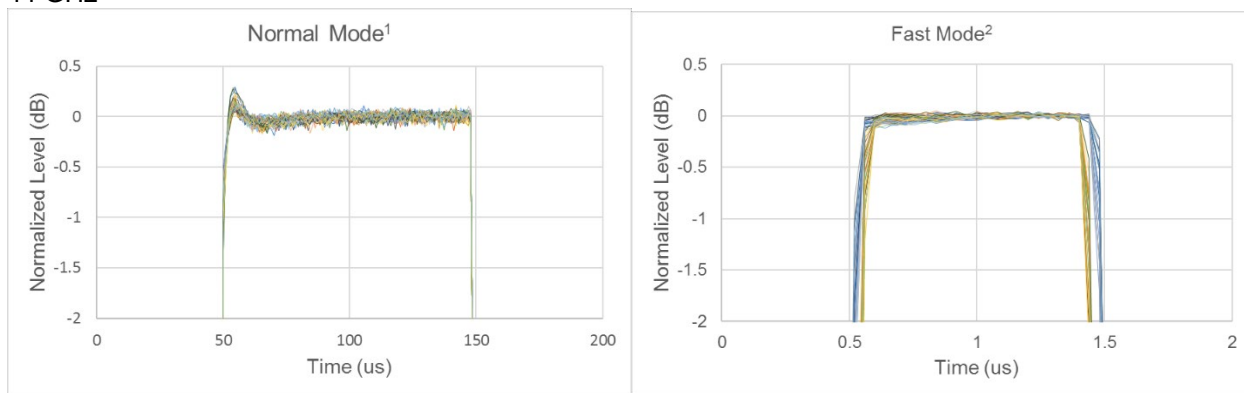

Figure 21. Pulse modulation shape (Normal mode and Fast mode) on E5056A/57A/58A with S96325B, 44 GHz

50 GHz

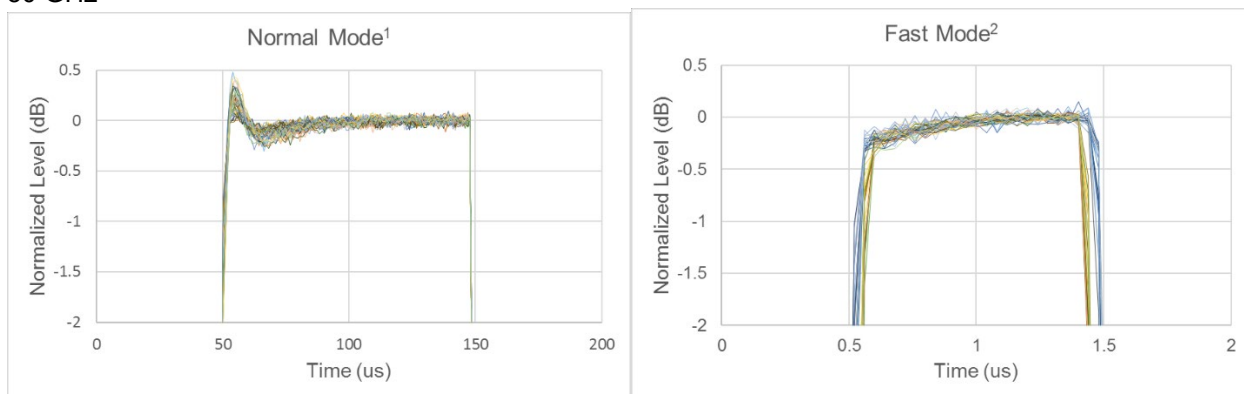

Figure 22. Pulse modulation shape (Normal mode and Fast mode) on E5056A/57A/58A with S96325B, 50 GHz

1. Measured with a 500 kHz IF bandwidth, no averaging. With 100 μ s pulse width setting.
 2. Measured with a 15 MHz IF bandwidth, averaging factor of 16 (Average Type = Point). With 1 μ s pulse width setting.

Table 56. Pulse modulation (source modulators) – Typical

Description	Typical
Minimum pulse width	200 ns
Minimum pulse period	1 μ s
Maximum pulse period	10 s

Internal Timebase

Table 57. Internal timebase (OCXO) performance

Description	Specification
Frequency uncertainty	10 MHz +/-0.45ppm
Frequency stability (typ.)	±10 ppb, Full temperature range (0 °C to +40 °C)
Frequency aging rate (typ.)	±0.5 ppb/day ±0.05 ppm/year (first-year operation) ± 0.03 ppm/year (second year)

General Information

Table 58. Miscellaneous information

Description	Specification
Operating System	Windows 10 (Supports both 32-bit and 64-bit applications)

Table 59. Front panel information

Description	Specification (E5055A)	Specification (E5056A/57A/58A)
RF In		
Connector	Type-N (female), 50 Ω	3.5 mm (male), 50 Ω (E5056A) 2.4 mm (male), 50 Ω (E5057A) 1.85 mm (male), 50 Ω (E5058A)
Number of ports	(Phase noise port) 1 for option 100, 200 2 for option 15x, 16x, 25x, 26x (VNA port) 2 ¹	
VSWR ⁴	1 MHz to 3 GHz: 1.2 3 GHz to 4 GHz: 1.4 4 GHz to 8 GHz: 1.6	1 MHz to 300 MHz: 1.5 300 MHz to 2 GHz: 1.3 2 GHz to 4 GHz: 1.4 4 GHz to 8 GHz: 1.6 8 GHz to 20 GHz: 1.9 20 GHz to 50 GHz: 2.6 50 GHz to 54 GHz: 3.5
Damage input level	+27 dBm or ±35 VDC (warranted)	
Source Out		
Connector	SMA (female)	3.5 mm (female), 50 Ω (E5056A) 2.4 mm (female), 50 Ω (E5057A) 1.85 mm (female), 50 Ω (E5058A)
LO Out ²		
Connector	Not available	SMA (female), 50 Ω (E5056A/57A/58A)
IF In ²		
Connector	Not available	SMA (female), 50 Ω (E5056A/57A/58A)
Baseband In		
Connector	BNC (female), 50 Ω, AC coupled	
Impedance	50 Ω (nominal)	
Damage input level	+23 dBm or ±35 VDC (warranted)	
DC Control	BNC (female)	
DC Supply 1 and 2	BNC (female)	
USB	4 ports (USB 2.0), Type-A female	
Ground terminal	2	
Display ³	31 cm (12.1 inch) diagonal color active matrix LCD with multi-touch screen, 1280 (horizontal) x 800 (vertical) resolution	

1. with Option 160, 161, 260, or 261

2. LO Out and IF In connectors are for opt.401/404, and not supported on E5055A.

3. Valid pixels are 99.99% and more. Below 0.02% of fixed points of black, blue, green or red are not regarded as failure.

4. RF1 Input and RF 2 Input ports only. VSWR is specified at measurement carrier frequency. VSWR changes depending on the internal path setting of the instrument.

Table 60. Side panel information

Description	Specification
Display Output	DisplayPort and VGA (supports up to two simultaneous displays)
GPIB	24-pin D-Sub (Type D-24), female; compatible with IEEE-488
USB Ports	Four SuperSpeed USB ports, one USB device port ¹ .
LAN	Two Gigabit Ethernet, RJ-45 LAN ports.

1. USB Test and Measurement Class (TMC) interface that communicates over USB, complying with the IEEE 488.1 and IEEE 488.2 standards.

Table 61. Rear panel information









Description	Specification (E5055A)	Specification (E5056A/57A/58A)
External Trigger Input		
Connector	BNC female	
Input level	Low threshold voltage: 0.5 V, High threshold voltage: 2.1 V Input level range: 0 to +5 V	
Pulse width	≥ 2 µsec	
Polarity	Positive or negative	
External Trigger Output / Measurement Trig Ready Output		
Connector	BNC female	
Maximum output current	50 mA	
Output level	Low level voltage: 0 V, High level voltage: 5 V	
Pulse width	1 µsec (External Trigger Output only)	
Polarity	Positive or negative	
External Reference Input		
Connector	BNC female	
Input frequency	10 MHz to 200 MHz	
Frequency lock range	± 1 ppm	
Input level	-3 to +10 dBm	
Input impedance	50 Ω (nominal)	
Internal Reference Output		
Connector	BNC female	
Output frequency	10 MHz or 100 MHz	
Frequency uncertainty	See table 18 (Internal time base)	
Output level	0 dBm ± 3 dB into 50 Ω (typ.)	
Output impedance	50 Ω (nominal)	
Application I/O		
Connector	15-pin D-sub connector (female), Provides access to pulse modulators and generators	
Device Test I/O		
Connector	25-pin D-sub connector (female), Provides serial and parallel digital signals for controlling device under test. Two independent 8-bit I/O	
Handler I/O Port		
Connector	36-pin Centronics, female; provides connection to handler system	
Line Power		
Voltage	100 to 240 VAC	
Frequency	50/60 Hz	
Maximum power	600 W	
Typical power consumption ¹	243W (E5055A Option 100/200) 343W (E5055A Option 150/151/160/161/250/251/260/261)	314W (E5056A/57A/58A Option 100/200) 392W (E5056A/57A/58A Option 150/151/160/161/250/251/260/261)
1. At preset		

Table 62. Environmental and physical specifications

Description	Specification	
Descriptions	Samples of this product have been type tested in accordance with the Keysight Environmental Test Manual and verified to be robust against the environmental stresses of Storage, Transportation and End-use; those stresses include, but are not limited to, temperature, humidity, shock, vibration, altitude, and power line conditions. Test Methods are aligned with IEC 60068-2 and levels are similar to MIL-PRF-28800F Class 3.	
Temperature	Operating	0 to 40 °C ambient
	Non-operating	-10 to 60 °C
Humidity	Operating	Type tested at 20 to 80%, wet bulb temperature < 29 °C (non-condensing)
	Non-operating	Type tested at 20 to 90 %, wet bulb temperature < 40 °C (non-condensing)
Altitude	Operating	Up to 2,000 meters (6,561 feet)
	Non-operating	Up to 4,572 meters (15,000 feet)
Vibration	Operating	0.21 G maximum, 5 Hz to 500 Hz
	Non-operating	0.5 G maximum, 5 Hz to 500 Hz
Instrument protection	IP 30 IEC/EN 60529	
Instrument calibration cycle	1 year	

EMC, Safety, Environment and Compliance

Table 63. EMC, safety, environment and compliance

EMC ¹	
Complies with the essential requirements of the European EMC Directive as well as current editions of the following standards (dates and editions are cited in the Declaration of Conformity).	
 ISM 1-A	The CE mark is a registered trademark of the European Community (if accompanied by a year, it is the year when the design was proven). This product complies with all relevant directives. <ul style="list-style-type: none"> • IEC 61326-1 • CISPR 11 Group 1, Class A
	UK conformity mark is a UK government owned mark. When affixed to the product is declaring all applicable Directives and Regulations have been met in full.
CAN ICES/NMB-001(A)	This ISM device complies with Canadian ICES-001. Cet appareil ISM est conforme a la norme NMB du Canada.
	The RCM mark is a registered trademark of the Australian Communications and Media Authority. AS/NZS CISPR 11
	South Korean Certification (KC) mark; includes the marking's identifier code: R-R-Kst-xxxxxx South Korean Class A EMC declaration: Information to the user: This equipment has been conformity assessed for use in business environments. In a residential environment this equipment may cause radio interference. ※ This EMC statement applies to the equipment only for use in business environment. 사 용 자 안 내 문 이 기기는 업무용 환경에서 사용할 목적으로 적합성평가를 받은 기기로서 가정용 환경에서 사용하는 경우 전파간섭의 우려가 있습니다. ※ 사용자 안내문은 “업무용 방송통신기자재”에만 적용한다.
Safety ¹	
Complies with the essential requirements of the European Low Voltage Directive as well as current editions of the following standards (dates and editions are cited in the Declaration of Conformity). This product is designed for use in INSTALLATION CATEGORY II and POLLUTION DEGREE 2 and MEASUREMENT CATEGORY NONE per IEC standards. This product is intended for indoor use.	
 ISM 1-A	IEC/EN 61010-1
	The CSA mark is a registered trademark of the CSA International. Canada: CSA C22.2 No. 610610-1 USA: UL std no. 61010-1
Environment	
	The crossed out wheeled bin symbol indicates that separate collection for waste electric and electronic equipment (WEEE) is required, as obligated by DIRECTIVE 2012/19/EU. Please refer to about.keysight.com/en/companyinfo/environment/takeback.shtml to understand your Trade in options with Keysight in addition to product takeback instructions.
Compliance	
	Class C (only applies to units that are shipped with firmware revision A.03.10 or later)

1. To find a current Declaration of Conformity for a specific Keysight product, go to: <http://www.keysight.com/conformity>

Weight and Dimensions

Table 64. Weight

Description	Specification (E5055A)	Specification (E5056A/57A/58A)
Weight	1-port: 24.3 kg 2-port: 27.3 kg	1-port: 26.8 kg 2-port: 28.1 kg

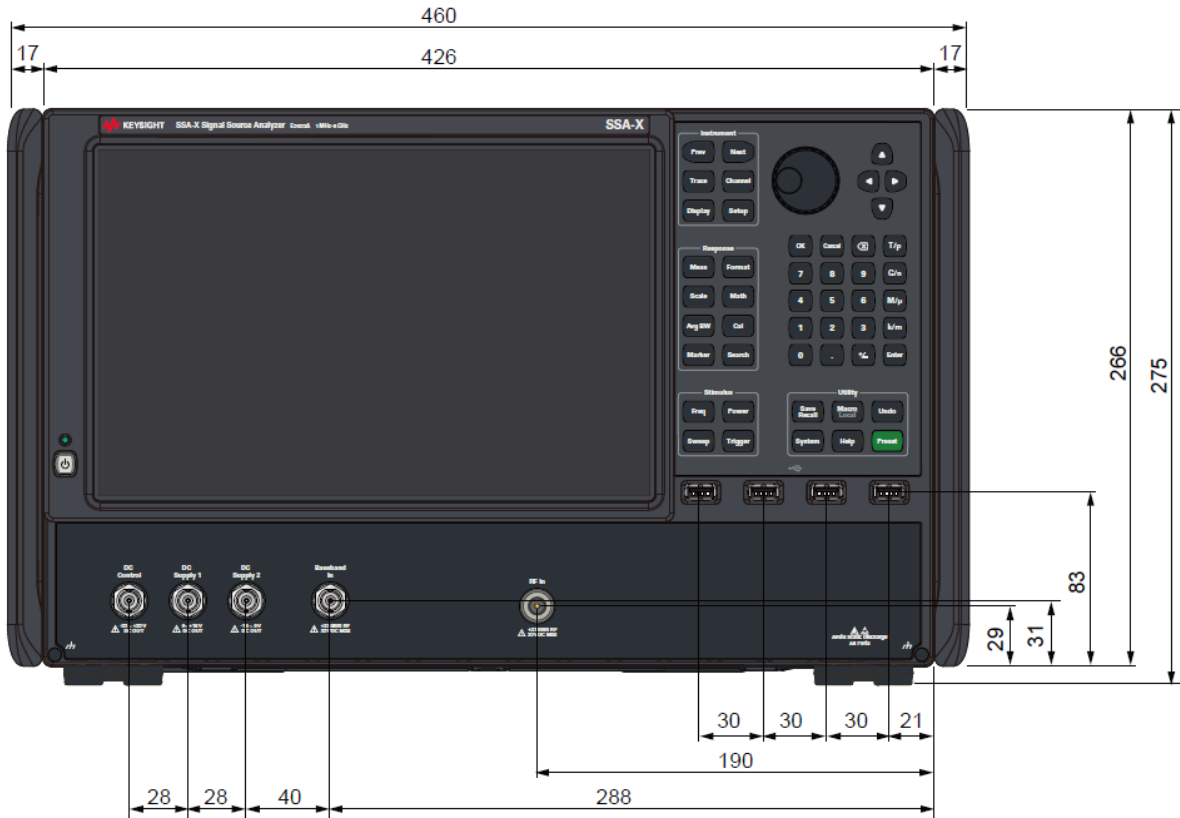

Figure 23. Front view: E505xA Option 100/200 (mm)

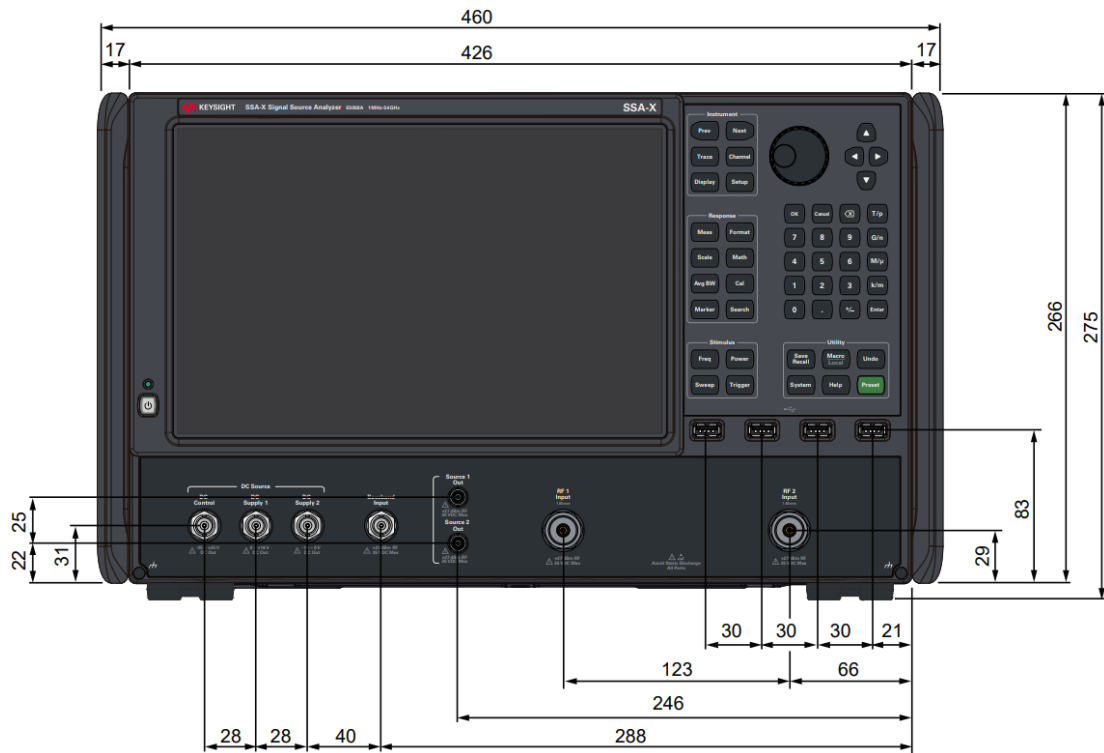

Figure 24. Front view: E505xA Option 15x/25x (mm)

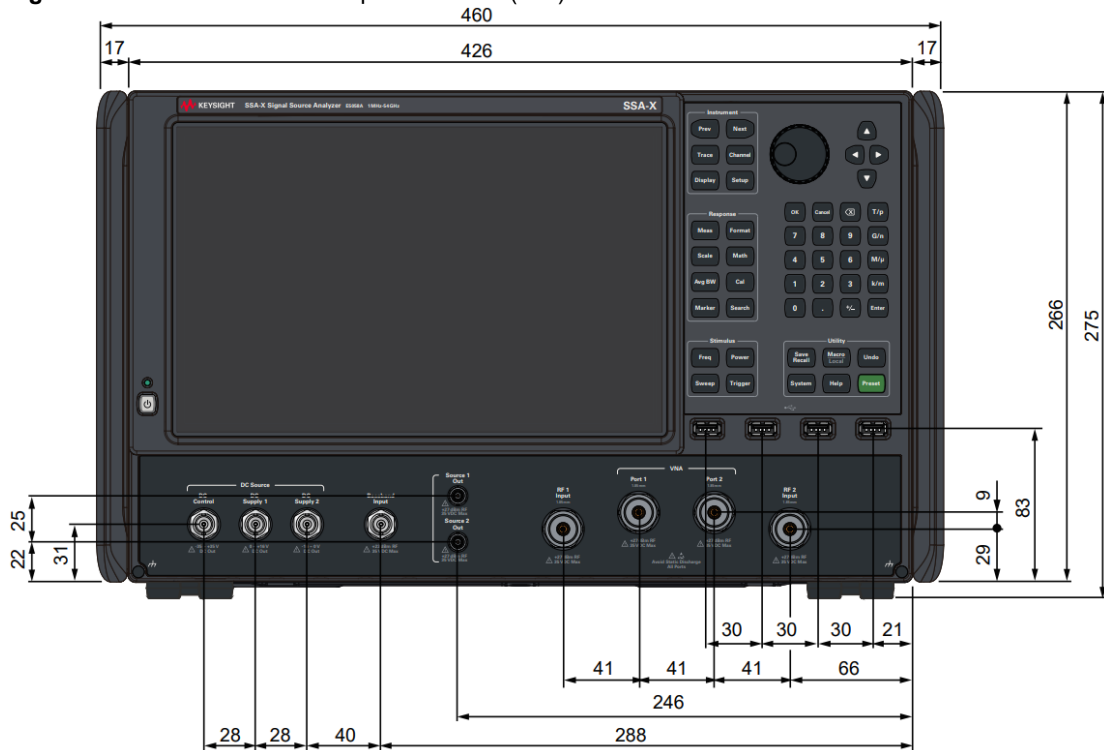

Figure 25. Front view: E505xA Option 16x/26x (mm)

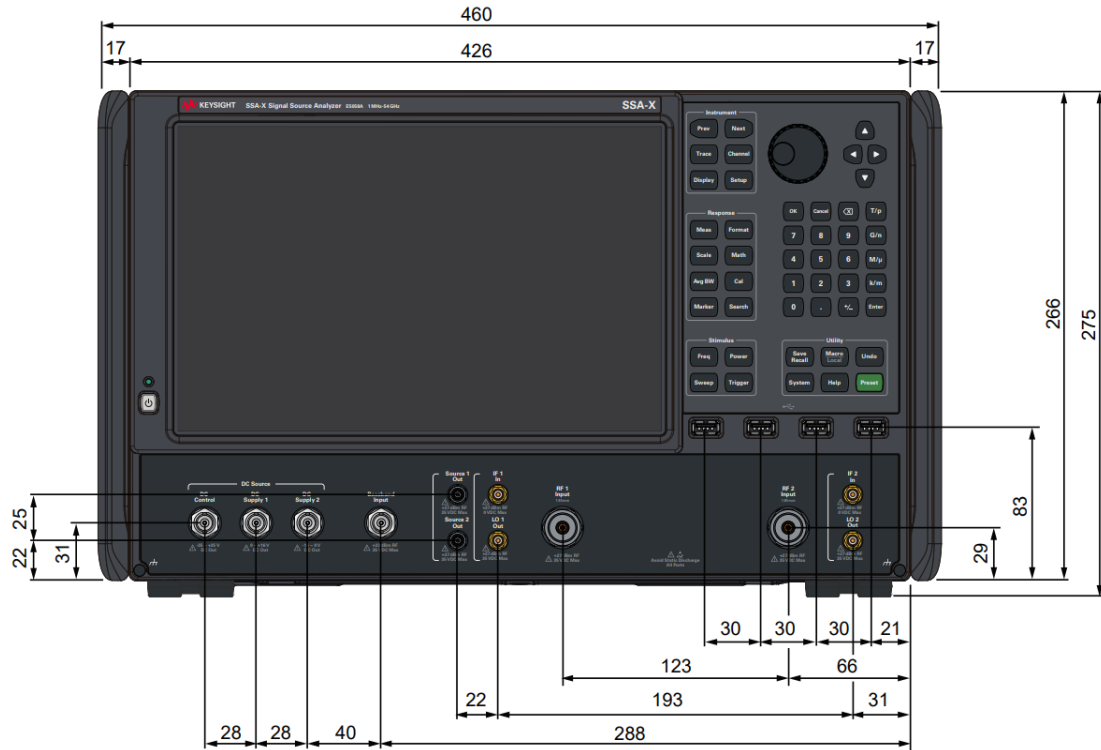

Figure 26. Front view: E505xA Option 15x + Option 40x or Option 25x + Option 40x (mm)

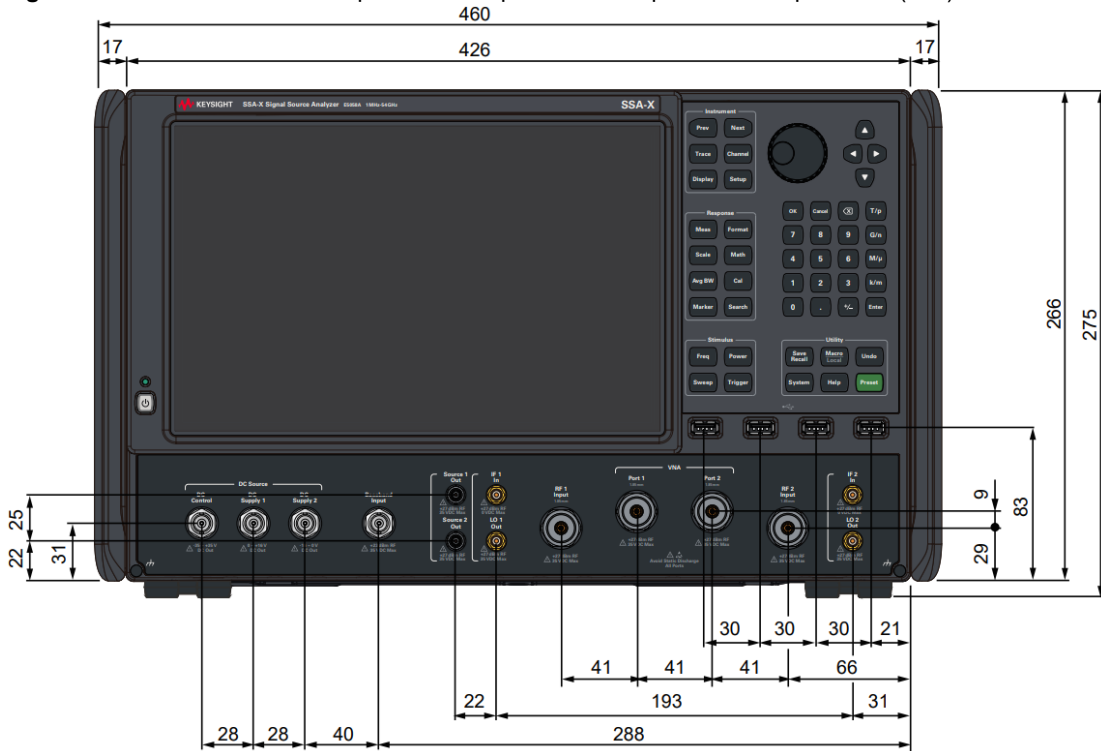

Figure 27. Front view: E505xA Option 16x + Option 40x or Option 26x + Option 40x (mm)

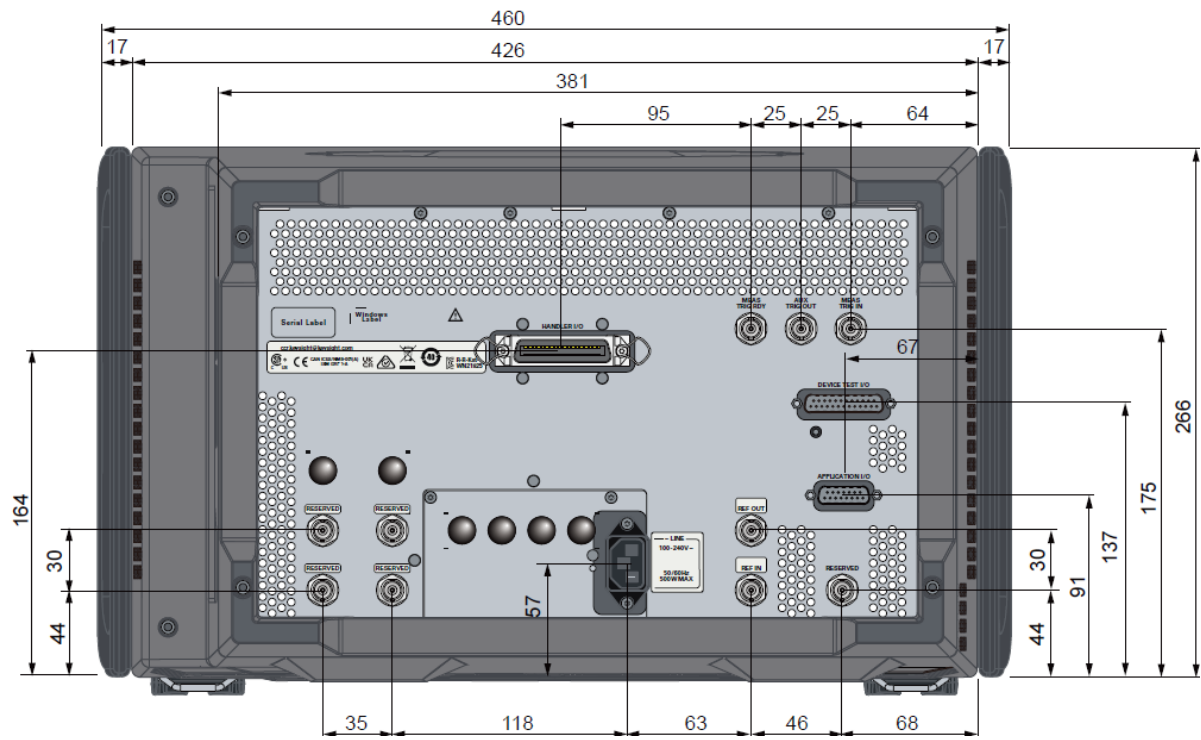

Figure 28. Rear view (mm)

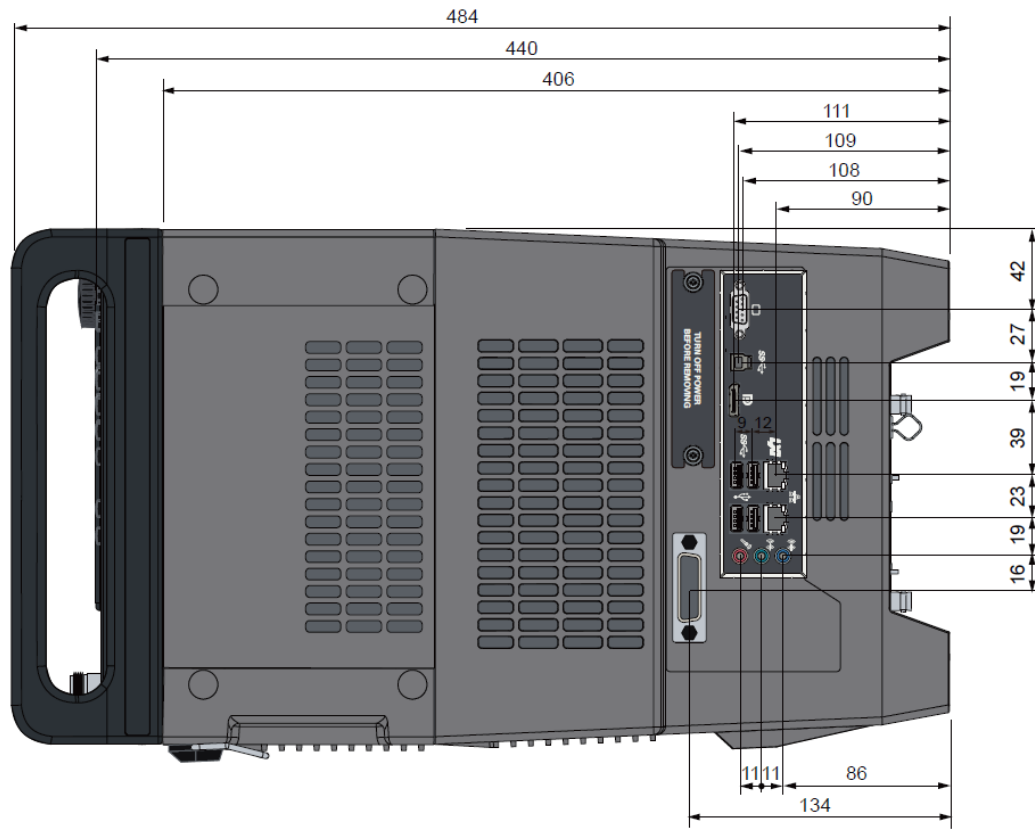

Figure 29. Side view (mm)

Software on E505xA SSA-X Signal Source Analyzer

Table 65. Optional application software

SW product number	Description and remarks
S963015B (for E5055A) S963016B (for E5056A) S963017B (for E5057A) S963018B (for E5058A)	SSA-X Signal Source Analyzer advanced features for E505xA <ul style="list-style-type: none"> • Node-locked, Transportable, Floating, USB license is selectable • Perpetual or subscription license is available • Available the following functionality and capabilities <ul style="list-style-type: none"> • Cross Correlation cycles (2 to 100,000) • Transient measurements • VCO characterization measurements • Spectrum monitor (15 MHz span)
S963905B (for E5055A) S963906B (for E5056A) S963907B (for E5057A) S963908B (for E5058A)	Spectrum analysis for E505xA <ul style="list-style-type: none"> • Node-locked, Transportable, Floating, USB license is selectable • Perpetual or subscription license is available • Full span, full function spectrum analysis (equivalent to the spectrum analysis capabilities on the E5080B ENA network analyzer.)
S96325B	Pulsed-RF measurements for SSA-X Signal Source Analyzer <ul style="list-style-type: none"> • Node-locked, Transportable, Floating, USB license is selectable • Perpetual or subscription license is available • Pulsed-RF AM/PM noise measurements • Available Pulsed RF measurements in the VNA mode on E505xA option 161, 261, 160, or 260
S96302B	Precision clock jitter analysis for SSA-X Signal Source Analyzer <ul style="list-style-type: none"> • Equivalent software as E5001A SSA-J Precision Clock Jitter Analysis Software for E5052B Signal Source Analyzer • Feature compatible with the E5001A

Web Sources

Visit our Signal Source Analyzer Web site for additional product information and literature:

www.keysight.com/find/E5055A

www.keysight.com/find/E5056A

www.keysight.com/find/E5057A

www.keysight.com/find/E5058A

www.keysight.com/find/ssa

Phase noise measurements:

www.keysight.com/find/phasenoise

RF and microwave accessories:

www.keysight.com/find/mta

Confidently Covered by Keysight Services

Prevent delays caused by technical questions and reduce system downtime due to instrument maintenance and repairs with Keysight Services. Keysight Services are here to support your test needs with expert technical support, instrument repair and calibration, software support, training, alternative acquisition program options, and more.

A KeysightCare agreement provides dedicated, proactive support through a single point of contact for instruments, software, and solutions. KeysightCare covers an extensive group of instruments, application software, and solutions and ensures optimal uptime, faster response, faster access to experts, and faster resolution.

Keysight services

Offering	Benefits
KeysightCare 	KeysightCare provides elevated support for Keysight instruments and software, with access to technical support experts that respond within a specified time and ensure committed repair and calibration turnaround times (TAT). KeysightCare offers multiple service agreement tiers, including KeysightCare Assured, Enhanced, and Application Software Support. See the KeysightCare data sheet for details.
KeysightCare Assured	KeysightCare Assured goes beyond basic warranty with repair services that include committed TAT and unlimited access to technical experts.
KeysightCare Enhanced	KeysightCare Enhanced includes all the benefits of KeysightCare Assured plus Keysight's accurate and reliable Calibration Services , accelerated, and committed TAT, and technical response.
Keysight Support Portal & Knowledge Center	All KeysightCare tiers include access to the Keysight Support Portal where you can manage support and service resources related to your assets such as service requests, and status, or browse the Knowledge Center.
Education Services	Build confidence and gain new skills to make accurate measurements, with flexible Education Services developed by Keysight experts. Including Start-up Assistance.
Alternative acquisition options	
KeysightAccess	Reduce budget challenges with a leased-based subscription service, that offers low monthly payments, enabling you to get the instruments, software, and technical support you want for your test needs.

Recommended services

Maximize your test system up-time by securing technical support, repair, and calibration services with committed response and turnaround times. 1-year KeysightCare Assured is included in every new instrument purchase. Obtain multi-year KeysightCare upfront to eliminate the need for lengthy and tedious paperwork and yearly requests for maintenance budget. Plus, you benefit from secured service for 2, 3, or 5 years.

Service	Function
KeysightCare Enhanced*	Includes tech support, warranty and calibration
R-55B-001-1	KeysightCare Enhanced – Upgrade 1 year
R-55B-001-2	KeysightCare Enhanced – Extend to 2 years
R-55B-001-3	KeysightCare Enhanced – Extend to 3 years (Recommended)
R-55B-001-5	KeysightCare Enhanced – Extend to 5 years (Recommended)
KeysightCare Assured	Includes tech support and warranty
R-55A-001-2	KeysightCare Assured – Extend to 2 years
R-55A-001-3	KeysightCare Assured – Extend to 3 years
R-55A-001-5	KeysightCare Assured – Extend to 5 years
Start-Up Assistance	
PS-S40-01	Included – instrument fundamentals and operations starter
PS-S40-04	Recommended – instrument fundamentals and operations starter
PS-S40-02	Optional, technology & measurement science standard learning

* Available in select countries. For details, please view the [datasheet](#). R-55B-001-2/3/5 must be ordered with R-55B-001-1.