



Errata

Title & Document Type: 8505A RF Network Analyzer Operating Guide

Manual Part Number: 08505-90084

Revision Date: September 1982

HP References in this Manual

This manual may contain references to HP or Hewlett-Packard. Please note that Hewlett-Packard's former test and measurement, semiconductor products and chemical analysis businesses are now part of Agilent Technologies. We have made no changes to this manual copy. The HP XXXX referred to in this document is now the Agilent XXXX. For example, model number HP8648A is now model number Agilent 8648A.

About this Manual

We've added this manual to the Agilent website in an effort to help you support your product. This manual provides the best information we could find. It may be incomplete or contain dated information, and the scan quality may not be ideal. If we find a better copy in the future, we will add it to the Agilent website.

Support for Your Product

Agilent no longer sells or supports this product. You will find any other available product information on the Agilent Test & Measurement website:

www.tm.agilent.com

Search for the model number of this product, and the resulting product page will guide you to any available information. Our service centers may be able to perform calibration if no repair parts are needed, but no other support from Agilent is available.

**HP 8505A
RF Network Analyzer
Basic Measurements**



© HEWLETT-PACKARD CO. 1976

Printed: SEPTEMBER 1982



HP 8505A
RF Network Analyzer
Basic
Measurements

LOCAL OPERATION

NOVEMBER 1978



CONTENTS

INTRODUCTION	3
Overview 8505A, test sets, and control functions.	
TRANSMISSION MEASUREMENTS	15
Setup, calibration, and measurement sequences for:	
Insertion Loss and Gain	
Insertion Phase	
Electrical Length	
Deviation from Linear Phase	
Group Delay	
REFLECTION MEASUREMENTS	22
Setup, calibration, and measurement sequences for:	
Return Loss, SWR	
Reflection Coefficient	
POWER LEVEL MEASUREMENTS	25
Measure the absolute power at the R, A, and B inputs.	
S-PARAMETER MEASUREMENTS	26
Setup, calibrate, and measure S_{11} , S_{21} , S_{12} , and S_{22} using the 8503A S-Parameter Test Set.	
THE 8501A STORAGE-NORMALIZER	30
Use the Digital Storage, Labels, Averaging, Magnification, and Normalization features of the 8501A to enhance 8505A measurement capabilities.	
CONTROLS AND DISPLAYS SUMMARY	33
A summary of the functions of the 8505A controls and displays.	

PREFACE

This application note will help you make transmission and reflection measurements with the Hewlett-Packard Model 8505A RF Network Analyzer and its associated test sets. Previous experience in network analysis techniques is assumed, so the note concentrates on generalized setup, calibration, and measurement sequences rather than basic measurement theory. As you become familiar with operation of the instrument you can modify and extend these sequences to more specialized applications.

The first part of this note introduces the 8505A and the standard test sets, then describes the main operations to make measurements. The Transmission Measurements, Reflection Measurements, Power Level Measurements, and S-Parameter Measurements sections contain specific step-by-step sequences used to make particular measurements on a device. If you have a device to measure, go directly to one of these sequences and try it. Use the Introduction as a reference for operations that require more explanation. A section for the 8501A Storage-Normalizer provides a brief description of how to use this important accessory. A foldout at the rear of this note presents a photo of the 8505A front panel and a summary of the functions of the controls, indicators, and displays.

Learn by doing. Use the 8505A to measure a device with known characteristics. You will better appreciate the ease with which measurements are made if you have access to an 8505A with test set from the very beginning. But, during the interval prior to arrival of your 8505A, you can develop valuable background knowledge of instrument operation from this note. Although the 8505A is fully programmable via the HP-IB, this note does not describe programming operations. It is recommended that you gain a good understanding of the 8505A in manual operation before writing programs to control it.

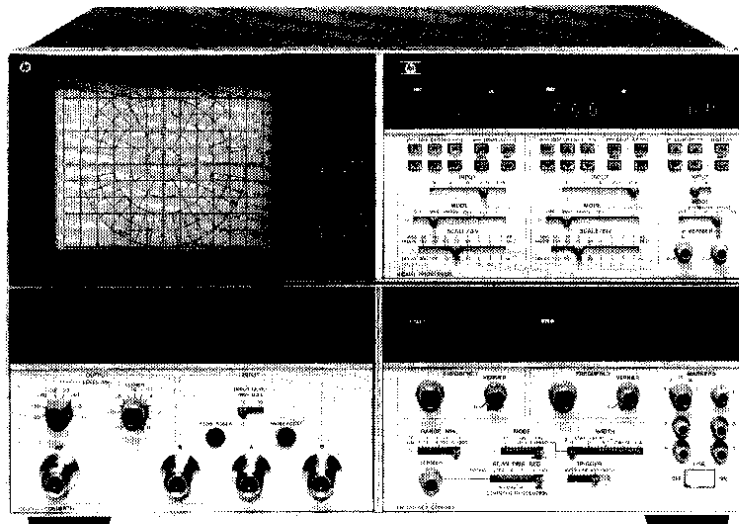

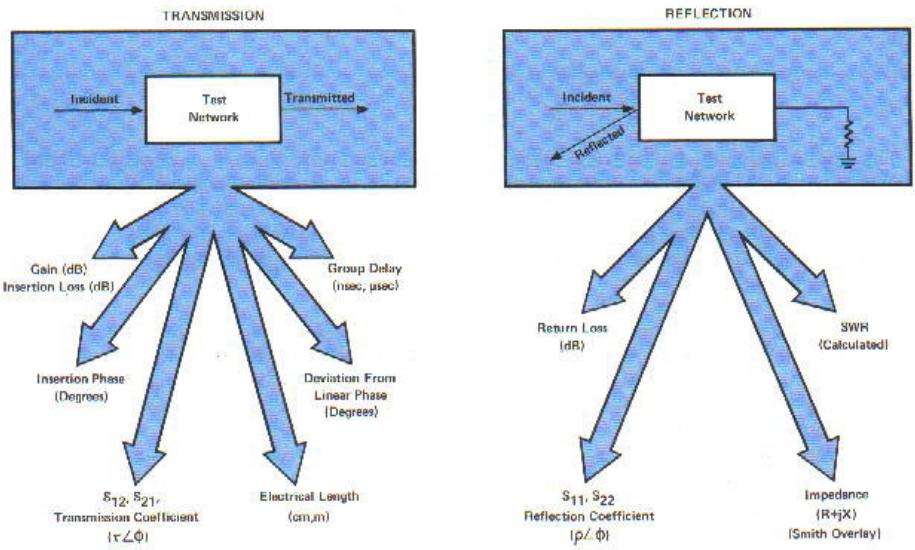

Basic 8505A Transmission and Reflection Measurements

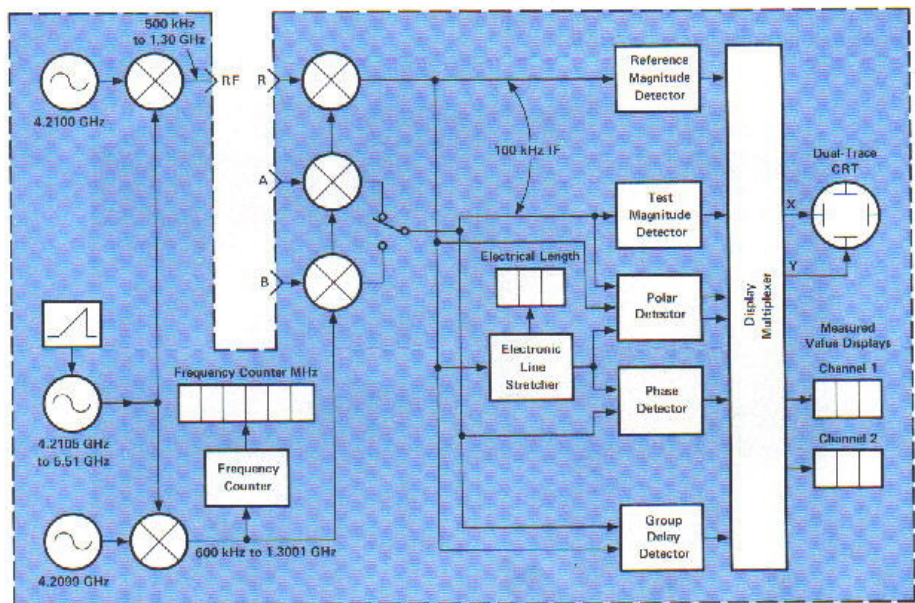

8505A Simplified Block Diagram

INTRODUCTION

The 8505A is a high performance RF network analyzer that includes a leveled source, frequency counter, two measurement channels, dual-trace CRT with both cartesian and polar displays, digital readout of the measured value, and an electronic line stretcher. Together with appropriate signal routing accessories, the 8505A is a fully integrated stimulus/response test system that measures magnitude, phase, and delay characteristics of linear networks by comparing the incident signal with the signal transmitted through the device or reflected from its input.

The basic transmission measurements described in this note are: insertion loss and gain, insertion phase, electrical length, deviation from linear phase, group delay, and transmission coefficient (S_{12} or S_{21}). Basic reflection measurements are: return loss, from which SWR can be calculated, and reflection coefficient (S_{11} or S_{22}), from which impedance can be calculated or read from a Smith Chart overlay.

To begin familiarizing yourself with the 8505A, recognize that it is packaged in two cases. The lower case contains the sweeper controls and displays, the receiver input connections, the measurement marker controls, and the frequency counter display. The upper case contains the dual trace CRT, the measurement selection controls, the measured value displays, and the electrical length controls and display. The boxed characters adjacent to the switches, buttons, and displays are HP-IB* addressing codes used when programming the instrument.

Block Diagram Description

The source produces leveled RF for the test device and a tracking local oscillator signal to the receivers. Reference (R) and test (A and B) inputs from the test setup are down-converted to 100 kHz IF frequency for application to the detectors. This combination of two identical fixed oscillators, which are phase-locked to a common reference and offset by 100 kHz, with a YIG-tuned swept oscillator provides continuous, very linear 3- $\frac{1}{2}$ decade frequency sweeps and the precise local oscillator tracking required for narrow bandwidth detection. High reliability thin-film technology enables all three input mixers to have closely matched magnitude, phase, and delay characteristics with full -10 to -110 dBm dynamic range and greater than 100 dB isolation between inputs.

Transmission and reflection characteristics can be measured simultaneously by using two identical measurement channels, one for the reference input and one switched between the A and B test inputs on alternate sweeps. Completely independent magnitude, phase, delay, and polar detectors process the IF to DC levels for multiplexing to the CRT display. The electronic line stretcher allows electrical length of the A and B test signal paths to be independently matched to the reference signal path by adding or subtracting up to 1700 degrees of linear phase shift per sweep prior to detection. This technique virtually eliminates the need for mechanical line length adjustments and allows direct measurement of deviation from linear phase. The group delay detector provides direct, calibrated measurement regardless of sweep width or sweep rate.

Frequency, magnitude, phase, and delay are read directly from digital displays by positioning a measurement marker to any point on the trace. Frequency at the marker is measured using a new up-down counter which measures the local oscillator frequency and subtracts the 100 kHz offset. This technique provides up to 100 Hz resolution and ± 2 count accuracy without the need to stop the sweep at the marker. Magnitude, phase, and delay values are measured by sampling the selected detector outputs at the marker position. An autoranging voltmeter displays the measured value with up to 0.01 dB, 0.1 degree, and 0.1 nanosecond resolution.

*HP-IB, the Hewlett-Packard Interface Bus, is Hewlett-Packard's implementation of IEEE 488.

INTRODUCTION

TEST SETS

The following test sets are designed especially for use with the 8505.

For precision transmission tests, or ratio tests using a standard device as a reference, the 11851A RF Cable Kit and 11850A (50Ω) or 11850B (75Ω) Power Splitter provide the necessary RF connections and shielding with excellent magnitude and phase tracking characteristics over the 8505 frequency range. The 11850B includes three 50Ω to 75Ω Model 11852A minimum loss pads.

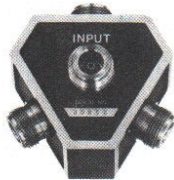

11850A/B Three-Way Power Splitter

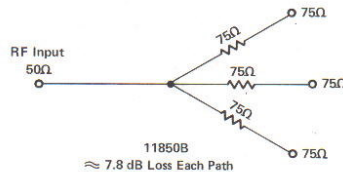
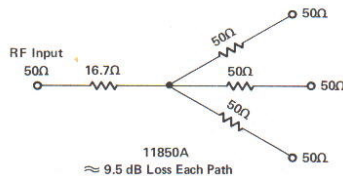

The 8502A (50Ω) or 8502B (75Ω) Transmission/Reflection Test Set contains a power splitter and directional bridge allowing simultaneous transmission and reflection measurements. It also includes a 0 to 70 dB, 10 dB step attenuator which allows control of the incident signal level independent from the reference signal level. The 8502B includes one 50Ω to 75Ω Model 11852A minimum loss pad.

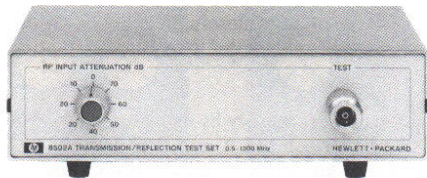

8502A Transmission/Reflection Test Set

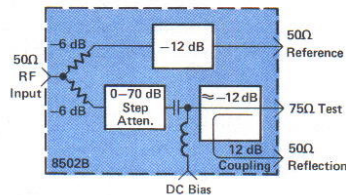
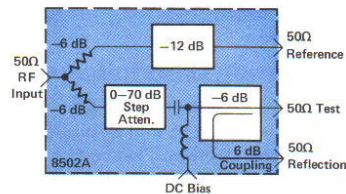

Transmission and reflection measurements on two port devices which require measurement of both forward and reverse characteristics can be accomplished easily using the 8503A (50Ω) or 8503B (75Ω) S-Parameter Test Set. With this test set and included cables, measurement of both forward and reverse characteristics can be accomplished without disconnecting and reversing the test device. DC bias connections for transistor testing are provided.

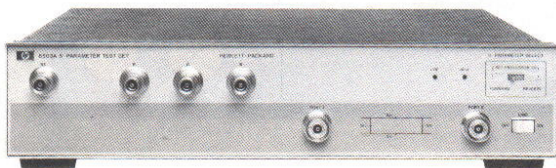

8503A S-Parameter Test Set

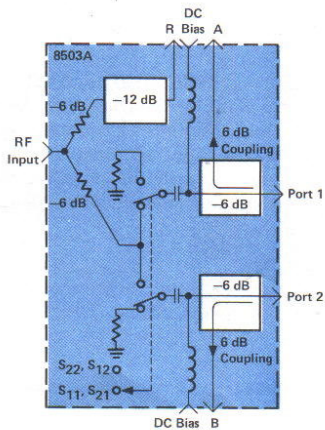

INTRODUCTORY MEASUREMENT SEQUENCE

With a basic understanding of the instrument and these test sets in mind, follow this typical operating sequence for measuring transmission insertion loss or gain. Use a bandpass filter or similar device with known characteristics. If you are not in front of an instrument, use the foldout at the rear of this note to locate the controls. This introductory sequence assumes measurements are made using the 8502 test set, or an 8503 test set with the front panel S-PARAMETER SELECT switch set to FORWARD.

Connect Test Set — See connection diagram. Do not connect the test device.

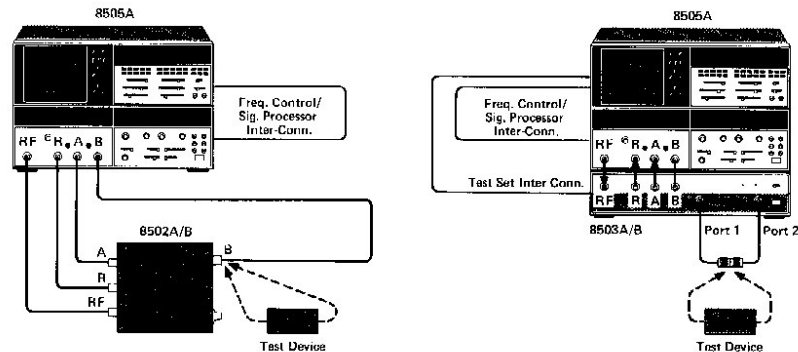

Set Signal Levels — Set the INPUT LEVEL dBm MAX switch to -10 . Use the OUTPUT LEVEL dBm and VERNIER to set the approximate signal levels to the test device. (Refer to the Power Level Measurements sequence on page 25 to measure the absolute power, if necessary.)

Select Measurement — Set CHANNEL 1 INPUT switch to B/R to select transmission, MODE to MAG to select magnitude ratio, and SCALE/DIV to 10 dB/division. Set CHANNEL 2 MODE and ELECTRICAL LENGTH MODE to OFF.

Set CRT Display — Press to detent REF LINE POSN/BEAM CENTER to display reference line, then use CH1 \blacklozenge to set reference line to desired position, usually center screen. Set TRIGGER to AUTO.

Set Frequency Sweep — Set RANGE MHz to lowest range that includes frequency range of interest. Set sweeper MODE to LIN EXPAND, and WIDTH to START/STOP 1. Now use the FREQUENCY controls below the FREQUENCY MHz displays to set the end points of the frequency sweep. Read the end points of the frequency sweep from the FREQUENCY MHz displays.

Calibrate — Connect through. Set MARKERS switch to position 1, then use the adjacent vernier to set upward-pointing measurement marker to desired calibration frequency. Press CHANNEL 1 MKR, then press and hold ZRO until the iterative zero process is complete and the trace moves to the reference line. This establishes test set response at 0 dB insertion loss or gain.

Connect Test Device — See connection diagram.

Read Measured Value — Use the MARKERS 1 vernier to position the measurement marker to any point on the trace. If necessary to position the trace for viewing, use the CH1 \blacklozenge control or the CHANNEL 1 REF OFFSET buttons (Δ moves trace up, ∇ moves trace down). Read the frequency at the measurement marker from the FREQUENCY MHz display. Press the CHANNEL 1 REF button to display value of the reference line, then press MKR to display marker displacement from the reference line. The measured value (dB) is the sum of the REF and MKR values.

The following paragraphs describe the functions of the controls used in these steps in more detail.

INTRODUCTION

SET SIGNAL LEVELS

Set Sweeper Output Level

The OUTPUT LEVEL attenuator and VERNIER set the sweeper output level at the RF connector to any level from +10 to -72 dBm. The sum of the rotary switch and the VERNIER setting is the RF output level, ± 1 dB. If the OUTPUT controls are set to -30 and -6, then the level at the RF connector will be $-36 (\pm 1)$ dBm.

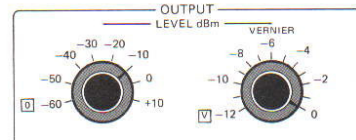

Set Reference and Test Channels Input Level

The maximum signal level which can be applied to the R, A, or B inputs is either -10 dBm or -30 dBm depending upon the INPUT LEVEL dBm MAX switch setting. If the signal level at any input is greater than the switch setting the R, A, or B OVERLOAD indicator on the dark panel above the switch will light to show that the input signal is near the compression point for the input mixer and measurement errors may result.

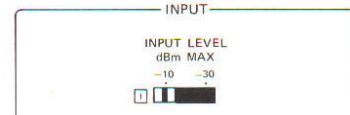

The switch is normally set at the -10 position. When making measurements in which the A or B inputs are below about -80 dBm and the R input is below -30 dBm, set the INPUT LEVEL dBm MAX switch to the -30 position. Selecting -30 increases the signal level into the detectors (and adds appropriate display compensation) thus reducing the magnitude, phase, and delay measurement uncertainties for low signal level measurements.

Signal Level Considerations

Minimum measurement uncertainty is achieved when the input levels are near maximum. For example, when the test input drops from -20 dBm to -100 dBm, the magnitude ratio uncertainty increases from ± 0.01 dB to ± 4.0 dB. The R, A, and B inputs are identical, each with -10 dBm to -110 dBm of range, thus allowing measurements to be made with 100 dB dynamic range. But, for best results in ratio measurements, the test input should be above -110 dBm for magnitude, -100 dBm for phase, and -90 dBm for delay.

The reference input level should remain constant for calibration and measurement. The test input level at calibration determines the gain and insertion loss range available for measurement without overload or excessive measurement uncertainty. Two examples are shown in this chart. Example (1) represents calibration levels for a passive device with both reference and test inputs at -10 dBm. When calibrated at this level the 8505 can measure the test device magnitude ratio to over 100 dB insertion loss. Example (2) represents calibration signal levels for an active device. It shows the reference level set to -10 dBm and the test channel set to -50 dBm. At these levels the magnitude ratio can be measured to 40 dB of gain and to over 60 dB for insertion loss.

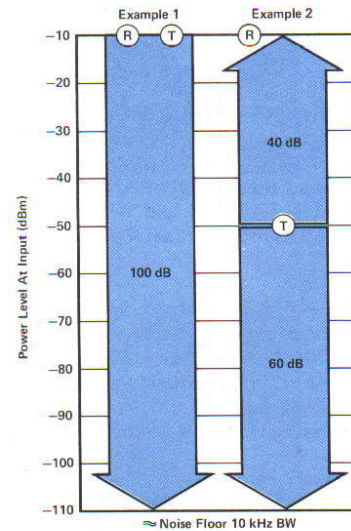

At low signal levels measurement uncertainty is seen as noise on the CRT trace. Select the 1 kHz IF bandwidth (the 1 kHz button to the right of the CRT) to reduce the pre-detection bandwidth and improve the signal-to-noise ratio into the detectors. Select the VIDEO FILTER to reduce the post-detection bandwidth and thus reduce the residual uncertainty caused by detector noise. Slower scan time may be required.

INTRODUCTION

SET CRT DISPLAY

Pressing to detent the REF LINE POSN/BEAM CENTER button displays the cartesian reference line or the polar beam center during the sweep retrace. Standard controls are used for beam focus, beam intensity, scale illumination, and trace align. This illustration presents a sequence for setting the cartesian reference line and polar beam center positions.



Depress REF LINE POSN/BEAM CENTER button

CHANNEL 2 MODE: OFF

CHANNEL 1: R, MAG

(Use SCALE/DIV switch or press REF OFFSET to move CRT trace away from reference line)

CH1 \blacktriangle to position reference line

CHANNEL 1: POLAR MAG

POL \blacktriangleleft and POL \blacktriangleright to center beam

CHANNEL 1 MODE: OFF

CHANNEL 2: R, MAG

CH2 \blacktriangledown to position reference line

Press to release REF LINE POSN/BEAM CENTER (may be left depressed)

For the cartesian display, the reference line is the position from which SCALE/DIV expands or contracts the trace. The value of the reference line is initially zero dB, degrees or seconds and the trace is positioned above or below the reference line depending upon whether the response characteristic is positive or negative.

The reference line can be set to any position on the CRT at any time using the CH1 \blacktriangle and CH2 \blacktriangledown controls without disturbing the calibration values.

To continue the previous exercise, press to detent the REF LINE POSN/BEAM CENTER button and move the reference line to the center CRT graticule line. Connect the test set, and set CHANNEL 1 or CHANNEL 2 INPUT to R, A, or B and set MODE to MAG. If the REL indicator near the measured value display is lit, press and hold the CLR button until REL goes out (\approx 2 seconds at each INPUT position). Read the power at the R, A, and B inputs from the CRT display by assuming that the reference line is 0 dBm and noting the trace position with respect to the reference line.

For the polar display, reflection and transmission coefficient values can be read directly from the polar graticule. For magnitude ratio, the beam center position is the point of zero reflection coefficient (infinite dB return loss) and zero transmission coefficient (infinite dB insertion loss). The outer circle is the magnitude ratio reference line, having a linear coefficient value corresponding to the SCALE/DIV POLAR FULL selection. At POLAR FULL 1 (and zero dB REF OFFSET) the outer circle represents a reflection coefficient magnitude of 1 (0 dB return loss) and transmission coefficient magnitude of 1 (0 dB insertion loss). For phase angle, the zero degrees reference line is the right hand intersection of the center line and the concentric circles and is scaled from zero to ± 180 degrees.

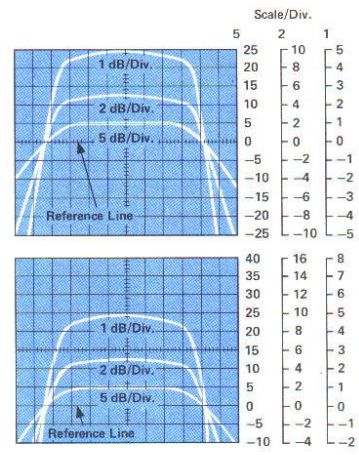

Cartesian Display

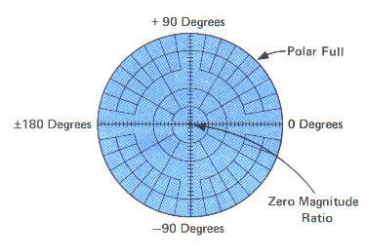

Polar Display

SET FREQUENCY SWEEP

Frequency sweep is controlled by the RANGE MHz, MODE, and WIDTH switches. RANGE MHz selects the frequency range. MODE selects logarithmic or linear full sweep, or the linear expanded sweep selected by WIDTH. You can set and store an independent expanded sweep at each of the WIDTH switch START/STOP 1, START/STOP 2, and CW $\pm \Delta F$ positions using the FREQUENCY MHz displays and FREQUENCY controls. To familiarize yourself with operation of the sweeper frequency controls, follow this sequence.

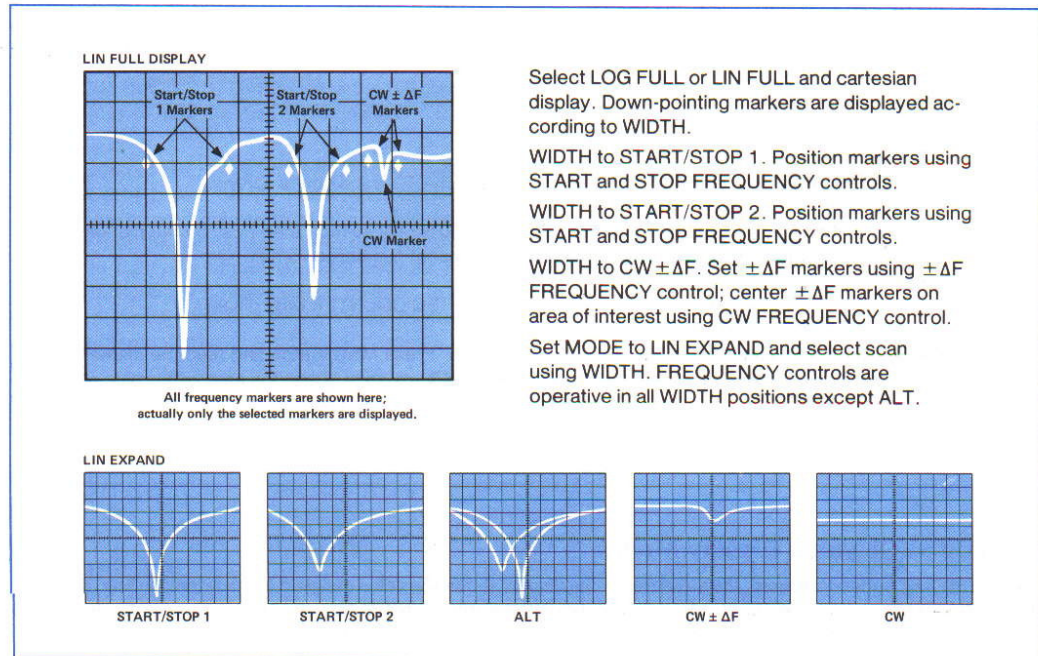

In LOG FULL, the full selected frequency range is swept with a logarithmic frequency axis. (The log sweep end points are identified above the RANGE MHz switch and log frequency graticule overlays are available.) LIN FULL selects a linear sweep of the full selected frequency range (500 kHz to 13, 130, or 1300 MHz). In the full sweep modes selecting one of the START/STOP or CW $\pm \Delta F$ places two down-pointing frequency markers on the CRT trace to identify the sweep end points. The FREQUENCY controls position these markers; each adjacent VERNIER provides fine adjustment but does not change the FREQUENCY MHz displays.

For ALT, CHANNEL 1 displays the START/STOP 1 sweep and CHANNEL 2 displays the START/STOP 2 sweep. The FREQUENCY MHz displays and the FREQ COUNTER MHz display readings apply to the START/STOP 1 sweep unless CHANNEL 1 is off, in which case the readings apply to the CHANNEL 2 sweep. For CW, the frequency counter measures the actual CW frequency and displays it using the left-hand six-digit FREQUENCY MHz display.

In START/STOP and CW $\pm \Delta F$ the FREQUENCY MHz displays do not have counter accuracy and thus should not be used for other than setting approximate frequency sweep widths. Residual FM performance is improved in the lower RANGE MHz settings, so select the lowest setting which includes the frequency range of interest for your measurement. The frequency controls can be set so that the start frequency is above the stop frequency, but degraded sweep linearity will reduce the accuracy of the measured frequency and group delay values.

Set Sweep Time

Time for a complete sweep of the selected frequency range is selected by the SCAN TIME SEC switch and adjacent VERNIER. Select the fastest sweep time then decrease until there is no distortion of the test device response. The vernier allows continuous adjustment within the selected range.

INTRODUCTION

READ MEASURED VALUE

The general sequence to read the measured value at a particular point on the CRT trace is as follows.

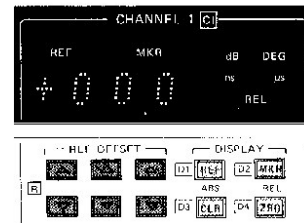

Measured Value Display

Use REF OFFSET buttons and SCALE/DIV switch to position CRT trace on the screen.

Select one of the five measurement markers using the MARKERS switch, then position the marker on the CRT trace at the point to be measured using the adjacent numbered vernier.

Read the frequency at the measurement marker from the FREQ COUNTER MHz display.

Press REF button and read the value of the reference line. Press MKR button and read the marker displacement from the reference line. Add the REF and MKR values to obtain the measured value at the measurement marker.

REF and MKR Value Display Modes

When the REF button is pressed, the measured value display shows the value assigned to the reference line. When the MKR button is pressed the measured value display shows the displacement of the selected measurement marker from the reference line. The magnitude, phase, or delay value at any point on the CRT trace is then:

$$\text{REF value} + \text{MKR value} = \text{Measured Value}$$

If REF OFFSET has not been used to position trace, REF will equal zero and the MKR value alone represents the measured value.

REF OFFSET

Pressing any REF OFFSET button increments the reference line value for that channel, thus moving the CRT trace in relation to the reference line. Holding a REF OFFSET button pressed increments the associated LED numeral at the rate of about two digits per second. Momentarily pressing the CLR button resets the reference line value for that channel to zero.

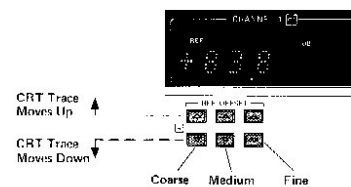

There is no accuracy advantage in moving the CRT trace closer to the reference line to make the measurement. In fact, the MKR value is correct even when the CRT trace and the measurement marker are positioned off screen. However, when the SCALE/DIV switch is at one of the four right-hand positions and the REF or MKR value is less than about 8 dB, 80 degrees, or 8 delay units, the displayed REF or MKR value gains an additional decimal digit of resolution. To see this change, select MKR mode, move SCALE/DIV to one of the four right-hand positions, and use REF OFFSET to move the CRT trace toward and away from the reference line.

Using REF OFFSET, the magnitude, phase, and delay trace positions can be set independently. The REF value is stored in six independent Reference Offset registers; three for each channel, one for each of the MAG, PHASE, and DLY selections. (The POLAR MAG position shares the same Reference Offset register as the MAG position and POLAR PHASE shares the PHASE register.)

Frequency Counter

The FREQ COUNTER MHz display indicates the frequency in MHz at the selected measurement marker in all sweep modes except CW. In CW, the counter uses the left-hand FREQUENCY MHz display to indicate the CW frequency.

Resolution of the FREQ COUNTER MHz display is controlled by RANGE MHz and SCAN TIME SEC selections. Slow sweep times allow greater counter resolution, shift one or more digits off the left of the display and cause the display OVERFLOW indicator to light. To obtain six digit counter resolution, move SCAN TIME SEC to a faster sweep position to inspect the most significant digits, then to a slower sweep position to inspect the least significant digits.

When the MARKERS rotary switch is moved to positions 2 through 5, all lower numbered markers are displayed on the CRT trace pointing down. The selected measurement marker points up.

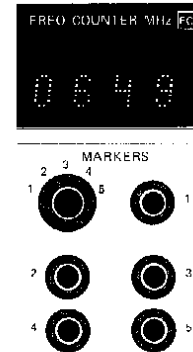

Polar Display

The CRT trace is the same for both POLAR MAG and POLAR PHASE selections. The measured value display reads the magnitude ratio at the measurement marker in POLAR MAG and the phase angle at the measurement marker in POLAR PHASE.

For POLAR MAG, the displayed measured value is the same dB ratio as indicated for the MAG selection. The magnitude part of the linear coefficient can be read from the concentric circles of the polar graticule, or calculated using the REF + MKR dB value and the HP Reflectometer Calculator (HP p/n 5952-0948) or the following equation:

$$\tau \text{ or } \rho = 10^{D/20} \quad \text{where } D = \frac{\text{Measured Value}}{20}$$

Where τ and ρ represent the magnitude part of the linear transmission or reflection coefficient, respectively, and Measured Value (dB) represents the REF + MKR value. For example if the REF + MKR value is -15 dB, the magnitude part of the linear coefficient is 0.178.

The phase value of the linear coefficient, $\angle\phi$, is read from the radial lines of the polar graticule, or by selecting POLAR PHASE and reading the REF + MKR value from the measured value display.

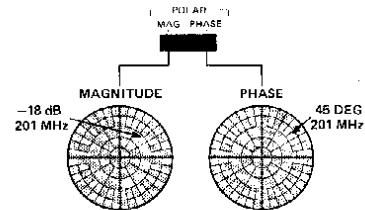

INTRODUCTION

CALIBRATE

Measurements on a test device are made relative to a measurement standard with known response characteristics. Calibration establishes the offsets required to obtain a correct measured value for the measurement standard using the same test set-up as will be used for measurements on the test device.

The calibration standard for transmission measurements is a "through" connection (connect the points at which the test device will be connected). Complete transmission calibration sets the magnitude ratio between the transmitted and reference signals to unity (0 dB), equalizes any electrical length difference between the transmitted and reference signal paths, sets the phase to zero degrees, and the group delay to zero seconds. This establishes the transmission coefficient of the test set-up as $1 \angle 0^\circ$ with zero seconds group delay, the theoretical value for a zero-length transmission line.

The calibration standard for reflection measurements is normally a short circuit connected at the measurement plane (the point at which the test device will be connected). Complete reflection calibration sets the magnitude ratio between the reflected and reference signals to unity (0 dB), equalizes any electrical length difference between the reflected and reference signal paths, and sets the phase to 180 degrees. This establishes the reflection coefficient of the test set as $1 \angle 180^\circ$, the theoretical value for a short circuit.

Calibration values are stored in independent Stored Reference Offset registers, one for each measurement category. Thus, you can perform calibration for transmission and reflection magnitude, phase, and delay in sequence prior to measurement. Calibration values are shared by CHANNEL 1 and CHANNEL 2 so calibration using one measurement channel serves for both. Also, calibration values for magnitude and phase are shared by the cartesian and polar display modes so calibration using one display mode serves for both. Calibration values remain stored for as long as power is applied to the instrument or until manually cleared or changed.

ZRO buttons for CHANNEL 1 and CHANNEL 2 provide the magnitude, phase, and delay calibration function. Operation of the ZRO button depends upon the MKR or REF display mode selection. The MKR, ZRO sequence is used to establish a zero reference, as for magnitude, transmission phase, and delay calibrations. MKR, ZRO stores the offset required to move the measurement marker and trace to the reference line. The REF, ZRO sequence is used to establish a non-zero reference, as for the + or - 180 degree phase offset required for reflection phase calibration.

The REL indicator above the display lights to show that a calibration offset is stored and that the measured value is relative to the calibration standard. Pressing and holding CLR for about one second clears the stored calibration and extinguishes the REL indicator.

MKR, ZRO

To calibrate using MKR, ZRO, select the measurement mode, select MKR, then press and hold ZRO until the iterative process which moves the marker to the reference line and zeros the measured value display is complete (2 or 3 sweeps). Now the measurement marker is positioned on the reference line and the MKR and REF values are both zero. The process assigns the reference line the value of zero, then stores the offset required to move the measurement marker to the reference line. This is an example of MKR, ZRO operation for magnitude calibration using a simple transmission test set with a through connection.

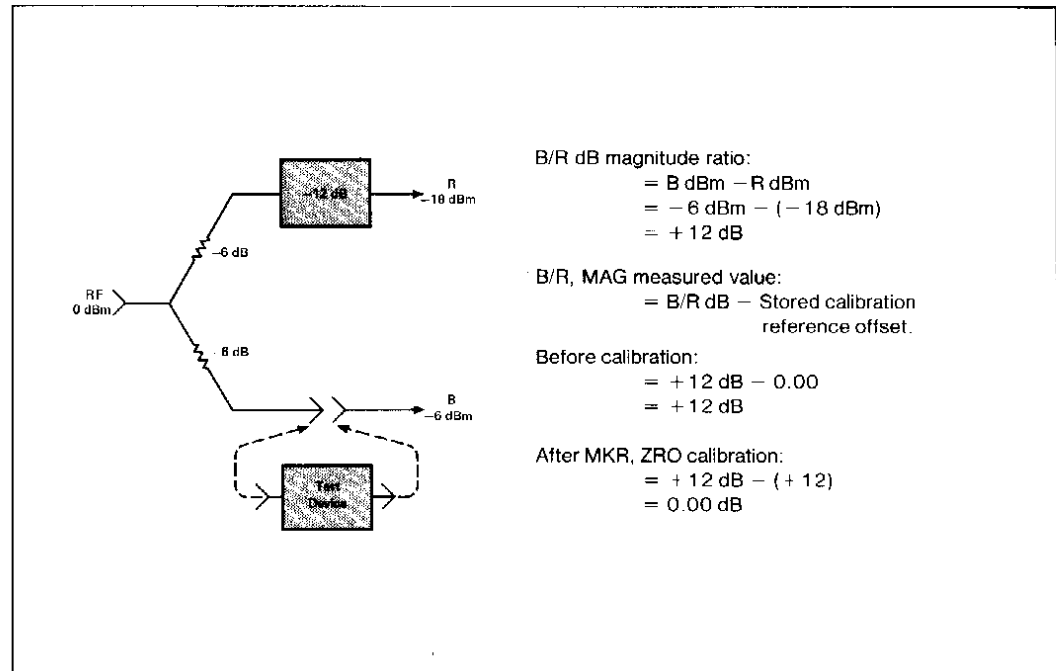

Calibration should be accomplished at higher than or equal to the resolution at which the measurement is to be made. Thus, if high resolution measurements are made, calibration should proceed as a two-step process. First set SCALE/DIV to one of the four left-hand positions, press MKR, then hold ZRO pressed until the display is zero. Now move SCALE/DIV to one of the four right-hand (high resolution) positions and hold ZRO pressed until the display is zero again. Notice that the display decimal point moves one digit to the left during the second step.

Offset values in the calibration registers cannot be displayed. It is not necessary to examine the calibration value following calibration because the value only represents the offset value necessary to remove the test set losses and offsets from the measurement. The absolute value of the measurement is the sum of the calibration offset value, the REF value, and the MKR value, but the instrument automatically subtracts the calibration value from the measurement and the test device response characteristic is represented by the MKR + REF value alone.

Each time ZRO is pressed, a new calibration offset is stored. Thus, for example, if the measurement marker is not at the correct calibration frequency the first time ZRO is pressed, the marker can be moved and ZRO pressed again. Normally, use ZRO only at calibration. CLR can be pressed momentarily to clear the displayed REF value, but holding it for about one second will clear the calibration offset value. Pressing and holding CLR until the REL indicator goes out will make re-calibration necessary.

INTRODUCTION

SET ELECTRICAL LENGTH

Electrical length is equal in the reference and test signal paths when the linear insertion phase response does not vary (is constant) over the frequency sweep of interest. Constant insertion phase is identified by a flat trace in a cartesian measurement, or a small cluster in a polar measurement.

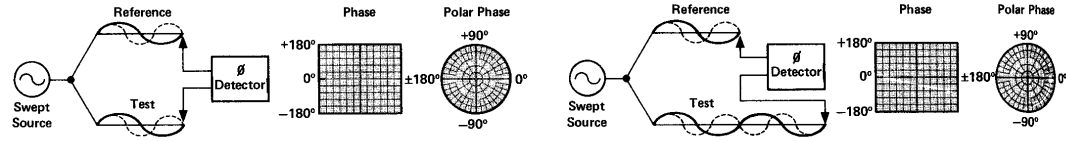

Equal Electrical Length. Phase relationship constant with frequency.

Unequal Electrical Length. Phase relationship shows linear variation with frequency.

On the ELECTRICAL LENGTH part of the control panel, INPUT selects display of the electrical length added to or subtracted from the reference signal path to equalize the A or B test signal path. There are two Electrical Length Offset registers, one for A and one for B. The LENGTH pushbuttons increment the register selected by INPUT, allowing independent equalization of the two test signal paths. Momentarily pressing the CLR button sets the selected register and display to zero. The A and B VERNIERS allow fine length adjustment without changing the LENGTH display or the value stored in the A or B electrical length register. Setting MODE to OFF removes the line length equalization for the test signal path selected by INPUT. Move the INPUT switch to the other position to deselect length for both channels.

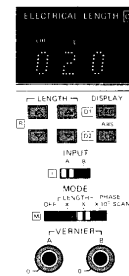

The MODE switch selects the units for electrical length. When MODE is set to x1 and x10, electrical length is introduced in units of meters or centimeters of equivalent air line as shown by the m or cm indicator above the display. When MODE is set to PHASE x10°/SCAN, ten times the displayed degrees of phase shift is introduced over the selected frequency sweep. The linear insertion phase added or subtracted is zero at the beginning of the frequency sweep, increasing linearly to ten times the display degrees at the end of the sweep. This degrees/scan mode allows greater range than the x1 or x10 MODE selection and is usually required for devices with long electrical length.

In the PHASE x10°/SCAN MODE, equivalent electrical length can be calculated from the displayed value using the following computation,

$$\begin{aligned} \text{electrical length (meters)} &= \frac{\text{phase change (degrees)}}{\text{sweep width (Hertz)}} \times \frac{3 \times 10^8 \text{ meters/sec}}{360 \text{ degrees/cycle}} \\ &= \frac{\text{display value} \times (10)}{\text{sweep width (MHz)} \times 1.2} \end{aligned}$$

where display value represents the ELECTRICAL LENGTH display reading, and sweep width represents the total selected frequency sweep in MHz. For example, if it is necessary to add +1350 degrees to flatten the phase response trace and the frequency sweep is from 1100 to 1110 MHz, the equivalent electrical length compensation is:

$$(\text{meters}) = \frac{+1350}{(1110-1100) 1.2} = +112.50 \text{ meters}$$

Electrical length calibration is accomplished by selecting the A or B input, equalizing the electrical length with the calibration standard connected, then pressing the ELECTRICAL LENGTH ZRO button. The displayed value is stored in the selected Stored Electrical Length register as the calibration electrical length offset, and the display is set to zero. The REL indicator lights to indicate that a non-zero calibration value is stored and that the display value is relative to the calibration value. Press and hold CLR until the REL light goes out to reset the stored calibration value to zero. Each time ZRO is pressed, the displayed value is added to the stored calibration value.

TRANSMISSION MEASUREMENTS

This section describes transmission insertion loss and gain, insertion phase, electrical length, deviation from linear phase, and group delay measurements. These measurements are described individually, each with separate setup, calibration, and measurement sequences. For a generalized calibration sequence for all transmission measurements, refer to the S-Parameter Measurements, General Calibration Sequence. Below is a diagram of transmission test connections using the 8502 Transmission/Reflection Test Set.

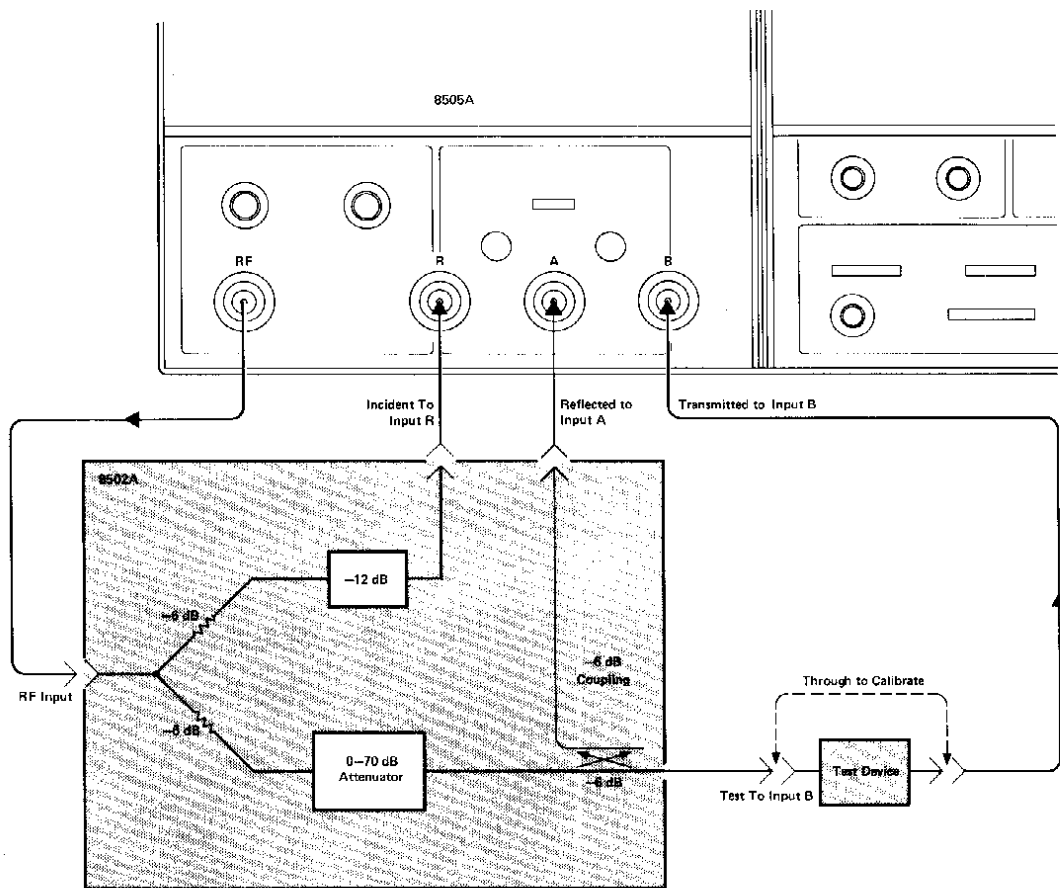

Connections to the test set and test device are made using the cables supplied in the 11851A Cable Kit. The test device input port is connected to the 8502 front panel TEST connector. For transmission calibration, the cable which connects to the device output is connected to the 8502 TEST output. Whatever configuration is used, all cables, adapters, and fixtures required for the measurement should also be used for calibration.

TRANSMISSION MEASUREMENTS

INSERTION LOSS AND GAIN

This sequence lists the steps for a typical insertion loss or gain measurement.

SETUP

- Set signal levels
- Set frequency sweep
- Set CRT display
- MARKERS: 1, position measurement marker so FREQ COUNTER MHz reads desired calibration frequency.

CALIBRATION

- Connect through.
- CHANNEL 1:
 - B/R, MAG, 10 dB/division.
 - MKR, ZRO (hold until display zero). ➔

MEASUREMENT

- Connect test device.
- Position measurement marker to read magnitude ratio (MKR + REF) and frequency.

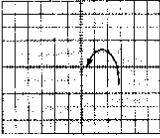

MKR, ZRO moves marker to reference line.

Calibration for insertion loss and gain measurement sets the magnitude ratio between the transmitted and reference signals to zero dB with the through connection. After connecting the test device, a negative measured value indicates insertion loss; a positive measured value indicates gain. Take care to choose signal levels to achieve maximum dynamic range (see page 6).

This figure shows a display of the magnitude ratio response of a bandpass filter. The measurement marker is positioned to the minimum insertion loss point in the passband. For this measurement no REF OFFSET has been added (the 0 dB reference line is positioned at the top graticule using CH1 \blacklozenge or CH2 \blacklozenge) so the displayed MKR value represents the insertion loss.

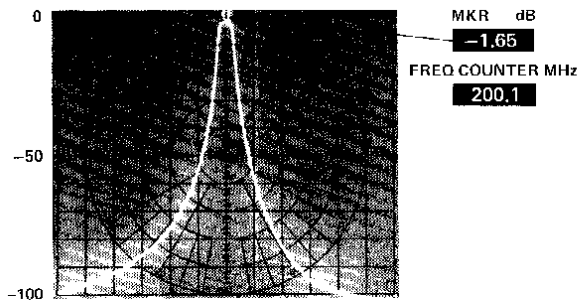

Relative Measurements

To measure the difference between two points on the trace, select MKR display mode, position the measurement marker to the first point, add or subtract REF OFFSET to make the MKR reading zero, then move the marker to the second point. The MKR reading at the second point represents the difference between the two points. Calibration is retained using this sequence and the measured value always represents the sum of the REF and MKR values at any point.

TRANSMISSION MEASUREMENTS

The same operation can be performed without preserving the original calibration value by positioning the marker to the first point, pressing MKR then ZRO (hold until display zero), then moving the marker to the second point. Using this sequence, a new calibration value is stored and all further measured value readings (REF + MKR) will be relative to the first point instead of the original calibration value.

Thus, both sequences are equivalent, but the first sequence retains the original calibration value. These sequences can also be used for magnitude, phase, and delay measurements.

3 dB Frequencies

For example, the insertion loss or gain measurement sequence can be extended to measure the 3 dB points of the filter.

SCALE/DIV: 1 dB/division.
Set frequency sweep to center the passband trace with 3 dB points visible.
Position measurement marker to center of passband or minimum insertion loss point.
MKR, then use REF OFFSET so MKR value is zero.
Move marker so MKR value is - 3.00 dB.
Read frequency from FREQ COUNTER MHz.
Move marker to other 3 dB point and read frequency.
CLR (momentarily) to remove REF OFFSET.

Be sure to press CLR momentarily; if held for more than about one second, the REL light will go out indicating that the stored calibration offset has been cleared and recalibration is necessary.

Gain Compression

A sequence similar to that above can be used to measure the 1 dB gain compression output power.

Position measurement marker to frequency of interest.
OUTPUT LEVEL dBm and VERNIER to increase incident power level until magnitude ratio begins to decrease.
MKR, then use REF OFFSET so MKR value is zero.
Increase incident power until MKR value is - 1 dB.

The amplifier output level can be estimated by summing the amplifier gain and sweeper output power, then subtracting test set transmission loss. A more precise measurement can be made by connecting the test device output directly to the B input and measuring the absolute power level by selecting B, MAG (see page 25).

TRANSMISSION MEASUREMENTS

INSERTION PHASE

This sequence lists the steps for a typical insertion phase measurement.

SETUP

- Set signal levels.
- Set frequency sweep.
- Set CRT display.
- MARKERS:** 1, position measurement marker so FREQ COUNTER MHz reads desired calibration frequency.

CALIBRATION

- Connect through.
- CHANNEL 1:**
 - B/R, PHASE, 90 degrees/division.
- ELECTRICAL LENGTH:**
 - B, MODE as required (usually x1 or x10),
 - CLR if REL lighted,
 - LENGTH AND VERNIER B for flat response.
- CHANNEL 1:**
 - MKR, ZRO (hold until display zero).

MEASUREMENT

- Connect test device.
- Electrical length MODE (and sweep width if PHASE x10°/SCAN selected) same as calibration.
- Position measurement marker to read insertion phase (MKR + REF) and frequency.

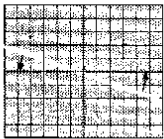

Center marker, press MKR, then press and hold CHANNEL 1 ZRO while adjusting LENGTH

This figure shows a bandpass filter insertion phase. The 8505A phase measurement range is +180 to -180 degrees, and the vertical line represents the transition between these values. Thus, the trace between any two of these transition lines represents 360 degrees of phase shift.

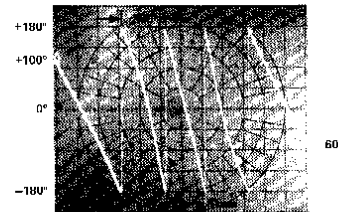

To illustrate the display format, determine the total phase shift for the selected sweep width as follows: Position the measurement marker as far to the left as possible before the FREQ COUNTER MHz display blanks. Read the phase value (+100° in this example) and determine the total number of degrees before the first transition trace (100 + 180). Next count the second and following transition traces and multiply by 360 (2 x 360). Now determine the number of degrees from the last transition trace to the right edge of the screen (180 + 60). The sum of these values represents the total phase shift over the frequency sweep.

$$(100 + 180) + (3 \times 360) + (180 + 60) = 1600^\circ$$

When the transmitted signal is below the noise floor for insertion phase measurements the CRT trace usually reads zero degrees.

ELECTRICAL LENGTH

This sequence lists the steps for a typical measurement of equivalent electrical length.

SETUP

- Set signal levels.
- Set frequency sweep.
- Set CRT display.

CALIBRATION

- Connect through CHANNEL 1:
- B/R, PHASE, 90 degrees/division
- ELECTRICAL LENGTH:**
- B, MODE as required (usually PHASE x10°/SCAN), CLR if REL lighted.
- LENGTH and VERNIER B for flat response, ZRO.

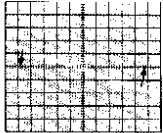

Center marker, press MKR, then press and hold CHANNEL 1 ZRO while adjusting LENGTH.

MEASUREMENT

- Connect test device
- Electrical length MODE (and sweep width if PHASE x10°/SCAN selected) must be same as calibration.
- ELECTRICAL LENGTH:**
- LENGTH for flat response over frequency range of interest. If MODE set to x1 or x10 read equivalent electrical length of test device from ELECTRICAL LENGTH display, or, if MODE set to PHASE x 10°/SCAN, calculate equivalent electrical length of test device using

$$\text{meters} = \frac{\text{display value} \times 10}{\text{sweep width (MHz)} \times 1.2}$$

This measurement determines the linear insertion phase required to equalize the electrical length of the reference and test channels with the test device installed. Note that if PHASE x10°/SCAN is selected the sweep width cannot be changed without affecting the calibration; if x1 or x10 is selected, changing sweep width does not affect calibration. To avoid the electrical length calculation required when the PHASE x10°/SCAN mode is selected, measure electrical length with a frequency sweep width of 8.333 MHz. With this sweep width, the ELECTRICAL LENGTH display reads the length in centimeters directly.

The wide range of the electrical length controls allow great latitude in the test setup, but you should recognize the limitations. For best accuracy in phase and electrical length measurements the maximum values listed below for electrical length should not be exceeded.

ELECTRICAL LENGTH MODE	RANGE MHz		
	0.5 - 13	0.5 - 130	0.5 - 1300
x1	±19.9 m	±1.99 m	±19.9 cm
x10	±100 m	±10.0 m	±100 cm
PHASE x10°/SCAN	±1700°	±1700°	±1700°

The values represent the sum of the calibration value and any length added during the measurement. Above these values insertion phase linearity is degraded.

TRANSMISSION MEASUREMENTS

DEVIATION FROM LINEAR PHASE

This sequence lists the steps for a typical measurement of deviation from linear phase.

SETUP
Set signal levels.
Set frequency sweep.
Set CRT display.

CALIBRATION
Connect through.
CHANNEL 1:
B/R, PHASE, 90 degrees/division.
ELECTRICAL LENGTH:
B, MODE as required (usually PHASE x10°/SCAN),
CLR if REL lighted,
LENGTH AND VERNIER B for flat response. ➡

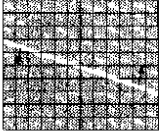

Center marker, press MKR, then press and hold CHANNEL 1 ZRO while adjusting LENGTH.

MEASUREMENT
Connect test device.
Electrical length MODE (and sweep width if PHASE x10°/SCAN selected) must be same as calibration.
ELECTRICAL LENGTH:
LENGTH and VERNIER B for flat phase response in frequency range of interest.
Position measurement marker to read phase deviation.

Measuring deviation from linear phase is an alternative to measuring group delay made possible by the range of the 8505 electronic line stretcher. Insertion phase consists of two components, linear and non-linear. Deviation from linear phase is a measure of the non-linear component of insertion phase. By compensating for the linear insertion phase component using the electrical length controls, the deviation from linear phase over the frequency sweep can be measured directly. Compared to group delay, deviation from linear phase is a fundamental measurement because delay is the derivative of phase change with frequency. Also, greater phase sensitivity allows a greater dynamic range than group delay measurements, and deviation from linear phase will produce greater detail in areas where the phase response changes rapidly over a small frequency change.

This figure shows how introducing linear insertion phase (electrical length) allows determination of non-linear insertion phase.

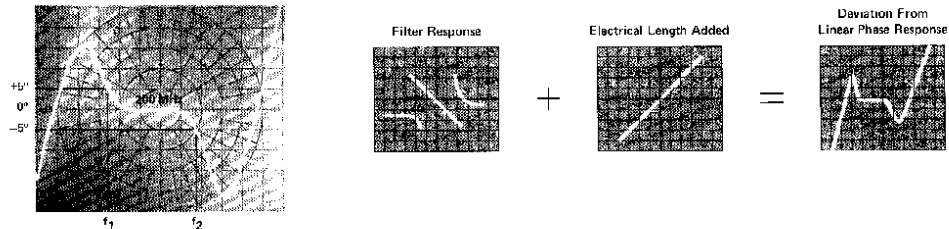

Note that the same maximum electrical length considerations as for the electrical length measurements (page 19) must be observed. If the network exhibits large phase changes with frequency, reduce the sweep width and make a series of measurements over the frequency range of interest. This example shows the deviation from linear phase of a bandpass filter with markers at the 3 dB frequencies. Even if the network must be specified in terms of group delay, the deviation from linear phase measurement serves as a good check of the actual phase response. Using the dual-trace capability of the 8505A, compare deviation from linear phase with the network group delay as described on the next page.

GROUP DELAY

This sequence lists the steps for a typical group delay measurement.

SETUP

- Set signal levels.
- Set frequency sweep.
- Set CRT display.
- MARKERS: 1, position measurement marker so FREQ COUNTER MHz reads desired calibration frequency.

CALIBRATION

- Connect through.
- CHANNEL 1:
 - B/R, DLY, 100 nanoseconds/division,
 - MKR, ZRO (hold until display zero).

MEASUREMENT

- Connect test device.
- Position measurement marker to read group delay (MKR REF) and frequency.



MKR, ZRO moves marker to reference line.

A device with no phase distortion presents a linear insertion phase characteristic. Group delay will thus appear as a flat horizontal line. This figure shows that group delay varies as a function of frequency when the test device exhibits deviation from linear phase.

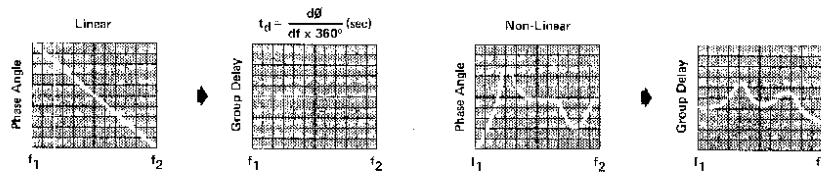

With slow sweep times or narrow frequency sweeps the instrument switches from the continuous mode to a sample mode in order to maintain the best signal-to-noise ratio for the measurement. Maximum sample rate is 1000 samples per second. If the test device bandwidth will permit fast sweeps, increase the sweep speed until the instrument switches to the analog mode, then slow the sweep speed until just before the switch to sampling. If not, slow to ≈ 1 sec/sweep and use the sample mode with video filtering.

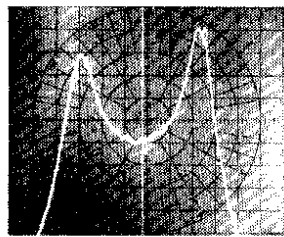

Continuous Mode. For best accuracy slow sweep until just before sampling.

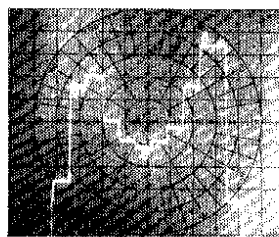

Sample Mode. Fast sweep means a small number of large samples.

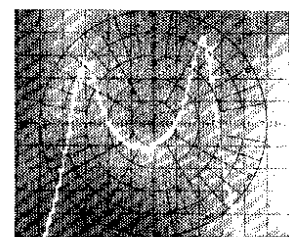

Sample Mode. For best accuracy slow to less than one second per sweep.

The maximum group delay which can be displayed depends upon the RANGE MHz selection as follows: 0.5-13, ± 80 microseconds; 0.5-130, ± 8 microseconds; and 0.5-1300, ± 800 nanoseconds and is the sum of the calibration offset value and the actual measured value.

REFLECTION MEASUREMENTS

This section describes return loss and reflection coefficient measurements. These measurements are described individually, each with separate setup, calibration, and measurement sequences. For a generalized calibration sequence for all reflection measurements, refer to the S-Parameter Measurements, General Calibration Sequence. Below is a diagram of reflection test connections using the 8502 Transmission/Reflection Test Set.

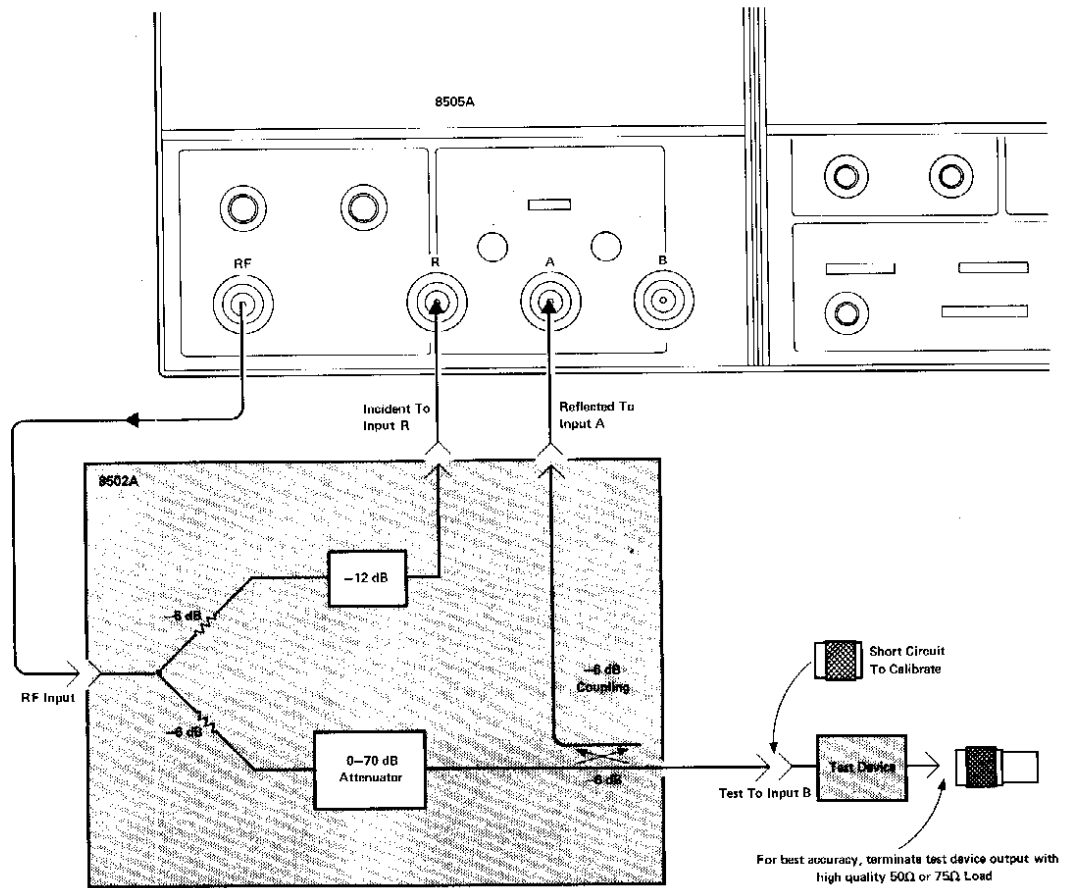

Connections to the test set and test device are made using the cables supplied in the 11851A Cable Kit. The test device input port is connected to the 8502 front panel TEST connector. For reflection calibration, connect the short circuit at the same point to which the test device will be connected. Whatever configuration is used, all cables, adapters, and fixtures required for the measurement should also be used during calibration.

RETURN LOSS

This sequence lists the steps for a typical return loss measurement.

SETUP

- Set signal levels.
- Set frequency sweep.
- Set CRT display.

MARKERS: 1, position measurement marker so FREQ COUNTER MHz reads desired calibration frequency.

CALIBRATION

- Connect short.

CHANNEL 1:

- A/R, MAG, 10 dB/division,
- MKR, ZRO (hold until display zero). 



MEASUREMENT

- Connect test device.
- Position measurement marker to read magnitude ratio (MKR + REF) and frequency.



MKR, ZRO moves marker to reference line.

Calibration for return loss sets the magnitude ratio between the reflected and reference signals to zero dB with the short circuit. After connecting the test device a negative value indicates that the reflected signal magnitude is less than the reference signal magnitude.

This figure shows a display of the return loss of a bandpass filter. The measurement marker is positioned to the minimum return loss point in the passband. The 0 dB reference line is set to the center graticule using CH1  or CH2  and no REF OFF-SET has been added, so the absolute value of the MKR reading is the return loss measured value.

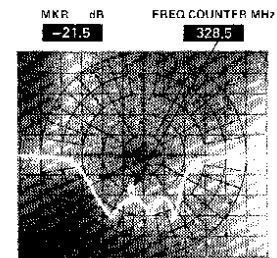

Standing wave ratio, SWR, can be calculated from the return loss measured value using the HP Reflectometer Calculator or these equations:

$$\rho = 10^{D/20} \quad \text{where } D = \frac{\text{measured value (dB)}}{20}$$

$$\text{SWR} = \frac{1 + \rho}{1 - \rho}$$

For example, if the measured magnitude ratio is -30 dB, ρ is 0.032 and the SWR is 1.07.

REFLECTION MEASUREMENTS

REFLECTION COEFFICIENT

This sequence lists the steps for a typical reflection coefficient measurement.

SETUP
 Set signal levels.
 Set frequency sweep.
 Set CRT display, polar beam center.
MARKERS: 1, position measurement marker so **FREQ COUNTER MHz** reads desired calibration frequency.

CALIBRATION
 Connect short.
CHANNEL 1:
 A/R, POLAR MAG, POLAR FULL 1,
 MKR, ZRO (hold until display zero),
ELECTRICAL LENGTH:
 A, MODE as required (usually x1 or x10), CLR if REL lighted, LENGTH and VERNIER A for smallest cluster.
CHANNEL 1:
 POLAR PHASE.
 MKR, ZRO (hold until display zero),
 REF,
 REF OFFSET so display reads ±180 degrees,
 ZRO,
 MKR.

MEASUREMENT
 Connect test device.
 Electrical length MODE (and sweep width if PHASE x10°/SCAN selected) same as calibration.
 Read $\rho \angle \phi$ at any point from polar display or:
 POLAR MAG,
 Position measurement markers to read magnitude ratio (MKR + REF) and frequency.
 Calculate ρ using

$$\rho = 10^{\frac{D}{20}} \quad \text{where } D = \frac{\text{return loss (dB)}}{20}$$

POLAR PHASE,
 Read $\angle \phi$ value (MKR + REF).

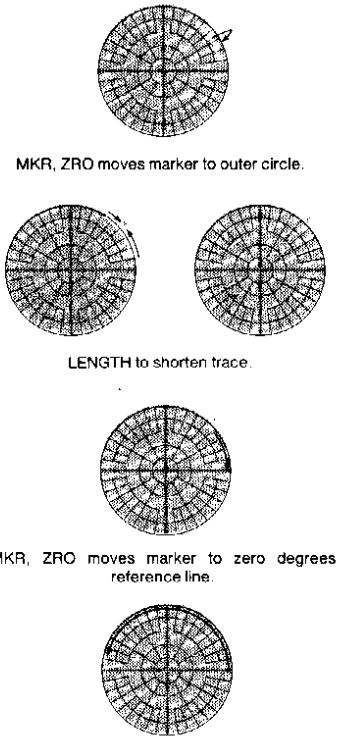
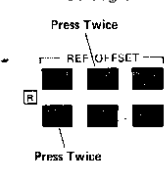
Impedance — Using Smith Chart

Impedance can be read directly from the polar display reflection coefficient by installing a Smith chart overlay. Smith chart overlays are supplied with the 8505 in four versions, 3.16, 1.0, 0.5, 0.2, and 0.1 full scale linear coefficient value of the outer circle. For the 3.16 full scale version use REF OFFSET to set the REF value to +10 dB in POLAR MAG and select POLAR FULL 1. For the other overlays, set the REF value to zero and select the POLAR FULL value corresponding to the full scale value of the Smith Chart.

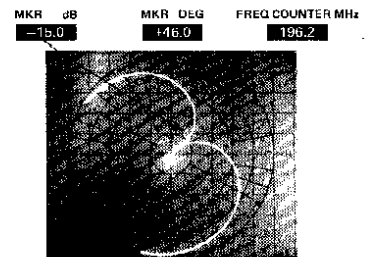

POWER LEVEL MEASUREMENTS

With the INPUT switch set to R, A, or B and the MODE switch set to MAG, the 8505 measures the absolute power level in dBm at the R, A, or B input. Some applications for this capability are: measuring and setting actual reference, reflected and transmitted signal levels into the R, A, and B inputs prior to calibration; verifying signal levels at various points in the test setup including actual incident and transmitted power; and direct measurement of losses in the test set, cables, and fixtures.

R, A, or B, MAG.

CLR (hold for 2 sec if REL lighted).

SCALE/DIV and REF OFFSET to position trace.

Position measurement marker to read measured dBm value (MKR + REF)

If desired, convert dBm to mW using

$$\text{mW} = 10^{\frac{\text{dBm}}{10}}$$

The dBm difference between an R, MAG and a B, MAG measurement may not be identical to the B/R, MAG measured value. The 8505A measures ratio values (A/R, B/R) with greater accuracy than absolute power.

S-PARAMETER MEASUREMENTS

Using the 8503A S-Parameter Test Set with the 8505A you can measure both forward and reverse transmission and reflection characteristics without disconnecting the test device. This illustration shows a typical 8505A/8503A installation. Use the 19 cm Type N cables supplied with the 8503A to connect RF, R, A, and B on the 8505A and 8503A front panels.

Be sure to connect the supplied test set interconnection cable between the 8505A TEST SET INTER-CONN connector on the rear of the signal processor and the SIGNAL PROCESSOR INTER-CONNECT connector on the rear of the 8503A test set.

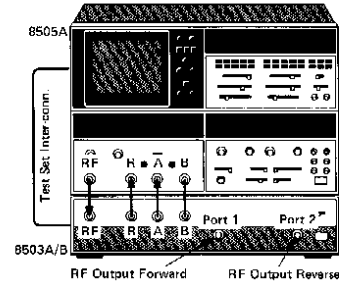

The 8503A front panel FORWARD/REVERSE control switches the incident RF to Port 1 for FORWARD or Port 2 for reverse. These illustrations show the functions of the 8505A R, A, and B connections in FORWARD and REVERSE.

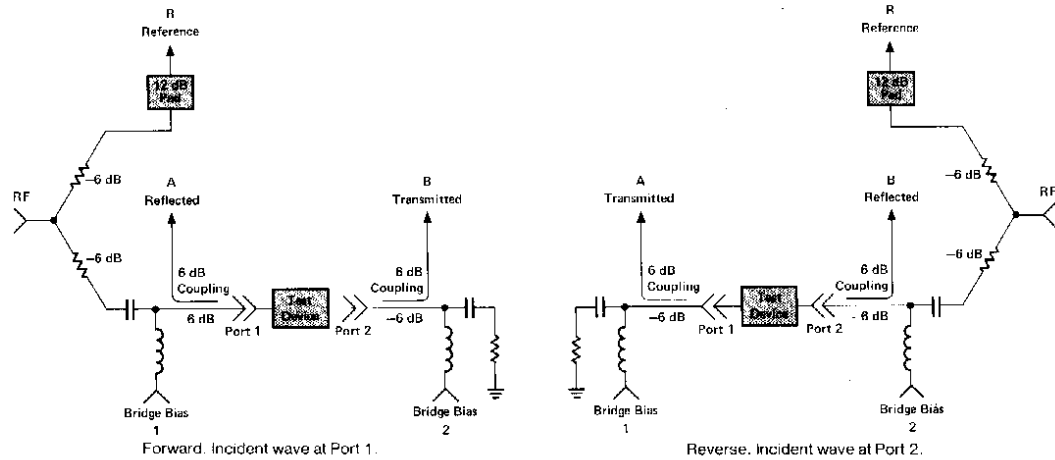

With these connections, the forward (input) and reverse (output) parameters as follows:

FORWARD

$$S_{21} = B/R = \text{Forward Transmission Coefficient}$$

$$S_{11} = A/R = \text{Input Reflection Coefficient}$$

REVERSE

$$S_{12} = A/R = \text{Reverse Transmission Coefficient}$$

$$S_{22} = B/R = \text{Output Reflection Coefficient}$$

Thus, the forward calibrations and measurements are made in exactly the same way as described in the previous Transmission and Reflection Measurements sections. For reverse measurements the 8505 A and B inputs exchange transmission and reflection functions.

Connecting the 8503A test set rear panel interconnection cable to the 8505A signal processor enables a second set of Reference Offset, Stored Reference Offset, Electrical Length Offset, and Stored Electrical Length Offset registers, allowing independent storage of forward and reverse magnitude, phase, delay, and electrical length calibrations.

S-PARAMETER MEASUREMENTS

Connections to the test device should be made using the 11857A Test Port Extension Cables or with the 11608A Transistor Fixture. As shown in the following illustrations, you may connect the test device directly to the 8503A Port 1 or Port 2. Using two cables balances the electrical length of the test set up. Connecting the device directly to the 8503A port may reduce reflection errors at one port by reducing cable and adapter reflections. Whatever configuration is used, all cables, adapters, and fixtures, required to make the measurement should also be used during calibration.

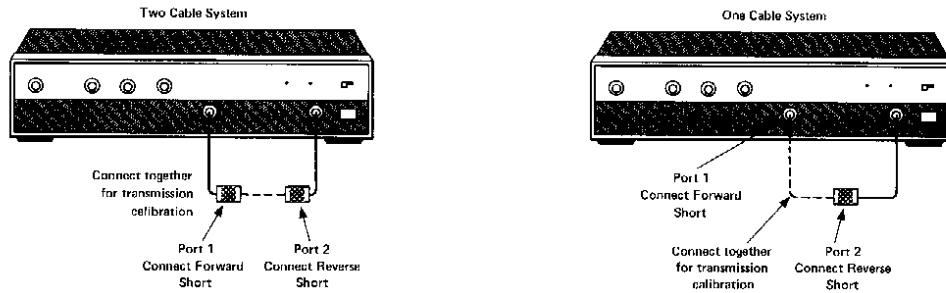

Transistor Bias

BRIDGE BIAS 1 and 2 on the 8503A rear panel provide connections for ± 30 Vdc, +200 mA bias when measuring transistors. Use a dual dc power supply, such as the HP 6205B, that is designed for use with bias tees optimized for RF applications. (The HP 8717B Transistor Bias Supply is not compatible with the 8503A; it is designed for bias tees optimized for microwave frequencies and may cause the test device to oscillate).

For common emitter configurations, bias is established by setting V_{ce} to the desired voltage then monitoring I_c as V_{be} in combination with resistor R_1 establishes the base current.

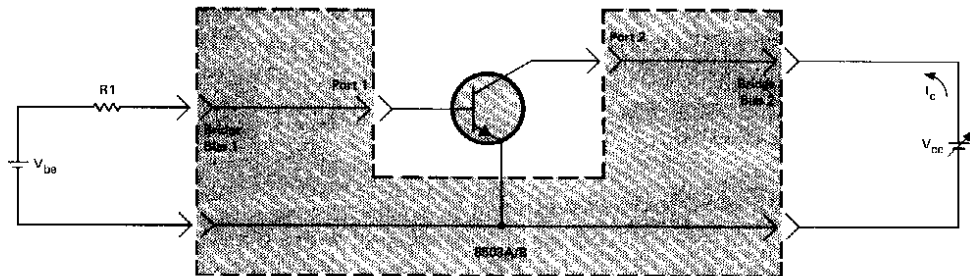

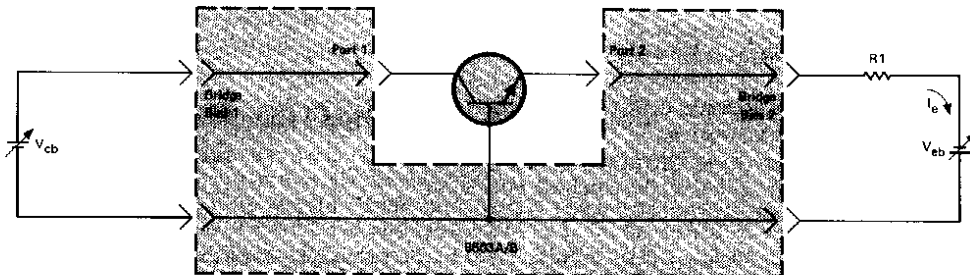

For common base configurations, bias is established by setting V_{cb} to the desired voltage then monitoring I_e as V_{cb} in combination with R_1 establishes emitter current.



S-PARAMETER MEASUREMENTS

GENERAL CALIBRATION SEQUENCE

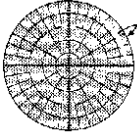
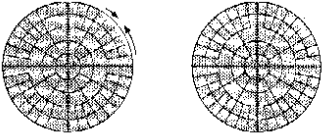
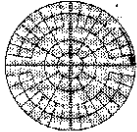
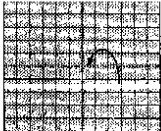
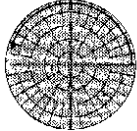
When testing most two port test devices it will probably be most convenient to perform complete forward and reverse transmission and reflection calibrations at one time. This sequence lists the steps for complete forward and reverse transmission and reflection calibration for all measurements.

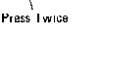
<p>SETUP Set signal levels. Set frequency sweep. Set CRT display; polar beam center.</p> <p>MARKERS: 1, position measurement marker so FREQ COUNTER MHz reads desired calibration frequency.</p> <p>FORWARD TRANSMISSION: S₂₁, Electrical Length, and Group Delay Select 8503 FORWARD Connect through.</p> <p>CHANNEL 1: B/R, POLAR MAG, POLAR FULL 1, MKR, ZRO (hold until display zero).</p> <p>ELECTRICAL LENGTH: B, MODE as required, CLR if REL lighted, LENGTH and VERNIER B for smallest cluster, ZRO.</p> <p>CHANNEL 1: POLAR PHASE, ZRO (hold until display zero), DLY, ZRO (hold until display zero).</p> <p>INPUT REFLECTION: S₁₁ Connect forward short.</p> <p>CHANNEL 1: A/R, POLAR MAG, ZRO (hold until display zero),</p> <p>ELECTRICAL LENGTH: A, CLR if REL lighted, LENGTH and VERNIER A for smallest cluster, ZRO.</p> <p>CHANNEL 1 POLAR PHASE, ZRO (hold until display zero), REF, REF OFFSET so display reads ± 180 degrees, ZRO, MKR.</p> <p>REVERSE TRANSMISSION: S₂₂ Use above FORWARD TRANSMISSION sequence except select 8503 REVERSE, change CHANNEL 1 B/R to A/R, and change ELECTRICAL LENGTH B to A.</p> <p>OUTPUT REFLECTION: S₁₂ Use above INPUT REFLECTION sequence except connect short on output port, change CHANNEL 1 A/R to B/R, and change ELECTRICAL LENGTH A to B.</p>	 <p>MKR, ZRO moves marker to outer circle.</p>  <p>LENGTH to shorten trace.</p>  <p>MKR, ZRO moves marker to zero degrees reference line.</p>  <p>MKR, ZRO moves marker to reference line.</p>  <p>REF OFFSET and REF ZRO moves marker to +180 degrees</p> <p>Press Twice</p>  <p>Press Twice</p>  <p>Press Twice</p>
---	--

S-PARAMETER MEASUREMENTS

The measured value for any of the S-Parameters can be read directly from the polar display graticule. The magnitude ratio, τ for transmission or ρ for reflection, is read from the concentric circles and the angle, ϕ , read from the radial lines. (Also see page 11).

Magnitude and phase values can also be read using the measurement marker as follows:

Position measurement marker to desired point on trace.
 Select A/R or B/R.
 Select POLAR MAG.
 Read magnitude ratio (MKR + REF).
 Calculate linear magnitude coefficient using:

$$\tau \text{ or } \rho = 10^{\frac{D}{20}} \quad \text{where } D = \frac{\text{Measured Value}}{20}$$

Select POLAR PHASE
 Read phase angle, $\angle \phi$, (MKR + REF).

The S-Parameter displayed is determined by combination of the 8503 S-PARAMETER SELECT switch and 8505 CHANNEL 1 or CHANNEL 2 INPUT switch position.

S-PARAMETER	8503A S-PARAMETER SELECT	8505A INPUT	MEASUREMENT
S_{11}	FORWARD	A/R	INPUT REFLECTION
S_{21}	FORWARD	B/R	FORWARD TRANSMISSION
S_{12}	REVERSE	A/R	REVERSE TRANSMISSION
S_{22}	REVERSE	B/R	OUTPUT REFLECTION

For a device with greater than unity gain, the transmission coefficient will exceed 1 and REF OFFSET must be added to place the full trace within the outer circle. Adding 20 dB of REF OFFSET changes the polar full values by a factor of 10 as shown.

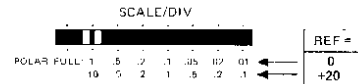

Electrical Length, Deviation from Linear Phase, Group Delay

These measurements can be made in the forward or reverse direction using the measurement sequences described in the Transmission Measurements section.

Return Loss

Return loss can be measured using FORWARD, A/R or REVERSE, B/R in either MAG or POLAR MAG mode. Refer to the Return Loss measurement sequence in the Reflection Measurements section.

Impedance — Using Smith Chart

Impedance can be read directly from the polar display of reflection coefficient (S_{11} or S_{22}) by installing a Smith Chart overlay. Smith chart overlays are supplied with the 8505A in four versions: 3.16, 1.0, 0.5, 0.2, and 0.1 full scale linear coefficient value of the outer circle. For the 3.16 full scale version use REF OFFSET to set the REF value to +10 dB in POLAR MAG and select POLAR FULL 1. For the others, set the REF value to zero and select the POLAR FULL value corresponding to the full scale value of the Smith Chart.

THE 8501A STORAGE-NORMALIZER

The 8501A provides independent processing and storage for both 8505A measurement channels. It serves as display memory for the 8505A by digitizing and storing measurement data at the 8505A sweep rate then outputting the processed trace to the CRT at a fixed display rate. Computational capabilities permit real time averaging and normalization, and the magnifier can increase display resolution. Also, key 8505A Channel 1 and 2 measurement parameters are displayed as labels on the CRT.

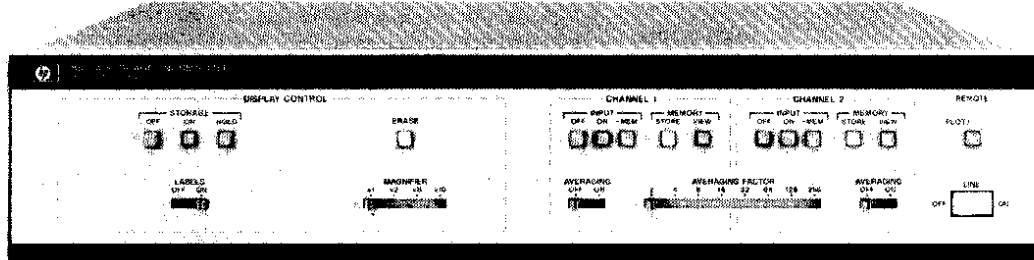

With 8501A STORAGE ON the 8501A controls all information presented on the 8505A CRT display. The MKR and REF values on the 8505A measured value displays are not affected by 8501A processing. All 8505A setup, calibration, and measurement sequences described in this note can be accomplished with STORAGE ON but the labeling interface must be connected to display the reference line or beam center. Selecting 8501A STORAGE OFF bypasses the 8501A and returns the 8505A CRT to conventional analog operation.

To familiarize yourself with operation of the 8501A make these control settings then proceed with the following paragraphs:

STORAGE OFF, LABELS OFF, MAGNIFIER X1,
Channel 1 and Channel 2 INPUT OFF, MEMORY VIEW OUT, AVERAGING OFF.

Digital Storage

When the device response characteristic requires a slow sweep to avoid distortion of the measurement, select

STORAGE ON,
Channel 1 and/or Channel 2 INPUT ON.

Cartesian traces are digitized at 500 frequency points on the X axis and 500 points on the Y axis, with $\pm 50\%$ overrange on the Y axis available to digitize an off-scale trace. Similarly, polar traces are digitized at 250 frequency points with $\pm 50\%$ overrange for both the X and Y axis. Changing the reference line or beam center position away from the middle of the CRT moves off-scale points onto the display.

INPUT OFF blanks the Channel 1 or Channel 2 trace. STORAGE HOLD freezes the CRT display for photography or further analysis and memory is not updated with new data on subsequent sweeps. ERASE completely clears 8501A memory of all stored information.

Labels

Select LABELS ON. Sweep mode and frequencies appear at the bottom of the CRT and measurement mode selections, including the MKR value, appear at the top of the CRT. 8505A Channel 1 and/or Channel 2 MODE switches must be set to other than OFF for the labels to appear.

Averaging

Both accuracy and resolution are improved when averaging is used to remove random noise variations from measurements. To use averaging, select

ERASE (momentary),
Channel 1 and/or Channel 2 AVERAGING ON,
AVERAGING FACTOR as required.

8501A averaging acts as a "digital" video filter, performing an exponential running average on the data at each frequency point. The current trace has the weight $1-1/n$ and the new trace has the weight $1/n$ where n is the selected AVERAGING FACTOR. Select an averaging factor appropriate for the sweep rate and degree of signal-to-noise improvement desired, noting that $2n$ sweeps are required to converge to 86% of the final value and $4n$ sweeps are required to reach 98%. Signal-to-noise improvement increases with \sqrt{n} .

These CRT photos illustrate the improvement in group delay measurement accuracy obtained by averaging.

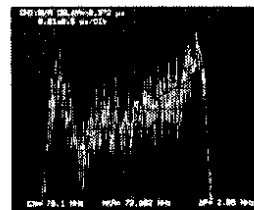

Noisy Group Delay Measurement

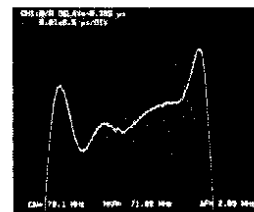

After Averaging

Magnification

High resolution displays at up to 0.01 dB, 0.1 degree, and 0.1 nanosecond per division are accomplished using the MAGNIFIER switch to expand the 8505A SCALE/DIV selection. For example, with 0.1 dB/division set at the 8505A and MAGNIFIER X10 selected, the CRT display resolution is 0.01 dB/division. The data stored in memory is amplified prior to display and the MAGNIFIER expands the trace about the reference line or beam center position. Frequency response of a cable using a 500 MHz sweep width and 0.01 dB/division is shown in this display. Digitizer resolution produces the step effect; each step represents a 0.002 dB change.

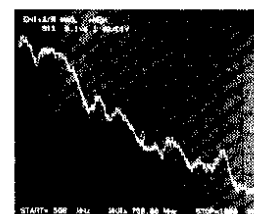

Passband Ripple at 0.01 dB/division using x10 magnification

Normalization

Normalization is the process of storing a reference trace in memory and then automatically subtracting the reference trace from the incoming trace and displaying the difference. Typical applications are to remove frequency response characteristics of the test setup from the measurement or to make a comparison measurement in which the test device is matched to a standard. Normalization is independent for Channel 1 and Channel 2 and is ordinarily used only for cartesian displays. To normalize:

Connect standard (open, short, through, or standard device),
8505A SCALE/DIV same as for measurement,
MEMORY STORE (momentary),
INPUT—MEM,
Connect test device.

When MEMORY STORE is pressed, the displayed trace is transferred to reference memory. Selecting INPUT-MEM displays the difference between the reference trace and the current trace, resulting in a flat trace at the reference line if the reference trace and the current trace are identical.

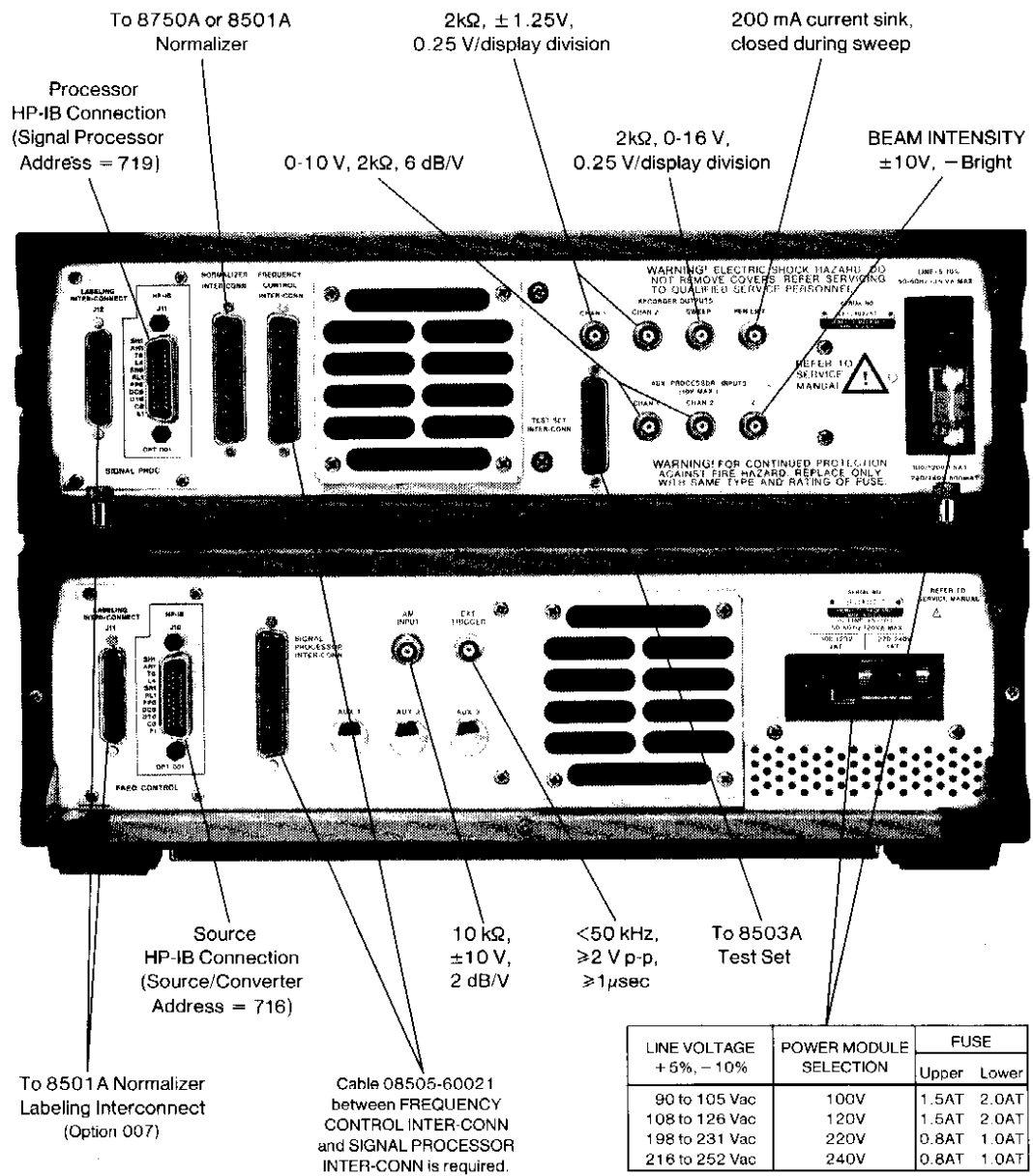

8505A Rear Panel Connections

CONTROLS AND DISPLAYS SUMMARY

CRT DISPLAY — The response of both measurement channels can be displayed simultaneously with magnitude and phase response displayed in either cartesian or polar format.

BEAM CONTROLS — Independent cartesian reference line position controls for each channel, beam center for both channels, and standard controls for beam and scale.

IF and VIDEO BANDWIDTH — Select either 10 kHz or 1 kHz IF bandwidth, and 30 Hz post detection video filter to smooth trace.

SWEEPER OUTPUT — Sweeper output at RF connector is sum of step attenuator and VERNIER settings.

REFERENCE AND TEST INPUTS - Three identical inputs for absolute or ratio measurements. Each input has a measurement range from -10 dBm to -110 dBm. Slide switch selects maximum input level applied at R, A, and B inputs for linear operation. OVERLOAD indicators above inputs light when level exceeded.

FREQUENCY SCAN CONTROLS AND DISPLAYS — RANGE MHz selects frequency range. MODE selects log and linear scans of full range or linear expanded scans selected by WIDTH. With MODE in LOG FULL or LIN FULL, WIDTH selections display down-pointing markers to identify end points of stored frequency displayed by the FREQUENCY MHz displays and set by the FREQUENCY controls. Moving MODE to LIN EXPAND selects the frequency stored for the WIDTH selection.

MEASUREMENT MARKERS — The rotary MARKERS switch selects measurement marker 1 through 5. The adjacent numbered vernier controls marker position on trace. The FREQ COUNTER MHz display is blank when the measurement is not accurate. At positions 2 through 5, deselected markers point down, the selected marker points up.

FREQUENCY COUNTER — Displays frequency of measurement marker selected by MARKERS. Resolution is controlled by RANGE MHz and SCAN TIME SEC. OVERFLOW indicates one or more most significant digits are shifted off left of display. Select fast scan time to inspect most significant digits, and slower scan time to inspect least significant digits.

ELECTRICAL LENGTH — Display shows equivalent electrical length or linear insertion phase added to reference channel to equalize electrical length in reference and A and B test signal paths depending upon INPUT and MODE selections. LENGTH buttons increment the displayed value. CLR (momentary) zeros display; CLR (hold until REL out) clears stored calibration; ZRO stores displayed value as calibration and zeros display.

CHANNEL 1 and CHANNEL 2 — Two identical, independent measurement channels. INPUT and MODE select measurement trace displayed on CRT. LED displays show the reference line value (REF button pressed), or measurement marker displacement from reference line (MKR button pressed). Measured value at marker is sum of REF and MKR values. REF OFFSET buttons increment the reference line value stored in separate magnitude, phase, and delay reference offset registers for each channel. CLR (momentary) resets the reference line value to zero; CLR (held until REL out) clears stored reference offset calibration. ZRO stores the calibration reference offset for selected measurement.

CONTROLS AND DISPLAYS

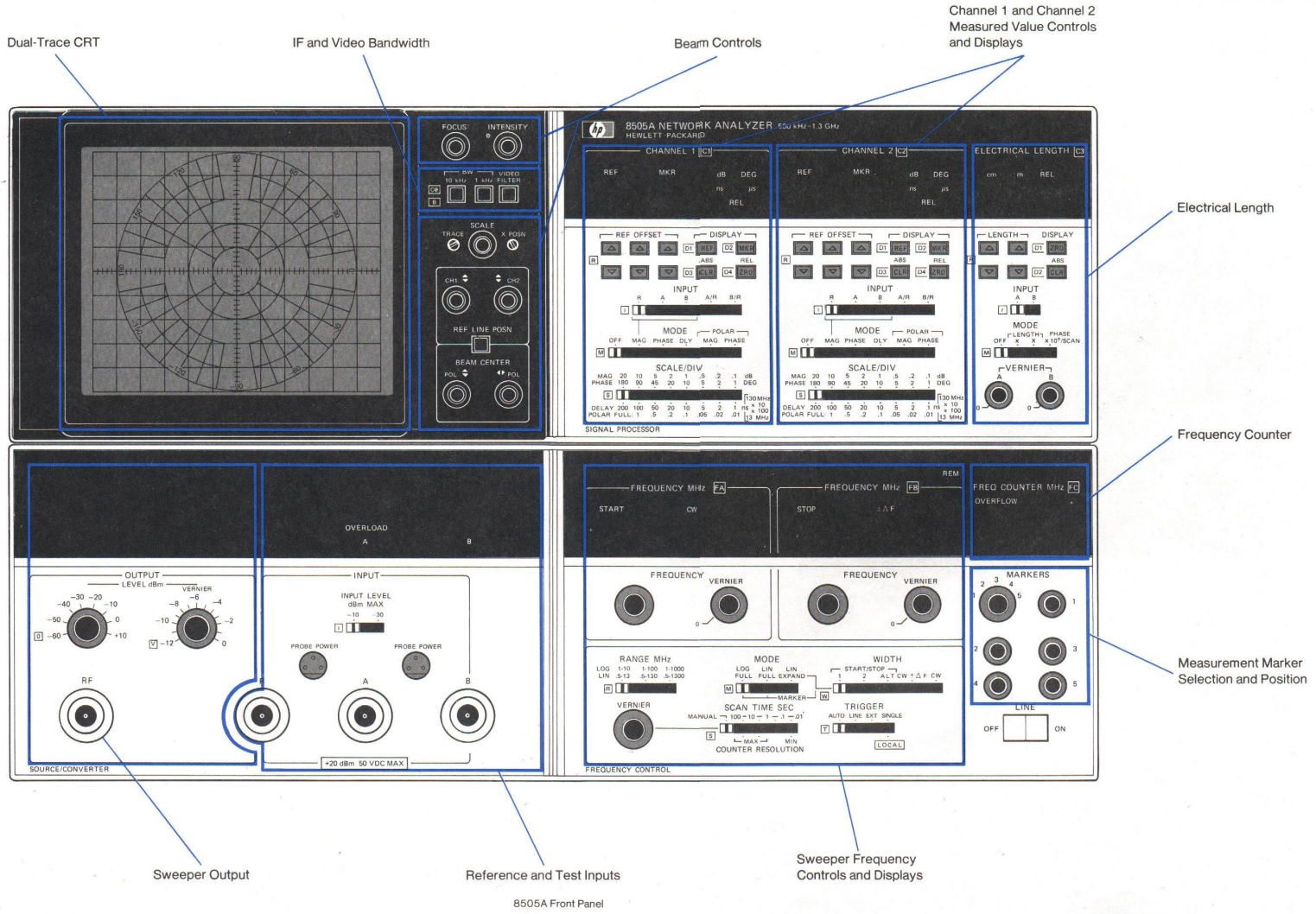

8505A Front Panel