



Advanced Test Equipment Rentals
www.atecorp.com 800-404-ATEC (2832)

GS610
Source Measure Unit

USER'S MANUAL

Product Registration

Thank you for purchasing YOKOGAWA products.

YOKOGAWA provides registered users with a variety of information and services.

Please allow us to serve you best by completing the product registration form accessible from our homepage.

<http://tmi.yokogawa.com/>

Thank you for purchasing the GS610 Source Measure Unit.

This user's manual contains useful information about the instrument's functions and operating procedures and lists the handling precautions of the GS610. To ensure correct use, please read this manual thoroughly before beginning operation. After reading the manual, keep it in a convenient location for quick reference whenever a question arises during operation.

Manual Title	Manual No.	Description
GS610 Source Measure Unit User's Manual	IM 765501-01E	This manual. Explains all the functions of the GS610 and their operating procedures.

Notes

- The contents of this manual are subject to change without prior notice as a result of continuing improvements to the instrument's performance and functions. The figures given in this manual may differ from those that actually appear on your screen.
- Every effort has been made in the preparation of this manual to ensure the accuracy of its contents. However, should you have any questions or find any errors, please contact your nearest YOKOGAWA dealer.
- Copying or reproducing all or any part of the contents of this manual without the permission of Yokogawa Electric Corporation is strictly prohibited.
- The TCP/IP software of this product and the document concerning the TCP/IP software have been developed/created by YOKOGAWA based on the BSD Networking Software, Release 1 that has been licensed from the University of California.

Trademarks

- Microsoft, Internet Explorer, MS-DOS, Windows, Windows NT, and Windows XP are either registered trademarks or trademarks of Microsoft Corporation in the United States and/or other countries.
- Adobe, Acrobat, and PostScript are trademarks of Adobe Systems Incorporated.
- For purposes of this manual, the TM and ® symbols do not accompany their respective trademark names or registered trademark names.
- Other company and product names are trademarks or registered trademarks of their respective holders.

Revisions

- 1st edition: August 2005
- 2nd edition: January 2009

Checking the Contents of the Package

Unpack the box and check the contents before operating the instrument. If some of the contents are not correct or missing or if there is physical damage, contact the dealer from which you purchased them.

GS610

Check that the model name and suffix code given on the name plate on the side panel match those on your order.

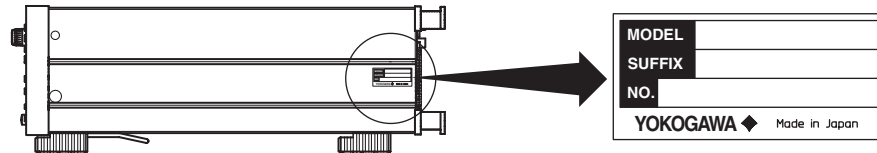

MODEL and SUFFIX Codes

Model	Suffix Code	Description
765501	100-240 VAC	
Power cord	-D	UL/CSA Standard Power Cord (Part No.: A1006WD) [Maximum rated voltage: 125 V; Maximum rated current: 7A]
	-F	VDE Standard Power Cord (Part No.: A1009WD) [Maximum rated voltage: 250 V; Maximum rated current: 10 A]
	-Q	BS Standard Power Cord (Part No.: A1054WD) [Maximum rated voltage: 250 V; Maximum rated current: 10 A]
	-R	AS Standard Power Cord (Part No.: A1024WD) [Maximum rated voltage: 250 V; Maximum rated current: 10 A]
	-H	GB Standard Power Cord (Part No.: A1064WD) [Maximum rated voltage: 250 V; Maximum rated current: 10 A]
Options	/C10	Ethernet interface

NO.(Instrument Number)

When contacting the dealer from which you purchased the instrument, please give them the instrument number.

Standard Accessories

The standard accessories below are supplied with the instrument.

Name	Model /Part No.	Qty.	Notes
Power cord	A1006WD	1	UL/CSA Standard Power Cord Maximum rated voltage: 125 V; Maximum rated current: 7A
	A1009WD	1	VDE Standard Power Cord Maximum rated voltage: 250 V; Maximum rated current: 10 A
	A1054WD	1	BS Standard Power Cord Maximum rated voltage: 250 V; Maximum rated current: 10 A
	A1024WD	1	AS Standard Power Cord Maximum rated voltage: 250 V; Maximum rated current: 10 A
	A1064WD	1	GB Standard Power Cord Maximum rated voltage: 250 V; Maximum rated current: 10 A
Rubber Feet	A9088ZM	2	Two rubber feet in one set
Measurement lead	758933	1	
Alligator clip adapter	758922	1 set	Safety terminal-to-alligator clip adapter. Red and black, 1 pc. each
D-sub connector for External I/O	A1519JD/ B8060KA	1 set	1 connector cover, 1 15-pin connectocer
User's Manual	IM765501-01E	1	This manual

One of these power cords is supplied according to the suffix code.

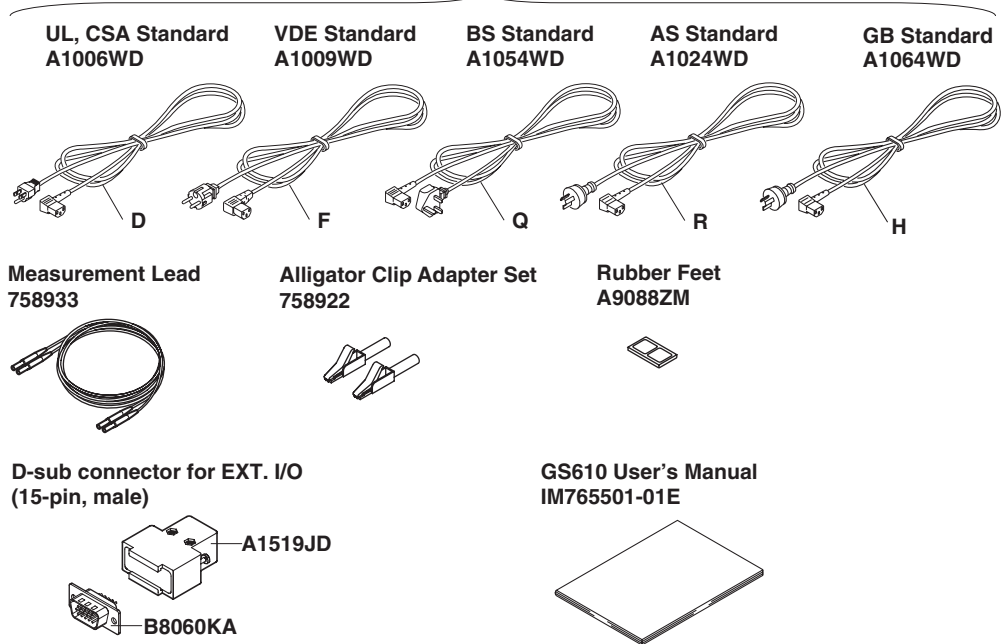

Checking the Contents of the Package

Optional Accessories (Sold Separately)

The optional accessories below are available for purchase separately.

Name	Part Number	Minimum Q'ty	Notes
Measurement lead	758917	1	Safety terminal cable. Length: 0.75 m
Measurement lead	758933	1	Safety terminal banana male. Length: 0.75 m
Safety adapter lead	701901	1	BNC-to-safety terminal cable Length: 1.8 m
Banana plug set	758919	1 set	φ4 mm plug/φ4 mm socket combined adapter. Red and black, 1 pc. each
Alligator clip adapter (small)	758922	1 set	Safety terminal-to-alligator clip adapter. Red and black, 1 pc. each
Alligator clip adapter (large)	758929	1 set	Safety terminal-to-alligator clip adapter. Red and black, 1 pc. each
Safety terminal adapter	758923	1 set	Spring clamp type. Red and black, 1 pc. each
Safety terminal adapter	758931	1 set	Screw-in type. Red and black, 1 pc. each
Safety mini-clip	701959	1 set	Safety terminal-to-mini clip adapter. Red and black, 1 pc. each
Fork terminal adapter	758921	1 set	Safety terminal-to-fork terminal adapter. Red and black, 1 pc. each
Conversion adapter	758924	1	BNC-to-binding post adapter
Safety BNC cable	701902	1	BNC-BNC, length: 1 m
Safety BNC cable	701903	1	BNC-BNC, length: 2 m
D-sub connector for External I/O	A1519JD/ B8060KA	1 set	1 connector cover, 1 15-pin connectocer

Safety Precautions

This instrument is an IEC safety class I instrument (provided with a terminal for protective earth grounding).

The general safety precautions described herein must be observed during all phases of operation. If the instrument is used in a manner not specified in this manual, the protection provided by the instrument may be impaired. Yokogawa Electric Corporation assumes no liability for the customer's failure to comply with these requirements.

The following symbols are used on this instrument.



Warning: handle with care. Refer to the user's manual or service manual. This symbol appears on dangerous locations on the instrument which require special instructions for proper handling or use. The same symbol appears in the corresponding place in the manual to identify those instructions.)



Alternating current



ON (power)



OFF (power)



ON (power) state



OFF (power)

Be sure to observe with the precautions below. Not complying might result in injury or death.

WARNING

- **Use the Correct Power Supply**
Before connecting the power cord, ensure that the source voltage matches the rated supply voltage of the instrument and that it is within the maximum rated voltage of the provided power cord.
 - **Use the Correct Power Cord and Plug**
To prevent the possibility of electric shock or fire, be sure to use the power cord supplied by YOKOGAWA. The main power plug must be plugged into an outlet with a protective earth terminal. Do not disable this protection by using an extension cord without protective earth grounding.
 - **Connect the Protective Grounding Terminal**
Make sure to connect the protective earth to prevent electric shock before turning ON the power. The power cord that comes with the instrument is a three-prong type power cord. Connect the power cord to a properly grounded three-prong outlet.
 - **Do Not Impair the Protective Grounding**
Never cut off the internal or external protective grounding wire or disconnect the wiring of the protective grounding terminal. Doing so poses a potential shock hazard.
 - **Do Not Operate with Defective Protective Grounding or Fuse**
Do not operate the instrument if the protective earth or fuse might be defective. Also, make sure to check them before operation.
 - **Do Not Operate in an Explosive Atmosphere**
Do not operate the instrument in the presence of flammable liquids or vapors. Operation in such an environment constitutes a safety hazard.
 - **Do Not Remove Covers**
The cover should be removed by YOKOGAWA's qualified personnel only. Opening the cover is dangerous, because some areas inside the instrument have high voltages.
 - **Ground the Instrument before Making External Connections**
Securely connect the protective grounding before connecting to the item under measurement or to an external control unit.
If you are going to touch the circuit, make sure to turn OFF the circuit and check that no voltage is present.
-

Waste Electrical and Electronic Equipment



Waste Electrical and Electronic Equipment (WEEE), Directive 2002/96/EC

(This directive is only valid in the EU.)

This product complies with the WEEE Directive (2002/96/EC) marking requirement. This marking indicates that you must not discard this electrical/electronic product in domestic household waste.

Product Category

With reference to the equipment types in the WEEE directive Annex 1, this product is classified as a "Monitoring and Control instrumentation" product.

Do not dispose in domestic household waste. When disposing products in the EU, contact your local Yokogawa Europe B. V. office.

Conventions Used in This Manual

Safety Markings

The following markings are used in this manual.



Improper handling or use can lead to injury to the user or damage to the instrument. This symbol appears on the instrument to indicate that the user must refer to the user's manual for special instructions. The same symbol appears in the corresponding place in the user's manual to identify those instructions. In the manual, the symbol is used in conjunction with the word "WARNING" or "CAUTION."

WARNING

Calls attention to actions or conditions that could cause serious or fatal injury to the user, and precautions that can be taken to prevent such occurrences.

CAUTION

Calls attentions to actions or conditions that could cause light injury to the user or damage to the instrument or user's data, and precautions that can be taken to prevent such occurrences.

Note

Calls attention to information that is important for proper operation of the instrument.

Subheadings

On pages that describe the operating procedures in chapters 3 through 17 and appendix, the following symbols are used to distinguish the procedures from their explanations.

Procedure

Follow the numbered steps. All procedures are written with inexperienced users in mind; experienced users may not need to carry out all the steps.

Explanation

This subsection describes the setup parameters and the limitations on the procedures. It may not give a detailed explanation of the function. For a detailed explanation of the function, see chapter 2.

<<Corresponding Command Mnemonic>>

Indicates a communication command that corresponds to the function described on the procedural explanation page.

Displayed Characters and Terminology Used in the Procedural Explanations

Panel Keys and Rotary Knob

Bold characters used in the procedural explanations indicate characters that are marked on the panel key or the rotary knob.

SHIFT+Key

SHIFT+key means you will press the SHIFT key to turn ON the SHIFT key followed by the operation key. In this state, the items marked in purple characters below the keys are controlled.

Contents

Checking the Contents of the Package	ii
Safety Precautions	v
Waste Electrical and Electronic Equipment	vii
Conventions Used in This Manual	viii
Chapter 1 Part Names and Functions	
1.1 Front Panel	1-1
1.2 Rear Panel	1-2
1.3 Names and Description of the Displayed Contents	1-3
1.4 Key Groups and Menus	1-5
Chapter 2 Explanation of Functions	
2.1 System Configuration and Block Diagram	2-1
2.2 Source Measure Cycle	2-3
2.3 Source	2-5
2.4 Measurement	2-10
2.5 Triggers	2-13
2.6 Sweep	2-14
2.7 Computation	2-17
2.8 Store and Recall (Statistical Computation Value Display)	2-19
2.9 USB Storage Function	2-20
2.10 Other Functions	2-22
Chapter 3 Instrument Preparation and Common Operations	
3.1 Handling Precautions	3-1
3.2 Installing the GS610	3-3
3.3 Connecting to the Power Supply	3-6
3.4 Turning the Power Switch ON/OFF	3-7
3.5 Wiring Precautions	3-8
3.6 Setting the Power Frequency	3-9
3.7 Setting the Date, Time, and the Time Difference from GMT (Greenwich Mean Time) ...	3-10
3.8 Basic Operation of Keys and Rotary Knob	3-12
3.9 Entering Values	3-14
Chapter 4 Trigger Setting, Connection Type (Remote Sense and Local Sense), and USB Storage Function	
4.1 Setting the Trigger	4-1
4.2 Connection Type (Remote Sense and Local Sense)	4-3
4.3 USB Storage Function	4-5
Chapter 5 Source	
5.1 Switching the Source Function	5-1
5.2 Setting the Source Range Setting	5-2
5.3 Setting the Limiter	5-4
5.4 Setting the DC Source Mode	5-6
5.5 Setting the Pulse Source Mode	5-8
5.6 Setting the Source Delay	5-11
5.7 Turning the Output ON/OFF	5-13
5.8 Zero Generation	5-14
5.9 Offset Calibration	5-16

Chapter 6 Sweep

6.1 Setting the Linear or Log Sweep 6-1
 6.2 Setting the Program Sweep 6-5
 6.3 Selecting the Termination Mode 6-7
 6.4 Setting the Repeat Count 6-9
 6.5 Starting the Sweep Operation 6-10
 6.6 Program Pattern File 6-11

Chapter 7 Measurement

7.1 Turning the Measurement ON/OFF 7-1
 7.2 Selecting the Measurement Function 7-2
 7.3 Turning ON/OFF the Auto Range function of the Measurement Range Settings 7-3
 7.4 Setting the Measurement Delay 7-4
 7.5 Setting the Integration Time 7-6
 7.6 Auto Zero Function 7-7
 7.7 Turning Auto V/I ON/OFF 7-8

Chapter 8 Computation

8.1 Averaging 8-1
 8.2 NULL Computation 8-3
 8.3 Computation Using Equations 8-4
 8.4 Comparison Operation 8-7
 8.5 User-Defined Computation 8-9

Chapter 9 Storing Measured Results and Recalling Statistical Computation Values

9.1 Storing the Measured Results 9-1
 9.2 Recalling Statistical Computation Values 9-4

Chapter 10 BNC Input/Output and External Input/Output

10.1 Setting the Input/Output Signals of the BNC Input/Output Terminal and the External Input/Output Connector 10-1
 10.2 Synchronized Operation 10-7

Chapter 11 Other Functions

11.1 Saving the Setup Data 11-1
 11.2 Loading the Setup Data 11-3
 11.3 Selecting the Settings Applied at Power ON 11-4
 11.4 Turning the Beep Sound ON/OFF 11-5
 11.5 Displaying the Error Log 11-6
 11.6 Selecting the Display Brightness and Turning the Display OFF 11-7
 11.7 Key Lock 11-8
 11.8 Selecting the Decimal Point and Separator Notations of CSV Files 11-9

Chapter 12 Ethernet Interface (Option)

12.1 Ethernet Interface Functions and Specifications 12-1
 12.2 Connecting to the Network 12-2
 12.3 Setting the TCP/IP 12-3
 12.4 Checking the Ethernet Settings 12-6
 12.5 Web Server Function 12-7

Chapter 13 GP-IB Communications

13.1 About the IEEE.488.2-1992 Standard 13-1

13.2 GP-IB Interface Functions and Specifications 13-3

13.3 Connecting the GP-IB Cable 13-4

13.4 Setting the GP-IB Address 13-5

13.5 Responses to Interface Messages 13-6

Chapter 14 RS-232 Communications

14.1 RS-232 Interface Functions and Specifications 14-1

14.2 Serial (RS-232) Interface Connection 14-2

14.3 Handshaking Method 14-4

14.4 Combination of Data Formats 14-5

14.5 Setting the RS-232 Interface 14-6

Chapter 15 USB Interface

15.1 USB Interface Functions and Specifications 15-1

15.2 Selecting the USB Interface Function 15-2

Chapter 16 Communication Commands

16.1 Program Format 16-1

16.1.1 Symbols Used in the Syntax 16-1

16.1.2 Messages 16-1

16.1.3 Commands 16-3

16.1.4 Responses 16-5

16.1.5 Data 16-5

16.2 Commands 16-6

16.2.1 A List of Commands 16-6

16.2.2 Output Commands (OUTPut Group) 16-14

16.2.3 Source Commands (SOURce GRoup) 16-15

16.2.4 Sweep Commands (SWEep Group) 16-23

16.2.5 Measurement Commands (SENSe GRoup) 16-24

16.2.6 Trigger Commands (TRIGger Group) 16-26

16.2.7 Computation Commands (CALCulate Group) 16-27

16.2.8 Store/Recall Commands (TRACe Group) 16-29

16.2.9 External Input/Output Commands (ROUTe Group) 16-31

16.2.10 System Commands (SYSTem Group) 16-34

16.2.11 Measured Value Read Commands (INITiate, FETCh, and READ Group) 16-38

16.2.12 Status Commands (STATus Group) 16-39

16.2.13 Common Command Group 16-40

16.3 Status Reports 16-42

16.3.1 Overview of the Status Report 16-42

16.3.2 Status Byte 16-43

16.3.3 Standard Event Register 16-44

16.3.4 Source Event Register 16-46

16.3.5 Measure Event Register 16-47

16.3.6 Output Queue and Error Queue 16-48

16.4 Sample Programs 16-49

16.4.1 Before Programming 16-49

16.4.2 GP-IB Access Function 16-50

16.4.3 Sample 1 (Example of Reading the Measured Results during Free Run Using Internal Trigger) 16-53

1

2

3

4

5

6

7

8

9

10

11

12

13

14

15

16

17

18

App

Index

16.4.4	Sample 2 (Example of generating a trigger from the PC and reading the measured results)	16-55
16.4.5	Sample 3 (Example of Updating the Source Level from a PC)	16-57
16.4.6	Sample 4 (Example of Updating the Source Level with the Sweep Function)	16-59
16.4.7	Sample 5 (Example of Carrying Out the Storage Function and Reading the Statistical Values)	16-62
16.5	ASCII Character Codes	16-63

Chapter 17 Troubleshooting and Maintenance

17.1	Troubleshooting	17-1
17.2	Error Code Description and Corrective Action	17-3
17.3	Self Test	17-6
17.4	Checking the System Status	17-8
17.5	Updating the System Firmware	17-9
17.6	Recommended Replacement Parts	17-11

Chapter 18 Specifications

18.1	Source Section	18-1
18.2	Measurement Section	18-3
18.3	Functions	18-4
18.4	External Input/Output Section (TRIG/SWEEP/CTRL IN and OUT)	18-5
18.5	Interface	18-5
18.6	General Specifications	18-6
18.7	External Dimensions	18-9

Appendix

Appendix 1	Computation Definition Specifications	App-1
Appendix 2	Application Examples	App-6
Appendix 3	Contents of the Factory Default Setup File (Default.txt)	App-18

Index

1.1 Front Panel

Remote indicator

Illuminates when the GS610 is in remote mode (controlled via communications).
See sections 13.2 and 14.1.

KEY LOCK indicator

Illuminates when key lock is ON.
See section 11.7.

Remote sense indicator

Illuminates when remote sense (four-terminal connection).
See section 4.2.

Average indicator

Illuminates when averaging is ON. See section 8.1.

Display.

See section 1.3.

Soft keys

Used to select items on the soft key menu that appears when setting up the GS610. See section 3.8.

Rotary knob, numeric keys, and cursor keys

Used to set values and select setup data or items.
See sections 3.8 and 3.9.

Output terminal

Connect the measurement lead that comes with the package.
See sections 3.5 and 4.2.

Power switch.

See section 3.4.

Handle

Used when carrying the GS610.
See section 3.1.

Setup and execution keys

Keys used to change the settings or carry out an operation.
Press a setup key to show the respective setup item.
See sections 1.4 and 3.9.

SHIFT key

The keys enter the shifted state when you press the SHIFT key and the SHIFT key illuminates. In this state, the items marked in purple characters below the keys are controlled.

ESC (DISPLAY) key

Used to clear the soft key menu.
See section 3.8.

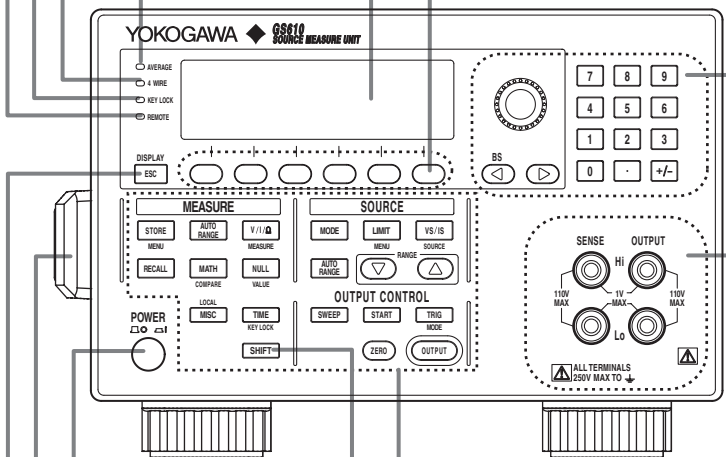

1.2 Rear Panel

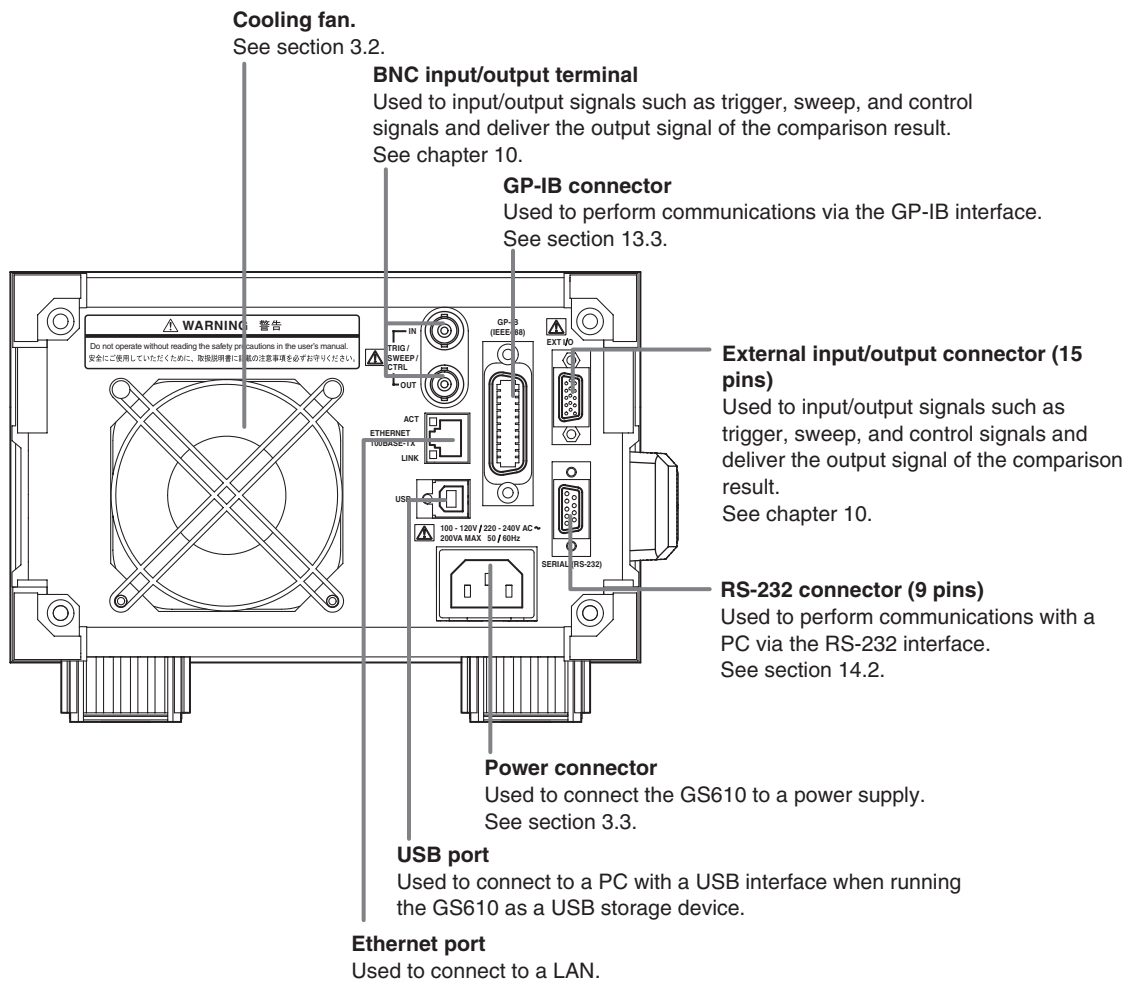

1.3 Names and Description of the Displayed Contents

The contents shown on the display are as follows:

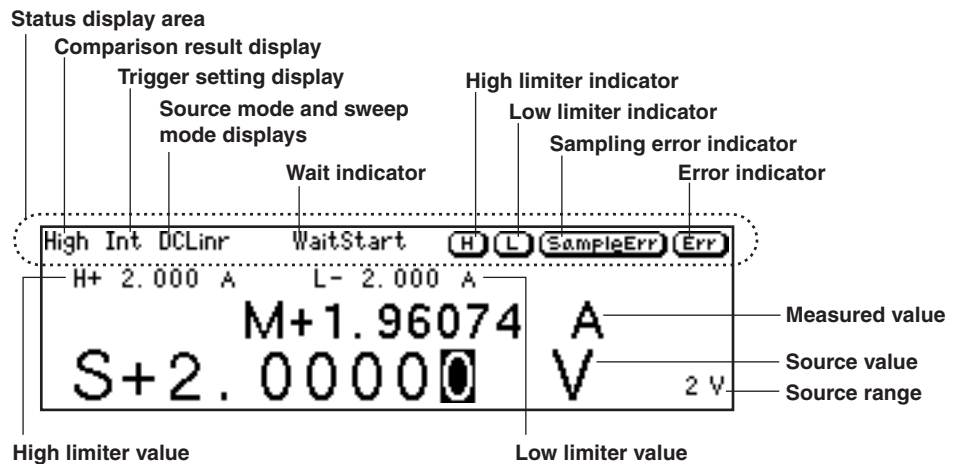

Information Shown in the Status Display Area

Comparison Result Display (For the procedures, see section 8.4)

Displays the judgement result of the comparison.

- High: Over the upper limit
- In: Within the limits
- Low: Under the lower limit

Trigger Mode Display (For the procedures, see section 4.1)

Displays the selected trigger mode.

- Int: Internal trigger
- Ext: External trigger
- Imm: Immediate (no trigger wait)

Source Mode and Sweep Mode Displays (For the procedures, see sections 5.4, 5.5, 6.1, and 6.2)

Displays the combination of the source mode and sweep mode. The following eight combinations are available.

- DC: DC source
- Pls: Pulse source
- DCLinr: Source mode = DC and sweep mode = Linear
- DCLog: Source mode = DC and sweep mode = Log
- DCProg: Source mode = DC and sweep mode = Program
- PlsLinr: Source mode = pulse and sweep mode = Linear
- PlsLog: Source mode = pulse and sweep mode = Log
- PlsProg: Source mode = pulse and sweep mode = Program

Wait Indicator (For the procedures, see section 2.5 and 6.5)

Displays the various wait conditions during operation.

- WaitTrigger: Waiting for trigger
- WaitStart: Waiting for sweep start
- Calculating: Calculating sweep data

1.3 Names and Description of the Displayed Contents

High Limiter Indicator (For the procedures, see section 5.3)

Turns ON when the high limiter is active.

Low Limiter Indicator (For the procedures, see section 5.3)

Turns ON when the low limiter is active.

Sampling Error Indicator (For the procedures, see section 2.5)

Turns ON when the trigger timing is not synchronized to the source measure cycle period (the starting point) such as when a trigger is activated in the middle of a source measure cycle.

Error Indicator (For the procedures, see section 11.5)

Turns ON when there is one or more errors in the error memory.

1.4 Key Groups and Menus

There are four functional key groups on the GS610. This section introduces each key group in a tree format.

Viewing the Tree Structure

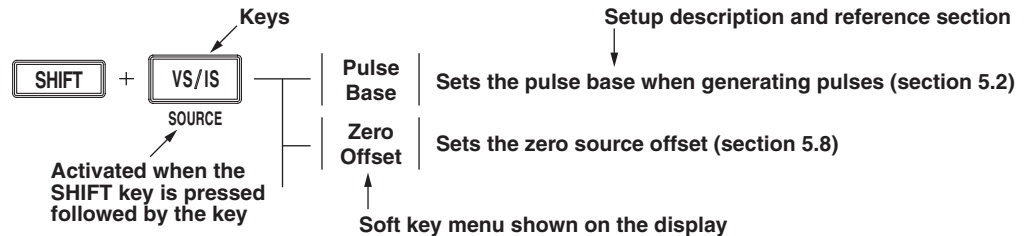

SOURCE Group

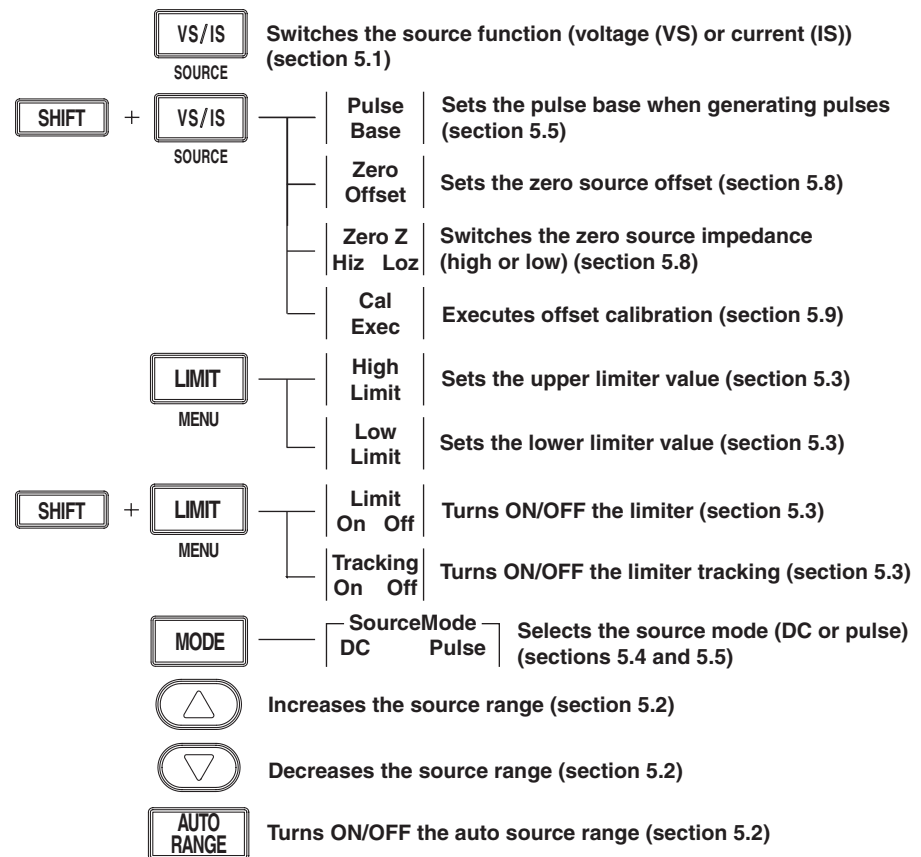

1.4 Key Groups and Menus

MEASURE Group

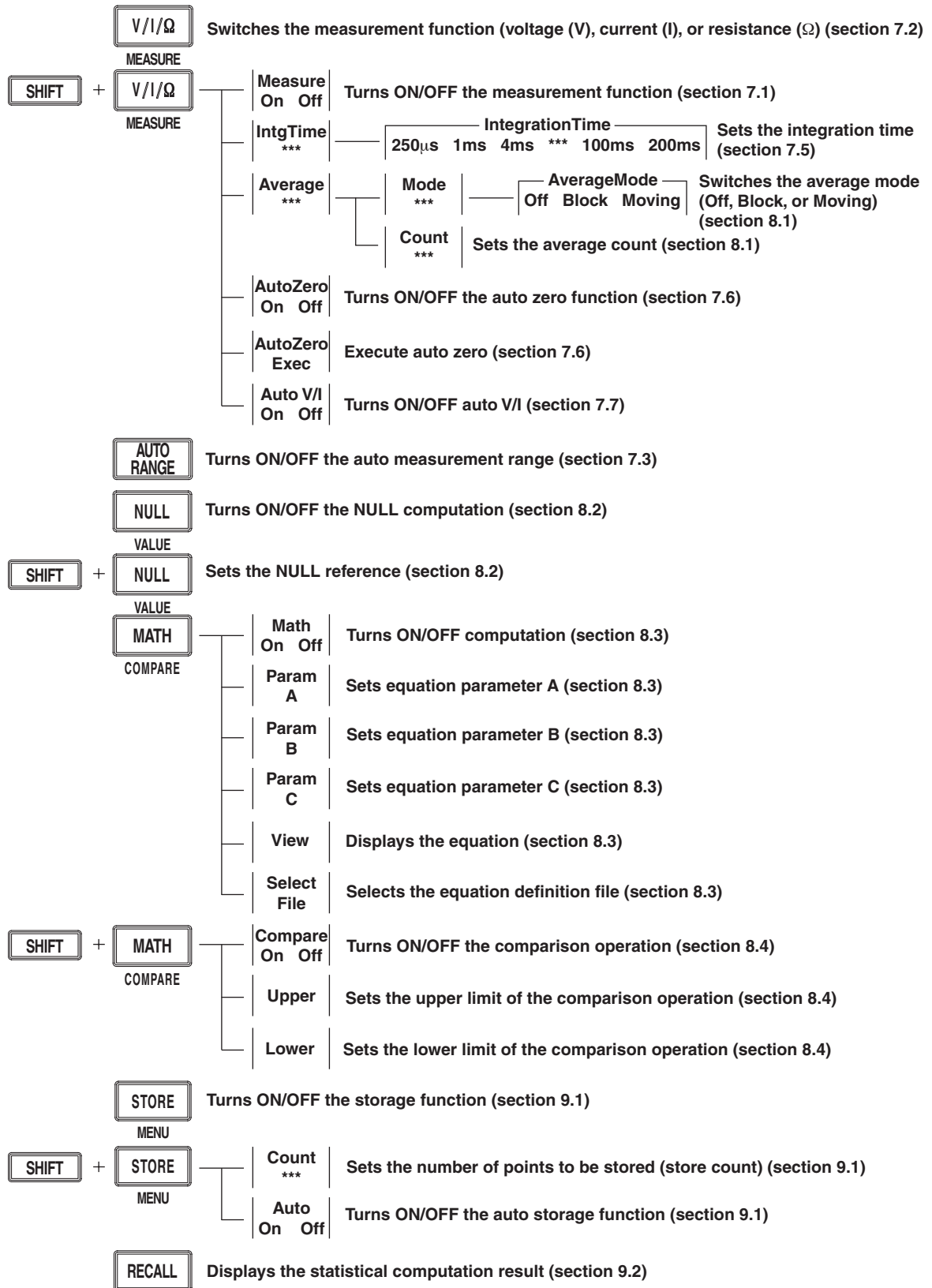

OUTPUT CONTROL Group

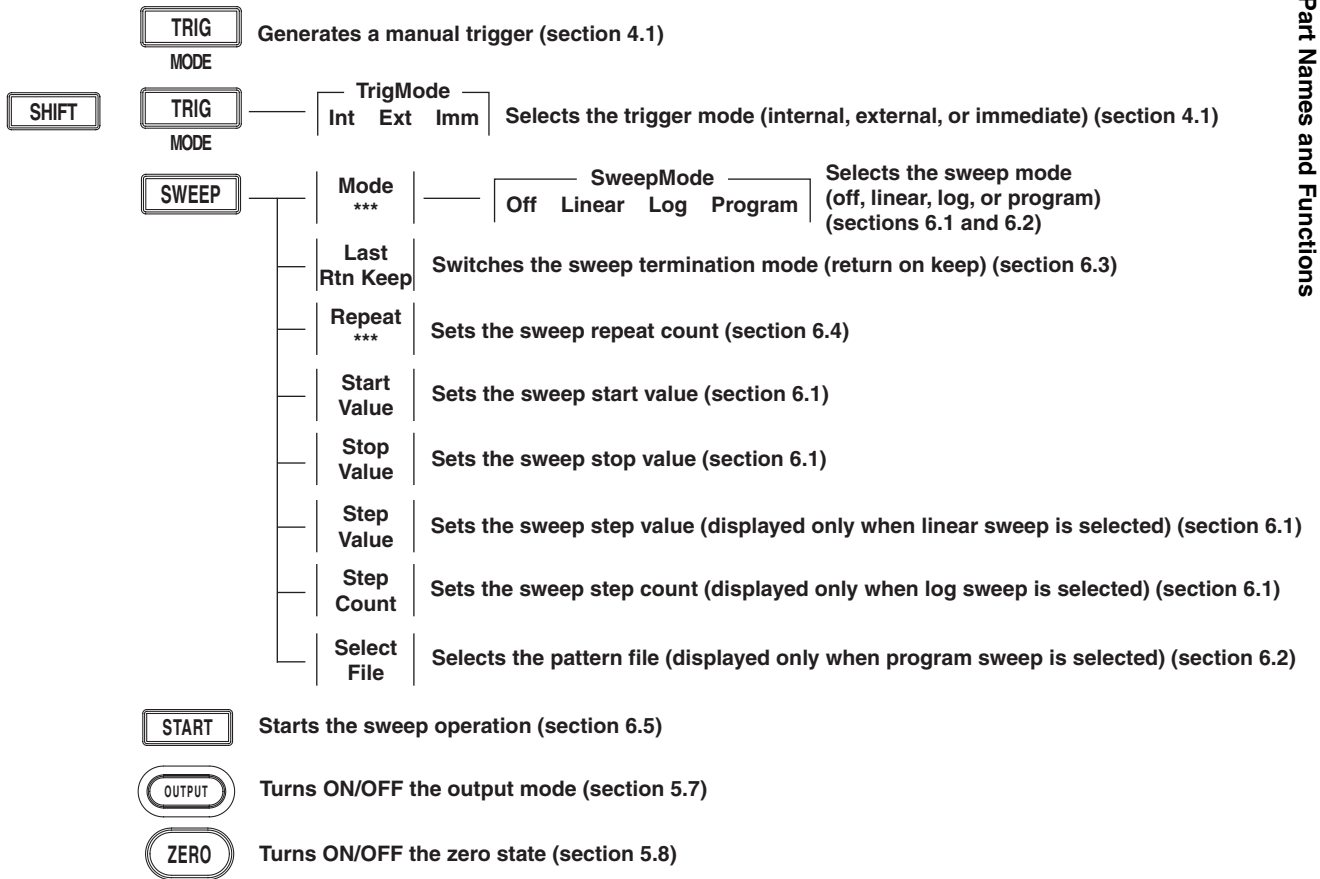

1.4 Key Groups and Menus

MISC Group

TIME KEY LOCK	S.Delay ***	Sets the source delay (section 5.6)								
	M.Delay ***	Sets the measure delay (section 7.4)								
	Period ***	Sets the repeat period of the internal trigger (section 4.1)								
	P.Width ***	Sets the pulse width (section 5.5)								
SHIFT + TIME KEY LOCK	Turns ON/OFF key lock (section 11.6)									
MISC	Remote I/F									
	GPIB ***	Sets the GP-IB address (section 13.4)								
	RS232	BaudRate ***	<table border="1"> <tr> <td>BaudRate</td> <td>9600</td> <td>14400</td> <td>19200</td> <td>38400</td> <td>57600</td> <td>115200</td> </tr> </table> Selects the RS-232 baud rate (section 14.5)	BaudRate	9600	14400	19200	38400	57600	115200
		BaudRate	9600	14400	19200	38400	57600	115200		
		DataBit 7 8	Switches the RS-232 data length (7 or 8) (section 14.5)							
		Parity ***	<table border="1"> <tr> <td>Parity</td> <td>None</td> <td>Even</td> <td>Odd</td> </tr> </table> Selects the RS-232 parity (none, odd, or even) (section 14.5)	Parity	None	Even	Odd			
		Parity	None	Even	Odd					
		StopBit 1 2	Switches the RS-232 stop bit (1 or 2) (section 14.6)							
	Flow ***	<table border="1"> <tr> <td>FlowControl</td> <td>None</td> <td>XON</td> <td>CTS/RTS</td> </tr> </table> Selects the RS-232 flow control (none, XON-OFF, CTS-RTS) (section 14.5)	FlowControl	None	XON	CTS/RTS				
	FlowControl	None	XON	CTS/RTS						
	Term ***	<table border="1"> <tr> <td>Terminator</td> <td>CR</td> <td>LF</td> <td>CR+LF</td> </tr> </table> Selects the RS-232 transmission delimiter (CR, LF, or CR+LF) (section 14.5)	Terminator	CR	LF	CR+LF				
	Terminator	CR	LF	CR+LF						
	LAN	DHCP On Off	Turns ON/OFF the Ethernet DHCP function (section 12.3)							
		IP Address	Enter Sets the fixed Ethernet IP address (section 12.3)							
		Subnet Mask	Enter Sets the fixed Ethernet subnet mask (section 12.3)							
		Default Gateway	Enter Sets the fixed Ethernet default gateway (section 12.3)							
		Term ***	<table border="1"> <tr> <td>Terminator</td> <td>CR</td> <td>LF</td> <td>CR+LF</td> </tr> </table> Sets the Ethernet transmission delimiter (CR, LF, or CR+LF) (section 12.3)	Terminator	CR	LF	CR+LF			
		Terminator	CR	LF	CR+LF					
	Overview	Shows a list of Ethernet settings (section 12.4)								
	USB ***	USB Mode Storage USB-TMC	Selects the USB function (storage function or USB communication function) (section 15.2)							
		Setup								
	Save Setup	Save RamDisk	Saves the settings to the RAM disk (GS610RAM) (section 11.1)							
		Save Setup1	Saves the settings to Setup 1 (section 11.1)							
Save Setup2		Saves the settings to Setup 2 (section 11.1)								
Save Setup3		Saves the settings to Setup 3 (section 11.1)								
Save Setup4		Saves the settings to Setup 4 (section 11.1)								
Load Setup	Loads the setup (section 11.2)									
PowerOn Setup	Selects the setup used when the GS610 is powered up (section 11.3)									
Error Log	Clear	Shows and clears error log (section 11.5)								

Continues to the next page

Continued from the previous page

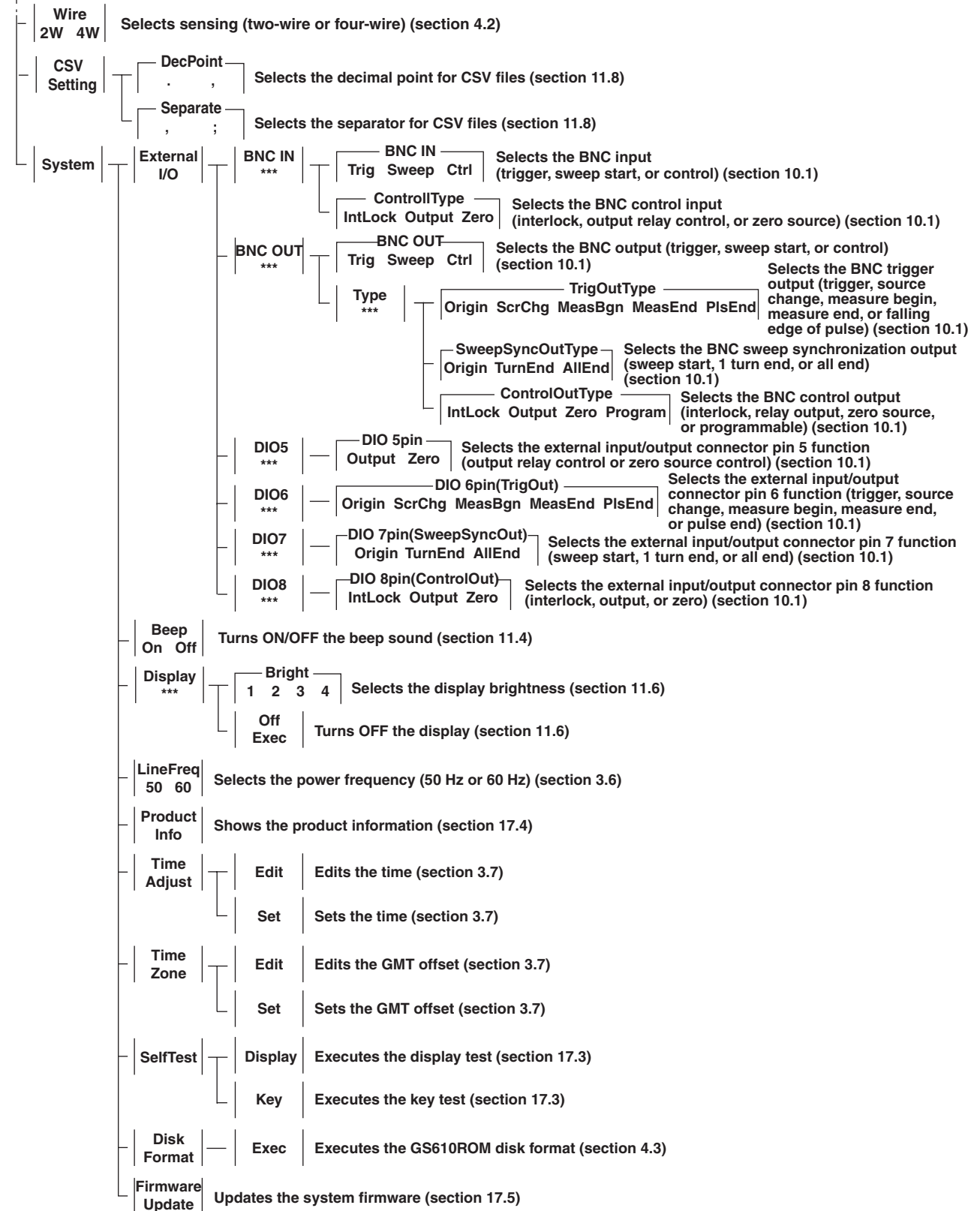

2.1 System Configuration and Block Diagram

System Configuration

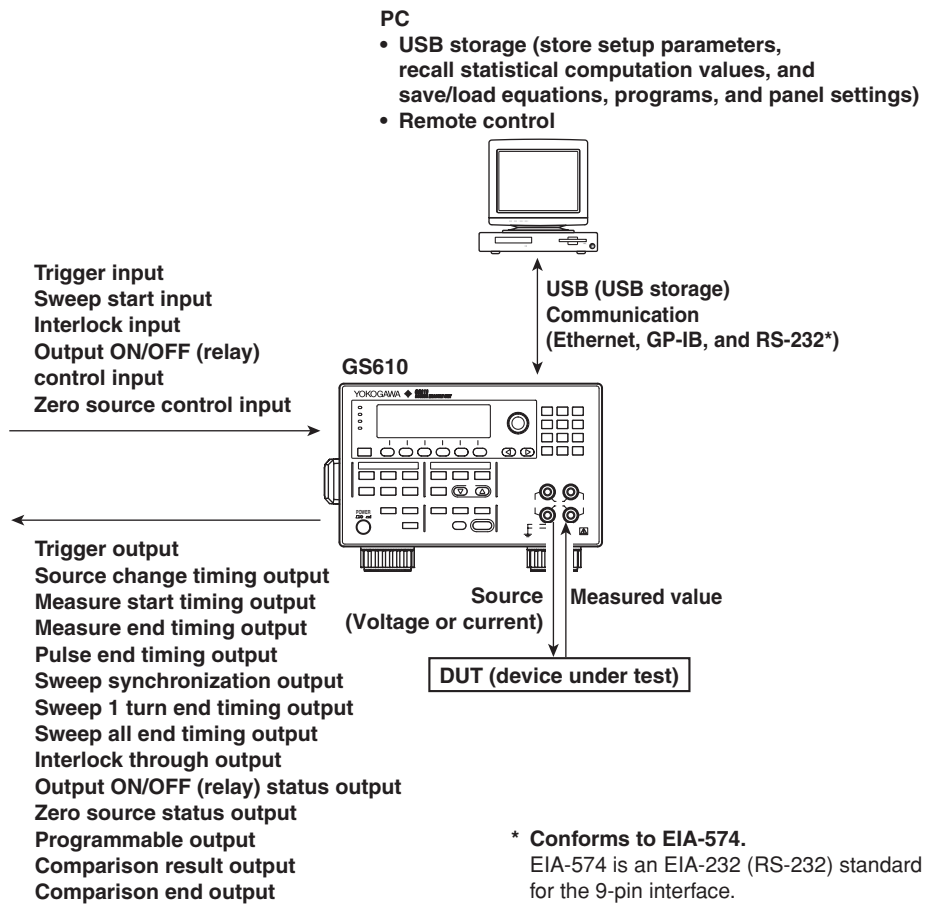

2.1 System Configuration and Block Diagram

Block Diagram

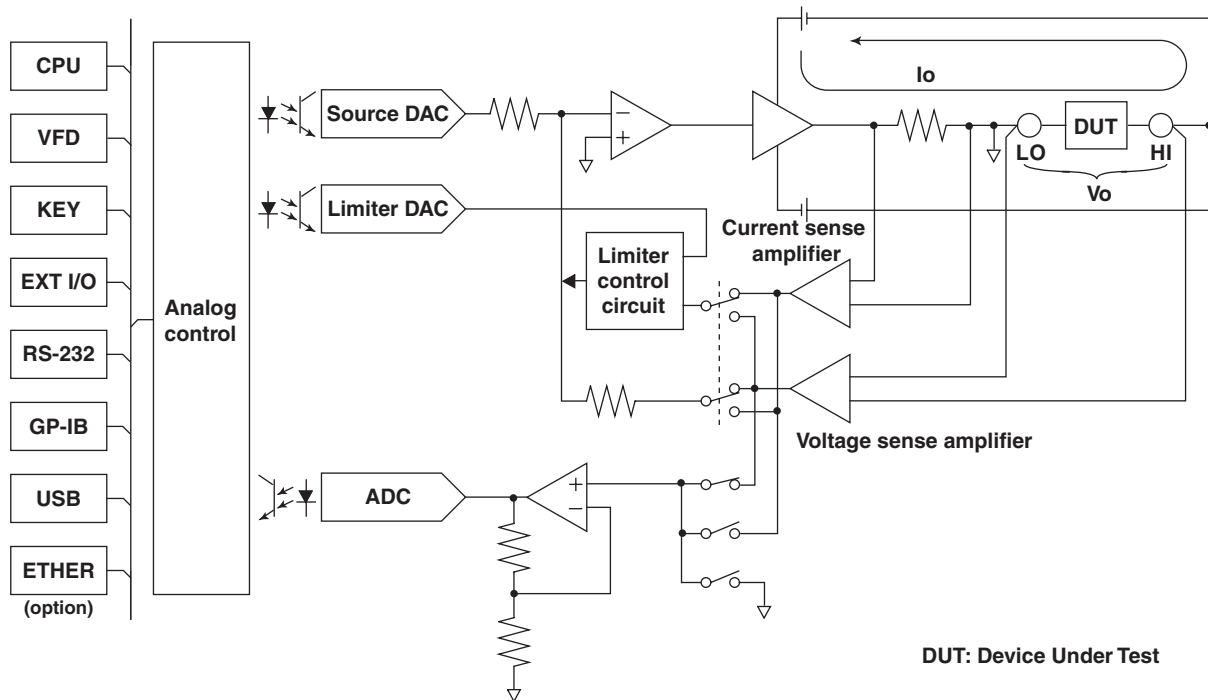

DUT: Device Under Test

Voltage V_o that appears across output terminals HI and LO is converted to normalized voltage by a differential amplifier (voltage sense amplifier) that has different gains for different voltage ranges. In addition, current I_o that flows through output terminals HI and LO is converted to normalized voltage by different shunt resistors and differential amplifiers (current sense amplifiers) for different current ranges.

The analog section consists of the source block, limiter block, and measurement block. The source block controls the voltage sense amplifier or the current sense amplifier so that its output is equal to the source DAC output, and delivers the specified source value across HI and LO. Two D/A converters are used in the source DAC to achieve a 5.5-digit resolution.

The limiter control circuit in the limiter block controls the output across HI and LO so that it is equal to the specified limiter value when the output from the voltage sense amplifier or current sense amplifier exceeds the specified limiter value. When generating voltage, the output from the current sense amplifier is compared with the limiter value; when generating current, the output from the voltage sense amplifier is compared with the limiter value. The measurement block measures the output from the voltage sense amplifier or current sense amplifier. In addition, if the auto zero function is enabled, the internal zero reference is measured every measurement cycle (measurement operation), and the offset drift of the measurement pre-amplifier and A/D converter is cancelled while measurements proceed. A feedback pulse width modulation (an integration type) is employed for the A/D converter (ADC).

The analog control section transfers data to the D/A converter (DAC), controls various switches, controls the width measurement of the pulse transferred from the A/D converter, and so on. To achieve high-speed sweep of 100 μ s steps, a high-speed photocoupler is employed for the transferring of data to the source DAC.

The display employs a 256 \times 64 dot VFD* to improve the visibility.

The GS610 comes with GP-IB and RS-232 interfaces that provide compatibility with conventional systems as well as a USB port that is convenient for writing to or reading data from a PC. An Ethernet port is also provided as an option if you wish to use the existing network for data communication.

* Vacuum Fluorescent Display

2.2 Source Measure Cycle

Source measure cycle on the GS610 refers to the basic operation that starts with a trigger (see section 2.5, “Triggers”). When the GS610 output is ON, the source measure cycle is constantly repeated.

In a source measure cycle, the source level changes after a time specified by the source delay elapses from the point in which the trigger is activated. Furthermore, the measurement starts after a time specified by the measurement delay elapses. When the measurement and computation are complete, one source measure cycle is finished. However, if you change the source level with a key or a communication command in the middle of a source measure cycle, the source level changes immediately without waiting for the source delay or measure delay, and the internal trigger phase is reset. If the measurement function is turned OFF, measure delay, measurement, and computation are not carried out. The way in which a source measure cycle ends varies depending on the source mode (see sections 5.4, “DC Source Mode” and 5.5, “Pulse Source Mode”).

Source Measure Cycle Example (When the Source Mode Is DC and Sweep Mode Is Linear)

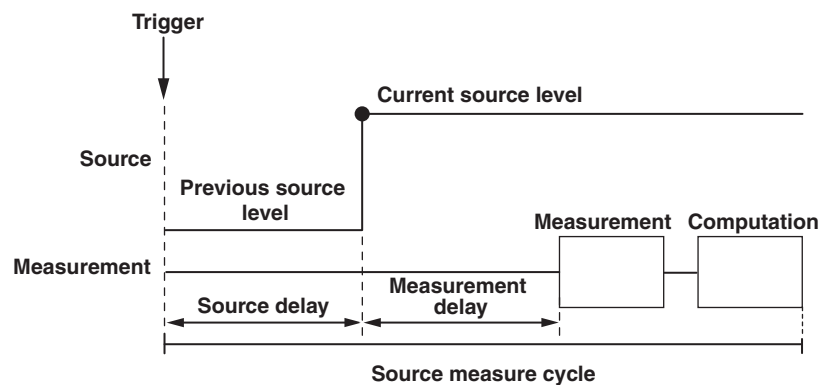

Flow Chart of a Source Measure Cycle

The time indicated in the chart is a typical time needed for its processing. The averaging time varies depending on the average count, and the computation time varies depending on the complexity of the equation.

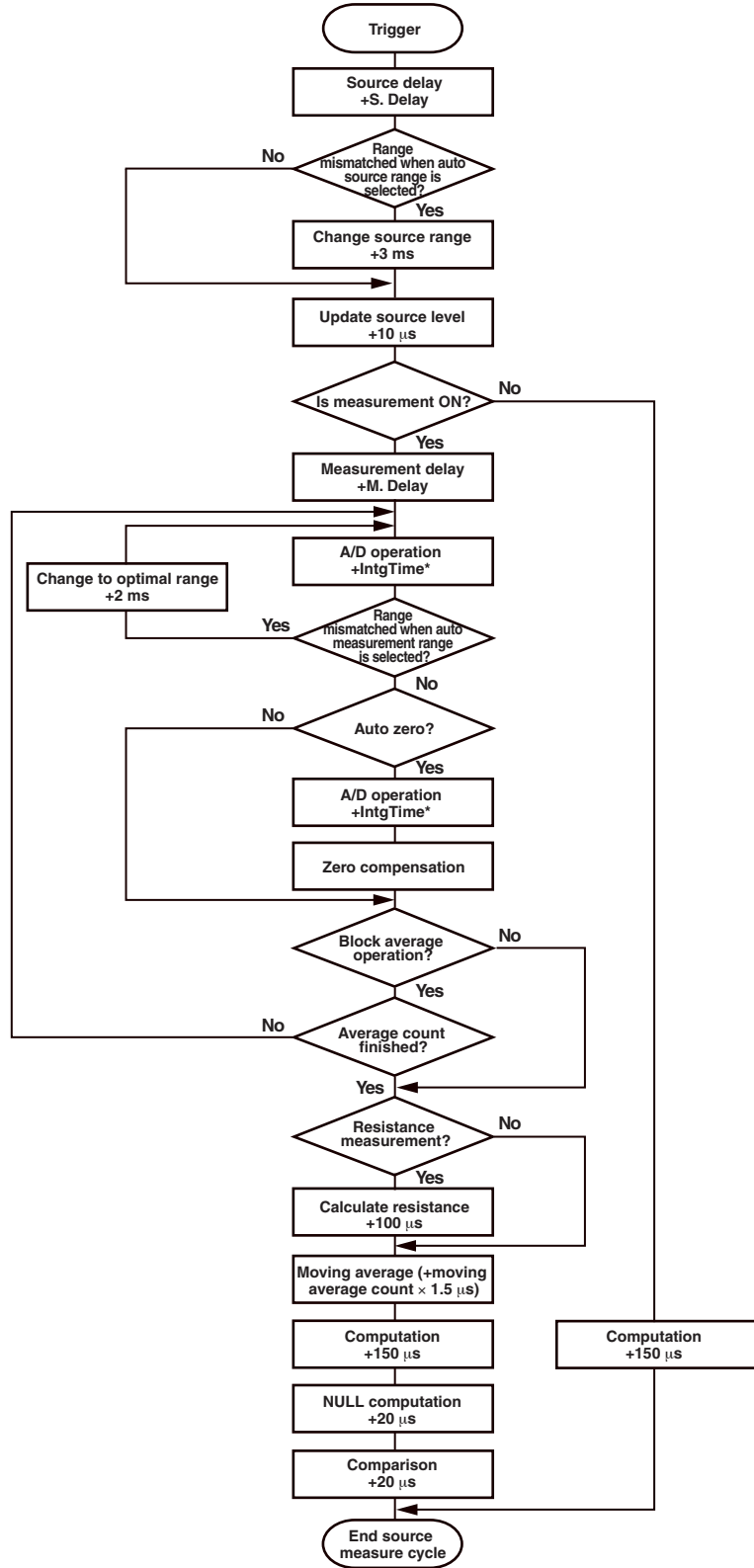

* Integration time + 200 μs when the integration time is 250 μs, 1 ms, or 4 ms.
Integration time + 520 μs when the integration time is 20 ms, 100 ms, or 200 ms.

2.3 Source

Source Function

You can select voltage source (VS) or current source (IS).

Source Range

The GS610 generates voltage or current in the range specified by the hatched lines in the figure below. The performance limitations of the GS610 place constraints on the current and voltage when generating voltage and current, respectively. For example, the voltage is limited to 30 V or less when 1.5 A is specified when generating current. If the voltage or current source level is at the boundary of the source range and is limited, a high limiter indicator (H) illuminates if the level is positive and a low limiter indicator (L) illuminates if the level is negative.

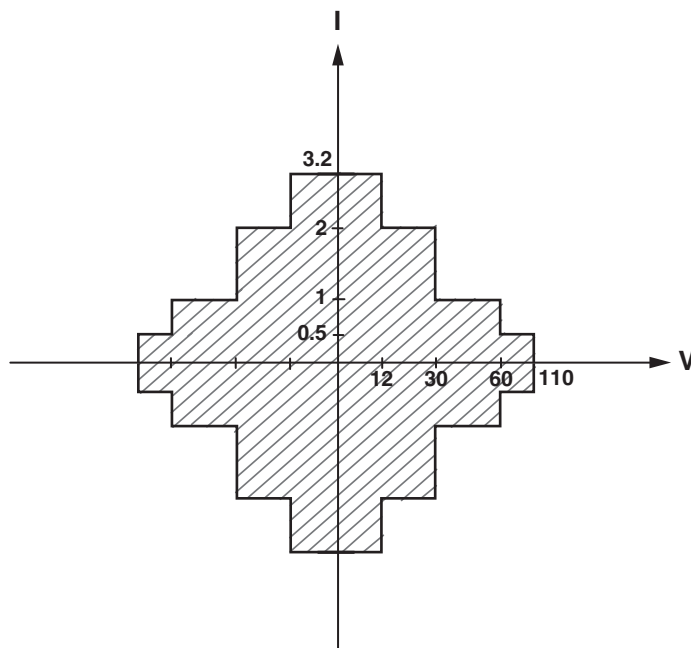

Limiter



CAUTION

If a load exceeding the source range above is connected such as a current source exceeding the current limiter setting when generating voltage or a voltage source exceeding the voltage limiter setting when generating current, abnormal load is detected, and the output is turned OFF. Do not connect a load exceeding the range above to the GS610. Doing so may cause malfunction.

If a limiter is set, an additional limit can be placed within the source range. This limit can prevent damage to the connected device due to overcurrent or overvoltage. The current limiter is automatically selected when generating voltage, and the voltage limiter is automatically selected when generating current.

If the limiter is turned OFF, the voltage or current can be generated up to the maximum value of the source range regardless of the limiter setting.

Voltage Limiter Operation

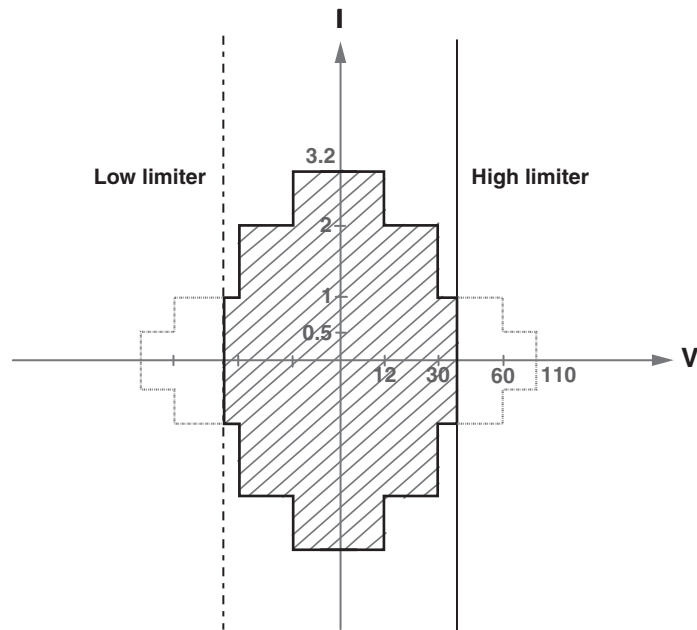

Current Limiter Operation

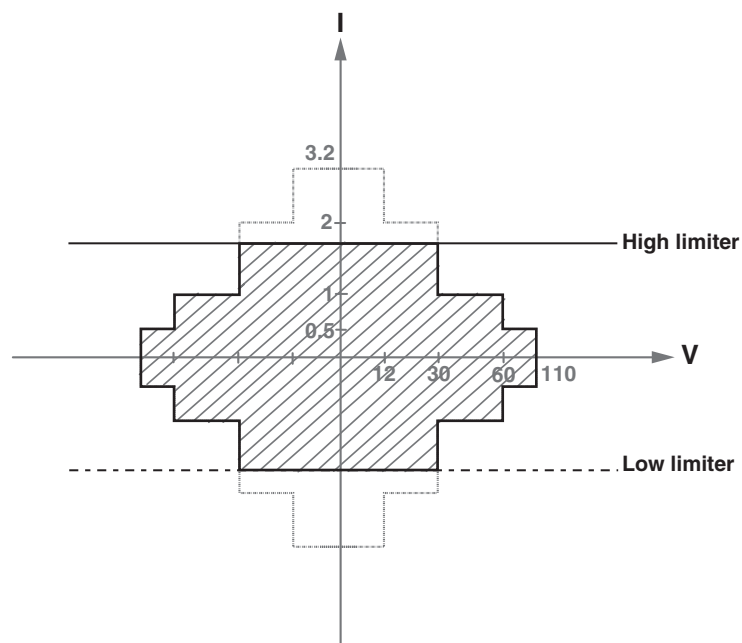

The high and low limiter values can be set independently. If tracking is turned ON, an absolute value can be set for the high and low limits, and the limiter functions in the positive and negative ranges around zero.

If the high limiter is active, the high limiter indicator (H) is shown on the display. If the low limiter is active, the low limiter indicator (L) is shown on the display.

Source Range Setting and Auto Range

Source Range Setting

The source range settings during voltage generation and current generation are listed below.

• Voltage Source Range Settings

Source Range Setting	Source Range	Resolution
200 mV	±205.000 mV	1 μ V
2 V	±2.05000 V	10 μ V
12 V	±12.0000 V	100 μ V
20 V	±20.5000 V	100 μ V
30 V	±30.000 V	1 mV
60 V	±60.000 V	1 mV
110 V	±110.000 V	1 mV

• Current Source Range Settings

Source Range Setting	Source Range	Resolution
20 μ A	±20.5000 μ A	100 pA
200 μ A	±205.000 μ A	1 nA
2 mA	±2.05000 mA	10 nA
20 mA	±20.5000 mA	100 nA
200 mA	±205.000 mA	1 μ A
0.5 A	±0.50000 A	10 μ A
1 A	±1.00000 A	10 μ A
2 A	±2.00000 A	10 μ A
3 A	±3.20000 A	10 μ A

Auto Range

If auto range is turned ON, the range setting with the highest resolution that contains the source level is automatically selected, eliminating the need for you to manually select the range setting. However, switching the range setting takes time, and the source level becomes discontinuous, if the range setting switches as a result of changing the source level.

Source Mode

There are two source modes available.

DC Source Mode

If the sweep mode (see section 2.6, "Sweep") is ON in DC source mode, the source level changes after a time specified by the source delay elapses from the point in which the trigger is activated. Then, measurement starts after a time specified by measurement delay elapses. When the measurement and computation are complete, one source measure cycle is finished.

If the sweep mode is OFF, the source level is maintained, and the source measure cycle is carried out.

If the measurement function (see section 2.4, "Measurement") is turned OFF, measurement delay, measurement, and computation are not carried out. The source measure cycle is finished when the source level changes.

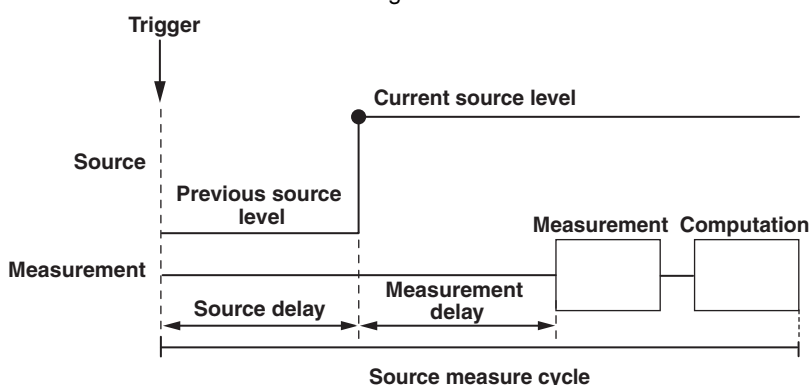

Pulse Source Mode

Pulse source mode can be used to improve the reproducibility of measurements on DUTs that change in characteristics due to the heat generation that results from applying the source such as a resistor with large temperature coefficient. It is also effective for evaluation of display devices that use pulse width to control the brightness.

The pulse is specified by two values, the pulse base value and the source level. The minimum pulse width is 100 μ s.

As with the DC source, the source level changes after a time specified by the source delay elapses from the point in which the trigger is activated. Furthermore, the measurement starts after a time specified by the measurement delay elapses. The source level changes at the same the measure delay is activated and returns to the pulse base value after the pulse width. A source measure cycle is finished at the end of the pulse or at the end of the measurement and computation, whichever comes later. If the measurement function (see section 2.4, "Measurement") is turned OFF, measure delay, measurement, and computation are not carried out. The end of the pulse is the end of a source measure cycle.

When the End of the Measurement and Computation Is after the End of the Pulse Generation

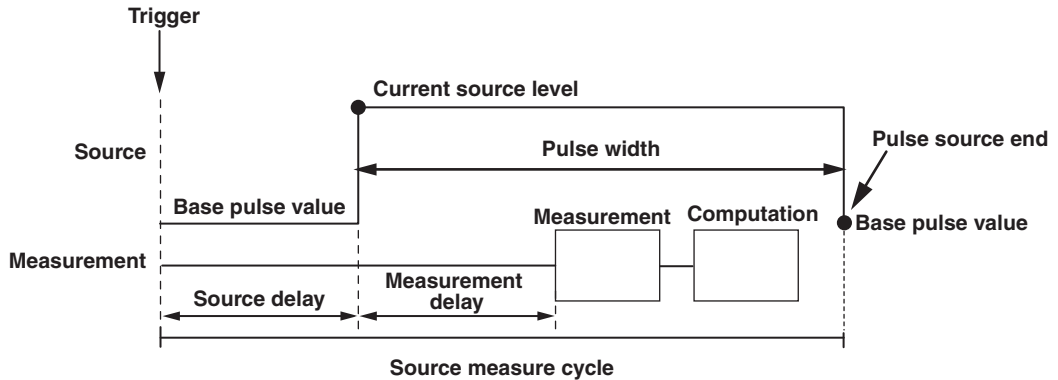

When the End of the Measurement and Computation Is before the End of the Pulse Generation

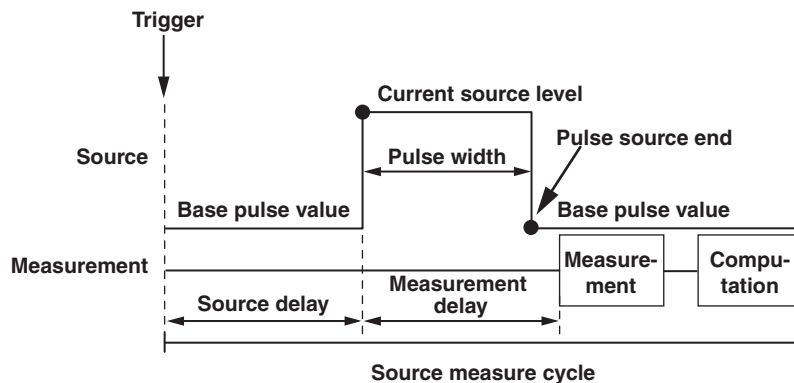

Source Delay

The source delay specifies the wait time at which the source value is actually changed after the trigger is activated. It is typically used as a trigger delay when an external trigger is used.

The source delay can be set in the range of 1 μ s to 3600 s. However, setting a long source delay results in a long source measure cycle. Set the smallest value possible.

Turning the Output ON/OFF and Generating Zero Output

As shown in the figure below, there are three output modes, Output ON, Output OFF, and Zero Generation. The mode is switched with the OUTPUT and ZERO keys.

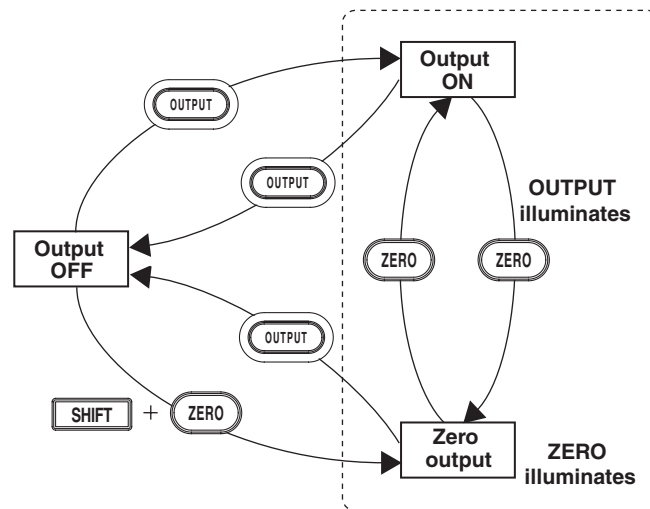

Output OFF: The output relay is OFF, and voltage or current is not generated.

The source measure cycle is also stopped.

Output ON: The output relay is ON, and voltage or current is generated. The source measure cycle is repeated.

Zero Generation: The output relay is ON. If generating voltage, 0 V is generated. If generating current, 0 A is generated. Then, the source measure cycle is stopped.

Zero Source Offset

An offset can be specified on the zero value when generating zero output.

Zero Source Impedance

Low impedance (LoZ) is default when generating voltage, and high impedance (HiZ) is default when generating current. Only the source value is set to zero.

If high impedance is set when generating voltage or low impedance is set when generating current, the source value is set to zero, and the limiter is constrained to the minimum value of the range.

Offset Calibration

Offset calibration can be used to correct the drift in the zero point of the source value such as due to temperature change. For example, the offset calibration is used to correct the offset fluctuation due to the leak current of the internal circuit when using a low current source range in a high temperature environment.

2.4 Measurement

Turning the Measurement Function ON/OFF

If measurement is not necessary, the measurement function can be turned OFF. When the measurement function is turned OFF, the procedure related to measurement is not carried out. This enables the source measure cycle to be shortened.

Measurement Function

You can select voltage measurement (V), current measurement (I), or resistance measurement (Ω).

In resistance measurement, current is measured when voltage is generated, and voltage is measured when current is generated. Then, the resistance is derived by calculating voltage/current.

Measurement Range Setting and Auto Range

The measurement range settings during voltage measurement and current measurement are listed below. However, the measurement range setting is not directly specified, but determined indirectly by the source range setting and limiter setting.

- **Voltage Measurement Range Settings**

Integration Time of 16.66 ms/20 ms, 100 ms, or 200 ms			Integration time of 4 ms, 1 ms, or 250 ms		
Range Setting	Measurement Range	Resolution	Range Setting	Measurement Range	Resolution
200 mV	± 205.000 mV	1 μ V	200 mV	± 205.00 mV	10 μ V
2 V	± 2.05000 V	10 μ V	2 V	± 2.0500 V	100 μ V
20 V	± 20.5000 V	100 μ V	20 V	± 20.500 V	1 mV
110 V	± 110.000 V	1 mV	110 V	± 110.00 V	10 mV

When Generating Current

Same as the voltage limiter range

When Generating Voltage

Same as the voltage source range

However, if the voltage source range is 12 V, 30 V, or 60 V, the settings below apply.

Voltage Source Range Setting	Voltage Measurement Range Setting
12 V	20 V
30 V	110 V
60 V	110 V

- **Current Measurement Range Settings**

Integration Time of 16.66 ms/20 ms, 100 ms, or 200 ms			Integration time of 4 ms, 1 ms, or 250 ms		
Range Setting	Measurement Range	Resolution	Range Setting	Measurement Range	Resolution
20 μ A	± 20.5000 μ A	100 pA	20 μ A	± 20.500 μ A	1 nA
200 μ A	± 205.000 μ A	1 nA	200 μ A	± 205.00 μ A	10 nA
2 mA	± 2.05000 mA	10 nA	2 mA	± 2.0500 mA	100 nA
20 mA	± 20.5000 mA	100 nA	20 mA	± 20.500 mA	100 nA
200 mA	± 205.000 mA	1 μ A	200 mA	± 205.00 mA	10 μ A
3 A	± 3.20000 A	10 μ A	3 A	± 3.2000 mA	100 μ A

When Generating Voltage

Same as the current limiter range

When Generating Current

Same as the current source range

However, if the current source range is 0.5 A, 1 A, or 2 A, the settings below apply.

Current Source Range Setting	Current Measurement Range Setting
0.5 A	3 A
1 A	3 A
2 A	3 A

Auto Range

When auto range is turned ON, the GS610 makes a measurement and checks whether a different range setting is available for making the measurement with the best resolution. If there is, the GS610 changes the range setting and makes the measurement again. However, it may take time for the GS610 to switch the range setting, and the source level may become discontinuous.

Measurement Delay

The measurement delay is the wait time at which the measurement is started after the source level is switched. It is used for the item being measured to stabilize.

The measurement delay can be set in the range of 1 μ s to 3600 s. However, setting a long measurement delay results in a long source measure cycle. Set the smallest value possible.

Integration Time

The integration time is the time that the integrating A/D converter performs integration. If you increase the integration time, the time needed to make measurements takes longer, but the measured values are more stable.

When the power frequency is 50 Hz: 250 μ s, 1 ms, 4 ms, 20 ms, 100 ms, or 200 ms

When the power frequency is 60 Hz: 250 μ s, 1 ms, 4 ms, 16.6 ms, 100 ms, or 200 ms

If the integration time is set to 200 ms, 100 ms, 20 ms, or 16.6 ms, the effects of noise from the power frequency can be eliminated, because these settings are integer multiples of the power cycle.

Auto Zero Function

When auto zero is ON, the GS610 also measures the internal zero reference for each measurement. The measured result is obtained by subtracting this value from the measured value canceling the offset drift of the measurement circuit in the GS610. However, the measurement takes approximately twice as long, because the GS610 measures twice.

Auto V/I

This function enables the measurement function to be switched when a limiter is activated.

For example, when a secondary battery is being charged with constant current, the rising battery voltage can be measured. When the voltage limiter is activated and the operation switches to constant voltage charge, the reduction in the charging current can be measured.

When Generating Voltage and Measuring Current

When the limiter is not activated: The GS610 measures current. The voltage source level is entered for the source value in the result file when the storage operation is carried out. (Normal operation)

When the limiter is activated: The GS610 measures voltage. The current limiter value is entered for the source value in the result file when the storage operation is carried out.

When Generating Current and Measuring Voltage

When the limiter is not activated: The GS610 measures voltage. The current source level is entered for the source value in the result file when the storage operation is carried out. (Normal operation)

When the limiter is activated: The GS610 measures current. The voltage limiter value is entered for the source value in the result file when the storage operation is carried out.

2.5 Triggers

The following three triggers are available for starting a source measure cycle.

Internal trigger (Int): The internal constant period timer is used as triggers. The cycle can be set in the range of 100 μ s to 3600 s.

External trigger (Ext): The rising edge of the voltage signal that is applied to the BNC input/output terminal or pin 2 on the external input/output connector on the rear panel is used as a trigger.

Immediate (Imm): The GS610 does not wait for a trigger. When the current source measure cycle is complete, the next source measure cycle starts immediately. This trigger can be selected only when the measurement function is ON.

When the GS610 is waiting for a trigger (when the source measure cycle is complete), the wait indicator on the display shows "WaitTrigger." If a trigger is activated, the TRIG key on the front panel blinks, and WaitTrigger of the wait indicator is turned OFF until the source measure cycle is complete.

When using an external trigger, manual trigger using the TRIG key on the front panel and triggers activated with communication commands ("*TRG" or GroupExecuteTrigger) are valid.

If you wish to activate triggers only with communication commands, select external trigger and do not apply triggers to the BNC input/output terminal or pin 2 on the external input/output connector on the rear panel.

Note

If another trigger is activated in the middle of a source measure cycle, that trigger is discarded. If the trigger timing is not synchronized to the source measure cycle period (the starting point) as in this case, the sampling error indicator (SampleErr) illuminates in the status display area of the display.

To prevent sampling errors from occurring, increase the interval at which triggers are activated or shorten the source measure cycle (see section 2.2, "Source Measure Cycle"). Below are ways of shortening the source measure cycle.

- Set the shortest source delay and measurement delay possible.
- If measurements are not needed, turn the measurement function OFF. When making measurements, set the shortest integration time possible.
- Turn OFF the auto zero function (see section 2.4, "Measurement").
- Turn OFF the auto range function of the source and measurement range settings.
- Turn OFF various computation functions.
- When performing a sweep, turn OFF the auto storage function (see section 2.8, "Store/Recall").

2.6 Sweep

There are three sweep modes, linear sweep, log sweep, and program sweep. To disable the sweep function, turn it OFF. The sweep key illuminates when the sweep mode is not OFF.

Basic Sweep Operation

The sweep function repeats the source measure cycle by automatically varying the source level. In this case, a start event is needed for starting the sweep operation in addition to the trigger that starts the source measure cycle.

The sweep function starts in a start-wait condition. The GS610 can receive triggers only after receiving a start event. Once started, the GS610 repeats the source measure cycle by varying the source level for the subsequent triggers that it receives. When a sweep operation is completed, the GS610 transits to the start-wait condition again.

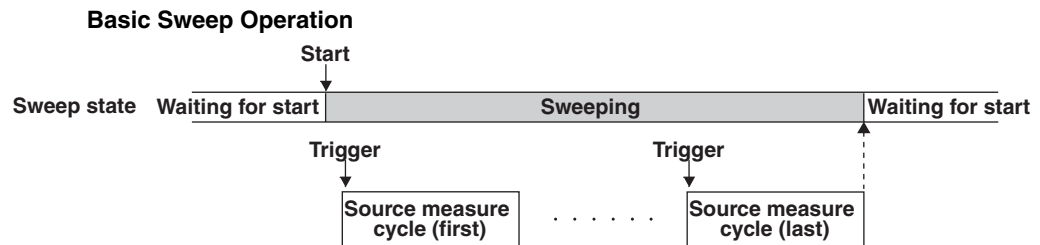

Sweep Mode

Linear Sweep

Sweeps using evenly spaced step values that increase linearly from the specified start value to the stop value.

• When the source mode is DC

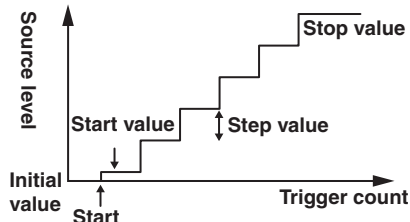

• When the source mode is pulse

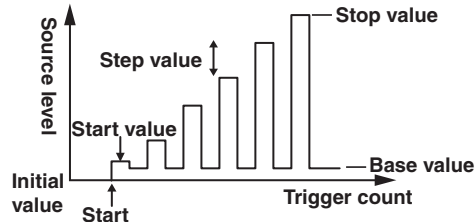

Log Sweep

Sweeps exponentially from the specified start value to the stop value at the specified step count.

The step count can be set arbitrary in the range of 2 to 65535. However, if the start value and stop value have opposite signs, an error occurs, and the sweep operation cannot be carried out.

• When the source mode is DC

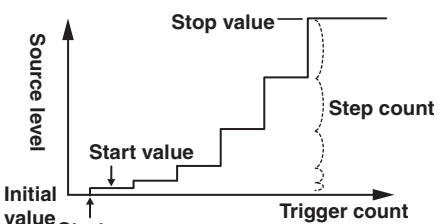

• When the source mode is pulse

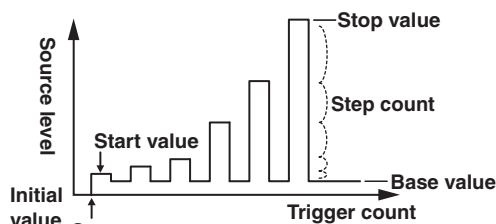

Program Sweep

Sweeps according to the values in a pattern file containing an arbitrary sweep pattern.

Program Sweep Example

• When the source mode is DC

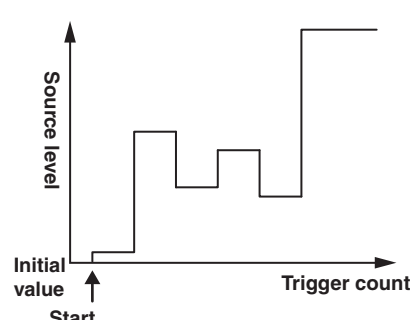

• When the source mode is pulse

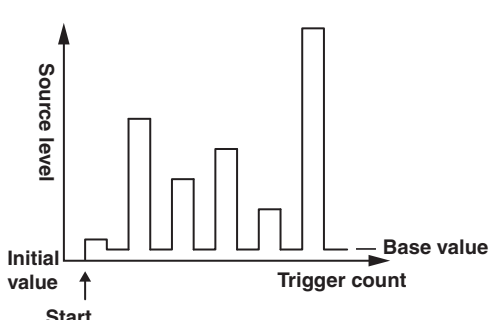

Termination Mode

There are two termination modes, Keep and return (Rtn).

In Keep mode, the last source level of the sweep operation is retained. In Return (Rtn) mode, the source level after the sweep operation is complete is reset to the level before the sweep operation was started.

- Sweep operation when the termination mode (Last) is set to keep

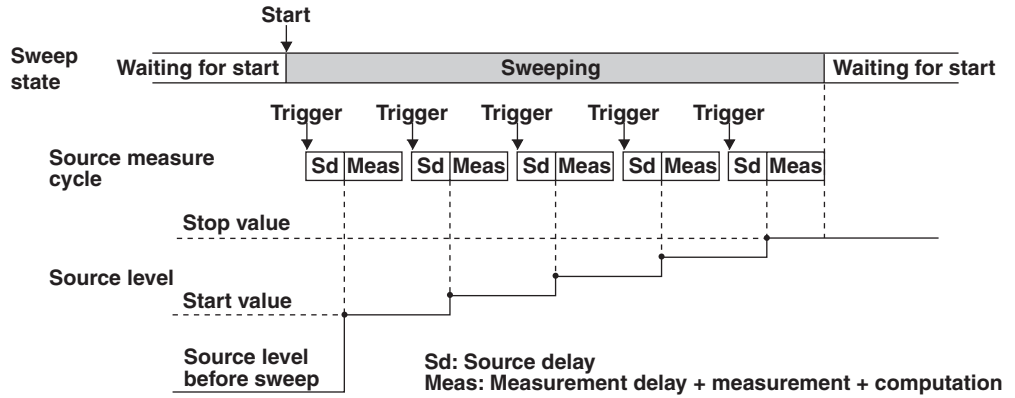

- Sweep operation when the termination mode (Last) is set to return (Rtn)

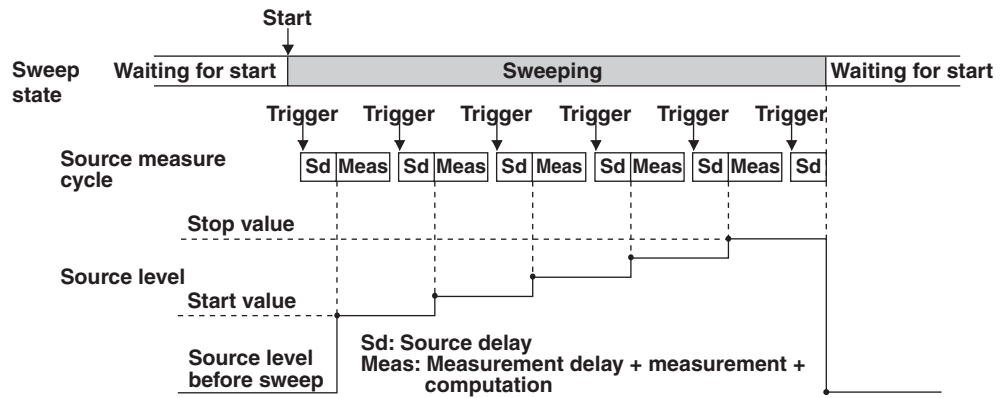

Repeat Count

The selectable range is 1 to 1000 or infinity (∞). For example, if the repeat count is set to 5, the GS610 repeats the sweep operation five times when it receives a start event. Then, the GS610 returns to the start-wait condition. If infinity (∞) is selected, the GS610 starts the sweep operation when it receives a start event and repeats the operation until the sweep operation or output is turned OFF.

2.7 Computation

Averaging

When the averaging function is used, the specified number (average count) of measured values are averaged to derive the final displayed value. Therefore, the measured results are more stable.

There are two averaging modes, block average and moving average.

Block average: The specified average count of measurements is carried out in a single source measure cycle. The GS610 displays the result obtained by summing the measured values and dividing the sum value by the average count. Therefore, the measurement time takes average count times as long.

Moving average: The GS610 measures once in a single source measure cycle. The GS610 displays the result obtained by summing the average count of measured values and dividing the sum value by the average count. If the number of measurements does not reach the average count, the average over the number of measurements is displayed.

$$\text{Display value} = \frac{1}{\text{AverageCount}} \times \sum_{i=1}^{\text{AverageCount}} \text{Measured value [i]}$$

The average count can be set in the range of 2 to 256.

When the averaging function is enabled, the average indicator on the left side of the GS610 illuminates.

NULL Computation

In NULL computation, a difference with respect to a given value can be displayed. The NULL value is set to the measured value when the NULL computation is turned ON. From that point, the GS610 displays the results obtained by subtracting the NULL value from the measured values.

$$\text{Displayed value} = \text{Measured value} - \text{NULL value}$$

When the NULL computation is switched from OFF to ON, the measured value at that point is automatically entered as the NULL value. However, this value can be changed afterwards.

When the NULL computation is enabled, the NULL key illuminates.

Computation Using Equations

Computation can be performed using equations provided in a text file. In computation using equations, four arithmetic operations, trigonometric functions, and so forth can be performed on variables such as source values and measured values as well as constants.

For example, if an equation “m=I*V” is applied, the GS610 calculates and displays the power.

The equation can be selected from the definition files in the MATH directory on the internal GS610 ROM disk (see section 2.9, “USB Storage Function”). For the definitions files, you can use built-in computation files that are available when the GS610 is shipped from the factory (or when the disk is formatted (see section 4.3, “USB Storage Function”) and user-defined computation files that you create such as on a PC.

If the definition file contains an equation with variables A, B, and C, the values for A, B, and C can be entered from the GS610 panel soft keys. Computation using equations can be used not only to perform computation using measured values, but also to create the next source value from the calculation.

2.7 Computation

The following five equations are available as built-in computation.

- **Decibel (dB.txt)**
 $m=A*\log(m/B)$: Computes the decibel of the measured value with respect to B.
- **Percent (Percent.txt)**
 $m=(m/A)*100$: Computes the percentage of the measured value with respect to A.
- **Scaling (Scaling.txt)**
 $m = A*M+B$: Scales the measured value.
- **Power (Power.txt)**
 $m=V*I$: Calculates the power from the source value and measured value. However, if the source and measurement are of the same function or when measuring resistance, the power cannot be calculated correctly. To measure power, set the GS610 to voltage generation and current measurement or current generation and voltage measurement.
- **Sinusoid generation (Sinusoid.txt)**
 $s=A*\sin(2*PI*B*t)$: Generates a sinusoid of amplitude A and frequency B. However, if the sweep function is enabled, the sweep operation takes precedence. To generate the sinusoid, turn the sweep function OFF.

When computation using equations is turned ON, the MATH key illuminates. For details on the syntax and operators of equations in the definition files, see appendix 1.

Comparison Operation

The measured value is compared with the upper and lower limits specified by the user and divided into three groups, over the upper limit (High), within the limits (In), and under the lower limit (Low). The result of the grouping is displayed at the upper left corner of the status display area on the display and output to the external input/output connector. For a description of the external input/output, see section 10.1, "Setting the Input/Output Signal on the BNC Input/Output Terminal and External Input/Output Connector."
When the comparison operation is turned ON, the MATH key illuminates.

2.8 Store and Recall (Statistical Computation Value Display)

Storage Operation

This function stores up to 65535 points of the results of the source measure cycle in the store memory. The contents of the store memory is output to the internal GS610RAM as a result file (Result.csv) after the storage operation is complete. The contents output to the result file are arrays of elapsed times from the store start point, source values, measured values, and setting changes during the sweep operation.

When you press the STORE key, the storage operation starts and the STORE key illuminates. Then, when the store count of source measure cycles is complete, the storage operation automatically ends, and the result file (Result.csv) is created.

If you press the STORE key while the storage operation is in progress, the storage operation is stopped, and the contents stored up to that point is saved to the result file (Result.csv).

The store count can be set in the range of 1 to 65535.

Auto Storage

The auto storage function automatically starts the storage operation with the start of the sweep operation. The store count in this case is automatically set to the sweep repeat count. However, if the sweep repeat count exceeds 65535, the store count is set to 65535.

Recall

When you carry out a recall operation, the statistical computation results of the measured values in the store memory can be retrieved. The statistical computation parameters are the store count, minimum value, maximum value, maximum value – minimum value, average value, and standard deviation.

2.9 USB Storage Function

The GS610 has a built-in 4-MB non-volatile disk (GS610ROM) and a 4-MB volatile disk (GS610RAM). If the GS610 is connected to a PC with a USB cable, these disks can be accessed from the PC as removable disks.

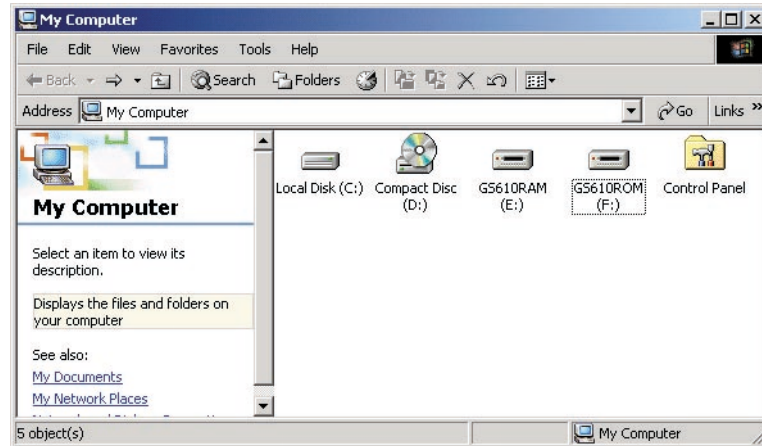

Non-Volatile Disk (GS610ROM)

GS610ROM is a non-volatile disk that retains the data on the disk even when the power is turned OFF. It contains three directories, MATH, PROGRAM, and SETUP. Equation definition files, program sweep files, and so forth can be stored on this disk to be used on the GS610.

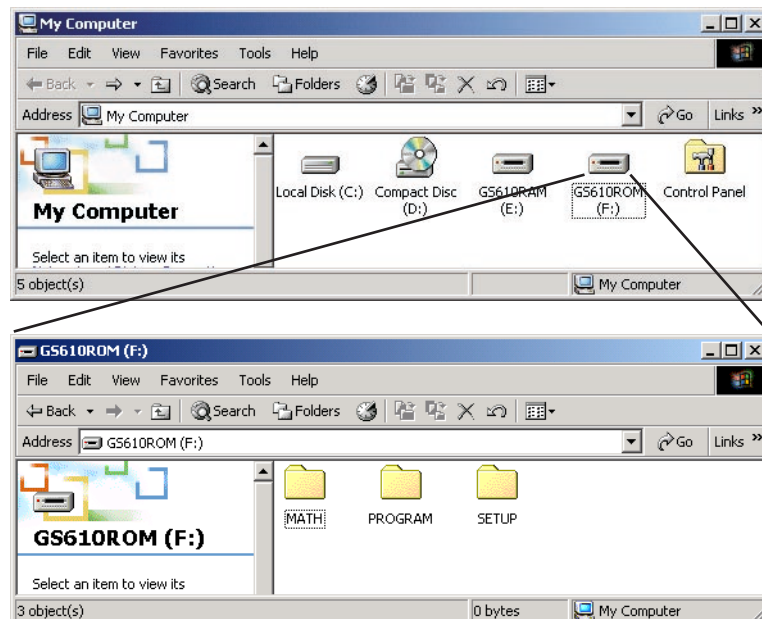

MATH

A directory for storing the definition files of equations.

The files in this directory can be selected for the computation using equations.

By factory default, built-in computation files are stored in this directory.

The built-in computation files are not erased even if the disk is formatted.

PROGRAM

A directory for storing the pattern files of program sweeps.
 The files in this directory can be selected for the program sweep function.
 By factory default, sample program files are stored in this directory.
 The sample program files are not erased even if the disk is formatted.

SETUP

A directory for storing the GS610 panel settings.
 The files in this directory can be selected as setup files.
 By factory default, a default setup file is stored in this directory.
 The default setup file is not erased even if the disk is formatted.

Volatile Disk (GS610RAM)

GS610RAM is a RAM disk that is automatically formatted when the power is turned ON. When the storage operation is carried out, the result file (Result.csv) file is created on this disk. If the settings are saved to the GS610RAM, the current settings are saved to a file named Setup.txt.

This directory is usually used to pass files that the GS610 creates to the PC. However, this disk is also used to write the system file (System.bin) from a PC when updating the system firmware. For details, see section 17.5, "Updating the System Firmware."

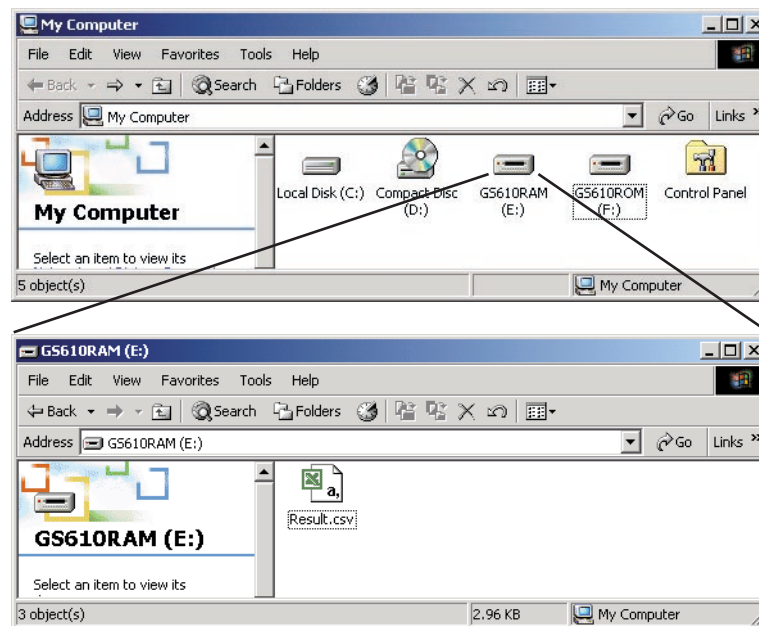

You can also create subdirectories and write files to this disk, but be sure that the disk does not become full. The data on this disk is lost when the power is turned OFF.

Formatting the Disk

You can format the disk when you wish to reset the GS610 to factory default conditions, when the non-volatile or volatile disk cannot be detected on your PC, or if you believe the data on the disk is corrupt.

2.10 Other Functions

Sensing

The GS610 has two types of sensing connections, 2W (two-terminal connection = local sense) and 4W (four-terminal connection = remote sense). You can select the appropriate sensing connection according to the amplitude of the output current. Four-terminal connection reduces the effects of the voltage drop due to the output current and lead resistance.

BNC Input/Output and External Input/Output

The GS610 has a BNC terminal (TRIG/SWEEP/CTRL IN/OUT) and external input/output connector (EXT I/O) that can be used to input or output trigger signals and other signals and output the comparison results.

GP-IB/RS-232 Communication

The GS610 is equipped with a GP-IB interface and RS-232 interface that can be used to control the GS610 using commands.

On the RS-232 interface, various parameters such as baud rate (9600 bps to 115200 bps), flow control (none, XON-OFF, or CTS-RTS), and terminator (CR, LF, or CR+LF). The command control using the GP-IB, RS-232, and the optional Ethernet interface are mutually independent, and can be used simultaneously. For example, the GS610 can be controlled via the GP-IB interface while monitoring the status via the Ethernet interface.

Ethernet Communications (Option)

A LAN interface with auto switching between 10 Mbps and 100 Mbps.

In addition to controlling the GS610 using commands, up to five FTP clients can be connected through the anonymous FTP server function. The non-volatile disk (GS610ROM) and volatile disk (GS610RAM) are available as subdirectories at the FTP root. Files can be transferred freely using the FTP protocol.

You can set a fixed address for the IP address or obtain the address dynamically from the DHCP server.

Command control server function: A command mnemonic stream parsing server at port 7655 that allows up to five clients to connect.

The terminator (CR, LF, or CR+LF) can be specified.

FTP server function: An anonymous FTP server at port 21 that allows up to five clients to connect.

HTTP server function: A function that enables various information to be displayed and performs remote control of the GS610 through port 80 using a Web browser.

Each server function is independent. Therefore, for example, the GS610 can be controlled using commands while transferring files using FTP.

Saving/Loading Setup Data

The current settings can be saved to a setup file (Setup1.txt to Setup4.txt) on the non-volatile disk (GS610ROM). The saved setup data can be loaded to restore the settings. The setup data can also be saved to the volatile disk (GS610RAM). This feature can be used to pass the setup file (Setup.txt) to a PC.

The setup file is a text file containing communication commands. The file can be edited later on a PC.

Setting at Power ON

The GS610 settings at power on can be changed from the default settings to the settings selected by the user. If one of the saved setup files is selected as the settings at power on, the GS610 starts up using the specified settings from the next time the GS610 is powered ON.

If the selected file is deleted or renamed, the GS610 starts up with default settings.

Error Log Display

The GS610 stores up to 127 runtime errors and command errors in the error memory. If one or more errors exist in the error memory, the error indicator (Err) at the upper right of the screen illuminates.

Turing ON/OFF the Beep Sound

You can select whether the GS610 generates a beep sound when you operate the GS610 incorrectly, when an error occurs during operation, or when the computation is turned ON.

Setting the Display Brightness or Turning OFF the Display

You can set the brightness of the display. You can turn OFF the display to prolong the service life of the display.

Key Lock

You can lock the panel keys so that the settings are not changed inadvertently.

Selecting the Decimal Point and Separator Notations of CSV Files

You can select the decimal point (period or comma) and the separator (comma or semicolon) notations according to the Excel program that you use. The selected notation is applied to program pattern files and measurement result files in CSV format.

Self Test

You can test the display and keys.

Checking the System Status

The GS610 displays the product name, serial number, firmware version, options, and calibration date.

Updating the System Firmware

The GS610 system can be updated by storing the most recent system file from a PC to the volatile disk (GS610RAM).

3.1 Handling Precautions

Read the Safety Precautions

Safety Precautions

If you are using this instrument for the first time, make sure to thoroughly read “Safety Precautions” given on pages v and vi.

Do Not Remove the Case

Do not remove the case from the instrument. Some sections inside the instrument have high voltages that are extremely dangerous. For internal inspection and adjustment, contact your nearest YOKOGAWA dealer.

Unplug If Abnormal Behavior Occurs

If you notice smoke or unusual odors coming from the instrument, immediately turn OFF the power and unplug the power cord. If these symptoms occur, contact your nearest YOKOGAWA dealer.

Correct the Problem If Output Is Forcibly Turned OFF

If the GS610 detects an internal circuit error due to an excessive external input or oscillation in the GS610, the GS610 forcibly turns OFF the output and displays an error. If this happens, remove the cause of the problem such as the load connected externally, and turn the output ON again. If the output still turns OFF after correcting the problem, the GS610 may have malfunctioned. Contact your nearest YOKOGAWA dealer. Note that the error display remains until you manually clear it (see section 11.5, “Error Log Display”) or read the error information via communications even if the GS610 recovers.

Turn the Power Switch OFF If Overheat Is Detected

If the GS610 detects an overheat condition such as when the inlet or vent holes for the cooling fan are obstructed or the fan is stopped, the GS610 forcibly turns the output OFF and displays a “Temperature Abnormality” warning. If this happens, immediately turn OFF the power switch. Provide adequate space around the GS610 or check and remove foreign objects caught in the cooling fan on the rear panel. If the same warning appears after waiting a substantial amount of time and you turn ON the power switch, the GS610 may have malfunctioned. Contact your nearest YOKOGAWA dealer.

Do Not Damage the Power Cord

Nothing should be placed on top of the power cord. The power cord should also be kept away from any heat sources. When unplugging the power cord from the outlet, never pull by the cord itself. Always hold and pull by the plug. If the power cord is damaged, check the part number indicated on page iii and purchase a replacement.

3.1 Handling Precautions

General Handling Precautions

Do Not Place Objects on Top of the Instrument

Never place objects containing water on top of the instrument, otherwise a breakdown may occur.

Do Not Apply Shock or Vibration

Do not apply shock or vibration. Doing so may cause malfunction. In addition, applying shock to the input/output terminal or the connected cable can cause electrical noise to enter or output from the instrument.

Keep Electrically Charged Objects Away from the Instrument

Keep electrically charged objects away from the input connectors. They may damage the internal circuitry.

Turn OFF the Power during Periods of Extended Non-Use

Turn OFF the power switch and remove the power cord from the outlet.

Carry the Instrument Properly

Remove the power cord and connecting cables. The instrument weighs approximately 7 kg. To carry the instrument, use the handle as shown in the figure below, and move it carefully.

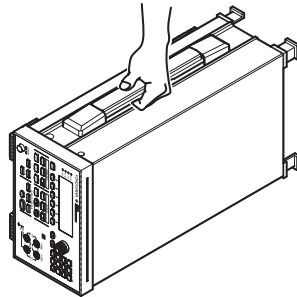

Cleaning

When wiping off dirt from the case or operation panel, turn OFF the power switch and remove the power cord from the outlet. Then, gently wipe with a soft dry clean cloth. Do not use volatile chemicals since this might cause discoloring and deformation.

3.2 Installing the GS610

Installation Position



WARNING

To prevent fire, never use the instrument with the rear side facing down. There are inlet holes for the cooling fan on the rear panel. Placing the instrument with the rear side down can cause a fire when the instrument malfunctions. If you must use the instrument with the rear panel down, place a metal plate or a flame-resistive barrier (grade UL94V-1 or higher) beneath the instrument.

Place the instrument in a horizontal position or inclined position using the stand as shown in the center of the figure below.

When using the stand, pull it forward until it locks (perpendicular to the bottom surface of the instrument). If you are installing the instrument on a slippery surface, attach the rubber feet (two pieces, included in the package) to the feet.

If you are not using the stand, return it to the original position while pressing the leg section of the stand inward.

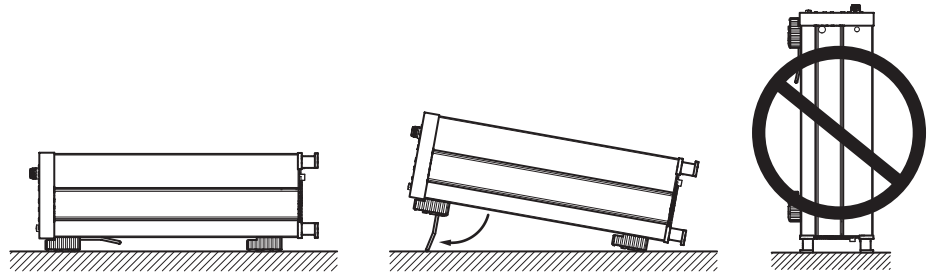

Installation Location

Install the instrument in a place that meets the following conditions.

Ambient Temperature and Humidity

Use the instrument in the following environment:

- Ambient temperature: 5 to 40°C
However, in order to obtain highly accurate measurements, operate the instrument in the $23 \pm 5^\circ\text{C}$ temperature range.
- Ambient humidity: 20 to 80%RH
No condensation should be present. However, in order to obtain highly accurate measurements, operate the instrument in the $50 \pm 10\%$ RH range.

Note

Condensation may occur if the recorder is moved to another place where both the ambient temperature and humidity are higher, or if the temperature changes rapidly. If this happens, let the recorder adjust to the new environment for at least one hour before using it.

Well-Ventilated Location

Inlet holes are located on the top and sides of the instrument. In addition, there are vent holes for the cooling fan on the rear panel. To prevent internal overheating, allow for enough space around the instrument (see the figure below) and do not block the inlet and vent holes.

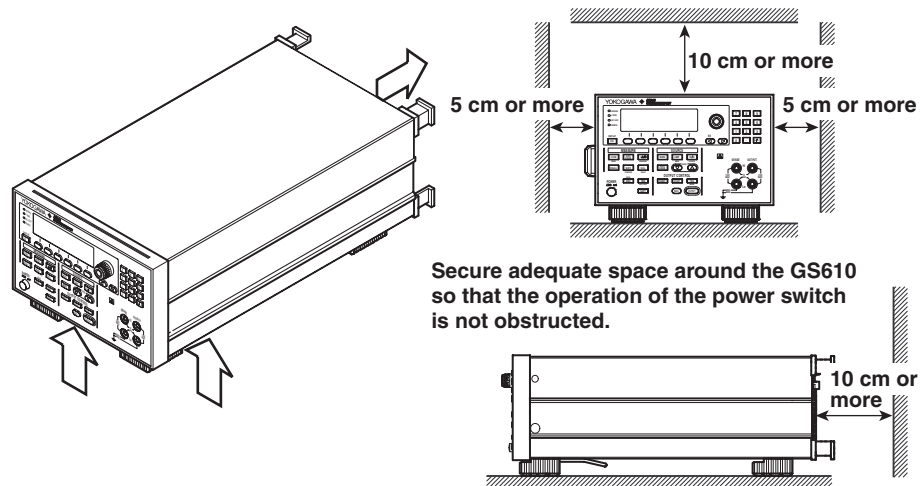

Do not install the recorder in the following places.

- In direct sunlight or near heat sources.
- Where an excessive amount of soot, steam, dust, or corrosive gas is present.
- Near strong magnetic field sources.
- Near high voltage equipment or power lines.
- Where the level of mechanical vibration is high.
- On an unstable surface.

Storage Location

When storing the instrument, avoid the following places:

- A place with a relative humidity of 80% or more.
- In direct sunlight.
- Where the temperature is 60°C or higher.
- Near a high humidity or heat source.
- Where the level of mechanical vibration is high.
- Where corrosive or explosive gas is present.
- Where an excessive amount of soot, dust, salt, and iron are present.
- Where water, oil, or chemicals may splash.

It is recommended that the instrument be stored in an environment where the temperature is between 5 and 40°C and the relative humidity is between 20 and 80% RH.

Rack Mount

When rack mounting the GS610, use the rack mount kit that is sold separately. For the procedure on attaching the GS610 to a rack, see the User's Manual included in the rack mount kit.

Name	Model	Notes
Rack mount kit	751533-E3	For EIA single mount
Rack mount kit	751534-E3	For EIA dual mount
Rack mount kit	751533-J3	For JIS single mount
Rack mount kit	751534-J3	For JIS dual mount

3.3 Connecting to the Power Supply

Before Connecting the Power

To prevent the possibility of electric shock and damage to the instrument, follow the warnings below.



WARNING

- Before connecting the power cord, ensure that the source voltage matches the rated supply voltage of the instrument and that it is within the maximum rated voltage of the provided power cord.
- Connect the power cord after checking that the power switch of the instrument is turned OFF.
- To prevent electric shock or fire, be sure to use the power cord for the instrument that was supplied by YOKOGAWA.
- Make sure to perform protective earth grounding to prevent electric shock. Connect the power cord to a three-prong power outlet with a protective earth terminal.
- Do not use an extension cord without protective earth ground. Otherwise, the protection function will be compromised.
- Use an AC outlet that complies with the power cord provided and securely connect the protective grounding. If such an AC outlet is unavailable and protective grounding cannot be furnished, do not use the instrument.

Connecting the Power Cord

1. Check that the power switch is OFF.
2. Connect the power cord plug to the power connector on the rear panel. (Use the power cord that comes with the package.)
3. Connect the plug on the other end of the power cord to the outlet that meets the conditions below. The AC outlet must be of a three-prong type with a protective earth ground terminal.

Item	Specifications
Rated supply voltage	100 to 120 VAC, 220 to 240 VAC
Permitted supply voltage range	90 to 132 VAC, 198 to 264 VAC
Rated power supply frequency	50/60 Hz
Permitted supply voltage frequency range	48 to 63 Hz
Maximum power consumption	Approx. 200 VA

* The instrument can use a 100-V or a 200-V system for the power supply. Check that the voltage supplied to the instrument is less than or equal to the maximum rated voltage of the provided power cord (see page iii) before using it.

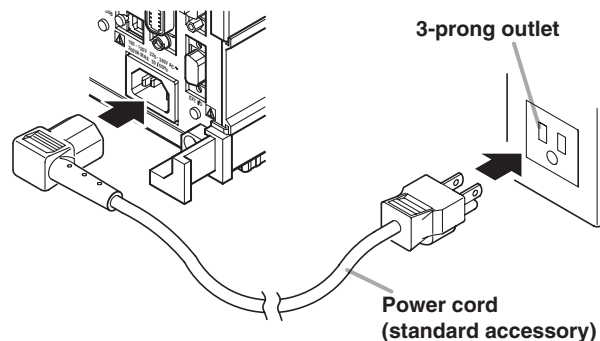

3.4 Turning the Power Switch ON/OFF

Items to Be Checked before Turning ON the Power

- Check that the instrument is installed properly (see section 3.2, “Installation”).
- Check that the power cord is connected properly (see section 3.3, “Connecting the Power Supply”).

Location of the Power Switch and ON/OFF Operation

The power switch is located in the lower left corner of the front panel. The power switch is a push button. Press the button once to turn it “ON” and press it again to turn it “OFF.”

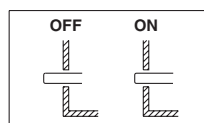
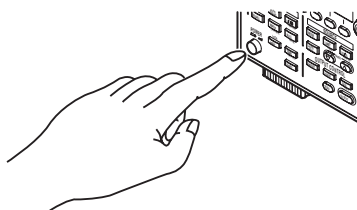

Power ON Operation

When the power switch is turned ON, the self-test starts automatically. When the self-test completes successfully, the GS610 is set to the factory default settings or the settings corresponding to the setup data file you specified in advance (see section 11.3, “Selecting the Power ON Setting”).

Note

- If the GS610 does not operate as described above when the power switch is turned ON, turn OFF the power switch and check the following points:
 - Check that the power cord is securely connected.
 - Check that the voltage supplied from the power outlet is correct. See section 3.3.
 - You can initialize the settings of the GS610. See section 11.2.
 If the GS610 still fails to power up when the power switch is turned ON after checking these points, it is probably a malfunction. Contact your nearest YOKOGAWA dealer for repairs.
- If you are turning the power switch ON after turning it OFF, allow at least 5 s before turning it ON.

For Making Accurate Measurements

At the installation location indicated in section 3.2, allow the instrument to warm up for at least 60 minutes after the power switch is turned ON before starting the use of the instrument.

Shutdown Operation

The setup data and measured results immediately before the power switch is turned OFF are not retained. The same is true when the power cord gets disconnected from the outlet. It is recommended that important setup data be saved to the SETUP directory on the non-volatile disk (GS610ROM) (see section 2.9, “USB Storage Function”).

3.5 Wiring Precautions



WARNING

- Be sure to turn OFF the GS610 output when connecting the DUT.
- Do not connect a voltage source when generating voltage or a current source when generating current. Incorrect connection may damage the GS610.
- Do not exceed a load that exceeds the maximum output indicated below between the OUTPUT Hi and OUTPUT Lo or SENSE Hi and SENSE Lo terminals.

Voltage Source		Current Source	
Range Setting	Maximum Output	Range Setting	Maximum Output
200 mV to 12 V range	±3.2 A	20 μ A to 0.5 A range	±110 V
20 V and 30 V range	±2 A	1 A range	±60 V
60 V range	±1 A	2 A range	±30 V
110 V range	±0.5 A	3 A range	±12 V

- The maximum allowable voltage between the case and each terminal is ± 250 V_{peak}. Applying a voltage exceeding this value can damage the GS610.
- Keep the voltage that is generated between OUTPUT Hi and SENSE Hi as well as OUTPUT Lo and SENSE Lo less than or equal to ± 1 V_{peak}.
- When making a four-terminal connection, be careful that the connection to the SENSE terminal does not get cut. If the voltage is not sensed correctly, abnormal voltage will appear between OUTPUT Hi and OUTPUT Lo terminals.
- When making a two-terminal connection, use the OUTPUT terminals. If you use the SENSE terminals, the current flows through the SENSE line causing damage to the GS610.



CAUTION

- Use conducting wires that have adequate margins of withstand voltage and current capacity with respect to the voltage or current to be used.
- To prevent oscillations due to stray capacitance and lead inductance, use twisted-pair lead wires for connecting the OUTPUT Hi and OUTPUT Lo terminals. Likewise, use twisted-pair lead wires for connecting the SENSE Hi and SENSE Lo terminals.

3.6 Setting the Power Frequency

Procedure

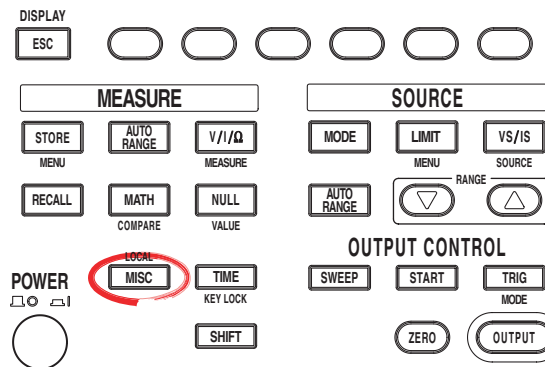

- To exit the menu during operation, press **ESC** at the upper left of the operation panel.
- In the procedural explanation below, the phrase “**rotary knob, numeric keys, <, and >**” are used to refer to the operation of selecting or setting items or entering values using the **rotary knob, numeric keys, <**, and **>** keys (BS key and right arrow key). For details on the operation using the rotary knob, numeric keys, **<**, and **>**, see sections 3.8 or 3.9.

1. Press **MISC** to display the MISC menu.
2. Press the **soft key** to display the System menu.

Remote I/F	Setup	Error Log	Wire 4W 2W	CSV Setting	System
---------------	-------	--------------	---------------	----------------	--------

3. Press the **LineFreq** soft key to select 50 or 60.

External I/O	Beep On Off	Display 1	LineFreq 50 60	Product Info	Next 1/2
-----------------	----------------	--------------	-------------------	-----------------	-------------

Explanation

The power frequency of the GS610 is automatically selected when the power is turned ON. Usually, it does not need to be changed.

The value corresponding to 1 period of the frequency (20 ms or 16.6 ms) in the integration time (see section 7.5, “Setting the Integration Time”) varies depending on the selected power frequency

<<Corresponding Command Mnemonic>>

:SYSTEM:LFrequency

3.7 Setting the Date, Time, and the Time Difference from GMT (Greenwich Mean Time)

Procedure

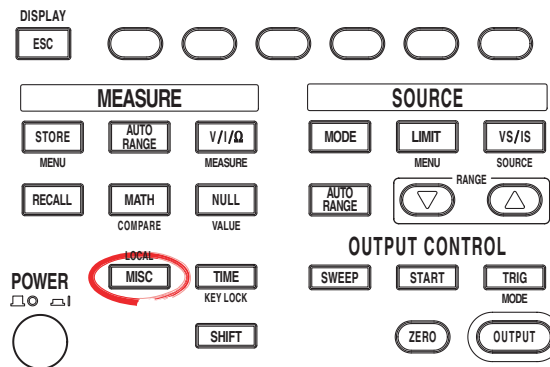

- To exit the menu during operation, press **ESC** at the upper left of the operation panel.
- In the procedural explanation below, the phrase “**rotary knob, numeric keys, <, and >**” are used to refer to the operation of selecting or setting items or entering values using the **rotary knob, numeric keys, <**, and **>** keys (BS key and right arrow key). For details on the operation using the rotary knob, numeric keys, **<**, and **>**, see sections 3.8 or 3.9.

1. Press **MISC** to display the MISC menu.
2. Press the **System** soft key to display the System menu.

Remote I/F	Setup	Error Log	Wire 4W 2W	CSV Setting	System
------------	-------	-----------	------------	-------------	--------

3. Press the **Next 1/2** soft key.

External I/O	Beep On Off	Display 1	LineFreq 50 60	Product Info	Next 1/2
--------------	-------------	-----------	----------------	--------------	----------

Setting the Date and Time

4. Press the **Time Adjust** soft key.

Time Adjust	Time Zone	Selftest	Disk Format	Firmware Update	Next 2/2
-------------	-----------	----------	-------------	-----------------	----------

5. Press the **Edit** soft key.

Time Adjust	2004/02/23	14:40:56			
Edit					

6. Use the **<** and **>** keys to move the cursor to the desired position.
7. Use the **rotary knob** or **numeric keys** to enter the date and time.
8. If you use the numeric keys, press the **Set** soft key to confirm the setting.

Time Adjust	2004/02/23	14:40:56			
					Set

3.7 Setting the Date, Time, and the Time Difference from GMT (Greenwich Mean Time)

Setting the Time Difference from GMT (Greenwich Mean Time)

4. Press the **Time Zone** soft key.

Time Adjust	Time Zone	Selftest	Disk Format	Firmware Update	Next 2/2
-------------	-----------	----------	-------------	-----------------	----------

5. Press the **Edit** soft key.

Time Zone	GMT +00:00				
Edit					

6. Use the < and > keys to move the cursor to the desired position.
7. Use the **rotary knob** or **numeric keys** to enter the time difference.
8. If you use the numeric keys, press the **Set** soft key to confirm the setting.

Time Zone	GMT +00:00				
					Set

Explanation

Setting the Date and Time

- Date (Year/Month/Day)
Set the year, month and day.
- Time (Hour/Minute/Second)
Set the time using a 24-hour clock.

Note

- The date and time settings are backed up with the lithium battery when the power is turned OFF.
- Leap year information is retained.

Setting the Time Difference from GMT (Greenwich Mean Time)

Set the time difference in the range of –12 hours 00 minutes to 13 hours 00 minutes. For example, Japan standard time is ahead of GMT by 9 hours. In this case, set Hour to 9 and Minute to 00.

Checking the Standard Time

Check the standard time for the region where the GS610 is to be used using one of the following methods.

- Check the date and time setting on your PC.
- Check the site at the following URL: <http://www.worldtimeserver.com/>

Note

The GS610 does not support daylight savings time. To set the daylight savings time, adjust the time difference from GMT.

<<Corresponding Command Mnemonic>>

:SYSTem:CLOCK:DATE
:SYSTem:CLOCK:TIME
:SYSTem:CLOCK:TZONE

3.8 Basic Operation of Keys and Rotary Knob

This section describes the basic operations of the keys and rotary knob on the GS610.

Basic Key Operations

Switching the Display

1. Press **ESC (DISPLAY)**. The displays are displayed cyclically in the following order each time you press the ESC (DISPLAY) key: one-value (source) display, one-value (measure) display, two-value (source and measure) display, four-value (source, measure, and limiter values (Hi and Lo)) display.

One-Value (Source) Display

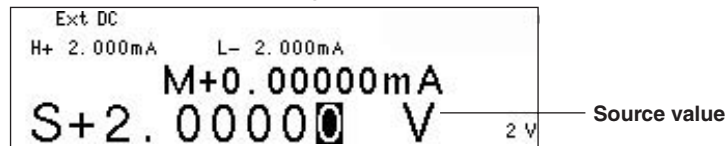

One-Value (Measure) Display

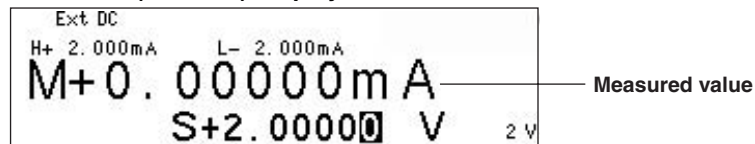

Two-Value (Source and Measure) Display

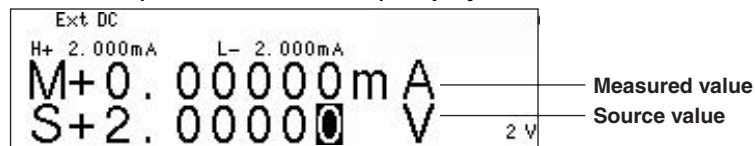

Four-Value (Source, Measure, and Limit Values (Hi and Lo)) Display

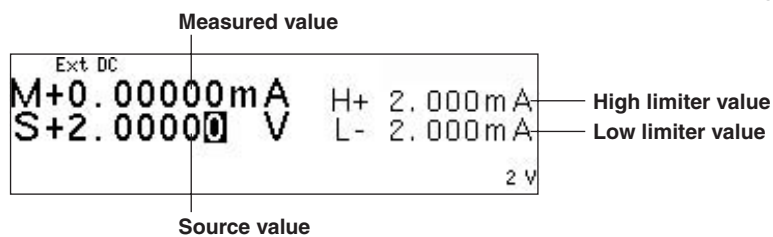

Displaying the Setup Menu of Panel Keys

1. Press a key to display a corresponding setup menu.
2. Press the soft key corresponding to the desired setup menu item.

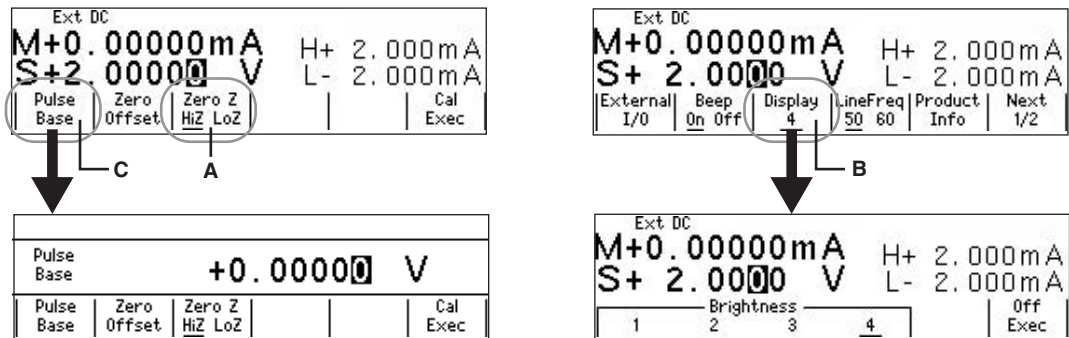

- A: Press the corresponding soft key to switch the setting. The underlined item is selected.
- B: Press the corresponding soft key to display the selection menu. Press the soft key corresponding to a selection to make the selection.
- C: Press the corresponding soft key to select the item to be changed with the numeric keys or rotary knob. Enter the value directly by pressing the numeric keys or set the value by turning the rotary knob. Press the BS (backspace) key and right arrow key to move across the digits.

Note

If the setup menu shows Next 1/2, you can press the Next 1/2 soft key to show the 2/2 menu. To show the 1/2 menu again, press the Next 2/2 soft key.

Clearing the Setup Menu

Press **ESC (DISPLAY)** to switch to the numeric display. If the menu that is shown is under multiple menu levels, press **ESC(DISPLAY)** to move up a level in the menu hierarchy. To switch to the numeric display, press **ESC(DISPLAY)** multiple times.

Note

In the procedural explanations in this manual, the procedure to clear the setup menu are not described.

3.9 Entering Values

Entering Values Using the Rotary Knob

Select the setup item with a soft key. Then, turn the rotary knob to change the value in the numeric entry area (highlighted area). To move across digits, press the BS (backspace) key or the right arrow key.

Entering Values Using Numeric Keys

You can enter a value for the item that has a numeric entry area (highlighted area) shown by pressing the numeric keys. Press the BS key to clear the entered characters one at a time.

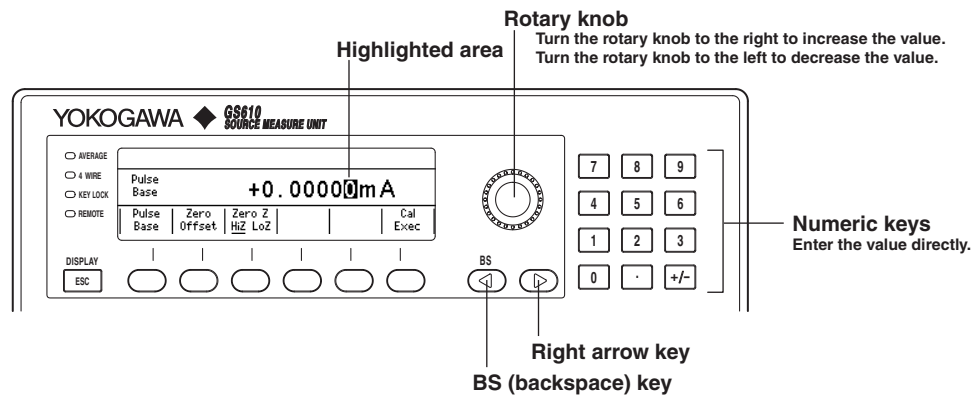

4.1 Setting the Trigger

Procedure

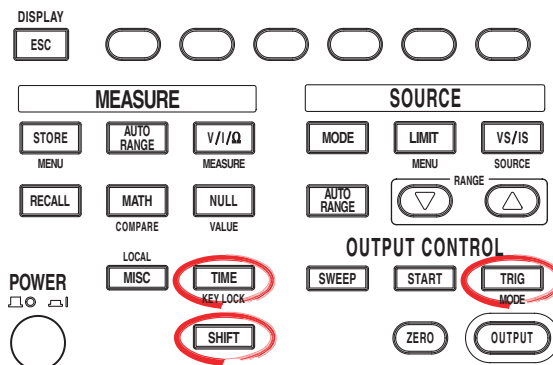

- To exit the menu during operation, press **ESC** at the upper left of the operation panel.
- In the procedural explanation below, the phrase “**rotary knob, numeric keys, <, and >**” are used to refer to the operation of selecting or setting items or entering values using the **rotary knob, numeric keys, <** and **>** keys (BS key and right arrow key). For details on the operation using the rotary knob, numeric keys, **<**, and **>**, see sections 3.8 or 3.9.

Selecting the Trigger Mode

1. Press **SHIFT+TRIG(MODE)** to display the TrigMode menu.
2. Select the desired trigger mode from Int, Ext, and Imm.
If the measurement is OFF (Measure OFF) (see section 7.1, “Turning the Measurement ON/OFF”), Imm cannot be selected.



If the trigger mode is set to Int, proceed to step 3.

Setting the Repeat Period

3. Press **TIME** to display the Time menu.
4. Press the **Period** soft key.



5. Use the **rotary knob** or **numeric keys and < and > keys** to set the repeat period.

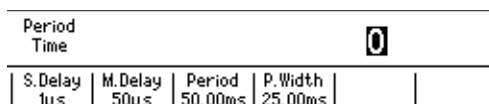

6. If you use the numeric keys, press a soft key corresponding to the desired unit or the **Enter** soft key to confirm the setting.



Manual Trigger

A trigger is activated each time you press TRIG.

Explanation

Trigger Mode

There are three trigger modes for starting the source measure cycle.

Int (Internal): Periodic internal trigger.

Ext (External): Manual trigger by applying an external signal or pressing the TRIG key.

Imm (Immediate): Starts the next source measure cycle immediately after the current source measure cycle is complete.

The selected trigger mode is used to trigger the following operations.

- Source measure cycle measurement and pulse generation
- Start the sweep when the sweep function is enabled

Repeat Period

If the trigger mode is set to Int, the repeat period is valid. The trigger is activated according to the specified repeat period. When a trigger is activated, the TRIG key illuminates to notify the trigger generation.

The selectable range is 100 μ s to 3600.000000 s.

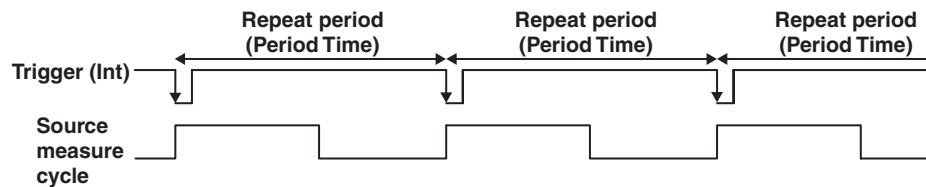

Manual Trigger

A trigger is activated when you press the TRIG key regardless of the selected trigger mode.

<<Corresponding Command Mnemonic>>

:TRIGger:SOURce

:TRIGger:TIMer

*TRG

4.2 Connection Type (Remote Sense and Local Sense)

Procedure

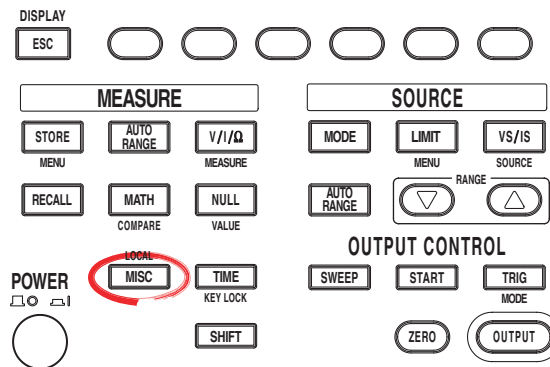

- To exit the menu during operation, press **ESC** at the upper left of the operation panel.
- In the procedural explanation below, the phrase “**rotary knob, numeric keys, <, and >**” are used to refer to the operation of selecting or setting items or entering values using the **rotary knob, numeric keys, <**, and **>** keys (BS key and right arrow key). For details on the operation using the rotary knob, numeric keys, **<**, and **>**, see sections 3.8 or 3.9.

Selecting the Connection Type (Remote Sense or Local Sense)

- Press **MISC** to display the MISC menu.
- Press the **Wire** soft key to select 4W or 2W. If you select 4W, the remote sense indicator (4WIRE) at the left of the display illuminates.

```
| Remote | Setup | Error | Wire | CSV | System |
| I/F   |       | Log  | 4W 2W | Setting |       |
```

Explanation

The GS610 has two types of sensing, 2W and 4W.

2W: Two-terminal connection (local sense)

4W: Four-terminal connection (remote sense)

The connection diagrams are given on the next page.

If the current flowing through the Hi and Lo terminals is small, select two-terminal connection (2W). When the output current is large, a voltage error occurs between the Hi and Lo terminals that are being sensed due to the effects of the lead wire resistance. In such case, select four-terminal connection (4W) and connect the measurement lead from the SENSE terminal close to the DUT. This enables the voltage to be sensed with the effects of the lead wire resistance reduced. This function is effective when the current is large and the voltage appearing at the DUT is small such as in a low resistance measurement.

Note

When making a four-terminal connection, be careful that the connection to the SENSE terminal does not get cut. If it does, an error occurs in the voltage between the Hi and Lo terminals, because the voltage is not sensed correctly.

When making a two-terminal connection, use the OUTPUT terminals. If the SENSE terminal is used, the GS610 cannot generate the voltage or current correctly and can cause a malfunction.

4.2 Connection Type (Remote Sense and Local Sense)

• Two-terminal connection

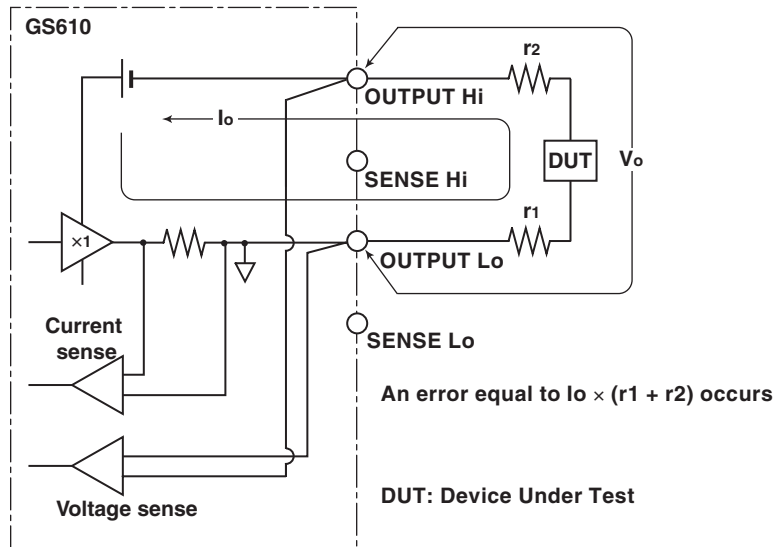

• Four-terminal connection

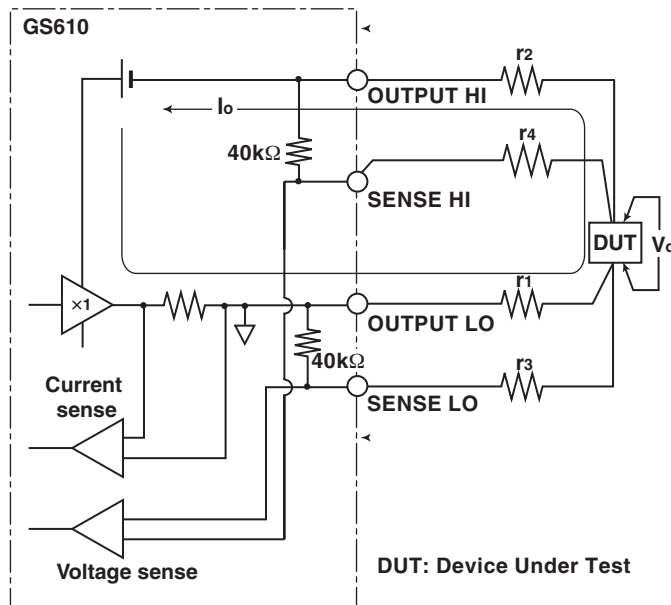

An error approximately equal to $I_o \times \left(\frac{r_1 \cdot r_3}{40k\Omega + r_3 + r_1} + \frac{r_2 \cdot r_4}{40k\Omega + r_4 + r_2} \right)$ occurs, but the effects are small if r_1 to r_4 are adequately small.

Note

If 4W (four-terminal connection) is used, the source voltage between the Hi OUTPUT and Lo OUTPUT terminals is greater than the voltage generated at the load. If the source voltage between the Hi OUTPUT and Lo OUTPUT terminals exceeds the source range, the GS610 cannot generate the voltage correctly, and abnormal load detection may be activated causing the output to be turned OFF. Be sure that the source voltage between the Hi OUTPUT and Lo OUTPUT terminals do not exceed the source range of the range setting.

<<Corresponding Command Mnemonic>>

:SENSE:RSENse

4.3 USB Storage Function

Connecting the USB Cable

1. Connect one end of the USB cable to the USB port on the GS610 rear panel.

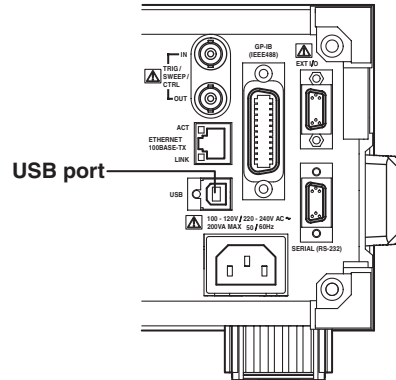

2. Connect the other end of the cable to the USB port on the PC.
3. After connecting the USB cable correctly, turn ON the power switch of the GS610. Two removable disks named GS610ROM and GS610RAM appear within My Computer on the PC.

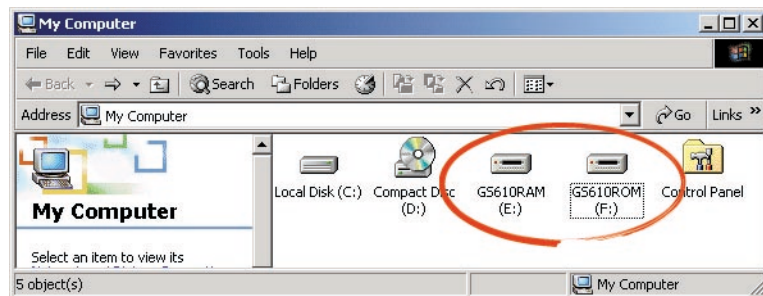

USB Storage Function

GS610ROM

A non-volatile disk with preset directories for different purposes. Various files are stored in the appropriate directories.

- **MATH**

Stores definition files of equations that you select when carrying out computation using equations.

When shipped from the factory and when the disk is formatted, built-in computation files are stored in this directory.

- **PROGRAM**

Stores program sweep pattern files that you select when carrying out program sweep.

When shipped from the factory or when the disk is formatted, sample pattern files are stored in this directory.

- **SETUP**

Stores the GS610 panel setup data that you select when settings are loaded.

When shipped from the factory or when the disk is formatted, a default setup file is stored in this directory.

GS610RAM

A RAM disk that is automatically formatted when the power is turned ON. It is a volatile disk used to exchange files with the PC. The result file (Result.csv) is created in this directory when the storage operation is carried out. If the settings are saved to the GS610RAM, the current settings are saved to a file named Setup.txt.

When updating the system firmware, the system file (System.bin) is written in this directory from a PC. For details, see section 17.5, "Updating the System Firmware."

Formatting the Disk

If GS610ROM and GS610RAM cannot be detected on the PC, if you wish to set the GS610 to factory default conditions, or if the disk is corrupt, you must format the disk.

Procedure

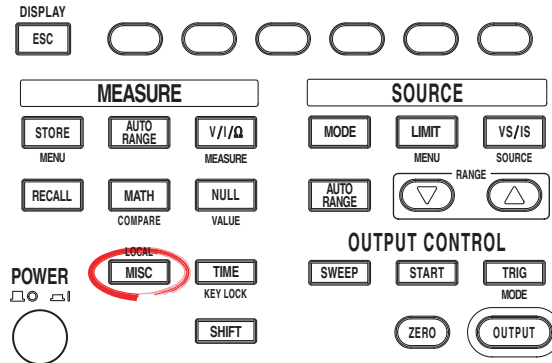

- To exit the menu during operation, press **ESC** at the upper left of the operation panel.
- In the procedural explanation below, the phrase “**rotary knob, numeric keys, <, and >**” are used to refer to the operation of selecting or setting items or entering values using the **rotary knob, numeric keys, <**, and **>** keys (BS key and right arrow key). For details on the operation using the rotary knob, numeric keys, **<**, and **>**, see sections 3.8 or 3.9.

- Press **MISC** to display the MISC menu.
- Press the **System** soft key.

Remote I/F	Setup	Error Log	Wire 4W 2W	CSV Setting	System
------------	-------	-----------	------------	-------------	--------

- Press the **Next 1/2** soft key.

External I/O	Beep On Off	Display 1	LineFreq 50 60	Product Info	Next 1/2
--------------	-------------	-----------	----------------	--------------	----------

- Press the **DiskFormat** soft key.

Time Adjust	Time Zone	SelfTest	Disk Format	Firmware Update	Next 2/2
-------------	-----------	----------	-------------	-----------------	----------

- Press the **Exec** soft key to execute the disk format.

					Exec
--	--	--	--	--	------

Note

- Always format the disk from the GS610 menu. If you format the disk from a PC, default directories such as MATH and default files are not created.
- You can also create subdirectories and write files to the disk, but be sure that the disk does not become full.
- Do not change the existing directory names such as MATH. If you do, you will no longer be able to select files from the GS610.

5.1 Switching the Source Function

Procedure

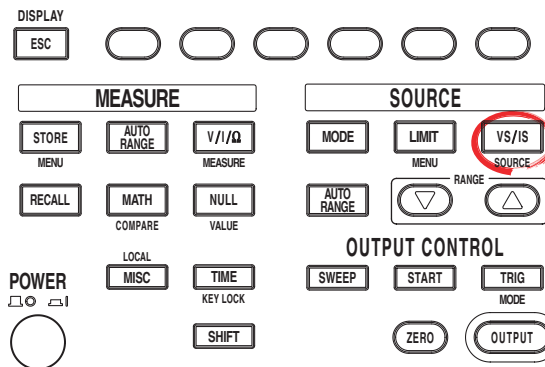

- To exit the menu during operation, press **ESC** at the upper left of the operation panel.
- In the procedural explanation below, the phrase “**rotary knob, numeric keys, <, and >**” are used to refer to the operation of selecting or setting items or entering values using the **rotary knob, numeric keys, <**, and **>** keys (BS key and right arrow key). For details on the operation using the rotary knob, numeric keys, **<**, and **>**, see sections 3.8 or 3.9.

Press **VS/IS**.

Each time you press the key, the source function toggles between voltage (V, mV) and current (μ A, mA, A).

Explanation

The source function (S on the display) is indicated by the unit of the source value (V for voltage and A for current).

Example

When the source function is voltage

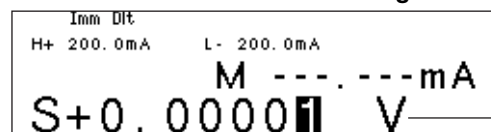

When the source function is current

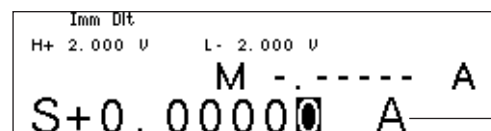

Note

- If you switch the source function, the output is turned OFF. The source value shows the value that was set previously for the switched source function.
- Be sure to check that the load is connected correctly before turning the output ON after switching the source function.

<<Corresponding Command Mnemonic>>

:SOURCE:FUNCTION

5.2 Setting the Source Range Setting

Procedure

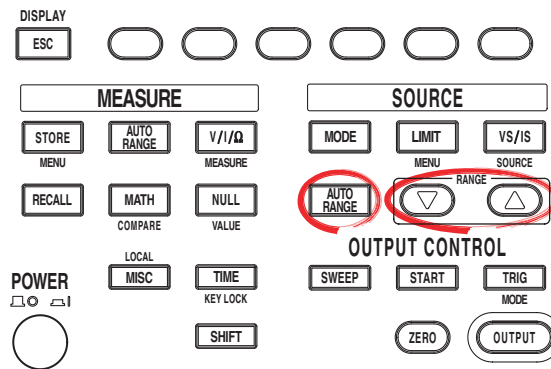

- To exit the menu during operation, press **ESC** at the upper left of the operation panel.
- In the procedural explanation below, the phrase “**rotary knob, numeric keys, <, and >**” are used to refer to the operation of selecting or setting items or entering values using the **rotary knob, numeric keys, <**, and **>** keys (BS key and right arrow key). For details on the operation using the rotary knob, numeric keys, <, and >, see sections 3.8 or 3.9.

There are two source range settings, fixed range and auto range.

Changing the Fixed Range Setting

Press the **RANGE** Δ or ∇ key to change the source range setting.

Auto Range

Press **AUTO RANGE** under SOURCE. The auto range function is turned ON, and the AUTO RANGE key illuminates.

Explanation**Note**

- If you change the range setting while a capacitive or inductive load such as a capacitor or coil is connected, an abnormal load may be detected due to the energy built up in the load may cause the output to be turned OFF.
- When you change the range setting, the source level zero state occurs transiently. If you wish to vary the source level continuously, set the maximum range setting that is needed so that the range setting does not change.

Fixed Range

The GS610 generates the source signal at the selected range setting. The range setting can be changed with the RANGE \triangle and ∇ keys while the source signal is being generated.

Voltage Source Range Setting

Source Range Setting	Source Range	Resolution
200 mV	± 205.000 mV	1 μ V
2 V	± 2.05000 V	10 μ V
12 V	± 12.0000 V	100 μ V
20 V	± 20.5000 V	100 μ V
30 V	± 30.000 V	1 mV
60 V	± 60.000 V	1 mV
110 V	± 110.000 V	1 mV

Current Source Range Setting

Source Range Setting	Source Range	Resolution
20 μ A	± 20.5000 μ A	100 pA
200 μ A	± 205.000 μ A	1 nA
2 mA	± 2.05000 mA	10 nA
20 mA	± 20.5000 mA	100 nA
200 mA	± 205.000 mA	1 μ A
0.5 A	± 0.50000 A	10 μ A
1 A	± 1.00000 A	10 μ A
2 A	± 2.00000 A	10 μ A
3 A	± 3.20000 A	10 μ A

Note

- Changing the range setting normally does not change the specified source value. However, if the fractional part is rounded in the source range of the new range setting or the source value falls outside the source range, the source value is set to zero.
- If you enter a source value exceeding the specified range setting, the maximum value of the source range is displayed, and a beep sound (see section 11.4, "Turning the Beep Sound ON/OFF") is generated (when the beep sound is enabled).

Auto Range

When turned ON, the range setting with the highest resolution that includes the source level is automatically selected. There is no need to select the range setting. However, switching the range setting takes time, and the source level may be discontinuous, if the range setting switches as a result of changing the source level.

<<Corresponding Command Mnemonic>>

```
:SOURce:VOLTage:RANGe
:SOURce:VOLTage:RANGe:AUTO
:SOURce:CURREnt:RANGe
:SOURce:CURREnt:RANGe:AUTO
```

5.3 Setting the Limiter

Procedure

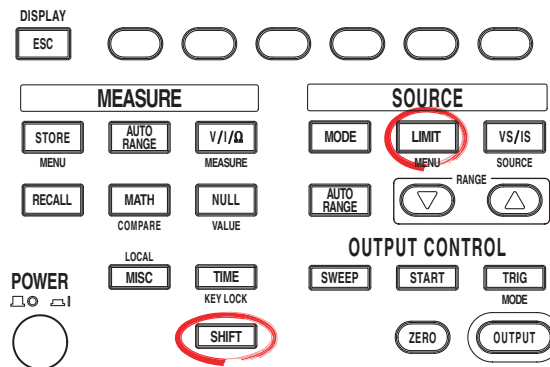

- To exit the menu during operation, press **ESC** at the upper left of the operation panel.
- In the procedural explanation below, the phrase “**rotary knob, numeric keys, <, and >**” are used to refer to the operation of selecting or setting items or entering values using the **rotary knob, numeric keys, <**, and **>** keys (BS key and right arrow key). For details on the operation using the rotary knob, numeric keys, **<**, and **>**, see sections 3.8 or 3.9.

Turning the Limiter ON/OFF

1. Press **SHIFT+LIMIT (MENU)** to display the limiter setup menu.
2. Press the **Limit** soft key to turn the limiter ON or OFF.

Limit	Tracking				
On Off	On Off				

Turning the Tracking ON/OFF

3. Press the **Tracking** soft key to turn the tracking function ON or OFF.

Limit	Tracking				
On Off	On Off				

Setting the Limiter Value

4. Press **LIMIT** to display the limiter value setup screen.
5. Use the **rotary knob** or **numeric keys and < and > keys** to set the limiter value.

If tracking is turned ON in step 3, the high and low limiter values can be set simultaneously.

High/Low Limit	$\pm 200.0 \text{ mA}$				

If tracking is turned OFF in step 3, the high and low limiter values can be set separately.

High Limit	$+200.0 \text{ mA}$				
High Limit	Low Limit				

6. If you set the limiter value using the numeric keys, press the desired unit or the **Enter** soft key.

High Limit	$+ 100$				
	μA	mA	A	Enter	

Explanation**Turning the Limiter ON/OFF**

ON: Apply the limit with the specified limiter values.

OFF: The limiter is activated at the maximum value of the source range (see section 2.2). However, the limiter value is not displayed.

Tracking

ON: Set the limiter values with the same absolute value but with opposite signs.

Example Hi limiter value: +1.000 mA

Lo limiter value: -1.000 mA

OFF: Set the limiter values to arbitrary values with opposite signs.

Example Hi limiter value: +1.500 mA

Lo limiter value: -1.000 mA

Setting the Limiter Value

The current limiter is selected when generating voltage, and the voltage limiter is automatically selected when generating current.

The optimal range for the specified limiter values is automatically selected.

- **Limiter Range**

Current

ILimiter Value ^{*1}	Range Setting	Resolution	Minimum Limit Value ^{*2}
0.10 μ A to 20.00 μ A	20 μ A	10 nA	100 nA
20.1 μ A to 200.0 μ A	200 μ A	100 nA	1 μ A
0.201 mA to 2.000 mA	2 mA	1 μ A	10 μ A
2.01 mA to 20.00 mA	20 mA	10 μ A	100 μ A
20.1 mA to 200.0 mA	200 mA	100 μ A	1 mA
0.201 A to 3.200 A	3 A	1 mA	10 mA

*1 When tracking is OFF, |Hi| or |Lo|, whichever is greater.

*2 Minimum value when tracking is OFF.

Voltage

ILimiter Value ^{*3}	Range Setting	Resolution	Minimum Limit Value ^{*4}
1.0 mV to 200.0 mV	200 mV	100 μ V	1 mV
0.201 V to 2.000 V	2 V	1 mV	10 mV
2.01 V to 20.00 V	20 V	10 mV	100 mV
20.1 V to 110.0 V	110 V	100 mV	1 V

*3 When tracking is OFF, |Hi| or |Lo|, whichever is greater.

*4 Minimum value when tracking is OFF.

Display When the Limiter Is Activated

When the high limiter is activated: High limiter activation display (H)

When the low limiter is activated: Low limiter activation display (L)

Note

- If the limit values are set outside the source range of the selected range setting, the limiter is activated at the boundary of the source range.
- If the limiter range is changed, the limiter level is transiently reduced to 10% of the range setting and moves sequentially to the adjacent ranges.

<<Corresponding Command Mnemonic>>

```
:SOURce:VOLTage:PROTection[:STATe]
:SOURce:VOLTage:PROTection:LINKage
:SOURce:VOLTage:PROTection:ULIMit
:SOURce:VOLTage:PROTection:LLIMit
:SOURce:CURREnt:PROTection[:STATe]
:SOURce:CURREnt:PROTection:LINKage
:SOURce:CURREnt:PROTection:ULIMit
:SOURce:CURREnt:PROTection:LLIMit
```

5.4 Setting the DC Source Mode

Procedure

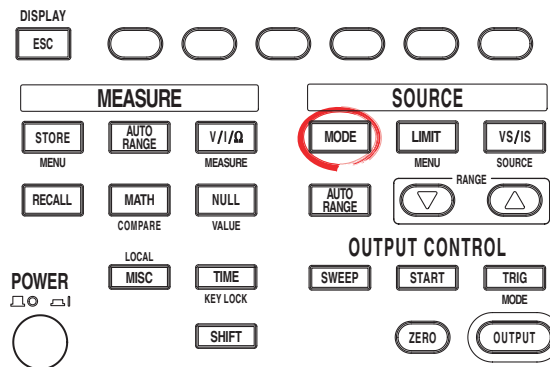

- To exit the menu during operation, press **ESC** at the upper left of the operation panel.
- In the procedural explanation below, the phrase “**rotary knob, numeric keys, <, and >**” are used to refer to the operation of selecting or setting items or entering values using the **rotary knob, numeric keys, <**, and **>** keys (BS key and right arrow key). For details on the operation using the rotary knob, numeric keys, **<**, and **>**, see sections 3.8 or 3.9.

1. Press **MODE** to display the source mode menu.

Selecting the DC Source Mode

2. Press the **DC** soft key.



Setting the Source Value (Source Level)

3. Use the **rotary knob** or **numeric keys and < and > keys** to set the source value.

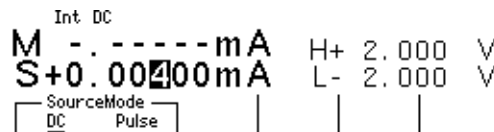

4. If you use the numeric keys, press a soft key corresponding to the desired unit or the **Enter** soft key to confirm the setting.

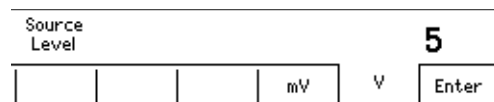

Explanation**DC Source Mode**

If the sweep mode (see section 2.6, “Sweep”) is ON in DC source mode, the source level changes after a time specified by the source delay elapses from the point in which the trigger is activated. Then, measurement starts after a time specified by measurement delay elapses. When the measurement and computation are complete, one source measure cycle is finished.

However, if you change the source level with a key or a communication command in the middle of a source measure cycle, the source level changes immediately without waiting for the source delay or measure delay, and the internal trigger phase is reset.

If the sweep mode is OFF, the source level is maintained, and the source measure cycle is carried out.

If the measurement function is turned OFF (see section 2.4, “Measurement”), measure delay, measurement, and computation are not carried out. The time when the source level changes is the end of the source measure cycle.

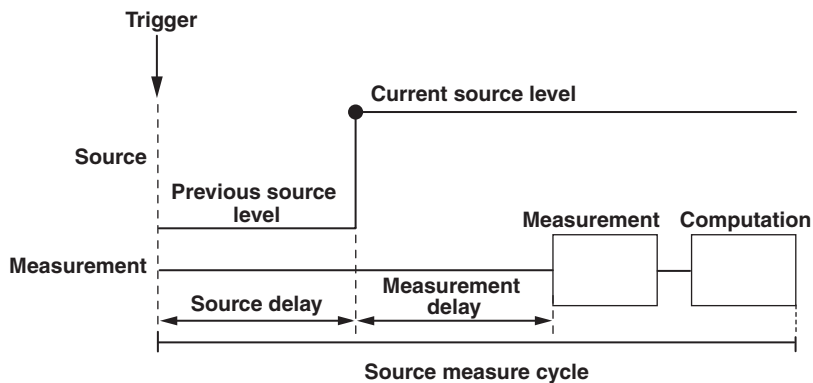
**Selectable Range of Source Values (Source Levels)**

See section 5.2, “Source Range Settings.”

Note

The output capacitance indicated below exists between the Hi OUTPUT and Lo OUTPUT terminals of the GS610. This capacitance produces the following effects.

- If the load changes drastically such as when a short circuit occurs when generating voltage, a large transient discharge current is generated from the output capacitance.
- If a voltage source (power supply, amplifier, signal generator, etc.) is connected as a load, the load voltage source may be unstable due to the output capacitance.
- Take the time it takes for the output capacitance to be charged and discharged when determining the response time of the source voltage.

Current Range Setting, Current Limiter Range	Output Capacitance
20 μ A, 200 μ A, 2 mA	5 μ F or less
20 mA	0.55 μ F or less
200 mA	0.05 μ F or less
3 A, 2 A, 1 A, 0.5 A	0.02 μ F or less

<<Corresponding Command Mnemonic>>

:SOURce:SHAPE
 :SOURce:VOLTage:LEVel
 :SOURce:CURREnt:LEVel

5.5 Setting the Pulse Source Mode

Procedure

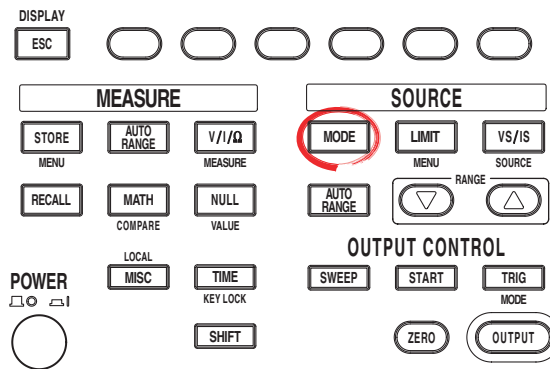

- To exit the menu during operation, press **ESC** at the upper left of the operation panel.
- In the procedural explanation below, the phrase “**rotary knob, numeric keys, <, and >**” are used to refer to the operation of selecting or setting items or entering values using the **rotary knob, numeric keys, <**, and **>** keys (BS key and right arrow key). For details on the operation using the rotary knob, numeric keys, **<**, and **>**, see sections 3.8 or 3.9.

1. Press **MODE** to display the source mode menu.

Selecting the Pulse Source Mode

2. Press the **Pulse** soft key.



Setting the Source Value (Source Level)

3. Use the **rotary knob** or **numeric keys and < and > keys** to set the source value.

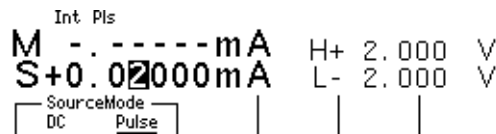

4. If you use the numeric keys, press a soft key corresponding to the desired unit or the **Enter** soft key to confirm the setting.

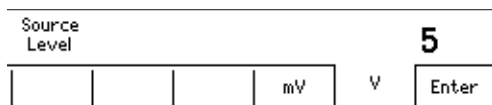

Setting the Pulse Base Value

5. Press **SHIFT+VS/IS(SOURCE)** to display the SOURCE menu.
6. Press the **Pulse Base** soft key.

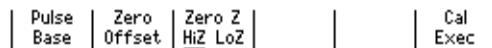

7. Use the **rotary knob** or **numeric keys and < and > keys** to set the pulse base value.

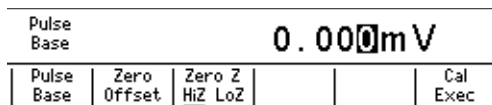

- If you use the numeric keys, press a soft key corresponding to the desired unit or the **Enter** soft key to confirm the setting.

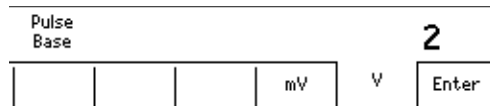

Setting the Pulse Width

- Press **TIME** to display the TIME menu.
- Press the **P.Width** soft key.

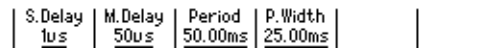

- Use the **rotary knob** or **numeric keys and < and > keys** to set the source voltage.

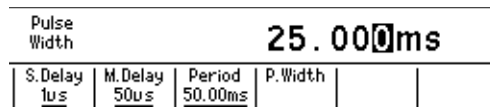

- If you use the numeric keys, press a soft key corresponding to the desired unit or the **Enter** soft key to confirm the setting.



Explanation

Pulse Source Mode

In pulse source mode, the pulse is specified by two values, the pulse base value and the source level. The minimum pulse width is 100 μs. As with the DC source mode, the source level changes after a time specified by the source delay elapses from the point in which the trigger is activated. Furthermore, the measurement starts after a time specified by the measurement delay elapses. The source level changes at the same the measure delay is activated and returns to the pulse base value after the pulse width. A source measure cycle is finished at the end of the pulse or at the end of the measurement and computation, whichever comes later. If the measurement function (see section 2.4, “Measurement”) is turned OFF, measure delay, measurement, and computation are not carried out. The end of the pulse is the end of a source measure cycle.

When the End of the Measurement and Computation Is after the End of the Pulse Generation

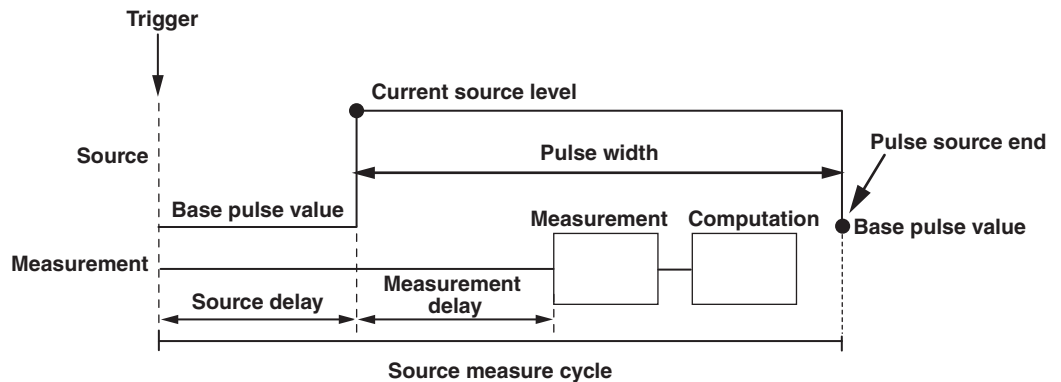

5.5 Setting the Pulse Source Mode

When the End of the Measurement and Computation Is before the End of the Pulse Generation

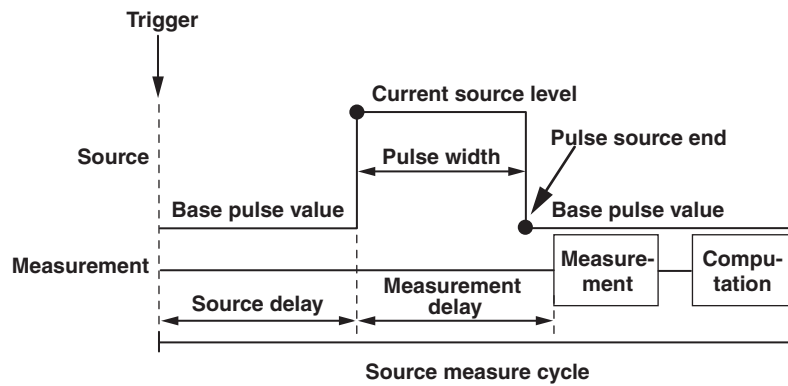

Selectable Range Source Values (Source Level)

See section 5.2, "Source Range Settings."

Selectable Range of Pulse Base Values

The pulse base value is the same as the source value (source level).

Note

If the source range setting is auto range, the range setting appropriate for the larger of the two values |source value| and |pulse base value| is applied.

Selectable Range of Pulse Width

100 μ s to 3600.000000 s

Note

If a capacitive or inductive load is connected, the limiter is activated transiently, and the settling time is increased.

If a capacitive load is connected, the output capacitance of the GS610 is also added. Be careful of the settling time.

<<Corresponding Command Mnemonic>>

```
:SOURCE:SHAPE
:SOURCE:VOLTage:LEVel
:SOURCE:VOLTage:PBASe
:SOURCE:CURREnt:LEVel
:SOURCE:CURREnt:PBASe
:SOURCE:PULSe:WIDTh
```

5.6 Setting the Source Delay

Procedure

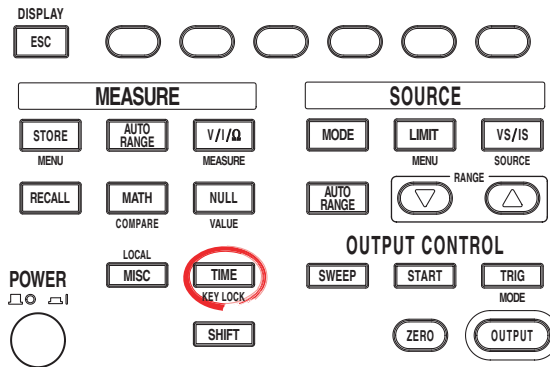

- To exit the menu during operation, press **ESC** at the upper left of the operation panel.
- In the procedural explanation below, the phrase “**rotary knob, numeric keys, <, and >**” are used to refer to the operation of selecting or setting items or entering values using the **rotary knob, numeric keys, <** (left arrow key), and **>** (right arrow key) keys (BS key and right arrow key). For details on the operation using the rotary knob, numeric keys, <, and >, see sections 3.8 or 3.9.

1. Press **TIME** to display the Time menu.
2. Press the **S.Delay** soft key to display the source delay setup screen.

S.Delay	M.Delay	Period	P.Width		
1 μ s	50 μ s	50.00ms	25.00ms		

3. Use the **rotary knob** or **numeric keys and < and > keys** to set the source delay.

Source Delay			1 μ s		
S.Delay	M.Delay	Period	P.Width		
	50 μ s	50.00ms	25.00ms		

4. If you use the numeric keys, press a soft key corresponding to the desired unit or the **Enter** soft key to confirm the setting.

Source Delay			5		
	μ s	ms	s	Enter	

5.6 Setting the Source Delay

Explanation

Source Delay

The wait time from trigger input to the start of source change can be specified.

Selectable Range

1 μ s to 3600.000000 s

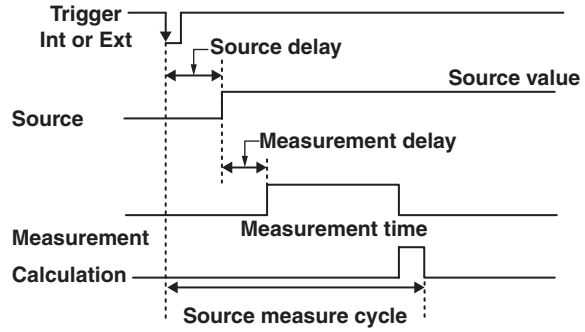

<<Corresponding Command Mnemonic>>

:SOURce:DELay

5.7 Turning the Output ON/OFF

Procedure

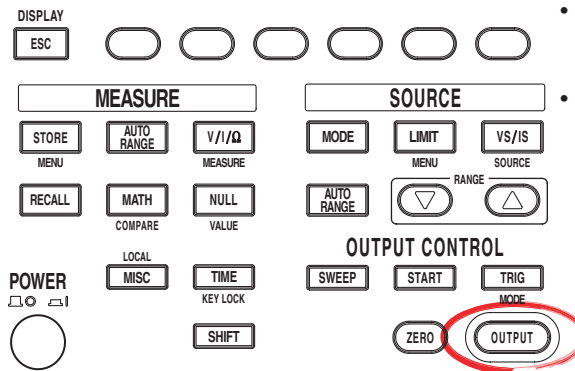

- To exit the menu during operation, press **ESC** at the upper left of the operation panel.
- In the procedural explanation below, the phrase “**rotary knob, numeric keys, <, and >**” are used to refer to the operation of selecting or setting items or entering values using the **rotary knob, numeric keys, <**, and **>** keys (BS key and right arrow key). For details on the operation using the rotary knob, numeric keys, **<**, and **>**, see sections 3.8 or 3.9.

Output ON

Press **OUTPUT**. The OUTPUT key illuminates while the output is ON.

Output OFF

Press **OUTPUT** while generating the signal to stop the output. When the output stops, the OUTPUT key turns OFF.

Explanation

Output ON

The output relay is activated, and source measure cycle is repeated.

Output OFF

The output relay is disconnected, and the source measure cycle stops.

Note

When the output relay is activated, the source level is set to zero.

- **When Output Is ON**

The output relay turns ON with the source level set to zero. After the output relay is activated, the source level is changed to the specified source value.

- **When Output Is OFF**

The source level is set to zero, and the output relay is turned OFF.

<<Corresponding Command Mnemonic>>

:OUTPut [:STATe]

5.8 Zero Generation

Procedure

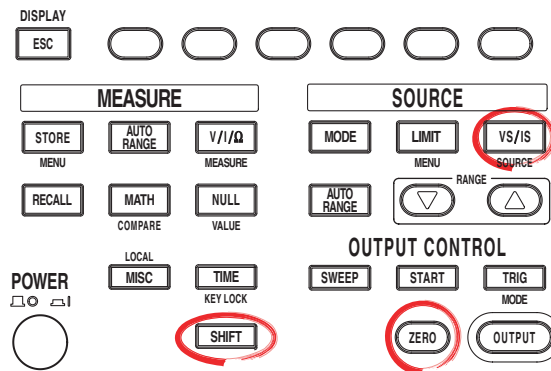

- To exit the menu during operation, press **ESC** at the upper left of the operation panel.
- In the procedural explanation below, the phrase “**rotary knob, numeric keys, <, and >**” are used to refer to the operation of selecting or setting items or entering values using the **rotary knob, numeric keys, <**, and **>** keys (BS key and right arrow key). For details on the operation using the rotary knob, numeric keys, **<**, and **>**, see sections 3.8 or 3.9.

Zero Generation

Press **ZERO** when generating the signal or press the **SHIFT+ZERO** key when the output is OFF to generate a zero level signal.

Setting the Zero Offset

1. Press **SHIFT+VS/IS(SOURCE)** to display the SOURCE menu.
2. Press the **Zero Offset** soft key.

Pulse	Zero	Zero Z		Cal
Base	Offset	HiZ LoZ		Exec

3. Use the **rotary knob** or **numeric keys and < and > keys** to set the zero offset voltage.

Zero Offset		99 V		
Pulse	Zero	Zero Z		Cal
Base	Offset	HiZ LoZ		Exec

4. If you use the numeric keys, press a soft key corresponding to the desired unit or the **Enter** soft key to confirm the setting.

Zero Offset		1.0		
		mV	V	Enter

Zero Source Impedance

5. Press the **Zero Z** soft key to select HiZ or LoZ.

Pulse	Zero	Zero Z		Cal
Base	Offset	HiZ LoZ		Exec

Explanation**Zero Generation**

When generating voltage, 0 V is generated. When generating current, 0 A is generated.

Setting the Zero Offset

An offset can be specified on the zero value when generating zero output.

Selectable Range of Zero Offset

–110.000 V to 110.000 V

Note

If the zero offset value exceeds the source range of the selected range setting, the zero offset is set to the upper or lower limit of the range setting.

Setting the Zero Source Impedance

The impedance when generating a zero level signal can be selected.

- **When Low Impedance (LoZ) Is Selected When Generating Voltage or When High Impedance (HiZ) Is Selected When Generating Current**

The source value is set to 0.

- **When High Impedance (HiZ) Is Selected When Generating Voltage or When Low Impedance (LoZ) Is Selected When Generating Current**

The source value is set to 0, and the limiter is set to 0.5% of the range setting.

<<Corresponding Command Mnemonic>>

```
:OUTPut [ :STATe ]
:SOURce:VOLTage:ZERO:OFFSet
:SOURce:VOLTage:ZERO:IMPedance
:SOURce:CURREnt:ZERO:OFFSet
:SOURce:CURREnt:ZERO:IMPedance
```

5.9 Offset Calibration

Procedure

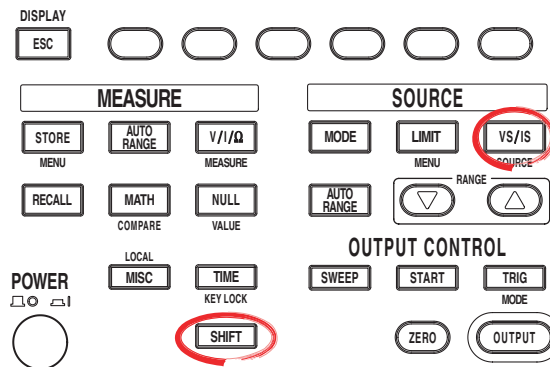

- To exit the menu during operation, press **ESC** at the upper left of the operation panel.
- In the procedural explanation below, the phrase “**rotary knob, numeric keys, <, and >**” are used to refer to the operation of selecting or setting items or entering values using the **rotary knob, numeric keys, <**, and **>** keys (BS key and right arrow key). For details on the operation using the rotary knob, numeric keys, <, and >, see sections 3.8 or 3.9.

1. Press **SHIFT+VS/IS(SOURCE)** to display the SOURCE menu.
2. Press the **CalExec** soft key to carry out the calibration.

Pulse	Zero	Zero Z		Cal
Base	Offset	HiZ LoZ		Exec

Explanation

Carry out calibration when correcting the offset drift of the source value such as due to temperature changes.

Note

The offset calibration is valid only for the range setting at which the calibration is carried out. The calibration setting is initialized when the power is cycled.

<<Corresponding Command Mnemonic>>

*CAL?

6.1 Setting the Linear or Log Sweep

Procedure

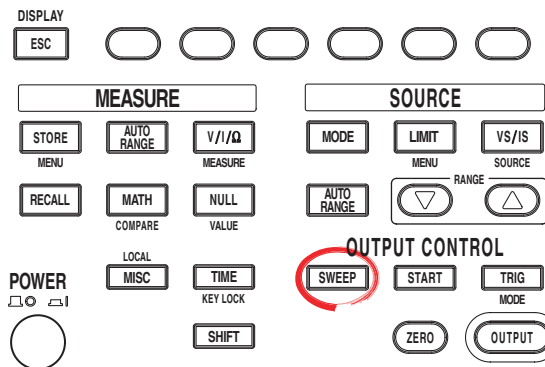

- To exit the menu during operation, press **ESC** at the upper left of the operation panel.
- In the procedural explanation below, the phrase “**rotary knob, numeric keys, <, and >**” are used to refer to the operation of selecting or setting items or entering values using the **rotary knob, numeric keys, <** and **>** keys (BS key and right arrow key). For details on the operation using the rotary knob, numeric keys, **<** and **>**, see sections 3.8 or 3.9.

1. Press **SWEEP** to display the SWEEP menu.
2. Press the **Mode** soft key to display the SWEEP mode menu.

Mode	Last	Repeat			
Off	Rtn Keep	1			

Setting the Linear Sweep

3. Press the **Linear** soft key. The SWEEP key illuminates. If you select Off, the key turns OFF.

SweepMode				
Off	Linear	Log	Program	

Setting the Start Value

4. Press the **Start Value** soft key.

Mode	Last	Repeat	Start	Stop	Step
Linear	Rtn Keep	1	Value	Value	Value

5. Use the **rotary knob** or **numeric keys and < and > keys** to set the start value.

Start Value	+ 100.00 mV				
Mode	Last	Repeat	Start	Stop	Step
Linear	Rtn Keep	1	Value	Value	Value

6. If you use the numeric keys, press a soft key corresponding to the desired unit or the **Enter** soft key to confirm the setting.

Start Value	+ 100				
			mV	V	Enter

6.1 Setting the Linear or Log Sweep

Setting the Stop Value

- Press the **Stop Value** soft key.

Mode	Last	Repeat	Start	Stop	Step
Linear	Rtn Keep	1	Value	Value	Value

- Use the **rotary knob** or **numeric keys and < and > keys** to set the stop value.

Stop Value	+200.000mV				
Mode	Last	Repeat	Start	Stop	Step
Linear	Rtn Keep	1	Value	Value	Value

- If you use the numeric keys, press a soft key corresponding to the desired unit or the **Enter** soft key to confirm the setting.

Stop Value					2
			mV	V	Enter

Setting the Step Value

- Press the **Step Value** soft key.

Mode	Last	Repeat	Start	Stop	Step
Linear	Rtn Keep	1	Value	Value	Value

- Use the **rotary knob** or **numeric keys and < and > keys** to set the step value.

Step Value	+ 10.000mV				
Mode	Last	Repeat	Start	Stop	Step
Linear	Rtn Keep	1	Value	Value	Value

- If you use the numeric keys, press a soft key corresponding to the desired unit or the **Enter** soft key to confirm the setting.

Step Value					1
			mV	V	Enter

Setting the Log Sweep

- Press the **Log** soft key. The SWEEP key illuminates. If you set the Sweep mode to Off, the key turns OFF.

SweepMode					
Off	Linear	Log	Program		

Setting the Start Value

- Press the **Start Value** soft key.

StartValue	+100.000mV	StepCount	10		
StopValue	+200.000mV				
Mode	Last	Repeat	Start	Stop	Step
Log	Rtn Keep	1	Value	Value	Count

5. Use the **rotary knob** or **numeric keys and < and > keys** to set the start value.

Start Value			+100.000mV		
Mode	Last	Repeat	Start	Stop	Step
Log	Rtn Keep	1	Value	Value	Count

6. If you use the numeric keys, press a soft key corresponding to the desired unit or the **Enter** soft key to confirm the setting.

Start Value			100		
			mV	V	Enter

Setting the Stop Value

7. Press the **Stop Value** soft key.

Mode	Last	Repeat	Start	Stop	Step
Log	Rtn Keep	1	Value	Value	Count

8. Use the **rotary knob** or **numeric keys and < and > keys** to set the stop value.

Stop Value			+200.000mV		
Mode	Last	Repeat	Start	Stop	Step
Log	Rtn Keep	1	Value	Value	Count

9. If you use the numeric keys, press a soft key corresponding to the desired unit or the **Enter** soft key to confirm the setting.

Stop Value			2.00		
			mV	V	Enter

Setting the Step Count

10. Press the **Step Count** soft key.

Mode	Last	Repeat	Start	Stop	Step
Log	Rtn Keep	1	Value	Value	Count

11. Use the **rotary knob** or **numeric keys and < and > keys** to set the step count.

Step Count			10		
Mode	Last	Repeat	Start	Stop	Step
Log	Rtn Keep	1	Value	Value	Count

12. If you use the numeric keys, press the **Enter** soft key to confirm the setting.

Step Count			8		
					Enter

Explanation

Linear Sweep

Sweeps using evenly spaced step values that increase linearly from the specified start value to the stop value.

If the sweep count calculated from the start, stop, and step values exceeds 65535 points, an error occurs, and the sweep operation can be carried out only up to 65535 points.

• When the source mode is DC

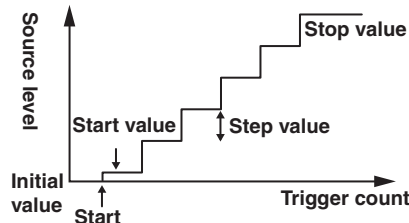

• When the source mode is pulse

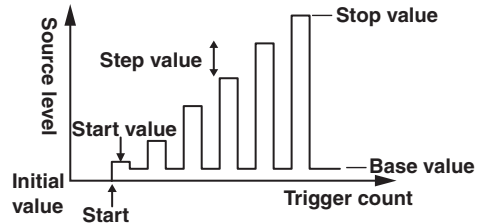

Log Sweep

Sweeps exponentially from the specified start value to the stop value at the specified step count.

The step count can be set arbitrary in the range of 2 to 65535. However, if the start value and stop value have opposite signs, an error occurs, and the sweep operation cannot be carried out.

In addition, if the start value or stop value is 0, an error occurs, and the sweep operation cannot be carried out.

• When the source mode is DC

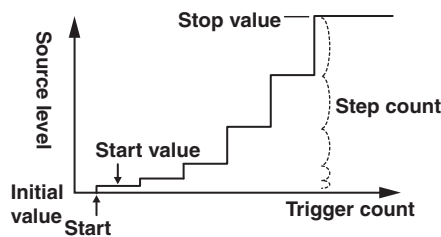

• When the source mode is pulse

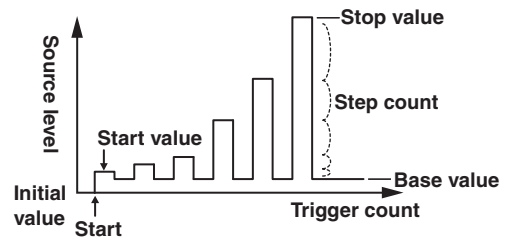

Note

- Use a fixed range so that the range setting does not change during the sweep operation. Sweep operation is possible in auto range, but the time of each source measure cycle will be irregular. In addition, if the range setting changes, the source level will be discontinuous.
- When fixed range is used, the sweep operation is carried out in the range setting best suited to the source level with the highest resolution.

<<Corresponding Command Mnemonic>>

- :SOURCE:MODE
- :SOURCE:VOLTage:SWEEp:SPACing
- :SOURCE:VOLTage:SWEEp:STArT
- :SOURCE:VOLTage:SWEEp:STOP
- :SOURCE:VOLTage:SWEEp:STEP
- :SOURCE:VOLTage:SWEEp:POINts
- :SOURCE:CURREnt:SWEEp:SPACing
- :SOURCE:CURREnt:SWEEp:STArT
- :SOURCE:CURREnt:SWEEp:STOP
- :SOURCE:CURREnt:SWEEp:STEP
- :SOURCE:CURREnt:SWEEp:POINts

6.2 Setting the Program Sweep

Procedure

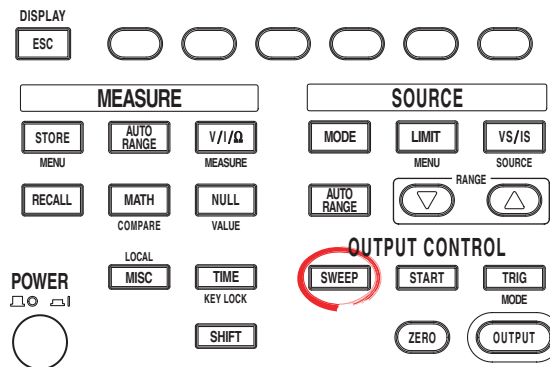

- To exit the menu during operation, press **ESC** at the upper left of the operation panel.
- In the procedural explanation below, the phrase “**rotary knob, numeric keys, <, and >**” are used to refer to the operation of selecting or setting items or entering values using the **rotary knob, numeric keys, <**, and **>** keys (BS key and right arrow key). For details on the operation using the rotary knob, numeric keys, **<**, and **>**, see sections 3.8 or 3.9.

Selecting the Program Sweep Mode

1. Press **SWEEP** to display the SWEEP menu.
2. Press the **Mode** soft key to display the SWEEP mode menu.

Mode	Last	Repeat			
Off	Rtn Keep	1			

3. Press the **Program** soft key.

SweepMode			
Off	Linear	Log	<u>Program</u>

Selecting the Pattern File

4. From the pattern files shown, use the **rotary knob** or **numeric keys** to select the file to be used for the program sweep. The selected file is underlined.

Sample.csv	2005/06/14 15:32
<u>SWEEP_1.TXT</u>	2005/06/21 10:42
SWEEP_2.TXT	2005/06/21 10:42

Mode	Last	Repeat		Select
<u>Program</u>	Rtn Keep	1		File

5. Press the **Select File** soft key to confirm the setting. When the setting is confirmed, an asterisk is placed before the file name.

Sample.csv	2005/06/14 15:32
SWEEP_1.TXT	2005/06/21 10:42
* <u>SWEEP_2.TXT</u>	2005/06/21 10:42

Mode	Last	Repeat		Select
<u>Program</u>	Rtn Keep	1		File

Explanation

Program Sweep

Sweeps according to the values in a pattern file containing an arbitrary sweep pattern.

Program Sweep Example

• When the source mode is DC

• When the source mode is pulse

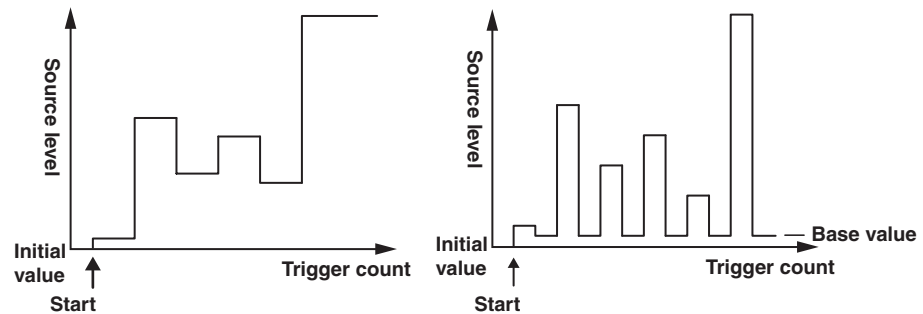

For details on the pattern file of program sweep, see section 6.6, "Program Pattern File."

Note

- Use a fixed range so that the range setting does not change during the sweep operation. Sweep operation is possible in auto range, but the time of each source measure cycle will be irregular. In addition, if the range setting changes, the source level will be discontinuous.
- When fixed range is used, the sweep operation is carried out in the range setting best suited to the source level with the highest resolution.

<<Corresponding Command Mnemonic>>

```
:SOURCE:MODE
:SOURCE:LIST:SElect
:SOURCE:LIST:CATalog?
:SOURCE:LIST:DELeTe
:SOURCE:LIST:DEFine
```

6.3 Selecting the Termination Mode

Procedure

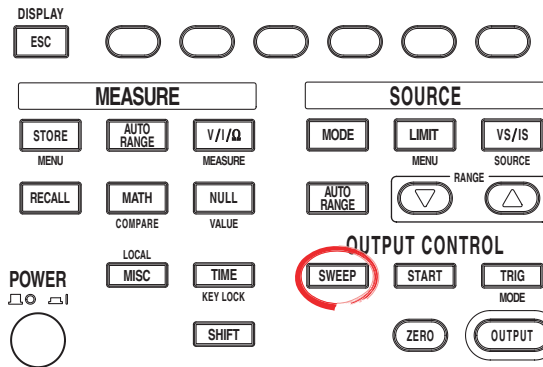

- To exit the menu during operation, press **ESC** at the upper left of the operation panel.
- In the procedural explanation below, the phrase “**rotary knob, numeric keys, <, and >**” are used to refer to the operation of selecting or setting items or entering values using the **rotary knob, numeric keys, <**, and **>** keys (BS key and right arrow key). For details on the operation using the rotary knob, numeric keys, **<**, and **>**, see sections 3.8 or 3.9.

1. Press **SWEEP** to display the SWEEP menu.
2. Press the **Last** soft key to select the sweep termination mode.

Mode	Last	Repeat	Start	Stop	Step
Log	Rtn	Keep	Value	Value	Count

Explanation

Sweep Termination Mode

Return (Rtn)

The source level after the sweep operation is complete is reset to the level before the sweep operation was started.

In return (Rtn) mode, a trigger for resetting the source value is needed in addition to the trigger for the measurement. Therefore, note that one additional trigger is needed for the GS610 to enter the start wait condition.

- Sweep operation when the termination mode (Last) is set to return (Rtn)

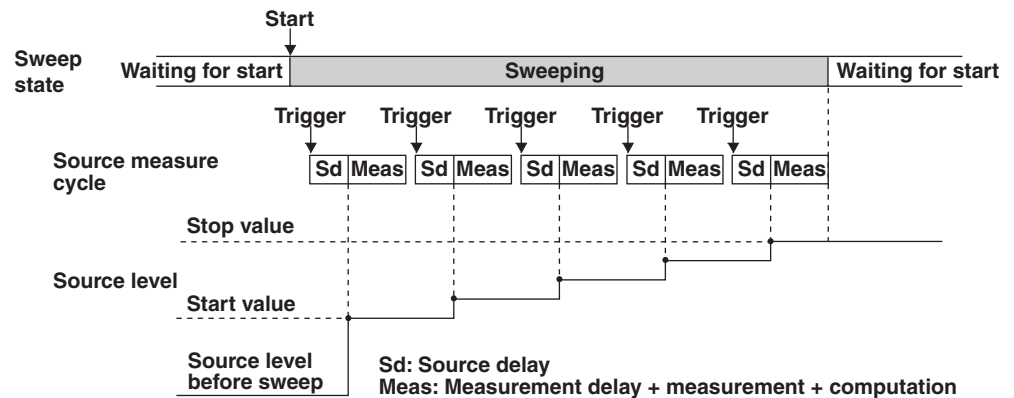

6.3 Selecting the Termination Mode

Keep

The last source level of the sweep operation is retained even after the sweep operation is complete.

- Sweep operation when the termination mode (Last) is set to keep

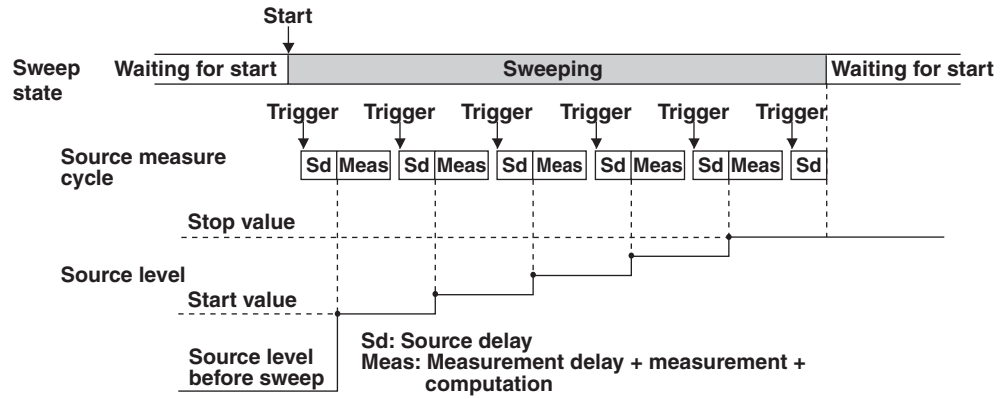

<<Corresponding Command Mnemonic>>

:SWEep:LAST

6.4 Setting the Repeat Count

Procedure

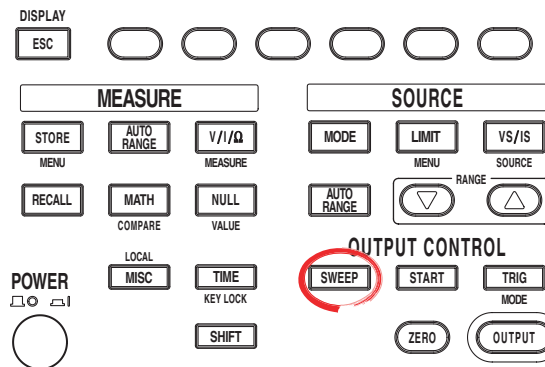

- To exit the menu during operation, press **ESC** at the upper left of the operation panel.
- In the procedural explanation below, the phrase “**rotary knob, numeric keys, <, and >**” are used to refer to the operation of selecting or setting items or entering values using the **rotary knob, numeric keys, <** and **>** keys (BS key and right arrow key). For details on the operation using the rotary knob, numeric keys, **<** and **>**, see sections 3.8 or 3.9.

1. Press **SWEEP** to display the SWEEP menu.
2. Press the **Repeat** soft key.

Mode	Last	Repeat	Start	Stop	Step
Log	Rtn Keep	1	Value	Value	Count

3. Use the **rotary knob** or **numeric keys** and **<** and **>** keys to set the repeat count. Press the **Infinity** soft key to select infinity (∞).

When the value is entered directly with the numeric keys

Repeat					
Count					2
					Enter

When the value is set with the rotary knob

Repeat					
Count					∞
					Infinity

4. Enter 0 with the numeric key and press the **Enter** soft key to select infinity (∞).

Explanation

Sweep Repeat Count

Set the value in the range from 1 to 1000. If 0 is specified, infinity (∞) is selected. After the sweep operation is started, the operation repeats until the sweep or output is turned OFF.

<<Corresponding Command Mnemonic>>

:SWEp:COUNT

6.5 Starting the Sweep Operation

Procedure

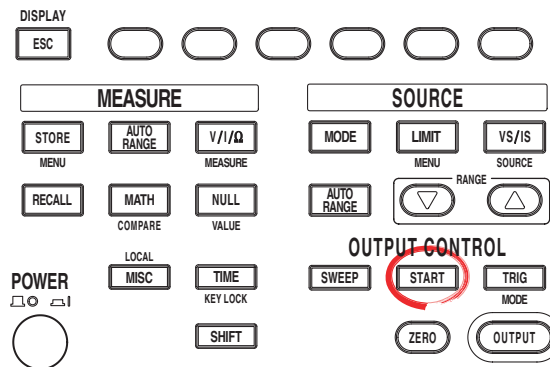

- To exit the menu during operation, press **ESC** at the upper left of the operation panel.
- In the procedural explanation below, the phrase “**rotary knob, numeric keys, <, and >**” are used to refer to the operation of selecting or setting items or entering values using the **rotary knob, numeric keys, <**, and **>** keys (BS key and right arrow key). For details on the operation using the rotary knob, numeric keys, **<**, and **>**, see sections 3.8 or 3.9.

Starting the Sweep Operation

Press **START** to set the sweep operation to trigger wait condition.

Explanation

Starting the Sweep Operation

Set the sweep operation to trigger wait condition. When a trigger is activated, the sweep operation starts. When the sweep operation is started, one step of the source measure cycle is executed.

You can generate the start event using the **START** key on the front panel or a communication command (“:SWEep:TRIGger,” see section 16.2.4, “Sweep Commands”). You can also generate the start event with the falling edge of the signal applied to the BNC input terminal or pin 3 of the external input/output connector on the rear panel.

When the GS610 is in the start wait state, the wait indicator (WaitStart) illuminates.

When the sweep operation is started, the **START** key blinks, and WaitStart turns OFF until the sweep operation is completed.

If a start event occurs in the middle of a sweep operation, the current sweep operation is cancelled, and the sweep operation is restarted from the beginning.

<<Corresponding Command Mnemonic>>

:SWEep:TRIGger

6.6 Program Pattern File

In program sweep, a text file created on a PC or a similar device is stored in the PROGRAM directory on the internal non-volatile disk (GS610ROM). The file is selected as a pattern file to carry out the sweep operation.

Sample.csv that is stored in the PROGRAM directory when the GS610 is shipped from the factory or when the disk is formatted is a sample pattern file.

Pattern File Description

A pattern file consists of a list of source values. Each value is delimited by a line feed code (CR, LF, CR+LF). The value format is an integer, fixed-point number, or floating-point number without a unit.

For example, a pattern file that changes from 0 to 5 in 1.25 steps is written as follows:

```
0.00  
1.25  
2.50  
3.75  
5.00
```

The same pattern file can also be written using floating-point numbers as follows:

```
0.00E+0  
1.25E+0  
2.50E+0  
3.75E+0  
5.00E+0
```

6.6 Program Pattern File

In a pattern file, a command specified by the user can be executed before each source measure cycle.

For example, a pattern file for generating the following pattern in the figure is shown below.

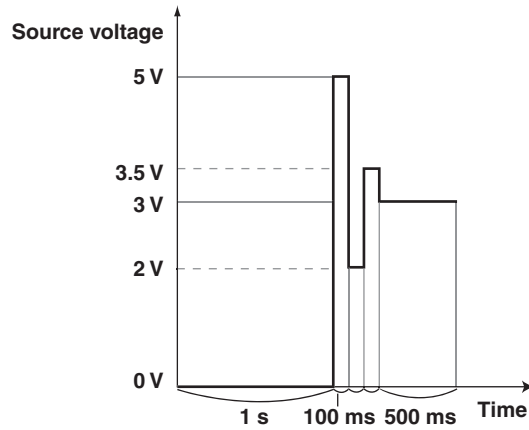

```
0.0, ":TRIG:TIM 1"  
5.0, ":TRIG:TIM 0.1"  
2.0  
3.5  
3.0, ":TRIG:TIM 0.5"
```

As shown above, if a character string enclosed in double quotations is written after the source value, it is executed as a command mnemonic before the source measure cycle. Multiple commands can be connected using semicolons in the command mnemonic. Note that the source value and the command mnemonic are separated by a comma. For a detailed description of the command mnemonic, see section 16.2, "Commands."

Note

- The maximum number of steps in program pattern is 65535. If a program pattern whose step count exceeds 65535 is swept, the first 65535 points are loaded.
 - You can change the decimal point and separator that are used in the program pattern files to the notations that match the Excel program that you use. For the procedure, see section 11.8, "Selecting the Decimal Point and Separator Notations of CSV Files."
-

7.1 Turning the Measurement ON/OFF

Procedure

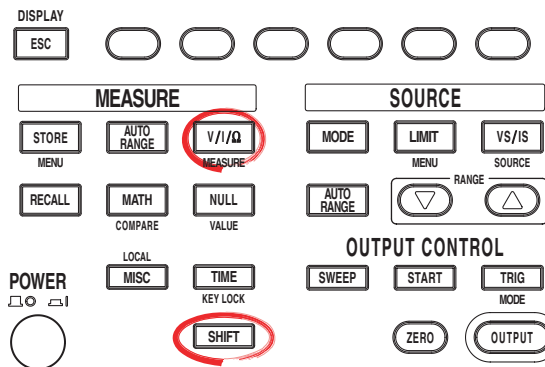

- To exit the menu during operation, press **ESC** at the upper left of the operation panel.
- In the procedural explanation below, the phrase “**rotary knob, numeric keys, <, and >**” are used to refer to the operation of selecting or setting items or entering values using the **rotary knob, numeric keys, <** (BS key and left arrow key), and **>** (right arrow key). For details on the operation using the rotary knob, numeric keys, <, and >, see sections 3.8 or 3.9.

1. Press **SHIFT+V/I/Ω**(MEASURE) to display the Measure menu.
2. Press the **Measure** soft key to select ON (measure) or OFF (not measure).

Measure	IntgTime	Average	AutoZero	AutoZero	Auto V/I
On Off	1ms	Off	On Off	Exec	On Off

Explanation

The default setting is ON (measure).

When turned OFF, the procedure related to measurement is not carried out. This enables the source measure cycle to be shortened. If you need to change the source level at high speeds such as a program sweep at a period time of 100 μs, turn the measurement OFF.

<<Corresponding Command Mnemonic>>

:SENSE[:STATe]

7.2 Selecting the Measurement Function

Procedure

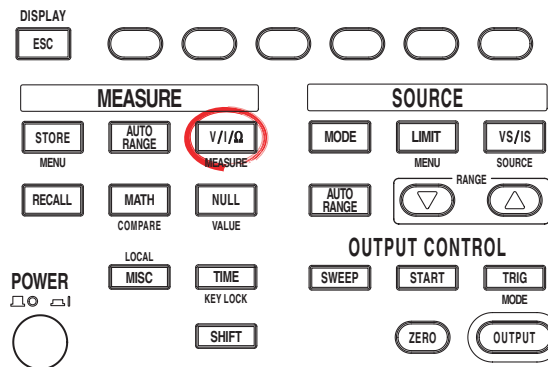

- To exit the menu during operation, press **ESC** at the upper left of the operation panel.
- In the procedural explanation below, the phrase “**rotary knob, numeric keys, <, and >**” are used to refer to the operation of selecting or setting items or entering values using the **rotary knob, numeric keys, <**, and **>** keys (BS key and right arrow key). For details on the operation using the rotary knob, numeric keys, <, and >, see sections 3.8 or 3.9.

Press the **V/I/Ω** key. Each time you press the key the measurement function changes as follows: **V, I, Ω, V, and so on.**

Explanation

The following measurement functions are available.

V: Voltage measurement

I: Current measurement

Ω: Resistance measurement (current measurement when generating voltage, voltage measurement when generating current, resistance = voltage/current)

<<Corresponding Command Mnemonic>>

:SENSe:FUNCTION

7.3 Turning ON/OFF the Auto Range function of the Measurement Range Settings

Procedure

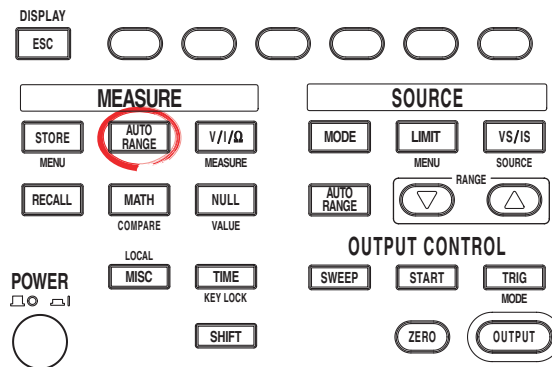

- To exit the menu during operation, press **ESC** at the upper left of the operation panel.
- In the procedural explanation below, the phrase “**rotary knob, numeric keys, <, and >**” are used to refer to the operation of selecting or setting items or entering values using the **rotary knob, numeric keys, <**, and **>** keys (BS key and right arrow key). For details on the operation using the rotary knob, numeric keys, **<**, and **>**, see sections 3.8 or 3.9.

Press **AUTO RANGE** under MEASURE to select ON or OFF. When the auto range function is turned ON, the AUTO RANGE key illuminates.

Explanation

Measurement Range Settings and Auto Range

The measurement range setting is determined indirectly by the source range setting and limiter setting. It is not set directly.

When auto range is turned ON, the GS610 makes a measurement and checks whether a different range setting is available for making the measurement with the best resolution. If so, the GS610 changes the range setting and makes the measurement again. However, it may take time for the GS610 to switch the range setting, and the source level may become discontinuous.

Note

- The measurement auto range does not operate, and an error occurs in the following cases.
 - If the source mode is set to pulse source.
 - If the source and measurement are set to the same function (voltage source and voltage measurement or current source and current measurement).
 - If the limiter tracking is turned OFF.
- If the source and measurement are set to the same function (voltage source and voltage measurement or current source and current measurement), the limiter range is set equal to the measurement range setting. Therefore, the limiter range is changed along with the measurement auto range operation. When the limiter range is changed, the limiter level is transiently set to 10% of the range setting.

<<Corresponding Command Mnemonic>>

:SENSe:RANGe:AUTO

7.4 Setting the Measurement Delay

Procedure

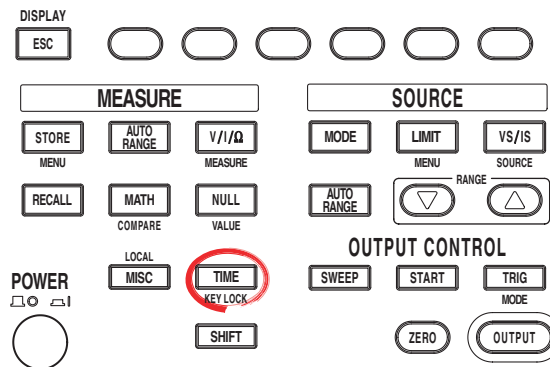

- To exit the menu during operation, press **ESC** at the upper left of the operation panel.
- In the procedural explanation below, the phrase “**rotary knob, numeric keys, <, and >**” are used to refer to the operation of selecting or setting items or entering values using the **rotary knob, numeric keys, <**, and **>** keys (BS key and right arrow key). For details on the operation using the rotary knob, numeric keys, **<**, and **>**, see sections 3.8 or 3.9.

1. Press **TIME** to display the Time menu.
2. Press the **M.Delay** soft key to display the measurement delay setup screen.

S.Delay	M.Delay	Period	P.Width		
1 μ s	50 μ s	50.00ms	25.00ms		

3. Use the **rotary knob** or **numeric keys and < and > keys** to set the measurement delay.

Measure Delay	50 μ s				
S.Delay	M.Delay	Period	P.Width		
1 μ s	50 μ s	50.00ms	25.00ms		

4. If you use the numeric keys, press a soft key corresponding to the desired unit or the **Enter** soft key to confirm the setting.

Measure Delay	50				
	μ s	mS	S	Enter	

Explanation**Measurement Delay**

You can set the wait time at which the measurement is started after the source level is switched.

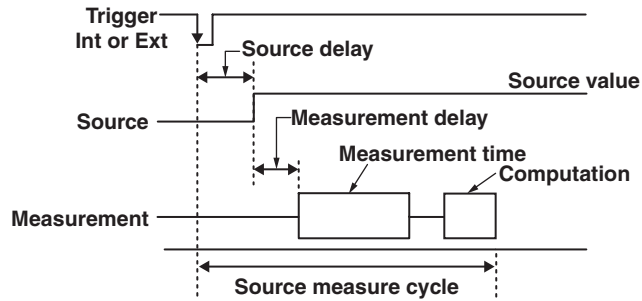
**Selectable Range**

1 μ S to 3600.000000 s

Note

The time needed for the source value to stabilize after the source is applied varies depending on the load, source value, and limiter value. Adjust the measurement delay by taking these into account as well as the time required for the measurement accuracy test.

<<Corresponding Command Mnemonic>>

:SENSe:DELAy

7.5 Setting the Integration Time

Procedure

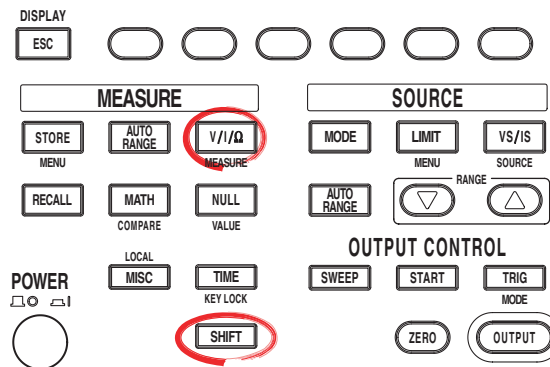

- To exit the menu during operation, press **ESC** at the upper left of the operation panel.
- In the procedural explanation below, the phrase “**rotary knob, numeric keys, <, and >**” are used to refer to the operation of selecting or setting items or entering values using the **rotary knob, numeric keys, <**, and **>** keys (BS key and right arrow key). For details on the operation using the rotary knob, numeric keys, **<**, and **>**, see sections 3.8 or 3.9.

1. Press **SHIFT+V/I/Ω**(MEASURE) to display the Measure menu.
2. Press the **IntgTime** soft key to display the IntegrationTime menu.

```
| Measure | IntgTime | Average | AutoZero | AutoZero | Auto V/I |
| On Off | 1ms     | Off    | On Off  | Exec    | On Off  |
```

3. Press the soft key corresponding to the desired integration time.

```
IntegrationTime
| 250µs  1ms  4ms  20ms  100ms  200ms |
```

Explanation

Select from the following:

- **When the Power Frequency Is 50 Hz**
250 µs, 1 ms, 4 ms, 20 ms, 100 ms, or 200 ms
- **When the Power Frequency Is 60 Hz**
250 µs, 1 ms, 4 ms, 16.6 ms, 100 ms, or 200 ms

Note

- If the integration time is set to 200 ms, 100 ms, 20 ms, or 16.6 ms, the effects of noise from the power frequency can be eliminated, because these settings are integer multiples of the power cycle. Use one of these integration times in measurements that handle delicate voltage or current that is easily affected by noise.
- The power frequency setting can be changed even after the GS610 starts up (see section 3.6, “Setting the Power Frequency”).

<<Corresponding Command Mnemonic>>

:SENSe:ITIME

7.6 Auto Zero Function

Procedure

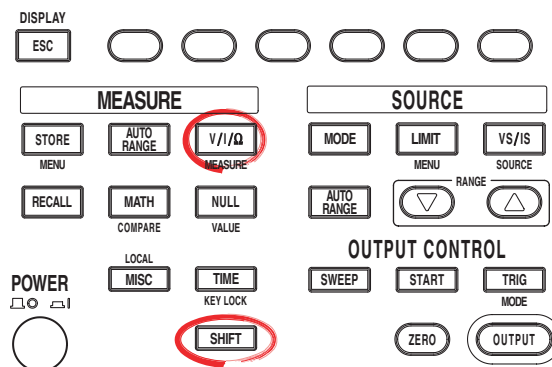

- To exit the menu during operation, press **ESC** at the upper left of the operation panel.
- In the procedural explanation below, the phrase “**rotary knob, numeric keys, <, and >**” are used to refer to the operation of selecting or setting items or entering values using the **rotary knob, numeric keys, <** (BS key and left arrow key), and **>** (right arrow key) keys. For details on the operation using the rotary knob, numeric keys, <, and >, see sections 3.8 or 3.9.

Turning the Auto Zero Function ON/OFF

1. Press **SHIFT+V/I/Ω**(MEASURE) to display the Measure menu.
2. Press the **Auto Zero** soft key to select On or Off.

```
| Measure | IntgTime | Average | AutoZero | AutoZero | Auto V/I |
| On Off | 1ms     | Off    | On Off  | Exec    | On Off  |
```

Executing the Auto Zero Function

3. Press the **Auto Zero Exec** soft key to execute the auto zero function.

```
| Measure | IntgTime | Average | AutoZero | AutoZero | Auto V/I |
| On Off | 1ms     | Off    | On Off  | Exec    | On Off  |
```

Explanation

Auto Zero Function

• On

Enables the auto zero function. The GS610 measures the internal zero point for each measurement. The measured result is obtained by subtracting this value from the measured value canceling the offset drift of the measurement circuit in the GS610. However, the measurement takes approximately twice as long as when the auto zero function is OFF, because the GS610 measures twice.

• Off

Disables the auto zero function. The GS610 carries out only the measurement of the DUT. The measurement time is approximately half the time as when the auto zero function is turned ON.

<<Corresponding Command Mnemonic>>

```
:SENSe:AZERo[ :STATe ]
:SENSe:AZERo:EXECute
```

7.7 Turning Auto V/I ON/OFF

Procedure

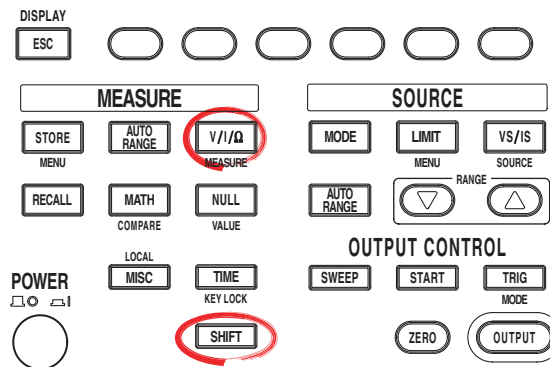

- To exit the menu during operation, press **ESC** at the upper left of the operation panel.
- In the procedural explanation below, the phrase “**rotary knob, numeric keys, <, and >**” are used to refer to the operation of selecting or setting items or entering values using the **rotary knob, numeric keys, <**, and **>** keys (BS key and right arrow key). For details on the operation using the rotary knob, numeric keys, **<**, and **>**, see sections 3.8 or 3.9.

1. Press **SHIFT+V/I/Ω**(MEASURE) to display the Measure menu.
2. Press the **Auto V/I** soft key to select On or Off.

Measure	IntgTime	Average	AutoZero	AutoZero	Auto V/I
On Off	1m \pm	Off	On Off	Exec	On Off

Explanation

When Auto V/I is turned ON, the measurement function switches when a limiter is activated.

- **When Generating Voltage and Measuring Current**

When the limiter is not activated: The GS610 measures current. The voltage source level is entered for the source value in the result file when the storage operation is carried out. (Normal operation)

When the limiter is activated: The GS610 measures voltage. The current limiter value is entered for the source value in the result file when the storage operation is carried out.

- **When Generating Current and Measuring Voltage**

When the limiter is not activated: The GS610 measures voltage. The current source level is entered for the source value in the result file when the storage operation is carried out. (Normal operation)

When the limiter is activated: The GS610 measures current. The voltage limiter value is entered for the source value in the result file when the storage operation is carried out.

<<Corresponding Command Mnemonic>>

:SENSe:ACHange

8.1 Averaging

Procedure

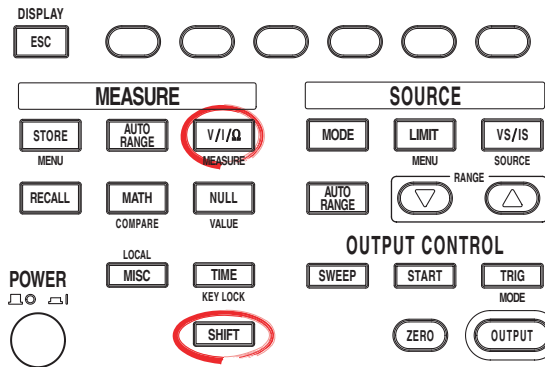

- To exit the menu during operation, press **ESC** at the upper left of the operation panel.
- In the procedural explanation below, the phrase “**rotary knob, numeric keys, <, and >**” are used to refer to the operation of selecting or setting items or entering values using the **rotary knob, numeric keys, <** and **>** keys (BS key and right arrow key). For details on the operation using the rotary knob, numeric keys, **<** and **>**, see sections 3.8 or 3.9.

1. Press **SHIFT+V/I/Ω**(MEASURE) to display the Measure menu.
2. Press the **Average** soft key to display the Average menu.

Measure	IntgTime	Average	AutoZero	AutoZero	Auto V/I
On Off	1ms	Off	On Off	Exec	On Off

Selecting the Averaging Mode

3. Press the **Mode** soft key to display the averaging mode menu.

		Mode	Count		
		Off	2		

4. Press the soft key corresponding to the desired averaging mode. If you select Off, averaging is disabled. If the averaging mode is set to Block or Moving, the averaging indicator to the left of the display illuminates.

	Mode	Count		
Off	Block Moving	2		

Setting the Average Count

5. Press the **Count** soft key.

		Mode	Count		
		Off	2		

6. Use the **rotary knob** or **numeric keys** and **<** and **>** keys to set the average count.
7. If you use the numeric keys, press the **Enter** soft key to confirm the setting.

	Count				
				5	
					Enter

Explanation

Averaging Mode

The following averaging modes are available.

Block: Block Average

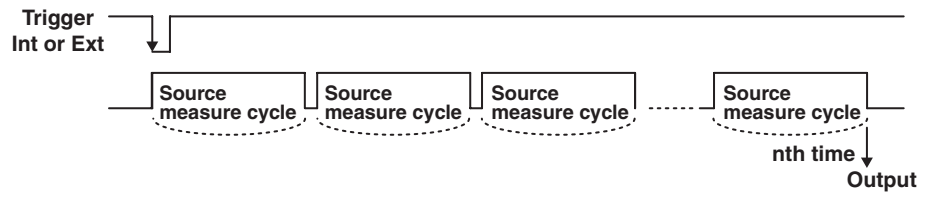

Moving: Moving Average

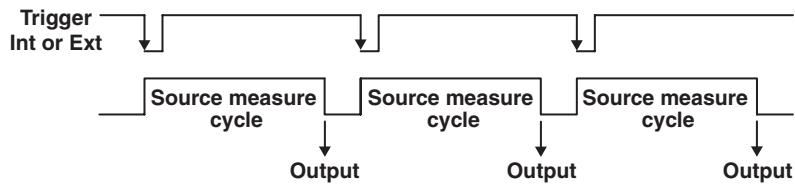

Note

The block average only works in DC source mode. In pulse source mode, an error occurs.

Setting the Average Count

Set the value in the range from 1 to 256.

<<Corresponding Command Mnemonic>>

- :SENSe:AVERAge[:STATe]
- :SENSe:AVERAge:MODE
- :SENSe:AVERAge:COUNT

8.2 NULL Computation

Procedure

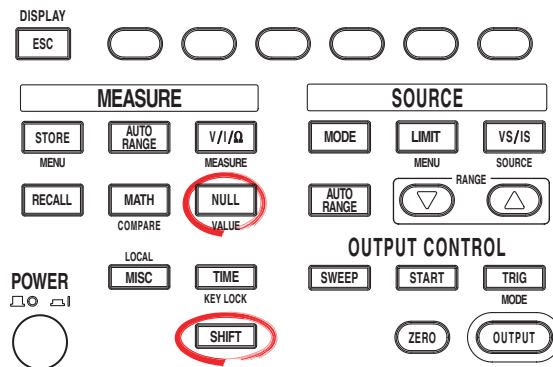

- To exit the menu during operation, press **ESC** at the upper left of the operation panel.
- In the procedural explanation below, the phrase “**rotary knob, numeric keys, <, and >**” are used to refer to the operation of selecting or setting items or entering values using the **rotary knob, numeric keys, <** and **>** keys (BS key and right arrow key). For details on the operation using the rotary knob, numeric keys, **<**, and **>**, see sections 3.8 or 3.9.

Turning NULL Computation ON/OFF

1. Press **NULL**. The NULL key illuminates, and the NULL computation is enabled.
2. If you press **NULL** again, the NULL computation is disabled, and the NULL key turns OFF.

Setting the NULL Value

1. Press **SHIFT+NULL**. The retrieved NULL value is displayed.

Null Value	+0.00000E+00				

2. Use the **rotary knob** or **numeric keys** and **<** and **>** keys to set the NULL value.
3. If you use the numeric keys, press a soft key corresponding to the desired unit or the **Enter** soft key to confirm the setting.

Null Value	2				
E					Enter

Explanation

NULL Computation

The measured value when NULL computation switches from OFF to ON when you press the NULL key is used as a NULL value. While NULL computation is ON, the value obtained by subtracting the NULL value from the measured value is displayed.

NULL Value

The retrieved NULL value applies to all measurement range settings.

<<Corresponding Command Mnemonic>>

:CALCulate:NULL[:STATe]

:CALCulate:NULL:OFFSet

8.3 Computation Using Equations

Procedure

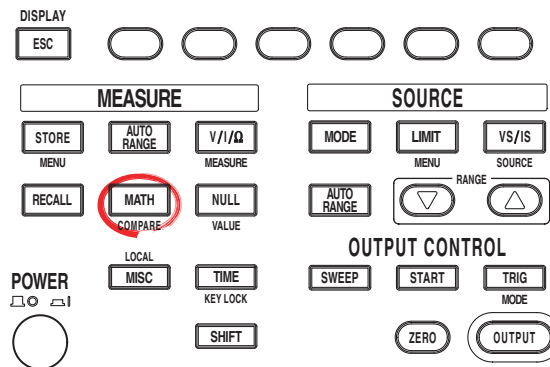

- To exit the menu during operation, press **ESC** at the upper left of the operation panel.
- In the procedural explanation below, the phrase “**rotary knob, numeric keys, <, and >**” are used to refer to the operation of selecting or setting items or entering values using the **rotary knob, numeric keys, <**, and **>** keys (BS key and right arrow key). For details on the operation using the rotary knob, numeric keys, **<**, and **>**, see sections 3.8 or 3.9.

Turning Computation ON/OFF

1. Press **MATH** to display the MATH menu.

Selecting the Computation Definition

2. Use the **rotary knob** and **<** and **>** keys to select the computation definition file. The selected file is underlined.

```

dB.txt          2005/06/28 16:31
Percent.txt    2005/06/28 16:31
Scaling.txt    2005/06/28 16:31
Power.txt      2005/06/28 16:31 ↓
| Math |          |          |          | View | Select |
| On Off |          |          |          |      | File  |

```

3. Press the **Select File** soft key to confirm the computation definition file. An asterisk is placed on the computation definition file that has been confirmed.

```

dB.txt          2005/06/28 16:31
Percent.txt    2005/06/28 16:31
* Scaling.txt  2005/06/28 16:31
Power.txt      2005/06/28 16:31 ↓
| Math | Param | Param |          | View | Select |
| On Off | A   | B   |          |      | File  |

```

Note

If the description in the computation definition file is not correct, the file cannot be selected. In this case, if the beep sound (see section 11.4, “Turning the Beep Sound ON/OFF”) is turned ON, a beep sound is generated.

4. Press the **Math** soft key to select On (compute) or Off (not compute). If On is selected, the MATH key illuminates, and the soft keys for the parameters that needs to be specified for the selected computation definition file are displayed.

```

| Math | Param | Param |          | View | Select |
| On Off | A   | B   |          |      | File  |

```

Note

If you select ON without selecting a computation definition file, an error occurs.

Setting the Parameters

5. Press the **Param A**, **Param B**, or **Param C** soft key.

Parameter A		+0.00000E+00			
Math On Off	Param A	Param B			

Note

If there is no parameter description in the selected computation definition file, the setup parameters (Param A to Param C) are not displayed.

6. Use the **rotary knob** or **numeric keys and < and > keys** to set the parameter.
 7. If you use the numeric keys, press a soft key corresponding to the desired unit or the **Enter** soft key to confirm the setting.

Parameter A		2			
E					Enter

Confirming the Computation Definition

8. Press the **View** soft key. The contents of the selected computation definition are displayed.

```
FILE: SCALING.txt
M=<(M-B)/A>*C
```

Explanation

The measured results can be used to perform various computations. The computation definition file can be set to any of the built-in computation files or a user-defined computation file that you create. For a description of writing a user-defined computation file, see section 8.5, "User-Defined Computation."

Built-in Computation Files

The following five equations are built in.

- **Decibel (dB.txt)**
 $m = A \cdot \log(m/B)$: Computes the decibel of the measured value with respect to B.
- **Percent (Percent.txt)**
 $m = (m/A) \cdot 100$: Computes the percentage of the measured value with respect to A.
- **Scaling (Scaling.txt)**
 $m = A \cdot M + B$: Scales the measured value.
- **Power (Power.txt)**
 $m = V \cdot I$: Calculates the power from the source value and measured value. However, if the source and measurement are of the same function or when measuring resistance, the power cannot be calculated correctly. To measure power, set the GS610 to voltage generation and current measurement or current generation and voltage measurement.
- **Sinusoid generation (Sinusoid.txt)**
 $s = A \cdot \sin(2 \cdot \text{PI} \cdot B \cdot t)$: Generates a sinusoid of amplitude A and frequency B. However, if the sweep function is enabled, the sweep operation takes precedence. To generate the sinusoid, turn the sweep function OFF.

8.3 Computation Using Equations

Selectable Range of the Parameters

-9.99999E+24 to +9.99999E+24

Confirming the Computation Definition

The contents of the computation definition files stored in the MATH directory of GS610ROM can be displayed.

<<Corresponding Command Mnemonic>>

:CALCulate:MATH[:STATe]
:CALCulate:MATH:SELEct
:CALCulate:MATH:CATalog?
:CALCulate:MATH:DELEte
:CALCulate:MATH:DEFine
:CALCulate:MATH:PARAmeter:A Or B Or C

8.4 Comparison Operation

Procedure

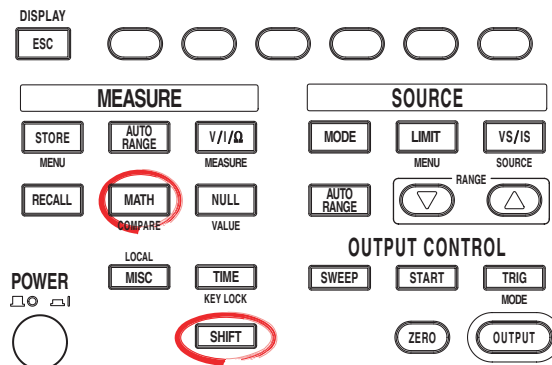

- To exit the menu during operation, press **ESC** at the upper left of the operation panel.
- In the procedural explanation below, the phrase “**rotary knob, numeric keys, <, and >**” are used to refer to the operation of selecting or setting items or entering values using the **rotary knob, numeric keys, <** and **>** keys (BS key and right arrow key). For details on the operation using the rotary knob, numeric keys, **<** and **>**, see sections 3.8 or 3.9.

Turning the Comparison Operation ON/OFF

- Press **SHIFT+MATH(COMPARE)** to display the COMPARE menu.

Compare	Upper	Lower			
On <u>Off</u>					

- Press the **Compare** soft key to select On or Off. When the comparison operation is turned ON, the MATH key illuminates.

Compare	Upper	Lower			
On <u>Off</u>					

Setting the Reference Value

- Press the **Upper** soft key to display the Upper setup screen.

Compare	Upper	Lower			
On <u>Off</u>					

- Use the **rotary knob** or **numeric keys and < and > keys** to set the upper value.

Upper	+0.00000E+00				
Compare	Upper	Lower			
On <u>Off</u>					

- If you use the numeric keys, press a soft key corresponding to the desired unit or the **Enter** soft key to confirm the setting.

Upper	2				
E					Enter

- Press the **Lower** soft key to display the Lower setup screen.

Compare	Upper	Lower			
On <u>Off</u>					

- Use the **rotary knob** or **numeric keys and < and > keys** to set the lower value.

Lower	+0.00000E+00				
Compare	Upper	Lower			
On <u>Off</u>					

8.4 Comparison Operation

8. If you use the numeric keys, press a soft key corresponding to the desired unit or the **Enter** soft key to confirm the setting.

Lower					2
E					Enter

Explanation

Comparison Operation

Determines the magnitude relation between the displayed value and the reference values (upper and lower) and displays the result. You can combine the two reference values to determine the upper > displayed value > lower relationship.

The results of the comparison are displayed as follows:

Displayed Value	Display of the Comparison Result in the Status Display Area	Determination of the External Input/Output Section
+ oL	High	HI
Displayed value > Upper	High	HI
Upper ≥ Displayed value ≥ Lower	In	IN
Lower > Displayed value	Low	LO
- oL	Low	LO

Setting the Reference Value

Set the reference values so that Upper is greater than Lower.

<<Corresponding Command Mnemonic>>

:CALCulate:LIMit[:STATe]

:CALCulate:LIMit:UPPer

:CALCulate:LIMit:LOWer

8.5 User-Defined Computation

In user-defined computation, the GS610 parses a text file created on a PC or a similar device is stored in the MATH directory on the internal non-volatile disk (GS610ROM) as a definition file and performs computation.

The five built-in computations (dB.txt, Percent.txt, Scaling.txt, Power.txt, and Sinusoid.txt) that are stored in the MATH directory when the GS610 is shipped from the factory or when the disk is formatted are also a type of user-defined computation. User-defined computation can be performed by creating files in the same format.

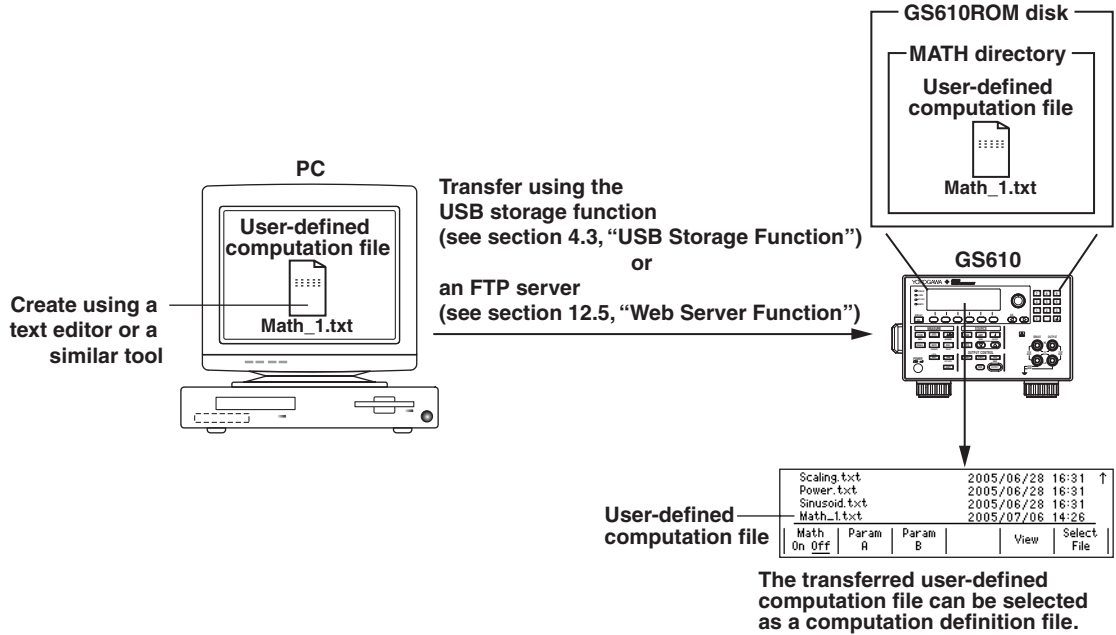

User-Definition Computation Syntax

The measured result is entered in variable M. The computed result can be substituted into variable M to further carry out computation.

For example, if you wish to display the result of subtracting 0.75 from 1.25 times the measured value, write the equation as follows:

$$M = M * 1.25 - 0.75$$

The available binary operators are listed below.

Symbol	Meaning
+	Addition
-	Subtraction
*	Multiplication
/	Division
%	Modulo (the remainder of an integer division operation)
^	Power
<	Less than
<=	Less than or equal to
>	Greater than
>=	Greater than or equal to
==	Equal to
!=	Not equal to
and	Logical product
or	Logical sum
xor	Exclusive OR

The following two unary operators are available.

Symbol	Meaning
not	Not
-	Negation

Equations using functions can also be written.

For example, if you wish to compute the absolute value of the measured value, you can use the absolute value function ABS() as follows:

$$M = \text{ABS}(M)$$

The available functions are listed below.

Function	Meaning
ABS(n)	Absolute value of n
EXP(n)	e to the n power
LN(n)	Natural logarithm of n
LOG(n)	Common logarithm of n
SQRT(n)	Square root of n
SIN(n)	Sine of n
COS(n)	Cosine of n
TAN(n)	Tangent of n
ASIN(n)	Arc sine of n
ACOS(n)	Arc cosine of n
ATAN(n)	Arc tangent of n
SINH(n)	Hyperbolic sine of n
COSH(n)	Hyperbolic cosine of n
TANH(n)	Hyperbolic tangent of n
RAND()	Random number between 0 and 1
RAND(n)	Random number between 0 and 1 using n as a seed
TRUNC(n)	Truncate n to an integer toward 0
EDGE(n)	1 when n changes from zero to a non-zero value, otherwise 0
MKTIME(n)	Convert string n to the same format as the time stamp

The GS610 retains the past 15 measured values (before the computation) in addition to the current measured value. These measured values can be used in the computation. M[-1] represents the previous measured value, and M[-15] represents the measured value 15 measurements in the past.

For example, to perform moving average over five measurements, write the equation as follows:

$$M=(M+M[-1]+M[-2]+M[-3]+M[-4])/5$$

If the past measured value is not retrieved, the computed result is over range. In the above example, the display is O.L until five source measure cycles are completed.

The available variables are listed below.

Variable	Meaning
M	Current measured value. If a value is substituted in this variable, the result becomes the measured result after the computation.
S	Current source value. If a value is substituted in this variable, the result is used as the next source value.
T	Current time stamp. Indicates the elapsed seconds from the first source measure cycle. The resolution is 1 μ s. A value cannot be substituted in this variable.
M[-n]	Measured value n times in the past (before computation). The variable n is an integer between 1 and 15. A value cannot be substituted in this variable.
S[-n]	Source value n times in the past. The variable n is an integer between 1 and 15. A value cannot be substituted in this variable.
T[-n]	Time stamp n times in the past. The variable n is an integer between 1 and 15. A value cannot be substituted in this variable.
I	Current source value or measured value that is a current. A value cannot be substituted in this variable.
V	Current source value or measured value that is a voltage. A value cannot be substituted in this variable.
A, B, C	General-purpose parameters that can be edited from the operation menu. A value cannot be substituted in this variable.
X, Y, Z	General-purpose variables. When a value is substituted, it is retained until another value is substituted.
J	A counter that increases for each source measure cycle starting from 0. A value cannot be substituted in this variable.

The description in the definition file can span multiple lines that are delimited by line feed codes (CR, LF, or CRLF).

For example,

$$M=((M^2+3)*(M/4-5)+6)/7$$

can be written using general-purpose variables X and Y as intermediate variables as

$$X=M^2+3$$

$$Y=M/4-5$$

$$M=(X*Y+6)/7$$

In addition, initial values can be assigned to general-purpose variables X, Y, and Z.

For example, if you write

$$X0=0$$

$$X=X+1$$

the value of general-purpose variable X changes each source measure cycle as follows: 0, 1, 2, and so on.

You can use an If statement to change the operation according to a given condition.

For example, if you write

$$\text{IF } ((V*I)>9.5) \text{ THEN @":OUTP OFF"}$$

the output can be turned OFF when the product of V and I or the power exceeds 9.5 W. The character string enclosed in double quotations following the @ character is parsed as a command mnemonic and executed.

For details, see appendix 1, "MATH Definition Specifications."

9.1 Storing the Measured Results

Procedure

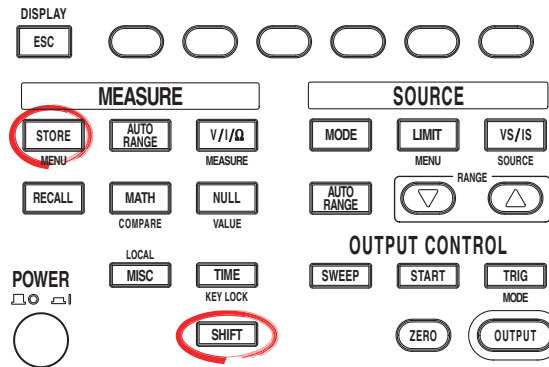

- To exit the menu during operation, press **ESC** at the upper left of the operation panel.
- In the procedural explanation below, the phrase “**rotary knob, numeric keys, <, and >**” are used to refer to the operation of selecting or setting items or entering values using the **rotary knob, numeric keys, <**, and **>** keys (BS key and right arrow key). For details on the operation using the rotary knob, numeric keys, **<**, and **>**, see sections 3.8 or 3.9.

1. Press **SHIFT+STORE(MENU)** to display the Store menu.

Setting the Store Count

2. Press the **Count** soft key to display the store count setup screen.

Count	Auto	MeasOnly			
10	On Off	On Off			

3. Use the **rotary knob** or **numeric keys and < and > keys** to set the store count.

Store Count	10				
Count	Auto	MeasOnly			
10	On Off	On Off			

4. If you use the numeric keys, press the **Enter** soft key to confirm the setting.

Store Count	5				
					Enter

Turning Auto Storage ON/OFF

5. Press the **Auto** soft key to select On or Off.

Count	Auto	MeasOnly			
10	On Off	On Off			

Turning Measurement-Only ON/OFF

6. Press the **MeasOnly** soft key to select On or Off.

When measurement-only is turned ON, only the data when the measurement is ON is stored. For example, only the data when measurement is ON can be stored, if measurement ON/OFF is switched during a program sweep. Turn measurement-only ON if you want to output only the lines that contain measured data in the result file.

Count	Auto	MeasOnly			
10	On Off	On Off			

Starting the Storage Operation

7. Press **STORE**. The storage operation starts and the STORE key illuminates.

Stopping the Storage Operation

8. Pressing **STORE** again after the storage operation is started stops the operation. The STORE key turns OFF.

9.1 Storing the Measured Results

Explanation

Store Count

The specified number of points of measured results is stored.

Selectable range: 1 to 65535

Turning the Auto Storage ON/OFF

When turned On, the storage operation can be started automatically when the sweep operation is started. The store count in this case is automatically set to the sweep count. However, if the sweep count exceeds 65535, the store count is set to 65535.

Starting the Storage Operation

When the storage operation starts, the STORE key illuminates, and the storage of the results of the source measure cycle starts. When the specified store count of source measure cycle results are stored, the storage operation automatically stops, and the STORE key turns OFF. The stored results are stored in the result file (Result.csv) on the GS610 RAM disk.

Result File

The stored results are stored in the result file (Result.csv) on the GS610 RAM disk. The result file is a text file in CSV format.

Note

You can change the decimal point and separator that are used in the result files to the notations that match the Excel program that you use. For the procedure, see section 11.8, "Selecting the Decimal Point and Separator Notations of CSV Files."

Result File Example

	A	B	C	D	E	F
1	Time(s)	Source(V)	Measure(A)	Setup	Comp	
2	0	0.00E+00	-9.43E-07	:TRIG:TIM 1	0	
3	0.9974	5.00E+00	3.29E-07	:TRIG:TIM 0.1	1	
4	1.0974	4.00E+00	-1.18E-06		-1	
5	1.1974	3.50E+00	-1.07E-06		-1	
6	1.2974	3.00E+00	-1.06E-06	:TRIG:TIM 0.5	-1	
7						
8						
9						
10						
11						
12						
13						
14						

0: In
1: High
-1: Low

Up to 33 result files are stored through auto numbering within the capacity (4 MB) of the GS610RAM. The name of the most recent result file is always Result.csv. When the storage operation is repeated, the result file is automatically numbered, and the file name is automatically updated. If two storage operations are complete, the most recent file is Result.csv, and the previous result file is Result1.csv. If the storage operation is repeated further, the result file name changes as follows: Result.csv, Result1.csv, Result2.csv, Result3.csv, and so on. Up to 32 results files are automatically numbered. If the number of result files exceeds 33, the files are deleted in order from the oldest file. However, if the size of the new result file is large such as when the store count is large, multiple result files may be deleted so that the capacity of the GS610RAM is not exceeded when the most recent result file is created.

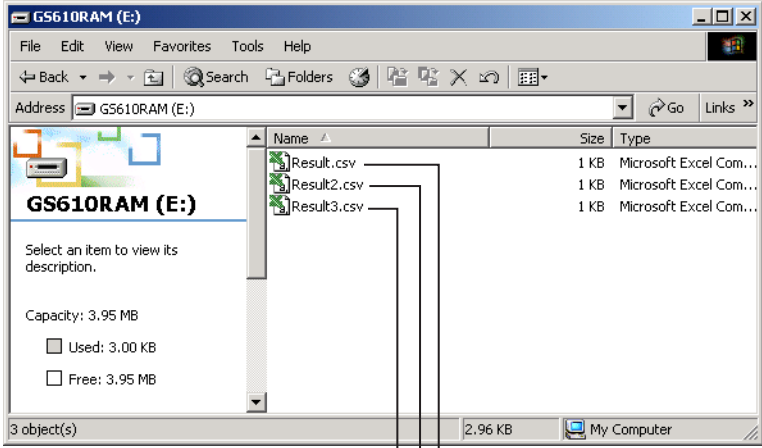

Previous result file
 Second oldest result file
 Most recent result file

Numbering of the Result Files

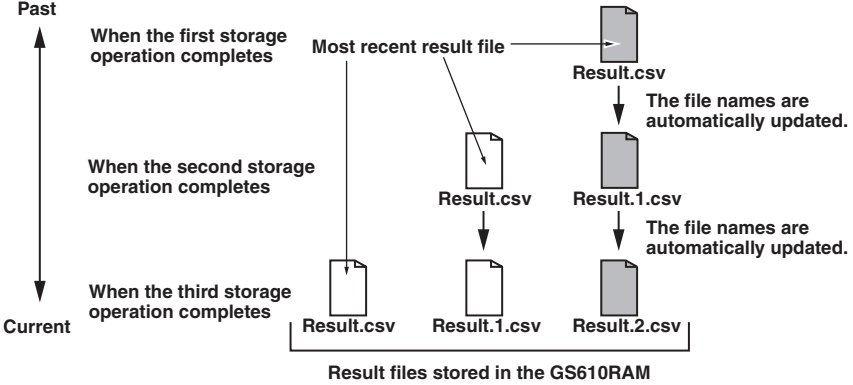

Note

GS610RAM is a volatile memory. When the GS610 is turned OFF, the stored files are lost. If you want to save the result files, copy them to a different directory before you turn the GS610 OFF.

Stopping the Storage Operation

If you press STORE before the storage operation reaches the specified store count, the storage operation is forcibly stopped. The results until the storage operation is stopped are saved in the result file on the GS610RAM disk.

<<Corresponding Command Mnemonic>>

- :TRACe [:STATe]
- :TRACe:POINts
- :TRACe:AUTO

9.2 Recalling Statistical Computation Values

Procedure

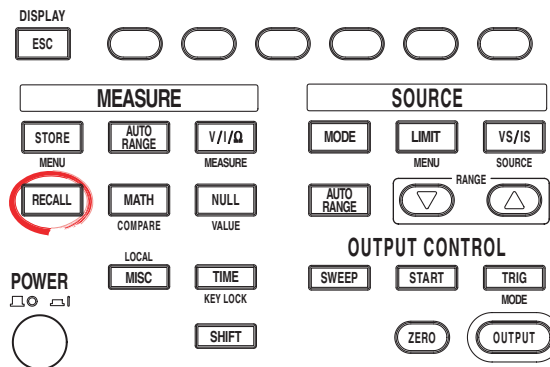

- To exit the menu during operation, press **ESC** at the upper left of the operation panel.
- In the procedural explanation below, the phrase “**rotary knob, numeric keys, <, and >**” are used to refer to the operation of selecting or setting items or entering values using the **rotary knob, numeric keys, <**, and **>** keys (BS key and right arrow key). For details on the operation using the rotary knob, numeric keys, **<**, and **>**, see sections 3.8 or 3.9.

Press **RECALL** to display the statistical computation results of the measured results of the most recent stored result.

Explanation

Statistical Computation Parameters

The following statistical computation parameters are displayed.

Total count :	10	Store count
Maximum :	4.98435E-07	Maximum value
Minimum :	7.05163E-09	Minimum value
Peak-Peak :	4.91383E-07	Maximum value – minimum value
Mean :	6.01002E-08	Average
Standard deviation :	1.54067E-07	Standard deviation

<<Corresponding Command Mnemonic>>

:TRACe:ACTual?
 :TRACe:CALCulate:ACTual?
 :TRACe:CALCulate:MAXimum?
 :TRACe:CALCulate:MINimum?
 :TRACe:CALCulate:AVERage?
 :TRACe:CALCulate:SDEViation?

10.1 Setting the Input/Output Signals of the BNC Input/Output Terminal and the External Input/Output Connector

Procedure

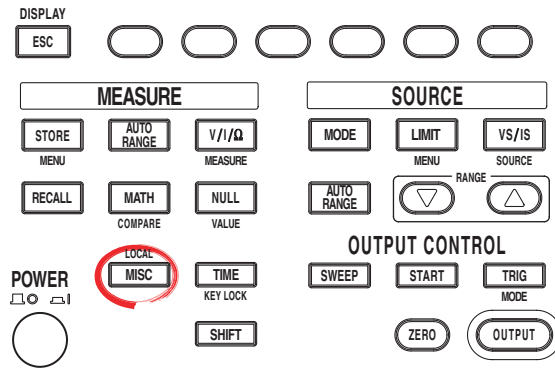

- To exit the menu during operation, press **ESC** at the upper left of the operation panel.
- In the procedural explanation below, the phrase “**rotary knob, numeric keys, <, and >**” are used to refer to the operation of selecting or setting items or entering values using the **rotary knob, numeric keys, <**, and **>** keys (BS key and right arrow key). For details on the operation using the rotary knob, numeric keys, **<**, and **>**, see sections 3.8 or 3.9.

1. Press **MISC** to display the MISC menu.
2. Press the **System** soft key to display the System menu.

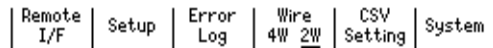

3. Press the **External I/O** soft key to display the External I/O menu.

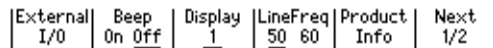

To set the BNC input/output terminal, proceed to step 4. To set the external input/output connector, proceed to step 13.

Setting the BNC Input Terminal

4. Press the **BNC In** soft key to display the BNC In menu.

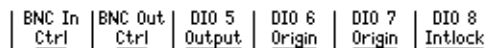

5. Select the signal to be applied to the BNC input terminal from Trig, Sweep, and Ctrl.

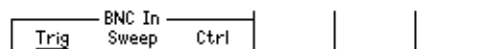

If you select Ctrl, proceed to step 6. If you select Trig or Sweep, proceed to step 8.

6. If you select Ctrl in step 5, a Type menu appears for you to select the input control signal.
Press the **Type** soft key.

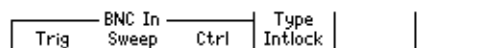

7. Press the Intlock, Output, or Zero soft key to select the signal.

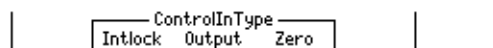

8. Press **ESC** to return to the External I/O menu.

10.1 Setting the Input/Output Signals of the BNC Input/Output Terminal and the External Input/Output Connector

Setting the BNC Output Terminal

- Press the **BNC Out** soft key to select the signal to output from the BNC output terminal from Trig, Sweep, and Ctrl.

```

┌──────────┐ BNC Out ┌──────────┐ Type
└── Trig ─┘ └── Sweep ─┘ └── Ctrl ─┘ └── Origin ─┘ |   |   |
  
```

- Press the **Type** soft key to select the appropriate signal for your application.
 - If Trig is selected in the BNC Out menu
 - Select Origin, SrcChg, MeasBgn, MeasEnd, or PulsEnd.

```

┌──────────┐ TrigOutType ┌──────────┐
└── Origin ─┘ SrcChg MeasBgn MeasEnd PulsEnd |
  
```

- If Sweep is selected in the BNC Out menu
 - Select Origin, TurnEnd, or AllEnd.

```

|   |   |   |
|   |   |   | ┌──────────┐ SweepOutType ┌──────────┐
|   |   |   | └── Origin ─┘ TurnEnd AllEnd |   |   |
  
```

- If Ctrl is selected in the BNC Out menu
 - Select Intlock, Output, Zero, or Program.

```

┌──────────┐ ControlOutType ┌──────────┐
└── Intlock ─┘ Output Zero Program |   |   |
  
```

- Press **ESC** to return to the External I/O menu.

Setting the External Input/Output Connector

- Press any of the keys from **DIO 5**, **DIO 6**, **DIO 7**, and **DIO 8** to select the signal to input or output from pins 5 to 8 of the external input/output connector.

```

| BNC In | BNC Out | DIO 5 | DIO 6 | DIO 7 | DIO 8 |
|  Ctrl  |  Ctrl  | Output | Origin | Origin | Intlock |
  
```

Proceed to one of the steps from 13 to 16 depending on the selected pin number.

- Press the **DIO 5pin** soft key to set the trigger input signal of the external input/output connector to Output or Zero.

```

|   |   |   |   |   |   |
|   |   |   |   |   |   | ┌──────────┐ DIO 5pin ┌──────────┐
|   |   |   |   |   |   | └── Output ─┘ Zero |   |   |
  
```

- Press the **DIO 6pin** soft key to set the trigger output signal of the external input/output connector to Origin, SrcChg, MeasBgn, MeasEnd, or PulsEnd.

```

┌──────────┐ DIO 6pin(TrigOut) ┌──────────┐
└── Origin ─┘ SrcChg MeasBgn MeasEnd PulsEnd |
  
```

- Press the **DIO 7pin** soft key to set the sweep synchronization output signal of the external input/output connector to Origin, TurnEnd, or AllEnd.

```

|   |   |   |   |   |   |
|   |   |   |   |   |   | ┌──────────┐ DIO 7pin(SweepOut) ┌──────────┐
|   |   |   |   |   |   | └── Origin ─┘ TurnEnd AllEnd |   |   |
  
```

- Press the **DIO 8pin** soft key to set the control output signal of the external input/output connector to Intlock, Output, or Zero.

```

|   |   |   |   |   |   |
|   |   |   |   |   |   | ┌──────────┐ DIO 8pin(ControlOut) ┌──────────┐
|   |   |   |   |   |   | └── Intlock ─┘ Output Zero |   |   |
  
```

10.1 Setting the Input/Output Signals of the BNC Input/Output Terminal and the External Input/Output Connector

Explanation

The GS610 can input or output various signals through the BNC input/output terminal (TRIG/SWEEP/CTRL IN/OUT) and the external input/output connector (EXT I/O) on the rear panel. Such signals include trigger input/output signals that determine the timing of the source and measurement, ON/OFF control signals of output relays, ON/OFF control signals of zero generation, and comparison result output.

The BNC input/output terminal and the external input/output connector are independent. Therefore, different roles can be assigned and used simultaneously.

BNC Input/Output Terminal

One signal can be assigned to each terminal. Multiple signals cannot be assigned.

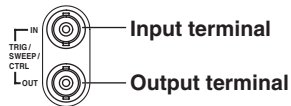

External Input/Output Connector

Multiple signals can be assigned. Pin assignments are shown below.

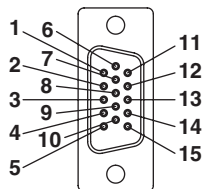

Signal Name and Function

Signal Name	Function	Signal Type	Active	Pin # of the External Input/Output Connector	Type of BNC Terminal	
TrigIn	Trigger input	Edge		2 pin	BNC IN	
Sweep Start In	Sweep start input	Edge		3 pin	BNC IN	
CtrlIn	IntLock	Interlock input	Level	Lo	4 pin	BNC IN
	Output	Relay control input	Both edges	ON OFF	5 pin	BNC IN
	Zero	Zero source control input	Both edges	ON OFF	5 pin	BNC IN
TrigOut	Origin	Trigger output	Pulse		6 pin	BNC OUT
	SrcChg	Source change timing output	Pulse		6 pin	BNC OUT
	MeasBgn	Measure start timing output	Pulse		6 pin	BNC OUT
	MeasEnd	Measure end timing output	Pulse		6 pin	BNC OUT
	PulsEnd	Pulse falling edge timing output	Pulse		6 pin	BNC OUT
SweepOut	Origin	Sweep synchronization output	Pulse		7 pin	BNC OUT
	TurnEnd	Sweep 1 turn end timing output	Pulse		7 pin	BNC OUT
	AllEnd	Sweep all end timing output	Pulse		7 pin	BNC OUT
CtrlOut	IntLock	Interlock through output	Level	Lo	8 pin	BNC OUT
	Output	Relay status output	Level	Lo=ON	8 pin	BNC OUT
	Zero	Zero source status output	Level	Lo=ZERO	8 pin	BNC OUT
	Program	Programmable output	Pulse/Level	programmable	9 pin	BNC OUT
Compare HI	Comparison result output high	Level	Lo	10 pin	—	
Compare IN	Comparison result output IN	Level	Lo	11 pin	—	
Compare LO	Comparison result output low	Level	Lo	12 pin	—	
Compare OV	Comparison result output OVERRANGE	Level	Lo	13 pin	—	
Compare END	Compare end	Pulse		14 pin	—	
GND	Ground	—	—	1 pin, 15 pin	—	

The input TTL level is a negative pulse of 10 μ s or greater in width.
The output TTL level is a negative pulse of 10 μ s in width.

Note

There are no settings that need to be entered on the GS610 screen for the trigger input (TrigIn), sweep synchronization input (Sweep Start In), control input (Ctrl In), and comparison result output (Compare) of the external input/output connector. Make connections according to the pin assignments given above.

10.1 Setting the Input/Output Signals of the BNC Input/Output Terminal and the External Input/Output Connector

Input Signals

- **Trigger (TrigIn)**
A trigger signal input used to start the source measure cycle. The falling edge works in the same fashion as the TRIG key.
- **Sweep Start (SweepStartIn)**
A start signal input used to start the sweep operation. The falling edge works in the same fashion as the START key.
- **Interlock (CtrlIn Intlock)**
An interlock signal input for safe operation. The output is forcibly turned OFF at low level, and the output cannot be turned ON while the signal is at low level.
- **Relay Control (CtrlIn Output)**
An output control signal input. Output is turned ON at the rising edge and turned OFF at the falling edge. This signal works in the same fashion as the OUTPUT key.
- **Zero Generation Control (CtrlIn Zero)**
A control signal input for zero output. When the output is ON, a falling edge sets the GS610 to zero output state, and a rising edge set the GS610 to output ON state. This signal works in the same fashion as the ZERO key.

Output Signals

- **Trigger (TrigOut Origin)**
The actual trigger signal (start timing of the source measure cycle) is output as a pulse signal.
- **Source Change Timing (TrigOut SrcChg)**
The source level change timing after the source delay is output as a pulse signal.
- **Measurement Start Timing (TrigOut MeasBgn)**
The measurement start timing after the measure delay is output as a pulse signal.
- **Measurement End Timing (TrigOut MeasEnd)**
The end timing of the measurement and computation is output as a pulse signal.
- **Pulse Falling Edge Timing (TrigOut PulsEnd)**
The timing of the pulse falling edge when generating pulse signals is output as a pulse signal.
- **Sweep Synchronization (SweepOut Origin)**
The actual start signal (start timing of the sweep operation) is output as a pulse signal.
- **Sweep 1 Turn End Timing (SweepOut TurnEnd)**
When the repeat count is greater than or equal to 1, the end timing of each turn is output as a pulse signal.
- **Sweep All End Timing (SweepOut AllEnd)**
The sweep end timing is output as a pulse signal.
- **Interlock Through (CtrlOut Intlock)**
The interlock input is output as-is.
- **Relay Status (CtrlOut Output)**
The actual output status (ON/OFF state of the OUTPUT key) is output as a level signal.
- **Zero Source Condition (CtrlOut Zero)**
The actual zero condition (ON/OFF state of the ZERO key) is output as a level signal.
- **Programmable (CtrlOut Program)**
Outputs a pulse signal with the “:OUTPut:PROGram PULSe” communication command (page 16-16) and a level signal with the “:OUTPut:PROGram 1|0|ON|OFF” command (page 16-16). If the communication command is written in the pattern file of the program sweep, a pulse signal can be generated at an arbitrary point in the sweep pattern.

10.1 Setting the Input/Output Signals of the BNC Input/Output Terminal and the External Input/Output Connector

- **Comparison Result (Compare HI/Compare In/Compare Low)**
The comparison result (High/In/Low) of the comparison operation is output as a level signal.
- **Comparison Result Output Over Range (Compare OV)**
Outputs a level signal when the measured result is over the range.
- **Comparison End (Compare End)**
Notifies that the comparison result output has been finalized. In the strict sense, the end timing of the source measure cycle is output as a pulse signal.

Input Section (When Using TRIG IN, SWEEP START IN, and CTRL IN)

Input level: TTL level

Minimum pulse width when applying edge input: 10 μ s or greater

- **Input Circuit Diagram**

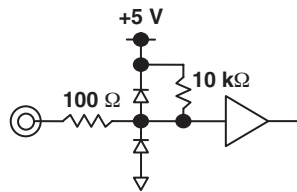

Output Section (When Using TRIG OUT, SWEEP SYNC OUT, and CTRL OUT or COMPARE HI, COMPARE IN, COMPARE LO, COMPARE OV, and COMPARE END)

Output level: TTL level

Pulse width when outputting a pulse signal: Approx. 10 μ s

- **Output Circuit Diagram**

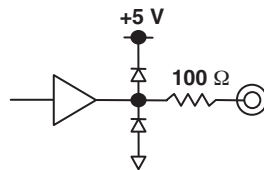

CAUTION

- Do not apply a voltage exceeding the TTL level to the input.
- Do not short or apply external voltage to the output.

<<Corresponding Command Mnemonic>>

```
:ROUte:BNCI:SElect
:ROUte:BNCI:CONTRol
:ROUte:BNCO:SElect
:ROUte:BNCO:TRIGger
:ROUte:BNCO:SWEep
:ROUte:BNCO:CONTRol
:ROUte:DIO5
:ROUte:DIO6
:ROUte:DIO7
:ROUte:DIO8
```

10.1 Setting the Input/Output Signals of the BNC Input/Output Terminal and the External Input/Output Connector

Timing Chart

• Trigger (Trig)

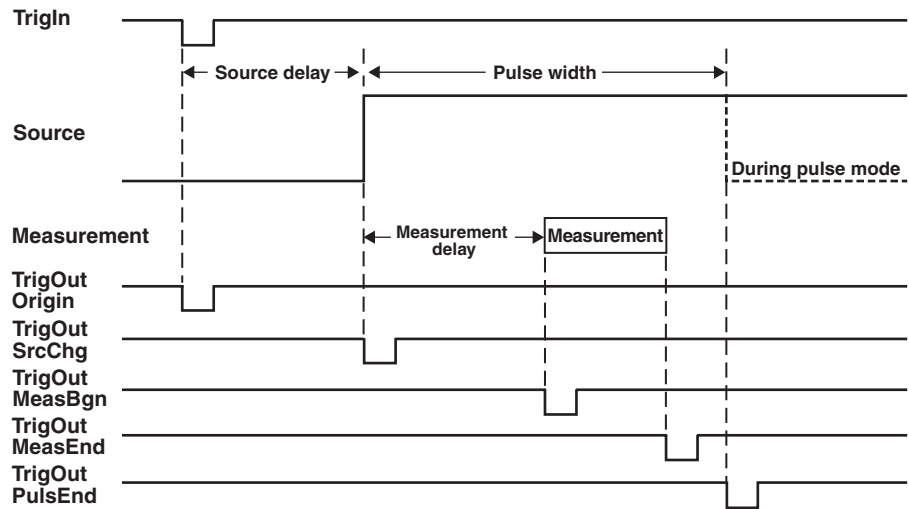

• Sweep

Example when the sweep count is 4

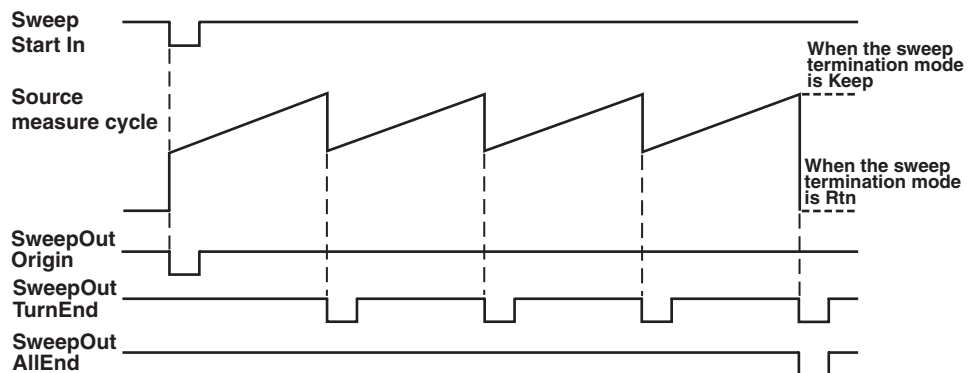

• Control (Ctrl)

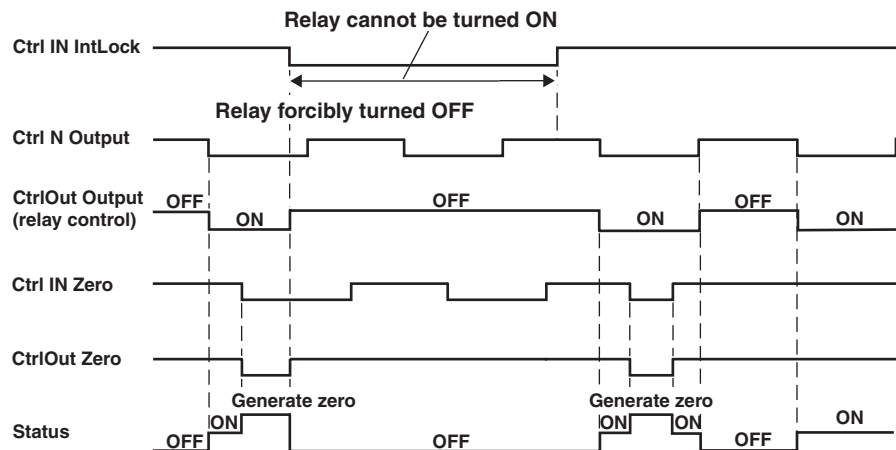

• Programmable Output (Output Using Communication Commands)

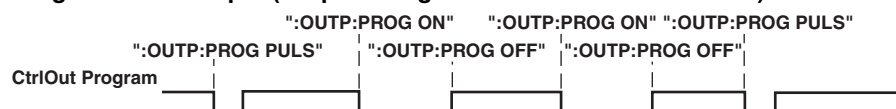

10.2 Synchronized Operation

Multiple GS610s can be connected and operated in sync by using the input/output signal function.

On the GS610, there is no configuration for setting master and slave units. However, the words master and slave are used in the explanations.

Typical synchronization operations are shown below.

Synchronizing the Pulse Generation and Measurement

- **Trigger mode setting**

Master: Internal trigger (Int)

Slave: External trigger (Ext)

For the setup procedure, see section 4.1, "Setting the Trigger."

- **Setting the Input/Output Signals of the BNC Input/Output Terminal and External Input/Output Connector**

Master: Set BNC Out to Trig and set Type to Origin or set DIO 6pin to Origin.

Slave: Set BNC In to Trig.

For the setup procedure, see "Setting the BNC Input Terminal," "Setting the BNC Output Terminal," or "Setting the External Input/Output Connector" in the previous section.

- **Connecting the Instruments**

Connect Trig Out of the master unit to Trig In of the slave unit using the BNC input/output terminal or external input/output connector.

For the pin assignments, see "Signal Name and Function" in the previous section.

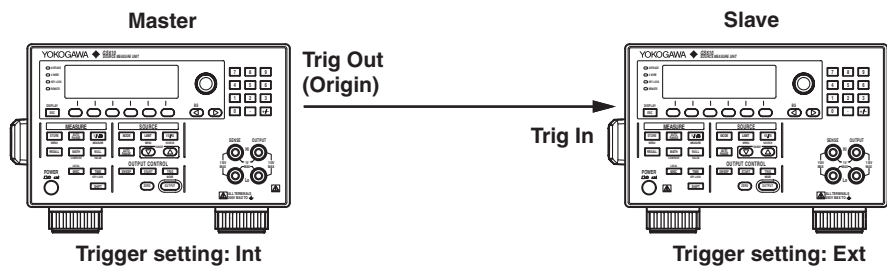

Synchronizing the Sweep Operation

- **Trigger mode setting**

Master: Internal trigger (Int)

Slave: External trigger (Ext)

For the setup procedure, see section 4.1, "Setting the Trigger."

- **Setting the Input/Output Signals of the BNC Input/Output Terminal and External Input/Output Connector**

Master: Set BNC Out to Trig and set Type to Origin or set DIO 6pin to Origin.

Set DIO 7pin to Origin.

Slave: Set BNC In to Trig.

For the setup procedure, see "Setting the BNC Input Terminal," "Setting the BNC Output Terminal," or "Setting the External Input/Output Connector" in the previous section.

10.2 Synchronized Operation

- **Connecting the Instruments**

Connect Trig Out of the master unit to Trig In of the slave unit and connect Sweep Sync Out of the master unit to Sweep Start In of the slave unit using the BNC input/output terminal or external input/output connector.

For the pin assignments, see “Signal Name and Function” in the previous section.

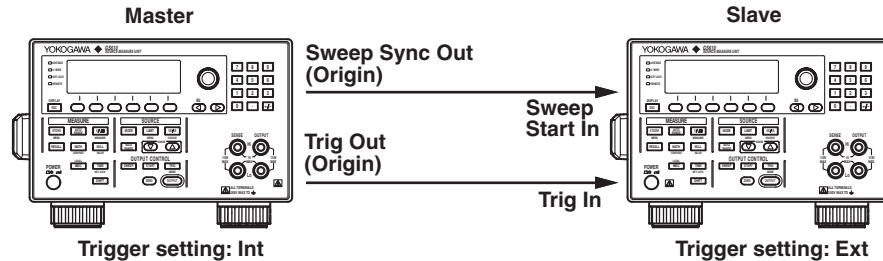

Synchronizing the Output Control

- **Setting the Input/Output Signals of the BNC Input/Output Terminal and External Input/Output Connector**

Master: Set BNC Out to Ctrl, and set Type to the appropriate setting for your application (IntLock, Output, or Zero).

If DIO8 is used, set it in a similar fashion.

Slave: Set BNC In to Ctrl, and set Type to the appropriate setting for your application (IntLock, Output, or Zero).

If DIO5 is used, set it in a similar fashion.

For the setup procedure, see “Setting the BNC Input Terminal,” “Setting the BNC Output Terminal,” or “Setting the External Input/Output Connector” in the previous section.

- **Connecting the Instruments**

Connect Ctrl Out of the master unit to Ctrl In of the slave unit using the BNC input/output terminal or external input/output connector.

For the pin assignments, see “Signal Name and Function” in the previous section.

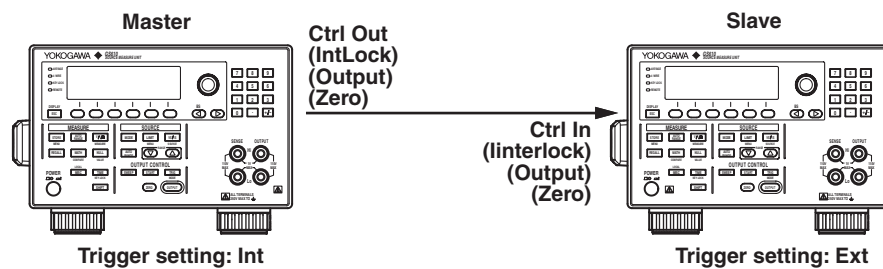

Note

- The time for the signal to pass from TRIG IN to TRIG OUT (ORIGIN) is 1 μ s or less.
- The error in the time from applying a signal to TRIG IN to starting the source measure cycle is less than or equal to 10 μ s.
- Use fixed range for the source range setting and measurement range setting on all GS610s that are to be synchronized, and set various time parameters such as the integration time to the same value.
- Use the shortest wiring possible to reduce the delay caused by wiring capacitance.
- Keep the number of slave units less than five.

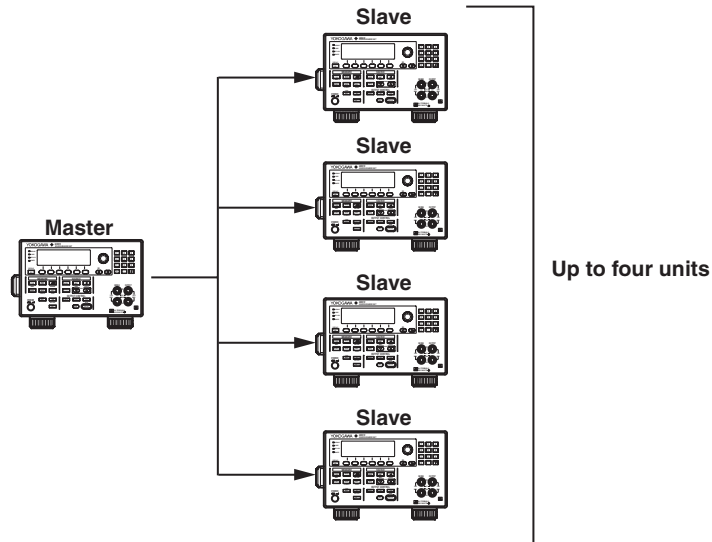

If you are connecting more than 4 units, connect them as shown below. Be sure to take into account the delay that occurs in each unit.

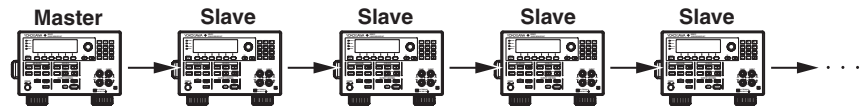

11.1 Saving the Setup Data

Procedure

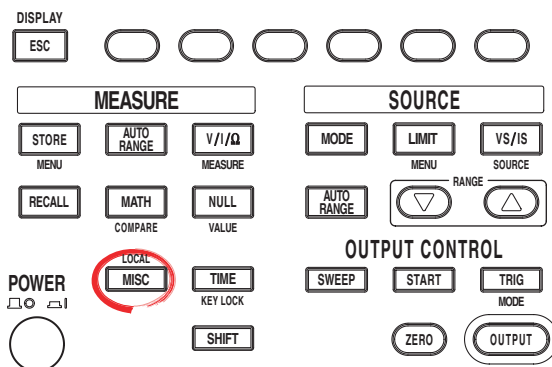

- To exit the menu during operation, press **ESC** at the upper left of the operation panel.
- In the procedural explanation below, the phrase “**rotary knob, numeric keys, <, and >**” are used to refer to the operation of selecting or setting items or entering values using the **rotary knob, numeric keys, <**, and **>** keys (BS key and right arrow key). For details on the operation using the rotary knob, numeric keys, **<**, and **>**, see sections 3.8 or 3.9.

- Press **MISC** to display the MISC menu.
- Press the **Setup** soft key. The files that are currently saved and the Setup menu is displayed.

```
| Remote | Setup | Error | Wire | CSV | System |
| I/F   |         | Log   | 4W 2W | Setting |         |
```

- Press the **Save Setup** soft key. The menu (SaveRamDisk) for saving to the volatile disk (GS610RAM) and the menu (Save Setup1 to Save Setup4) for saving to the non-volatile disk (GS610ROM) are displayed.

```
* Default.txt      2005/06/28 16:31
  Setup1.txt       2005/07/05 14:15
  Setup2.txt       2005/07/06 20:33
```

```
| Save | | | | Load | PowerOn |
| Setup | | | | Setup | Setup |
```

Saving to the Volatile Disk (GS610RAM)

- Press the **SaveRamDisk** soft key. The SaveRamDisk soft key blinks while the save operation is in progress. When the save operation completes, the menu shown in step 2 appears.

```
* Default.txt      2005/06/14 15:32
  Setup1.txt       2005/06/14 15:33
  Setup2.txt       2005/06/14 15:33
```

```
| Save | | | | Save | Save |
| RamDisk | | | | Setup1 | Setup2 | Setup3 | Setup4 |
```

Saving to the Non-Volatile Disk (GS610ROM)

- Press the soft key corresponding to the desired setup number from **Save Setup1** to **Save Setup4**. The soft key that you pressed blinks while the save operation is in progress. When the save operation completes, the menu shown in step 2 appears.

```
* Default.txt      2005/06/14 15:32
  Setup1.txt       2005/06/14 15:33
  Setup2.txt       2005/06/14 15:33
```

```
| Save | | | | Save | Save |
| RamDisk | | | | Setup1 | Setup2 | Setup3 | Setup4 |
```

Explanation

Saving to the Volatile Disk (GS610RAM)

The setup file (Setup.txt) is stored to the GS610RAM. If a setup file already exists, it is overwritten.

This setup file is used to transfer the file to a PC.

Saving to the Non-Volatile Disk (GS610ROM)

The setup file (Setup1 to Setup4.txt) are saved to the SETUP folder on the GS610ROM. Up to four setup files can be saved. If a different file is saved to a number already containing a setup file, it is overwritten.

Note

- The setup file is a text file containing a sequence of command mnemonics. The contents can be edited on a PC.
 - The file stored in the SETUP directory on the GS610ROM can be renamed on the PC. However, do not rename the default setup file (Default.txt).
-

<<Corresponding Command Mnemonic>>

:SYSTem:SETup:SAVE

*SAV

11.2 Loading the Setup Data

Procedure

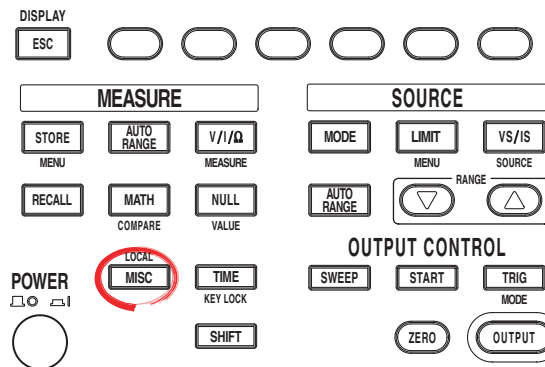

- To exit the menu during operation, press **ESC** at the upper left of the operation panel.
- In the procedural explanation below, the phrase “**rotary knob, numeric keys, <, and >**” are used to refer to the operation of selecting or setting items or entering values using the **rotary knob, numeric keys, <**, and **>** keys (BS key and right arrow key). For details on the operation using the rotary knob, numeric keys, **<**, and **>**, see sections 3.8 or 3.9.

1. Press **MISC** to display the MISC menu.
2. Press the **Setup** soft key. The files that are currently saved and the Setup menu is displayed.

```
| Remote | Setup | Error | Wire | CSV | System |
| I/F   |         | Log  | 4W 2W | Setting |         |
```

3. Use the **rotary knob** and **<** and **>** keys to select the setup file to be loaded.

```
* Default.txt      2005/06/28 16:31
  Setup1.txt       2005/07/05 14:15
  Setup2.txt       2005/07/06 20:33
```

```
| Save | | | | Load | PowerOn |
| Setup | | | | Setup | Setup |
```

4. Press the **Load Setup** soft key. The setup file is loaded, and the display returns to the numeric display.

Explanation

A saved setup file can be loaded to restore the settings.

Note

The GS610 is set to the factory default settings if the Default.txt file is loaded. For details on the Default.txt file, see appendix 3, “Contents of the Factory Default Setup File (Default.txt).”

<<Corresponding Command Mnemonic>>

- **:SYSTEM:SETup:LOAD**
- ***RCL**
- ***RST** (reset to the factory default settings)

11.3 Selecting the Settings Applied at Power ON

Procedure

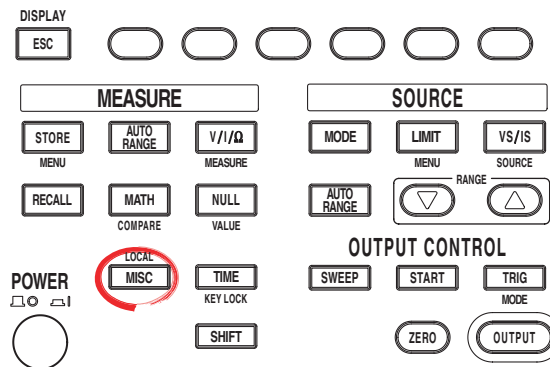

- To exit the menu during operation, press **ESC** at the upper left of the operation panel.
- In the procedural explanation below, the phrase “**rotary knob, numeric keys, <, and >**” are used to refer to the operation of selecting or setting items or entering values using the **rotary knob, numeric keys, <**, and **>** keys (BS key and right arrow key). For details on the operation using the rotary knob, numeric keys, **<**, and **>**, see sections 3.8 or 3.9.

1. Press **MISC** to display the MISC menu.
2. Press the **Setup** soft key to display the Setup menu.

```
| Remote | Setup | Error | Wire | CSV | System |
| I/F   |         | Log  | 4W 2W | Setting |         |
```

3. Use the **rotary knob** and **<** and **>** keys to select the setup file that is applied when the GS610 is turned ON and press the **PowerOnSetup** soft key. An asterisk is placed on the selected setup file.

```
* Default.txt      2005/06/28 16:31
  Setup1.txt       2005/07/05 14:15
  Setup2.txt       2005/07/06 20:33
```

```
| Save | | | | Load | PowerOn |
| Setup | | | | Setup | Setup |
```

Explanation

The setup files are the files (Setup1.txt to Setup4.txt) that are saved in section 11.1, “Saving the Setup Data” and the factory default setup file (Default.txt). If you select Default.txt, the settings are initialized each time the power is turned ON.

Note

The communication command “*RST” initializes settings other than the stored setup data, communication parameters, and brightness (see section 16.2.3, “Common Commands”).

<<Corresponding Command Mnemonic>>

:SYSTEM:SETUP:PON

11.4 Turning the Beep Sound ON/OFF

Procedure

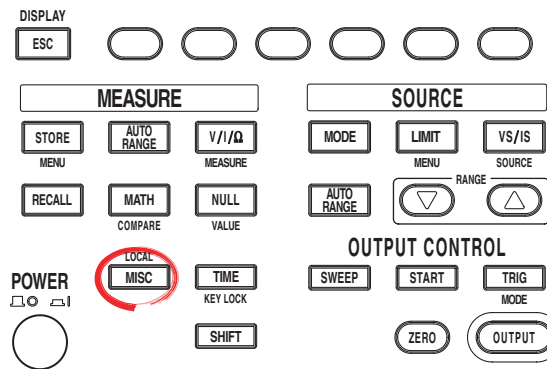

- To exit the menu during operation, press **ESC** at the upper left of the operation panel.
- In the procedural explanation below, the phrase “**rotary knob, numeric keys, <, and >**” are used to refer to the operation of selecting or setting items or entering values using the **rotary knob, numeric keys, <**, and **>** keys (BS key and right arrow key). For details on the operation using the rotary knob, numeric keys, **<**, and **>**, see sections 3.8 or 3.9.

1. Press **MISC** to display the MISC menu.
2. Press the **System** soft key to display the System menu.

```
| Remote | Setup | Error | Wire | CSV | System |
| I/F   |          | Log  | 4W 2W | Setting |          |
```

3. Press the **Beep** soft key to select On or Off.

```
| External | Beep | Display | LineFreq | Product | Next |
| I/O     | On Off | 1       | 50 60   | Info    | 1/2  |
```

Explanation

If the beep sound is turned ON, a beep sound is generated such as when an error occurs during operation.

<<Corresponding Command Mnemonic>>

:SYSTem:BEEPer [:STATE]

11.5 Displaying the Error Log

Procedure

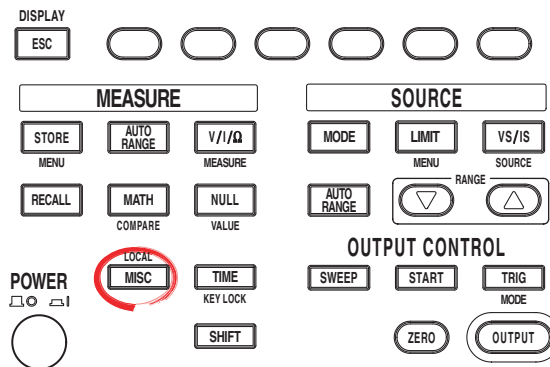

- To exit the menu during operation, press **ESC** at the upper left of the operation panel.
- In the procedural explanation below, the phrase “**rotary knob, numeric keys, <, and >**” are used to refer to the operation of selecting or setting items or entering values using the **rotary knob, numeric keys, <**, and **>** keys (BS key and right arrow key). For details on the operation using the rotary knob, numeric keys, **<**, and **>**, see sections 3.8 or 3.9.

1. Press **MISC** to display the MISC menu.

Displaying the Error Log

2. Press the **Error Log** soft key to display the error log.

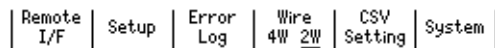

Clearing the Error Log Display

3. Press the **Clear** soft key to clear the error log.

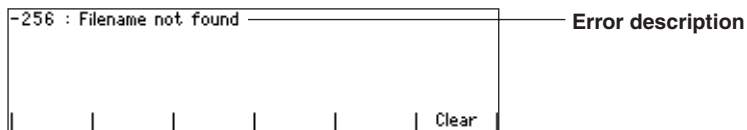

Explanation

When an error such as a runtime error or communication command error is stored in the error memory, the error indicator (Err) illuminates at the upper right corner of the display. The error log displays errors and messages. An error has an associated error number, and a message does not.

A message is displayed in the error log until the problem indicated by the message is solved. It is not cleared when the Clear soft key is pressed.

For the meaning and corrective action of errors, see section 17.2, “Error Code Description and Corrective Action.”

Note

- The error memory is also cleared when the error is read using a communication command (“:SYSTem:ERRor?”) or when the GS610 is turned OFF. You can also clear the error memory by sending the *CLS communication command.
- When the error memory is full, “-350: Queue overflow” is entered as the last error indicating that any addition errors will be discarded. When the error memory is cleared, the error indicator turns OFF.

<<Corresponding Command Mnemonic>>

:SYSTem:ERRor?
*CLS

11.6 Selecting the Display Brightness and Turning the Display OFF

Procedure

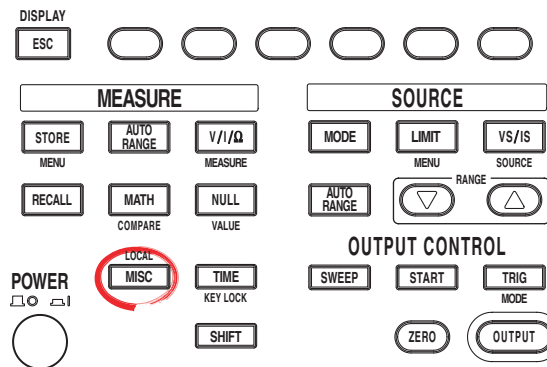

- To exit the menu during operation, press **ESC** at the upper left of the operation panel.
- In the procedural explanation below, the phrase “**rotary knob, numeric keys, <, and >**” are used to refer to the operation of selecting or setting items or entering values using the **rotary knob, numeric keys, <**, and **>** keys (BS key and right arrow key). For details on the operation using the rotary knob, numeric keys, **<**, and **>**, see sections 3.8 or 3.9.

- Press **MISC** to display the MISC menu.
- Press the **System** soft key to display the System menu.

```
| Remote | Setup | Error | Wire | CSV | System |
| I/F   |          | Log  | 4W 2W | Setting |          |
```

- Press the **Display** soft key.

```
| External | Beep | Display | LineFreq | Product | Next |
| I/O     | On Off | 1       | 50 60   | Info    | 1/2  |
```

Selecting the Display Brightness

- Press the soft key corresponding to the desired brightness.

```
----- Brightness ----- | Off |
| 1 2 3 4 | | Exec |
```

Turning the Display OFF

- Press the **Off Exec** soft key. The display is turned OFF, and the SHIFT key blinks until the display is turned ON again. Press any key or turn the **rotary knob** to turn the display back ON.

```
----- Brightness ----- | Off |
| 1 2 3 4 | | Exec |
```

Explanation

Selecting the Display Brightness

You can select the display brightness in the range of 1 to 4. The darkest setting is 1, and the brightest setting is 4.

Turning the Display OFF

You can turn OFF the display to prolong the service life of the display.

<<Corresponding Command Mnemonic>>

```
:SYSTem:DISPlay[:STATe]
:SYSTem:DISPlay:BRIGht
```

11.7 Key Lock

Procedure

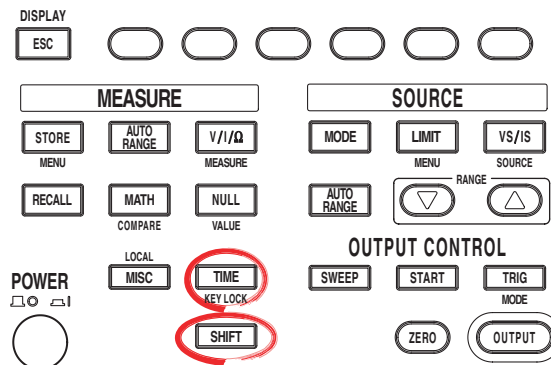

- To exit the menu during operation, press **ESC** at the upper left of the operation panel.
- In the procedural explanation below, the phrase “**rotary knob, numeric keys, <, and >**” are used to refer to the operation of selecting or setting items or entering values using the **rotary knob, numeric keys, <**, and **>** keys (BS key and right arrow key). For details on the operation using the rotary knob, numeric keys, **<**, and **>**, see sections 3.8 or 3.9.

Turning Key Lock ON

Press **SHIFT+TIME(KEY LOCK)**. The key lock turns ON, and the KEY LOCK indicator to the left of the display illuminates. When the key lock is turned ON, all keys are disabled except for the power switch and the SHIFT+TIME (KEY LOCK) key.

Turning Key Lock OFF

Press **SHIFT+TIME (KEY LOCK)** when the key lock is ON. The key lock turns OFF, and the KEY LOCK indicator turns OFF. All keys are enabled.

Explanation

Key lock can be enabled even when the GS610 is in the remote mode through the communication function.

<<Corresponding Command Mnemonic>>

:SYSTem:KLOCK

11.8 Selecting the Decimal Point and Separator Notations of CSV Files

Procedure

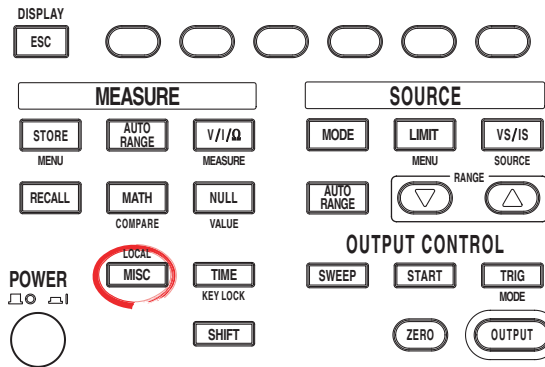

- To exit the menu during operation, press **ESC** at the upper left of the operation panel.
- In the procedural explanation below, the phrase “**rotary knob, numeric keys, <, and >**” are used to refer to the operation of selecting or setting items or entering values using the **rotary knob, numeric keys, <**, and **>** keys (BS key and right arrow key). For details on the operation using the rotary knob, numeric keys, **<**, and **>**, see sections 3.8 or 3.9.

1. Press **MISC** to display the MISC menu.
2. Press the **CSV Setting** soft key to display the CSV Setting menu.

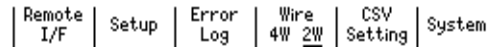

3. Press the **DecPoint** or **Separate** soft key to select the decimal point or separator notation of CSV files. The **DecPoint** and **Separate** settings are interlocked. Changing either setting changes the other setting automatically.



Explanation

Select the decimal point and separator notations used in program pattern files and measurement result files that are in CSV format. **Note that if you do not select the correct notation for your Excel program, the CSV files will not be loaded correctly.** The decimal point (DecPoint) and separator (Separate) settings are interlocked. Changing either setting automatically changes the other. The following two combinations are available.

Combination with the decimal point set to period and the separator set to comma

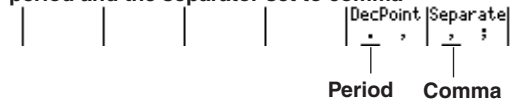

Combination with the decimal point set to comma and the separator set to semicolon



Changes each time you press DecPoint or Separate

Note

- The factory default setting is the combination of period and comma.
- The selected notation applies only to program pattern files and measurement result files. It is not applied to the numeric notation used on the display and communication commands. In addition, this setting does not change even if you load the setup data (see section 11.2, “Loading the Setup Data”) or execute the “RST” communication command (see section 16.2.13, “Common Commands”).

12.1 Ethernet Interface Functions and Specifications

Ethernet Interface Functions

Reception Function

- You can specify the same settings as those specified by front panel key operations.
- Receives output requests for measured and computed data, setup data of the panel, and error codes.

Transmission Function

- Outputs measured and computed data.
- Outputs panel setup data and the status byte.
- Outputs error codes that have occurred.

Switching between Remote and Local Modes

When Switching from Local to Remote Mode

Remote mode is activated when the :SYSTem:REMOte command is received from a controller while local mode is active.

- The REMOTE indicator (see section 1.2) is turned ON.
- All keys except the **LOCAL** key are disabled.
- Settings entered in local mode are retained even when the GS610 switches to remote mode.

When Switching from Remote to Local Mode

Pressing **LOCAL** in remote mode puts the instrument in local mode. The GS610 switches to local mode when it receives a :SYSTem:LOCAl command from the PC.

- The REMOTE indicator is turned OFF.
- Key operations are enabled.
- Settings entered in remote mode are retained even when the GS610 switches to local mode.

Ethernet Interface Specifications

Connector type:

RJ-45

Number of ports:

1

Electrical and mechanical specifications:

Conforms to IEEE 802.3.

Transmission system:

100BASE-TX/10BASE-T

Maximum transmission rate:

100 Mbps

Protocol:

TCP/IP

Command control server function:

A command mnemonic stream parsing server at port 7655 that allows up to five clients to connect. The terminator (CR, LF, or CR+LF) can be specified.

FTP server function:

An anonymous FTP server at port 21 that allows up to five clients to connect.

HTTP server function:

A function that enables various information to be displayed and performs remote control of the GS610 through port 80 using a Web browser.

12.2 Connecting to the Network

Connect a UTP (Unshielded Twisted-Pair) cable or an STP (Shielded Twisted-Pair) cable that is connected to a hub, for example, to the 100BASE-TX port on the rear panel of the GS610.

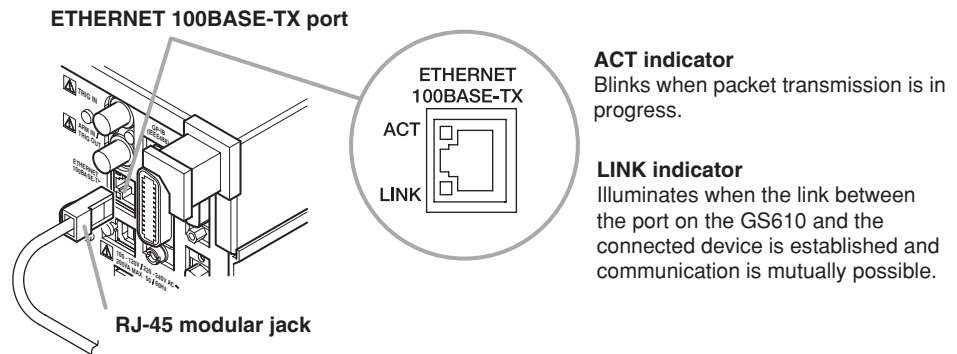

Cable

Use either of the following cables to make the connection.

- UTP (Unshielded Twisted-Pair) cable (category 5 or better)
- STP (Shielded Twisted-Pair) cable (category 5 or better)

When Connecting to a PC on the Network

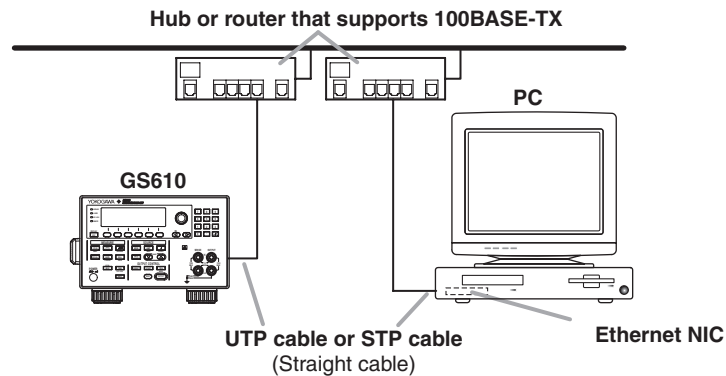

When Making a One-to-One Connection with the PC

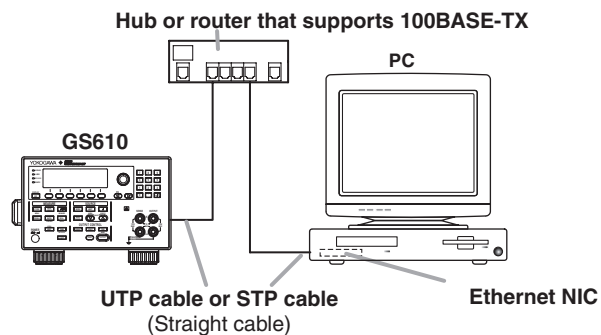

Note

- When using a UTP cable or STP cable (straight cable), be sure to use a category 5 or better cable.
- Avoid connecting the PC directly to the GS610 without going through the hub or router. Operations are not guaranteed for communications using direct connection.

12.3 Setting the TCP/IP

Procedure

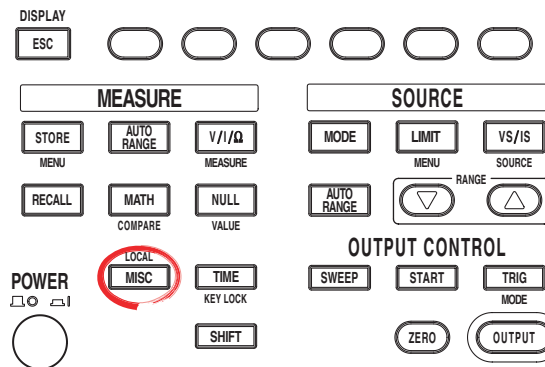

- To exit the menu during operation, press **ESC** at the upper left of the operation panel.
- In the procedural explanation below, the phrase “**rotary knob, numeric keys, <, and >**” are used to refer to the operation of selecting or setting items or entering values using the **rotary knob, numeric keys, <**, and **>** keys (BS key and right arrow key). For details on the operation using the rotary knob, numeric keys, **<**, and **>**, see sections 3.8 or 3.9.

1. Press **MISC** to display the MISC menu.
2. Press the **Remote I/F** soft key to display the Remote I/F menu.

```
| Remote I/F | Setup | Error Log | Wire 4W 2W | CSV Setting | System |
```

Selecting Ethernet Communications

3. Press the **LAN** soft key to display the LAN menu.

```
| GPIB 30 | RS232 | LAN | USB Storage | | |
```

Selecting Whether to Use DHCP

4. Press the **DHCP** soft key to select On or Off.

```
| DHCP On Off | | | | Term LF | OverView |
```

Setting the IP Address

Turn OFF DHCP according to the procedure described earlier, and then set the IP address.

5. Press the **IP Address** soft key to display the IP address setup screen.

```
| DHCP On Off | IP Address | SubNet Mask | Default Gateway | Term CR+LF | OverView |
```

6. Use the **numeric keys** to set the IP address.

```
IP Address 10. 0. 159. 60
| | | | | Enter |
```

7. Press the **Enter** soft key to confirm the setting.

Setting the Subnet Mask

Turn OFF DHCP according to the procedure described earlier, and then set the subnet mask.

5. Press the **SubNet Mask** soft key to display the subnet mask setup screen.

```
| DHCP On Off | IP Address | SubNet Mask | Default Gateway | Term CR+LF | OverView |
```

12.3 Setting the CP/IP

- Use the **numeric keys** to set the subnet mask.

SubNet Mask	255	.	255	.	252	.	0	Enter
----------------	-----	---	-----	---	-----	---	---	-------

- Press the **Enter** soft key to confirm the setting.

Setting the Default Gateway

Turn OFF DHCP according to the procedure described earlier, and then set the default gateway.

- Press the **Default Gateway** soft key to display the default gateway setup screen.

DHCP On Off	IP Address	SubNet Mask	Default Gateway	Term CR+LF	OverView
----------------	---------------	----------------	--------------------	---------------	----------

- Use the **numeric keys** to set the default gateway.

Default Gateway	10	.	0	.	156	.	1	Enter
--------------------	----	---	---	---	-----	---	---	-------

- Press the **Enter** soft key to confirm the setting.

Setting the Transmission Terminator

Turn OFF DHCP according to the procedure described earlier, and then set the transmission terminator.

- Press the **Term** soft key to display the Terminator menu.

DHCP On Off	IP Address	SubNet Mask	Default Gateway	Term CR+LF	OverView
----------------	---------------	----------------	--------------------	---------------	----------

- Press the soft key corresponding to the desired terminator.

		Terminator	
	CR	LF	CR+LF

Explanation

To use the network function of the GS610, the TCP/IP parameters must be configured.

Ethernet Communications

The GS610 can be controlled using communication commands from a PC via the Ethernet interface.

DHCP (Dynamic Host Configuration Protocol)

DHCP is a protocol that allocates setup information that is needed temporarily to PCs connecting to the network. When DHCP is turned ON, the following settings are automatically assigned.

IP address
Subnet mask
Default gateway

- To use DHCP, the network must have a DHCP server. Consult your network administrator to see if DHCP can be used.
- When DHCP is turned ON, different settings may be assigned each time the power is turned ON. When accessing the GS610 from a PC, you must check the GS610 TCP/IP settings such as the IP address each time the power is turned ON.

IP Address (Internet Protocol Address)

You can set the IP address assigned to the GS610. You can set the IP address only when DHCP is turned OFF.

- The IP address is an ID that is assigned to each device on an IP network such as the internet or an intranet.
- The address is a 32-bit value expressed using four octets (each 0 to 255), each separated by a period as in [192.168.111.24].
- Obtain an IP address from your network administrator.
- This parameter is automatically configured in environments using DHCP.

Subnet Mask

You can set the mask value used when determining the subnet network address from the IP address. You can set the subnet mask only when DHCP is turned OFF.

- Huge TCP/IP networks such as the Internet are often divided up into smaller networks called sub networks. The subnet mask is a 32 bit value that specifies the number of bits of the IP address used to identify the network address. The portion other than the network address is the host address that identifies individual computers on the network.
- Consult your network administrator for the subnet mask value. You may not need to set the value.
- This parameter is automatically configured in environments using DHCP.

Default Gateway

You can set the IP address of the gateway (default gateway) used to communicate with other networks. You can set the default gateway only when DHCP is turned OFF.

- The default gateway has control functions that handle protocol exchanges when communicating with multiple networks, so that data transmission is carried out smoothly.
- Consult your network administrator for the default gateway value. You may not need to set the value.
- This parameter is automatically configured in environments using DHCP.

Transmission Terminator

You can set the terminator that is used when sending data from the GS610.

- Select CR, LF, or CR+LF.
- The GS610 handles CR, LF, and CR+LF as a terminator when receiving data.

Note

- If you change the network settings, the GS610 may have to be power cycled.
- If the GS610 is turned ON with the DHCP function enabled but without an Ethernet cable connected, communication functions may not operate properly. In this happens, turn DHCP OFF and power cycle the GS610.
- Network parameters such as the IP address must be specified also on the PC side. For details on the setup, check the manual (help) for your PC or consult your network administrator.

12.4 Checking the Ethernet Settings

Procedure

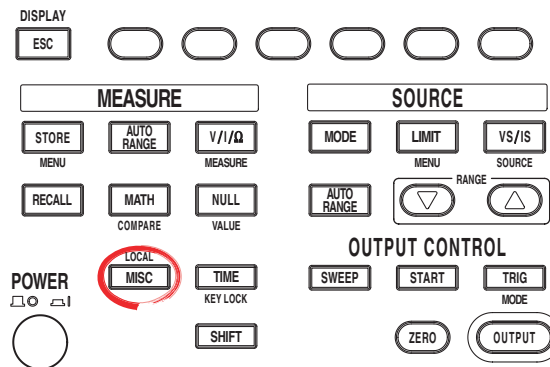

- To exit the menu during operation, press **ESC** at the upper left of the operation panel.
- In the procedural explanation below, the phrase “**rotary knob, numeric keys, <, and >**” are used to refer to the operation of selecting or setting items or entering values using the **rotary knob, numeric keys, <**, and **>** keys (BS key and right arrow key). For details on the operation using the rotary knob, numeric keys, **<**, and **>**, see sections 3.8 or 3.9.

1. Press **MISC** to display the MISC menu.
2. Press the **Remote I/F** soft key to display the Remote I/F menu.

```
| Remote I/F | Setup | Error Log | Wire 4W 2W | CSV Setting | System |
```

Selecting Ethernet Communications

3. Press the **LAN** soft key to display the LAN menu.

```
| GPIB 30 | RS232 | LAN | USB Storage | | |
```

Checking the Network Settings

4. Press the **OverView** soft key. The current network settings are displayed. If the settings have been changed after the GS610 was turned ON, the settings before the change are displayed until the power is cycled.

```
| DHCP On Off | IP Address | SubNet Mask | Default Gateway | Term CR+LF | OverView |
```

Explanation

The following network settings can be confirmed.

- **MAC Address**
A unique 48-bit address assigned to the GS610.
- **IP address** (see section 12.3)
- **Subnet mask** (see section 12.3)
- **Default gateway** (see section 12.3)

```
MAC address : 00:00:68:86:D0:0F
IP address : 10. 0. 159. 60
Subnet mask : 255. 255. 252. 0
Default gateway : 10. 0. 156. 1
```

Note

When DHCP is enabled, “0.0.0.0” is displayed for the IP address, subnet mask, and default gateway until the addresses are assigned. If the display does not change even after 30 seconds elapses after the power is turned ON, the DHCP address assignment may have failed. If this happens, check that the Ethernet cable is connected correctly and that the LINK indicator of the 100BASE-TX port on the rear panel is illuminated, and power cycle the GS610.

12.5 Web Server Function

The Web server function on the GS610 links the Web browser on the PC to the GS610 and enables the GS610 to be controlled from the Web browser window. The following functions are available.

- **Remote Panel Function**
Set or operate the GS610 using keys on the remote panel.
- **Command Control Function**
Set or query the GS610 by sending communication commands from the command control screen.
- **Communication environment display**
Check the communication environment on the status screen
- **FTP Server Function**
View the file on the GS610 volatile memory (GS610RAM) or non-volatile memory (GS610ROM) and transmit or copy files to the PC.

GS610 Environment

Connecting to the Network

Connect the GS610 to the network using the Ethernet. For the connection procedure, see section 12.2.

TCP/IP

Configure the network environment and IP address for communication using the Ethernet interface. For the setup procedure, see section 12.3.

Preparations on the PC

Power up the PC and log on.

Logging into the Web Server (GS610)

1. Start Internet Explorer.
2. Enter the IP address of the GS610 (for example, 10.0.159.30) or the host name of the GS610 (for example, gs610-1) if a DNS server is available on the network.
Enter the IP address http://10.0.159.30/
Enter the host name http://gs610-1/
3. Press the ENTER key on the PC keyboard. If the login to the GS610 Web server is successful, the Web server window appears.

Web Server Window

FTP server function

Communication environment display

Command control function

Remote panel function

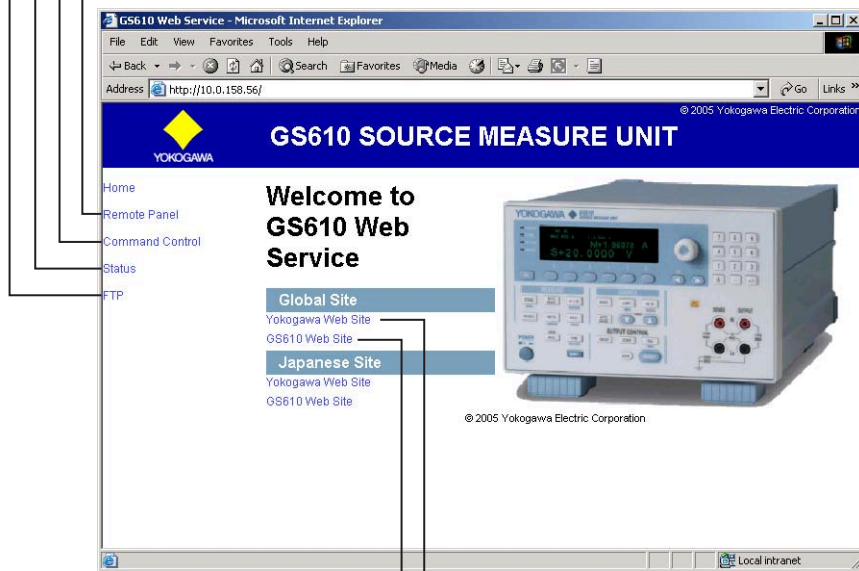

Link to the top page of the YOKOGAWA website
Link to the GS610 page of the YOKOGAWA website

Using the Web Server Function

Remote Panel Function

Click the words "Remote Panel" in the Web server window to display an image of the GS610 front panel.

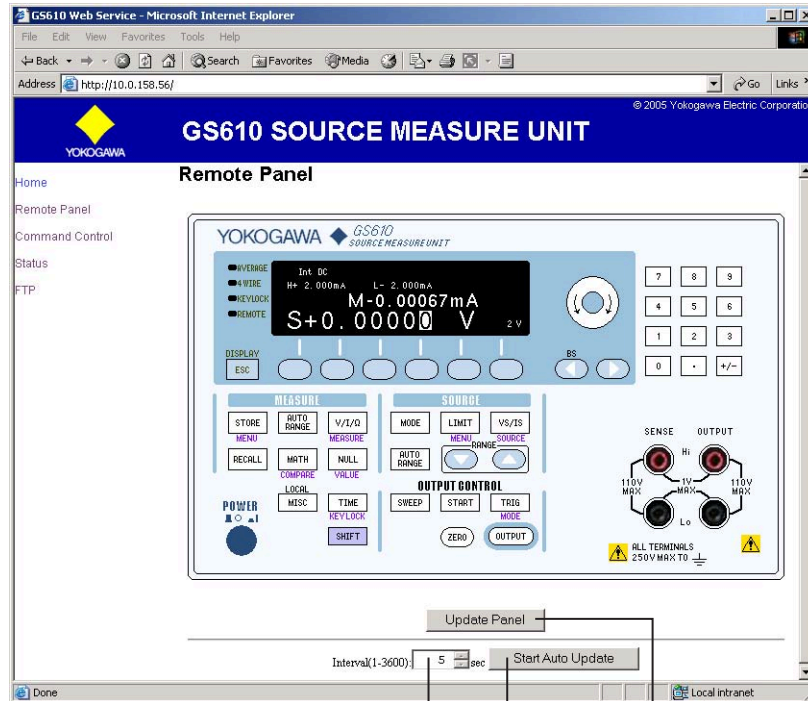

Click to apply the changes to the GS610 panel

Click to apply the changes automatically to the GS610 panel

Set the update interval

The GS610 can be controlled in the same fashion as using the actual keys on the GS610. Point the cursor to the desired key and click. The operation on the remote panel is immediately applied to the GS610. To apply the operations on the GS610 to the remote panel, click Update Panel in the Web server window. Click Start Auto Update to automatically apply the operations on the GS610 to the remote panel at the interval specified in the Interval box.

12.5 Web Server Function

Command Control Function

Click the words "Command Control" in the Web server window to display the command control screen.

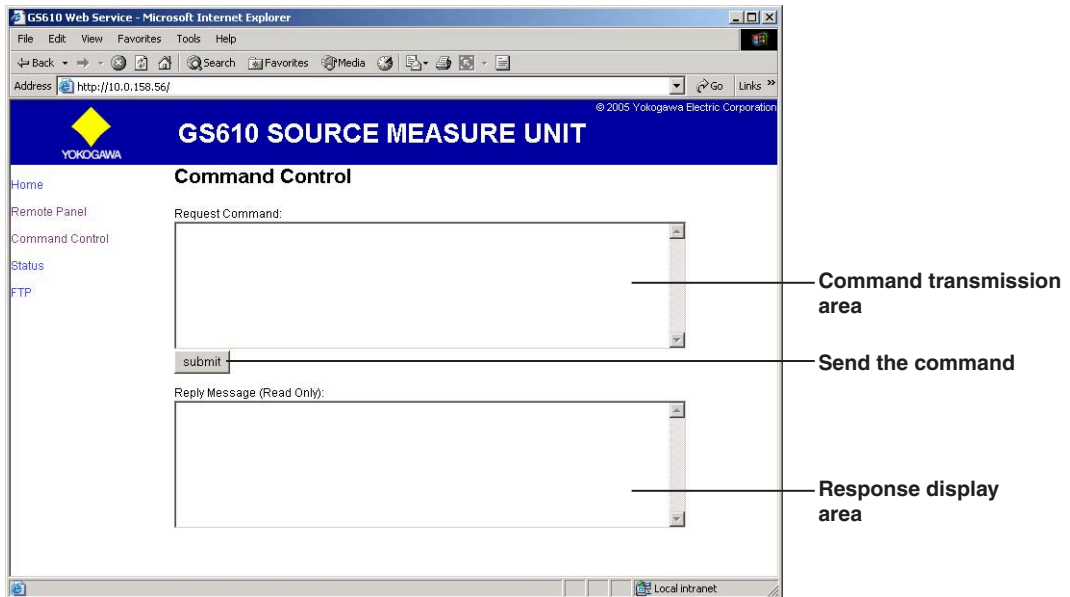

You can send communication commands from the command control window that is displayed in the remote panel to set or query the GS610. Enter the communication command in the command transmission area, and click submit. The response to the transmitted communication command is displayed in the response display area. The returned message is read-only.

Displaying the Communication Environment

Click the word "Status" in the Web server window to display the communication environment pop-up window.



The communication environment of the GS610 is displayed. Press Refresh to update the displayed information.

FTP Server Function

Click the word “FTP” in the Web server window to display the FTP server.

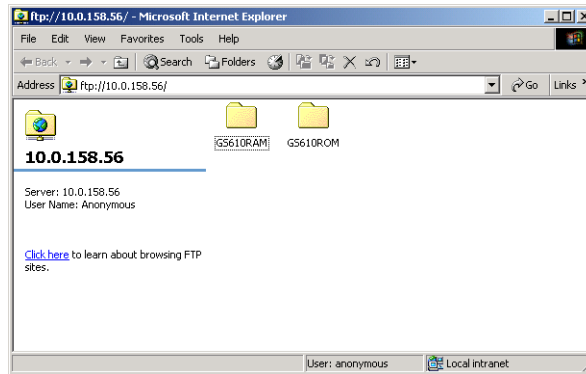

The GS610RAM folder and GS610ROM folder are linked to the volatile memory (GS610RAM) and non-volatile memory (GS610ROM) on the GS610. The files in the GS610 memory can be viewed, duplicated, deleted, or transferred to the PC from the remote panel. For details on the volatile memory (GS610RAM) and non-volatile memory (GS610ROM), see section 2.9, “USB Storage Function.”

13.1 About the IEEE.488.2-1992 Standard

The GP-IB interface of the instrument conforms to the IEEE 488.2-1992 Standard. This standard specifies that the following 23 points be stated in the document. This section describes these points.

(1) Of the IEEE 488.1 interface functions, the subsets that are supported

See "GP-IB Interface Specifications" on page 13-3.

(2) The operation of the device when it is assigned an address outside the 0 to 30 range

The GS610 does not allow assignment to an address other than 0 to 30.

(3) Reaction of the device when the user changes the address

The address change is detected when the address is set on the GP-IB Address menu (see section 13.4). The new address is valid until the next time it is changed.

(4) Device settings at power-up. The commands that can be used at power-up.

The settings selected in section 11.3, "Selecting the Settings Applied at Power ON." If you issue the RST common command, the GS610 always returns to the factory default settings.

(5) Message exchange options

(a) Input buffer size

64 KB.

(b) Queries that return multiple response messages

See the example of the commands given in section 16.2.

(c) Queries that create response data when the command syntax is being analyzed

Every query generates a response data when analysis of the syntax is completed.

(d) Queries that create response data during reception

No query generates response data when the query is received by the controller.

(e) Commands that have parameters that restrict one another

See the example of the commands given in section 16.2.

(6) Items that are included in the functional or composite header elements constituting a command

See sections 16.1 and 16.2.

(7) Buffer sizes that affect block data transmission

The receive buffer size of block data is 64 KB.

(8) A list of program data elements that can be used in equations and their nesting limitations

No equations can be used.

(9) Syntax of the responses to queries

See the example of the commands given in section 16.2.

(10) Communication between devices that do not follow the response syntax

Not supported.

(11) Size of the response data block

There are no commands that return block data.

(12) A list of supported common commands

See section 16.2.13, "Common Commands."

(13) Device condition after a successful calibration

The settings return to the conditions that existed before the calibration, measurements are terminated, and previous measured data are invalidated.

(14) The maximum length of block data that can be used for the *DDT trigger macro definition

Not supported.

(15) The maximum length of the macro label for defining macros, the maximum length of block data that can be used for the macro definition, and the process when recursion is used in macro definitions

Macro functions are not supported.

(16) Reply to the IDN? query

See section 16.2.13, "Common Commands."

(17) Size of storage area for protected user data for PUD and *PUD?

*PUD and *PUD? are not supported.

13.1 About the IEEE.488.2-1992 Standard

(18) The length of the *RDT and *RDT? resource names

*RDT and *RDT? are not supported.

(19) The change in the status due to *RST, *LRN?, *RCL, and *SAV

*RST, *RCL, and *SAV

See section 16.2.13, "Common Commands."

*LRN?

This common command is not supported.

(20) The extent of the self-test using the *TST? command

Nothing is executed and 1 is always returned.

(21) The structure of the extended return status

See section 16.3.

(22) Whether each command is processed in an overlap fashion or sequentially

All commands are sequential commands.

(23) The description of the execution of each command

See the functional and procedural explanations in chapters 1 to 15 and 17.

13.2 GP-IB Interface Functions and Specifications

GP-IB Interface Functions

Listener Capability

- All of the information that you can set with the panel keys can be set through the GP-IB interface except for turning ON/OFF the power and setting the communication parameters.
- Receives commands from a controller requesting the output of setup data, measured data, and other information.
- Also receives status report commands.

Talker Capability

Outputs setup data, measured data, and other information.

Note

Talk-only, listen-only, and controller functions are not available on this instrument.

Switching between Remote and Local Modes

When Switching from Local to Remote Mode

Receiving a REN (Remote Enable) message from the controller when the instrument is in the local mode causes the instrument to switch to the remote mode.

- The REMOTE indicator (see section 1.2) is turned ON.
- All keys other than the LOCAL key are locked.
- Settings entered in local mode are retained even when the GS610 switches to remote mode.

When Switching from Remote to Local Mode

Pressing LOCAL in remote mode puts the instrument in local mode.

- The REMOTE indicator turns OFF.
- Key operations are enabled.
- Settings entered in remote mode are retained even when the GS610 switches to local mode.

GP-IB Interface Specifications

• Electrical and mechanical specifications

Conforms to IEEE St'd 488-1978

• Functional specifications

See the table below

• Code used

ISO (ASCII) code

• Mode

Addressable mode

• Address setting

Set the address between 0 and 30 in the GP-IB address setting (see section 13.4) in the GP-IB Address menu.

• Clear remote mode

Clear remote mode by pressing LOCAL. However, key operations are void when Local Lockout is enabled by the controller.

Function	Subset Name	Description
Source handshaking	SH1	Full source handshaking capability
Acceptor handshaking	AH1	Full acceptor handshaking capability
Talker	T6	Basic talker capability, serial polling, untalk on MLA (My Listen Address), and no talk-only capability
Listener	L4	Basic listener capability, unlisten on MTA (My Talk Address), and no listen-only capability.
Service request	SR1	Full service request capability
Remote local	RL1	Full remote/local capability
Parallel polling	PP0	No parallel polling capability
Device clear	DC1	Full device clear capability
Device trigger	DT1	Full device trigger capability
Controller	C0	No controller capability
Electrical characteristics E1		Open collector

13.3 Connecting the GP-IB Cable

GP-IB cable

The GP-IB connector used on this instrument is a 24-pin connector that conforms to the IEEE St'd 488-1978. Use a GP-IB cable that conforms to this standard.

Connection Procedure

Connect the cable as shown below.

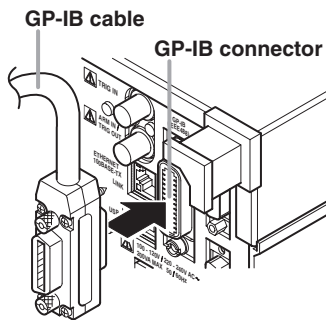

Precautions to Be Taken When Making Connections

- Firmly tighten the screws on the GP-IB cable connector.
- Multiple devices can be connected to a single GP-IB system. However, no more than 15 devices (including the controller) can be connected to a single system.
- When connecting multiple devices, each device must have its own unique address.
- Use a cable of length 2 m or less for connecting the devices.
- Make sure the total cable length does not exceed 20 m.
- When communicating, have at least two-thirds of the devices turned ON.
- When connecting multiple devices, connect them in a star or linear configuration (see the figure below). Loop and parallel configurations are not allowed.

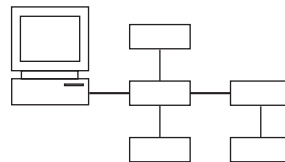
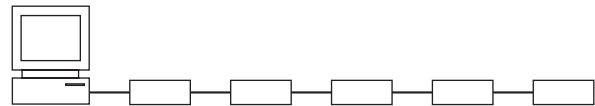

13.4 Setting the GP-IB Address

Procedure

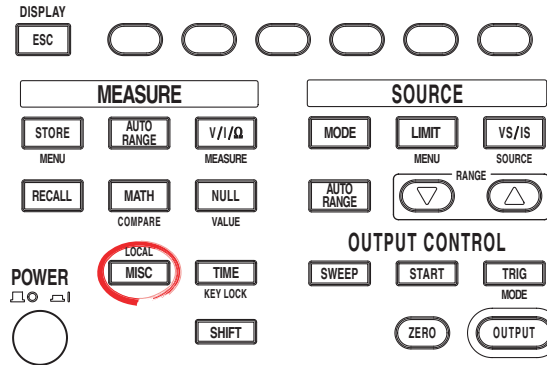

- To exit the menu during operation, press **ESC** at the upper left of the operation panel.
- In the procedural explanation below, the phrase “**rotary knob, numeric keys, <, and >**” are used to refer to the operation of selecting or setting items or entering values using the **rotary knob, numeric keys, <**, and **>** keys (BS key and right arrow key). For details on the operation using the rotary knob, numeric keys, **<**, and **>**, see sections 3.8 or 3.9.

1. Press **MISC** to display the MISC menu.
2. Press the **Remote I/F** soft key to display the communication menu.

Remote I/F	Setup	Error Log	Wire 4W 2W	CSV Setting	System
------------	-------	-----------	------------	-------------	--------

Setting the GP-IB Address

3. Press the **GP-IB** soft key.

GP-IB 30	RS232	LAN	USB Storage		
----------	-------	-----	-------------	--	--

4. Use the **rotary knob** or **numeric keys and < and > keys** to set the GP-IB address.

GP-IB Address	30
	Enter

5. If you use the numeric keys, press the **Enter** soft key to confirm the setting.

Explanation

GP-IB Address

Each device that can be connected via GP-IB has a unique address within the GP-IB system. This address is used to distinguish the device from others. If you are connecting the GS610 to a controller such as a PC, select the GP-IB address of the GS610 on the PC side.

Selectable range: 0 to 30

13.5 Responses to Interface Messages

What Is an Interface Message

Interface messages are also referred to as interface commands or bus commands. They are commands that are issued by the controller. They are classified as follows:

Uni-Line Messages

A single control line is used to transmit uni-line messages. The following three types are available. IFC (Interface Clear), REN (Remote Enable), and IDY (Identify)

Multi-Line Messages

Eight data lines are used to transmit multi-line messages. The messages are classified as follows:

- **Address commands**
These commands are valid when the instrument is designated as a listener or as a talker. The following five types are available.
 - Commands that are valid on an instrument that is designated as a listener
GTL (Go To Local), SDC (Selected Device Clear), PPC (Parallel Poll Configure), and GET (Group Execute Trigger)
 - Commands that are valid on an instrument that is designated as a talker
TCT (Take Control)
- **Universal commands**
These commands are valid on all instruments regardless of the listener and talker designations. The following five types are available.
LLO (Local Lockout), DCL (Device Clear), PPU (Parallel Poll Unconfigure), SPE (Serial Poll Enable), and SPD (Serial Poll Disable)

Other Interface Messages

Listener address, talker address, and secondary commands are also considered interface messages.

The Differences between SDC and DCL

In multi-line messages, SDC messages are those that require talker or listener designation and DCL messages are those that do not require the designation. Therefore, SDC messages are directed at a particular instrument while DCL messages are directed at all instruments on the bus.

Responses to Interface Messages

Responses to a Uni-Line Message

- **IFC**
Clears the talker and listener functions. Stops output if data are being output.
- **REN**
Switches between the remote and local modes.
- **IDY**
Not supported.

Responses to a Multi-Line Message (Address Command)

- **GTL**
Switches to the local mode.
- **SDC**
 - Clears the program message (command) being received and the output queue (see section 16.3.5).
 - The COMMunicate:WAIT command is immediately terminated.
- **GET**
Same operation as the *TRG command.
- **PPC and TCT**
Not supported.

Responses to a Multi-Line Message (Universal Command)

- **LLO**
Disables LOCAL on the front panel to prohibit switching to the local mode.
- **DCL**
Same operation as the SDC message.
- **SPE**
Sets the talker function on all devices on the bus to serial polling mode. The controller polls the devices in order.
- **SPD**
Clears the serial polling mode of the talker function on all devices on the bus.
- **PPU**
Not supported.

14.1 RS-232 Interface Functions and Specifications

Reception Function

You can specify the same settings as those specified by front panel key operations.

Receives output requests for measured and computed data, setup data of the panel, and error codes.

Transmission Function

Outputs measured and computed data.

Outputs panel setup data and the status byte.

Outputs error codes that have occurred.

RS-232 Interface Specifications

Electrical characteristics:

Conforms to EIA-574 (9-pin EIA-232 (RS-232))

Connection:

Point-to-point

Transmission mode:

Full-duplex

Synchronization:

Start-stop synchronization

Baud rate:

9600, 14400, 19200, 38400, 57600, and 115200

Start bit:

Fixed to 1 bit

Data length:

7 or 8 bits

Parity:

Even, odd, or no parity

Stop bit:

1 or 2 bits

Connector:

DELC-J9PAF-13L6 (JAE or equivalent)

Hardware handshaking:

CTS and RTS signals can be used to control both transmission and reception.

Software handshaking:

X-ON and X-OFF signals can be used to control both transmission and reception.

X-ON (ASCII 11H) and X-OFF (ASCII 13H)

Received buffer length:

64 KB

Switching between Remote and Local Modes

• When Switching from Local to Remote Mode

If the GS610 receives a “:SYSTem:REMOte” command from the PC when it is in the local mode, it switches to the remote mode.

- The REMOTE indicator to the left of the display illuminates.
- All keys except the **LOCAL** key are disabled.
- Settings entered in local mode are retained even when the GS610 switches to remote mode.

• When Switching from Remote to Local Mode

Pressing **LOCAL** in remote mode puts the instrument in local mode. The GS610 switches to local mode when it receives a :SYSTem:LOCAl command from the PC.

- The REMOTE indicator to the left of the display turns OFF.
- Key operations are enabled.
- Settings entered in remote mode are retained even when the GS610 switches to local mode.

14.2 Serial (RS-232) Interface Connection

When you connect the GS610 to a PC, you must set the GS610 so that the handshaking method, baud rate, data format, and other parameters match those on the PC.

For details on the settings, see the following pages. In addition, use an interface cable that meets the specifications of the GS610.

Connector and Signal Names

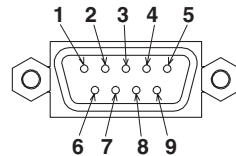

- 2 RD (Received Data): Received data from the PC.
Signal direction: Input
- 3 SD (Send Data): Transmitted data to the PC.
Signal direction: Output
- 5 SG (Signal Ground): Signal ground.
- 7 RS (Request to Send): Handshaking used to receive data from the PC.
Signal direction: Output
- 8 CS (Clear to Send): Handshaking used to send data to the PC.
Signal direction: Input

* Pins 1, 4, 6, and 9 are not used.

9-Pin to 25-Pin Adapter and Signal Names

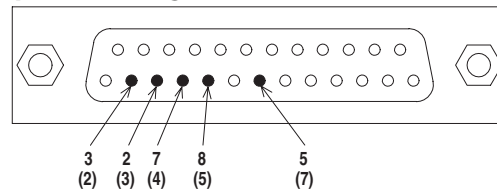

The numbers inside the parentheses are pin numbers for the 25-pin connector.

RS-232 Standard Signals and Their JIS and CCITT Abbreviations

Signal Table

Pin # (9-pin connector)	Symbol			Name
	RS-232	CCITT	JIS	
5	AB (GND)	102	SG	Signal ground
3	BA (TXD)	103	SD	Transmitted data
2	BB (RXD)	104	RD	Received data
7	CA (RTS)	105	RS	Request to send
8	CB (CTS)	106	CS	Clear to send

Signal Wiring Example

The pin numbers are for the 9-pin connector.
 In general, use a cross cable.

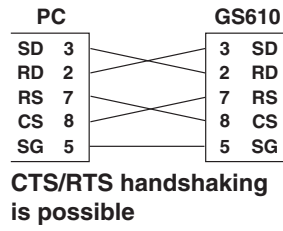
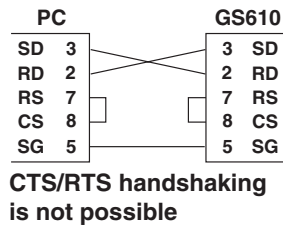

14.3 Handshaking Method

When using the serial (RS-232) interface for transferring data, it is necessary to synchronize the equipment so that data is not transmitted in excess of the receive buffer on the receiving end (overrun). This procedure is called handshaking. The GS610 can use any of the three methods below. Match the setting with your PC.

No Handshaking

If the entire command sequence fits in the receive buffer (64 K on the GS610) or when a query command is included in the middle of the command sequence, overrun does not occur.

Select this method when transmitting data in this fashion.

Hardware Handshaking (CTS/RTS)

This handshaking method stops the transmission by setting CTS to false before the receive buffer becomes full and resumes the transmission by setting CTS to true when there is enough free space in the receive buffer.

Software Handshaking (XON-XOFF)

This handshaking method stops the transmission by sending an XOFF code (0X13) before the receive buffer becomes full and resumes transmission by sending an XON code (0X11) when there is enough free space in the receive buffer.

Handshaking is possible by wiring only the data line, but binary data that includes XON (0X11) or XOFF (0X13) cannot be transmitted.

14.4 Combination of Data Formats

The RS-232 interface on the GS610 performs communications using start-stop synchronization. In start-stop synchronization, characters are transmitted one at a time. Each character consists of a start bit, data bits, a parity bit, and a stop bit (see the following figure).

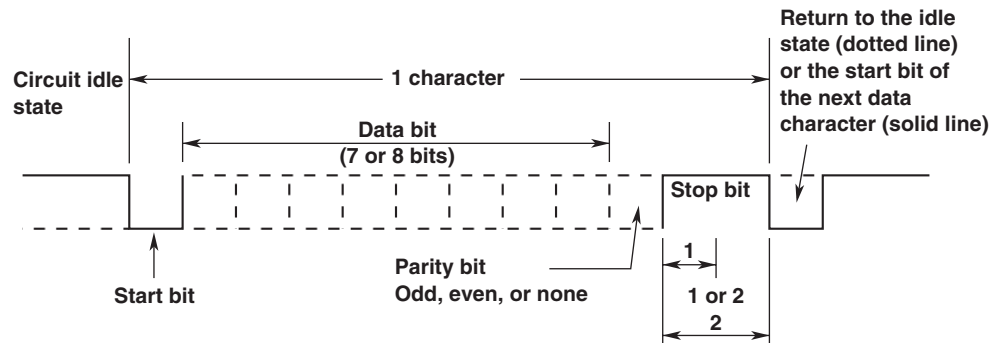

Handling of Break Signals

When a break signal is transmitted from a PC, the GS610 behaves in the same fashion as when a GP-IB device clear is received.

14.5 Setting the RS-232 Interface

Procedure

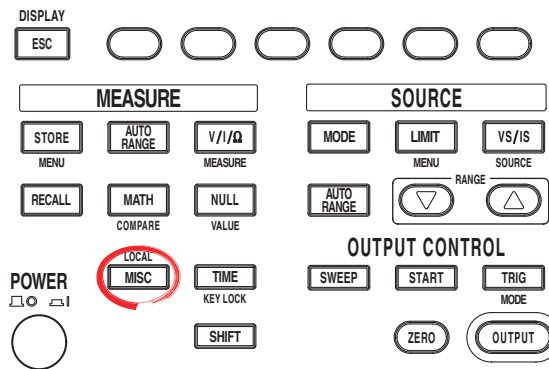

- To exit the menu during operation, press **ESC** at the upper left of the operation panel.
- In the procedural explanation below, the phrase “**rotary knob, numeric keys, <, and >**” are used to refer to the operation of selecting or setting items or entering values using the **rotary knob, numeric keys, <**, and **>** keys (BS key and right arrow key). For details on the operation using the rotary knob, numeric keys, **<**, and **>**, see sections 3.8 or 3.9.

1. Press **MISC** to display the MISC menu.
2. Press the **Remote I/F** soft key to display the Remote I/F menu.

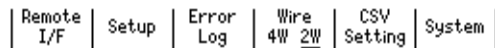

3. Press the **RS232** soft key to display the RS-232 communication menu.

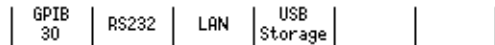

Selecting the Baud Rate

4. Press the **BaudRate** soft key to display the baud rate menu.

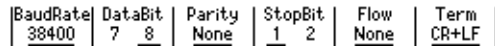

5. Press the soft key corresponding to the desired baud rate.

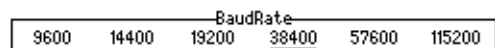

Selecting the Data Length

4. Press the **DataBit** soft key to select the data length.

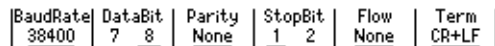

Selecting the Parity

4. Press the **Parity** soft key to display the parity menu.

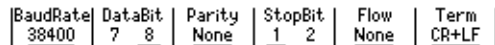

5. Press the soft key corresponding to the desired parity.

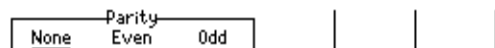

Selecting the Stop Bit

4. Press the **StopBit** soft key to select the stop bit.

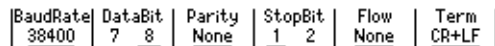

Selecting the Handshaking Method

- Press the **Flow** soft key to display the handshaking method menu.

BaudRate	DataBit	Parity	StopBit	Flow	Term
38400	7 8	None	1 2	None	CR+LF

- Press the soft key corresponding to the desired handshaking method.

		Flow Control		
		None	XON	CTS/RTS

Selecting the Transmission Terminator

- Press the **Term** soft key.

BaudRate	DataBit	Parity	StopBit	Flow	Term
38400	7 8	None	1 2	None	CR+LF

- Press the soft key corresponding to the desired terminator.

		Terminator		
		CR	LF	CR+LF

Explanation

Carry out the following settings when using a controller to set information that can be specified through key operation on the GS610 or when outputting setting data or output waveform data to the controller.

Selecting the Baud Rate

Select the baud rate from the following:

9600, 14400, 19200, 38400, 57600, or 115200

Selecting the Data Length

Select the data length from below.

8 bits or 7 bits

Selecting the Parity

Select the parity from the following:

None (no parity), Even, or Odd

Selecting the Stop Bit

Select the stop bit from the following:

1 bit or 2 bits

Selecting the Handshaking Method

Select the transmit data control and receive data control from the following:

None, XON, or CTS-RTS

Selecting the Terminator

On the GS610 menu, select the terminator that is used when transmitting data from the GS610 from the following:

CR, LF, or CR+LF

The GS610 handles CR, LF, and CR+LF as a terminator when receiving data.

15.1 USB Interface Functions and Specifications

USB Interface Functions

USB Storage Function

The two disks, GS610ROM and GS610RAM, can be accessed as external removable disks on your PC (see section 2.9, “USB Storage Function”).

Command Control Function by Way of USB-TMC

The GS610 can be controlled using commands from a VISA (Virtual Instrument Software Architecture) library. A VISA library must be installed in your PC in advance to perform command control by way of USB-TMC.

USB Interface Specifications

Electrical and mechanical specifications: Conforms to USB Rev. 2.0

Connector: Type B connector (receptacle)

Number of ports: 1

Power supply: Self-powered

Connecting to the Network

Connection Cable

Use a USB cable for the type B connector (receptacle). For the connection procedure, see section 2.9, “USB Storage Function.”

15.2 Selecting the USB Interface Function

Procedure

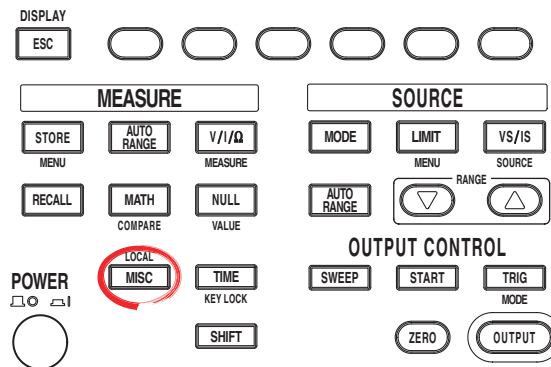

- To exit the menu during operation, press **ESC** at the upper left of the operation panel.
- In the procedural explanation below, the phrase “**rotary knob, numeric keys, <, and >**” are used to refer to the operation of selecting or setting items or entering values using the **rotary knob, numeric keys, <**, and **>** keys (BS key and right arrow key). For details on the operation using the rotary knob, numeric keys, **<**, and **>**, see sections 3.8 or 3.9.

1. Press **MISC** to display the MISC menu.
2. Press the **Remote I/F** soft key to display the Remote I/F menu.

Remote I/F	Setup	Error Log	Wire 4W 2W	CSV Setting	System
------------	-------	-----------	------------	-------------	--------

Selecting the USB Interface Function

3. Press the **USB** soft key to display the USB menu.

GPIB 1	RS232	LAN	USB Storage		
--------	-------	-----	-------------	--	--

4. Press the soft key corresponding to the desired USB interface function.

			USB Mode Storage	USB-TMC	
--	--	--	------------------	---------	--

Explanation

Selecting the USB Interface Function

Storage

Select this to use the USB storage function (see section 2.9, “USB Storage Function”).

USB-TMC

Select this to perform command control from a VISA library.

VISA resource name

VISA resource name contains the character string that is passed to open a device (viOpen()) using a VISA library.

USB::0xB21::0x1E::No. (Instrument Number)*1C::INSTR

*1 The No. (Instrument Number) is given on the name plate on the side panel of the instrument (see page ii).

16.1 Program Format

16.1.1 Symbols Used in the Syntax

Symbols which are used in the syntax descriptions in section 16.2 are shown below. For details on the data, see page 16-5.

Symbol	Meaning	Example
	Exclusive OR	SOURce:FUNctIon VOLTage CURRent Example of Input SOURce:FUNCTION VOLTage
[]	Can be omitted	OUTPut[:STATe]
...	Can be repeated	

16.1.2 Messages

Messages

Messages are used to exchange information between the controller and the instrument. Messages that are sent from the controller to the instrument are called program messages and messages that are sent back from the instrument to the controller are called response messages.

If a program message contains a message unit that requests a response (a query), the instrument returns a response message upon receiving the program message. A single response message is always returned in response to a single program message.

Program Messages

Data that is sent from the controller to the instrument are called program messages. The program message format is shown below.

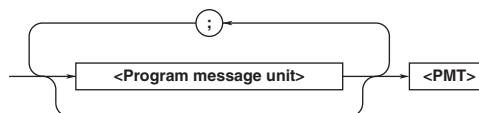

<Program Message Unit>

A program message consists of one or more program message units; each unit corresponds to one command. The instrument executes the received commands in order.

Each program message unit is separated by a semicolon (;).

For details regarding the format of the program message unit, see the next section.

Example:

```
:MEASURE:FUNCTION DTC;SPEED 1.0<PMT>
```

Unit
Unit

16.1 Program Format

<PMT>

<PMT> is a program message terminator. The following three types are available.

- **NL (New Line)**
Same as LF (Line Feed). ASCII code "0AH"
- **^END**
The END message (EOI signal) as defined in the IEEE488.1. (The data byte that is sent with the END message is the last data of the program message.)
- **NL^END**
NL with an END message attached. (NL is not included in the program message.)

Program Message Unit Format

The program message unit format is shown below.

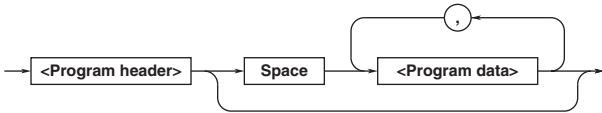

<Program Header>

The program header indicates the command type. For details, see page 16-3.

<Program Data>

If certain conditions are required in executing a command, program data is added. A space (ASCII code "20H") separates the program data from the header. If there are multiple sets of program data, they are separated by commas (,).

For details, see page 16-5.

Example:

```
:SAMPLE:GATE:MODE TIME<PMT>
```

Header Data

Response Messages

Data that is sent from the instrument to the controller are called response messages. The response message format is shown below.

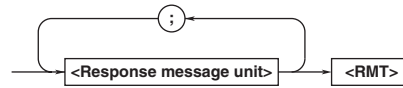

<Response Message Unit>

A response message consists of one or more response message units; each response message unit corresponds to one response.

Response message units are separated by a semicolon (;).

For details regarding the format of the response message unit, see the next section.

Example:

```
:SAMPLE:INHIBIT:STATE 1;POLARITY POSITIVE<RMT>
```

Unit Unit

<RMT>

<RMT> is a response message terminator. It is NL^END.

Response Message Unit Format

The response message unit format is shown below.

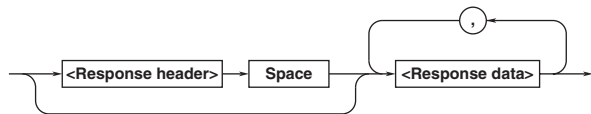

<Response Header>

A response header sometimes precedes the response data. A space separates the data from the header.

For details, see page 16-5.

<Response Data>

Response data contains the content of the response.

If there are multiple sets of response data, they are separated by commas (,).

Example:

```
500.0E-03<RMT> :SAMPLE:GATE:MODE TIME<RMT>
```

Data Header Data

If there are multiple queries in a program message, responses are made in the same order as the queries. In most cases, a single query returns a single response message unit, but there are a few queries that return multiple units. The first response message unit always corresponds to the first query, but the nth response unit may not necessarily correspond to the nth query. Therefore, if you want to make sure that every response is retrieved, divide the program messages into individual messages.

Precautions to Be Taken when Transferring Messages

- If a program message that does not contain a query is sent, the next program message can be sent at any time.
- If a program message that contains a query is sent, a response message must be received before the next program message can be sent. If the next program message is sent before the response message is received in its entirety, an error occurs. The response message that was not received is discarded.
- If the controller tries to receive a response message when there is none, an error occurs. If the controller tries to receive a response message before the transmission of the program message is complete, an error occurs.
- If a program message containing multiple message units is sent, and the message contains incomplete units, the instrument attempts to execute the ones that are believed to be complete. However, these attempts may not always be successful. In addition, if the message contains queries, the responses may not be returned.

Deadlock

The instrument can store in its buffer program and response messages of length 64 KB or more (The number of available bytes varies depending on the operating conditions). When both the transmit and receive buffers become full at the same time, the instrument can no longer continue to operate. This state is called a deadlock. In this case, operation can be resumed by discarding the program message. Deadlock will not occur if the program message (including the <PMT>) is kept below 64 KB. Furthermore, deadlock never occurs if a program message does not contain a query.

16.1.3 Commands

Commands

There are three types of commands (program headers) that are sent from the controller to the instrument. They differ in their program header formats.

Common Command Header

Commands that are defined in the IEEE 488.2-1987 are called common commands. The header format of a common command is shown below. An asterisk (*) is always placed in the beginning of a command.

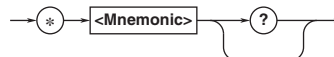

An example of a common command: *CLS

Compound Header

Dedicated commands used by the instrument are classified and arranged in a hierarchy according to their functions. The format of a compound header is shown below. A colon (:) must be used to specify a lower hierarchy.

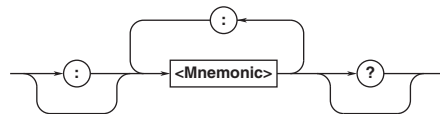

An example of a compound header:
MEASURE:FUNCTION

Simple Header

These commands are functionally independent and do not have a hierarchy. The format of a simple header is shown below.

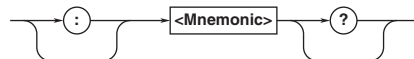

An example of a simple header: START

Note

A <mnemonic> is a character string made up of alphanumeric characters.

When Concatenating Commands

Command Group

A command group is a group of commands that have common compound headers arranged in a hierarchy. A command group may contain sub-groups.

Example: Group of commands related to sampling

```
SAMPLE?  
SAMPLE:ARMING  
SAMPLE:ARMING:DELAY:TIME  
SAMPLE:ARMING:SLOPE  
SAMPLE:ARMING:SOURCE  
SAMPLE:GATE?  
SAMPLE:GATE:TIME  
SAMPLE:INHIBIT?  
SAMPLE:INHIBIT:POLARITY  
SAMPLE:INHIBIT:STATE
```

When Concatenating Commands of the Same Group

The instrument stores the hierarchical level of the command that is currently being executed, and performs analysis on the assumption that the next command sent will also belong to the same level. Therefore, common header sections can be omitted for commands belonging to the same group.

Example:

```
INPUT:DATA:TRIG:MODE MAN;  
LEVEL 1.000V<PMT>
```

When Concatenating Commands of Different Groups

If the following command does not belong to the same group, a colon (:) is placed in front of the header.

Example:

```
MEASURE:FUNCTION DTOC;:DISPLAY:  
SCALE R10<PMT>
```

When Concatenating Simple Headers

If a simple header follows another command, a colon (:) is placed in front of the simple header.

Example:

```
MEASURE:FUNCTION DTOC;:START<PMT>
```

When Concatenating Common Commands

Common commands that are defined in the IEEE 488.2-1992 are independent of hierarchy. Colons (:) are not needed before a common command.

Example:

```
MEASURE:FUNCTION DTOC;*CLS<PMT>
```

When Separating Commands with <PMT>

If a terminator is used to separate two commands, each command is a separate message. Therefore, the common header must be specified for each command even when commands belonging to the same command group are being concatenated.

Example:

```
MEASURE:FUNCTION DTOC<PMT>MEASURE:  
SPEED 1.0<PMT>
```

Header Interpretation Rules

The instrument interprets the header that is received according to the rules below.

- Mnemonics are not case sensitive.

Example:

MEASure can be also written as measureOR Measure.

- The lower-case section of the mnemonic can be omitted.

Example:

MEASure can be also written as measureOR meas.

- The question mark (?) at the end of a header indicates that it is a query. The question mark (?) cannot be omitted.

Example:

The shortest abbreviation for "MEASure?" is "MEAS?."

- If the <x> (value) at the end of a mnemonic is omitted, it is interpreted as a 1.

Example:

If "FILTer<x>" is written as "FILT," it means "FILTer1"

- The section enclosed by braces ([]) can be omitted.

Example:

```
INPut:PLL[ :MODE ] 1
```

can be written as INPut:PLL 1

However, the last section enclosed by braces ([]) cannot be omitted in an upper-level query.

16.1.4 Responses

When the controller sends a message unit that has a question mark (?) in its program header (query), the instrument returns a response message to the query.

16.1.5 Data

Data

A data section comes after the header. A space must be included between the header and the data. The data contains conditions and values. Data is classified as below.

Notation	Meaning Example
<Integer>	- 125 -1
<Fixed-point number>	- 125.0 -.90
<Floating-point number>*	- 125.0E+0 -9E-1
<Numeric value>	<Integer>, <Fixed-point number>, or <Floating-point number>
<Voltage>	A <Numeric value> to which a voltage unit (V) can be attached. -1.25 mV
<Current>	A <Numeric value> to which a current unit (V) can be attached. -75.1E-2A
<Time>	A <Numeric value> to which a time unit (S) can be attached. 360S
<Binary/Octal/Hexadecimal Number>	A binary number following #B, an octal number following #Q, or an hexadecimal number following #H. #B1101 #Q706 #H9F3C
<String>	A character string enclosed in double quotations (") or single quotations (') "Hello"

* In <Floating-point number>, the + sign after E can be omitted.

<Multiplier>

The table below lists the <multipliers> that can be added after a <value>.

Symbol	Word	Multiplier
EX	Exa	10^{18}
PE	Peta	10^{15}
T	Tera	10^{12}
G	Giga	10^9
MA	Mega	10^6
K	Kilo	10^3
M	Milli	10^{-3}
U	Micro	10^{-6}
N	Nano	10^{-9}
P	Pico	10^{-12}
F	Femto	10^{-15}
A	Ato	10^{-18}

16.2 Commands

16.2.1 A List of Commands

Command	Function	Page
Output Commands (OUTPUT Group)		
:OUTPut		
[:STATe] 1 0 ON OFF ZERO	Sets the output state (ON, OFF, or ZERO).	16-14
[:STATe]?	Queries the output state (ON, OFF, or ZERO).	16-14
:PROGram 1 0 ON OFF PULSe	Sets the programmable output state (ON or OFF) and executes pulse generation.	16-14
:PROGram?	Queries the programmable output state (ON or OFF).	16-14
Source Commands (SOURCE Group)		
:SOURce		
:FUNCTion VOLTage CURRent	Sets the source function (voltage or current).	16-15
:FUNCTion?	Queries the source function (voltage or current).	16-15
:SHAPE DC PULSe	Sets the source mode (DC or pulse).	16-15
:SHAPE?	Queries the source mode (DC or pulse).	16-15
:MODE FIXed SWEEp LIST	Sets the source pattern (fixed level, sweep, or program sweep).	16-15
:MODE?	Queries the source pattern (fixed level, sweep, or program sweep).	16-15
:DELay <Time> MINimum MAXimum	Sets the source delay.	16-15
:DELay? [MINimum MAXimum]	Queries the source delay.	16-15
:PULSe		
:WIDTh <Time> MINimum MAXimum	Sets the pulse width when generating pulse signals.	16-15
:WIDTh? [MINimum MAXimum]	Queries the pulse width when generating pulse signals.	16-15
:LIST		
:SElect <String>	Sets the program sweep pattern file.	16-16
:SElect?	Queries the program sweep pattern file	16-16
:CATalog?	Queries the list of program sweep pattern files.	16-16
:DELete <String>	Deletes the program sweep pattern file.	16-16
:DEFine <String>, <String>	Creates a program sweep pattern file.	16-16
:VOLTage		
:RANGe <Voltage> MINimum MAXimum UP DOWN	Sets the voltage source range setting (200 mV, 2 V, 12 V, 20 V, 30 V, 60 V, or 110 V).	16-16
:RANGe? [MINimum MAXimum]	Queries the voltage source range setting (200 mV, 2 V, 12 V, 20 V, 30 V, 60 V, or 110 V).	16-16
:AUTO <Boolean>	Sets the source auto range (ON or OFF).	16-16
:AUTO?	Queries the source auto range (ON or OFF).	16-16
:LEVel <Voltage> MINimum MAXimum	Sets the voltage source level value.	16-17
:LEVel? [MINimum MAXimum]	Queries the voltage source level value.	16-17
:PBASe <Voltage> MINimum MAXimum	Sets the pulse base value for voltage pulse generation.	16-17
:PBASe? [MINimum MAXimum]	Queries the pulse base value for voltage pulse generation.	16-17
:PROtection		
[:STATe] 1 0 ON OFF	Sets the limiter state (ON or OFF).	16-17
[:STATe]?	Queries the limiter state (ON or OFF).	16-17
:LINKage 1 0 ON OFF	Sets the limiter tracking state (ON or OFF).	16-17
:LINKage?	Queries the limiter tracking state (ON or OFF).	16-17
:ULIMit <Voltage> MINimum MAXimum	Sets the upper voltage limiter value (for generating current).	16-17
:ULIMit? [MINimum MAXimum]	Queries the upper voltage limiter value (for generating current).	16-17

Command	Function	Page
:LLIMit <Voltage> MINimum MAXimum	Sets the lower voltage limiter value (for generating current).	16-18
:LLIMit? [MINimum MAXimum]	Queries the lower voltage limiter value (for generating current).	16-18
:SWEep		
:SPACing LINear LOGarithmic	Sets the sweep mode (linear or log)	16-18
:SPACing?	Queries the sweep mode (linear or log) of the voltage sweep.	16-18
:STARt <Voltage> MINimum MAXimum	Sets the start value of the voltage sweep.	16-18
:STARt? [MINimum MAXimum]	Queries the start value of the voltage sweep.	16-18
:STOP <Voltage> MINimum MAXimum	Sets the stop value of the voltage sweep.	16-18
:STOP? [MINimum MAXimum]	Queries the stop value of the voltage sweep.	16-18
:STEP <Voltage> MINimum MAXimum	Sets the step value of the voltage sweep (linear sweep).	16-19
:STEP? [MINimum MAXimum]	Queries the step value of the voltage sweep (linear sweep).	16-19
:POINTs <Integer> MINimum MAXimum	Sets the step count of the voltage sweep (log sweep).	16-19
:POINTs? [MINimum MAXimum]	Queries the step count of the voltage sweep (log sweep).	16-19
:ZERO		
:IMPedance HIGH LOW	Sets the zero source impedance (high or low) for generating voltage.	16-19
:IMPedance?	Queries the zero source impedance (high or low) for generating voltage.	16-19
:OFFset <Voltage>	Sets the zero source offset value for generating voltage.	16-19
:OFFset?	Queries the zero source offset value for generating voltage.	16-19
:CURRent		
:RANGE <Current> MINimum MAXimum UP DOWN	Sets the current source range setting (2 μ A, 200 μ A, 2 mA, 20 mA, 200 mA, 0.5 A, 1 A, 2 A, or 3 A).	16-19
:RANGE? [MINimum MAXimum]	Queries the current source range setting (2 μ A, 200 μ A, 2 mA, 20 mA, 200 mA, 0.5 A, 1 A, 2 A, or 3 A).	16-19
:AUTO 1 0 ON OFF	Sets the source auto range (ON or OFF).	16-19
:AUTO?	Queries the source auto range (ON or OFF).	16-20
:LEVel <Current> MINimum MAXimum	Sets the current source level value.	16-20
:LEVel? [MINimum MAXimum]	Queries the current source level value.	16-20
:PBASe <Current> MINimum MAXimum	Sets the pulse base value for generating current pulse.	16-20
:PBASe? [MINimum MAXimum]	Queries the pulse base value for generating current pulse.	16-20
:PROTection		
[:STATe] 1 0 ON OFF	Sets the limiter state (ON or OFF).	16-20
[:STATe]?	Queries the limiter state (ON or OFF).	16-20
:LINKage 1 0 ON OFF	Sets the limiter tracking state (ON or OFF).	16-20
:LINKage?	Queries the limiter tracking state (ON or OFF).	16-20
:ULIMit <Current> MINimum MAXimum	Sets the upper current limiter value (for generating voltage).	16-21
:ULIMit? [MINimum MAXimum]	Queries the upper current limiter value (for generating voltage).	16-21
:LLIMit <Current> MINimum MAXimum	Sets the lower current limiter value (for generating voltage).	16-21
:LLIMit? [MINimum MAXimum]	Queries the lower current limiter value (for generating voltage).	16-21
:SWEep		
:SPACing LINear LOGarithmic	Sets the sweep mode (linear or log)	16-21

16.2 Commands

Command	Function	Page
:SPACing?	Queries the sweep mode (linear or log) of the current sweep.	16-21
:START <Current> MINimum MAXimum	Sets the start value of the current sweep.	16-21
:START? [MINimum MAXimum]	Queries the start value of the current sweep.	16-21
:STOP <Current> MINimum MAXimum	Sets the stop value of the current sweep.	16-22
:STOP? [MINimum MAXimum]	Queries the stop value of the current sweep.	16-22
:STEP <Current> MINimum MAXimum	Sets the step value of the current sweep (linear sweep).	16-22
:STEP? [MINimum MAXimum]	Queries the step value of the current sweep (linear sweep).	16-22
:POINTs <Integer> MINimum MAXimum	Sets the step count of the current sweep (log sweep).	16-22
:POINTs? [MINimum MAXimum]	Queries the step count of the current sweep (log sweep).	16-22
:ZERO		
:IMPedance HIGH LOW	Sets the zero source impedance (high or low) for generating current.	16-22
:IMPedance?	Queries the zero source impedance (high or low) for generating current.	16-22
:OFFset <Current>	Sets the zero source offset value for generating current.	16-22
:OFFset?	Queries the zero source offset value for generating current.	16-22
Sweep Commands (SWEep Group)		
:SWEep		
:TRIGger	Starts the sweep operation.	16-23
:COUNT <Integer> INFINITY MINimum MAXimum	Sets the sweep repeat count.	16-23
:COUNT? [MINimum MAXimum]	Queries the sweep repeat count.	16-23
:LAST KEEP RETURN	Sets the sweep termination mode (keep level or return to initial level).	16-23
:LAST?	Queries the sweep termination mode (keep level or return to initial level).	16-23
Measurement Commands (SENSe Group)		
:SENSe		
[:STATe] 1 0 ON OFF	Sets the measurement state (ON or OFF).	16-24
[:STATe]?	Queries the measurement state (ON or OFF).	16-24
:FUNction VOLTage CURRent RESistance	Sets the measurement function (voltage, current, or resistance).	16-24
:FUNction?	Queries the measurement function (voltage, current, or resistance).	16-24
:RANge		
:AUTO 1 0 ON OFF	Sets the measurement auto range (ON or OFF).	16-24
:AUTO?	Queries the measurement auto range (ON or OFF).	16-24
:ITIME <Time> PLC MINimum MAXimum UP DOWN	Sets the integration time.	16-24
:ITIME? [PLC MINimum MAXimum]	Queries the integration time.	16-24
:DELay <Time> MINimum MAXimum	Sets the measurement delay.	16-24
:DELay? [MINimum MAXimum]	Queries the measurement delay.	16-24
:AZERo		
[:STATe] 1 0 ON OFF	Sets the auto zero state (ON or OFF).	16-25
[:STATe]?	Queries the auto zero state (ON or OFF).	16-25
:EXECute	Executes auto zero.	16-25
:AVERage		
[:STATe] 1 0 ON OFF	Sets the average state (ON or OFF).	16-25
[:STATe]?	Queries the average state (ON or OFF).	16-25
:MODE BLOCK MOVing	Sets the average mode (block or moving average).	16-25
:MODE?	Queries the average mode (block or moving average).	16-25
:COUNT <Integer> MINimum MAXimum	Sets the average count.	16-25

Command	Function	Page
:COUNT? [MINimum MAXimum]	Queries the average count.	16-25
:ACHange 1 0 ON OFF	Sets the auto V/I mode (ON or OFF).	16-25
:ACHange?	Queries the auto V/I mode (ON or OFF).	16-25
:RSENse 1 0 ON OFF	Sets the four-wire measurement (remote sense) (ON or OFF).	16-25
:RSENse?	Queries the four-wire measurement (remote sense) (ON or OFF).	16-25
Trigger Commands (TRIGger Group)		
:TRIGger		
:SOURce TIMer EXTernal IMMediate	Sets the trigger source (constant period timer, external trigger, or no trigger wait).	16-26
:SOURce?	Queries the trigger source (constant period timer, external trigger, or no trigger wait).	16-26
:TIMer <Time> MINimum MAXimum	Sets the period of the constant period timer.	16-26
:TIMer? [MINimum MAXimum]	Queries the period of the constant period timer.	16-26
Computation Commands (CALCulate Group)		
:CALCulate		
:NULL		
[:STATe] 1 0 ON OFF	Sets the NULL computation state (ON or OFF).	16-27
[:STATe]?	Queries the NULL computation state (ON or OFF).	16-27
:OFFSet <Value>	Sets the offset value of NULL computation.	16-27
:OFFSet?	Queries the offset value of NULL computation.	16-27
:MATH		
[:STATe] 1 0 ON OFF	Sets the state of the computation using equations (ON or OFF).	16-27
[:STATe]?	Queries the state of the computation using equations (ON or OFF).	16-27
:SElect <String>	Sets the definition file of the computation using equations.	16-27
:SElect?	Queries the definition file of the computation using equations.	16-27
:CATalog?	Queries a list of definition files of the computation using equations.	16-27
:DElete <String>	Deletes the definition file of the computation using equations.	16-27
:DEFine <String>,<String>	Creates a definition file of the computation using equations.	16-27
:PARAmeter		
:A <Value>	Sets equation parameter A.	16-28
:A?	Queries equation parameter A.	16-28
:B <Value>	Sets equation parameter B.	16-28
:B?	Queries equation parameter B.	16-28
:C <Value>	Sets equation parameter C.	16-28
:C?	Queries equation parameter C.	16-28
:LIMit		
[:STATe] 1 0 ON OFF	Sets the state of the comparison operation (ON or OFF).	16-28
[:STATe]?	Queries the state of the comparison operation (ON or OFF).	16-28
:UPPer <Value> MINimum MAXimum	Sets the upper limit of the comparison operation.	16-28
:UPPer? [MINimum MAXimum]	Queries the upper limit of the comparison operation.	16-28
:LOWer <Value> MINimum MAXimum	Sets the lower limit of the comparison operation.	16-28
:LOWer? [MINimum MAXimum]	Queries the lower limit of the comparison operation.	16-28
Store/Recall Commands (TRACe Group)		
:TRACe		
[:STATe] 1 0 ON OFF	Sets the storage state (ON or OFF).	16-29
[:STATe]?	Queries the storage state (ON or OFF).	16-29
:AUTO 1 0 ON OFF	Sets the auto storage state (ON or OFF).	16-29
:AUTO?	Queries the auto storage state (ON or OFF).	16-29
:POINts <Integer> MINimum MAXimum	Sets the store count.	16-29
:POINts? [MINimum MAXimum]	Queries the store count.	16-29

16.2 Commands

Command	Function	Page
:ACTual?	Queries the actual number of stored points.	16-29
:CALCulate		
:MINimum?	Queries the minimum value among the stored measured values.	16-29
:MAXimum?	Queries the maximum value among the stored measured values.	16-29
:AVERage?	Queries the average value among the stored measured values.	16-29
:SDEViation?	Queries the standard deviation of the stored measured values.	16-30
:DATA		
:NUMber <Integer> MINimum MAXimum UP DOWN	Sets the store data number.	16-30
:NUMber? [MINimum MAXimum]	Queries the store data number.	16-30
:TIME?	Queries the time stamp of the stored data.	16-30
:SOURce?	Queries the source value of the stored data.	16-30
[:SENSe]?	Queries the measured value of the stored data.	16-30
:SETup?	Queries the stored data setup mnemonic.	16-30
:MONLy 1 0 ON OFF	Sets the measurement-only state (ON or OFF).	16-30
:MONLy?	Queries the measurement-only state (ON or OFF).	16-30

External Input/Output Commands (ROUTE Group)

:ROUTE		
:BNCI		
:SElect TRIGger SWEEp CONTrol	Selects the BNC input (trigger input, sweep start input, or control input).	16-31
:SElect?	Queries the BNC input selection (trigger input, sweep start input, or control input).	16-31
:CONTrol ILOCK OUTPut ZERO	Selects the BNC control input (interlock, output control, or zero control).	16-31
:CONTrol?	Queries the BNC control input selection (interlock, output control, or zero control).	16-31
:BNC0		
:SElect TRIGger SWEEp CONTrol	Selects the BNC output (trigger output, sweep synchronization output, or control output).	16-31
:SElect?	Queries the BNC output selection (trigger output, sweep synchronization output, or control output).	16-31
:TRIGger ORIGin SCHange MBEGin MEND PEND	Sets the BNC trigger output generation timing (trigger, source change, measurement begin, measurement end, or pulse end).	16-31
:TRIGger?	Queries the BNC trigger output generation timing (trigger, source change, measurement begin, measurement end, or pulse end).	16-31
:SWEEp ORIGin TURN ALL	Sets the BNC sweep synchronization output generation timing (sweep start, 1 turn end, all sweep end).	16-31
:SWEEp?	Queries the BNC sweep synchronization output generation timing (sweep start, 1 turn end, all sweep end).	16-31
:CONTrol ILOCK OUTPut ZERO PROGram	Selects the control output (interlock, output control, zero control, or programmable).	16-32
:CONTrol?	Queries the control output selection (interlock, output control, zero control, or programmable).	16-32
:DIO5 OUTPut ZERO	Sets the function (output control or zero control) of pin 5 (control input) of the external input/output connector.	16-32
:DIO5?	Queries the function (output control or zero control) of pin 5 (control input) of the external input/output connector.	16-32
:DIO6 ORIGin SCHange MBEGin MEND PEND	Sets the function (trigger start point, source change, measurement begin, measurement end, or pulse end) of pin 6 (trigger output) of the external input/output connector.	16-32

Command	Function	Page
:DIO6?	Queries the function (trigger start point, source change, measurement begin, measurement end, or pulse end) of pin 6 (trigger output) of the external input/output connector.	16-32
:DIO7 ORIGin TURN ALL	Sets the function (sweep start point, 1 turn end, or all sweep end) of pin 7 (sweep synchronization output) of the external input/output connector.	16-32
:DIO7?	Queries the function (sweep start point, 1 turn end, or all sweep end) of pin 7 (sweep synchronization output) of the external input/output connector.	16-32
:DIO8 ILOCK OUTPut ZERO	Sets the function (interlock, output control, or zero control) of pin 8 (control output) of the external input/output connector.	16-33
:DIO8?	Queries the function (interlock, output control, or zero control) of pin 8 (control output) of the external input/output connector.	16-33
System Commands (SYSTEM Group)		
:SYSTem		
:DISPlay		
[:STATe] 1 0 ON OFF	Sets the display state (ON or OFF).	16-34
[:STATe]?	Queries the display state (ON or OFF).	16-34
:BRIGht <Integer> MINimum MAXimum	Sets the display brightness.	16-34
:BRIGht? [MINimum MAXimum]	Queries the display brightness.	16-34
:CLOCK		
:DATE <String>	Sets the date.	16-34
:DATE?	Queries the date.	16-34
:TIME <String>	Sets the time.	16-34
:TIME?	Queries the time.	16-34
:TZONE <String>	Sets the time zone.	16-34
:TZONE?	Queries the time zone.	16-34
:SETup		
:SAVE <String>	Saves the setup data.	16-34
:LOAD <String>	Loads the setup data.	16-34
:CATalog?	Queries a list of setup data files.	16-34
:DELeTe<String>	Deletes the setup data file.	16-34
:PON <String>	Sets the setup data applied at power on.	16-35
:PON?	Queries the setup data applied at power on.	16-35
:ERRor?	Queries the error code and message information.	16-35
:REMOte	Transits to remote mode.	16-35
:LOCal	Transits to local mode.	16-35
:KLOCK 1 0 ON OFF	Sets the key lock state (ON or OFF).	16-35
:KLOCK?	Queries the key lock state (ON or OFF).	16-35
:BEEPer		
[:STATe] 1 0 ON OFF	Sets the beep sound (ON or OFF).	16-35
[:STATe]?	Queries the beep sound state (ON or OFF).	16-35
:LFRequency 50 60	Sets the power frequency (50 Hz or 60 Hz).	16-35
:LFRequency?	Queries the power frequency (50 Hz or 60 Hz).	16-35
:WAIT <Time>	Holds the command parsing operation for a specified time.	16-35
:COMMunicate		
:GPIB		
:ADDResS <Integer>	Sets the GP-IB address.	16-35
:ADDResS?	Queries the GP-IB address.	16-35
:RS232		
:BAUDrate 9600 14400 19200 38400 57600 115200	Sets the RS-232 baud rate (9600 bps to 115200 bps).	16-36
:BAUDrate?	Queries the RS-232 baud rate (9600 bps to 115200 bps).	16-36
:DLEnGth 7 8	Sets the RS-232 data length (7 bits or 8 bits).	16-36
:DLEnGth?	Queries the RS-232 data length (7 bits or 8 bits).	16-36
:PARity NONE EVEN ODD	Sets the RS-232 parity (none, even, or odd).	16-36

16.2 Commands

Command	Function	Page
:PARity?	Queries the RS-232 parity (none, even, or odd).	16-36
:SBITs 1 2	Sets the RS-232 stop bit (1 bit or 2 bits).	16-36
:SBITs?	Queries the RS-232 stop bit (1 bit or 2 bits).	16-36
:PACE NONE XON HARDware	Sets the RS-232 flow control (none, XON-OFF, or CTS-RTS).	16-36
:PACE?	Queries the RS-232 flow control (none, XON-OFF, or CTS-RTS).	16-36
:TERMinator CR LF CRLF	Sets the RS-232 terminator (CR, LF, or CR+LF).	16-36
:TERMinator?	Queries the RS-232 terminator (CR, LF, or CR+LF).	16-36
:ETHER		
:MAC?	Queries the MAC address of Ethernet communication.	16-37
:PORT?	Queries the command socket port number of Ethernet communication.	16-37
:DHCP 1 0 ON OFF	Sets DHCP (ON or OFF) of Ethernet communication.	16-37
:DHCP?	Queries the DHCP state (ON or OFF) of Ethernet communication.	16-37
:IP <String>	Sets the IP address of Ethernet communication.	16-37
:IP?	Queries the IP address of Ethernet communication.	16-37
:MASK <String>	Sets the net mask of Ethernet communication.	16-37
:MASK?	Queries the net mask of Ethernet communication.	16-37
:GATE <String>	Sets the default gateway of Ethernet communication.	16-37
:GATE?	Queries the default gateway of Ethernet communication.	16-37
:TERMinator CR LF CRLF	Sets the terminator (CR, LF, or CR+LF) of Ethernet communication.	16-37
:TERMinator?	Queries the terminator (CR, LF, or CR+LF) of Ethernet communication.	16-37
Measured Value Read Commands (INITiate, FETCh, and READ Group)		
:INITiate	Starts a new measurement.	16-38
:FETCh?	Queries the measured results.	16-38
:READ?	Starts a new measurement and queries the measured results.	16-38
Status Commands (STATus Group)		
:STATus		
:SOURce		
:CONDition?	Queries the source event condition register.	16-39
:EVENT?	Queries the source event register and clears the register.	16-39
:ENABle <Integer> <Binary/Octal/Hexadecimal>	Sets the source event enable register.	16-39
:ENABle?	Queries the source event enable register.	16-39
:SENSe		
:CONDition?	Queries the measurement event condition register.	16-39
:EVENT?	Queries the measurement event register and clears the register.	16-39
:ENABle <Integer> <Binary/Octal/Hexadecimal>	Sets the measurement event enable register.	16-39
:ENABle?	Queries the measurement event enable register.	16-39
Common Commands		
*IDN?	Queries the instrument model.	16-40
*OPT?	Queries the options.	16-40
*TRG	Generates a trigger.	16-40
*CAL?	Performs calibration and queries the result.	16-40
*TST?	Performs a self-test and queries the result.	16-40
*RST	Initializes settings (resets to factory default settings).	16-40
*SAV 1 2 3 4	Saves the settings.	16-40
*RCL 1 2 3 4	Loads the saved settings.	16-40
*CLS	Clears the event register and error queue.	16-40
*STB?	Queries the status byte and clears the SRQ.	16-40
*SRE <Integer> <Binary/Octal/Hexadecimal>	Sets the service request enable register.	16-40
*SRE?	Queries the service request enable register.	16-40
*ESR?	Queries the standard event register and clears the register.	16-40

Command	Function	Page
*ESE <Integer> <Binary/Octal/Hexadecimal>	Sets the standard event enable register.	16-40
*ESE?	Queries the standard event enable register.	16-40
*OPC	Generates a standard event OPC when the execution of all previous commands is completed.	16-41
*OPC?	Creates a response after the execution of all previous commands is completed.	16-41
*WAI	Waits the completion of the overlap command.	16-41

16.2.2 Output Commands (OUTPut Group)

:OUTPut [:STATe]

Function Sets the output state (ON, OFF, or zero) or queries the current setting.

Syntax :OUTPut [:STATe] 1 | 0 | ON | OFF | ZERO
 1 or ON = Turns the output ON.
 0 or OFF = Turns the output OFF.
 ZERO = Turns the output to zero.
 :OUTPut [:STATe] ?
 → 1 = Currently ON
 0 = Currently OFF
 ZERO = Currently zero

Example :OUTP ON
 :OUTP:STAT ZERO
 :OUTP:STAT?

Description ON and OFF indicates ON and OFF of the output relay. ZERO indicates the zero state. The zero state is defined using the :SOURce:VOLTage:ZERO or :SOURce:CURREnt:ZERO command.

:OUTPut:PROGram

Function Sets the programmable output state (ON or OFF) or queries the current setting Or, carries out pulse generation.

Syntax :OUTPut:PROGram 1 | 0 | ON | OFF | PULSe
 1 or ON = Turns the output ON (Low).
 0 or OFF = Turns the output OFF (High).
 PULSe = Generates a 10- μ s pulse.
 :OUTPut:PROGram ?
 → 1 = Currently ON (Low)
 0 = Currently OFF (High)

Example :OUTP:PROG 1
 :OUTP:PROG PULS
 :OUTP:PROG?

Description The program output used here indicates pin 9 of the external input/output connector. If the BNC output is set to programmable output using the :ROUte:BOUte:SELEct CONTROl;CONTROl PROGram command, the same signal is output to the BNC output.

16.2.3 Source Commands (SOURce GRoup)

:SOURce:FUNction

Function Sets the source function (voltage or current) or queries the current setting.

Syntax :SOURce:FUNction VOLTage|CURRent
 VOLTage = Sets the source function to voltage.
 CURRent = Sets the source function to current.
 :SOURce:FUNction?
 → VOLT = Currently set to voltage.
 CURR = Currently set to current.

Example :SOUR:FUNC VOLT
 :SOUR:FUNC?

Description When the source function is changed, the output (:OUTPut:STATe) is automatically turned OFF.

:SOURce:SHAPE

Function Sets the source mode (DC or pulse) or queries the current setting.

Syntax :SOURce:SHAPE DC|PULSe
 DC = Sets the source mode to DC.
 PULSe = Sets the source mode to pulse.
 :SOURce:SHAPE?
 → DC = Currently set to DC.
 PULS = Currently set to pulse.

Example :SOUR:SHAP PULS
 :SOUR:SHAP?

Description This function corresponds to MODE on the front panel.

:SOURce:MODE

Function Sets the source pattern (fixed level, sweep, or program sweep) or queries the current setting.

Syntax :SOURce:MODE FIXed|SWEep|LIST
 FIXed = Sets the source pattern to constant level (sweep OFF).
 SWEep = Sets the source pattern to sweep (linear or log sweep).
 LIST = Sets the source pattern to program sweep.
 :SOURce:MODE?
 → FIX = Currently set to constant level (sweep OFF)
 SWE = Currently set to sweep (linear or log sweep)
 LIST = Currently set to program sweep.

Example :SOUR:MODE LIST
 :SOUR:MODE?

Description This function corresponds to SWEEP on the front panel. Specify the linear or log setting of the sweep mode using the :SOURce:VOLTage:SWEep:SPACing or :SOURce:CURRent:SWEep:SPACing command.

:SOURce:DELay

Function Sets the source delay or queries the current setting.

Syntax :SOURce:DELay <Time>|MINimum|MAXimum
 <Time> = Sets the source delay to the specified value.
 MINimum = Sets the source delay to the minimum value.
 MAXimum = Sets the source delay to the maximum value.
 :SOURce:DELay? [MINimum|MAXimum]
 No parameter = Queries the current value.
 MINimum = Queries the minimum value.
 MAXimum = Queries the maximum value.
 → <Time>

Example :SOUR:DEL 2.5E-3
 :SOUR:DEL MIN
 :SOUR:DEL?
 :SOUR:DEL? MAX

:SOURce:PULSe:WIDTh

Function Sets the pulse width for pulse generation or queries the current setting.

Syntax :SOURce:PULSe:WIDTh <Time>|MINimum|MAXimum
 <Time> = Sets the source delay to the specified value.
 MINimum = Sets the source delay to the minimum value.
 MAXimum = Sets the source delay to the maximum value.
 :SOURce:PULSe:WIDTh? [MINimum|MAXimum]
 No parameter = Queries the current value.
 MINimum = Queries the minimum value.
 MAXimum = Queries the maximum value.
 → <Time>

Example :SOUR:PULS:WIDT 0.75
 :SOUR:PULS:WIDT MIN
 :SOUR:PULS:WIDT?
 :SOUR:PULS:WIDT? MAX

16.2 Commands

:SOURCE:LIST:SElect

Function Sets the program sweep pattern file or queries the current setting.

Syntax :SOURCE:LIST:SElect <String>
<String> = File name to be specified.
:SOURCE:LIST:SElect?
→ <String> = Current file name.

Example :SOUR:LIST:SEL "Test.csv"
:SOUR:LIST:SEL?

Description Select a file in the PROGRAM directory on the GS610ROM disk. An error occurs if a file name that does not exist is specified.
The file name is not case sensitive.

:SOURCE:LIST:CATalog?

Function Queries the list of program sweep pattern files.

Syntax :SOURCE:LIST:CATalog?
→ <String>[,<String>[,<String> ...]] = A list of pattern files.
NONE indicates that there are no pattern files.

Example :SOUR:LIST:CAT?

Description Pattern files are files in the PROGRAM directory of the GS610ROM disk.

:SOURCE:LIST:DElete

Function Deletes the program sweep pattern file.

Syntax :SOURCE:LIST:DElete <String>
<String> = Name of the file to be deleted.

Example :SOUR:LIST:DEL "Test.csv"

Description Select a file in the PROGRAM directory on the GS610ROM disk. An error occurs if a file name that does not exist is specified.
The file name is not case sensitive.

:SOURCE:LIST:DEFine

Function Creates a program sweep pattern file.

Syntax :SOURCE:LIST:DEFine <String>,<String>
<String> = Name of the file to be created
<String> = Contents to be written to the file

Example :SOUR:LIST:DEF "Sample.csv",
"1.0_{REF} 2.0_{REF}"

Description The file is created in the PROGRAM directory on the GS610ROM disk. If an existing file name is specified, the file is overwritten.

:SOURCE:VOLTage:RANGE

Function Sets the voltage source range setting (200 mV, 2 V, 12 V, 20 V, 30 V, 60 V, or 110 V) or queries the current setting.

Syntax :SOURCE:VOLTage:RANGE <Voltage>|MINimum|MAXimum|UP|DOWN
<Voltage> = Sets the smallest range setting that includes the specified value.
MINimum = Sets the range setting to the minimum value.
MAXimum = Sets the range setting to the maximum value.
UP = Increases the range setting by 1.
DOWN = Decreases the range setting by 1.
:SOURCE:VOLTage:RANGE? [MINimum|MAXimum]
No parameter = Queries the current value.
MINimum = Queries the minimum value.
MAXimum = Queries the maximum value.
→ <Voltage>

Example :SOUR:VOLT:RANG 20
:SOUR:VOLT:RANG DOWN
:SOUR:VOLT:RANG?
:SOUR:VOLT:RANG? MIN

Description If the range setting is changed when auto range is ON by the SOURCE:VOLTage:RANGE:AUTO ON command, auto range is automatically disabled.

:SOURCE:VOLTage:RANGE:AUTO

Function Sets the source auto range (ON or OFF) or queries the current setting.

Syntax :SOURCE:VOLTage:RANGE:AUTO 1|0|ON|OFF
1 or ON = Turns auto range ON.
0 or OFF = Turns auto range OFF.
:SOURCE:VOLTage:RANGE:AUTO?
→ 1 = Currently ON
0 = Currently OFF

Example :SOUR:VOLT:RANG:AUTO ON
:SOUR:VOLT:RANG:AUTO?

Description This command and :SOURCE:CURRENT:RANGE:AUTO are equivalent.

:SOURCE:VOLTage:LEVel

Function Sets the voltage source level value or queries the current setting.

Syntax :SOURCE:VOLTage:LEVel <Voltage>|
MINimum|MAXimum
<Voltage> = Sets the voltage level to the specified value.
MINimum = Sets the voltage level to the minimum value.
MAXimum = Sets the voltage level to the maximum value.
:SOURCE:VOLTage:LEVel? [MINimum|
MAXimum]
No parameter = Queries the current value.
MINimum = Queries the minimum value.
MAXimum = Queries the maximum value.
→ <Voltage>

Example :SOUR:VOLT:LEV -99.999
:SOUR:VOLT:LEV MAX
:SOUR:VOLT:LEV?
:SOUR:VOLT:LEV? MAX

:SOURCE:VOLTage:PBASe

Function Sets the pulse base value for voltage pulse generation or queries the current setting.

Syntax :SOURCE:VOLTage:PBASe <Voltage>|
MINimum|MAXimum
<Voltage> = Sets the pulse base value to the specified value.
MINimum = Sets the pulse base value to the minimum value.
MAXimum = Sets the pulse base value to the maximum value.
:SOURCE:VOLTage:PBASe? [MINimum|
MAXimum]
No parameter = Queries the current value.
MINimum = Queries the minimum value.
MAXimum = Queries the maximum value.
→ <Voltage>

Example :SOUR:VOLT:PBAS -0.5
:SOUR:VOLT:PBAS MAX
:SOUR:VOLT:PBAS?
:SOUR:VOLT:PBAS? MAX

:SOURCE:VOLTage:PROTection[:STATe]

Function Sets the limiter state (ON or OFF) or queries the current setting.

Syntax :SOURCE:VOLTage:PROTection[:STATe]
1|0|ON|OFF
1 or ON = Turns the limiter ON.
0 or OFF = Turns the limiter OFF.
:SOURCE:VOLTage:PROTection[:STATe]?
→ 1 = Currently ON
0 = Currently OFF

Example :SOUR:VOLT:PROT:STAT OFF
:SOUR:VOLT:PROT:STAT?

Description This command and :SOURCE:CURRent:
PROTection[:STATe] are equivalent.

:SOURCE:VOLTage:PROTection:LINKage

Function Sets the limiter tracking state (ON or OFF) or queries the current setting.

Syntax :SOURCE:VOLTage:PROTection:LINKage
1|0|ON|OFF
1 or ON = Turns limiter tracking ON.
0 or OFF = Turns limiter tracking OFF.
:SOURCE:VOLTage:PROTection:LINKage?
→ 1 = Currently ON
0 = Currently OFF

Example :SOUR:VOLT:PROT:LINK OFF
:SOUR:VOLT:PROT:LINK?

Description This command and :SOURCE:CURRent:
PROTection:LINKage are equivalent.

:SOURCE:VOLTage:PROTection:ULIMit

Function Sets the upper voltage limiter value (for generating current) or queries the current setting.

Syntax :SOURCE:VOLTage:PROTection:ULIMit
<Voltage>|MINimum|MAXimum
<Voltage> = Sets the limiter value to the specified value.
MINimum = Sets the limiter value to the minimum value.
MAXimum = Sets the limiter value to the maximum value.
:SOURCE:VOLTage:PROTection:ULIMit?
[MINimum|MAXimum]
No parameter = Queries the current value.
MINimum = Queries the minimum value.
MAXimum = Queries the maximum value.
→ <Voltage>

Example :SOUR:VOLT:PROT:ULIM 75.0
:SOUR:VOLT:PROT:ULIM MAX
:SOUR:VOLT:PROT:ULIM?
:SOUR:VOLT:PROT:ULIM? MAX

Description Note that the voltage limiter is activated when the source function is set to current (:SOURCE:FUNCTION CURRent).

16.2 Commands

:SOURCE:VOLTage:PROTection:LLIMit

Function Sets the lower voltage limiter value (for generating current) or queries the current setting.

Syntax :SOURCE:VOLTage:PROTection:LLIMit
<Voltage>|MINimum|MAXimum
<Voltage> = Sets the limiter value to the specified value.
MINimum = Sets the limiter value to the minimum value.
MAXimum = Sets the limiter value to the maximum value.
:SOURCE:VOLTage:PROTection:LLIMit?
[MINimum|MAXimum]
No parameter = Queries the current value.
MINimum = Queries the minimum value.
MAXimum = Queries the maximum value.
→ <Voltage>

Example :SOUR:VOLT:PROT:LLIM -25.0
:SOUR:VOLT:PROT:LLIM MIN
:SOUR:VOLT:PROT:LLIM?
:SOUR:VOLT:PROT:LLIM? MIN

Description Note that the voltage limiter is activated when the source function is set to current (:SOURCE:FUNCTION CURRENT).

:SOURCE:VOLTage:SWEep:SPACing

Function Sets the sweep mode (linear or log) or queries the current setting.

Syntax :SOURCE:VOLTage:SWEep:SPACing
LINear|LOGarithmic
LINear = Sets the sweep mode to linear.
LOGarithmic = Sets the sweep mode to logarithmic.
:SOURCE:VOLTage:SWEep:SPACing?
→ LIN = Currently set to linear
LOG = Currently set to logarithmic

Example :SOUR:VOLT:SWE:SPAC LIN
:SOUR:VOLT:SWE:SPAC?

Description This setting is used when the source pattern is set to sweep (:SOURCE:MODE SWEep). This command and :SOURCE:CURRENT:SWEep:SPACing are equivalent.

:SOURCE:VOLTage:SWEep:STARt

Function Sets the start value of the voltage sweep or queries the current setting.

Syntax :SOURCE:VOLTage:SWEep:STARt
<Voltage>|MINimum|MAXimum
<Voltage> = Sets the start value to the specified value.
MINimum = Sets the start value to the minimum value.
MAXimum = Sets the start value to the maximum value.
:SOURCE:VOLTage:SWEep:STARt?
[MINimum|MAXimum]
No parameter = Queries the current value.
MINimum = Queries the minimum value.
MAXimum = Queries the maximum value.
→ <Voltage>

Example :SOUR:VOLT:SWE:STAR 0.05
:SOUR:VOLT:SWE:STAR MIN
:SOUR:VOLT:SWE:STAR?
:SOUR:VOLT:SWE:STAR? MIN

:SOURCE:VOLTage:SWEep:STOP

Function Sets the stop value of the voltage sweep or queries the current setting.

Syntax :SOURCE:VOLTage:SWEep:STOP
<Voltage>|MINimum|MAXimum
<Voltage> = Sets the stop value to the specified value.
MINimum = Sets the stop value to the minimum value.
MAXimum = Sets the stop value to the maximum value.
:SOURCE:VOLTage:SWEep:STOP?
[MINimum|MAXimum]
No parameter = Queries the current value.
MINimum = Queries the minimum value.
MAXimum = Queries the maximum value.
→ <Voltage>

Example :SOUR:VOLT:SWE:STOP 12.5
:SOUR:VOLT:SWE:STOP MAX
:SOUR:VOLT:SWE:STOP? MAX

:SOURCE:VOLTage:SWEep:STEP

Function	Sets the step value of the voltage sweep (linear sweep) or queries the current setting.
Syntax	:SOURCE:VOLTage:SWEep:STEP <Voltage> MINimum MAXimum <Voltage> = Sets the step value to the specified value. MINimum = Sets the step value to the minimum value. MAXimum = Sets the step value to the maximum value. :SOURCE:VOLTage:SWEep:STEP? [MINimum MAXimum] No parameter = Queries the current value. MINimum = Queries the minimum value. MAXimum = Queries the maximum value. → <Voltage>
Example	:SOUR:VOLT:SWE:STEP 1.25 :SOUR:VOLT:SWE:STEP MIN :SOUR:VOLT:SWE:STEP? :SOUR:VOLT:SWE:STEP? MIN
Description	This setting is used when the sweep mode is set to linear (:SOURCE:VOLTage:SWEep:SPACing LINear).

:SOURCE:VOLTage:SWEep:POINTS

Function	Sets the step count of the voltage sweep (log sweep) or queries the current setting.
Syntax	:SOURCE:VOLTage:SWEep:POINTS <Integer> MINimum MAXimum <Integer> = Sets the step count to the specified value. MINimum = Sets the step count to the minimum value. MAXimum = Sets the step count to the maximum value. :SOURCE:VOLTage:SWEep:POINTS? [MINimum MAXimum] No parameter = Queries the current value. MINimum = Queries the minimum value. MAXimum = Queries the maximum value. → <Integer>
Example	:SOUR:VOLT:SWE:POIN 100 :SOUR:VOLT:SWE:POIN MAX :SOUR:VOLT:SWE:POIN? :SOUR:VOLT:SWE:POIN? MAX
Description	This setting is used when the sweep mode is set to logarithmic (:SOURCE:VOLTage:SWEep:SPACing LOGarithmic).

:SOURCE:VOLTage:ZERO:IMPedance

Function	Sets the zero source impedance (high or low) for generating voltage or queries the current setting.
Syntax	:SOURCE:VOLTage:ZERO:IMPedance HIGH LOW HIGH = Sets the impedance to high. LOW = Sets the impedance to low. :SOURCE:VOLTage:ZERO:IMPedance? → HIGH = Currently set to high impedance LOW = Currently set to low impedance
Example	:SOUR:VOLT:ZERO:IMP LOW :SOUR:VOLT:ZERO:IMP?

:SOURCE:VOLTage:ZERO:OFFset

Function	Sets the zero source offset value for generating voltage or queries the current setting.
Syntax	:SOURCE:VOLTage:ZERO:OFFSet <Voltage> <Voltage> = Sets the offset value to the specified voltage. :SOURCE:VOLTage:ZERO:OFFSet? → <Voltage>
Example	:SOUR:VOLT:ZERO:OFFS -0.3 :SOUR:VOLT:ZERO:OFFS?

:SOURCE:CURREnt:RANGe

Function	Sets the current source range setting (20 μ A, 200 μ A, 2 mA, 20 mA, 200 mA, 0.5 A, 1 A, 2 A, or 3 A) or queries the current setting.
Syntax	:SOURCE:CURREnt:RANGe <Current> MINimum MAXimum UP DOWN <Current> = Sets the smallest range setting that includes the specified value. MINimum = Sets the range setting to the minimum value. MAXimum = Sets the range setting to the maximum value. UP = Increases the range setting by 1. DOWN = Decreases the range setting by 1. :SOURCE:CURREnt:RANGe? [MINimum MAXimum] No parameter = Queries the current value. MINimum = Queries the minimum value. MAXimum = Queries the maximum value. → <Current>
Example	:SOUR:CURR:RANG 200E-6 :SOUR:CURR:RANG MAX :SOUR:CURR:RANG? :SOUR:CURR:RANG? MAX
Description	If the range setting is changed when auto range is ON by the SOURCE:CURREnt:RANGe:AUTO ON command, auto range is automatically disabled.

16.2 Commands

:SOURCE:CURRENT:RANGE:AUTO

Function Sets the source auto range (ON or OFF) or queries the current setting.

Syntax :SOURCE:CURRENT:RANGE:AUTO 1|0|ON|OFF
1 or ON = Turns auto range ON.
0 or OFF = Turns auto range OFF.
:SOURCE:CURRENT:RANGE:AUTO?
→ 1 = Currently ON
0 = Currently OFF

Example :SOUR:CURR:RANG:AUTO ON
:SOUR:CURR:RANG:AUTO?

Description This command and :SOURCE:VOLTage:RANGE:AUTO are equivalent.

:SOURCE:CURRENT:LEVEL

Function Sets the current source level value or queries the current setting.

Syntax :SOURCE:CURRENT:LEVEL <Current>|MINimum|MAXimum
<Voltage> = Sets the current level to the specified value.
MINimum = Sets the current level to the minimum value.
MAXimum = Sets the current level to the maximum value.
:SOURCE:VOLTage:LEVEL? [MINimum|MAXimum]
No parameter = Queries the current value.
MINimum = Queries the minimum value.
MAXimum = Queries the maximum value.
→ <Current>

Example :SOUR:CURR:LEV 3.5E-6
:SOUR:CURR:LEV MIN
:SOUR:CURR:LEV?
:SOUR:CURR:LEV? MIN

:SOURCE:CURRENT:PBASe

Function Sets the pulse base value for current pulse generation or queries the current setting.

Syntax :SOURCE:CURRENT:PBASe <Current>|MINimum|MAXimum
<current> = Sets the pulse base value to the specified value.
MINimum = Sets the pulse base value to the minimum value.
MAXimum = Sets the pulse base value to the maximum value.
:SOURCE:CURRENT:PBASe? [MINimum|MAXimum]
No parameter = Queries the current value.
MINimum = Queries the minimum value.
MAXimum = Queries the maximum value.
→ <Current>

Example :SOUR:CURR:PBAS -0.5
:SOUR:CURR:PBAS MIN
:SOUR:CURR:PBAS?
:SOUR:CURR:PBAS? MIN

:SOURCE:CURRENT:PROTECTION[:STATE]

Function Sets the limiter state (ON or OFF) or queries the current setting.

Syntax :SOURCE:CURRENT:PROTECTION[:STATE] 1|0|ON|OFF
1 or ON = Turns the limiter ON.
0 or OFF = Turns the limiter OFF.
:SOURCE:CURRENT:PROTECTION[:STATE]?
→ 1 = Currently ON
0 = Currently OFF

Example :SOUR:CURR:PROT:STAT OFF
:SOUR:CURR:PROT:STAT?

Description This command and :SOURCE:VOLTage:PROTECTION[:STATE] are equivalent.

:SOURCE:CURRENT:PROTECTION:LINKage

Function Sets the limiter tracking state (ON or OFF) or queries the current setting.

Syntax :SOURCE:CURRENT:PROTECTION:LINKage 1|0|ON|OFF
1 or ON = Turns limiter tracking ON.
0 or OFF = Turns limiter tracking OFF.
:SOURCE:CURRENT:PROTECTION:LINKage?
→ 1 = Currently ON
0 = Currently OFF

Example :SOUR:CURR:PROT:LINK OFF
:SOUR:CURR:PROT:LINK?

Description This command and :SOURCE:VOLTage:PROTECTION:LINKage are equivalent.

:SOURCE:CURRENT:PROTECTION:ULIMIT

Function	Sets the upper current limiter value (for generating voltage) or queries the current setting.
Syntax	:SOURCE:CURRENT:PROTECTION:ULIMIT <Current> MINimum MAXimum <current> = Sets the limiter value to the specified value. MINimum = Sets the limiter value to the minimum value. MAXimum = Sets the limiter value to the maximum value. :SOURCE:CURRENT:PROTECTION:ULIMIT? [MINimum MAXimum] No parameter = Queries the current value. MINimum = Queries the minimum value. MAXimum = Queries the maximum value. → <Current>
Example	:SOUR:CURR:PROT:ULIM 1.75 :SOUR:CURR:PROT:ULIM MAX :SOUR:CURR:PROT:ULIM? :SOUR:CURR:PROT:ULIM? MAX
Description	Note that the current limiter is activated when the source function is set to voltage (:SOURCE:FUNCTION VOLTage).

:SOURCE:CURRENT:PROTECTION:LLIMIT

Function	Sets the lower current limiter value (for generating voltage) or queries the current setting.
Syntax	:SOURCE:CURRENT:PROTECTION:LLIMIT <Current> MINimum MAXimum <current> = Sets the limiter value to the specified value. MINimum = Sets the limiter value to the minimum value. MAXimum = Sets the limiter value to the maximum value. :SOURCE:CURRENT:PROTECTION:LLIMIT? [MINimum MAXimum] No parameter = Queries the current value. MINimum = Queries the minimum value. MAXimum = Queries the maximum value. → <Current>
Example	:SOUR:CURR:PROT:LLIM -2.5 :SOUR:CURR:PROT:LLIM MIN :SOUR:CURR:PROT:LLIM? :SOUR:CURR:PROT:LLIM? MIN
Description	Note that the current limiter is activated when the source function is set to voltage (:SOURCE:FUNCTION VOLTage).

:SOURCE:CURRENT:SWEep:SPACing

Function	Sets the sweep mode (linear or log) or queries the current setting.
Syntax	:SOURCE:CURRENT:SWEep:SPACing LINear LOGarithmic LINear = Sets the sweep mode to linear. LOGarithmic = Sets the sweep mode to logarithmic. :SOURCE:CURRENT:SWEep:SPACing? → LIN = Currently set to linear LOG = Currently set to logarithmic
Example	:SOUR:CURR:SWE:SPAC LIN :SOUR:CURR:SWE:SPAC?
Description	This setting is used when the source pattern is set to sweep (:SOURCE:MODE SWEep). This command and :SOURCE:VOLTage:SWEep:SPACing are equivalent.

:SOURCE:CURRENT:SWEep:STARt

Function	Sets the start value of the current sweep or queries the current setting.
Syntax	:SOURCE:CURRENT:SWEep:STARt <Current> MINimum MAXimum <current> = Sets the start value to the specified value. MINimum = Sets the start value to the minimum value. MAXimum = Sets the start value to the maximum value. :SOURCE:CURRENT:SWEep:STARt? [MINimum MAXimum] No parameter = Queries the current value. MINimum = Queries the minimum value. MAXimum = Queries the maximum value. → <Current>
Example	:SOUR:CURR:SWE:STAR 0.05 :SOUR:CURR:SWE:STAR MIN :SOUR:CURR:SWE:STAR? :SOUR:CURR:SWE:STAR? MIN

16.2 Commands

:SOURCE:CURRENT:SWEep:STOP

Function Sets the stop value of the current sweep or queries the current setting.

Syntax :SOURCE:CURRENT:SWEep:STOP
<Current>|MINimum|MAXimum
<current> = Sets the stop value to the specified value.
MINimum = Sets the stop value to the minimum value.
MAXimum = Sets the stop value to the maximum value.
:SOURCE:CURRENT:SWEep:STOP?
[MINimum|MAXimum]
No parameter = Queries the current value.
MINimum = Queries the minimum value.
MAXimum = Queries the maximum value.
→ <Current>

Example :SOUR:CURR:SWE:STOP 1.25
:SOUR:CURR:SWE:STOP MAX
:SOUR:CURR:SWE:STOP?
:SOUR:CURR:SWE:STOP? MAX

:SOURCE:CURRENT:SWEep:STEP

Function Sets the step value of the current sweep (linear sweep) or queries the current setting.

Syntax :SOURCE:CURRENT:SWEep:STEP
<Voltage>|MINimum|MAXimum
<current> = Sets the step value to the specified value.
MINimum = Sets the step value to the minimum value.
MAXimum = Sets the step value to the maximum value.
:SOURCE:CURRENT:SWEep:STEP?
[MINimum|MAXimum]
No parameter = Queries the current value.
MINimum = Queries the minimum value.
MAXimum = Queries the maximum value.
→ <Current>

Example :SOUR:CURR:SWE:STEP 1.25
:SOUR:CURR:SWE:STEP MIN
:SOUR:CURR:SWE:STEP?
:SOUR:CURR:SWE:STEP? MIN

Description This setting is used when the sweep mode is set to linear (:SOURCE:VOLTage:SWEep:SPACing LINear).

:SOURCE:CURRENT:SWEep:POINTs

Function Sets the step count of the current sweep (log sweep) or queries the current setting.

Syntax :SOURCE:CURRENT:SWEep:POINTs
<Integer>|MINimum|MAXimum
<Integer> = Sets the step count to the specified value.
MINimum = Sets the step count to the minimum value.
MAXimum = Sets the step count to the maximum value.
:SOURCE:CURRENT:SWEep:POINTs?
[MINimum|MAXimum]
No parameter = Queries the current value.
MINimum = Queries the minimum value.
MAXimum = Queries the maximum value.
→ <Integer>

Example :SOUR:CURR:SWE:POIN 100
:SOUR:CURR:SWE:POIN MAX
:SOUR:CURR:SWE:POIN?
:SOUR:CURR:SWE:POIN? MAX

Description This setting is used when the sweep mode is set to logarithmic (:SOURCE:CURRENT:SWEep:SPACing LOGarithmic).

:SOURCE:CURRENT:ZERO:IMPedance

Function Sets the zero source impedance (high or low) for generating current or queries the current setting.

Syntax :SOURCE:CURRENT:ZERO:IMPedance
HIGH|LOW
HIGH = Sets the impedance to high.
LOW = Sets the impedance to low.
:SOURCE:CURRENT:ZERO:IMPedance?
→ HIGH = Currently set to high impedance
LOW = Currently set to low impedance

Example :SOUR:CURR:ZERO:IMP HIGH
:SOUR:CURR:ZERO:IMP?

:SOURCE:CURRENT:ZERO:OFFset

Function Sets the zero source offset value for generating current or queries the current setting.

Syntax :SOURCE:CURRENT:ZERO:OFFset
<Current>
<Voltage> = Sets the offset value to the specified current.
:SOURCE:CURRENT:ZERO:OFFset?
→ <Current>

Example :SOUR:CURR:ZERO:OFFS -0.3
:SOUR:CURR:ZERO:OFFS?

16.2.4 Sweep Commands (SWEep Group)

:SWEep:TRIGger

Function Starts the sweep operation.

Syntax :SWEep:TRIGger

Example :SWE:TRIG

Description This command is valid when the sweep pattern is set to sweep (:SOURce:MODE SWEep) or program sweep (:SOURce:MODE LIST).

:SWEep:COUNT

Function Sets the sweep repeat count or queries the current setting.

Syntax :SWEep:COUNT <Integer>|INFIinity|MINimum|MAXimum
 <Integer> = Sets the sweep repeat count to the specified value.
 INFIinity = Sets the sweep repeat count to infinity.
 MINimum = Sets the sweep repeat count to the minimum value.
 MAXimum = Sets the sweep repeat count to the maximum value.
 :SWEep:COUNT? [MINimum|MAXimum]
 No parameter = Queries the current value.
 MINimum = Queries the minimum value.
 MAXimum = Queries the maximum value.
 → <Integer> = Current count
 INF = Currently set to infinity

Example :SWE:COUN 10
 :SWE:COUN INF
 :SWE:COUN MAX
 :SWE:COUN?
 :SWE:COUN? MAX

Description This setting is used when the sweep pattern is set to sweep (:SOURce:MODE SWEep) or program sweep (:SOURce:MODE LIST).

:SWEep:LAST

Function Sets the sweep termination mode (keep level or return to initial level) or queries the current setting.

Syntax :SWEep:LAST KEEP|RETurn
 KEEP = Retains the last level.
 RETurn = Returns to the level before starting.
 :SWEep:LAST?
 → KEEP = Currently set to keep (retains the last level)
 RET= Currently set to return (reset to the level before starting)

Example :SWE:LAST KEEP
 :SWE:LAST?

Description This setting is used when the sweep pattern is set to sweep (:SOURce:MODE SWEep) or program sweep (:SOURce:MODE LIST).

16.2.5 Measurement Commands (SENSe GRoup)

:SENSe[:STATe]

Function Sets the measurement state (ON or OFF) or queries the current setting.

Syntax :SENSe[:STATe] 1|0|ON|OFF
 1 or ON = Turns the measurement ON.
 0 or OFF = Turns the measurement OFF.
 :SENSe[:STATe]?
 → 1 = Currently ON
 0 = Currently OFF

Example :SENS:STAT OFF
 :SENS:STAT?

:SENSe:FUNCTION VOLTage|CURRent|RESistance

Function Sets the measurement function (voltage, current, or resistance) or queries the current setting.

Syntax :SOURce:FUNCTION VOLTage|CURRent|RESistance
 VOLTage = Sets the measurement function to voltage.
 CURRent = Sets the measurement function to current.
 RESistance = Sets the measurement function to resistance.
 :SOURce:FUNCTION?
 → VOLT = Currently set to voltage.
 CURR = Currently set to current.
 RES = Current set to resistance.

Example :SENS:FUNC RES
 :SENS:FUNC?

:SENSe:RANGe:AUTO

Function Sets the measurement auto range (ON or OFF) or queries the current setting.

Syntax :SENSe:RANGe:AUTO 1|0|ON|OFF
 1 or ON = Turns auto range ON.
 0 or OFF = Turns auto range OFF.
 :SENSe:RANGe:AUTO?
 → 1 = Currently ON
 0 = Currently OFF

Example :SENS:RANG:AUTO OFF
 :SENS:RANG:AUTO?

:SENSe:ITIME

Function Sets the integration time or queries the current setting.

Syntax :SENSe:ITIME <Time>|PLC|MINimum|MAXimum|UP|DOWN
 <Time> = Sets the smallest integration time that includes the specified value.
 PLC = Sets the integration time to 1 cycle of the power frequency.
 MINimum = Sets the integration time to the minimum value.
 MAXimum = Sets the integration time to the maximum value.
 UP = Increases the integration time by 1 setting.
 DOWN = Decreases the integration time by 1 setting.
 :SENSe:ITIME? [MINimum|MAXimum]
 No parameter = Queries the current value.
 MINimum = Queries the minimum value.
 MAXimum = Queries the maximum value.
 → <Time>

Example :SENS:ITIM 4E-3
 :SENS:ITIM MIN
 :SENS:ITIM?
 :SENS:ITIM? MIN

:SENSe:DELay

Function Sets the measurement delay or queries the current setting.

Syntax :SENSe:DELay <Time>|MINimum|MAXimum
 <Time> = Sets the measurement delay to the specified value.
 MINimum = Sets the measurement delay to the minimum value.
 MAXimum = Sets the measurement delay to the maximum value.
 :SENSe:DELay? [MINimum|MAXimum]
 No parameter = Queries the current value.
 MINimum = Queries the minimum value.
 MAXimum = Queries the maximum value.
 → <Time>

Example :SENS:DEL 2.5E-3
 :SENS:DEL MIN
 :SENS:DEL?
 :SENS:DEL? MAX

:SENSe:AZERo[:STATe]

Function Sets the auto zero state (ON or OFF) or queries the current setting.

Syntax :SENSe:AZERo[:STATe] 1|0|ON|OFF
 1 or ON = Turns auto zero ON.
 0 or OFF = Turns auto zero OFF.
 :SENSe:AZERo[:STATe]?
 → 1 = Currently ON
 0 = Currently OFF

Example :SENS:AZER:STAT ON
 :SENS:AZER:STAT?

:SENSe:AZERo:EXECute

Function Executes auto zero.

Syntax :SENSe:AZERo:EXECute

Example :SENS:AZER:EXEC

:SENSe:AVERAge[:STATe]

Function Sets the average state (ON or OFF) or queries the current setting.

Syntax :SENSe:AVERAge[:STATe] 1|0|ON|OFF
 1 or ON = Turns averaging ON.
 0 or OFF = Turns averaging OFF.
 :SENSe:AVERAge[:STATe]?
 → 1 = Currently ON
 0 = Currently OFF

Example :SENS:AVER:STAT ON
 :SENS:AVER:STAT?

:SENSe:AVERAge:MODE

Function Sets the average mode (block or moving average) or queries the current setting.

Syntax :SENSe:AVERAge:MODE BLOCK|MOVing
 BLOCK = Sets the average mode to block.
 MOVing = Sets the average mode to moving.
 :SENSe:AVERAge:MODE?
 → 1 = Currently set to block
 0 = Currently set to moving

Example :SENS:AVER:MODE MOV
 :SENS:AVER:MODE?

:SENSe:AVERAge:COUNT

Function Sets the average count or queries the current setting.

Syntax :SENSe:AVERAge:COUNT <Integer>|
 MINimum|MAXimum
 <Integer> = Sets the average count to the specified value.
 MINimum = Sets the average count to the minimum value.
 MAXimum = Sets the average count to the maximum value.
 :SENSe:AVERAge:COUNT? [MINimum|
 MAXimum]
 No parameter = Queries the current value.
 MINimum = Queries the minimum value.
 MAXimum = Queries the maximum value.
 → <Integer>

Example :SENS:AVER:COUN 10
 :SENS:AVER:COUN MAX
 :SENS:AVER:COUN?
 :SENS:AVER:COUN? MAX

:SENSe:ACHange

Function Sets the auto V/I mode (ON or OFF) or queries the current setting.

Syntax :SENSe:ACHange 1|0|ON|OFF
 1 or ON = Turns auto V/I mode ON.
 0 or OFF = Turns auto V/I mode OFF.
 :SENSe:ACHange?
 → 1 = Currently ON
 0 = Currently OFF

Example :SENS:ACH ON
 :SENS:ACH?

Description Auto V/I mode automatically changes the measurement function when a limiter is activated. For details, see section 7.7, "Turning Auto V/I ON/OFF."

:SENSe:RSENse

Function Sets the four-wire measurement (remote sense) (ON or OFF) or queries the current setting.

Syntax :SENSe:RSENse 1|0|ON|OFF
 1 or ON = Turns the four-wire measurement ON.
 0 or OFF = Turns the four-wire measurement OFF (two-wire measurement).
 :SENSe:RSENse?
 → 1 = Currently ON (four-wire measurement)
 0 = Currently OFF (two-wire measurement)

Example :SENS:RSEN ON
 :SENS:RSEN?

16.2.6 Trigger Commands (TRIGger Group)

:TRIGger:SOURce

Function Sets the trigger source (constant period timer, external trigger, or no trigger wait) or queries the current setting.

Syntax :TRIGger:SOURce TIMer | EXTernal | IMMEDIATE
 TIMer = Sets the trigger source to constant period timer.
 EXTernal = Sets the trigger source to external trigger.
 IMMEDIATE = Sets the trigger source to no wait.
:TRIGger:SOURce?
 → TIM = Currently set to constant period timer
 EXT = Currently set to external trigger
 IMM = Currently set to no trigger wait

Example :TRIG:SOUR EXT
 :TRIG:SOUR?

Description This function corresponds to SHIFT+TRIG on the front panel. To apply triggers through communication, set the trigger source to external and use the GET or *TRG command to generate the trigger.

:TRIGger:TIMer

Function Sets the period of the constant period timer or queries the current setting.

Syntax :TRIGger:TIMer <Time> | MINimum | MAXimum
 <Time> = Sets the period to the specified value.
 MINimum = Sets the period to the minimum value.
 MAXimum = Sets the period to the maximum value.
:TRIGger:TIMer? [MINimum|MAXimum]
 No parameter = Queries the current value.
 MINimum = Queries the minimum value.
 MAXimum = Queries the maximum value.
 → <Time>

Example :TRIG:TIM 2.4
 :TRIG:TIM MIN
 :TRIG:TIM?
 :TRIG:TIM? MIN

16.2.7 Computation Commands (CALCulate Group)

:CALCulate:NULL[:STATe]

Function Sets the NULL computation state (ON or OFF) or queries the current setting.

Syntax `:CALCulate:NULL[:STATe] 1|0|ON|OFF`
 1 or ON = Turns NULL computation ON.
 0 or OFF = Turns NULL computation OFF.
`:CALCulate:NULL[:STATe]?`
 → 1 = Currently ON
 0 = Currently OFF

Example `:CALC:NULL:STAT ON`
`:CALC:NULL:STAT?`

Description When the NULL computation state is changed from OFF to ON, the NULL offset value is updated so that the current display value shows 0.

:CALCulate:NULL:OFFSet

Function Sets the offset value of the NULL computation or queries the current setting.

Syntax `:CALCulate:NULL:OFFSet <Value>`
 <Value> = Sets the offset value to the specified value.
`:CALCulate:NULL:OFFSet?`
 → <Value>

Example `:CALC:NULL:OFFS -0.123`
`:CALC:NULL?`

Description The NULL offset value is updated when the NULL computation state changes from OFF to ON so that the current displayed value shows 0. The NULL computation is carried out after other computations (AVERage, MATH, etc.) have been performed. Therefore, it is a parameter with no unit.

:CALCulate:MATH[:STATe]

Function Sets the state of the computation using equations (ON or OFF) or queries the current setting.

Syntax `:CALCulate:MATH[:STATe] 1|0|ON|OFF`
 1 or ON = Turns computation using equations ON.
 0 or OFF = Turns computation using equations OFF.
`:CALCulate:MATH[:STATe]?`
 → 1 = Currently ON
 0 = Currently OFF

Example `:CALC:MATH:STAT ON`
`:CALC:MATH:STAT?`

:CALCulate:MATH:SElect

Function Sets the definition file of the computation using equations or queries the current setting.

Syntax `:CALCulate:MATH:SElect <String>`
 <String> = File name to be specified.
`:CALCulate:MATH:SElect?`
 → <String> = Current file name.

Example `:CALC:MATH:SEL "Scale.txt"`
`:CALC:MATH:SEL?`

Description Select a file in the MATH directory on the GS610ROM disk. An error occurs if a file name that does not exist is specified. The file name is not case sensitive.

:CALCulate:MATH:CATalog?

Function Queries a list of definition files of the computation using equations.

Syntax `:CALCulate:MATH:CATalog?`
 → <String>[,<String>[,<String> ...]] = A list of definition files.
 NONE indicates that there are no definition files.

Example `:CALC:MATH:CAT?`

Description Specify a file in the MATH directory on the GS610 ROM disk for the definition file.

:CALCulate:MATH:DElete

Function Deletes the definition file of the computation using equations.

Syntax `:CALCulate:MATH:DElete <String>`
 <String> = Name of the file to be deleted.

Example `:CALC:MATH:DEL "Scale.txt"`

Description Select a file in the MATH directory on the GS610ROM disk. An error occurs if a file name that does not exist is specified. The file name is not case sensitive.

:CALCulate:MATH:DEFine

Function Creates a definition file of the computation using equations.

Syntax `:CALCulate:MATH:DEFine <String>,<String>`
 <String> = Name of the file to be created
 <String> = Contents to be written to the file

Example `:CALC:MATH:DEF "Scale.txt",
 "M=M*2+1"`

Description The file is created in the MATH directory on the GS610ROM disk. If an existing file name is specified, the file is overwritten.

16.2 Commands

:CALCulate:MATH:PARameter:A

Function Sets equation parameter A or queries the current setting.

Syntax **:CALCulate:MATH:PARameter:A <Value>**
<Value> = Sets equation parameter A to the specified value.
:CALCulate:MATH:PARameter:A?
→ <Value>

Example **:CALC:MATH:PAR:A 3.141592**
:CALC:MATH:PAR:A?

:CALCulate:MATH:PARameter:B

Function Sets equation parameter B or queries the current setting.

Syntax **:CALCulate:MATH:PARameter:B <Value>**
<Value> = Sets equation parameter B to the specified value.
:CALCulate:MATH:PARameter:B?
→ <Value>

Example **:CALC:MATH:PAR:B 1.41421356**
:CALC:MATH:PAR:B?

:CALCulate:MATH:PARameter:C

Function Sets equation parameter C or queries the current setting.

Syntax **:CALCulate:MATH:PARameter:C <Value>**
<Value> = Sets equation parameter C to the specified value.
:CALCulate:MATH:PARameter:C?
→ <Value>

Example **:CALC:MATH:PAR:C 6.626069E-34**
:CALC:MATH:PAR:C?

:CALCulate:LIMit[:STATe]

Function Sets the state of the comparison operation (ON or OFF) or queries the current setting.

Syntax **:CALCulate:LIMit[:STATe] 1|0|ON|OFF**
1 or ON = Turns comparison operation ON.
0 or OFF = Turns comparison operation OFF.
:CALCulate:LIMit[:STATe]?
→ 1 = Currently ON
0 = Currently OFF

Example **:CALC:LIM:STAT ON**
:CALC:LIM:STAT?

:CALCulate:LIMit:UPPer

Function Sets the upper limit of the comparison operation or queries the current setting.

Syntax **:CALCulate:LIMit:UPPer <Value>|MINimum|MAXimum**
<Value> = Sets the upper limit to the specified value.
MINimum = Sets the upper limit to the minimum value.
MAXimum = Sets the upper limit to the maximum value.
:CALCulate:LIMit:UPPer? [MINimum|MAXimum]
No parameter = Queries the current value.
MINimum = Queries the minimum value.
MAXimum = Queries the maximum value.
→ <Value>

Example **:CALC:LIM:UPP 12.5**
:CALC:LIM:UPP MAX
:TRIG:LIM:UPP?
:TRIG:LIM:UPP? MAX

:CALCulate:LIMit:LOWer

Function Sets the lower limit of the comparison operation or queries the current setting.

Syntax **:CALCulate:LIMit:LOWer <Value>|MINimum|MAXimum**
<Value> = Sets the lower limit to the specified value.
MINimum = Sets the lower limit to the minimum value.
MAXimum = Sets the lower limit to the maximum value.
:CALCulate:LIMit:LOWer? [MINimum|MAXimum]
No parameter = Queries the current value.
MINimum = Queries the minimum value.
MAXimum = Queries the maximum value.
→ <Value>

Example **:CALC:LIM:LOW 8.5**
:CALC:LIM:LOW MIN
:TRIG:LIM:LOW?
:TRIG:LIM:LOW? MIN

16.2.8 Store/Recall Commands (TRACe Group)

:TRACe[:STATe]

Function Sets the storage state (ON or OFF) or queries the current setting.

Syntax :TRACe[:STATe] 1|0|ON|OFF
 1 or ON = Turns storage state ON.
 0 or OFF = Turns storage state OFF.
 :TRACe[:STATe]?
 → 1 = Currently ON
 0 = Currently OFF

Example :TRAC:STAT ON
 :TRAC:STAT?

Description The storage operation automatically turns OFF after the store count (:TRACe:POINts) of basic cycles are completed after the storage operation is turned ON. If auto storage is ON (:TRACe:AUTO ON), the storage operation automatically turns ON when the sweep operation is started.

:TRACe:AUTO

Function Sets the auto storage state (ON or OFF) or queries the current setting.

Syntax :TRACe:AUTO 1|0|ON|OFF
 1 or ON = Turns auto storage ON.
 0 or OFF = Turns auto storage OFF.
 :TRACe:AUTO?
 → 1 = Currently ON
 0 = Currently OFF

Example :TRAC:AUTO ON
 :TRAC:AUTO?

Description If auto storage is ON, the storage operation automatically turns ON (:TRACe[:STATe] ON) when the sweep operation is started.

:TRACe:POINts

Function Sets the store count or queries the current setting.

Syntax :TRACe:POINts <Integer>|MINimum|MAXimum
 <Integer> = Sets the store count to the specified value.
 MINimum = Sets the store count to the minimum value.
 MAXimum = Sets the store count to the maximum value.
 :TRACe:POINts? [MINimum|MAXimum]
 No parameter = Queries the current value.
 MINimum = Queries the minimum value.
 MAXimum = Queries the maximum value.
 → <Integer>

Example :TRAC:POIN 256

Description If auto storage is ON (:TRACe:AUTO ON), the store count is automatically set to the sweep count (sweep count × repeat count). However, if this value is greater than 65535, it is rounded to 65535.

:TRACe:ACTual?

Function Queries the actual number of stored points.

Syntax :TRACe:ACTual?
 → <Integer>

Example :TRAC:ACT?

:TRACe:CALCulate:MINimum?

Function Queries the minimum value among the stored measured values.

Syntax :TRACe:CALCulate:MINimum?
 → <Value>

Example :TRAC:CALC:MIN?

:TRACe:CALCulate:MAXimum?

Function Queries the maximum value among the stored measured values.

Syntax :TRACe:CALCulate:MAXimum?
 → <Value>

Example :TRAC:CALC:MAX?

:TRACe:CALCulate:AVERage?

Function Queries the average value among the stored measured values.

Syntax :TRACe:CALCulate:AVERage?
 → <Value>

Example :TRAC:CALC:AVER?

16.2 Commands

:TRACe:CALCulate:SDEVIation?

Function Queries the standard deviation of the stored measured values.

Syntax :TRACe:CALCulate:SDEVIation?
→ <Value>

Example :TRAC:CALC:SDEV?

:TRACe:DATA:NUMBER

Function Sets the store data number or queries the current setting.

Syntax :TRACe:DATA:NUMBER <Integer> |
MINimum | MAXimum | UP | DOWN
<Integer> = Sets the store data number to the specified value.
MINimum = Sets the store data number to the minimum value.
MAXimum = Sets the store data number to the maximum value.
UP = Increments the store data number.
DOWN = Decrements the store data number.
:TRACe:DATA:NUMBER [MINimum |
MAXimum]
No parameter = Queries the current value.
MINimum = Queries the minimum value.
MAXimum = Queries the maximum value.
→ <Integer>

Example :TRAC:DATA:NUMB 1
:TRAC:DATA:NUMB MAX
:TRAC:DATA:NUMB UP
:TRAC:DATA:NUMB?
:TRAC:DATA:NUMB? MAX

Description This data number indicates the read position in the storage memory. It is used by the :TRACe:DATA:TIME?, :TRACe:DATA:SOURce?, :TRACe:DATA[:SENSe]?, and :TRACe:DATA:SETup? commands. Set the number in the range of 1 (start) to the return value of :TRACe:ACTual? (last).

:TRACe:DATA:TIME?

Function Queries the time stamp of the stored data.

Syntax :TRACe:DATA:TIME?
→ <Time>

Example :TRAC:DATA:TIME?

Description Queries the time stamp of the position specified by :TRACe:DATA:NUMBER in the storage memory. The time stamp is a relative value from the start of the stored data.

:TRACe:DATA:SOURce?

Function Queries the source value of the stored data.

Syntax :TRACe:DATA:SOURce?
→ <Value>

Example :TRAC:DATA:SOURce?

Description Queries the source value of the position specified by :TRACe:DATA:NUMBER in the storage memory. The source value is voltage if generating voltage (:SOURce:FUNCTion VOLTage) and current if generating current (:SOURce:FUNCTion CURRent).

:TRACe:DATA[:SENSe]?

Function Queries the measured value of the stored data.

Syntax :TRACe:DATA[:SENSe]?
→ <Value>

Example :TRAC:DATA:SENS?

Description Queries the measured value of the position specified by :TRACe:DATA:NUMBER in the storage memory. The measured value is voltage if measuring voltage (:SENSe:FUNCTion VOLTage), current if measuring current (:SENSe:FUNCTion CURRent), and resistance if measuring resistance (:SENSe:FUNCTion RESistance).

:TRACe:DATA:SETup?

Function Queries the setup mnemonic of the stored data.

Syntax :TRACe:DATA:SETup?
→ <String>

Example :TRAC:DATA:SET?

Description Queries the setup mnemonic of the position specified by :TRACe:DATA:NUMBER in the storage memory. The setup mnemonic written in the program sweep pattern file is returned. However, if the source mode is fixed level (:SOURce:MODE FIXed) or linear/log (:SOURce:MODE SWEEp), an empty string "" is returned.

:TRACe:MONLy

Function Sets the measurement-only state (ON or OFF) or queries the current setting.

Syntax :TRACe:MONLy 1 | 0 | ON | OFF
1 or ON = Turns measurement only ON.
0 or OFF = Turns measurement only OFF.
:TRACe:MONLy?
→ 1 = Currently ON
0 = Currently OFF

Example :TRAC:MONL ON
:TRAC:MONL?

Description When measurement-only is turned ON, only the data when the measurement is ON is stored. Turn measurement-only ON when you want to output only the lines that contain measured data in the result file.

16.2.9 External Input/Output Commands (ROUTE Group)

:ROUTE:BNCI:SElect

Function Selects the BNC input (trigger input, sweep start input, or control input) or queries the current setting.

Syntax :ROUTE:BNCI:SElect TRIGger|SWEep|CONTrol
 TRIGger = Sets the BNC input to trigger input.
 SWEep = Sets the BNC input to sweep start input.
 CONTrol = Sets the BNC input to control input.
 :ROUTE:BNCI:SElect?
 → TRIG = Currently set to trigger input
 SWE = Currently set to sweep start
 CONT = Currently set to control input

Example :ROUT:BNCI:SEL TRIG
 :ROUT:BNCI:SEL?

:ROUTE:BNCI:CONTrol

Function Selects the BNC control input (interlock, output control, or zero control) or queries the current setting.

Syntax :ROUTE:BNCI:CONTrol ILOCK|OUTPut|ZERO
 ILOCK = Sets the input to interlock.
 OUTPut = Sets the input to output control.
 ZERO = Sets the input to zero control.
 :ROUTE:BNCI:CONTrol?
 → ILOC = Currently set to interlock input
 OUTP = Currently set to output control input
 ZERO = Currently set to zero control input

Example :ROUT:BNCI:CONT OUTP
 :ROUT:BNCI:CONT?

:ROUTE:BNCO:SElect

Function Selects the BNC output (trigger output, sweep synchronization output, or control output) or queries the current setting.

Syntax :ROUTE:BNCO:SElect TRIGger|SWEep|CONTrol
 TRIGger = Sets the BNC output to trigger output.
 SWEep = Sets the BNC output to sweep synchronization output.
 CONTrol = Sets the BNC output to control output.
 :ROUTE:BNCO:SElect?
 → TRIG = Currently set to trigger output
 SWE = Currently set to sweep synchronization output
 CONT = Currently set to control output

Example :ROUT:BNCO:SEL SWE
 :ROUT:BNCO:SEL?

:ROUTE:BNCO:TRIGger

Function Sets the BNC trigger output generation timing (trigger, source change, measurement begin, measurement end, or pulse end) or queries the current setting.

Syntax :ROUTE:BNCO:TRIGger ORIGin|SCHange|MBEGin|MEND|PEND
 ORIGin = Sets the timing to the trigger point.
 SCHange = Sets the timing to the source change point.
 MBEGin = Sets the timing to measurement start point.
 MEND = Sets the timing to measurement end point.
 PEND = Sets the timing to pulse end point.
 :ROUTE:BNCO:TRIGger?
 → ORIG = Currently set to trigger point
 SCH = Currently set to source change point
 MBEG = Currently set to measurement start point
 MEND = Currently set to measurement end point
 PEND = Currently set to pulse end point

Example :ROUT:BNCO:TRIG ORIG
 :ROUT:BNCO:TRIG?

:ROUTE:BNCO:SWEep

Function Sets the BNC sweep synchronization output generation timing (sweep start, 1 turn end, all sweep end) or queries the current setting.

Syntax :ROUTE:BNCO:SWEep ORIGin|TURN|ALL
 ORIGin = Sets the timing to the sweep start point.
 TURN = Sets the timing to the end of a turn.
 ALL = Sets the timing to the end of all sweeps.
 :ROUTE:BNCO:SWEep?
 → ORIG = Currently set to sweep start
 TURN = Currently set to the end of a turn
 ALL = Currently set to the end of all sweeps

Example :ROUT:BNCO:SWE ALL
 :ROUT:BNCO:SWE?

16.2 Commands

:ROUTE:BNCO:CONTROL

Function Selects the control output of the BNC output terminal (interlock, output control, zero control, or programmable) or queries the current setting.

Syntax :ROUTE:BNCO:CONTROL ILOCK|OUTPUT|ZERO|PROGRAM
ILOCK = Outputs the interlock state.
OUTPUT = Outputs the output state.
ZERO = Outputs the zero state.
PROGRAM = Sets the control output to programmable output.

:ROUTE:BNCO:CONTROL?
→ ILOC = Currently set to interlock state
OUTP = Currently set to output state
ZERO = Currently set to zero state
PROG = Currently set to programmable output

Example :ROUT:BNCO:CONT PROG
:ROUT:BNCO:CONT?

:ROUTE:DIO5

Function Sets the function (output control or zero control) of pin 5 (control input) of the external input/output connector or queries the current setting.

Syntax :ROUTE:DIO5 OUTPUT|ZERO
OUTPUT = Sets the function to output control input.
ZERO = Sets the function to zero control input.

:ROUTE:DIO5?
→ OUTP = Currently set to output control input
ZERO = Currently set to zero control input

Example :ROUT:DIO5 OUTP
:ROUT:DIO5?

:ROUTE:DIO6

Function Sets the function (trigger start point, source change, measurement begin, measurement end, or pulse end) of pin 6 (trigger output) of the external input/output connector or queries the current setting.

Syntax :ROUTE:DIO6 ORIGIN|SCHANG|MBEGIN|MEND|PEND

ORIGIN = Sets the function to the trigger point.
SCHANG = Sets the function to the source change point.
MBEGIN = Sets the function to measurement start point.
MEND = Sets the function to measurement end point.
PEND = Sets the function to pulse end point.

:ROUTE:DIO6?
→ ORIG = Currently set to trigger point
SCH = Currently set to source change point
MBEG = Currently set to measurement start point
MEND = Currently set to measurement end point
PEND = Currently set to pulse end point

Example :ROUT:DIO6 MBEG
:ROUT:DIO6?

:ROUTE:DIO7

Function Sets the function (sweep start point, 1 turn end, or all sweep end) of pin 7 (sweep synchronization output) of the external input/output connector or queries the current setting.

Syntax :ROUTE:DIO7 ORIGIN|TURN|ALL

ORIGIN = Sets the function to the sweep start point.
TURN = Sets the function to the end of 1 turn.
ALL = Sets the function to the end of all sweeps.

:ROUTE:DIO7?
→ ORIG = Currently set to sweep start
TURN = Currently set to the end of a turn
ALL = Currently set to the end of all sweeps

Example :ROUT:DIO7 END
:ROUT:DIO7?

:ROUTe:DIO8

Function Sets the function (interlock, output control, or zero control) of pin 8 (control output) of the external input/output connector or queries the current setting.

Syntax :ROUTe:DIO8 ILOCK|OUTPut|ZERO
ILOCK = Outputs the interlock state.
OUTPut = Outputs the output state.
ZERO = Outputs the zero state.
:ROUTe:DIO8?
→ ILOC = Currently set to interlock state
OUTP = Currently set to output state
ZERO = Currently set to zero state

Example :ROUT:DIO8 OUTP
:ROUT:DIO8?

16.2.10 System Commands (SYSTEM Group)

:SYSTEM:DISPLAY[:STATE]

Function Sets the display state (ON or OFF) or queries the current setting.

Syntax :SYSTEM:DISPLAY[:STATE] 1|0|ON|OFF
 1 or ON = Turns the display ON.
 0 or OFF = Turns the display OFF.
 :SYSTEM:DISPLAY[:STATE]?
 → 1 = Currently ON
 0 = Currently OFF

Example :SYST:DISP:STAT OFF
 :SYST:DISP:STAT?

:SYSTEM:DISPLAY:BRIGHT

Function Sets the display brightness or queries the current setting.

Syntax :SYSTEM:DISPLAY:BRIGHT <Integer> |
 MINimum|MAXimum|UP|DOWN
 <Integer> = Sets the brightness to the specified value.
 MINimum = Sets the brightness to the minimum value.
 MAXimum = Sets the brightness to the maximum value.
 UP = Increments the brightness.
 DOWN = Decrements the brightness.
 :SYSTEM:DISPLAY:BRIGHT? [MINimum|
 MAXimum]
 No parameter = Queries the current value.
 MINimum = Queries the minimum value.
 MAXimum = Queries the maximum value.
 → <Integer>

Example :SYST:DISP:BRIG 2
 :SYST:DISP:BRIG DOWN
 :SYST:DISP:BRIG?

:SYSTEM:CLOCK:DATE

Function Sets the date or queries the current setting.

Syntax :SYSTEM:CLOCK:DATE <String>
 :SYSTEM:CLOCK:DATE?
 → <String> = String representing the date in
 "YYYY/MM/DD" format

Example :SYST:CLOC:DATE "2005/03/31"
 :SYST:CLOC:DATE?

:SYSTEM:CLOCK:TIME

Function Sets the time or queries the current setting.

Syntax :SYSTEM:CLOCK:TIME <String>
 :SYSTEM:CLOCK:TIME?
 → <String> = String representing the time in
 "HH:MM:SS" format

Example :SYST:CLOC:TIME "21:30:00"
 :SYST:CLOC:TIME?

:SYSTEM:CLOCK:TZONE

Function Sets the time zone or queries the current setting.

Syntax :SYSTEM:CLOCK:TZONE <String>
 :SYSTEM:CLOCK:TZONE?
 → <String> = String representing the time
 difference in "+HH:MM" or "-HH:MM" format

Example :SYST:CLOC:TZON "+09:00"
 :SYST:CLOC:TZON?

:SYSTEM:SETUP:SAVE

Function Saves the current setup data to a file.

Syntax :SYSTEM:SETUP:SAVE <String>
 <String> = Name of the file to be saved

Example :SYSTEM:SETUP:SAVE "SetupXXX.txt"

Description The file is created in the SETUP directory on the GS610ROM disk. If an existing file name is specified, the file is overwritten.

:SYSTEM:SETUP:LOAD

Function Loads the saved setup data.

Syntax :SYSTEM:SETUP:LOAD <String>
 <String> = Name of the file to be loaded

Example :SYSTEM:SETUP:LOAD "SetupXXX.txt"

Description Select a file in the SETUP directory on the GS610ROM disk. An error occurs if a file name that does not exist is specified. The file name is not case sensitive.

:SYSTEM:SETUP:CATALOG?

Function Queries a list of setup data files that are saved.

Syntax :SYSTEM:SETUP:CATALOG?
 → <String>[,<String>[,<String> ...]] = A list of
 setup files.
 NONE indicates that there are no setup
 files.

Example :SYST:SET:CAT?

Description Setup files are files in the SETUP directory of the GS610ROM disk.

:SYSTEM:SETUP:DELETE

Function Deletes the setup data files that are saved.

Syntax :SYSTEM:SETUP:DELETE <String>
 <String> = Name of the file to be deleted.

Example :SYST:SET:DEL "SetupXXX.txt"

Description Select a file in the SETUP directory on the GS610ROM disk. An error occurs if a file name that does not exist is specified. The file name is not case sensitive.

:SYSTEM:SETUP:PON

Function Sets the setup data that is loaded when the power is turned ON or queries the current setting.

Syntax :SYSTEM:SETUP:PON <String>
 <String> = File name to be specified.
 :SYSTEM:SETUP:PON?
 → <String> = Current file name.

Example :SYST:SET:PON "Setup1.txt"
 :SYST:SET:PON?

Description Select a file in the SETUP directory on the GS610ROM disk. An error occurs if a file name that does not exist is specified. The file name is not case sensitive.

:SYSTEM:ERROR?

Function Queries the error code and message information.

Syntax :SYSTEM:ERROR?
 <Integer>, <String>
 → <Integer> = Error code
 <String> = Error message

Example :SYST:ERR?

:SYSTEM:REMOte

Function Transits to remote mode.

Syntax :SYSTEM:REMOte

Example :SYST:REM

Description This command is used to set the GS610 to remote mode on communication interfaces other than GP-IB. To release remote mode, send the SYSTEM:LOCAL command.

:SYSTEM:LOCAL

Function Transits to local mode.

Syntax :SYSTEM:LOCAL

Example :SYST:LOC

Description This command is used to release the GS610 from remote mode (change to local mode) on communication interfaces other than GP-IB.

:SYSTEM:KLOCK

Function Sets the key lock state (ON or OFF) or queries the current setting.

Syntax :SYSTEM:KLOCK 1|0|ON|OFF
 1 or ON = Turns key lock ON.
 0 or OFF = Turns key lock OFF.
 :SYSTEM:KLOCK?
 → 1 = Currently ON
 0 = Currently OFF

Example :SYST:KLOC ON
 :SYST:KLOC?

:SYSTEM:BEEPer [:STATE]

Function Sets the beep sound (ON or OFF) or queries the current setting.

Syntax :SYSTEM:BEEP 1|0|ON|OFF
 1 or ON = Turns the beep sound ON.
 0 or OFF = Turns the beep sound OFF.
 :SYSTEM:BEEP?
 → 1 = Currently ON
 0 = Currently OFF

Example :SYST:BEEP ON
 :SYST:BEEP?

:SYSTEM:LFRrequency

Function Sets the power frequency (50 Hz or 60 Hz) or queries the current setting.

Syntax :SYSTEM:LFRrequency 50|60
 50 = Sets the power frequency to 50 Hz.
 60 = Sets the power frequency to 60 Hz.
 :SYSTEM:LFRrequency?
 → 50 = Currently set to 50 Hz
 60 = Currently set to 60 Hz

Example :SYST:LFR 50
 :SYST:LFR?

Description The power frequency is automatically detected when the power is turned ON. Therefore, you normally do not need to set the frequency.

:SYSTEM:WAIT

Function Holds the GS610 for the specified wait time.

Syntax :SYSTEM:WAIT <Time>
 <Time> = Wait time

Example :SYST:WAIT 0.05

:SYSTEM:COMMunicate:GPIB:ADDRESS

Function Sets the GP-IB address or queries the current setting.

Syntax :SYSTEM:COMMunicate:GPIB:ADDRESS
 <Integer>
 :SYSTEM:COMMunicate:GPIB:ADDRESS?
 → <Integer>

Example :SYST:COMM:GPIB:ADDR 15
 :SYST:COMM:GPIB:ADDR?

16.2 Commands

:SYSTem:COMMunicate:RS232:BAUDrate

Function Sets the RS-232 baud rate or queries the current setting.

Syntax `:SYSTem:COMMunicate:RS232:BAUDrate`
9600|14400|19200|38400|57600|115200
9600 = Sets the baud rate to 9600 bps.
14400 = Sets the baud rate to 14400 bps.
19200 = Sets the baud rate to 19200 bps.
38400 = Sets the baud rate to 38400 bps.
57600 = Sets the baud rate to 57600 bps.
115200 = Sets the baud rate to 115200 bps.
`:SYSTem:COMMunicate:RS232:BAUDrate?`
→ 9600 = Currently set to 9600 bps
14400 = Currently set to 14400 bps
19200 = Currently set to 19200 bps
38400 = Currently set to 38400 bps
57600 = Currently set to 57600 bps
115200 = Currently set to 115200 bps

Example `:SYST:COMM:RS232:BAUD 38400`
`:SYST:COMM:RS232:BAUD?`

:SYSTem:COMMunicate:RS232:DLENgth

Function Sets the RS-232 data length (7 bits or 8 bits) or queries the current setting.

Syntax `:SYSTem:COMMunicate:RS232:DLENgth`
7|8
7 = Sets the data length to 7 bits.
8 = Sets the data length to 8 bits.
`:SYSTem:COMMunicate:RS232:DLENgth?`
→ 7 = Currently set to 7 bits.
8 = Currently set to 8 bits.

Example `:SYST:COMM:RS232:DLEN 8`
`:SYST:COMM:RS232:DLEN?`

:SYSTem:COMMunicate:RS232:PARity

Function Sets the RS-232 parity (none, even, or odd) or queries the current setting.

Syntax `:SYSTem:COMMunicate:RS232:PARity`
NONE|EVEN|ODD
NONE = Sets the parity to none.
EVEN = Sets the parity to even.
ODD = Sets the parity to ODD.
`:SYSTem:COMMunicate:RS232:PARity?`
→ NONE = Currently set to none
EVEN = Currently set to even
ODD = Currently set to odd

Example `:SYST:COMM:RS232:PAR NONE`
`:SYST:COMM:RS232:PAR?`

:SYSTem:COMMunicate:RS232:SBITs

Function Sets the RS-232 stop bit(1 bit or 2 bits) or queries the current setting.

Syntax `:SYSTem:COMMunicate:RS232:SBITs` 1|2
1 = Sets the stop bit to 1 bit.
2 = Sets the stop bit to 2 bits.
`:SYSTem:COMMunicate:RS232:SBITs?`
→ 1 = Currently set to 1 bit.
2 = Currently set to 2 bits.

Example `:SYST:COMM:RS232:SBIT 1`
`:SYST:COMM:RS232:SBIT?`

:SYSTem:COMMunicate:RS232:PACE

Function Sets the RS-232 flow control (none, XON-OFF, or CTS-RTS) or queries the current setting.

Syntax `:SYSTem:COMMunicate:RS232:PACE`
NONE|XON|HARDware
NONE = Sets the flow control to none.
XON = Sets the flow control to XON/XOFF.
HARDware = Sets the flow control to CTS/RTS.
`:SYSTem:COMMunicate:RS232:SBITs?`
→ NONE = Currently set to none
XON = Currently set to XON/XOFF control
HARD = Currently set to CTS/RTS control

Example `:SYST:COMM:RS232:PACE HARD`
`:SYST:COMM:RS232:PACE?`

:SYSTem:COMMunicate:RS232:TERMinator

Function Sets the RS-232 terminator (CR, LF, or CR+LF) or queries the current setting.

Syntax `:SYSTem:COMMunicate:RS232:`
TERMinatorCR|LF|CRLF
CR = Sets the terminator to CR (ASCII code: 0x0D).
LF = Sets the terminator to LF (ASCII code: 0x0A).
CRLF = Sets the terminator to CR+LF.
`:SYSTem:COMMunicate:RS232:`
TERMinator?
→ CR = Currently set to CR
LF = Currently set to LF
CRLF = Currently set to CR+LF

Example `:SYST:COMM:RS232:TERM LF`
`:SYST:COMM:RS232:TERM?`

Description This setting is the terminator for transmission messages. When receiving messages, CR, LF, and CR+LF are all accepted as terminators.

:SYSTEM:COMMUNICATE:ETHER:MAC?

Function Queries the MAC address of Ethernet communication.

Syntax `:SYSTEM:COMMUNICATE:ETHER:MAC?`
 → <String> = String representing the MAC address in "h:h:h:h:h" format (where h is a hexadecimal number between 00 and FF)

Example `:SYST:COMM:ETH:MAC?`

:SYSTEM:COMMUNICATE:ETHER:PORT?

Function Queries the command socket port number of Ethernet communication.

Syntax `:SYSTEM:COMMUNICATE:ETHER:PORT? ->`
 7655

Example `:SYST:COMM:ETH:PORT?`

Description A port number used for the command socket. Port 7655 is used on the GS610.

:SYSTEM:COMMUNICATE:ETHER:DHCP

Function Sets DHCP (ON or OFF) of Ethernet communication or queries the current setting.

Syntax `:SYSTEM:COMMUNICATE:ETHER:DHCP 1|0|ON|OFF`
 1 or ON = Turns DHCP ON.
 0 or OFF = Turns DHCP OFF.
`:SYSTEM:COMMUNICATE:ETHER:DHCP?`
 → 1 = Currently ON
 0 = Currently OFF

Example `:SYST:COMM:ETH:DHCP ON`
`:SYST:COMM:ETH:DHCP?`

:SYSTEM:COMMUNICATE:ETHER:IP

Function Sets the IP address of Ethernet communication or queries the current setting.

Syntax `:SYSTEM:COMMUNICATE:ETHER:IP`
 <String>
`:SYSTEM:COMMUNICATE:ETHER:IP?`
 → <String> = String representing the address in "d.d.d.d" format (where d is a decimal number between 0 and 255)

Example `:SYST:COMM:ETH:IP "10.0.128.64"`
`:SYST:COMM:ETH:IP?`

Description The result varies depending on the DHCP state. If DHCP is OFF, the specified fixed value is returned. If DHCP is ON, a dynamic result assigned through DHCP is returned. If the dynamic address is being assigned or the address assignment failed, "0.0.0.0" is returned.

:SYSTEM:COMMUNICATE:ETHER:MASK

Function Sets the net mask of Ethernet communication or queries the current setting.

Syntax `:SYSTEM:COMMUNICATE:ETHER:MASK`
 <String>
`:SYSTEM:COMMUNICATE:ETHER:MASK?`
 → <String> = String representing the address in "d.d.d.d" format (where d is a decimal number between 0 and 255)

Example `:SYST:COMM:ETH:MASK "255.255.254.0"`
`:SYST:COMM:ETH:MASK?`

Description The result varies depending on the DHCP state. If DHCP is OFF, the specified fixed value is returned. If DHCP is ON, a dynamic result assigned through DHCP is returned. If the dynamic address is being assigned or the address assignment failed, "0.0.0.0" is returned.

:SYSTEM:COMMUNICATE:ETHER:GATE

Function Sets the default gateway of Ethernet communication or queries the current setting.

Syntax `:SYSTEM:COMMUNICATE:ETHER:GATE`
 <String>
`:SYSTEM:COMMUNICATE:ETHER:GATE?`
 → <String> = String representing the address in "d.d.d.d" format (where d is a decimal number between 0 and 255)

Example `:SYST:COMM:ETH:GATE "10.0.129.255"`
`:SYST:COMM:ETH:GATE?`

Description The result varies depending on the DHCP state. If DHCP is OFF, the specified fixed value is returned. If DHCP is ON, a dynamic result assigned through DHCP is returned. If the dynamic address is being assigned or the address assignment failed, "0.0.0.0" is returned.

:SYSTEM:COMMUNICATE:ETHER:TERMINATOR?

Function Sets the terminator (CR, LF, or CR+LF) of Ethernet communication or queries the current setting.

Syntax `:SYSTEM:COMMUNICATE:ETHER:TERMINATOR CR|LF|CRLF`
 CR = Sets the terminator to CR (ASCII code: 0x0D).
 LF = Sets the terminator to LF (ASCII code: 0x0A).
 CRLF = Sets the terminator to CR+LF.
`:SYSTEM:COMMUNICATE:ETHER:TERMINATOR?`
 → CR = Currently set to CR
 LF = Currently set to LF
 CRLF = Currently set to CR+LF

Example `:SYST:COMM:ETH:TERM LF`
`:SYST:COMM:ETH:TERM?`

Description This setting is the terminator for transmission messages. When receiving messages, CR, LF, and CR+LF are all accepted as terminators.

16.2.11 Measured Value Read Commands (INITiate, FETCh, and READ Group)

:INITiate

Function Starts a new measurement.
Syntax :INITiate
Example :INIT

:FETCh?

Function Queries the measured results.
Syntax :FETCh?
→ <Value>
Example :FETC?

:READ?

Function Starts a new measurement and queries the measured results.
Syntax :READ?
Example :READ?
Description This command is equivalent to :INITiate;:FETCh?.

Note

The :FETCh? command after sending the :INITiate command applies a new trigger. When the measurement is complete, the result is returned. If the :FETCh? command is send without sending the :INITiate command, the last measured result is immediately returned. Use the :READ? command to read the measured result when using an internal trigger or external trigger. To generate triggers from a PC, set the trigger source to external (:TRIGger:SOURce EXTernal) and use the following commands.

:INITiate	Starts a new measurement.
*TRG	Generates a trigger.
:FETCh?	Read the results.

16.2.12 Status Commands (STATus Group)

:STATus:SOURce:CONDition?

Function Queries the source event condition register.

Syntax :STATus:SOURce:CONDition?
→ <Integer>

Example :STAT:SOUR:COND?

Description For details, see section 16.3.

:STATus:SOURce:EVENT?

Function Queries the source event register and clears the register.

Syntax :STATus:SOURce:EVENT?
→ <Integer>

Example :STAT:SOUR:EVEN?

Description For details, see section 16.3.

:STATus:SOURce:ENABle

Function Sets the source event enable register or queries the current setting.

Syntax :STATus:SOURce:ENABle <Integer>|
<Binary/Octal/Hexadecimal>
:STATus:SOURce:ENABle?
→ <Integer>

Example :STAT:SOUR:ENAB 255
:STAT:SOUR:ENAB?

Description For details, see section 16.3.

:STATus:SENSe:CONDition?

Function Queries the measurement event condition register.

Syntax :STATus:SENSe:CONDition?
→ <Integer>

Example :STAT:SENS:COND?

Description For details, see section 16.3.

:STATus:SENSe:EVENT?

Function Queries the measurement event register and clears the register.

Syntax :STATus:SENSe:EVENT?
→ <Integer>

Example :STAT:SENS:EVEN?

Description For details, see section 16.3.

:STATus:SENSe:ENABle

Function Sets the measurement event enable register or queries the current setting.

Syntax :STATus:SENSe:ENABle <Integer>|
<Binary/Octal/Hexadecimal>
:STATus:SENSe:ENABle?
→ <Integer>

Example :STAT:SENS:ENAB 255
:STAT:SENS:ENAB?

Description For details, see section 16.3.

16.2.13 Common Command Group

***IDN?**

Function Queries the instrument model.
 Syntax *IDN?
 → Yokogawa Electric Co.,765501,serial
 number,firmware revision
 Example *IDN?

***OPT?**

Function Queries the options.
 Syntax *OPT?
 → NONE = No options
 /C10 = Ethernet option
 Example *OPT?

***TRG**

Function Generates a trigger.
 Syntax *TRG
 Example *TRG
 Description Carries out the same action as the trigger key on the GP-IB panel. The GP-IB GET (Group Execute Trigger) is also equivalent.

***CAL?**

Function Performs calibration and queries the result.
 Syntax *CAL?
 → 0 = Calibration successful
 Value other than 0 = Calibration failed
 Example *CAL?

***TST?**

Function Performs a self-test and queries the result.
 Syntax *TST?
 → 0 = Self-test normal
 Value other than 0 = Self test error
 Example *TST?

***RST**

Function Resets the GS610 to factory default settings.
 Syntax *RST
 Example *RST
 Description This command is equivalent to setting the file name of the :SYSTEM:SETup:LOAD command to "Default.txt."

***SAV**

Function Saves the settings.
 Syntax *SAV 1|2|3|4
 1 = Saves the settings as Setup 1.
 2 = Saves the settings as Setup 2.
 3 = Saves the settings as Setup 3.
 4 = Saves the settings as Setup 4.
 Example *SAV 3
 Description This command is equivalent to setting the file name of the :SYSTEM:SETup:SAVE command to "Setup1.txt" to "Setup4.txt."

***RCL**

Function Loads the saved settings.
 Syntax *RCL 1|2|3|4
 1 = Loads Setup 1.
 2 = Loads Setup 2.
 3 = Loads Setup 3.
 4 = Loads Setup 4.
 Example *RCL 3
 Description This command is equivalent to setting the file name of the :SYSTEM:SETup:LOAD command to "Setup1.txt" to "Setup4.txt."

***CLS**

Function Clears the event register and error queue.
 Syntax *CLS
 Example *CLS

***STB?**

Function Queries the status byte and clears the SRQ.
 Syntax *STB?
 → <Integer>
 Example *STB?
 Description For details, see section 16.3. GP-IB Serial polling carries out the same action as this command.

***SRE?**

Function Sets the service request enable register or queries the current setting.
 Syntax *SRE <Integer>|<Binary/Octal/Hexadecimal>
 *SRE?
 → <Integer>
 Example *SRE 255
 *SRE?
 Description For details, see section 16.3.

***ESR?**

Function Queries the standard event register and clears the register.
 Syntax *ESR?
 → <Integer>
 Example *ESR?
 Description For details, see section 16.3.

***ESE**

Function Sets the standard event enable register or queries the current setting.
 Syntax *ESE <Integer>|<Binary/Octal/Hexadecimal>
 *ESE?
 → <Integer>
 Example *ESE 255
 *ESE?
 Description For details, see section 16.3.

***OPC**

Function Generates a standard event OPC when the execution of all previous commands is completed.

Syntax *OPC

Example *OPC

***OPC?**

Function Queries the completion of the execution of all previous commands, and returns ASCII code "1" if it is.

Syntax *OPC?

→ 1

Example *OPC?

***WAI**

Function Waits for the completion of the overlap command.

Syntax *WAI

Example *WAI

Description The GS610 actually does nothing, because the GS610 does not support overlap commands.

16.3 Status Reports

16.3.1 Overview of the Status Report

Status Reports

The figure below shows the status report that is read by serial polling. This status report is an extended version of the status report defined in IEEE 488.2-1992.

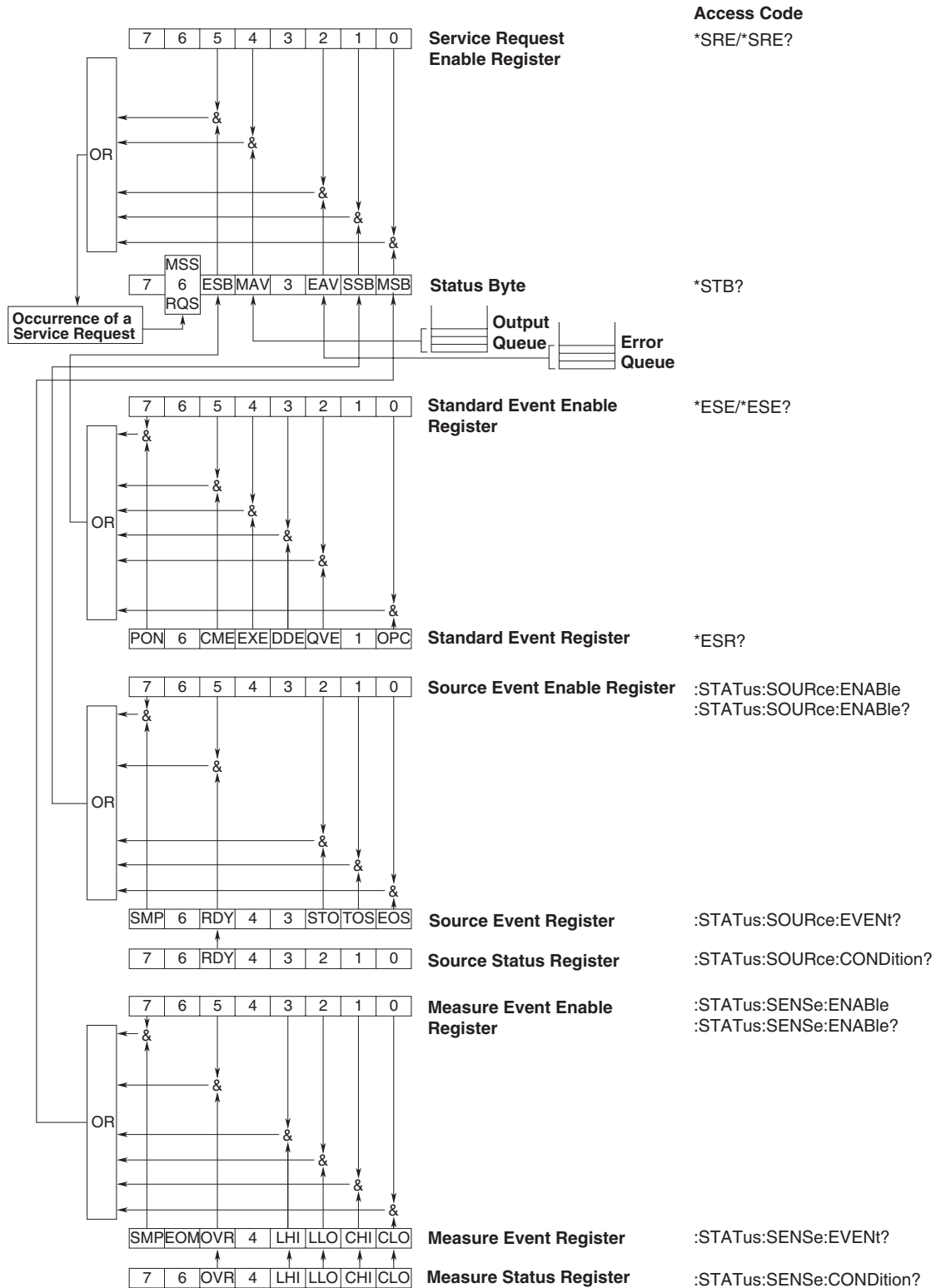

Registers and Queues That Affect the Status Byte

Registers that affect the bits of the status byte are shown below.

- Standard event register: Sets bit 5 (ESB) of the status byte to 1 or 0.
- Output queue: Sets bit 4 (MAV) of the status byte to 1 or 0.
- Source event register: Sets bit 1 (SSB) of the status byte to 1 or 0.
- Measure event register: Sets bit 0 (MSB) of the status byte to 1 or 0.
- Error queue: Sets bit 2 (EAV) of the status byte to 1 or 0.

Enable Registers

Registers that are used to mask a bit so that the bit will not affect the status byte even when it is set to 1, are shown below.

- Status byte: Mask the bits using the service request enable register.
- Standard event register: Mask the bits using the standard event enable register.
- Source event register: Mask the bits using the source event enable register.
- Measure event register: Mask the bits using the measure event enable register.

Writing/Reading from Registers

The *ESE command is used to set the bits in the standard event enable register to 1's or 0's. The *ESE? command is used to query whether the bits in the standard event enable register are 1's or 0's. For details regarding these commands, see section 16.2.13.

16.3.2 Status Byte

Status Byte

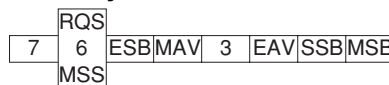

Bits 3 and 7

Not used (always 0)

Bit 0 MSB (Measure Event Summary Bit)

Set to 1 when the logical product of each bit of the measure event register and each bit of the corresponding enable register is 1. See the page 16-47.

Bit 1 SSB (Source Event Summary Bit)

Set to 1 when the logical product of each bit of the source event register and each bit of the corresponding enable register is 1. See the page 16-46.

Bit 2 EAV (Error Available)

Set to 1 when the error queue is not empty. In other words, this bit is set to 1 when an error occurs. See the page 16-48.

Bit 4 MAV (Message Available)

Set to 1 when the output queue is not empty. In other words, this bit is set to 1 when there is data to be transmitted. See the page 16-48.

Bit 5 ESB (Event Summary Bit)

Set to 1 when the logical product of each bit of the standard event register and each bit of the corresponding enable register is 1. See the page 16-44.

Bit 6 RQS (Request Service)/MSS (Master Status Summary)

Set to 1 when the logical AND of the status byte excluding bit 6 and the service request enable register is not 0. In other words, this bit is set to 1 when the instrument is requesting service from the controller. RQS is set to 1 when the MSS bit changes from 0 to 1, and cleared when serial polling is carried out or when the MSS bit changes to 0.

Bit Masking

To mask a bit in the status byte so that it does not cause an SRQ, set the corresponding bit of the service request enable register to 0.

For example, to mask bit 2 (EAV) so that service is not requested when an error occurs, set bit 2 of the service request enable register to 0. This can be done using the *SRE command. To query whether each bit of the service request enable register is 1 or 0, use *SRE?. For details on the *SRE command, see section 16.2.13.

Operation of the Status Byte

A service request is issued when bit 6 of the status byte becomes 1. Bit 6 is set to 1 when any of the other bits becomes a 1 (when the corresponding bit of the service request enable register is also set to 1).

For example, if an event takes place and the logical OR of each bit of the standard event register and the corresponding bit in the enable register is 1, bit 5 (ESB) will be set to 1. In this case, if bit 5 of the service request enable register is 1, bit 6 (MSS) will be set to 1, thus requesting service from the controller. It is also possible to check what type of event has occurred by reading the contents of the status byte.

Reading from the Status Byte

The following two methods are provided for reading the status byte.

Inquiry Using the *STB? Query

Making an inquiry using the *STB? query sets bit 6 to MSS. This causes the MSS to be read. After completion of the read-out, none of the bits in the status byte will be cleared.

Serial Polling

Execution of a serial polling changes bit 6 to RQS. This causes RQS to be read. After completion of the read-out, only RQS is cleared. It is not possible to read MSS using serial polling.

Clearing the Status Byte

No method is provided for forcibly clearing all the bits in the status byte. The bits that are cleared for each operation are shown below.

When a Query Is Made Using the *STB? Command

No bits are cleared.

When a Serial Polling Is Executed

Only the RQS bit is cleared.

When a *CLS Command Is Received

When the *CLS command is received, the status byte itself is not cleared, but the contents of the standard event register (which affects the bits in the status byte) are cleared. As a result, the corresponding bits in the status byte are cleared, except bit 4 (MAV), since the output queue cannot be emptied by the *CLS command. However, the output queue will also be cleared if the *CLS command is received just after a program message terminator.

16.3.3 Standard Event Register

Standard Event Register

7	6	5	4	3	2	1	0
PON	URQ	CME	EXE	DDE	QYE	RQC	OPC

Bit 7 PON (Power ON)

Set to 1 when the power is turned ON.

Bit 6 URQ (User Request)

Not used (always 0)

Bit 5 CME (Command Error)

Set to 1 when the command syntax is incorrect.

Example Incorrectly spelled command name; 9 used in octal data.

Bit 4 EXE (Execution Error)

Set to 1 when the command syntax is correct but the command cannot be executed in the current state.

Example Parameters are outside the range.

Bit 3 DDE (Device Error)

Set to 1 when execution of the command is not possible due to an internal problem in the instrument that is not a command error or an execution error.

Bit 2 QYE (Query Error)

Set to 1 if the output queue is empty or if the data is missing even after a query has been sent.

Example No response data; data is lost due to an overflow in the output queue.

Bit 1 RQC (Request Control)

Not used (always 0)

Bit 0 OPC (Operation Complete)

Set to 1 when the operation designated by the *OPC command (see section 16.2.13) has been completed.

Bit Masking

To mask a bit in the standard event register so that it does not cause bit 5 (ESB) of the status byte to change, set the corresponding bit in the standard event enable register to 0.

For example, to mask bit 2 (QYE) so that ESB will not be set to 1, even if a query error occurs, set bit 2 of the standard event enable register to 0. This can be done using the *ESE command. To inquire whether each bit of the standard event enable register is 1 or 0, use the *ESE?. For details on the *ESE command, see section 16.2.13.

Operation of the Standard Event Register

The standard event register is provided for eight different kinds of event which can occur inside the instrument. Bit 5 (ESB) of the status byte is set to 1 when any of the bits in this register becomes 1 (or when the corresponding bit of the standard event enable register becomes 1).

Example

1. A query error occurs.
2. Bit 2 (QYE) is set to 1.
3. Bit 5 (ESB) of the status byte is set to 1 if bit 2 of the standard event enable register is 1.

It is also possible to check what type of event has occurred inside the instrument by reading the contents of the standard event register.

Reading from the Standard Event Register

The contents of the standard event register can be read by the *ESR command. After the register is read, it is cleared.

Clearing the Standard Event Register

The standard event register is cleared in the following three cases.

- When the contents of the standard event register are read using the *ESR command.
- When a *CLS command is received.
- When the instrument is power cycled.

16.3.4 Source Event Register

Source Event Register

Status Register
:STATus:SOURce:CONDition?

7	6	5	4	3	2	1	0
		RDY					

Event Register
:STATus:SOURce:EVENT?

7	6	5	4	3	2	1	0
SMP		RDY			STO	TOS	EOS

Bit 7 SMP (Sampling Error)

Set to 1 when a sampling error (trigger is applied before the completion of the source measure cycle) occurs.

Bit 6

Not used (always 0)

Bit 5 RDY (Sweep Ready)

The bit in the condition register is set to 0 when sweep mode is enabled, when the LIN/LOG sweep parameter is changed, or while the program pattern file is being loaded. It is set to 1 when the GS610 is ready to receive sweep start. The bit in the event register is set to 1 when the condition register bit changes from 0 to 1.

Bit 4

Not used (always 0)

Bit 3

Not used (always 0)

Bit 2 STO (Store Complete)

Set to 1 when the storage operation completes.

Bit 1 TOS (Turn of Sweep)

Set to 1 each time a turn of the sweep operation completes.

Bit 0 EOS (End of Sweep)

Set to 1 when the entire sweep operation completes.

Bit Masking

To mask a bit in the source event register so that it does not cause bit 1 (SSB) of the status byte to change, set the corresponding bit in the source event enable register to 0. Use the :STATus:SOURce:ENABLE command for this purpose.

Reading from the Source Event Register

The contents of the source event register can be read by the :STATus:SOURce:EVENT? command. After the register is read, it is cleared. The contents of the source condition register can be read by the :STATus:SOURce:CONDition? command. Reading the register does not change the contents of the register.

Clearing the Source Event Register

The source event register is cleared in the following three cases.

- When the contents of the source event register is read by the :STATus:SOURce:EVENT? command.
- When a *CLS command is received.
- When the instrument is power cycled.

16.3.5 Measure Event Register

Measure Event Register

Status Register

:STATus:SENSe:CONDition?

7	6	5	4	3	2	1	0
		OVR		LHI	LLO	CHI	CLO

Event Register

:STATus:SENSe:EVENT?

7	6	5	4	3	2	1	0
SMPE	EOM	OV	R	LHI	LLO	CHI	CLO

Bit 7 SMP (Sampling Error)

Set to 1 when a sampling error (trigger is applied before the completion of the source measure cycle) occurs.

Bit 6 EOM (End of Measurement)

When the measurement is completed, the event register bit is set to 1.

Bit 5 OVR (Over Range)

The bit in the condition register is set to 1 when a measurement overrange occurs and reset to 0 when overrange is corrected. The bit in the event register is set to 1 when the condition register bit changes from 0 to 1.

Bit 4

Not used (always 0)

Bit 3 LHI (High Limiting)

The bit in the condition register is set to 1 when the high limiter is activated and set to 0 when is deactivated. The bit in the event register is set to 1 when the condition register bit changes from 0 to 1.

Bit 2 LLO (Low Limiting)

The bit in the condition register is set to 1 when the low limiter is activated and set to 0 when is deactivated. The bit in the event register is set to 1 when the condition register bit changes from 0 to 1.

Bit 1 CHI (Compare High)

The bit in the condition register is set to 1 when the comparison result is high and set to 0, otherwise. The bit in the event register is set to 1 when the condition register bit changes from 0 to 1.

Bit 0 CLO (Compare Low)

The bit in the condition register is set to 1 when the comparison result is low and set to 0, otherwise. The bit in the event register is set to 1 when the condition register bit changes from 0 to 1.

Bit Masking

To mask a bit in the measure event register so that it does not cause bit 1 (MSB) of the status byte to change, set the corresponding bit in the measure event enable register to 0. Use the :STATus:SENSe:ENABle command for this purpose.

Reading from the Measure Event Register

The contents of the measure event register can be read by the :STATus:SENSe:EVENT? command. After the register is read, it is cleared. The contents of the measure condition register can be read by the :STATus:SENSe:CONDition? command. Reading the register does not change the contents of the register.

Clearing the Measure Event Register

The measure event register is cleared in the following three cases.

- When the contents of the source event register is read by the :STATus:SENSe:EVENT? command.
- When a *CLS command is received.
- When the instrument is power cycled.

16.3.6 Output Queue and Error Queue

Output Queue

The output queue is provided to store response messages to queries.

The example below shows that data is stored record by record in the output queue, and is read out oldest item first. The output queue is emptied in the following cases (in addition to when read-out is performed).

- When a new message is received from the controller.
- When a deadlock occurs (see page 16-3).
- When a device clear command (DCL or SDC) is received.
- When the instrument is power cycled.

The output queue cannot be emptied using the *CLS command. To see whether the output queue is empty or not, check bit 4 (MAV) of the status byte.

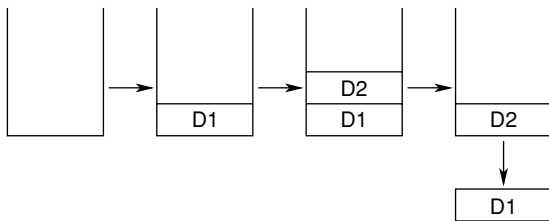

Error Queue

The error queue stores the error No. and message when an error occurs. For example, if the controller sends an incorrect program message, the error number and message “-113, “Undefined header”” are stored in the error queue when the error is displayed. The contents of the error queue can be read using the SYSTem:ERRor? query. As with the output queue, the messages are read from the oldest ones first.

When the error queue overflows, the last message is replaced by the message “-350, “Queue overflow.”

The error queue is emptied in the following cases (in addition to when read-out is performed).

- When a *CLS command is received.
 - When the instrument is power cycled.
- To see whether the error queue is empty or not, check bit 2 (EAV) of the status byte.

16.4 Sample Programs

Notes on Using the Sample Programs

Yokogawa Electric Corporation assumes no liability for any problems that may occur as a result of using the sample programs.

16.4.1 Before Programming

Applicable Model and Language

Model: Windows PC
Language: Visual Basic Version 5.0 Professional Edition or later.
GPIB board: AT-GPIB/TNT IEEE-488.2 by National Instruments.

Setting Up Visual Basic

Standard modules used: Niglobal.bas
Vbib-32.bas

Setting Up the GS610

GP-IB

The sample programs given in this chapter use a GP-IB address of 1 for the GS610. Set the GP-IB address to 1 according to the procedures described in section 13.4. Or, change the ADDRESS definition in GpibLib.bas.

16.4.2 GP-IB Access Function

```

Attribute VB_Name = "GpibLib"
'=====
'
' GPIB Access Function
'
' Board:          AT-GPIB/TNT IEEE488.2 by National Instruments.
'
' Used modules:   Niglobal.bas and Vbib-32.bas by National Instruments
'
'=====
'-----
'
' Constant declaration Change them as necessary.
'
'-----

Const BOARD_ID = 0      ' GPIB board ID
Const ADDRESS = 1      ' GS610 GPIB address
Const TIMEOUT = T1s    ' Timeout value

'-----
'
' Access Functions
'
'-----

' Open function
Function CommOpen() As Integer
    Dim dev As Integer
    dev = ildev(BOARD_ID, ADDRESS, 0, TIMEOUT, 1, XEOS + REOS + &HA)
    If (dev >= 0) Then Call CommClear(dev)
    CommOpen = dev
End Function

' Close function
Sub CommClose(dev As Integer)
    Call ilonl(dev, 0)
End Sub

' Send function
Function CommSend(dev As Integer, msg As String) As Integer
    If (ilwrt(dev, msg + Chr$(10), Len(msg) + 1) And (EERR Or TIMO)) Then
        CommSend = -1
    Else
        CommSend = ibcntl
    End If
End Function

' Receive function
Function CommRecv(dev As Integer, msg As String) As Integer
    Dim ret As Integer
    ret = ilrd(dev, msg, Len(msg))
    If (ret And TIMO) Then
        CommClear (dev)
        CommRecv = -1
    Else
        If (ret And EERR) Then
            CommRecv = -1
        Else
            CommRecv = ibcntl
        End If
    End If
End Function

```

```

' Query function
Function CommQuery(dev As Integer, snd_msg As String) As String
    Dim rcv_msg As String * 64
    Dim ret As Integer
    ret = CommSend(dev, snd_msg)
    If (ret < 0) Then
        CommQuery = "ERROR"
    Else
        ret = CommRecv(dev, rcv_msg)
        If (ret <= 0) Then
            CommQuery = "ERROR"
        Else
            CommQuery = Left$(rcv_msg, ret - 1)
        End If
    End If
End Function

' Device clear
Sub CommClear(dev As Integer)
    ilclr dev
End Sub

' Serial polling
Function CommPoll(dev As Integer) As Integer
    Dim ret As Integer
    If (ilrsp(dev, ret) And EERR) Then
        CommPoll = -1
    Else
        CommPoll = ret
    End If
End Function

' Read the source status
Function CommSourceStatus(dev As Integer) As Integer
    Dim msg As String * 64
    msg = CommQuery(dev, ":STAT:SOUR:COND?")
    If (msg = "ERROR") Then
        CommSourceStatus = -1
    Else
        CommSourceStatus = Val(msg)
    End If
End Function

' Read the source event
Function CommSourceEvent(dev As Integer) As Integer
    Dim msg As String * 64
    msg = CommQuery(dev, ":STAT:SOUR:EVEN?")
    If (msg = "ERROR") Then
        CommSourceEvent = -1
    Else
        CommSourceEvent = Val(msg)
    End If
End Function

' Read the measure status
Function CommMeasureStatus(dev As Integer) As Integer
    Dim msg As String * 64
    msg = CommQuery(dev, ":STAT:SENS:COND?")
    If (msg = "ERROR") Then
        CommMeasureStatus = -1
    Else
        CommMeasureStatus = Val(msg)
    End If
End Function

```

16.4 Sample Programs

```
' Read the measure event
Function CommMeasureEvent(dev As Integer) As Integer
    Dim msg As String * 64
    msg = CommQuery(dev, ":STAT:SENS:EVEN?")
    If (msg = "ERROR") Then
        CommMeasureEvent = -1
    Else
        CommMeasureEvent = Val(msg)
    End If
End Function
```

16.4.3 Sample 1 (Example of Reading the Measured Results during Free Run Using Internal Trigger)

```

Attribute VB_Name = "Sample1"
'=====
'
' Sample 1 (Example of Reading the Measured Results during Free Run Using Internal
Trigger)
'
' CALL SampleSequence1().
'
'=====

'-----
'
' Setup 1
'
' <Source setting>
' Source function:      Current
' Source range setting: 1 A
' Limiter:             ±250 mV
' Source level:        0.33333 A
'
' <Measurement setting>
' Measurement:         ON
' Measurement function: Voltage
' Integration time:    1PLC
' Auto zero:          ON
'
' <Trigger setting>
' Trigger source:      Internal trigger 100 ms period
' Source delay:        Minimum (= 1 us)
' Measurement delay:   Minimum (= 1 us)
'
' Output:              ON
'-----

Function Setup1(dev As Integer)

    Call CommSend(dev, "*RST")           ' Reset to factory default
settings

    Call CommSend(dev, ":SOUR:FUNC CURR") ' Source function Current
    Call CommSend(dev, ":SOUR:CURR:RANG 1A") ' Source range setting 1 A
    Call CommSend(dev, ":SOUR:VOLT:PROT:LINK ON") ' Limiter tracking ON
    Call CommSend(dev, ":SOUR:VOLT:PROT:ULIM 250mV") ' Limiter 250 mV
    Call CommSend(dev, ":SOUR:VOLT:PROT:STAT ON") ' Limiter ON
    Call CommSend(dev, ":SOUR:CURR:LEV 0.33333A") ' Source level 0.33333 A

    Call CommSend(dev, ":SENS:STAT ON") ' Measurement ON
    Call CommSend(dev, ":SENS:FUNC VOLT") ' Measurement function Voltage
    Call CommSend(dev, ":SENS:ITIM PLC") ' Integration time 1PLC
    Call CommSend(dev, ":SENS:AZER:STAT ON") ' Auto zero ON

    Call CommSend(dev, ":TRIG:SOUR TIM") ' Trigger source Internal timer
    Call CommSend(dev, ":TRIG:TIM 100ms") ' Internal timer period 100 ms
    Call CommSend(dev, ":SOUR:DEL MIN") ' Source delay Minimum
    Call CommSend(dev, ":SENS:DEL MIN") ' Measurement delay Minimum

    Call CommSend(dev, ":OUTP:STAT ON") ' Output ON

End Function

```

16.4 Sample Programs

```
' _____  
'  
' Read the measured result  
'  
' Free run using internal trigger  
'  
' _____  
  
Function ReadAsString(dev As Integer) As String ' String output  
  
    ReadAsString = CommQuery(dev, ":READ?")  
  
End Function  
  
Function ReadAsDouble(dev As Integer) As Double ' Real number output  
  
    ReadAsDouble = Val(ReadAsString(dev))  
  
End Function  
  
' _____  
'  
' Sample Sequence 1  
'  
' Set the GS610 to Setup 1, read 10 result values in an array, and turn the output  
' OFF  
'  
' _____  
  
Function SampleSequence1()  
    Dim dev As Integer  
    Dim result(10) As Double  
    Dim i As Integer  
  
    dev = CommOpen() ' Open the device  
  
    Call Setup1(dev) ' Set to Setup 1  
  
    For i = 0 To 9 ' Loop 10 times  
        result(i) = ReadAsDouble(dev) ' Read the result and substitute  
                                     into an array  
    Next i  
  
    Call CommSend(dev, ":OUTP:STAT OFF") ' Turn the output OFF  
  
    Call CommClose(dev) ' Close the device  
  
End Function
```

16.4.4 Sample 2 (Example of generating a trigger from the PC and reading the measured results)

```

Attribute VB_Name = "Sample2"
'=====
'
' Sample 2 (Example of generating a trigger from the PC and reading the measured
results)
'
' CALL SampleSequence2().
'
'=====

'-----
'
' Setup 2
'
' <Source setting>
' Source function:      Voltage
' Source range setting: 20 V
' Limiter:             ±50 mA
' Source level:        -17.5 V
'
' <Measurement Setup>
' Measurement:         ON
' Measurement function: Current
' Integration time:    Minimum (= 250 us)
' Auto zero:          OFF
'
' <Trigger setting>
' Trigger source:      External trigger
' Source delay:        Minimum (= 1 us)
' Measurement delay:   1 ms
'
' Output:              ON
'-----

Function Setup2(dev As Integer)

    Call CommSend(dev, "*RST")           ' Reset to factory default
settings

    Call CommSend(dev, ":SOUR:FUNC VOLT") ' Source function Voltage
    Call CommSend(dev, ":SOUR:VOLT:RANG 20V") ' Source range setting 20 V
    Call CommSend(dev, ":SOUR:CURR:PROT:LINK ON") ' Limiter tracking ON
    Call CommSend(dev, ":SOUR:CURR:PROT:ULIM 50mA") ' Limiter 50 mA
    Call CommSend(dev, ":SOUR:CURR:PROT:STAT ON") ' Limiter ON
    Call CommSend(dev, ":SOUR:VOLT:LEV -17.5V") ' Source level -17.5 V

    Call CommSend(dev, ":SENS:STAT ON") ' Measurement ON
    Call CommSend(dev, ":SENS:FUNC CURR") ' Measurement function Current
    Call CommSend(dev, ":SENS:ITIM MIN") ' Integration time Minimum
    Call CommSend(dev, ":SENS:AZER:STAT OFF") ' Auto zero OFF

    Call CommSend(dev, ":TRIG:SOUR EXT") ' Trigger source External trigger
    Call CommSend(dev, ":SOUR:DEL MIN") ' Source delay Minimum
    Call CommSend(dev, ":SENS:DEL 1ms") ' Measure delay 1 ms

    Call CommSend(dev, ":OUTP:STAT ON") ' Output ON

End Function

```

16.4 Sample Programs

```
' _____
'
' Generate triggers and read the measured results
'
' Generate triggers from a PC and read the results
'
' _____

Function TrigReadAsString(dev As Integer) As String      ' String output

    TrigReadAsString = CommQuery(dev, ":INIT;*TRG;*FETC?")

End Function

Function TrigReadAsDouble(dev As Integer) As Double     ' Real number output

    TrigReadAsDouble = Val(TrigReadAsString(dev))

End Function

' _____
'
' Sample Sequence 2
'
' Set the GS610 to Setup 2 and vary the source level as follows: 2.8 V, 2.9 V,
' 3.0 V, 3.1 V, and 3.2 V. Then, generate a trigger, read the results, and turn
' the output OFF.
'
' _____

Function SampleSequence2()
    Dim dev As Integer
    Dim result(5) As Double

    dev = CommOpen()                                ' Open the device

    Call Setup2(dev)                                ' Set to Setup 2

    Call CommSend(dev, ":SOUR:VOLT:LEV 2.8")        ' Set the level to 2.8 V
    result(0) = TrigReadAsDouble(dev)              ' Generate a trigger and read the
                                                    ' result

    Call CommSend(dev, ":SOUR:VOLT:LEV 2.9")        ' Set the level to 2.9 V
    result(1) = TrigReadAsDouble(dev)              ' Generate a trigger and read the
                                                    ' result

    Call CommSend(dev, ":SOUR:VOLT:LEV 3.0")        ' Set the level to 3.0 V
    result(2) = TrigReadAsDouble(dev)              ' Generate a trigger and read the
                                                    ' result

    Call CommSend(dev, ":SOUR:VOLT:LEV 3.1")        ' Set the level to 3.1 V
    result(3) = TrigReadAsDouble(dev)              ' Generate a trigger and read the
                                                    ' result

    Call CommSend(dev, ":SOUR:VOLT:LEV 3.2")        ' Set the level to 3.2 V
    result(4) = TrigReadAsDouble(dev)              ' Generate a trigger and read the
                                                    ' result

    Call CommSend(dev, ":OUTP:STAT OFF")           ' Turn the output OFF

    Call CommClose(dev)                             ' Close the device

End Function
```

16.4.5 Sample 3 (Example of Updating the Source Level from a PC)

```

Attribute VB_Name = "Sample3"
'=====
'
' Sample 3 (Example of Updating the Source Level from a PC)
'
' CALL SampleSequence3().
'
'=====

'-----
'
' Setup 3
'
' <Source setting>
' Source function:      Voltage
' Source range setting: 30 V
' Limiter:             ±0.5 A
' Source level:        0 V
'
' <Measurement Setup>
' Measurement:         OFF
'
' <Trigger setting>
' Trigger source:      Internal trigger 500 us period
' Source delay:        Minimum (= 1 us)
'
' Output:              ON
'-----

Function Setup3(dev As Integer)

    Call CommSend(dev, "*RST")           ' Reset to factory default
settings

    Call CommSend(dev, ":SOUR:FUNC VOLT") ' Source function Voltage
    Call CommSend(dev, ":SOUR:VOLT:RANG 30V") ' Source range setting 30 V
    Call CommSend(dev, ":SOUR:CURR:PROT:LINK ON") ' Limiter tracking ON
    Call CommSend(dev, ":SOUR:CURR:PROT:ULIM 0.5A") ' Limiter 0.5 A
    Call CommSend(dev, ":SOUR:CURR:PROT:STAT ON") ' Limiter ON
    Call CommSend(dev, ":SOUR:VOLT:LEV 0V") ' Source level 0 V

    Call CommSend(dev, ":SENS:STAT OFF") ' Measurement OFF

    Call CommSend(dev, ":TRIG:SOUR TIM") ' Trigger source Internal timer
    Call CommSend(dev, ":TRIG:TIM 500E-6") ' Internal timer period 500 us
    Call CommSend(dev, ":SOUR:DEL MIN") ' Source delay Minimum

    Call CommSend(dev, ":OUTP:STAT ON") ' Output ON

End Function

'-----
'
' Sample Sequence 3
'
' Set the GS610 to Setup 3, change the source level from 15 V to 30 V in 1 V steps,
and turn the output OFF.
'
'-----

```

16.4 Sample Programs

```
Function SampleSequence3()
  Dim dev As Integer

  dev = CommOpen()                ' Open the device

  Call Setup3(dev)                ' Set to Setup 3

  For i = 15 To 30                ' Change the level
    Call CommSend(dev, ":SOUR:VOLT:LEV " + CStr(i)) ' from 15 V to 30 V
    Sleep (1000)                  ' 1 s wait
  Next

  Call CommSend(dev, ":OUTP:STAT OFF") ' Turn the output OFF
  Call CommClose(dev)             ' Close the device

End Function
```

16.4.6 Sample 4 (Example of Updating the Source Level with the Sweep Function)

```

Attribute VB_Name = "Sample4"
'=====
'
' Sample 4 (Example of Updating the Source Level with the Sweep Function)
'
' CALL SampleSequence4().
'
'=====

'-----
'
' Setup 4
'
'
' <Source setting>
' Source mode:                Pulse
' Sweep:                      ON
' Source function:            Voltage
' Source range setting:       12 V
' Limiter:                   OFF
' Source level:               0 V
'
' <Pulse settings>
' Pulse base:                 -10 V
' Pulse width:                500 us
'
' <Sweep setting>
' Type:                      Linear
' Range:                      0 V to 10 V 0.1 V steps
' Sweep count:                1
' Level after the sweep operation: Reset to the initial level
'
' <Measurement setting>
' Measurement:                OFF
'
' <Trigger setting>
' Trigger source:             Internal trigger 10 ms period
' Source delay:               Minimum (= 1 us)
'
' Output:                     ON
'-----

Function Setup4(dev As Integer)

    Call CommSend(dev, "*RST")           ' Reset to factory default
settings

    Call CommSend(dev, ":SOUR:SHAP PULS") ' Pulse source mode
    Call CommSend(dev, ":SOUR:MODE SWE")  ' Sweep mode
    Call CommSend(dev, ":SOUR:FUNC VOLT")  ' Source function Voltage
    Call CommSend(dev, ":SOUR:VOLT:RANG 12") ' Source range setting 12 V
    Call CommSend(dev, ":SOUR:CURR:PROT:STAT OFF") ' Limiter OFF
    Call CommSend(dev, ":SOUR:VOLT:LEV 0V") ' Source level 0 V

    Call CommSend(dev, ":SOUR:VOLT:PBAS -10.0V") ' Pulse base -10 V
    Call CommSend(dev, ":SOUR:PULS:WIDT 500us") ' Pulse width 500 us

    Call CommSend(dev, ":SOUR:VOLT:SWE:SPAC LIN") ' Linear sweep
    Call CommSend(dev, ":SOUR:VOLT:SWE:STAR 0") ' Start 0 V
    Call CommSend(dev, ":SOUR:VOLT:SWE:STOP 10") ' Stop 10 V
    Call CommSend(dev, ":SOUR:VOLT:SWE:STEP 0.1") ' Step 0.1 V
    Call CommSend(dev, ":SWE:COUN 1") ' Sweep count 1
    Call CommSend(dev, ":SWE:LAST RET") ' Level after the sweep operation
Initial level

```

16.4 Sample Programs

```
        Call CommSend(dev, ":SENS:STAT OFF")           ' Measurement OFF

        Call CommSend(dev, ":TRIG:SOUR TIM")           ' Trigger source Internal timer
        Call CommSend(dev, ":TRIG:TIM 10ms")          ' Internal timer period 10 ms
        Call CommSend(dev, ":SOUR:DEL MIN")           ' Source delay Minimum

        Call CommSend(dev, ":OUTP:STAT ON")           ' Output ON

End Function

' _____
'
' Wait for the completion of the sweep computation
'
' Wait until bit 5 (RDY) of the source status is set to 1
'
' _____

Function WaitSweepCalculate(dev As Integer)

    While ((CommSourceStatus(dev) And &H20) = 0)
        Sleep (10)
    Wend

End Function

' _____
'
' Wait for the completion of the sweep operation
'
' Wait until bit 0 (EOS) of the source event is set to 1
'
' _____

Function WaitSweepEnd(dev As Integer)

    While ((CommSourceEvent(dev) And &H1) = 0)
        Sleep (10)
    Wend

End Function

' _____
'
' Sample Sequence 4
'
' Set the GS610 to Setup 4 and start the sweep operation when the sweep computation
' is complete
' After starting, turn the output OFF when the sweep operation is complete
'
' _____

Function SampleSequence4()
    Dim dev As Integer

    dev = CommOpen()           ' Open the device

    Call Setup4(dev)           ' Set to Setup 4

    Call WaitSweepCalculate(dev) ' Wait for the completion of the
                                sweep computation

    Call CommSend(dev, "*CLS") ' Clear all events

    Call CommSend(dev, ":SWE:TRIG") ' Start the sweep operation

    Call WaitSweepEnd(dev)     ' Wait for the completion of the
                                sweep operation
```

```
Call CommSend(dev, ":OUTP:STAT OFF")      ' Turn the output OFF
Call CommClose(dev)                       ' Close the device
End Function
```

16.4.7 Sample 5 (Example of Carrying Out the Storage Function and Reading the Statistical Values)

```

Attribute VB_Name = "Sample5"
'=====
'
' Sample 5 (Example of Carrying Out the Storage Function and Reading the
' Statistical Values)
'
' CALL SampleSequence5().
'=====

'-----
'
' Wait for the storage operation to complete
'
' Wait for the result of :TRACe:STATus? to become 0
'
'-----

Function WaitStoreComplete(dev As Integer)

    While (Val(CommQuery(dev, ":TRAC:STAT?"))
        Sleep (10)
    Wend

End Function

'-----
'
' Sample Sequence 5
'
' Store 100 points and read the statistical result
'
' This sample does not set the source and measurement. Set them appropriately in
' advance.
'
'-----

Function SampleSequence5()
    Dim dev As Integer
    Dim r_min As Double
    Dim r_max As Double
    Dim r_ave As Double
    Dim r_sdv As Double

    dev = CommOpen()                ' Open the device

    Call CommSend(dev, ":TRAC:POIN 100")    ' Store count 100

    Call CommSend(dev, ":TRAC:STAT ON")    ' Start the storage operation

    Call WaitStoreComplete(dev)           ' Wait for the storage operation
                                           to complete

    r_min = Val(CommQuery(dev, ":TRAC:CALC:MIN?")) ' Read the minimum value
    r_max = Val(CommQuery(dev, ":TRAC:CALC:MAX?")) ' Read the maximum value
    r_ave = Val(CommQuery(dev, ":TRAC:CALC:AVER?")) ' Read the average value
    r_sdv = Val(CommQuery(dev, ":TRAC:CALC:SDEV?")) ' Read the standard deviation

    Call CommClose(dev)                ' Close the device

End Function

```

16.5 ASCII Character Codes

The following table shows the ASCII character codes.

	0	1	2	3	4	5	6	7
0	0 NUL	20 DEL	40 SP	60 0	100 @	120 P	140 '	160 p
1	1 SOH	21 DC1	41 !	61 1	101 A	121 Q	141 a	161 q
2	2 STX	22 DC2	42 "	62 2	102 B	122 R	142 b	162 r
3	3 ETX	23 DC3	43 #	63 3	103 C	123 S	143 c	163 s
4	4 EOT	24 DC4	44 \$	64 4	104 D	124 T	144 d	164 t
5	5 ENQ	25 NAK	45 %	65 5	105 E	125 U	145 e	165 u
6	6 ACK	26 SYN	46 &	66 6	106 F	126 V	146 f	166 v
7	7 BEL	27 ETB	47 ,	67 7	107 G	127 W	147 g	167 w
8	10 BS	30 CAN	50 (70 8	110 H	130 X	150 h	170 x
9	11 HT	31 EM	51)	71 9	111 I	131 Y	151 i	171 y
A	12 LF	32 SUB	52 *	72 :	112 J	132 Z	152 j	172 z
B	13 VT	33 ESC	53 +	73 ;	113 K	133 [153 k	173 {
C	14 FF	34 FS	54 ,	74 <	114 L	134 \	154 l	174
D	15 CR	35 GS	55 -	75 =	115 M	135]	155 m	175 }
E	16 SO	36 RS	56 .	76 >	116 N	136 ^	156 n	176 ~
F	17 SI	37 US	57 /	77 ?	117 O	137 _	157 o	177 DEL (RUBOUT)
	Address Command	Universal Command	Listener Address	Talker Address	Secondary Command			

Example



17.1 Troubleshooting

- For the appropriate corrective actions when an error code is shown on the display, see section 17.2.
- If servicing is necessary, or if the instrument is not operating correctly after performing the corrective actions described below, contact your nearest YOKOGAWA dealer.

Problem	Probable Cause	Corrective Action	Reference Section
The power does not turn ON.	Using a power supply outside the ratings.	Use a correct power supply.	3.3
The GS610 does not power up correctly.	The setup file is corrupt.	If the GS610 still does not power up correctly even after cycling the power, turn ON the power while holding down the ESC key and +/- key. The GS610 powers up by forcibly formatting the GS610ROM disk. If the GS610 still does not power up correctly, servicing is required.	-
Nothing is displayed.	The display is turned OFF.	If the SHIFT key is blinking, the display is turned OFF. Press any key or turn the rotary knob.	11.5
Keys do not work.	The GS610 is in remote mode.	The GS610 is in remote mode when the remote indicator is illuminated. Press the MISC key to enter the LOCAL mode.	-
	The keys are locked.	If the KEYLOCK indicator is illuminated, the keys are locked. Press the SHIFT+TIME key to clear the key lock.	11.7
	Other causes.	If a certain key does not work, it may be due to a bad connection. Perform a key test of the self test. If there are keys that do not operate, servicing is required.	17.3
The USB storage function does not work.	The GS610ROM disk is corrupt.	If only the GS610RAM disk appears on the PC, the GS610ROM disk may be corrupt. Format the disk.	4.3
	The drive assignment on the PC overlaps with another drive.	Use a management tool on the PC and change the drive letter so that it does not overlap with other drives.	-
	The PC does not support the USB mass storage class.	The USB storage function is valid on Windows Me, 2000, and XP. The USB storage function cannot be used on PCs running other operating systems.	-
The file written from the PC cannot be viewed on the GS610.	The file is written only to the PC cache memory.	Carry out "Safely remove USB Mass Storage Device" on the PC to make sure that the cache is written to the storage device.	-
The source value or measured value is odd.	Insufficient warm-up.	Warm up the GS610 for 60 minutes after turning ON the power.	-
	The ambient temperature is fluctuating.	Use the GS610 in a stable environment within the specification range.	-
	The signal contains noise.	Use the GS610 in an environment free of noise. Exercise caution especially when handling minute voltage or current. The measured value stabilizes when the integration time is increased.	7.5
	The GS610 is oscillating.	Check whether the load is within the allowable range. Use twisted-pair wires for wiring.	3.5
	The connection is inappropriate.	In the case of a four-terminal connection, check that the connection is correct. Note that in the case of a two-terminal connection, the GS610 receives effects from the lead wire resistance or contact resistance when the output current is large.	3.5

17.1 Troubleshooting

Problem	Probable Cause	Corrective Action	Reference Section
Unable to save data to the disk.	No free space on the disk.	Delete unneeded files or format the disk.	4.3
Unable to set the GS610 via the communication interface.	Communication settings are not matched.	Match the communication settings with the PC.	Chapters 12 to 15

17.2 Error Code Description and Corrective Action

The following two types of messages can appear in the center of the screen.

- Error messages
Displayed when an inappropriate operation is carried out.
- Confirmation messages
Confirmation messages are not entered in the error queue, but displayed in the error log.

Syntax Errors (-100 to -199)

Error No.	Error Message	Corrective Action	Page
-101	Invalid_character	Check whether invalid characters such as \$ or & are used in the command header or parameters.	-
-102	Syntax_error	Check that the syntax is correct.	-
-103	Invalid separator	Check the use of the separator (comma).	-
-106	Parameter not allowed	Check the command and the number of parameters.	-
-107	Missing parameter	Check the command and the number of parameters.	-
-112	Program mnemonic too long	Check the command mnemonic.	-
-113	Undefined header	Check the command mnemonic.	-
-121	Invalid character in number	Check that the notation of the numeric parameter is correct (for example, binary notation should not contain characters other than 0 and 1).	16-5
-122	Header suffix out of range	Check whether the numeric suffix of the command header is correct.	-
-123	Exponent too large	Check whether the exponent is within the range of -127 to 127.	-
-124	Too many digits	Check that the number of digits in the value does not exceed 255.	-
-128	Numeric data not allowed	Check the parameter format.	-
-131	Invalid suffix	Check the unit that can be used for the parameter.	-
-138	Suffix not allowed	Check the parameter format.	-
-141	Invalid character data	Check the character data that can be used for the parameter.	-
-148	Character data not allowed	Check the command and parameter format.	-
-150	String data error	Check that the closing quotation mark (" or ') for a string is available.	-
-151	Invalid string data	Check that the string parameter is in the correct format.	-
-158	String data not allowed	Check the command and parameter format.	-
-161	Invalid block data	Check that the block data is in the correct format.	-
-168	Block data not allowed	Check the command and parameter format.	-
-178	Expression data not allowed	Check the command and parameter format.	-

17.2 Error Code Description and Corrective Action

Errors in Execution (-200 to -299)

Error No.	Error Message	Corrective Action	Page
-221	Setting conflict	The following four setting conflicts are possible. <ul style="list-style-type: none">• Pulse source and block average• Pulse source and auto measurement range• The source and measurement are set to the same function and using auto measurement range• Limiter tracking OFF and auto measurement range Change the settings so that these conflicts do not occur.	-
-222	Data out of range	Check the selectable range of the parameter. If the command can use MINimum and MAXimum as its parameter, the range can also be queried.	-
-256	Filename not found	Check that the file exists. You can also use the CATalog? command to query the list of files.	16-16, 16-27, 16-34
-285	Program syntax error	Check that the sweep pattern file is in the correct format.	6-11

Device Errors (-300 to -399)

Error No.	Error Message	Corrective Action	Page
-350	Queue overflow	Read the error using :SYSTem:ERRor? or clear the error queue using *CLS.	16-35, 16-40
-361	Parity error	Check that the communication settings on the GS610 and PC match. If the settings are correct, check the cable, and lower the baud rate.	14-6
-362	Framing error	Check that the communication settings on the GS610 and PC match. If the settings are correct, check the cable, and lower the baud rate.	14-6
-363	Input buffer overrun	Set the handshaking to a setting other than OFF. Lower the baud rate.	14-6

Query Errors (-400 to -499)

Error No.	Error Message	Corrective Action	Page
-410	Query INTERRUPTED	Check transmission/reception procedure.	16-3
-420	Query UNTERMINATED	Check transmission/reception procedure.	16-3
-430	Query DEADLOCK	Keep the program message shorter than or equal to 64 KB.	16-3

Instrumental Errors (+100 and up)

Error No.	Error Message	Corrective Action	Page
+100	Expression syntax error	Check that the syntax of the MATH definition file is correct.	App-1
+101	Too complex expression	Keep the total number of constants, variables, and operators in a MATH definition less than or equal to 256. Keep the total number of constants, variables, and operators in all MATH definitions less than or equal to 1024.	App-1
+201	Interlocking	Release the interlock, and then turn the output ON.	-
+202	Hardware abnormal	Wait for the temperature inside the case to become normal, and turn the output ON.	-
+203	Sweep running	Stop the sweep operation before changing the settings.	-
+300	Hardware input abnormal error	Check the input.	-
+301	Low battery	Request to have the battery replaced, because the time stamp when creating files will not be correct.	17-11

Messages (Messages That Are Not Entered in the Error Queue but Displayed in the Error Log)

Error Message	Corrective Action	Page
Log sweep zero cross	Set the start and stop values with values with the same sign.	6-2
Log sweep start level illegal	Set the start value to a value other than 0.	6-2
Log sweep stop level illegal	Set the stop value to a value other than 0.	6-2
Outside of number of trigger count	Increase the step value so that the number of points is less than or equal to 65535.	6-3
Cannot execute measure auto ranging	Correct the setting conflict (see -221 Setting conflict).	-
Cannot average with block mode	Correct the setting conflict (see -221 Setting conflict).	-
Illegal compare level	Set the comparison operation settings so that the upper limit is greater than the lower limit.	8-7
Program sweep cannot be executed	Select a sweep pattern file.	6-5
Calculation cannot be executed	Select a MATH definition file.	8-4
Illegal CAL data	It is possible that the specifications may not be met even when the GS610 is calibrated with the default calibration values. Request to have the GS610 recalibrated.	-

17.3 Self Test

Procedure

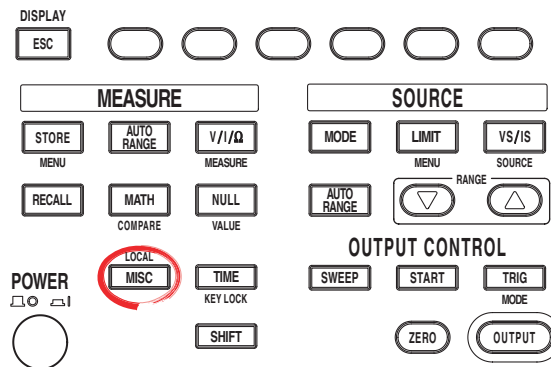

- To exit the menu during operation, press **ESC** at the upper left of the operation panel.
- In the procedural explanation below, the phrase “**rotary knob, numeric keys, <, and >**” are used to refer to the operation of selecting or setting items or entering values using the **rotary knob, numeric keys, <**, and **>** keys (BS key and right arrow key). For details on the operation using the rotary knob, numeric keys, **<**, and **>**, see sections 3.8 or 3.9.

Displaying the Self Test Menu

1. Press **MISC** to display the MISC menu.
2. Press the **System** soft key.

Remote I/F	Setup	Error Log	Wire 4W 2W	CSV Setting	System
---------------	-------	--------------	---------------	----------------	--------

3. Press the **Next 1/2** soft key.

External I/O	Beep On Off	Display 1	LineFreq 50 60	Product Info	Next 1/2
-----------------	----------------	--------------	-------------------	-----------------	-------------

4. Press the **Selftest** soft key.

Time Adjust	Time Zone	Selftest	Disk Format	Firmware Update	Next 2/2
----------------	--------------	----------	----------------	--------------------	-------------

Executing the Display Test

5. Press the **Display** soft key. The entire display illuminates.

				Display	Key
--	--	--	--	---------	-----

6. To end the test, press **ESC**.

Executing the Key Test

5. Press the **Key** soft key.

				Display	Key
--	--	--	--	---------	-----

6. Press each key and check that the name of the respective key is displayed.
7. To end the test, press **ESC** twice.

Explanation**Testing the Display**

The display test checks for color dropouts or abnormality on the display. If the display is not correct, contact your nearest YOKOGAWA dealer.

Key Test

The key test checks whether the front panel keys are operating properly. If the name of the key being pressed is highlighted, the key is operating correctly. If it does not, contact your nearest YOKOGAWA dealer.

<<Corresponding Command Mnemonic>>

:TST?

17.4 Checking the System Status

Procedure

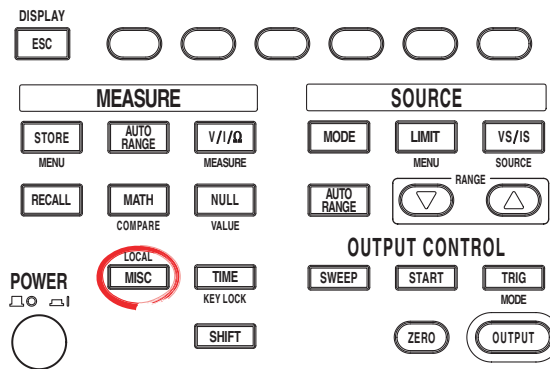

- To exit the menu during operation, press **ESC** at the upper left of the operation panel.
- In the procedural explanation below, the phrase “**rotary knob, numeric keys, <, and >**” are used to refer to the operation of selecting or setting items or entering values using the **rotary knob, numeric keys, <**, and **>** keys (BS key and right arrow key). For details on the operation using the rotary knob, numeric keys, **<**, and **>**, see sections 3.8 or 3.9.

1. Press **MISC** to display the MISC menu.
2. Press the **System** soft key.

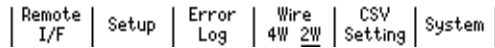

3. Press the **Product Info** soft key.

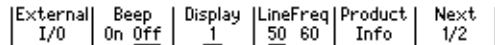

Explanation

The following items can be confirmed.

Instrument :	GS610 SOURCE MEASURE UNIT	Product name
SerialNo :	12345678	Serial number
Firmware Revision :	2005/06/03 10:15:00	Firmware revision
Option :	Ethernet Interface Option	Options
Calibration Date :	2005/02/14 05:46:49 *	Calibrated date

<<Corresponding Command Mnemonic>>

* IDN?

17.5 Updating the System Firmware

Procedure

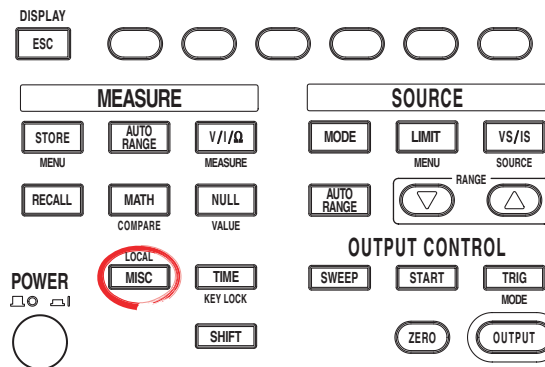

- To exit the menu during operation, press **ESC** at the upper left of the operation panel.
- In the procedural explanation below, the phrase “**rotary knob, numeric keys, <, and >**” are used to refer to the operation of selecting or setting items or entering values using the **rotary knob, numeric keys, <**, and **>** keys (BS key and right arrow key). For details on the operation using the rotary knob, numeric keys, **<**, and **>**, see sections 3.8 or 3.9.

Obtaining the Update File

1. Download the most recent system file (System.bin) from YOKOGAWA GS610 Web page (<http://www.yokogawa.com/tm/GS610>) to your PC.
2. Connect the PC and the GS610 using a USB cable.
3. Copy the system file (System.bin) to the volatile disk (GS610RAM).

Executing the Firmware Update

1. Press **MISC** to display the MISC menu.
2. Press the **System** soft key.

Remote I/F	Setup	Error Log	Wire 4W 2W	CSV Setting	System
------------	-------	-----------	------------	-------------	--------

3. Press the **Next 1/2** soft key.

External I/O	Beep On Off	Display 1	LineFreq 50 60	Product Info	Next 1/2
--------------	-------------	-----------	----------------	--------------	----------

4. Press the **FirmwareUpdate** soft key.
The system file automatically opens and the update operation is carried out. If a system file does not exist on the GS610RAM, an error message is displayed.

Time Adjust	Time Zone	Selftest	Disk Format	Firmware Update	Next 2/2
-------------	-----------	----------	-------------	-----------------	----------

5. When the update operation is complete, a message prompting you to power cycle the GS610 appears. If the message is displayed, cycle the GS610 power.

Note

- Do not turn the power OFF after you select FirmwareUpdate until the system is completely written. If you do, the GS610 may malfunction.
- When the system firmware is updated, all of the data files stored on the GS610RAM are cleared. Be sure to move important data files to a different directory in advance.

17.5 Updating the System Firmware

Explanation

When updating the system firmware, the most recent file must be stored on the GS610RAM in advance.

You can download the system file from YOKOGAWA website.

Check the site at the following URL:

<http://www.yokogawa.com/tm/GS610>

17.6 Recommended Replacement Parts

The one-year warranty applies only to the main unit of the instrument (starting from the day of delivery) and does not cover any other items nor expendable items (items which wear out). The replacement period for expendable items varies depending on the conditions of use. Refer to the table below as a general guideline. Contact your nearest YOKOGAWA dealer to have parts replaced.

Parts Name	Recommended Replacement Period
Cooling fan	3 years
Backup battery (lithium battery)	5 years
VFD	3 years

18.1 Source Section

DC Voltage Source

Range Setting	Source Range	Resolution	Max. Load Current	Accuracy (One Year) ±(% of setting + V + V×lo/ f.s of the limiter range)	Temperature Coefficient ±(% of setting + V + V×lo/ f.s of the limiter range)/°C
200 mV	±205.000 mV	1 μV	±3.2 A	0.02+200 μV+80 μV (400 μV)	0.002+20 μV+8 μV (40 μV)
2 V	±2.05000 V	10 μV	±3.2 A	0.02+300 μV+100 μV (500 μV)	0.002+30 μV+10 μV (50 μV)
12 V	±12.0000 V	100 μV	±3.2 A	0.02+2 mV+800 μV (3 mV)	0.002+200 μV+80 μV (300 μV)
20 V	±20.5000 V	100 μV	±2 A	0.02+2 mV+800 μV (5 mV)	0.002+200 μV+80 μV (500 μV)
30 V	±30.000 V	1 mV	±2 A	0.02+20 mV+5 mV (30 mV)	0.002+2 mV+500 μV (3 mV)
60 V	±60.000 V	1 mV	±1 A	0.02+20 mV+6 mV (40 mV)	0.002+2 mV+600 μV (4 mV)
110 V	±110.000 V	1 mV	±0.5 A	0.02+20 mV+8 mV (70 mV)	0.002+2 mV+800 μV (7 mV)

Accuracy: One year accuracy at 23±5°C.

Temperature coefficient: Add the temperature coefficient at 5 to 18°C and 28 to 40°C.

The values inside the parentheses are those when the limiter range is 3 A.

DC Current Source

Range Setting	Source Range	Resolution	Max. Load Voltage	Accuracy (One Year) ±(% of setting+A)	Temperature Coefficient ±(% of setting+A)/°C
20 μA	±20.5000 μA	100 pA	±110 V	0.03+50 nA	0.003+5 nA
200 μA	±205.000 μA	1 nA	±110 V	0.03+300 nA	0.003+30 nA
2 mA	±2.05000 mA	10 nA	±110 V	0.03+3 μA	0.003+300 nA
20 mA	±20.5000 mA	100 nA	±110 V	0.03+30 μA	0.003+3 μA
200 mA	±205.000 mA	1 μA	±110 V	0.03+300 μA	0.003+30 μA
0.5 A	±0.50000 A	10 μA	±110 V	0.03+5 mA	0.003+500 μA
1 A	±1.00000 A	10 μA	±60 V	0.03+5 mA	0.003+500 μA
2 A	±2.00000 A	10 μA	±30 V	0.03+5 mA	0.003+500 μA
3 A	±3.20000 A	10 μA	±12 V	0.03+5 mA	0.003+500 μA

Accuracy: One year accuracy at 23±5°C.

Temperature coefficient: Add the temperature coefficient at 5 to 18°C and 28 to 40°C.

Current Limiter

I _{Limiter Value} ^{*1}	Range Setting	Resolution	Minimum Limit Value ^{*2}
0.10 μA to 20.00 μA	20 μA	10 nA	100 nA
20.1 μA to 200.0 μA	200 μA	100 nA	1 μA
0.201 mA to 2.000 mA	2 mA	1 μA	10 μA
2.01 mA to 20.00 mA	20 mA	10 μA	100 μA
20.1 mA to 200.0 mA	200 mA	100 μA	1 mA
0.201 A to 3.200 A	3 A	1 mA	10 mA

*1 When tracking is OFF, |Hi| or |Lo|, whichever is greater.

*2 Minimum value when tracking is OFF.

Voltage Limiter

I _{Limiter Value} ^{*3}	Range Setting	Resolution	Minimum Limit Value ^{*4}
1.0 mV to 200.0 mV	200 mV	100 μV	1 mV
0.201 V to 2.000 V	2 V	1 mV	10 mV
2.01 V to 20.00 V	20 V	10 mV	100 mV
20.1 V to 110.0 V	110 V	100 mV	1 V

*3 When tracking is OFF, |Hi| or |Lo|, whichever is greater.

*4 Minimum value when tracking is OFF.

Response Time (Typical)

Voltage Source

100 μ s: Time to reach within $\pm 0.1\%$ of the setting^{*1}

(at 20 V range setting with the source and limiter settings at maximum values and with a pure resistive load with a load factor of 25%)

*1 Measure delay needed for the measured voltage to reach $\pm 0.1\%$ in pulse source mode with the pulse base value set to zero.

*1 Integration time: 250 μ s

Current Source

400 μ s: Time to reach within $\pm 1\%$ of the setting^{*2}

(at 20 A range setting with the source and limiter settings at maximum values and with a pure resistive load)

*2 Measure delay needed for the measured current to reach $\pm 1\%$ in pulse source mode with the pulse base value set to zero.

*2 Integration time: 250 μ s

Output Noise (Typical)

8 mVp-p (DC to 20 MHz)

(with 2 V source range setting and at 1 A limiter range)

18.2 Measurement Section

Voltage Measurement

Integration Time of 16.66 ms/20 ms, 100 ms, or 200 ms

Range Setting	Measurement Range	Resolution	Accuracy (One Year) ±(% of reading+V)	Temperature Coefficient ±(% of reading+V)/°C
200 mV	±205.000 mV	1 µV	0.02+100 µV	0.002+30 µV
2 V	±2.05000 V	10 µV	0.02+200 µV	0.002+20 µV
20 V	±20.5000 V	100 µV	0.02+1 mV	0.002+100 µV
110 V	±110.000 V	1 mV	0.02+10 mV	0.002+1 mV

Integration time of 4 ms, 1 ms, or 250 µs

Range Setting	Measurement Range	Resolution	Accuracy (One Year) ±(% of reading+V)	Temperature Coefficient ±(% of reading+V)/°C
200 mV	±205.00 mV	10 µV	0.02+200 µV (300 µV)	0.002+20 µV (30 µV)
2 V	±2.0500 V	100 µV	0.02+300 µV (500 µV)	0.002+30 µV (50 µV)
20 V	±20.500 V	1 mV	0.02+3 mV (5 mV)	0.002+300 µV (500 µV)
110 V	±110.00 V	10 mV	0.02+30 mV (50 mV)	0.002+3 mV (5 mV)

Accuracy: One year accuracy at 23±5°C with auto zero turned ON.

Temperature coefficient: Add the temperature coefficient at 5 to 18°C and 28 to 40°C.

Values inside the parentheses are those when those when the integration time 1 ms or 250 µs.

Current Measurement

Integration Time of 16.66 ms/20 ms, 100 ms, or 200 ms

Range Setting	Measurement Range	Resolution	Accuracy (One Year) ±(% of reading+A)	Temperature Coefficient ±(% of reading+A)/°C
20 µA	±20.5000 µA	100 pA	0.03+50 nA	0.003+5 nA
200 µA	±205.000 µA	1 nA	0.03+300 nA	0.003+30 nA
2 mA	±2.05000 mA	10 nA	0.03+3 µA	0.003+300 nA
20 mA	±20.5000 mA	100 nA	0.03+30 µA	0.003+3 µA
200 mA	±205.000 mA	1 µA	0.03+300 µA	0.003+30 µA
3 A	±3.20000 A	10 µA	0.03+5 mA	0.003+500 µA

Integration time of 4 ms, 1 ms, or 250 µs

Range Setting	Measurement Range	Resolution	Accuracy (One Year) ±(% of reading+A)	Temperature Coefficient ±(% of reading+A)/°C
20 µA	±20.500 µA	1 nA	0.03+70 nA (80 nA)	0.003+7 nA (8 nA)
200 µA	±205.00 µA	10 nA	0.03+350 nA (400 nA)	0.003+35 nA (40 nA)
2 mA	±2.500 mA	100 nA	0.03+3.5 µA (4 µA)	0.003+350 nA (400 nA)
20 mA	±20.500 mA	1 µA	0.03+35 µA (40 µA)	0.003+3.5 µA (4 µA)
200 mA	±205.00 mA	10 µA	0.03+350 µA (400 µA)	0.003+35 µA (40 µA)
3 A	±3.2000 mA	100 µA	0.03+5.5 mA (6 mA)	0.003+550 µA (600 µA)

Accuracy: One year accuracy at 23±5°C with auto zero turned ON.

Temperature coefficient: Add the temperature coefficient at 5 to 18°C and 28 to 40°C.

Values inside the parentheses are those when those when the integration time 1 ms or 250 µs.

18.3 Functions

Source

Source function:	Voltage and current
Source mode:	DC or pulse
Sweep mode:	Linear, logarithmic, or program (up to 65535 steps)

Measurement

Measurement function:	Voltage, current, and resistance (calculated from measured voltage/generated current or generated voltage/measured current)
Measurement data storage:	Up to 65535 data points
Averaging:	Block average or moving average at the specified count (2 to 256)

Trigger

Trigger mode:	Internal trigger, external trigger, and immediate
---------------	---

Time Setting

Pulse width:	100 μ s to 3600 s	1 μ s resolution
Repeat period:	100 μ s to 3600 s	1 μ s resolution
Source delay:	1 μ s to 3600 s	1 μ s resolution
Measurement delay:	1 μ s to 3600 s	1 μ s resolution
Integration time:	250 μ s, 1 ms, 4 ms, 16.6 ms or 20 ms, 100 ms, 200 ms	Auto detect from the power supply frequency when the power is turned ON for 16.6 ms and 20 ms

Computation

Computation Using Equations

Loads the equation definition file created in text format and performs the computation
Five built-in equations are pre-installed

Operators: + (addition), - (subtraction), * (multiplication), / (division), and ^ (exponentiation)

Functions: abs() (absolute value), exp() (exponent of e), ln() (natural logarithm), log (log base 10), sqrt() (square root), sin(), cos(), tan(), asin(), acos(), atan(), sinh(), cosh(), and tanh()

NULL Computation

Sets the NULL value to the measured value when the NULL computation is turned ON, and displays values obtained by subtracting the NULL value from the measured value for subsequent measurements.

Comparison Operation

Determines the magnitude relation between the displayed value and the reference values (upper and lower) and displays the result.

18.4 External Input/Output Section (TRIG/SWEEP/CTRL IN and OUT)

Connector type:	BNC connector, D-Sub 15-pin receptacle
Input/output level:	TTL
I/O logic format:	Negative logic, falling edge
Minimum pulse width:	10 μ s or greater

18.5 Interface

GP-IB Interface

Electrical and mechanical specifications:	Conforms to IEEE St'd 488-1987
Functional specifications:	SH1, AH1, T6, L4, SR1, RL1, PP0, DC1, DT1, and C0
Protocol:	Conforms to IEEE St'd 488.2-1987
Address:	0 to 30

RS-232 Interface

Connector type:	D-Sub 9-pin
Electrical specifications:	Conforms to EIA RS-232
Connection format:	Point-to-point
Transmission mode:	Full-duplex
Synchronization mode:	Start-stop synchronization
Baud rate:	9600, 14400, 19200, 38400, 57600, and 115200 bps

USB Interface

Number of ports:	1
Connector type:	Type B connector (receptacle)
Electrical and mechanical specifications:	Conforms to USB Rev. 2.0

Ethernet Interface (Option)

Number of communication ports:	1
Connector type:	RJ-45 connector
Electrical and mechanical specifications:	Conforms to IEEE 802.3.
Transmission system:	100BASE-TX/10BASE-T
Data rate:	100 Mbps/10 Mbps

18.6 General Specifications

Safety Standards*¹

Complying standard

EN61010-1

Measurement category I (250V_{peak})*²

Pollution degree 2*³

Emission*¹

Complying standard

EN61326-1 Class A

EN55011 Class A, Group 1

EN61000-3-2 Class A

EN61000-3-3

C-Tick EN55011 Class A, Group 1

This is a Class A product. In a domestic environment this product may cause radio interference in which case the user may be required to take adequate measures.

Cable condition

- **Output terminal**

Use a measurement lead (758933, red and black 1pc, length: 1 m) of the standard accessories for connection.

Connection of sense terminal at the time of 4 terminal connection also recommends use of this cable. (Use a cable of length 1 m or less.)

- **BNC IN/OUT terminal**

For connection, use a BNC cable that is better than or equivalent to the 1.5D-QEW BNC cable.*⁴

- **ETHERNET port**

Use a five or more-category LAN cable for connection.

- **USB port**

Use a cable corresponding to USB 2.0 (Hi-speed USB) for connection.*⁴

- **GP-IB connector**

Use a GP-IB (IEEE488) cable for connection.

- **EXT I/O connector**

Use a shielded cable for connection.*⁴

- **SERIAL (RS-232) connector**

Use a RS-232 shielded cable for connection.

Immunity*1**Complying standard**

EN61326-1 Table2*5

- **Immunity influence**

Within the measured value $\pm 20\%$ of range

- **Test condition**

100-V range, DC source mode, limit: ± 0.5 A, resistance under measurement: 220 Ω , local sense (2W)

However, a cable is connected also to sense terminal and others are set up at the factory default setup.

(Cable conditions examined on the same conditions as emission.)

- *1 Applies to products that have "CE Mark" on the back panel.
For all other products, contact your nearest YOKOGAWA dealer listed on the back cover of the manual.
- *2 The transient overvoltage of the measurement terminal section on the GS610 is 1500 V. Do not use the GS610 for making measurements in Measurement Categories II, III, and IV.
- *3 Pollution Degree applies to the degree of adhesion of a solid, liquid, or gas which deteriorates withstand voltage or surface resistivity.
Pollution Degree 2 applies to normal indoor atmospheres (with only non-conductive pollution).
- *4 Use a cable of length 2 m or less.
- *5 Immunity test requirements for equipment intended for use in industrial locations.

Display

256 × 64 dots fluorescent tube (VFD)

Internal Memory

GS610ROM: 4 MB (non-volatile. Used to save setup files and output pattern files.)

GS610RAM: 4 MB (volatile (cleared when the power is turned OFF). Used to save the measured results.)

Warm-up time

Approx. 60 minutes

Storage Conditions

Temperature	-15°C to 60°C
Humidity	20% to 80% RH (no condensation)
Altitude	2000 m or less

Operating Conditions

Temperature	5°C to 40°C
Humidity	20% to 80% RH (no condensation)
Altitude	2000 m or less

Rated Supply Voltage

100 to 120 VAC or 220 to 240 VAC (automatic switching)

Permitted Supply Voltage Range

90 to 132 VAC, 198 to 264 VAC

Rated Supply Voltage Frequency

50/60 Hz

18.6 General Specifications

Permitted Supply Voltage Frequency Range

48 Hz to 63 Hz

Maximum Allowable Input Voltage

Between Hi SENSE and Lo SENSE and between Hi OUTPUT and Lo OUTPUT ± 110

V_{peak}

Between Hi SENSE and Hi OUTPUT and between Lo SENSE and Lo OUTPUT ± 1

V_{peak}

Maximum Power Consumption

Approx. 200 VA

Maximum Common-Mode Voltage

Between source (measurement) terminal and case ± 250 V_{peak}

External Dimensions

Approx. 213(W) × 132(H) × 400 (D) mm excluding projections.

Weight

Approx. 7 kg

Key Lock

Key lock can be set.

Recommended Calibration Period

1 year

Standard Accessories

Power cord	1 pc.
Measurement lead	1 set (red and black 1 piece each)
Alligator clip adapter (small)	1 set (red and black 1 piece each)
Rubber feet	2 sets (2 pcs. in a set)
User's manual (this manual)	1 pc.

18.7 External Dimensions

Unit: mm

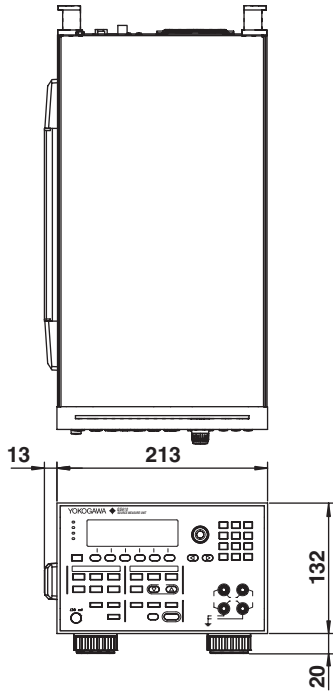

Rear View

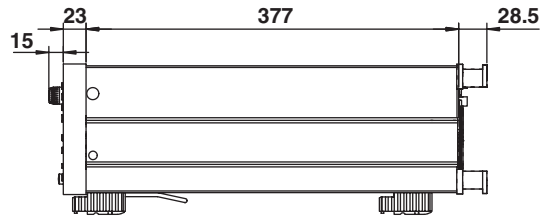
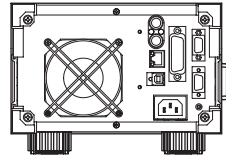

• Dimensions with the JIS rack mount kit
Mounting surface

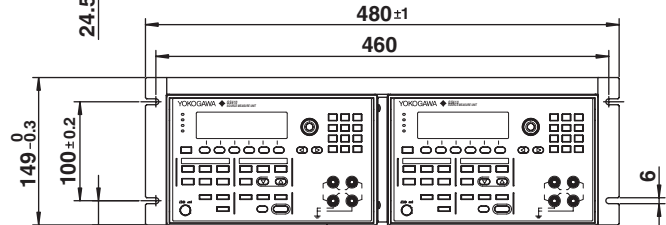
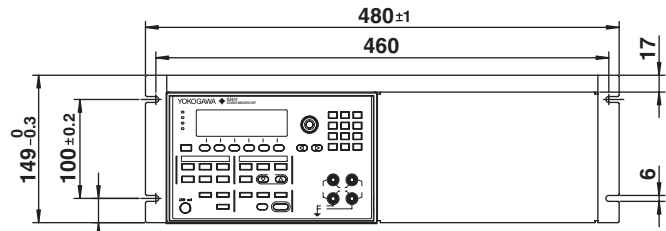
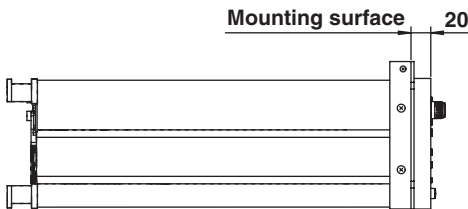
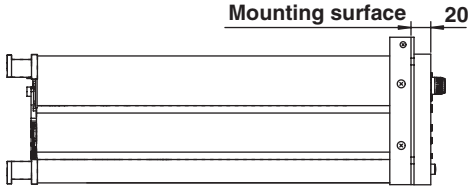

• Dimensions with the EIA rack mount kit
Mounting surface

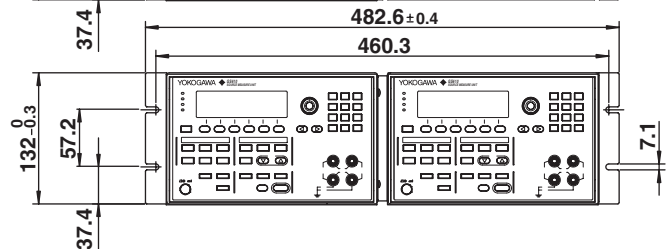
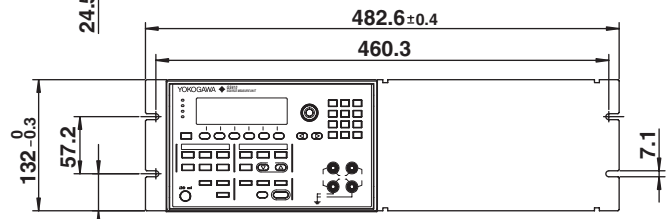
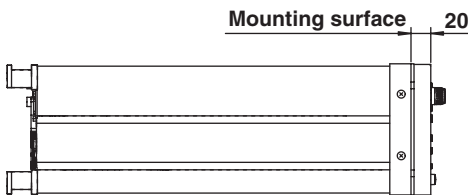
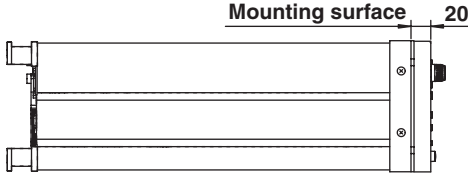

Note: Be sure to provide support from the bottom of the GS610 avoiding the vent holes. Allow at least 80 mm of space around the GS610 for ventilation.

Unless otherwise specified, tolerance is ±3% (however, tolerance is ±0.3 mm when below 10 mm).

Appendix 1 Computation Definition Specifications

Computation (MATH) can be performed by creating a text file (equation definition file) containing equations and statements similar to BASIC on a PC, (2) placing the file in the MATH directory on the GS610ROM disk, and (3) selecting the file on the GS610.

File Format

The file is a text file consisting of statements. To write multiple lines of statements, use a line feed code (CR, LF, or CR+LF) for the delimiter. However, in the case of a compound statement described later, the line feed code is parsed as a delimiter of the statement composing the compound statement.

Variables, constants, and functions are not case-sensitive. You can arbitrarily insert blank lines between statements for better readability. You can enter arbitrary blank characters (spaces or tabs) between variables, constants, literals, operators, and functions.

If multiple statements are written, the statements are basically executed in ascending order of line numbers. Statements for substituting initial values into internal variables are executed only in the following cases.

- First computation after the output is turned ON.
- First computation after the sweep operation is started.
- First computation after the computation is turned ON.
- First computation after the equation definition file is reselected.

If the total number of variables, constants, literals, operators, functions, and branches in a statement exceeds 256 or the total number of variables, constants, literals, operators, functions, and branches in the definition file exceeds 1024, the GS610 generates the following error indicating that the definition is too complex to be handled.

“101: Too complex expression”

If a syntax error exists in the definition, the GS610 generates the following error, and the definition is not selected.

“100: Expression syntax error”

Statements

The following types of statements are available.

- Statement for computing measured values
M = <expression>
The result of <expression> is displayed as the measured result.
- Statement for computing the next source value
S = <expression>
The result of <expression> is used as the next source value.
However, this cannot be used simultaneously with a sweep operation.
- Statement for substituting values into internal variables
X = <expression>
Y = <expression>
Z = <expression>
The result of <expression> is substituted into internal variable X, Y, or Z.
- Statement for substituting initial values into internal variables
X0 = <expression>
Y0 = <expression>
Z0 = <expression>
The result of <expression> is substituted as an initial value into internal variable X, Y, or Z.
This substitution statement is carried out at the time as specified in "File Format."
- IF Statement
IF <expression> THEN <statement>
If the result of <expression> is not zero, <statement> is executed.
IF <expression> THEN <statement1> ELSE <statement2>
If the result of <expression> is not zero, <statement1> is executed. If the result is zero, <statement2> is executed.
- Compound statement { <statement1> <delim> <statement2> <delim> }
<delim> = CR/LF/CR+LF
Used when executing multiple statements in a IF statement. The statements are executed in order.
- Command execution statement
@<string>
Executes the string following the @ character as a communication command.
However, query commands cannot be used.
- Comment statement
// comment
Characters following two consecutive slashes up to the line feed are considered a comment statement and are discarded.

Expression

An expression is made up of the combination of variables/constants/literals and operators/functions. The order of expressions can be changed by enclosing the expression you wish to prioritize with parentheses. The order of precedence (the order in which the operators are evaluated in a compound expression) is described later.

Variables

- M: Measured value
- S: Source value
- T: Time stamp equivalent to GMT in 1 μ s resolution (unit is seconds)
- M[n]: The current measured value to the measured value 15 measurements in the past (before the computation) specified by n in the range of 0 to -15
- S[n]: The current source value to the source value 15 source cycles in the past specified by n in the range of 0 to -15
- T[n]: The current time stamp to the time stamp 15 cycles in the past specified by n in the range of 0 to -15
- I: Source value or measured value that is a current.
- V: Source value or measured value that is a voltage.
- A: Parameter A
- B: Parameter B
- C: Parameter C
- X: Internal variable X
- Y: Internal variable Y
- Z: Internal variable Z
- J: Counter Cleared to 0 when the statement for substituting initial values into internal variables is executed and incremented for subsequent computations.

Constants

- PI: Ratio of the circumference 3.1415926...
- E: The base of the natural logarithm 2.7182818...

Literals

Integer, fixed-point real number, and floating-point real number
 Example 1.0 0.1234 -1.2345E-1

Strings

Characters enclosed with double quotations

Used as a command execution statement or as a parameter for MKTIME().

Example @":SOURCE:VOLTAGE:LEVEL 12.5V"
 MKTIME("2005/12/25 18:30")

Operators

<exp1> + <exp2>: Addition
<exp1> - <exp2>: Subtraction
<exp1> * <exp2>: Multiplication
<exp1> / <exp2>: Division
<exp1> % <exp2>: Modulo (the remainder of an integer division operation)
<exp1> ^ <exp2>: <exp1> to the power of <exp2>
<exp1> < <exp2>: 1 if <exp1> is less than <exp2>, or 0 otherwise
<exp1> <= <exp2>: 1 if <exp1> is less than or equal to <exp2>, or 0 otherwise
<exp1> >= <exp2>: 1 if <exp1> is greater than or equal to <exp2>, or 0 otherwise
<exp1> > <exp2>: 1 if <exp1> is greater than <exp2>, or 0 otherwise
<exp1> == <exp2>: 1 if <exp1> is equal to <exp2>, or 0 otherwise
<exp1> != <exp2>: 1 if <exp1> is not equal to <exp2>, or 0 otherwise
<exp1> AND <exp2>: 1 if <exp1> is nonzero and <exp2> is nonzero, or 0 otherwise
<exp1> OR <exp2>: 1 if <exp1> is nonzero or <exp2> is nonzero, or 0 otherwise
<exp1> XOR <exp2>: 1 if <exp1> is nonzero and <exp2> is 0 or <exp1> is 0 and <exp2> is nonzero, or 0 otherwise

NOT <exp>: 1 if <exp> is 0, 0 otherwise
- <exp>: Negation

Functions

RAND(<exp>): Random number between 0 and 1 using <exp> as a seed.
RAND(): Random number between 0 and 1
EDGE(<exp>): 1 when <exp> changes from 0 to nonzero, 0 otherwise
ABS(<exp>): Absolute value of <exp>
EXP(<exp>): E to the power of <exp>
LN(<exp>): Natural logarithm of <exp>
LOG(<exp>): Common logarithm of <exp>
SQRT(<exp>): Square root of <exp>
SIN(<exp>): Sine of <exp>
COS(<exp>): Cosine of <exp>
TAN(<exp>): Tangent of <exp>
ASIN(<exp>): Arc sine of <exp>
ACOS(<exp>): Arc cosine of <exp>
ATAN(<exp>): Arc tangent of <exp>
SINH(<exp>): Hyperbolic sine of <exp>
COSH(<exp>): Hyperbolic cosine of <exp>
TANH(<exp>): Hyperbolic tangent of <exp>
TRUNC(<exp>): Truncate <exp>
MKTIME(<string>): Convert the date/time expressed by <string> to the same format as the time stamp
 Format: [yyyy/mm/dd] hh:mm[:ss]
 Interpreted as the current year, month and day if yyyy/mm/dd is omitted.
 Interpreted as :00 is :ss is omitted.

Order of Precedence

Expressions with higher order of precedence (larger value) are evaluated first.

Symbol, Operator, and Function	Order of Precedence
()	12
[]	11
RAND() EDGE() ABS() EXP() LN() LOG() SQRT() SIN() COS() TAN() ASIN() ACOS() ATAN() SINH() COSH() TANH() MKTIME() TRUNC()	10
NOT	9
^	8
* / %	7
+ -	6
< <= > >=	5
== !=	4
XOR	3
AND	2
OR	1
=	0

Appendix 2 Application Examples

Evaluation of the Static Characteristics of a Transistor

• V_{CE} - I_C Characteristics Evaluation

The V_{CE} - I_C characteristics of a transistor can be measured using the GS610 program sweep mode.

Details of Operation

Measures collector current I_C when collector-emitter voltage V_{CE} is varied with base current I_B fixed.

Connection example for measurements

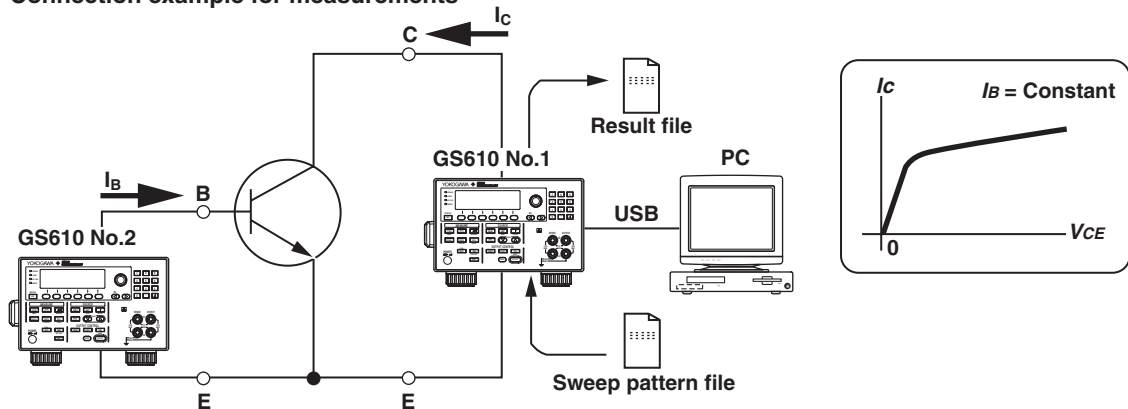

Key Points in the Operation and Setting

- Transferring the pattern files and measurement result data files using the USB storage function: See section 6.6, "Program Pattern File" and 4.3, "USB Storage Function."
- Saving the measurement result data using the storage function: See section 9.1, "Storing the Measured Results."

Connection Procedure

1. Connect the first GS610 between the collector and the emitter of the transistor.
2. Connect the second GS610 between the base and the emitter of the transistor.
3. Connect the first GS610 to a PC using the USB cable.

Procedure

Preparation

1. Create a sweep pattern (source pattern) used to vary collector-emitter voltage V_{CE} of the transistor using a general-purpose spreadsheet application on your PC. (If the amount of voltage change is constant, you can also use the linear sweep (see section 6.1, "Setting the Log or Linear Sweep").)

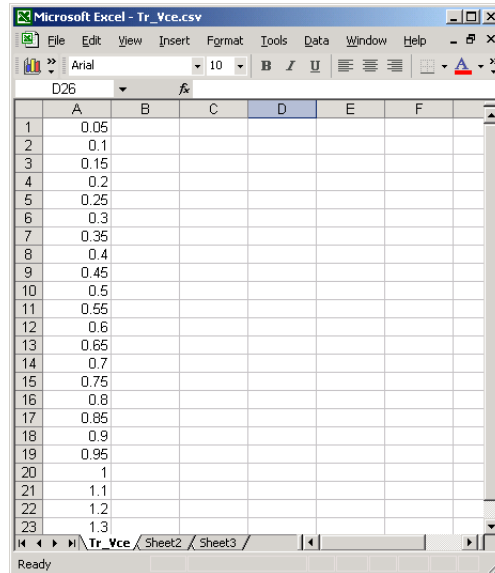

2. Save the pattern sweep data that you created in step 1 to a file in CSV format.
3. Transfer (Copy) the pattern sweep data file to the internal memory (GS610ROM) of the first GS610 via the USB.
4. Set each GS610 as follows:

		Setup Example of the First GS610	Setup Example of the Second GS610
SOURCE	Output function	Voltage output	Current output
	Limiter value	150 mA	1 V
	Output mode	DC	DC
	Output range:	AUTO	AUTO
OUTPUT CONTROL	Trigger mode	Internal	Internal
	Sweep mode	Program	OFF
MEASURE	Measurement function	ON	OFF
	Measurement function	Current measurement	—
	Integration time	200 ms	—
	Measurement range	AUTO	—
	Auto store	ON	—
	Store	ON	—
TIME	Source delay	1 μ s	—
	Measurement delay	1 ms	—
	Repeat period	500 ms	—
	(of the internal trigger)*		

* Repeat period of the internal trigger > Output delay + measure delay + integration time + α . (α = Time caused by range change, calibration, and so on)

Source and Measurement

1. Use the second GS610 to supply a constant current I_B (base current) across the base and the emitter of the transistor.
2. Use the first GS610 to apply the voltage pattern created in step 1 in “Preparation” as collector-emitter voltage V_{CE} of the transistor (see section 6.2, “Setting the Program Sweep”), and measure collector current I_C .
3. A file containing the source voltage pattern and measured results is created in the internal volatile memory (GS610RAM) of the first GS610 (See section 9.1, “Storing the Measured Results”).
4. Transfer (Copy) the measurement result file from the GS610RAM of the first GS610 to the PC via the USB.
5. Display the graph of the measured results using a general-purpose spreadsheet application on your PC.

Time(s)	Source(V)	Measure(I)	Setup
0	5.00E-02	-8.97E-07	
0.05	1.00E-01	-5.95E-07	
0.1	1.50E-01	-5.92E-07	
0.15	2.00E-01	-5.94E-07	
0.2	2.50E-01	-5.94E-07	
0.25	3.00E-01	-5.86E-07	
0.3	3.50E-01	-5.95E-07	
0.35	4.00E-01	-5.92E-07	
0.4	4.50E-01	-5.96E-07	
0.45	5.00E-01	-5.92E-07	
0.5	5.50E-01	-5.94E-07	
0.55	6.00E-01	-5.92E-07	
0.6	6.50E-01	-6.00E-07	
0.65	7.00E-01	-5.90E-07	
0.7	7.50E-01	-5.92E-07	
0.75	8.00E-01	-5.90E-07	
0.8	8.50E-01	-5.78E-07	
0.85	9.00E-01	-5.87E-07	
0.9	9.50E-01	-5.90E-07	
0.95	1.00E+00	-5.91E-07	
1	1.10E+00	-5.72E-07	
1.05	1.20E+00	-5.77E-07	
1.1	1.30E+00	-5.77E-07	

• I_B - I_C Characteristics Evaluation

The I_B - I_C characteristics of a transistor can be measured by synchronizing two GS610s.

Details of Operation

Measures collector current I_C when base current I_B is varied with collector-emitter voltage V_{CE} fixed using two synchronized GS610s.

Connection example for measurements

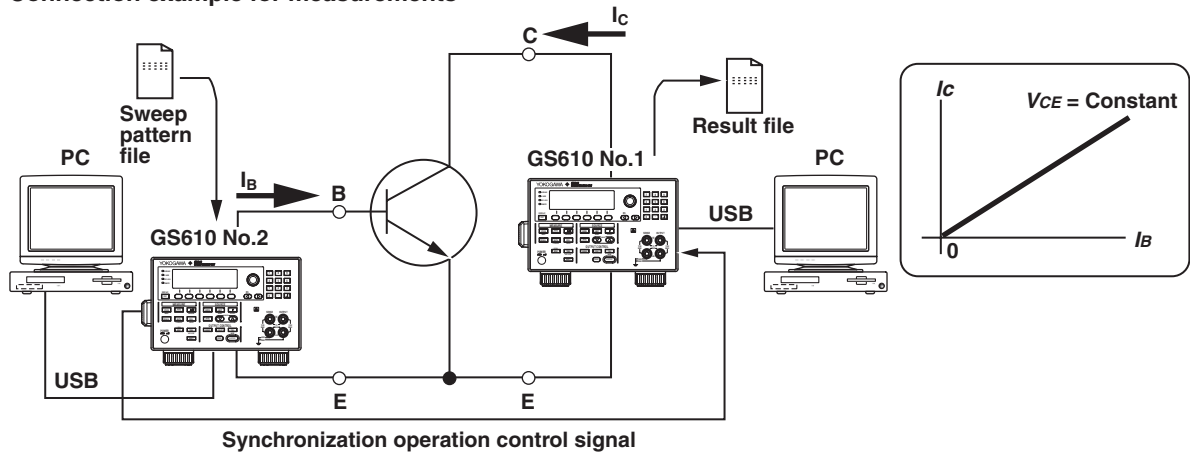

Key Points in the Operation and Setting

- Synchronizing two GS610s: See section 10.2, "Synchronized Operation."
- Transferring the pattern files and measurement result data files using the USB storage function: See section 6.6, "Program Pattern File" and 4.3, "USB Storage Function."
- Saving the measurement result data using the storage function: See section 9.1, "Storing the Measured Results."

Connection Procedure

1. Connect the first GS610 between the collector and the emitter of the transistor.
2. Connect the second GS610 between the base and the emitter of the transistor.
3. Connect TRIG IN on the rear panel of the first GS610 to TRIG OUT on the rear panel of the second GS610 (see section 10.2, "Synchronized Operation.").
4. Connect each GS610 to a PC using a USB cable (see section 4.3, "USB Storage Function").

Procedure

Preparation

1. Create an arbitrary sweep pattern file for varying base current I_B of the transistor using a general-purpose spreadsheet application on your PC.

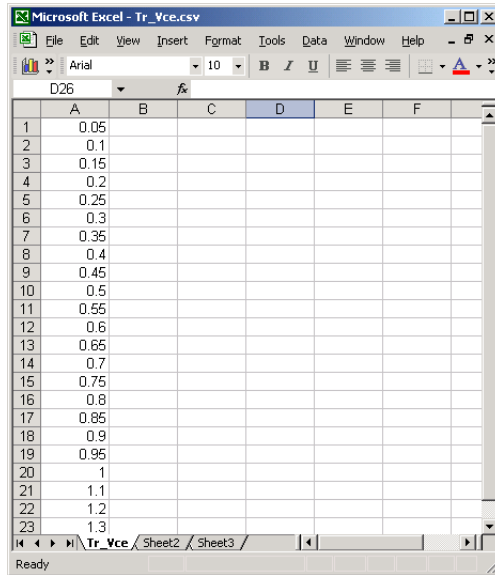

2. Save the data that you created in step 1 to a file in CSV format.
3. Transfer (Copy) the pattern sweep data file to the internal memory (GS610ROM) of the second GS610 via the USB.
4. Set each GS610 as follows:

		Setup Example of the First GS610	Setup Example of the Second GS610
SOURCE	Output function	Voltage output	Current output
	Limiter value	150 mA	1 V
	Output mode	DC	DC
	Output range:	AUTO	AUTO
OUTPUT CONTROL	Trigger mode	External	Internal
	Sweep mode	OFF	Program
MEASURE	Measurement function	ON	OFF
	Measurement function	Current measurement	–
	Integration time	200 ms	–
	Measurement range	AUTO	–
	Store count	Source data count	–
TIME	Source delay	1 μ s	1 μ s
	Measurement delay	1 ms	1 ms
	Repeat period	–	500 ms
	(of the internal trigger)		
External I/O	Trigger input	BNC input	–
	Trigger output	–	BNC output

Source and Measurement

1. Use the first GS610 to apply a constant voltage V_{CE} across the collector and the emitter of the transistor.
2. Use the second GS610 to supply current pattern I_B (base current) that you created in step 1 of "Preparation" across the base and the emitter of the transistor. The first GS610 measures collector current I_C by synchronizing to the current pattern using the external trigger signal.
3. The measurement result data is created in the internal memory (GS610RAM) of the first GS610.

	A	B	C	D	E	F
	Time(s)	Source(V)	Measure(I)	Setup		
2	0	5.00E-02	-8.97E-07			
3	0.05	1.00E-01	-5.95E-07			
4	0.1	1.50E-01	-5.92E-07			
5	0.15	2.00E-01	-5.94E-07			
6	0.2	2.50E-01	-5.94E-07			
7	0.25	3.00E-01	-5.86E-07			
8	0.3	3.50E-01	-5.95E-07			
9	0.35	4.00E-01	-5.92E-07			
10	0.4	4.50E-01	-5.96E-07			
11	0.45	5.00E-01	-5.92E-07			
12	0.5	5.50E-01	-5.94E-07			
13	0.55	6.00E-01	-5.92E-07			
14	0.6	6.50E-01	-6.00E-07			
15	0.65	7.00E-01	-5.90E-07			
16	0.7	7.50E-01	-5.92E-07			
17	0.75	8.00E-01	-5.90E-07			
18	0.8	8.50E-01	-5.78E-07			
19	0.85	9.00E-01	-5.87E-07			
20	0.9	9.50E-01	-5.90E-07			
21	0.95	1.00E+00	-5.91E-07			
22	1	1.10E+00	-5.72E-07			
23	1.05	1.20E+00	-5.77E-07			
24	1.1	1.30E+00	-5.77E-07			

4. Transfer (Copy) the measurement result file in the internal memory (GS610RAM) of the first GS610 and the pattern file saved in the internal memory (GS610ROM) of the second GS610 to your PC via the USB.
5. Using a general-purpose spreadsheet application on your PC, save the sweep pattern and the measured results to a single file.

	A	B	C	D	E	F
	Time(s)	Source(V)	Measure(I)	Setup		
2	0	5.00E-02	-8.97E-07			
3	0.05	1.00E-01	-5.95E-07			
4	0.1	1.50E-01	-5.92E-07			
5	0.15	2.00E-01	-5.94E-07			
6	0.2	2.50E-01	-5.94E-07			
7	0.25	3.00E-01	-5.86E-07			
8	0.3	3.50E-01	-5.95E-07			
9	0.35	4.00E-01	-5.92E-07			
10	0.4	4.50E-01	-5.96E-07			
11	0.45	5.00E-01	-5.92E-07			
12	0.5	5.50E-01	-5.94E-07			
13	0.55	6.00E-01	-5.92E-07			
14	0.6	6.50E-01	-6.00E-07			
15	0.65	7.00E-01	-5.90E-07			
16	0.7	7.50E-01	-5.92E-07			
17	0.75	8.00E-01	-5.90E-07			
18	0.8	8.50E-01	-5.78E-07			
19	0.85	9.00E-01	-5.87E-07			
20	0.9	9.50E-01	-5.90E-07			
21	0.95	1.00E+00	-5.91E-07			
22	1	1.10E+00	-5.72E-07			
23	1.05	1.20E+00	-5.77E-07			
24	1.1	1.30E+00	-5.77E-07			

Voltage Fluctuation Simulation of Electronic Devices and Sensors for Vehicles

Transient signals can be generated (10 kS/s at the fastest) using the USB storage function of the GS610.

This section explains how to output from the GS610 real waveforms such as the fluctuation signal of an automotive power supply (12 V or 24 V).

Key Points in the Operation and Setting

1. Using real waveforms: See the user's manual that comes with your instrument such as YOKOGAWA's Digital ScopeCoder (DL750P).
2. Transferring the pattern files using the USB storage function: See section 6.6, "Program Pattern File" and 4.3, "USB Storage Function."

• Example in which the real waveform of supply voltage fluctuation is reproduced via a PC

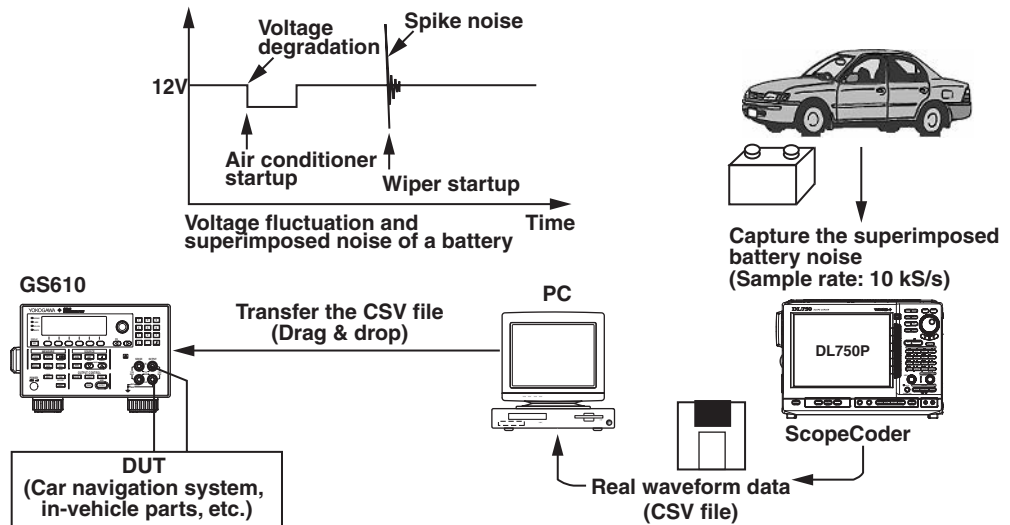

Procedure

1. Measure the signal you wish to generate by simulation from the GS610 (the fluctuation signal of an automotive power supply in this example) using an instrument such as YOKOGAWA's Digital ScopeCoder (DL750P).
2. Save the measured data in CSV format to a storage medium (floppy disk or memory card).
3. Load the file you saved in step 2 to your PC.
4. Use a general-purpose spreadsheet application to edit the measured data as necessary.
5. Copy the measured data that was loaded in your PC to the internal memory of the GS610 (GS610ROM) via the USB.
6. Generate the output pattern that was copied to the GS610ROM from the GS610. The fastest output is 100 kS/s.

- Example in which the real waveform of supply voltage fluctuation is set directly from the ScopeCoder (oscilloscope) and reproduced

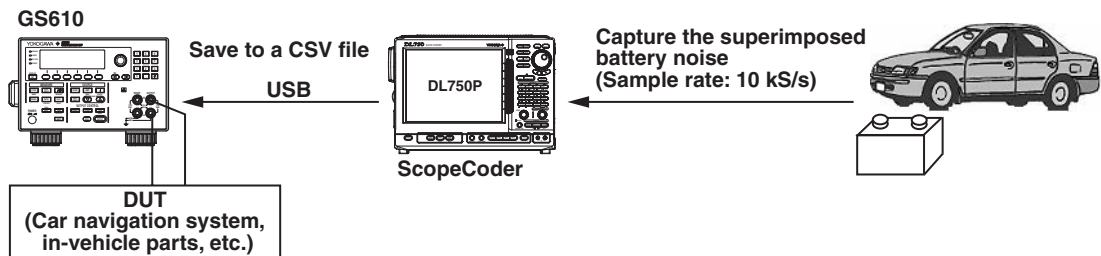

1. Connect the GS610 and the DL750P via the USB.
2. Measure the signal you wish to generate by simulation from the GS610 (the fluctuation signal of an automotive power supply in this example) using an instrument such as YOKOGAWA's Digital ScopeCoder (DL750P).
3. Save the measured data to the internal memory (GS610ROM) of the GS610 in CSV format via the USB.
4. Generate the output pattern that was saved to the GS610ROM. The fastest output is 100 kS/s.

Charge/Discharge Characteristics Measurement of Secondary Batteries (Lithium-Ion or Nickel-Hydride)

The GS610 functions can be used to carry out charge/discharge characteristics tests of lithium-ion batteries, nickel-hydride batteries, etc.

In boost charge operation, constant current charge using large current of approximately 2C to 5C (2 to 5 times the battery capacity) is carried out. When the battery voltage reaches a specified level, the operation is switched to constant voltage charge. In constant voltage charge operation, the charge current gradually decreases. When it decreases to a specified value, the charge operation is stopped.

The Auto V/I function of the GS610 switches from battery voltage measurement to charge current measurement by synchronizing to the switching of the operation mode from constant current charge to constant voltage charge.

• Charge Test

Details of Operation

1. The GS610 generates constant current to the secondary battery and measures the voltage.
2. When the voltage of the secondary battery reaches the charge voltage, the GS610 switches from voltage measurement mode to current measurement mode.
3. When the measured current reaches a given value, the GS610 stops the output.

Key Points in the Operation and Setting

1. Switching the measurement function using the Auto V/I function: See section 7.7, "Turning Auto V/I ON/OFF."
2. Stopping the output using the computation function: See section 8.5, "User Defined Computation."
3. Saving the measured data using the storage function: See section 9.1, "Storing the Measured Results."

Connection Procedure

Connect the OUTPUT terminal to each end of the battery with cables.

To carry out voltage measurements more accurately, use the remote sense (four-terminal) connection to connect the SENSE terminal to each end of the battery with cables.

Connection example for measurements

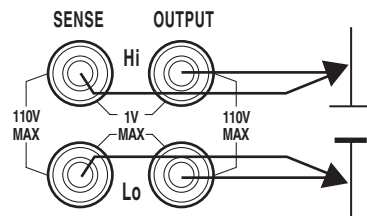

Procedure

Preparation

Enable the AUTO V/I function that automatically switches from voltage measurement mode to current measurement mode when the measured voltage reaches a specified value. Set the GS610 as follows:

Setup Example of the GS610		
SOURCE	Output function	Current output
	Limiter value	3.6 V
	Output mode	DC
	Output range:	AUTO
OUTPUT CONTROL	Trigger mode	Internal
MEASURE	Measurement function	Voltage measurement
	Integration time	200 ms
	Measurement range	AUTO
	AUTO V/I (auto switching of the measurement mode)	ON
	Store count	Up to 65535 points.
	Computation	ON*
TIME	Source delay	1 μs
	Measurement delay	1 ms
	Repeat period (of the internal trigger)	60 s

* Equation Example
 If (I<=10E-3) then{←Condition statement for when the current value is less than or equal to 10 mA
 @":OUTPUT:STATS OFF"}←Turns the output OFF.

Source and Measurement

1. The GS610 generates constant current to the secondary battery and measures the voltage.
2. When the voltage of the secondary battery reaches the charge voltage, a limiter is activated, and the GS610 switches to current measurement mode.
3. Through the computation function, the GS610 turns the output OFF when the measured current reaches a given value.
 The source values and measured results are saved to a single file in the internal memory of the GS610 (GS610RAM).
4. Transfer (Copy) the measurement result file from the GS610RAM of the GS610 to the PC via the USB.
5. Display the graph of the measured results using a general-purpose spreadsheet application on your PC.

Charging of a secondary battery

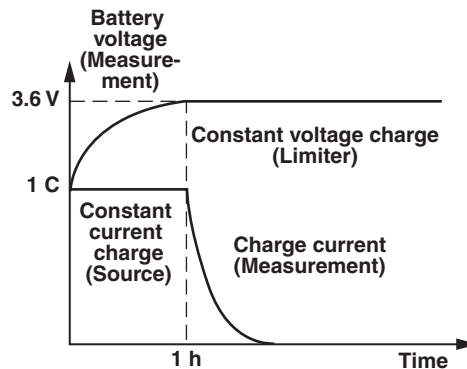

In the discharge simulation, the pulse current sink operation of the GS610 can be used to carry out constant current pulse discharge. The intermittent operation of mobile devices can be simulated.

The maximum number of measured data points that can be stored is 65535.

• Discharge Test

Details of Operation

The GS610 sinks the pulse current from the secondary battery and measures the voltage.

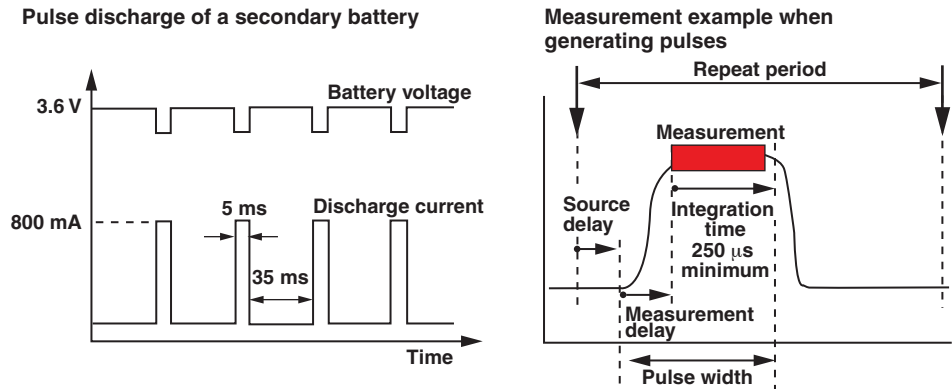

Key Points in the Operation and Setting

1. Pulse source (sink operation) and high-speed measurement: See section 5.5, "Setting the Pulse Source Mode."
2. Saving the measured data using the storage function: See section 9.1, "Storing the Measured Results."

Connection Procedure

Connect the OUTPUT terminal to each end of the battery with cables. To carry out voltage measurements more accurately, use the remote sense (four-terminal) connection to connect the SENSE terminal to each end of the battery with cables.

Connection example for measurements

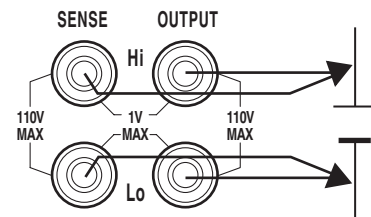

Procedure**Preparation**

Set the GS610 as follows:

		Setup Example of the GS610
SOURCE	Output function	Current output
	Limiter value	3 V
	Output mode	Pulse
	Output range	AUTO
OUTPUT CONTROL	Trigger mode	Internal
MEASURE	Measurement function	Voltage measurement
	Integration time	250 μ s
	Measurement range	AUTO
	AUTO V/I (auto switching of the measurement mode)	ON
	Store count	65535 points
TIME	Source delay	1 μ s
	Measurement delay	1 μ s
	Repeat period (of the internal trigger)	40 ms
	Pulse width	5 ms

Source and Measurement

1. The GS610 outputs (sinks) the pulse current to the secondary battery and measures the voltage.
The source values and measured results are saved to a single file in the internal memory of the GS610 (GS610RAM).
2. Transfer (Copy) the measurement result file from the GS610RAM to the PC via the USB.

Appendix 3 Contents of the Factory Default Setup File (Default.txt)

Item		Setting	Item		Setting
Source	Mode	DC	External input/output	BNC input terminal setting	Trig
	Function	Voltage source		BNC output terminal setting	Trig
	Auto range	OFF		Trig setting of the BNC output terminal	Origin
	Voltage range setting	2 V		DIO5 input connector setting	Output
	Voltage level	0 V		DIO6 output connector setting	Origin
	Voltage pulse base	0 V		DIO7 output connector setting	Origin
	Current range setting	2 mA		DIO8 output connector setting	IntLock
	Current level	0 mA			
	Current pulse base	0 mA			
	Voltage zero offset	0 mV			
	Current zero offset	0 uA			
	Voltage zero impedance	LoZ			
	Current zero impedance	HiZ			
Limiter		ON	Others	Connection type	2W
	Tracking	ON		Beep sound	ON
	Current high limit	2 mA		Display brightness	4
	Current low limit	-2 mA			
	Voltage high limit	2 V			
Voltage low limit	-2 V				
Sweep	Mode	OFF			
	Voltage start value	100 mV			
	Voltage step value	10 mV			
	Voltage stop value	200 mV			
	Voltage log sweep step count	10			
	Current start value	1 μ A			
	Current step value	0.1 μ A			
	Current stop value	2 μ A			
	Current log sweep step count	10			
	Repeat count	1			
	Termination mode	Keep			
Trigger	Trigger mode	Int (internal trigger)			
Measurement		ON			
	Function	Current			
	Auto range	OFF			
	Integration time	16.6/20 ms			
	Auto zero	ON			
	Store	OFF			
	Auto store	OFF			
	Store count	10			
	Auto V/I	OFF			
	Averaging mode	OFF			
	Average count	2			
NULL	OFF				
NULL value	0				
Time	Source delay	1 μ s			
	Measurement Delay	50 μ s			
	Pulse width	25 ms			
	Repeat period of the internal trigger	50 ms			
Computation using equations		OFF			
	Param A	0			
	Param B	0			
	Param C	0			
Comparison operation		OFF			
	Upper	0			
	Lower	0			

Index

Symbols

	Page
▽ down key	5-2
△ up key	5-2
2W	2-22, 4-3
4W	2-22, 4-3

A

	Page
accessories, optional	iv
accessories, standard	iii
auto range	2-11, 5-3
auto range (measurement)	2-10, 7-3
auto range (source)	2-7
AUTO RANGE key	5-2, 7-3
auto storage	2-19
auto storage, turning ON/OFF of	9-2
Auto V/I	2-12, 7-8
Auto Zero	7-7
Auto Zero Exec	7-7
auto zero function	2-11, 7-7
Average	8-1
average count	8-2
averaging	2-17, 8-1

B

	Page
backspace key	3-14
baud rate	14-7
BaudRate	14-6
Block	8-2
block average	2-17, 8-2
block diagram	2-2
BNC In	10-1
BNC input/output terminal	10-1, 10-3
BNC Out	10-2
BS key	3-14
built-in computation	2-18
built-in computation files	8-5

C

	Page
CALCulate group	16-27
CalExec	5-16
Clear	11-6
command control function	12-10
command list	16-6
common commands	16-40
communication environment, displaying of	12-10
Compare	8-7
COMPARE END	10-5
COMPARE HI	10-5

COMPARE IN	10-5
COMPARE LO	10-5
COMPARE OV	10-5
comparison operation	2-18, 8-7
computation	2-17
computation commands	16-27
computation using equations	2-17, 8-4
connection type	4-3
Count	8-1, 9-1
CTRL IN	10-5
CTRL OUT	10-5
current limiter	2-5
current measurement range settings	2-10
current source range settings	2-7

D

	Page
data length	14-7
DataBit	14-6
date and time	3-10
DC	5-6
DC source mode	2-7, 5-6
Default Gateway	12-4, 12-5, 12-6
DHCP	12-3
DIO 5pin	10-2
DIO 6pin	10-2
DIO 7pin	10-2
DIO 8pin	10-2
disk, formatting of	2-21, 4-7
DiskFormat	4-7
Display	11-7, 17-6
display brightness	11-7
display, turning OFF	11-7

E

	Page
error code	17-3
Error Log	11-6
error log display	11-6
error queue	16-48
ESC (DISPLAY) key	3-12
Ethernet interface	12-1
Ethernet settings	12-6
Ext	2-13, 4-2
EXT I/O	2-22
External I/O	10-1
external input/output commands	16-31
external input/output connector	10-1, 10-3
external trigger	2-13

Index

F	Page
FETCh group	16-38
FirmwareUpdate	17-9
fixed range	5-3
Flow	14-7
four-terminal connection	2-22, 4-3
FTP server function	12-11

G	Page
GMT	3-10
GP-IB address, setting of	13-5
GP-IB cable, connection of	13-4
GP-IB interface	13-3
GPIB	13-5
Greenwich Mean Time	3-10
GS610RAM	2-20, 4-6
GS610ROM	2-20, 4-6

H	Page
handling precautions	3-1
handshaking method	14-4, 14-7
High	2-18
high limiter indicator	2-5, 2-6
HiZ	2-9

I	Page
Imm	2-13, 4-2
immediate	2-13
In	2-18
Infinity	6-9
INITiate group	16-38
input section	10-5
input signals	10-4
installation location	3-4
installation position	3-3
instrument number	ii
Int	2-13, 4-2
integration time	2-11, 7-6
interface messages	13-6
internal trigger	2-13
IntgTime	7-6
IP Address	12-3
IP address	12-5, 12-6

K	Page
Keep	2-16, 6-8
Key	17-6
key groups	1-5
key lock	11-8
key operations	3-12

L	Page
LAN	12-3, 12-6
Last	6-7
Limit	5-4
LIMIT key	5-4
limiter	2-5, 5-4
limiter range	5-5
limiter, turning ON/OFF of	5-5
limiter value	5-5
Linear	6-1
linear sweep	2-14, 6-1
LineFreq	3-9
load (setup data)	11-3
Load Setup	11-3
local sense	2-22, 4-3
Log	6-1, 6-2
log sweep	2-14
Low	2-18
low limiter indicator	2-5, 2-6
Lower	8-7
LoZ	2-9

M	Page
M.Delay	7-4
MAC address	12-6
manual trigger	4-2
MATH	2-20, 4-6
Math	8-4
MATH key	2-18, 8-4
Measure	7-1
measure event register	16-47
MEASURE group	1-6
measured results, storing of	9-1
measured value readout	16-38
measurement command	16-24
measurement delay	2-11, 7-4
measurement function	2-10, 7-2
measurement range	2-10
measurement, turning ON/OFF of	7-1
menus	1-5
MISC group	1-8
MISC key	3-9, 3-10, 4-3, 4-7, 10-1, 11-1, 11-3, 11-6, 11-7, 12-3, 13-5, 14-6, 15-2, 17-6, 17-8, 17-9
Mode	6-1, 6-5
Mode (averaging)	8-1
MODE key	5-6, 5-8
MODEL	ii
Moving	8-2
moving average	2-17, 8-2

N	Page
network, connection to	12-2
NO.	ii

non-volatile disk	2-20
non-volatile disk (GS610ROM), saving to	11-2
NULL computation	2-17, 8-3
NULL key	8-3
NULL value	2-17, 8-3

O**Page**

offset calibration	2-9, 5-16
Options	ii
OUTPUT CONTROL group	1-7
OUTPUT key	5-13
output OFF	5-13
output ON	5-13
output queue	16-48
output relay	2-9, 5-13
output section	10-5
output signals	10-4
output states	2-9
OverView	12-6

P**Page**

P.Width	5-9
Param A to C	8-5
Parity	14-6, 14-7
pattern file description	6-11
Period	4-1
power cord	3-6
power frequency	3-9, 7-6
power switch, turning ON/OFF of	3-7
Product Info	17-8
PROGRAM	2-21, 4-6
Program	6-5
program format	16-1
program sweep	2-14, 6-5
Pulse	5-8
Pulse Base	5-8
pulse base value	5-10
pulse source mode	2-8, 5-8
pulse width	5-10

R**Page**

RANGE	5-2
READ group	16-38
recall	2-19, 9-4
recall commands	16-29
RECALL key	9-4
recommended replacement parts	17-11
reference value	8-8
Remote I/F	12-3, 12-6, 13-5, 14-6, 15-2
remote panel function	12-9
remote sense	2-22, 4-3
removable disks	2-20

Repeat	6-9
repeat count	2-16, 6-9
repeat period	4-2
result file	2-21, 9-2
return	2-16, 6-7
ROUTe group	16-31
RS-232 interface	14-1
RS-232 interface, setting of	14-6
RS232	14-6
Rtn	2-16, 6-7

S**Page**

S.Delay	5-11
sample program	16-49
save (setup data)	11-1
Save Setup	11-1
SaveRamDisk	11-1
Select File	6-5, 8-4
self test	17-6
Selftest	17-6
SENSe group	16-24
sensing	2-22
serial (RS-232) interface connection	14-2
SETUP	2-21, 4-6
Setup	11-1, 11-3
setup data, loading of	11-3
setup data, saving of	11-1
signal name and function	10-3
source command	16-15
source delay	2-8, 5-11
source event register	16-46
source function	2-5, 5-1
SOURCE group	1-5
SOURce group	16-15
source level	5-7, 5-10
source measure cycle	2-3
source range	2-7
source range setting	5-2
source value	5-7, 5-10
standard event register	16-44
START key	6-10
Start Value	2-15, 6-1, 6-2, 6-4
statistical computation value display	2-19
statistical computation values, recalling of	9-4
status byte	16-43
status report	16-42
Step Count	2-15, 6-3, 6-4
Step Value	2-15, 6-2, 6-4
Stop Bit	14-7
Stop Value	2-15, 6-2, 6-3, 6-4
StopBit	14-6
Storage	15-2
storage operation, stopping of	9-3
storage, starting of	9-2
store	2-19, 9-1

Index

store count	9-2
STORE key	2-19, 9-1
store/recall commands	16-29
SubNet Mask	12-3, 12-5, 12-6
SUFFIX	ii
sweep	2-14
sweep commands	16-23
SWEep group	16-23
SWEEP key	6-1, 6-5, 6-7, 6-9
sweep mode	2-15
sweep operation, starting of	6-10
SWEEP START IN	10-5
SWEEP SYNC OUT	10-5
synchronized operation	10-7
System	3-9, 3-10, 4-7, 10-1, 11-7, 17-6, 17-8, 17-9
system commands	16-34
system configuration	2-1
system firmware, updating of	17-9
SYSTem group	16-34
system status, checking of	17-8

T	Page
TCP/IP, setting of	12-3, 12-5
Term	12-4, 14-7
termination mode	2-16, 6-7
terminator, selection of	14-7
Time Adjust	3-10
TIME key	4-1, 5-9, 5-11, 7-4
Time Zone	3-11
TRACe group	16-29
Tracking	2-6, 5-4, 5-5
transmission terminator	12-5
TRIG IN	10-5
TRIG key	2-13, 4-1
TRIG OUT	10-5
TRIG/SWEEP/CTRL IN/OUT	2-22
trigger	4-1
trigger command	16-26
TRIGger group	16-26
trigger mode	4-2
triggers	2-13
TrigMode	4-1
troubleshooting	17-1
two-terminal connection	2-22, 4-3
Type	10-1, 10-2

U	Page
Upper	8-7
USB	15-2
USB cable, connection of	4-5
USB Interface	15-1
USB port	4-5
USB Storage	15-1
USB storage function	2-20, 4-5

USB-TMC	15-2
user-defined computation	8-9
user-defined computation syntax	8-10

V	Page
V/I/IsIW key	7-2
value, entry of	3-14
View	8-5
VISA	15-1
VISA resource name	15-2
volatile disk	2-20
volatile disk (GS610RAM), saving to	11-2
voltage limiter	2-5
voltage measurement range settings	2-10
voltage source range settings	2-7
VS/IS key	5-1

W	Page
wait indicator	6-10
WaitStart	6-10
WaitTrigger	2-13
Web server function	12-7
Wire	4-3
wiring precautions	3-8

Z	Page
zero generation	2-9, 5-14
ZERO key	5-14
Zero Offset	5-14, 5-15
zero source impedance	2-9, 5-15
zero source offset	2-9
Zero Z	5-14