



Advanced Test Equipment Rentals
www.atecorp.com 800-404-ATEC (2832)

SERIES
682XXB/683XXB
SYNTHESIZED SIGNAL GENERATORS
OPERATION MANUAL

Anritsu

WARRANTY

The ANRITSU product(s) listed on the title page is (are) warranted against defects in materials and workmanship for one year from the date of shipment.

ANRITSU's obligation covers repairing or replacing products which prove to be defective during the warranty period. Buyers shall prepay transportation charges for equipment returned to ANRITSU for warranty repairs. Obligation is limited to the original purchaser. ANRITSU is not liable for consequential damages.

LIMITATION OF WARRANTY

The foregoing warranty does not apply to ANRITSU connectors that have failed due to normal wear. Also, the warranty does not apply to defects resulting from improper or inadequate maintenance by the Buyer, unauthorized modification or misuse, or operation outside of the environmental specifications of the product. No other warranty is expressed or implied, and the remedies provided herein are the Buyer's sole and exclusive remedies.

TRADEMARK ACKNOWLEDGEMENTS

Adobe Acrobat is a registered trademark of Adobe Systems Incorporated.

NOTICE

ANRITSU Company has prepared this manual for use by ANRITSU Company personnel and customers as a guide for the proper installation, operation and maintenance of ANRITSU Company equipment and computer programs. The drawings, specifications, and information contained herein are the property of ANRITSU Company, and any unauthorized use or disclosure of these drawings, specifications, and information is prohibited; they shall not be reproduced, copied, or used in whole or in part as the basis for manufacture or sale of the equipment or software programs without the prior written consent of ANRITSU Company.

DECLARATION OF CONFORMITY

Manufacturer's Name: ANRITSU COMPANY

Manufacturer's Address: Microwave Measurements Division
490 Jarvis Drive
Morgan Hill, CA 95037-2809
USA

declares that the product specified below:

Product Name: Synthesized CW / Sweep / Signal Generator

Model Number: 680XXB, 681XXB, 682XXB, 683XXB

conforms to the requirement of:

EMC Directive 89/336/EEC as amended by Council Directive 92/31/EEC & 93/68/EEC
Low Voltage Directive 73/23/EEC as amended by Council directive 93/68/EEC

Electromagnetic Interference:

Emissions: CISPR 11:1990/EN55011:1991 Group 1 Class A

Immunity: IEC 1000-4-2:1995/prEN50082-1:1995 - 4kV CD, 8kV AD
IEC 1000-4-3:1993/ENV50140:1994 - 3V/m
IEC 1000-4-4:1995/prEN50082-1:1995 - 0.5kV SL, 1kV PL
IEC 1000-4-5:1995/prEN50082-1:1995 - 0.5kV - 1kV LN
0.5kV - 1kV NG
0.5kV - 1kV GL

Electrical Safety Requirement:

Product Safety: IEC 1010-1:1990 + A1/EN61010-1:1993

Morgan Hill, CA

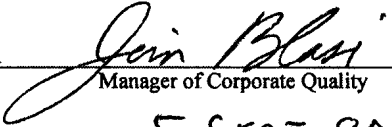

Manager of Corporate Quality
5-SEPT-97
Date

European Contact: For Anritsu product EMC & LVD information, contact Anritsu LTD, Rutherford Close,
Stevenage Herts, SG1 2EF UK, (FAX 44-1438-740202)

Safety Symbols

To prevent the risk of personal injury or loss related to equipment malfunction, ANRITSU Company uses the following symbols to indicate safety-related information. For your own safety, please read the information carefully BEFORE operating the equipment.

WARNING

WARNING indicates a hazard. It calls attention to a procedure that could result in personal injury or loss of life if not performed properly. Do not proceed beyond a WARNING notice until the indicated conditions are fully understood and met.

CAUTION

CAUTION indicates a hazard. It calls attention to a procedure which, if not performed properly, could result in damage to or destruction of a component of the instrument. Do not proceed beyond a CAUTION note until the indicated conditions are fully understood and met.



The instrument is marked with this symbol to indicate that it is necessary for the user to refer to the instructions in the operation manual.



Indicates ground.



Indicates heavy weight equipment.

For Safety



WARNING

When supplying power to this equipment, **always** use a three-wire power cable connected to a three-wire power line outlet. If power is supplied without grounding the equipment in this manner, there is a risk of receiving a severe or fatal electric shock.



WARNING

Before changing the fuse, **always** remove the power cord from the power outlet. There is the risk of receiving a fatal electric shock if the fuse is replaced with the power cord connected.

Always use a new fuse of the type and rating specified by the fuse markings on the rear panel of the instrument.

WARNING

There are no operator serviceable components inside. Refer servicing of the instrument to qualified service technicians.

To prevent the risk of electrical shock or damage to precision components, **do not** remove the equipment covers.



WARNING

Use two or more people to lift and move this equipment, or use an equipment cart. There is a risk of back injury, if this equipment is lifted by one person.

Table of Contents

Chapter 1 - General Information

1-1	SCOPE OF MANUAL	1-3
1-2	INTRODUCTION	1-3
1-3	DESCRIPTION	1-3
1-4	IDENTIFICATION NUMBER	1-8
1-5	ELECTRONIC MANUAL	1-8
1-6	RELATED MANUALS	1-8
	GPIB Programming Manual	1-8
	SCPI Programming Manual	1-8
	Maintenance Manual	1-9
1-7	OPTIONS	1-9
1-8	PERFORMANCE SPECIFICATIONS	1-10
1-9	RECOMMENDED TEST EQUIPMENT	1-11

Chapter 2 - Installation

2-1	INTRODUCTION	2-3
2-2	INITIAL INSPECTION	2-3
2-3	PREPARATION FOR USE	2-4
	Power Requirements	2-4
	Line Voltage Selection	2-4
	Power Connection	2-4
	Standby Operation	2-5
	Warmup Time	2-6
	Operating Environment	2-6
2-4	GPIB SETUP AND INTERCONNECTION	2-7
	Interface Connector	2-7
	Cable Length Restrictions	2-7
	GPIB Interconnection	2-7
	Setting the GPIB Address	2-7
	Selecting the Line Terminator	2-9
	Selecting the Interface Language	2-9
2-5	RACK MOUNTING KIT INSTALLATION	2-10
	Preliminary	2-10
	Procedure	2-10

Table of Contents (Continued)

2-6	PREPARATION FOR STORAGE/SHIPMENT . . .	2-13
	Preparation for Storage	2-13
	Preparation for Shipment	2-13

Chapter 3 - Local (Front Panel) Operation

3-1	INTRODUCTION	3-5
3-2	FRONT PANEL LAYOUT.	3-6
	Line Key	3-6
	Data Display Area	3-6
	Data Entry Area.	3-7
	RF Output Control Key	3-7
	Connectors	3-7
3-3	DATA DISPLAY AREA	3-8
	Menu Display Format	3-9
	Menu Keys	3-10
3-4	DATA ENTRY AREA.	3-12
3-5	INSTRUMENT START-UP	3-14
	Powering Up the 682XXB/683XXB	3-14
	Start-Up Display	3-14
	Standby Operation	3-14
	Self-Testing the 682XXB/683XXB	3-15
	Resetting to Default Parameters	3-15
3-6	ENTERING DATA	3-18
	Opening the Parameter.	3-18
	Editing the Current Value	3-19
	Entering a New Value	3-20
3-7	CW FREQUENCY OPERATION	3-21
	Selecting CW Mode.	3-21
	Selecting a CW Frequency	3-21
	Selecting a Power Level.	3-23
	CW Ramp	3-24
3-8	SWEEP FREQUENCY OPERATION.	3-25
	Selecting Analog Sweep Mode.	3-25
	Setting the Analog Sweep Time.	3-26
	Selecting a Sweep Trigger	3-27
	Selecting Step Sweep Mode	3-28
	Setting Step Size and Dwell Time.	3-29

Table of Contents (Continued)

	Selecting Manual Sweep Mode	3-30
	Selecting a Sweep Range	3-31
	Selecting a Power Level.	3-33
	Frequency Markers.	3-34
	Selecting Alternate Sweep Mode	3-36
3-9	FIXED POWER LEVEL OPERATION	3-39
	Selecting Fixed Power Level Mode	3-39
	Selecting a Power Level.	3-39
	Level Offset	3-42
3-10	POWER LEVEL SWEEP OPERATION.	3-43
	Selecting CW Power Sweep Mode	3-43
	Setting CW Power Sweep Step Size and Dwell Time	3-44
	Selecting a CW Power Sweep Trigger	3-45
	Selecting a Power Level Sweep Range.	3-46
	Selecting a Sweep Frequency/Step Power Mode	3-48
	Setting Power Level Step Size	3-49
3-11	LEVELING OPERATIONS	3-50
	Selecting a Leveling Mode	3-50
	Attenuator Decoupling	3-54
	ALC Power Slope.	3-55
	User Cal (User Level Flatness Correction)	3-57
3-12	SIGNAL MODULATION	3-63
	Amplitude Modulation Operating Modes	3-63
	Providing Amplitude Modulation	3-63
	Frequency Modulation Operating Modes	3-68
	Providing Frequency Modulation	3-68
	Phase Modulation Operating Modes.	3-73
	Providing Phase Modulation	3-73
	Pulse Modulation Operating Modes	3-77
	Providing Pulse Modulation.	3-78
3-13	SYSTEM CONFIGURATION	3-86
	Configuring the Front Panel	3-87
	Configuring the Rear Panel.	3-88
	Configuring the RF.	3-89
	Configuring the GPIB	3-91
	Setting Increment Sizes	3-94
3-14	SAVING/RECALLING INSTRUMENT SETUPS	3-95
	Saving Setups	3-95

Table of Contents (Continued)

	Recalling Setups	3-95
	Erasing Stored Setups	3-96
3-15	SECURE OPERATION	3-97
3-16	SCAN MODULATION (OPTION 20)	3-98
3-17	INTERNAL POWER METER (OPTION 8)	3-99
3-18	REFERENCE OSCILLATOR CALIBRATION	3-100

Chapter 4 - Local Operation–Menu Maps

4-1	INTRODUCTION	4-3
4-2	MENU MAP DESCRIPTION	4-3

Chapter 5 - Operation Verification

5-1	INTRODUCTION	5-3
5-2	TEST EQUIPMENT.	5-3
5-3	TEST RECORDS	5-3
5-4	INITIAL 682XXB/683XXB CHECKOUT	5-4
	Power Up	5-4
	Self Test.	5-4
	Resetting the Signal Generator	5-4
	Warmup Time	5-4
5-5	CW FREQUENCY ACCURACY TEST.	5-5
	Test Setup.	5-5
	Test Procedure.	5-6
5-6	POWER LEVEL ACCURACY AND FLATNESS TESTS.	5-13
	Test Setup	5-13
	Power Level Accuracy Test Procedure	5-14
	Power Level Flatness Test Procedure	5-15

Chapter 6 - Operator Maintenance

6-1	INTRODUCTION	6-3
6-2	ERROR AND WARNING/STATUS MESSAGES.	6-3
	Self-Test Error Messages.	6-3
	Normal Operation Error and Warning/ Status Messages	6-8

Table of Contents (Continued)

6-3	TROUBLESHOOTING	6-11
6-4	ROUTINE MAINTENANCE	6-14
	Cleaning the Fan Filter.	6-14
	Cleaning the Data Display	6-15
	Replacing the Line Fuse	6-15

Chapter 7 - Use With Other Instruments

7-1	INTRODUCTION	7-3
7-2	MASTER-SLAVE OPERATION	7-4
	Connecting the 68XXXBs	7-4
	Initiating Master-Slave Operation	7-5
	Master-Slave Operation	7-7
	Master-Slave Operation in VNA Mode	7-7
	Terminating Master-Slave Operation	7-9
7-3	USE WITH A 562 SCALAR NETWORK ANALYZER	7-10
	Connecting the 682XXB/683XXB to the 562	7-10
7-4	USE WITH A 360B VECTOR NETWORK ANALYZER	7-11
	Connecting the 682XXB/683XXB to the 360B	7-11
	Modes of Operation.	7-12
	Source Lock Mode	7-12
	Tracking Mode	7-14
7-5	USE WITH A 8003 SCALAR NETWORK ANALYZER	7-16
	Connecting the 682XXB/683XXB to the 8003	7-16
	Setting Up the 682XXB/683XXB	7-17
	Initiating 8003 SNA Operation	7-18
7-6	USE WITH A HP8757D SCALAR NETWORK ANALYZER	7-20
	Connecting the 682XXB/683XXB to the HP8757D	7-20
	Setting up the 682XXB/683XXB.	7-21
	Initiating HP8757D SNA Operation.	7-23

Appendix A - Rear Panel Connectors

A-1	INTRODUCTION.	A-1
A-2	REAR PANEL CONNECTORS	A-1

Table of Contents (Continued)

A-3 CONNECTOR PINOUT DIAGRAMS A-1

Appendix B - Performance Specifications

B-1 INTRODUCTION. B-1

Series 682XXB - Synthesized Signal Generator
Performance Specifications B-3

Series 683XXB - Synthesized Signal Generator
Performance Specifications. B-13

Chapter 1

General Information

Table of Contents

1-1	SCOPE OF MANUAL	1-3
1-2	INTRODUCTION	1-3
1-3	DESCRIPTION	1-3
1-4	IDENTIFICATION NUMBER	1-8
1-5	ELECTRONIC MANUAL	1-8
1-6	RELATED MANUALS	1-8
	GPIB Programming Manual	1-8
	SCPI Programming Manual	1-8
	Maintenance Manual	1-9
1-7	OPTIONS	1-9
1-8	PERFORMANCE SPECIFICATIONS	1-10
1-9	RECOMMENDED TEST EQUIPMENT	1-11



Figure 1-1. Series 682XXB/683XXB Synthesized Signal Generator

Chapter 1

General Information

1-1 SCOPE OF MANUAL

This manual provides general information, installation, and operating information for the ANRITSU Series 682XXB/683XXB Synthesized Signal Generators. (Throughout this manual, the terms *682XXB/683XXB* and *signal generator* will be used interchangeably to refer to the instruments.) Manual organization is shown in the table of contents.

1-2 INTRODUCTION

This chapter contains general information about the series 682XXB/683XXB signal generators. It includes a general description of the instruments and information on their identification number, related manuals, options, and performance specifications. A listing of recommended test equipment is also provided.

1-3 DESCRIPTION

The Series 682XXB Synthesized Signal Generator and the Series 683XXB Synthesized Signal Generator are microprocessor-based, synthesized signal sources with high resolution phase-lock capability. They generate both discrete CW frequencies and broad (full range) and narrow band sweeps across the frequency range of 10 MHz to 65 GHz. All functions of the signal generators are fully controllable locally from the front panel or remotely (except for power on/standby) via the IEEE-488 General Purpose Interface Bus (GPIB).

The Series 682XXB Synthesized Signal Generator and the Series 683XXB Synthesized Signal Generator each presently consist of 15 models covering a variety of frequency and power ranges. Table 1-1, pages 1-4 and 1-5, lists series 682XXB models, frequency ranges, and maximum leveled output; Table 1-2, pages 1-6 and 1-7, lists series 683XXB models, frequency ranges, and maximum leveled output.

Table 1-1. Series 682XXB Models (1 of 2)

682XXB Model	Frequency (GHz)	Output Power	Output Power w/Step Attenuator
68237B	2.0 – 20.0 GHz	+13.0 dBm	+11.0 dBm
68245B	0.5 – 20.0 GHz	+13.0 dBm	+11.0 dBm
68247B	0.01 – 20.0 GHz	+13.0 dBm	+11.0 dBm
68253B	2.0 – 20.0 GHz	+9.0 dBm	+7.0 dBm
	20.0 – 26.5 GHz	+6.0 dBm	+3.5 dBm
68255B	0.5 – 2.2 GHz	+13.0 dBm	+11.0 dBm
	2.2 – 20.0 GHz	+9.0 dBm	+7.0 dBm
	20.0 – 26.5 GHz	+6.0 dBm	+3.5 dBm
68259B	0.01 – 2.0 GHz	+13.0 dBm	+11.0 dBm
	2.0 – 20.0 GHz	+9.0 dBm	+7.0 dBm
	20.0 – 26.5 GHz	+6.0 dBm	+3.5 dBm
68263B	2.0 – 20.0 GHz	+9.0 dBm	+7.0 dBm
	20.0 – 40.0 GHz	+6.0 dBm	+3.0 dBm
68265B	0.5 – 2.2 GHz	+13.0 dBm	+11.0 dBm
	2.2 – 20.0 GHz	+9.0 dBm	+7.0 dBm
	20.0 – 40.0 GHz	+6.0 dBm	+3.0 dBm
68269B	0.01 – 2.0 GHz	+13.0 dBm	+11.0 dBm
	2.0 – 20.0 GHz	+9.0 dBm	+7.0 dBm
	20.0 – 40.0 GHz	+6.0 dBm	+3.0 dBm
68275B	0.5 – 2.2 GHz	+11.0 dBm	+10.0 dBm
	2.2 – 20.0 GHz	+10.0 dBm	+8.5 dBm
	20.0 – 40.0 GHz	+2.5 dBm	0.0 dBm
	40.0 – 50.0 GHz	+2.5 dBm	-1.0 dBm
68277B	0.01 – 2.0 GHz	+12.0 dBm	+10.0 dBm
	2.0 – 20.0 GHz	+10.0 dBm	+8.5 dBm
	20.0 – 40.0 GHz	+2.5 dBm	0.0 dBm
	40.0 – 50.0 GHz	+2.5 dBm	-1.0 dBm
68285B	0.5 – 2.2 GHz	+11.0 dBm	+10.0 dBm
	2.2 – 20.0 GHz	+10.0 dBm	+8.5 dBm
	20.0 – 40.0 GHz	+2.5 dBm	0.0 dBm
	40.0 – 50.0 GHz	+2.0 dBm	-1.5 dBm
	50.0 – 60.0 GHz	+2.0 dBm	-2.0 dBm
68287B	0.01 – 2.0 GHz	+12.0 dBm	+10.0 dBm
	2.0 – 20.0 GHz	+10.0 dBm	+8.5 dBm
	20.0 – 40.0 GHz	+2.5 dBm	0.0 dBm
	40.0 – 50.0 GHz	+2.0 dBm	-1.5 dBm
	50.0 – 60.0 GHz	+2.0 dBm	-2.0 dBm
68295B	0.5 – 2.2 GHz	+11.0 dBm	Not Available
	2.2 – 20.0 GHz	+10.0 dBm	
	20.0 – 40.0 GHz	+2.5 dBm	
	40.0 – 50.0 GHz	0.0 dBm	
	50.0 – 65.0 GHz	-2.0 dBm	

Table 1-1. Series 682XXB Models (2 of 2)

682XXB Model	Frequency (GHz)	Output Power	Output Power w/Step Attenuator
68297B	0.01 – 2.0 GHz	+12.0 dBm	Not Available
	2.0 – 20.0 GHz	+10.0 dBm	
	20.0 – 40.0 GHz	+2.5 dBm	
	40.0 – 50.0 GHz	0.0 dBm	
	50.0 – 65.0 GHz	-2.0 dBm	
With Option 15B (High Power) Installed			
68237B	2.0 – 20.0 GHz	+17.0 dBm	+15.0 dBm
68245B	0.5 – 2.2 GHz	+13.0 dBm	+11.0 dBm
	2.2 – 20.0 GHz	+17.0 dBm	+15.0 dBm
68247B	0.01 – 2.0 GHz	+13.0 dBm	+11.0 dBm
	2.0 – 20.0 GHz	+17.0 dBm	+15.0 dBm
68253B	2.0 – 20.0 GHz	+13.0 dBm	+11.0 dBm
	20.0 – 26.5 GHz	+10.0 dBm	+7.5 dBm
68255B	0.5 – 2.2 GHz	+13.0 dBm	+11.0 dBm
	2.2 – 20.0 GHz	+13.0 dBm	+11.0 dBm
	20.0 – 26.5 GHz	+10.0 dBm	+7.5 dBm
68259B	0.01 – 2.0 GHz	+13.0 dBm	+11.0 dBm
	2.0 – 20.0 GHz	+13.0 dBm	+11.0 dBm
	20.0 – 26.5 GHz	+10.0 dBm	+7.5 dBm
68263B	2.0 – 20.0 GHz	+13.0 dBm	+11.0 dBm
	20.0 – 40.0 GHz	+6.0 dBm	+3.0 dBm
68265B	0.5 – 2.2 GHz	+13.0 dBm	+11.0 dBm
	2.2 – 20.0 GHz	+13.0 dBm	+11.0 dBm
	20.0 – 40.0 GHz	+6.0 dBm	+3.0 dBm
68269B	0.01 – 2.0 GHz	+13.0 dBm	+11.0 dBm
	2.0 – 20.0 GHz	+13.0 dBm	+11.0 dBm
	20.0 – 40.0 GHz	+6.0 dBm	+3.0 dBm
68275B	0.5 – 50.0 GHz	Standard	Standard
68277B	0.01 – 50.0 GHz	Standard	Standard
68285B	0.5 – 60.0 GHz	Standard	Standard
68287B	0.01 – 60.0 GHz	Standard	Standard
68295B	0.5 – 65.0 GHz	Standard	Not Available
68297B	0.01 – 65.0 GHz	Standard	Not Available

Table 1-2. Series 683XXB Models (1 of 2)

683XXB Model	Frequency (GHz)	Output Power	Output Power w/Step Attenuator
68337B	2.0 – 20.0 GHz	+13.0 dBm	+11.0 dBm
68345B	0.5 – 20.0 GHz	+13.0 dBm	+11.0 dBm
68347B	0.01 – 20.0 GHz	+13.0 dBm	+11.0 dBm
68353B	2.0 – 20.0 GHz	+9.0 dBm	+7.0 dBm
	20.0 – 26.5 GHz	+6.0 dBm	+3.5 dBm
68355B	0.5 – 2.2 GHz	+13.0 dBm	+11.0 dBm
	2.2 – 20.0 GHz	+9.0 dBm	+7.0 dBm
	20.0 – 26.5 GHz	+6.0 dBm	+3.5 dBm
68359B	0.01 – 2.0 GHz	+13.0 dBm	+11.0 dBm
	2.0 – 20.0 GHz	+9.0 dBm	+7.0 dBm
	20.0 – 26.5 GHz	+6.0 dBm	+3.5 dBm
68363B	2.0 – 20.0 GHz	+9.0 dBm	+7.0 dBm
	20.0 – 40.0 GHz	+6.0 dBm	+3.0 dBm
68365B	0.5 – 2.2 GHz	+13.0 dBm	+11.0 dBm
	2.2 – 20.0 GHz	+9.0 dBm	+7.0 dBm
	20.0 – 40.0 GHz	+6.0 dBm	+3.0 dBm
68369B	0.01 – 2.0 GHz	+13.0 dBm	+11.0 dBm
	2.0 – 20.0 GHz	+9.0 dBm	+7.0 dBm
	20.0 – 40.0 GHz	+6.0 dBm	+3.0 dBm
68375B	0.5 – 2.2 GHz	+11.0 dBm	+10.0 dBm
	2.2 – 20.0 GHz	+10.0 dBm	+8.5 dBm
	20.0 – 40.0 GHz	+2.5 dBm	0.0 dBm
	40.0 – 50.0 GHz	+2.5 dBm	-1.0 dBm
68377B	0.01 – 2.0 GHz	+12.0 dBm	+10.0 dBm
	2.0 – 20.0 GHz	+10.0 dBm	+8.5 dBm
	20.0 – 40.0 GHz	+2.5 dBm	0.0 dBm
	40.0 – 50.0 GHz	+2.5 dBm	-1.0 dBm
68385B	0.5 – 2.2 GHz	+11.0 dBm	+10.0 dBm
	2.2 – 20.0 GHz	+10.0 dBm	+8.5 dBm
	20.0 – 40.0 GHz	+2.5 dBm	0.0 dBm
	40.0 – 50.0 GHz	+2.0 dBm	-1.5 dBm
	50.0 – 60.0 GHz	+2.0 dBm	-2.0 dBm
68387B	0.01 – 2.0 GHz	+12.0 dBm	+10.0 dBm
	2.0 – 20.0 GHz	+10.0 dBm	+8.5 dBm
	20.0 – 40.0 GHz	+2.5 dBm	0.0 dBm
	40.0 – 50.0 GHz	+2.0 dBm	-1.5 dBm
	50.0 – 60.0 GHz	+2.0 dBm	-2.0 dBm
68395B	0.5 – 2.2 GHz	+11.0 dBm	Not Available
	2.2 – 20.0 GHz	+10.0 dBm	
	20.0 – 40.0 GHz	+2.5 dBm	
	40.0 – 50.0 GHz	0.0 dBm	
	50.0 – 65.0 GHz	-2.0 dBm	

Table 1-2. Series 683XXB Models (2 of 2)

683XXB Model	Frequency (GHz)	Output Power	Output Power w/Step Attenuator
68397B	0.01 – 2.0 GHz	+12.0 dBm	Not Available
	2.0 – 20.0 GHz	+10.0 dBm	
	20.0 – 40.0 GHz	+2.5 dBm	
	40.0 – 50.0 GHz	0.0 dBm	
	50.0 – 65.0 GHz	-2.0 dBm	
With Option 15B (High Power) Installed			
68337B	2.0 – 20.0 GHz	+17.0 dBm	+15.0 dBm
68345B	0.5 – 2.2 GHz	+13.0 dBm	+11.0 dBm
	2.2 – 20.0 GHz	+17.0 dBm	+15.0 dBm
68347B	0.01 – 2.0 GHz	+13.0 dBm	+11.0 dBm
	2.0 – 20.0 GHz	+17.0 dBm	+15.0 dBm
68353B	2.0 – 20.0 GHz	+13.0 dBm	+11.0 dBm
	20.0 – 26.5 GHz	+10.0 dBm	+7.5 dBm
68355B	0.5 – 2.2 GHz	+13.0 dBm	+11.0 dBm
	2.2 – 20.0 GHz	+13.0 dBm	+11.0 dBm
	20.0 – 26.5 GHz	+10.0 dBm	+7.5 dBm
68359B	0.01 – 2.0 GHz	+13.0 dBm	+11.0 dBm
	2.0 – 20.0 GHz	+13.0 dBm	+11.0 dBm
	20.0 – 26.5 GHz	+10.0 dBm	+7.5 dBm
68363B	2.0 – 20.0 GHz	+13.0 dBm	+11.0 dBm
	20.0 – 40.0 GHz	+6.0 dBm	+3.0 dBm
68365B	0.5 – 2.2 GHz	+13.0 dBm	+11.0 dBm
	2.2 – 20.0 GHz	+13.0 dBm	+11.0 dBm
	20.0 – 40.0 GHz	+6.0 dBm	+3.0 dBm
68369B	0.01 – 2.0 GHz	+13.0 dBm	+11.0 dBm
	2.0 – 20.0 GHz	+13.0 dBm	+11.0 dBm
	20.0 – 40.0 GHz	+6.0 dBm	+3.0 dBm
68375B	0.5 – 50.0 GHz	Standard	Standard
68377B	0.01 – 50.0 GHz	Standard	Standard
68385B	0.5 – 60.0 GHz	Standard	Standard
68387B	0.01 – 60.0 GHz	Standard	Standard
68395B	0.5 – 65.0 GHz	Standard	Not Available
68397B	0.01 – 65.0 GHz	Standard	Not Available

**1-4 IDENTIFICATION
NUMBER**

All ANRITSU instruments are assigned a unique six-digit ID number, such as “402001.” The ID number is imprinted on a decal that is affixed to the rear panel of the unit. Special-order instrument configurations also have an additional *special* serial number tag attached to the rear panel of the unit.

When ordering parts or corresponding with ANRITSU Customer Service, please use the correct serial number with reference to the specific instrument’s model number (i.e., Model 68347B Synthesized Signal Generator, Serial No. 402001).

1-5 ELECTRONIC MANUAL

This manual is available on CD ROM as an Adobe Acrobat Portable Document Format (*.pdf) file. The file can be viewed using Acrobat Reader, a free program that is also included on the CD ROM. The file is “linked” such that the viewer can choose a topic to view from the displayed “bookmark” list and “jump” to the manual page on which the topic resides. The text can also be word-searched. Contact ANRITSU Customer Service for price and availability.

1-6 RELATED MANUALS

This is one of a four manual set that consists of an Operation Manual, a GPIB Programming Manual, a SCPI Programming Manual, and a Maintenance Manual.

***GPIB Pro-
gramming
Manual***

This manual provides information for remote operation of the signal generator with Product Specific commands sent from an external controller via the IEEE 488 General Purpose Interface Bus (GPIB). It contains a general description of the GPIB and bus data transfer and control functions, a complete listing and description of all 682XXB/683XXB GPIB Product Specific commands, and several programming examples. The ANRITSU part number for the GPIB Programming Manual is 10370-10286.

***SCPI Pro-
gramming
Manual***

This manual provides information for remote operation of the signal generator with Standard Commands for Programmable Instruments (SCPI) commands sent from an external controller via the IEEE 488 General Purpose Interface Bus (GPIB). It contains a general description of the GPIB and bus data transfer and control functions, a complete listing and description of each command in the 682XXB/683XXB SCPI command set, and examples of command usage. The ANRITSU part number for the SCPI Programming Manual is 10370-10288.

Maintenance Manual The Maintenance Manual supplies service information for all models in the 682XXB/683XXB series. The service information includes functional circuit descriptions, block diagrams, performance verification tests, calibration procedures, troubleshooting data, and assembly and component removal/replacement procedures. The ANRITSU part number for the Maintenance Manual is 10370-10290.

1-7 OPTIONS

The following options are available.

Option 1, Rack Mounting. Rack mount kit containing a set of track slides (90° tilt capability), mounting ears, and front panel handles for mounting the instrument in a standard 19-inch equipment rack.

Option 2A, 110 dB Step Attenuator. Adds a 10 dB per step attenuator with a 110 dB range for models having a high-end frequency of ≤ 26.5 GHz. Output power is selected directly in dBm on the front panel (or via GPIB). Rated RF output power is reduced.

Option 2B, 110 dB Step Attenuator. Adds a 10 dB per step attenuator with a 110 dB range for models having a high-end frequency of ≤ 40 GHz. Output power is selected directly in dBm on the front panel (or via GPIB). Rated RF output power is reduced.

Option 2C, 90 dB Step Attenuator. Adds a 10 dB per step attenuator with a 90 dB range for models having a high-end frequency of ≤ 50 GHz. Output power is selected directly in dBm on the front panel (or via GPIB). Rated RF output power is reduced.

Option 2D, 90 dB Step Attenuator. Adds a 10 dB per step attenuator with a 90 dB range for modes having a high-end frequency of ≤ 60 GHz. Output power is selected directly in dBm on the front panel (or via GPIB). Rated RF output power is reduced.

Option 6, Phase Modulation (Φ M). Adds phase modulation capability. The internal FM generator becomes the FM/ Φ M generator. (Not available in combination with Option 7.)

Option 7, Delete AM/FM Generator. Deletes the internal AM and FM generators. External AM and FM capability remains unchanged. (Not available in combination with Options 6, 8, or 20.)

Option 8, Internal Power Meter. Adds an internal power meter that is compatible with ANRITSU 560-7, 5400-71, or 6400-71 series detectors. (Not available in combination with Option 7.)

Option 9, Rear Panel RF Output. Moves the RF output connector to the rear panel.

Option 10, Complex Modulation Capability. Provides user-defined waveform capability for complex modulation. Requires a computer/controller (not included). Includes cable and Windows based software. (Not available in combination with Option 7.)

Option 11, 0.1 Hz Frequency Resolution. Provides frequency resolution of 0.1 Hz.

Option 14, ANRITSU 360B VNA Compatibility. Modifies rack mounting hardware to mate unit in a ANRITSU 360B VNA console.

Option 15B, High Power Output. Adds high-power RF components to the instrument providing increased RF output power in the 2–26.5 GHz frequency range. Option 15B is standard in models having a high-end frequency that is >40 GHz.

Option 16, High-Stability Time Base. Adds an ovenized, 10 MHz crystal oscillator with $<5 \times 10^{-10}$ /day frequency stability.

Option 17A, No Front Panel. Deletes the front panel for use in remote control applications where a front panel display or keyboard control are not needed.

Option 18, mmWave Module Bias Output. Provides bias output for 54000-xWRxx Millimeter Wave Source Modules. BNC Twinax connector, rear panel. (Not available in combination with Option 20.)

Option 19, SCPI Programmability. Adds GPIB command mnemonics complying with Standard Commands for Programmable Instruments (SCPI), Version 1993.0. SCPI programming complies with IEEE 488.2-1987.

Option 20, SCAN Modulator. Adds an internal SCAN modulator for simulating high-depth amplitude modulated signals in models 68237B/68337B, 68245B/68345B, and 68247B/68347B only. Requires an external modulating signal. (Not available in combination with Option 7 or 18.)

1-8 PERFORMANCE SPECIFICATIONS

Series 682XXB Synthesized Signal Generator and Series 683XXB Synthesized Signal Generator performance specifications are provided in Appendix B.

**1-9 RECOMMENDED TEST
EQUIPMENT**

Table 1-3 lists the recommended test equipment for performing the Series 682XXB/683XXB Synthesized Signal Generator operation verification tests in Chapter 5.

Table 1-3. Recommended Test Equipment

Instrument	Critical Specification	Recommended Manufacturer/Model
Frequency Counter, with Cable Kit and External Mixer	<i>Range:</i> 0.01 to 65 GHz <i>Input Z:</i> 50Ω <i>Resolution:</i> 1 Hz <i>Other:</i> External Time Base Input	EIP Microwave, Inc. Models 538B, 548B, or 578B, with Cable Kit: Option 590 and External Mixer: Option 91 (26.5 to 40 GHz) Option 92 (40 to 60 GHz) Option 93 (60 to 90 GHz)
Power Meter, with Power Sensor	<i>Range:</i> -30 to +20 dBm (1μW to 100 mW)	Hewlett-Packard Model 437B, with Power Sensor: HP 8487A (0.05 to 50 GHz)
Oscilloscope	<i>Bandwidth:</i> DC to 150 MHz <i>Vertical Sensitivity:</i> 2 mV/division <i>Horiz Sensitivity:</i> 50 ns/division	Tektronix, Inc. Model TAS485
Adapter	K (male) to 2.4 mm (female) Adapts the Power Sensor, HP 8487A, to the 682XXB/683XXB RF OUTPUT connector (≤40 GHz models)	Hewlett-Packard Part Number: HP 11904D

Chapter 2

Installation

Table of Contents

2-1	INTRODUCTION	2-3
2-2	INITIAL INSPECTION	2-3
2-3	PREPARATION FOR USE	2-4
	Power Requirements	2-4
	Line Voltage Selection	2-4
	Power Connection	2-4
	Standby Operation	2-5
	Warmup Time	2-6
	Operating Environment	2-6
2-4	GPIB SETUP AND INTERCONNECTION	2-7
	Interface Connector	2-7
	Cable Length Restrictions	2-7
	GPIB Interconnection	2-7
	Setting the GPIB Address	2-7
	Selecting the Line Terminator	2-9
	Selecting the Interface Language	2-9
2-5	RACK MOUNTING KIT INSTALLATION	2-10
	Preliminary	2-10
	Procedure	2-10
2-6	PREPARATION FOR STORAGE/SHIPMENT	2-13
	Preparation for Storage	2-13
	Preparation for Shipment	2-13

Chapter 2

Installation

2-1 INTRODUCTION

This chapter provides installation instructions for the Series 682XXB/683XXB Synthesized Signal Generators. It includes information on initial inspection, preparation for use, storage, and reshipment, and General Purpose Interface Bus (GPIB) setup and interconnections.



WARNING

Use two or more people to lift and move this equipment, or use an equipment cart. There is a risk of back injury, if this equipment is lifted by one person.

2-2 INITIAL INSPECTION

Inspect the shipping container for damage. If the shipping container or cushioning material is damaged, retain until the contents of the shipment have been checked against the packing list and the signal generator has been checked for mechanical and electrical operation.

If the shipment is incomplete or if the signal generator is damaged mechanically or electrically, notify your local sales representative or ANRITSU Customer Service. If either the shipping container is damaged or the cushioning material shows signs of stress, notify the carrier as well as ANRITSU. Keep the shipping materials for the carrier's inspection.

2-3 PREPARATION FOR USE

Preparation for use consists of checking that the rear panel line voltage selector switch is set for the correct line voltage and connecting the signal generator to the power source. The following paragraphs provide these procedures along with information about power requirements, warmup times, and the operating environment.

Power Requirements The signal generator accepts 90 to 132 Vac and 180 to 264 Vac, 48 to 400 Hz, single-phase power. Power consumption is 400 VA maximum. The signal generator is intended for Installation Category (Over-voltage Category) II.



CAUTION

Before applying power, verify that the unit is set to match the available line voltage and that the installed fuse is of the correct type and rating.

Line Voltage Selection

The line voltage selector switch on the rear panel can be set for either 110 Vac or 220 Vac operation (Figure 2-1). When the switch is set to 110 Vac, the 682XXB/683XXB accepts 90 to 132 Vac line voltage. When the switch is set to 220 Vac, the 682XXB/683XXB accepts 180 to 264 Vac line voltage. If the selector setting is incorrect for the line voltage available, change it to the correct setting.

Whenever the selector setting is changed, the line fuse must be changed to the correct value for the line voltage selected. Line fuse values for the line voltages are printed on the rear panel next to the fuse holder.



WARNING

When supplying power to this equipment, **always** use a three-wire power cable connected to a three-wire power line outlet. If power is supplied without grounding the equipment in this manner, there is a risk of receiving a severe or fatal electric shock.

Power Connection

Connecting the 682XXB/683XXB to line power automatically places it in operation (front panel OPER-ATE LED on). To connect it to the power source, plug the female end of the power cable into the input line voltage receptacle on the rear panel (Figure 2-1). Then plug the male end of the power cord into a three-wire power line outlet.

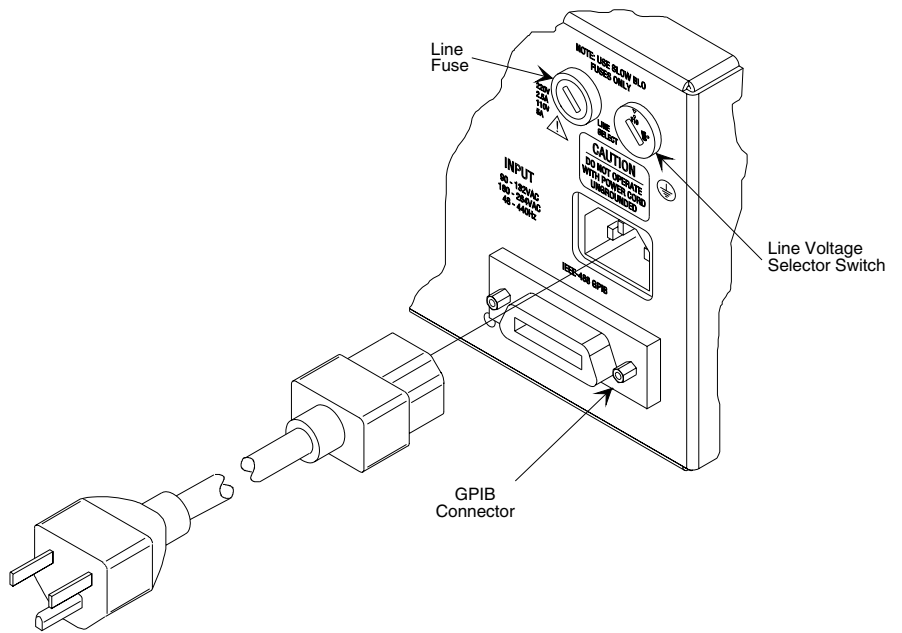
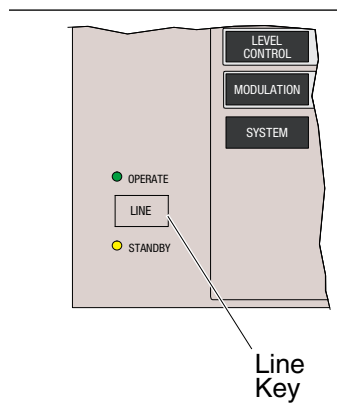

Figure 2-1. Signal Generator Rear Panel showing Power Connection



**Standby
Operation**

Whenever the signal generator is not being used it should be left connected to the power source and placed in standby. This keeps the internal timebase frequency reference at operating temperature.

On the front panel, press **LINE** to switch the 682XXB/683XXB from OPERATE (green LED on) to STANDBY (orange LED on).

NOTE

During standby operation, the fan runs continuously.

Warmup Time From a cold start (ac power application), the signal generator requires approximately 120 hours (5 days) of warm up to achieve 2×10^{-8} /day frequency accuracy and stability.

If the Option 16 time base is installed, the 682XXB/683XXB requires approximately 120 hours (5 days) of warm up to achieve 5×10^{-10} /day frequency accuracy and stability. Instruments disconnected from AC power for more than 72 hours require 30 days to return to specified aging.

When placing the 682XXB/683XXB in operation from stand-by, allow 30 minutes warmup to assure stable operation.

Operating Environment The 682XXB/683XXB can be operated within the following environmental limits.

- ❑ **Temperature.** 0°C to 50°C (-32°F to 122°F).
- ❑ **Humidity.** 5 to 95% relative at 40°C.
- ❑ **Altitude.** up to 4600 meters (approximately 15,000 feet).
- ❑ **Cooling.** Internal cooling is provided by forced airflow from the fan mounted on the rear panel.

CAUTION

Before installing the 682XXB/683XXB in its operating environment, ensure that all airflow passages at the sides and rear of the instrument are clear. This is of particular importance whenever the unit is being rack-mounted.

Keep the cooling fan filter clean so that the ventilation holes are not obstructed. A blocked fan filter can cause the instrument to overheat and shut down.

2-4 GPIB SETUP AND INTERCONNECTION

The 682XXB/683XXB provides automated microwave signal generation via the GPIB. The following paragraphs provide information about interface connections, cable requirements, setting the GPIB operating parameters, and selecting the external interface language.

Interface Connector

Interface between the signal generator and other devices on the GPIB is via a 24-wire interface cable. This cable uses connector shells having two connector faces. These double-faced connectors allow for the parallel connection of two or more cables to a single device. Figure 2-1 shows the location of the rear panel GPIB connector.

Cable Length Restrictions

The GPIB can accommodate up to 15 instruments at any one time. To achieve design performance on the bus, proper timing and voltage level relationships must be maintained. If either the cable length between separate instruments or the cumulative cable length between all instruments is too long, the data and control lines cannot be driven properly and the system may fail to perform. Cable length restrictions are as follows:

- No more than 15 instruments may be installed on the bus.
- Total cumulative cable length in meters may not exceed two times the number of bus instruments or 20 meters—whichever is less.

NOTE

For low EMI applications, the GPIB cable should be a fully shielded type, with well-grounded metal-shell connectors

GPIB Interconnection

The only interconnection required for GPIB operation is between the signal generator and the controller. This interconnection is via a standard GPIB cable. The ANRITSU Part number for such a cable is 2000-1, -2, or -4 (1, 2, or 4 meters in length).

Setting the GPIB Address

The default GPIB address is 5. If a different GPIB address is desired, it can be set from the front panel using the Configure GPIB Menu.

To change the GPIB address, first press the front panel main menu key labeled **SYSTEM**. The System Menu (shown on the following page) is displayed.

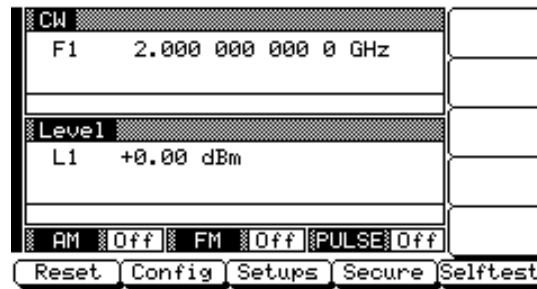

Now press the menu soft-key **Config**. The System Configuration Menu (below) is displayed.

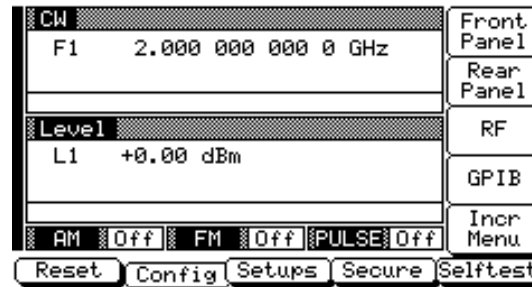

To go to the Configure GPIB menu from this menu, press the menu soft-key **GPIB**. The Configure GPIB Menu (below) is displayed.

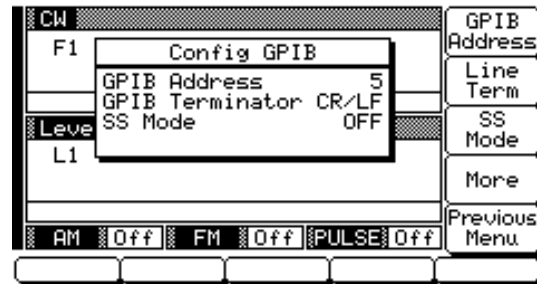

Press the menu soft-key **GPIB Address** to change the current GPIB address of the signal generator. Enter a new address using the cursor control key or the data entry keypad and the terminator key



The new GPIB address will now appear on the display. The entry must be between 1 and 30 to be recognized as a valid GPIB address.

Selecting the Line Terminator

Data is delimited on the GPIB by either the carriage return (CR) ASCII character or both the carriage return and line feed (CR/LF) ASCII characters. Which character is used depends upon the requirements of the system controller. Most modern controllers can use either CR or CR/LF, while many older controllers require one or the other. Consult the controller's manual for its particular requirements.

From the Configure GPIB Menu display, you can select which GPIB terminator to use by pressing the menu soft-key **Line Term**. This menu soft-key toggles the GPIB terminator between CR and CR/LF. The current selection appears on the display.

Selecting the Interface Language

Series 682XXB/683XXB Synthesized Signal Generators can be remotely operated via the GPIB using one of two external interface languages—Native or SCPI (Option 19). The Native interface language uses a set of 682XXB/683XXB GPIB Product Specific commands to control the instrument; the SCPI interface language uses a set of the Standard Commands for Programmable Instruments commands to control the unit.

The Configure GPIB Menu has additional menu displays. For instruments with Option 19, selection of which external interface language is to be used is made from the first additional menu. From the Configure GPIB Menu display, you can access the first additional menu by pressing **More**. The First Additional Configure GPIB Menu (below) is displayed.

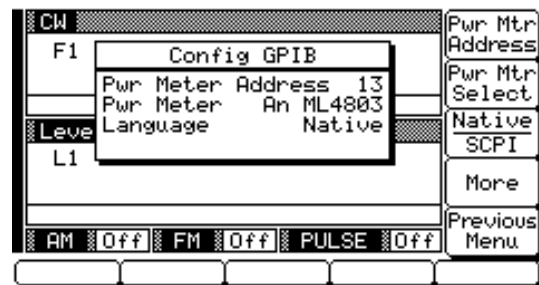

Press **Native/SCPI** to select the external interface language to be used. This menu soft-key toggles the language selection between Native and SCPI. The current selection appears on the display.

**2-5 RACK MOUNTING KIT
INSTALLATION**

The rack mounting kit (Option 1) contains a set of track slides (90° tilt capability), mounting ears, and front panel handles for mounting the signal generator in a standard 19-inch equipment rack. The following procedure provides instructions for installing the rack mounting hardware on the instrument. Refer to Figure 2-2 and 2-3 during this procedure.

Preliminary Disconnect the power cord and any other cables from the instrument.

Procedure Install the rack mounting hardware as follows:

Step 1 Using a Phillips screwdriver, remove the screws and the front handle assemblies from the instrument. (For instruments not having front handles, remove the screws and the front top and bottom feet from the instrument.) Retain the screws.

Step 2 Remove the four feet from the rear of the instrument. Retain the screws.

Step 3 Remove the screws and the carrying handle from the side handle cover. (The two screws fastening the carrying handle through the side handle cover to the chassis are accessible by lifting up the rubber covering at each end of the handle.)

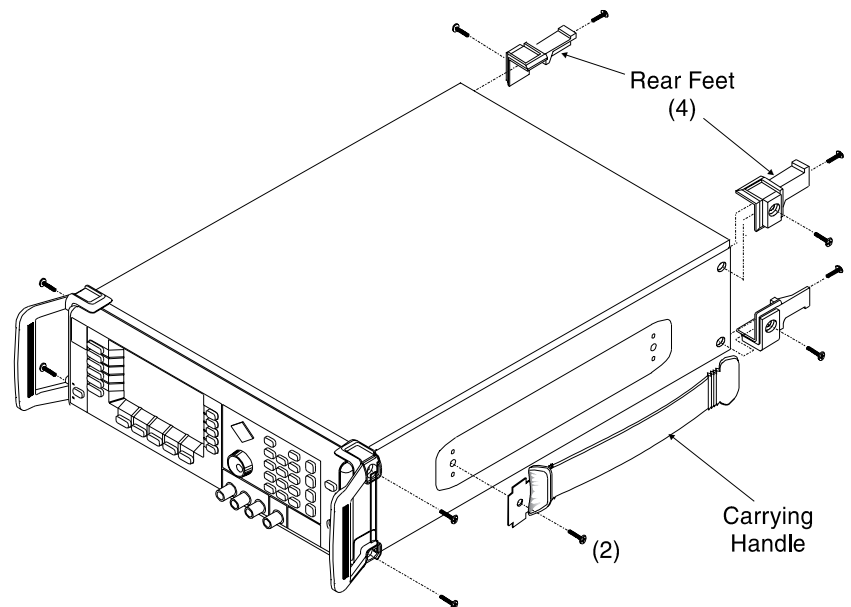

Figure 2-2. Front Handle, Feet, and Carrying Handle Removal

NOTE

The screws with green heads have metric threads. When it becomes necessary to replace any of these screws, *always* use the exact replacement green-headed screws (ANRITSU P/N 2000-560) to avoid damage to the instrument.

- Step 4** Remove the inner slide assemblies from the outer slide assemblies.
- Step 5** Place the left side inner slide assembly onto the instrument case with the handle towards the front of the instrument (Figure 2-3).
- Step 6** Insert two green-headed screws through the holes in the slide assembly behind the handle and into the metric tapped holes in the side of the instrument.
- Step 7** Insert two green-headed screws through the holes near the rear of the slide assembly and into the metric tapped holes in the side of the instrument.
- Step 8** Insert the two SAE threaded screws (removed from the feet) through the 90° tabs on the rear of the slide assembly and into the rear panel of the instrument.
- Step 9** Using the Phillips screwdriver, tighten all screws holding the left side slide assembly to the instrument chassis.

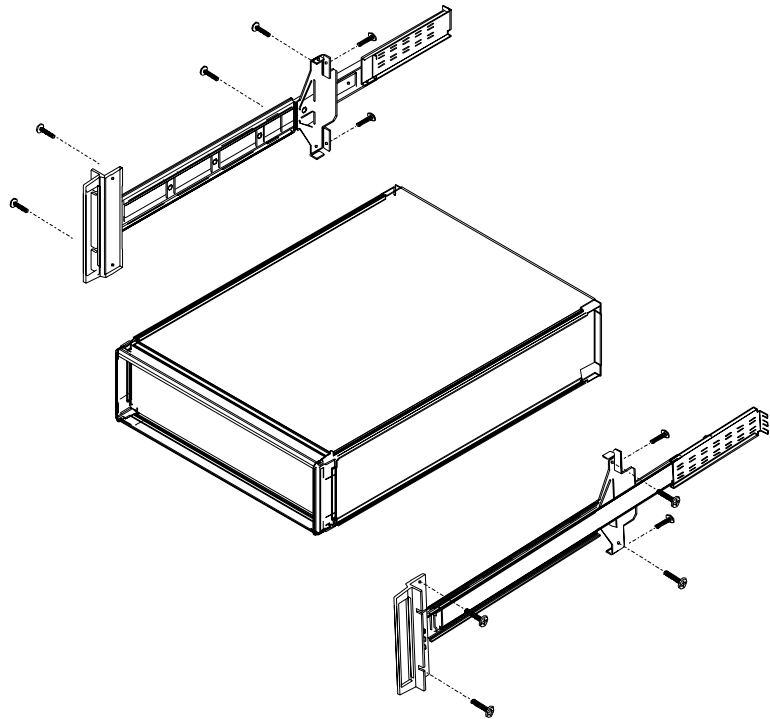

Figure 2-3. Rack Mounting Hardware Installation

- Step 10** Place the right side inner slide assembly onto the instrument case with the handle towards the front of the instrument.
- Step 11** Insert two green-headed screws through the holes in the slide assembly behind the handle and into the metric tapped holes in the side of the instrument.
- Step 12** Insert two green-headed screws through the holes near the rear of the slide assembly and into the metric tapped holes in the side of the instrument.
- Step 13** Insert the two SAE threaded screws (removed from the feet) through the 90° tabs on the rear of the slide assembly and into the rear panel of the instrument.
- Step 14** Using a Phillips screwdriver, tighten all screws holding the right side slide assembly to the instrument chassis.
- Step 15** With the appropriate hardware, install the outer slide assemblies onto the equipment rack.
- Step 16** Lift the signal generator into position. Align the inner and outer slide assemblies and slide the instrument into the rack. Realign the hardware as needed for smooth operation.



WARNING

Use two or more people to lift and move this equipment, or use an equipment cart. There is a risk of back injury, if this equipment is lifted by one person.

**2-6 PREPARATION FOR
STORAGE/SHIPMENT**

The following paragraphs give instructions for preparing the 682XXB/683XXB for storage or shipment.

Preparation for Storage Preparing the signal generator for storage consists of cleaning the unit, packing the inside with moisture-absorbing desiccant crystals, and storing the unit in a temperature environment that is maintained between -40°C and $+75^{\circ}\text{C}$ (-40°F to $+167^{\circ}\text{F}$).

Preparation for Shipment To provide maximum protection against damage in transit, the signal generator should be repackaged in the original shipping container. If this container is no longer available and the unit is being returned to ANRITSU for repair, advise ANRITSU Customer Service; they will send a new shipping container free of charge. In the event neither of these two options is possible, instructions for packaging and shipment are given below.

Use a Suitable Container.

Obtain a corrugated cardboard carton with a 275-pound test strength. This carton should have inside dimensions of no less than six inches larger than the unit dimensions to allow for cushioning.

Protect the Instrument.

Surround the unit with polyethylene sheeting to protect the finish.

Cushion the Instrument.

Cushion the instrument on all sides by tightly packing dunnage or urethane foam between the carton and the unit. Provide at least three inches of dunnage on all sides.

Seal the Container.

Seal the carton by using either shipping tape or an industrial stapler.

Address the Container.

If the instrument is being returned to ANRITSU for service, mark the address of the appropriate ANRITSU service center (Table 2-1) and your return address on the carton in one or more prominent locations.

Table 2-1. ANRITSU Service Centers

UNITED STATES ANRITSU COMPANY 685 Jarvis Drive Morgan Hill, CA 95037-2809 Telephone: (408) 776-8300 FAX: 408-776-1744 ANRITSU COMPANY 10 New Maple Ave., Unit 3 Pine Brook, NJ 07058 Telephone: (201) 227-8999 FAX: 201-575-0092 ANRITSU COMPANY 1155 E. Collins Blvd Richardson, TX 75081 Telephone: 1-800-ANRITSU FAX: 972-67d1-1877	FRANCE ANRITSU S.A 9 Avenue du Quebec Zone de Courtaboeuf 91951 Les Ulis Cedex Telephone: 016-44-66-546 FAX: 016-44-61-065 GERMANY ANRITSU GmbH Grafenberger Allee 54-56 D-40237 Dusseldorf Germany Telephone: 0211-68550 FAX: 0211-685555	KOREA ANRITSU CORPORATION LTD. #901 Daeo Bldg. 26-5 Yeoido Dong, Youngdeungpo Seoul Korea 150 010 Telephone: 02-782-7156 FAX: 02-782-4590
AUSTRALIA ANRITSU PTY. LTD. Unit 3, 170 Foster Road Mt Waverley, VIC 3149 Australia Telephone: 03-9558-8177 Fax: 03-9558-8255	INDIA MEERA AGENCIES (P) LTD. A-23 Hauz Khas New Delhi 110 016 Telephone: 011-685-3959 FAX: 011-686-6720	SINGAPORE ANRITSU (SINGAPORE) PTE LTD 3 Shenton Way #24-03 Shenton House Singapore 0106 Telephone: 022-65-206 FAX: 022-65-207
BRAZIL ANRITSU ELECTRONICA LTDA. Praia de Botafogo 440,Sala 2401 CEP22250-040, Rio de Janeiro, RJ, Brasil Telephone: 021-28-69-141 Fax: 021-53-71-456	ISRAEL TECH-CENT, LTD Haarad St. No. 7, Ramat Haahayal Tel-Aviv 69701 Telephone: (03) 64-78-563 FAX: (03) 64-78-334	SOUTH AFRICA ETESCSA 12 Surrey Square Office Park 330 Surrey Avenue Ferndale, Randburt, 2194 South Africa Telephone: 011-27-11-787-7200 Fax: 011-27-11-787-0446
CANADA ANRITSU INSTRUMENTS LTD. 215 Stafford Road, Unit 102 Nepean, Ontario K2H 9C1 Telephone: (613) 828-4090 FAX: (613) 828-5400	ITALY ANRITSU Sp.A Rome Office Via E. Vittorini, 129 00144 Roma EUR Telephone: (06) 50-22-666 FAX: (06) 50-22-4252	SWEDEN ANRITSU AB Botvid Center S-15 85 Stockholm, Sweden Telephone: (08) 534-717-00 FAX: (08) 534-717-30
CHINA INSTRIMPEX ANRITSU PRODUCT SERVICE STATION NO. 1515 Beijing Fortune Building 5 Dong San Huan Bei Lu Chao Yang-qu Beijing, China Telephone: 10-6590-9230 FAX: 10-6590-9235	JAPAN ANRITSU CORPORATION 1800 Onna Atsugi-shi Kanagawa-Prf. 243 Japan Telephone: 0462-23-1111 FAX: 0462-25-8379	TAIWAN ANRITSU CO., LTD. 8F, No. 96, Section 3 Chien Kuo N. Road Taipei, Taiwan, R.O.C. Telephone: (02) 515-6050 FAX: (02) 509-5519
		UNITED KINGDOM ANRITSU LTD. 200 Capability Green Luton, Bedfordshire LU1 3LU, England Telephone: 015-82-41-88-53 FAX: 015-82-31-303

Chapter 3

Local (Front Panel) Operation

Table of Contents

3-1	INTRODUCTION	3-5
3-2	FRONT PANEL LAYOUT.	3-6
	Line Key	3-6
	Data Display Area.	3-6
	Data Entry Area.	3-7
	RF Output Control Key	3-7
	Connectors	3-7
3-3	DATA DISPLAY AREA	3-8
	Menu Display Format	3-9
	Menu Keys	3-10
3-4	DATA ENTRY AREA.	3-12
3-5	INSTRUMENT START-UP	3-14
	Powering Up the 682XXB/683XXB	3-14
	Start-Up Display	3-14
	Standby Operation	3-14
	Self-Testing the 682XXB/683XXB	3-15
	Resetting to Default Parameters	3-15
3-6	ENTERING DATA	3-18
	Opening the Parameter.	3-18
	Editing the Current Value	3-19
	Entering a New Value	3-20

Table of Contents (Continued)

3-7	CW FREQUENCY OPERATION	3-21
	Selecting CW Mode	3-21
	Selecting a CW Frequency	3-21
	Selecting a Power Level	3-23
	CW Ramp	3-24
3-8	SWEEP FREQUENCY OPERATION	3-25
	Selecting Analog Sweep Mode	3-25
	Setting the Analog Sweep Time	3-26
	Selecting a Sweep Trigger	3-27
	Selecting Step Sweep Mode	3-28
	Setting Step Size and Dwell Time	3-29
	Selecting Manual Sweep Mode	3-30
	Selecting a Sweep Range	3-31
	Selecting a Power Level	3-33
	Frequency Markers	3-34
	Selecting Alternate Sweep Mode	3-36
3-9	FIXED POWER LEVEL OPERATION	3-39
	Selecting Fixed Power Level Mode	3-39
	Selecting a Power Level	3-39
	Level Offset	3-42
3-10	POWER LEVEL SWEEP OPERATION	3-43
	Selecting CW Power Sweep Mode	3-43
	Setting CW Power Sweep Step Size and Dwell Time	3-44
	Selecting a CW Power Sweep Trigger	3-45
	Selecting a Power Level Sweep Range	3-46
	Selecting a Sweep Frequency / Step Power Mode	3-48
	Setting Power Level Step Size	3-49
3-11	LEVELING OPERATIONS	3-50
	Selecting a Leveling Mode	3-50
	Attenuator Decoupling	3-54
	ALC Power Slope	3-55
	User Cal (User Level Flatness Correction)	3-57

Table of Contents (Continued)

3-12	SIGNAL MODULATION	3-63
	Amplitude Modulation Operating Modes	3-63
	Providing Amplitude Modulation	3-63
	Frequency Modulation Operating Modes	3-68
	Providing Frequency Modulation	3-68
	Phase Modulation Operating Modes.	3-73
	Providing Phase Modulation	3-73
	Pulse Modulation Operating Modes	3-77
	Providing Pulse Modulation.	3-78
3-13	SYSTEM CONFIGURATION	3-86
	Configuring the Front Panel	3-87
	Configuring the Rear Panel.	3-88
	Configuring the RF.	3-89
	Configuring the GPIB	3-91
	Setting Increment Sizes	3-94
3-14	SAVING/RECALLING INSTRUMENT SETUPS	3-95
	Saving Setups	3-95
	Recalling Setups	3-95
	Erasing Stored Setups	3-96
3-15	SECURE OPERATION	3-97
3-16	SCAN MODULATION (OPTION 20)	3-98
3-17	INTERNAL POWER METER (OPTION 8)	3-99
3-18	REFERENCE OSCILLATOR CALIBRATION	3-100

Chapter 3

Local (Front Panel) Operation

3-1 INTRODUCTION

This chapter provides information and instructions on operating the Series 682XXB/683XXB Synthesized Signal Generators using the front panel controls. It contains the following:

- ❑ Illustrations and diagrams of the front panel, data display area, and data entry area that identify and describe all front panel controls, inputs, and outputs.
- ❑ An annotated diagram of the menu display format showing where the current frequency, power, and modulation information is displayed.
- ❑ Instructions for performing signal generator operations; namely, frequency and frequency sweep, power level and power sweep, signal modulation, system configuration, and saving and recalling instrument setups.

3-2 FRONT PANEL LAYOUT

The 682XXB/683XXB front panel is divided into two main areas—the data display area and the data entry area. The following paragraphs provide a brief description of the front panel controls, inputs, outputs, and data display and data entry areas as shown in Figure 3-1. Detailed descriptions of the data display and data entry areas are contained in paragraphs 3-3 and 3-4.

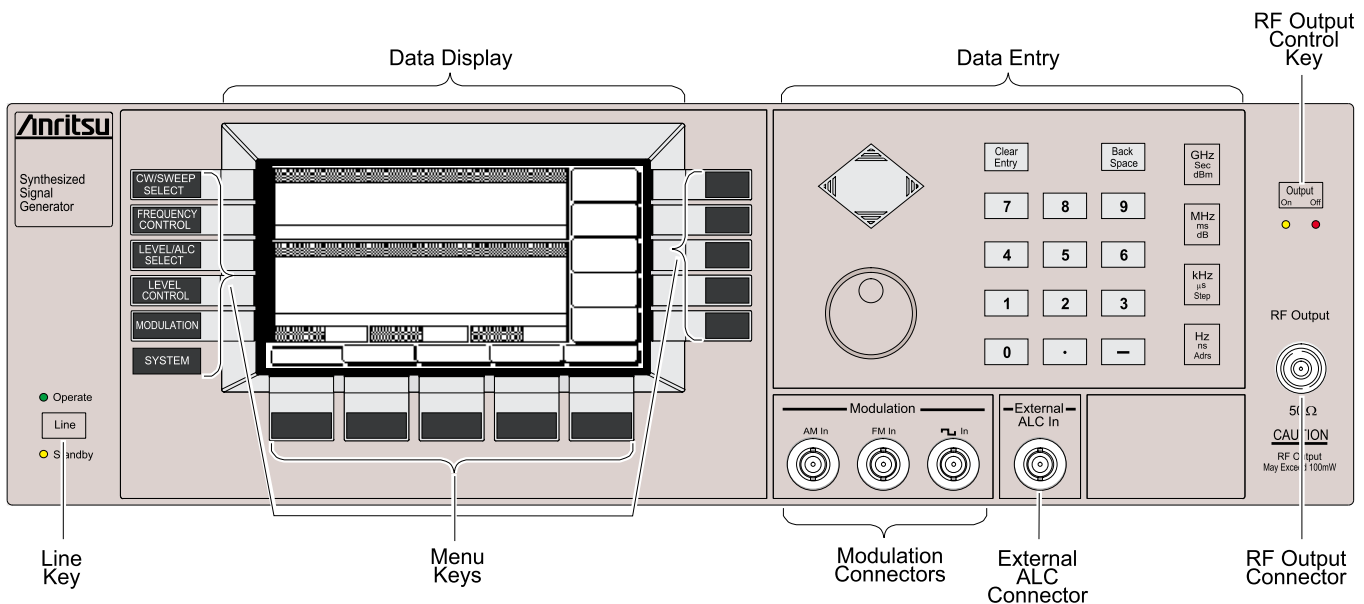

Figure 3-1. Front Panel, 682XXB/683XXB Synthesized Signal Generator

Line Key

The line key provides for turning the signal generator on and off. STANDBY (off) is indicated by an orange LED; OPERATE (on) by a green LED.

Data Display Area

The data display area consists of the data display and the surrounding menu keys.

Data Display

The data display provides information about the current status of the 682XXB/683XXB in a menu display format. This includes the operating mode of the instrument, the value of the active frequency and power level parameters, and the modulation status.

Menu Keys

Menu keys provide for selecting the operating mode, parameters, and configuration of the signal generator.

***Data Entry
Area***

The data entry area consists of data entry keys and controls that provide for (1) changing values for each 682XXB/683XXB parameter, and (2) terminating the value entry and assigning the appropriate units (GHz, MHz, dBm, etc.).

***RF Output
Control Key***

The RF output control key provides for turning the RF output power on and off. OUTPUT OFF is indicated by a red LED; OUTPUT ON by a yellow LED.

Connectors

The front panel has both input and output connectors.

Modulation Connectors

The modulation connectors provide for applying external AM, FM, or Pulse modulation to the RF output signal.

External ALC Connector

The external ALC connector provides for leveling the RF output signal externally using either a detector or a power meter.

RF Output Connector

The RF output connector provides RF output from a 50 Ω source.

NOTE

To prevent power losses due to an impedance mismatch, the mating connector and cable should also be rated at 50 Ω .

3-3 DATA DISPLAY AREA

The data display area consists of the data display and the surrounding menu keys. The data display is a dot matrix liquid crystal display (LCD) that provides 16 lines of 40 characters each. Information is presented on the LCD in the form of menu displays. The menu keys either select the main menu to be displayed, select a sub-menu of the current menu display, or control a function on the current menu display.

Figure 3-2 shows the format of the menu display and identifies the display elements. It also shows the placement of the menu keys in relation to the display. The paragraphs that follow provide descriptions of the menu display elements and the menu keys.

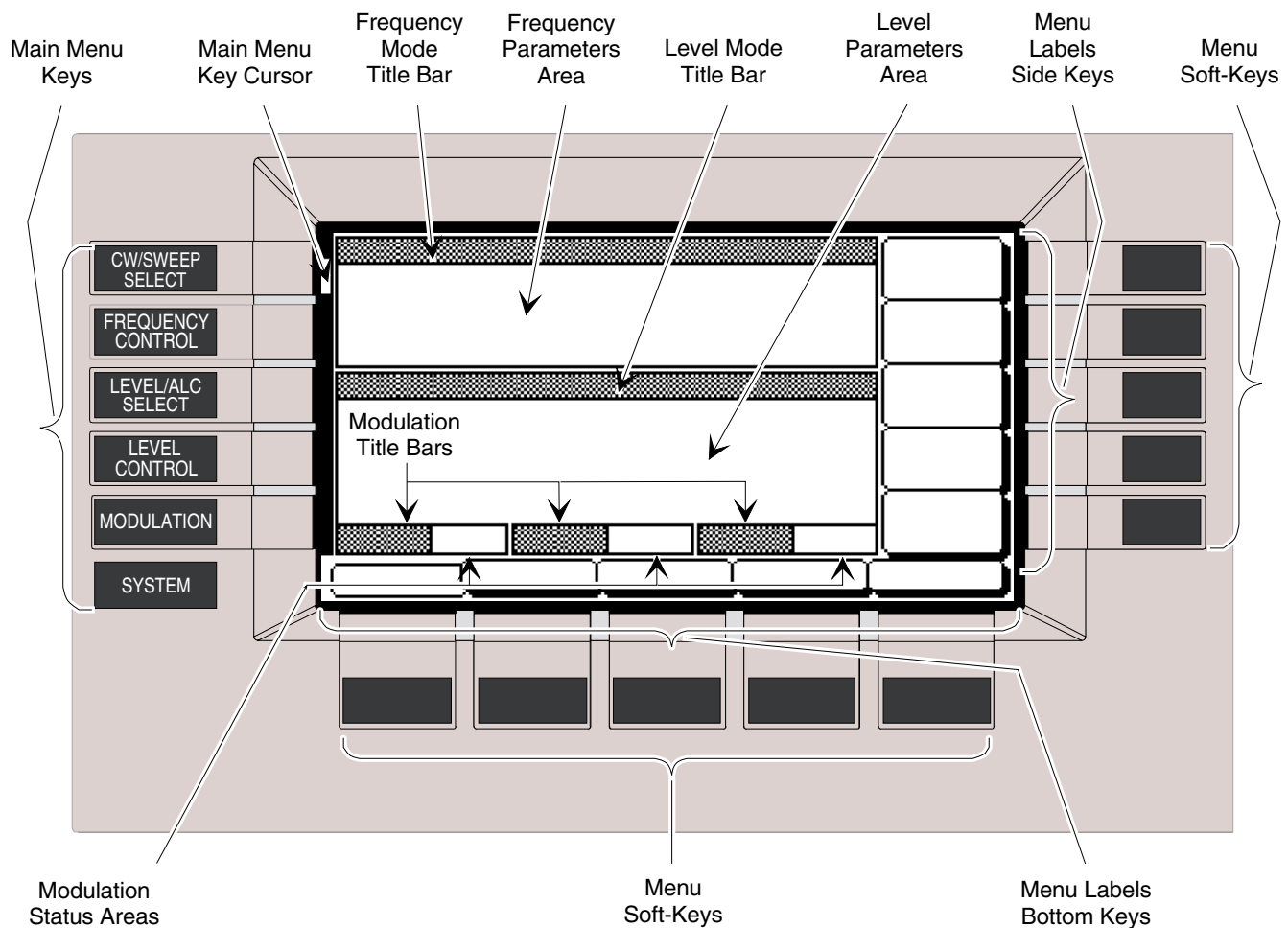

Figure 3-2. Front Panel Data Display Area

**Menu Display
Format**

The menu display is divided into specific areas that show the frequency, power level, and modulation information for the current instrument setup. Menu labels for the current menu's soft-keys appear along the bottom and right side of the display.

Title Bars

A shaded title bar identifies each parameter area. Mode information is displayed in reverse video on the title bars.

- ❑ **Frequency Mode Title Bar**—The current frequency mode (CW, Analog Sweep, Step Sweep, or Manual Sweep) appears on the left side of the bar. In an analog or step sweep mode, the type of sweep trigger (Auto, External, or Single) appears on the right side.
- ❑ **Level Mode Title Bar**—The current power level mode (Level or Level Sweep) appears on the left side of the bar. In a level sweep mode, the type of sweep trigger (Auto, External, or Single) appears on the right side of the bar.
- ❑ **Modulation Title Bars**—Each type of signal modulation (AM, FM/ΦM, and Pulse) has a separate title bar on the display.

Parameter Areas

The parameter areas show the frequency, power level, and modulation information for the current 682XXB/683XXB setup.

- ❑ **Frequency Parameters Area**—The current CW frequency in GHz, or the start and stop frequencies of the current frequency sweep range in GHz are displayed in this area.
- ❑ **Power Level Parameters Area**—The current power level in dBm, or the start and stop levels of the current power level sweep range in dBm are displayed in this area.
- ❑ **Modulation Status Areas**—These areas display Int, Ext, or Off to indicate the status of signal modulation for the current setup.

Menu Labels

Each of the menu soft-keys, located below and to the right of the display, has a corresponding menu label area on the display. These labels identify the function of the soft-keys for the current menu display. In most cases, when a soft-key is pressed, its menu label changes appearance to visually show the On/Off condition.

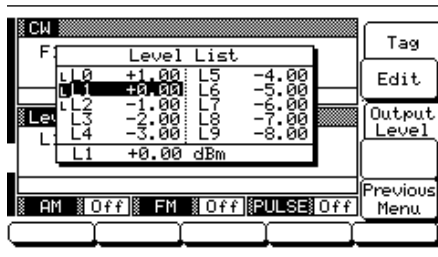

Window Display

A window display that overlays a portion of the current menu display is used to (1) show the parameter being edited; (2) display selection lists of preset frequencies, power levels, markers, etc.; (3) show the modulation and system configuration choices and current selections; or (4) show self-test error messages. A typical window display is shown on the left.

Menu Keys

As shown in Figure 3-2, there are two types of menu keys that surround the data display—main menu keys and menu soft-keys. The main menu keys are positioned to the left of the data display. The menu soft-keys are located at the bottom and to the right of the data display.

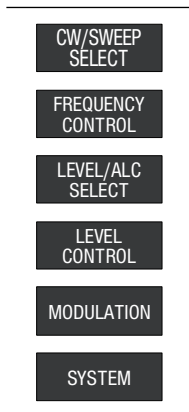

Main Menu Keys

Each of the main menu keys, shown on the left, selects a main (top-level) menu display. These menus let you select the operating mode, operating parameters, and configuration of the instrument. A brief functional description of each main menu follows.

- ❑ **CW/SWEEP SELECT**—This menu lets you select between CW, Analog, Step, and Manual Sweep frequency modes.
- ❑ **FREQUENCY CONTROL**—In CW frequency mode, this menu lets you select the CW frequency parameter (F0-F9 or M0-M9) to use. In the Analog, Step, or Manual Sweep frequency mode, this menu lets you select the sweep range parameters (Full, F1-F2, F3-F4, F5-dF, or F6-dF) to use. In Analog or Step Sweep frequency mode, the menu also lets you select up to 20 independent, pre-settable frequency markers.
- ❑ **LEVEL/ALC SELECT**—This menu lets you select power level and ALC modes (Level, Level Sweep, Level Offset, ALC on or off, internal or external ALC, ALC/attenuator decoupling, ALC slope, and user level flatness correction).
- ❑ **LEVEL CONTROL**—In Level mode, this menu lets you select the level parameter (L0-L9) to use for a CW frequency or a frequency sweep. In the Level Sweep mode, this menu lets you select the power sweep range parameters to use.

- ❑ **MODULATION**—This menu provides you with access to sub-menus that let you select the type of signal modulation (AM, FM, Φ M, or Pulse) and control the option settings for each type.
- ❑ **SYSTEM**—This menu provides you with access to sub-menus that let you (1) reset the instrument to factory-selected default values; (2) configure the front panel, rear panel, RF, and GPIB; (3) set incremental sizes for editing frequency, power level, and time parameters; (4) set the reference multiplier for frequency scaling; (5) save or recall instrument setups; (6) disable front panel data display; and (7) perform instrument self-test.

Main Menu Key Cursor

With the exception of the **SYSTEM** key, when any main menu key is pressed, the main menu that is displayed contains a cursor positioned adjacent to the pressed key (Figure 3-2). The cursor is displayed on all sub-menus of the current menu until a different main menu key is pressed.

When the **SYSTEM** key is pressed, the System menu is displayed. The System menu and its sub-menus do *not* contain a main menu key cursor.

Menu Soft-Keys

As shown on the left, five menu soft-keys are located below the data display and five menu soft-keys are located to the right of the data display. In general, the menu soft-keys located below the data display select the mode of operation for the main Frequency, Level/ALC, Modulation, and System menus and the preset parameters for the main Frequency Control and Level Control menus; the menu soft-keys located to the right of the data display either control a function on the current menu display or select an additional sub-menu. Menu labels that identify the current function of each soft-key are shown on the menu display adjacent to the soft-keys.

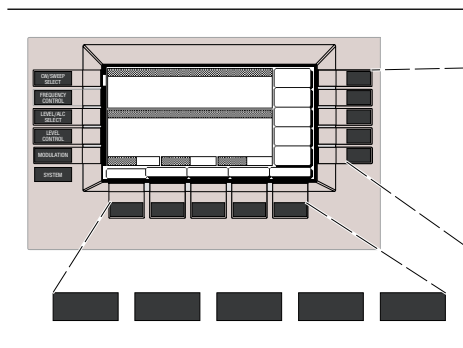

3-4 DATA ENTRY AREA

The value of a selected 682XXB/683XXB parameter can be changed using the rotary data knob and/or keys of the data entry area. Each element of the data entry area is identified in Figure 3-3 and described in the following paragraphs.

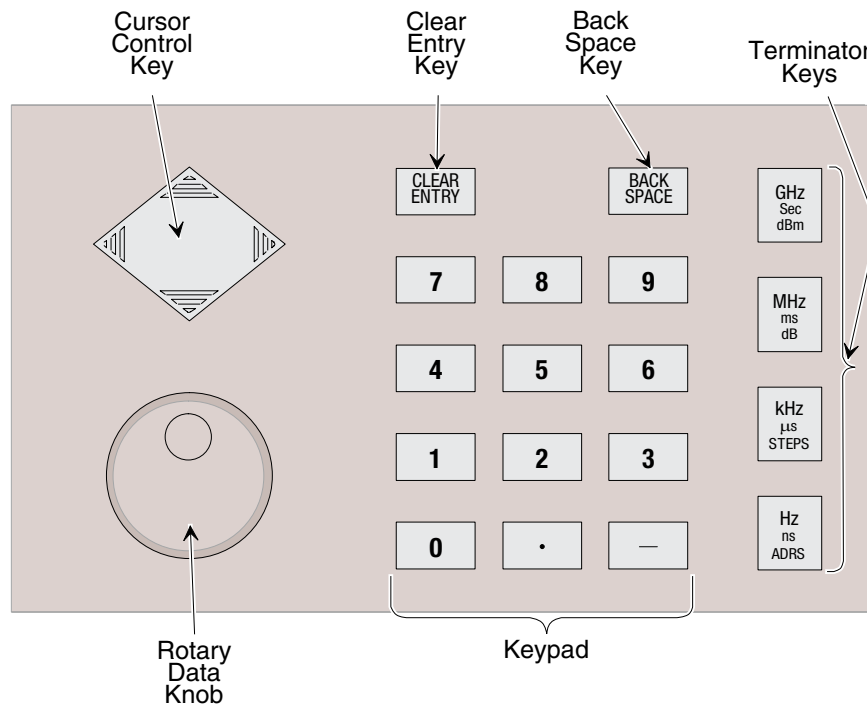

Figure 3-3. Front Panel Data Entry Area

Cursor Control Key

In general, this diamond-shaped key controls the movement of the cursor on the display. When a parameter is opened for editing, a cursor appears under the open parameter. Each time the < or > pad is pressed, the cursor moves left or right by one digit. The ^ or v pad can then be used to increase or decrease the value of the parameter. The unit size of the increase or decrease that occurs each time the ^ or v pad is pressed is determined by the cursor position.

In addition, when editing frequency, power level, and time parameters, the incremental size can be set to a specific value using a system configuration sub-menu. Once set and activated, each time the ^ or v pad is pressed, the parameter's value increases or decreases by the set amount.

Rotary Data Knob

The rotary data knob can be used to change the value of a parameter that is open for editing. The cursor is moved under the open parameter using the < and > pads of the cursor control key. Then, by slowly turning the knob clockwise or counter-clockwise the value of the parameter is increased or decreased by the unit size. The unit size is determined by the cursor placement. Turning the knob rapidly changes the value of the parameter in larger steps.

When editing frequency, power level, and time parameters, the incremental size can be set to a specific value using a system configuration sub-menu. Once set and activated, each time the knob is turned clockwise or counter-clockwise, the parameter's value increases or decreases by the set amount.

KEYPAD

The numeric keypad provides for entering frequency, power level, time, and number-of-steps parameters and GPIB address values. The “-” key functions as a “change sign” key during any keypad entry.

CLEAR ENTRY Key

When a parameter is open for editing, the CLEAR ENTRY key is used to clear the parameter entry.

BACK SPACE Key

The BACK SPACE key is used to correct keypad data entry errors by deleting the last number, “-”, or decimal point entered.

Terminator Keys

The terminator keys are used to terminate keypad data entries and change the parameter values in memory. If the entered value is outside the allowable range of the open parameter, an error message will be displayed along with an audible “beep”. The terminator keys are as follows:

GHz / Sec / dBm
MHz / ms / dB
kHz / μ s / STEPS
Hz / ns / ADRS

3-5 INSTRUMENT START-UP

Now that you have familiarized yourself with the layout of the signal generator's front panel controls and data display, you are ready to begin operating the instrument. Begin by powering it up.

**Powering Up
the 682XXB/
683XXB**

Connect the 682XXB/683XXB to an ac power source by following the procedure in the Installation chapter. This automatically places the instrument in operation (front panel OPERATE LED on).

**Start-Up
Display**

During power up, the start-up display (below) appears on the data display. It provides you with the revision level of the installed firmware and informs you that the instrument is loading programs. The start-up display remains displayed until the signal generator has loaded all programs.

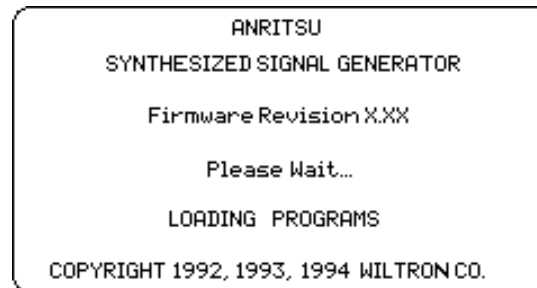

Upon completion of power up, the 682XXB/683XXB returns to the exact configuration it was in when last turned off.

**Standby
Operation**

Whenever the signal generator is not being used, it should be left connected to the power source and placed in standby. Standby operation provides power to keep the internal time base at operating temperature. This assures specified frequency accuracy and stability when the 682XXB/683XXB is placed in operation.

NOTE

During standby operation, the fan runs continuously.

Press **LINE** to switch the unit from OPERATE (green LED on) to STANDBY (orange LED on).

NOTE

When switching to operate from standby, allow at least a *30-minute warmup* before beginning 682XXB/683XXB operations.

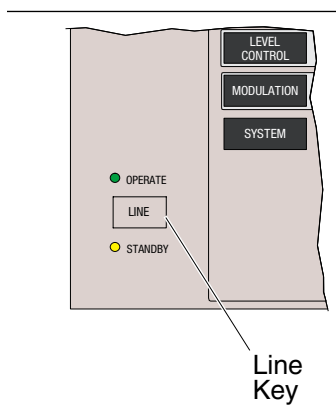

**Self-Testing
the 682XXB/
683XXB**

The 682XXB/683XXB firmware includes internal diagnostics that self-test the instrument. These self-test diagnostics perform a brief go/no-go test of most of the PCBs and other internal assemblies. If the signal generator fails self-test, an error message is displayed on the data display. Error messages and descriptions are listed in the Operator Maintenance chapter of this manual.

CAUTION

During self-test with RF OUTPUT set to ON, the output power level is set to 0 dBm. Always disconnect sensitive equipment from the unit before performing self-test.

You can perform a self-test of the signal generator at any time during normal operation. To perform a self-test from any menu, press **SYSTEM**. Then, when the System Menu (below) is displayed, press **Selftest**.

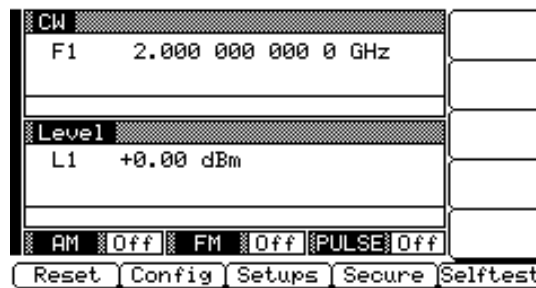

**Resetting to
Default
Parameters**

You can reset the 682XXB/683XXB to the factory-selected default parameter values at any time during normal operation. Identical model numbers of the series 682XXB signal generators and the series 683XXB signal generators have the same default parameters. Table 3-1, on the following page, lists the default parameters for all 682XXB/683XXB models.

To reset the signal generator, press **SYSTEM**. When the System Menu (above) is displayed, press **Reset**.

NOTE

Resetting the instrument clears the setup presently in place. If these parameter values are needed for future testing, save them as a stored setup before resetting the signal generator. (For information on saving/recalling instrument setups, refer to paragraph 3-14.)

Table 3-1. Series 682XXB/683XXB Reset (Default) Parameters (1 of 2)

MODEL NUMBER	FREQUENCY PARAMETERS (GHz)																				
	F0	F1	F2	F3	F4	F5	F6	F7	F8	F9	M0	M1	M2	M3	M4	M5	M6	M7	M8	M9	ΔF
68X37B	3.5	2.0	20.0	2.0	5.0	8.0	11.0	14.0	17.0	20.0	3.5	2.0	20.0	2.0	5.0	8.0	11.0	14.0	17.0	20.0	1.0
68X45B	3.5	2.2	20.0	2.0	5.0	8.0	11.0	14.0	17.0	20.0	3.5	2.0	20.0	2.0	5.0	8.0	11.0	14.0	17.0	20.0	1.0
68X47B	3.5	2.0	20.0	2.0	5.0	8.0	11.0	14.0	17.0	20.0	3.5	2.0	20.0	2.0	5.0	8.0	11.0	14.0	17.0	20.0	1.0
68X53B	3.5	2.0	26.5	2.0	5.0	8.0	11.0	14.0	17.0	20.0	3.5	2.0	26.5	2.0	5.0	8.0	11.0	14.0	17.0	20.0	1.0
68X55B	3.5	2.2	26.5	2.0	5.0	8.0	11.0	14.0	17.0	20.0	3.5	2.0	26.5	2.0	5.0	8.0	11.0	14.0	17.0	20.0	1.0
68X59B	3.5	2.0	26.5	2.0	5.0	8.0	11.0	14.0	17.0	20.0	3.5	2.0	26.5	2.0	5.0	8.0	11.0	14.0	17.0	20.0	1.0
68X63B	3.5	2.0	40.0	2.0	5.0	8.0	11.0	14.0	17.0	20.0	3.5	2.0	40.0	2.0	5.0	8.0	11.0	14.0	17.0	20.0	1.0
68X65B	3.5	2.2	40.0	2.0	5.0	8.0	11.0	14.0	17.0	20.0	3.5	2.0	40.0	2.0	5.0	8.0	11.0	14.0	17.0	20.0	1.0
68X69B	3.5	2.0	40.0	2.0	5.0	8.0	11.0	14.0	17.0	20.0	3.5	2.0	40.0	2.0	5.0	8.0	11.0	14.0	17.0	20.0	1.0
68X75B	3.5	2.2	50.0	2.0	5.0	8.0	11.0	14.0	17.0	20.0	3.5	2.0	50.0	2.0	5.0	8.0	11.0	14.0	17.0	20.0	1.0
68X77B	3.5	2.0	50.0	2.0	5.0	8.0	11.0	14.0	17.0	20.0	3.5	2.0	50.0	2.0	5.0	8.0	11.0	14.0	17.0	20.0	1.0
68X85B	3.5	2.2	60.0	2.0	5.0	8.0	11.0	14.0	17.0	20.0	3.5	2.0	60.0	2.0	5.0	8.0	11.0	14.0	17.0	20.0	1.0
68X87B	3.5	2.0	60.0	2.0	5.0	8.0	11.0	14.0	17.0	20.0	3.5	2.0	60.0	2.0	5.0	8.0	11.0	14.0	17.0	20.0	1.0
68X95B	3.5	2.2	65.0	2.0	5.0	8.0	11.0	14.0	17.0	20.0	3.5	2.0	65.0	2.0	5.0	8.0	11.0	14.0	17.0	20.0	1.0
68X97B	3.5	2.0	65.0	2.0	5.0	8.0	11.0	14.0	17.0	20.0	3.5	2.0	65.0	2.0	5.0	8.0	11.0	14.0	17.0	20.0	1.0

MODEL NUMBER	POWER LEVEL PARAMETERS (dBm)									
	L0	L1	L2	L3	L4	L5	L6	L7	L8	L9
68X37B	+1.0	0.0	-1.0	-2.0	-3.0	-4.0	-5.0	-6.0	-7.0	-8.0
68X45B	+1.0	0.0	-1.0	-2.0	-3.0	-4.0	-5.0	-6.0	-7.0	-8.0
68X47B	+1.0	0.0	-1.0	-2.0	-3.0	-4.0	-5.0	-6.0	-7.0	-8.0
68X53B	+1.0	0.0	-1.0	-2.0	-3.0	-4.0	-5.0	-6.0	-7.0	-8.0
68X55B	+1.0	0.0	-1.0	-2.0	-3.0	-4.0	-5.0	-6.0	-7.0	-8.0
68X59B	+1.0	0.0	-1.0	-2.0	-3.0	-4.0	-5.0	-6.0	-7.0	-8.0
68X63B	+1.0	0.0	-1.0	-2.0	-3.0	-4.0	-5.0	-6.0	-7.0	-8.0
68X65B	+1.0	0.0	-1.0	-2.0	-3.0	-4.0	-5.0	-6.0	-7.0	-8.0
68X69B	+1.0	0.0	-1.0	-2.0	-3.0	-4.0	-5.0	-6.0	-7.0	-8.0

Table 3-1. Series 682XXB/683XXB Reset (Default) Parameters (2 of 2)

MODEL NUMBER	POWER LEVEL PARAMETERS (dBm)									
	L0	L1	L2	L3	L4	L5	L6	L7	L8	L9
68X75B	+1.0	0.0	-1.0	-2.0	-3.0	-4.0	-5.0	-6.0	-7.0	-8.0
68X77B	+1.0	0.0	-1.0	-2.0	-3.0	-4.0	-5.0	-6.0	-7.0	-8.0
68X85B	+1.0	0.0	-1.0	-2.0	-3.0	-4.0	-5.0	-6.0	-7.0	-8.0
68X87B	+1.0	0.0	-1.0	-2.0	-3.0	-4.0	-5.0	-6.0	-7.0	-8.0
68X95B	+1.0	0.0	-1.0	-2.0	-3.0	-4.0	-5.0	-6.0	-7.0	-8.0
68X97B	+1.0	0.0	-1.0	-2.0	-3.0	-4.0	-5.0	-6.0	-7.0	-8.0

MODEL NUMBER	SWEEP TIME	STEP SWEEP		LEVEL SWEEP		LEVEL OFFSET
		DWELL TIME	NUMBER OF STEPS	DWELL TIME	NUMBER OF STEPS	
68X37B	50 ms	1 ms	50	50 ms	50	0.0 dB
68X45B	50 ms	1 ms	50	50 ms	50	0.0 dB
68X47B	50 ms	1 ms	50	50 ms	50	0.0 dB
68X53B	50 ms	1 ms	50	50 ms	50	0.0 dB
68X55B	50 ms	1 ms	50	50 ms	50	0.0 dB
68X59B	50 ms	1 ms	50	50 ms	50	0.0 dB
68X63B	50 ms	1 ms	50	50 ms	50	0.0 dB
68X65B	50 ms	1 ms	50	50 ms	50	0.0 dB
68X69B	50 ms	1 ms	50	50 ms	50	0.0 dB
68X75B	50 ms	1 ms	50	50 ms	50	0.0 dB
68X77B	50 ms	1 ms	50	50 ms	50	0.0 dB
68X85B	50 ms	1 ms	50	50 ms	50	0.0 dB
68X87B	50 ms	1 ms	50	50 ms	50	0.0 dB
68X95B	50 ms	1 ms	50	50 ms	50	0.0 dB
68X97B	50 ms	1 ms	50	50 ms	50	0.0 dB

3-6 ENTERING DATA

Before proceeding to the various modes of signal generator operation, you need to know how to enter data from the front panel. Entering data refers to changing a parameter's value by editing its current value or entering a new value to replace the current value. The following instructions describe how to (1) open a parameter, (2) edit its current value, and (3) enter a new value.

A typical 682XXB/683XXB menu display (below) is used throughout the data entry instructions. At this menu display, you can edit both the CW frequency and the output power level parameters.

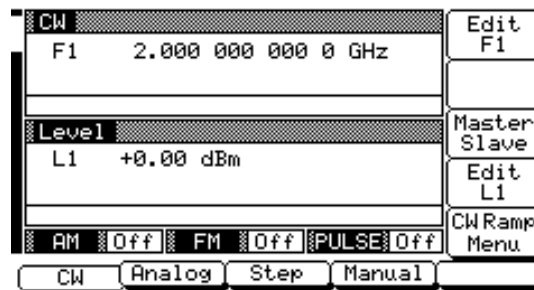

If you wish to follow along on your instrument, you can obtain this same menu display by resetting your instrument (press **SYSTEM**, then press **Reset**).

Opening the Parameter

In order for the value of a parameter to be changed, the parameter must first be opened.

To open the frequency parameter from the above menu, press **Edit F1**. The menu display now changes to show that the menu soft-key **Edit F1** has been pressed and that the frequency parameter has been opened. An open parameter is indicated by placing it in a window with a movable cursor under its digits.

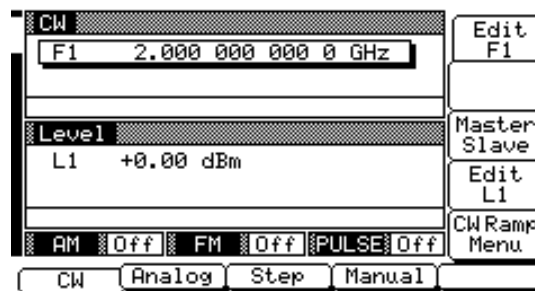

Only one parameter can be open at a time. If you press **Edit L1**, then the frequency parameter will close and the power level parameter will open.

**Editing the
Current Value**

To change the current value of a parameter by editing, you can use either the cursor control key or the rotary data knob.

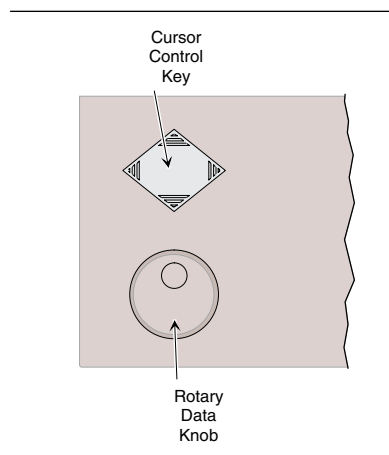

Using the Cursor Control Key

Using the < and > pads of the cursor control key, move the cursor under the digit where you want to begin editing. Then increase or decrease the value of the parameter using the ^ or v pad of the cursor control key. The unit size of the increase or decrease that occurs each time the ^ or v pad is pressed is determined by the cursor position.

Using the Rotary Data Knob

You can also increase or decrease the value of the parameter using the rotary data knob. Once you have positioned the cursor under the digit where you want to begin editing, slowly turn the knob clockwise or counter-clockwise to increase or decrease the value of the parameter by the unit size. Turning the knob rapidly changes the value of the parameter in larger steps.

Using a Set Increment

When editing frequency, power level, and time parameters, you can increase or decrease the parameter's value by a set amount each time the ^ or v pad is pressed or the rotary data knob is turned clockwise or counter-clockwise. For instructions on setting the increment size, refer to paragraph 3-13.

Now, try changing the current value of the CW frequency displayed on your instrument from 2.0 GHz to 6.395 GHz. Use both the cursor control key's ^ and v pads and the rotary data knob to make the value changes. When you are finished, your menu display should look similar to the example below.

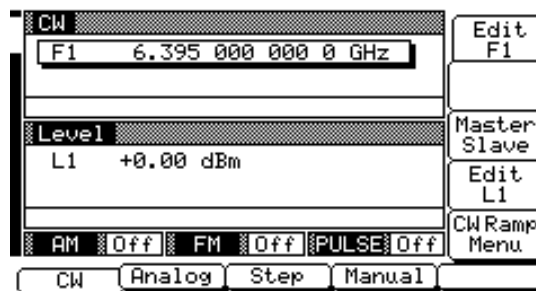

To close the open parameter when you are finished editing, press **Edit F1** or make another menu selection.

***Entering a
New Value***

To change the current value of a parameter by entering a new value for the parameter, use the data entry keypad and termination keys.

As soon as you press one of the keys on the data entry keypad, the current parameter display clears for entry of a new value. Enter the new value for the parameter, then press the appropriate terminator key to store it in memory. If the entered value is outside the allowable range of the open parameter, the entry is not accepted and the previous value for the parameter is displayed.

NOTE

A frequency entry may be terminated in GHz, MHz, kHz, or Hz; however, it is always displayed on the data display in GHz. A time entry may be terminated in Sec, ms, μ s, or ns; however it is always displayed on the data display in Sec.

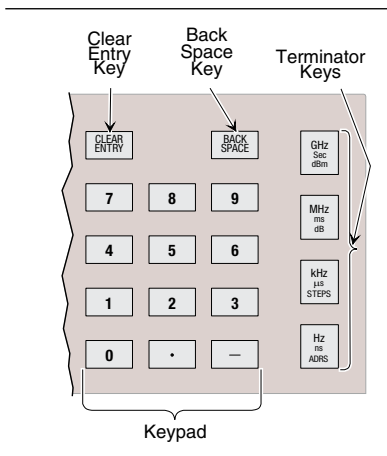

If you make an error during data entry, either (1) press **BACK SPACE** to delete the entry one character at a time starting from the last character entered, or (2) delete the entire entry by pressing **CLEAR ENTRY**. Then, re-enter the correct value.

Now, try entering a new value for the CW frequency displayed on your instrument using the data entry keypad and termination keys.

To close the open parameter when you are finished entering data, press **Edit F1** or make another menu selection.

**3-7 CW FREQUENCY
OPERATION**

One of the signal generator's major functions is to produce discrete CW frequencies across the frequency range of the instrument. The following paragraphs describe how to place the 682XXB/683XXB in the CW frequency mode, select a CW frequency and power level for output, and activate the CW ramp. Use the CW Frequency Mode menu map (Chapter 4, Figure 4-2) to follow the menu sequences.

Selecting CW Mode To place the 682XXB/683XXB in the CW frequency mode, press the main menu key

**CW/SWEEP
SELECT**

At the resulting menu display, press **CW**. The CW Menu (below) is displayed.

NOTE
Refer to Chapter 7, paragraph 7-2 for Master-Slave mode operating instructions.

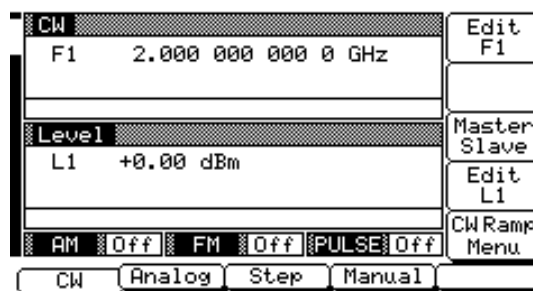

NOTE
When the signal generator is reset, it automatically comes up operating in the CW frequency mode.

Selecting a CW Frequency There are several ways to select a CW frequency for output. You can (1) edit the current frequency, (2) enter a new frequency, or (3) select one of the 20 pre-set frequency parameters.

Editing the Current Frequency
Press **Edit F1** to open the frequency parameter, then edit the current CW frequency using the cursor control key or the rotary data knob. To close the open frequency parameter, press **Edit F1** or make another menu selection.

Entering a New Frequency
Press **Edit F1** to open the frequency parameter, then enter the new CW frequency using the keypad and appropriate terminator key. To close the open frequency parameter, press **Edit F1** or make another menu selection.

Selecting a Preset Frequency

To select one of the preset frequencies for output, press the main menu key

**FREQUENCY
CONTROL**

The CW Frequency Control menu (below) is displayed. This menu lets you (1) select preset frequencies F0, F1, F2, M1, or M2 for output, (2) go to the frequency list menu, or (3) go to the tagged frequencies menu.

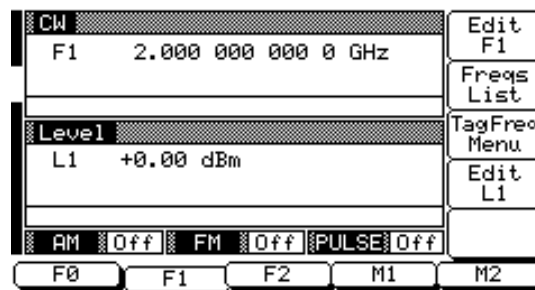

Frequency List—To go to the Frequency List menu (below), press **Freqs List**. This menu lets you tag, edit, or output a frequency from the list.

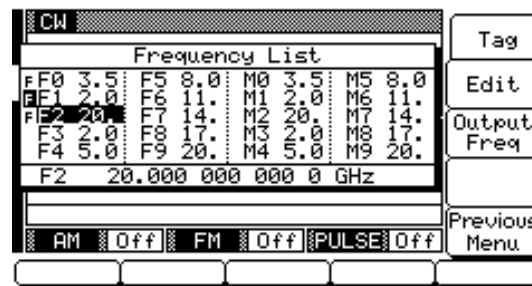

Use the cursor control key to select a frequency from the frequency list. The selected frequency is highlighted in reverse video and displayed in full below the frequency list.

Press **Tag** to mark a selected frequency (place an **F** in front of it). If the frequency is already tagged, pressing **Tag** will untag it (remove the **F**). Tagging selected frequencies lets you quickly switch between them using the scan keys of the Tagged Frequencies menu.

Press **Edit** to edit the selected frequency or enter a new frequency.

Press **Output Freq** to output the selected frequency. This frequency is output until you select another frequency from the list and press **Output Freq**. On the frequency list, the output frequency selection is marked by a black square or, if tagged, an F highlighted in reverse video.

When you are finished, press **Previous Menu** to return to the CW Frequency Control menu display.

Scanning Tagged Frequencies—To go to the Tagged Frequencies menu (below) from the CW Frequency Control menu, press **Tag Freq Menu**.

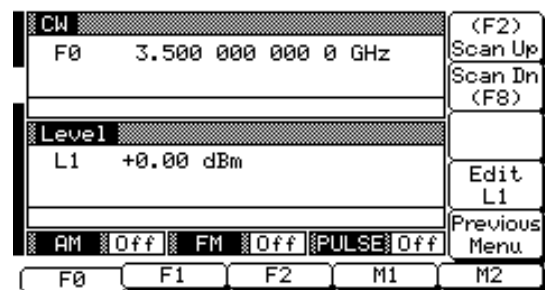

This menu lets you select the tagged frequencies for output using the **Scan Up** and **Scan Dn** keys.

Return to the CW Frequency Control menu by pressing **Previous Menu**.

Selecting a Power Level

While in the CW frequency mode, you can edit the current CW frequency output power level or enter a new output power level.

Editing the Current Power Level

Press **Edit L1** to open the power level parameter, then edit the current power level using the cursor control key or rotary data knob. To close the open power level parameter, press **Edit L1** or make another menu selection.

Entering a New Power Level

Press **Edit L1** to open the power level parameter, then enter the new power level using the keypad and appropriate terminator key. To close the open power level parameter, press **Edit L1** or make another menu selection.

NOTE

You can also select any of the preset power levels or a power level sweep for a CW frequency. For instructions, refer to paragraphs 3-9 (Fixed Power Level Operation) and 3-10 (Power Level Sweep Operation).

CW Ramp

When active, the signal generator's CW ramp provides a repetitive 0V to 10V ramp output to the rear panel HORIZ OUT BNC connector and AUX I/O connector. The CW ramp is used to drive a scalar analyzer display.

To go to the CW Ramp menu (below) from the CW menu, press **CW Ramp Menu**.

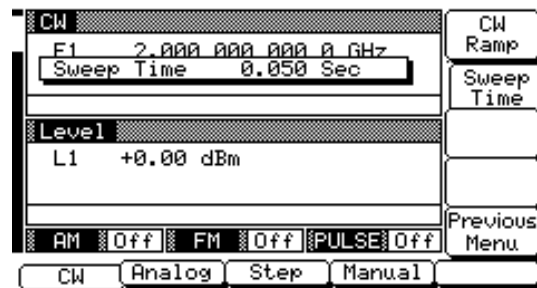

This menu lets you set the ramp speed and turn the CW ramp on/off.

To set ramp speed, press **Sweep Time**. The sweep time parameter opens for editing. Edit the current sweep time using the cursor control key or rotary data knob or enter a new sweep time using the keypad and appropriate termination key. The sweep time entered must be in the range of 30 ms to 99 sec. To close the open sweep time parameter when you are done, press **Sweep Time** or make another menu selection.

Press **CW Ramp** to turn the CW ramp on. While the CW ramp is on, the message **CW Ramp** appears on the right side of frequency title bar on all CW menus.

Press **Previous Menu** to return to the CW menu.

**3-8 SWEEP FREQUENCY
OPERATION**

The signal generator can generate broad (full range) and narrow band sweeps across the frequency range of the instrument. The series 682XXB signal generator has two sweep frequency modes—step sweep and manual sweep. The series 683XXB signal generator has three sweep frequency modes—*analog sweep*, *step sweep*, and *manual sweep*. The following paragraphs describe how to select each sweep frequency mode, a sweep range, an output power level, a sweep trigger, and frequency markers. Use the Analog Sweep, Step Sweep, and Manual Sweep Frequency Mode menu maps (Chapter 4, Figures 4-3, 4-4, and 4-5) to follow the menu sequences.

**Selecting
Analog Sweep
Mode**

In analog sweep frequency mode, the 683XXB's output frequency is swept between selected start and stop frequencies. When the sweep width is >100 MHz, the sweep is phase-lock corrected at both the start and stop frequencies and at each band-switch point. When the sweep width is ≤100 MHz, only the center frequency of the sweep is phase-lock corrected.

NOTE
In 683X5B models performing analog sweeps between 0.5 and 2.2 GHz, the sweep is phase-lock corrected as follows. For sweep widths of >25 MHz, phase-lock correction occurs at both the start and stop frequencies and at each band-switch point. For sweep widths of ≤25 MHz, only the center frequency of the sweep is phase-lock corrected.

To place the 683XXB in analog sweep frequency mode, press the main menu key

**CW/SWEEP
SELECT**

At the resulting menu display, press **Analog**. The Analog Sweep Menu (below) is then displayed.

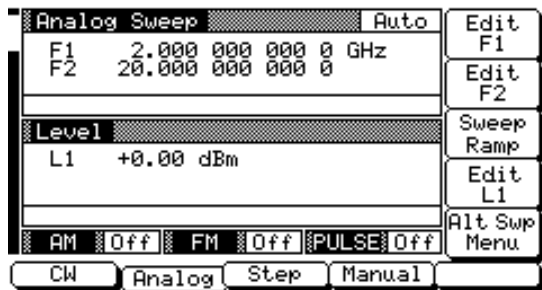

- This menu lets you perform the following:
- ❑ Select a sweep range (edit the sweep start and stop frequency parameters).
 - ❑ Go to the sweep ramp menu (set the sweep time and select a sweep trigger).
 - ❑ Select an output power level for the sweep.
 - ❑ Go to the alternate sweep menu.

***Setting the
Analog Sweep
Time***

The duration of the analog sweep can be set for any time in the range of 30 ms to 99 sec. The sweep time parameter is set from the sweep ramp menu.

To go to the Analog Sweep Ramp menu (below) from the Analog Sweep menu, press **Sweep Ramp**.

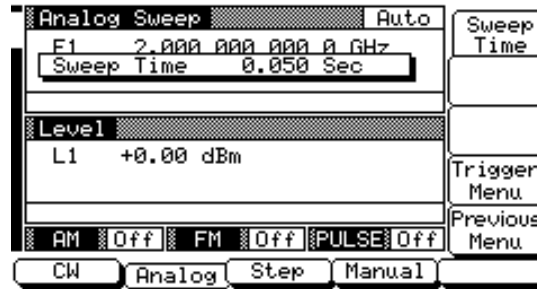

This menu lets you set the sweep time and go to the trigger menu.

To open the sweep time parameter for editing, press **Sweep Time**. Edit the current sweep time using the cursor control key or the rotary data knob or enter a new sweep time using the key pad and appropriate termination key. To close the open sweep time parameter once you have set the desired time, press **Sweep Time** or make another menu selection.

To go to the Analog Sweep Trigger menu from this menu, press **Trigger Menu**. Sweep trigger is described on the next page.

Press **Previous Menu** to return to the Analog Sweep menu.

**Selecting a
Sweep
Trigger**

The 682XXB/683XXB provides sweep triggering for frequency sweeps and CW power sweep. There are three modes of sweep triggering, each selectable from the trigger menu. The following is a description of each mode.

- ❑ **Auto (Automatic)**–The sweep continually sweeps from its start frequency or power level to its stop frequency or power level with optimal retrace time.
- ❑ **External**–The sweep recurs when triggered by an external TTL-compatible clock pulse to the rear panel AUX I/O connector.
- ❑ **Single**–A single sweep starts when the trigger key is pressed. If a sweep is in progress when the key is pressed, it aborts and resets.

To go to the Sweep Trigger menu (below) from the Analog Sweep Ramp menu, press **Trigger Menu**.

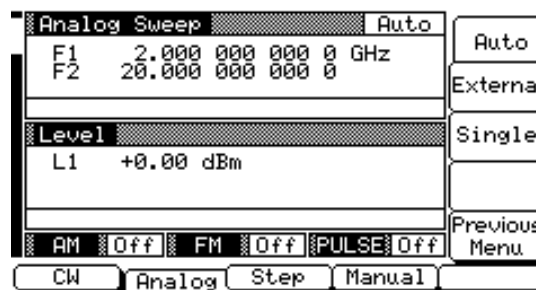

To select a sweep trigger mode, press its menu soft-key. A message showing the sweep trigger mode selected appears on the right side of frequency title bar. When you are finished, press **Previous Menu** to return to the Analog Sweep Ramp menu.

If you select the single sweep trigger mode, the menu display adds the menu soft-key **Trig**. Pressing **Trig** starts a single sweep. If a single sweep is in progress, pressing **Trig** causes the sweep to abort and reset.

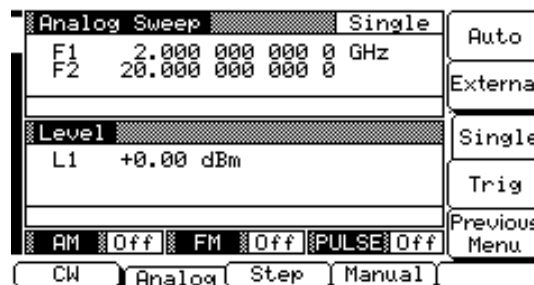

**Selecting
Step Sweep
Mode**

In step sweep frequency mode, the output frequency changes in discrete, synthesized steps between selected start and stop frequencies. Step sweeps can be from a high frequency to a low frequency and vice versa. The step size or number of steps between the start and stop frequencies and the dwell time-per-step are controllable from a step sweep menu.

To place the 682XXB/683XXB in step sweep frequency mode, press the main menu key

**CW/SWEEP
SELECT**

At the resulting menu display, press **Step**. The Step Sweep Menu (below) is then displayed.

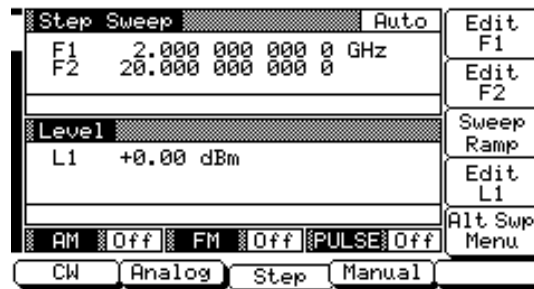

This menu lets you perform the following:

- Select a sweep range (edit the sweep start and stop frequency parameters).
- Go to the sweep ramp menu (set the dwell time-per-step, the step size or number of steps, and select a sweep trigger).
- Select an output power level for the sweep.
- Go to the alternate sweep menu.

**Setting Step
Size and
Dwell Time**

There are two ways to set the size of each step of the step sweep—set the step size or set the number of steps. The step size range is 1 kHz to the full frequency range of the signal generator (0.1 Hz to full frequency range with Option 11); the number of steps range is 1 to 10,000. The dwell-time-per-step of the step sweep can be set for any time in the range of 1 ms to 99 sec. The step size and dwell-time-per-step parameters are set from the step sweep ramp menu.

To go to the Step Sweep Ramp menu (below) from the Step Sweep menu, press **Sweep Ramp**.

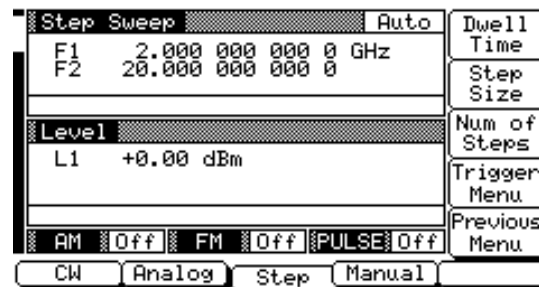

This menu lets you set the dwell time, the step size, the number of steps, and go to the trigger menu.

Press **Dwell Time** to open the dwell-time-per-step parameter.

Press **Step Size** to open the step size parameter.

Press **Num of Steps** to open the number of steps parameter.

Open the parameter you wish to change, then edit the current value using the cursor control key or the rotary data knob or enter a new value using the key pad and appropriate termination key. When you have finished setting the open parameter, close it by pressing its menu soft-key or make another menu selection.

To go to the Step Sweep Trigger menu from this menu, press **Trigger Menu**. The trigger menu lets you select a sweep trigger (previously described on page 3-27).

Press **Previous Menu** to return to the Step Sweep menu.

RANGE

This error message is displayed when (1) the step size value entered is greater than the sweep range or (2) the number of steps entered results in a step size of less than 1 kHz (0.1 Hz with Option 11). Entering a valid step size will clear the error.

**Selecting
Manual
Sweep Mode**

In manual sweep frequency mode, the output frequency can be manually tuned in phase-locked steps between the selected start and stop frequencies using the rotary data knob. As the knob is turned, the current output frequency is displayed on the data display as Fm. The step size or number of steps between the start and stop frequencies are controllable from the manual sweep menu.

To place the 682XXB/683XXB in manual sweep frequency mode, press the main menu key

**CW/SWEEP
SELECT**

At the resulting menu display, press **Manual**. The Manual Sweep menu (below) is then displayed.

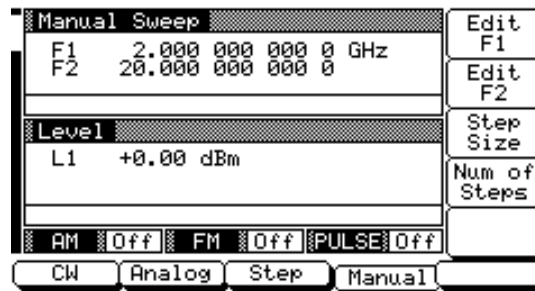

This menu lets you perform the following:

- Select a sweep range (edit the start and stop frequency parameters).
- Set the step size or number of steps (previously described on page 3-29).

**Selecting a
Sweep Range**

Selecting a sweep range involves choosing a start and a stop frequency for the frequency sweep. The sweep range selection process is identical for all sweep frequency modes (analog, step, and manual). You can select a frequency sweep range as follows:

- ❑ Edit the current start and stop frequency parameter values.
- ❑ Enter new start and stop frequency parameter values.
- ❑ Select one of the preset sweep range parameters (F1-F2, F3-F4, F5-dF, or F6-dF).

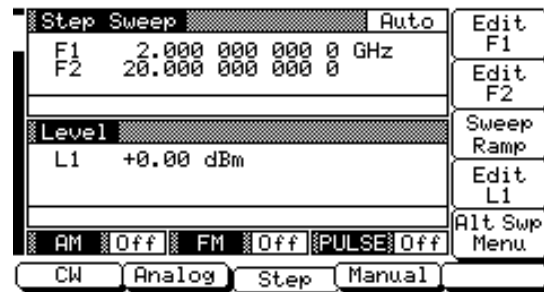

Editing the Current Start / Stop Frequencies

To edit the current frequency sweep range, open either the start or stop frequency parameter. In the display above, **Edit F1** opens the start frequency parameter and **Edit F2** opens the stop frequency parameter.

Edit the open frequency parameter using the cursor control key or the rotary data knob. When you are finished, close the open parameter by pressing its menu edit soft-key or by making another menu selection.

Entering New Start / Stop Frequencies

To enter a new frequency sweep range, open either the start or stop frequency parameter (press **Edit F1** or **Edit F2**).

Enter a new frequency using the keypad and appropriate terminator key. When you are finished, close the open parameter by pressing its menu edit soft-key or by making another menu selection.

RANGE

This error message is displayed when (1) the analog sweep start frequency entered is greater than the stop frequency (683XXB models only), or (2) the dF value entered results in a sweep outside the range of the instrument. Entering valid values will clear the error.

Selecting a Preset Sweep Range

There are four preset sweep range parameters, selectable in the analog sweep, step sweep, and manual sweep frequency modes. The following is a description of each preset sweep range.

- ❑ **F1-F2**—provides a frequency sweep between the start frequency, F1, and the stop frequency, F2.
- ❑ **F3-F4**—provides a frequency sweep between the start frequency, F3, and the stop frequency, F4.
- ❑ **F5-dF**—provides a symmetrical frequency sweep about the center frequency, F5. The sweep width is determined by the dF frequency parameter.
- ❑ **F6-dF**—provides a symmetrical frequency sweep about the center frequency, F6. The sweep width is determined by the dF frequency parameter.

To select one of the preset sweep ranges from any sweep frequency mode menu, press the main menu key

**FREQUENCY
CONTROL**

The Sweep Frequency Control menu (below) is displayed.

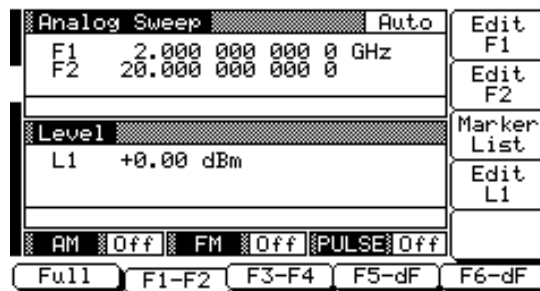

This menu lets you perform the following:

- ❑ Select a full range sweep (Fmin–Fmax) or one of the preset sweep ranges for the sweep frequency mode.
- ❑ Select the frequency parameters for each preset sweep range.
- ❑ Select an output power level for the sweep.
- ❑ Go to the marker list menu.

Setting a Preset Sweep Range—At the menu, select the sweep range (F1-F2, F3-F4, F5-dF, or F6-dF) that you wish to set. The menu then displays the current frequency parameters for the selected sweep range. Now use the menu edit soft-keys to open the frequency parameters for editing.

Edit the current frequency parameters or enter new frequency parameter values for the sweep range. To close the open frequency parameter when you are finished, press its menu edit soft-key or make another menu selection.

You can set all the preset sweep ranges in this manner.

Selecting a Power Level

While in a sweep frequency mode, you can edit the current output power level or enter a new output power level for the frequency sweep.

Editing the Current Power Level

Press **Edit L1** to open the power level parameter, then edit the current power level using the cursor control key or rotary data knob. To close the open power level parameter, press **Edit L1** or make another menu selection.

Entering a New Power Level

Press **Edit L1** to open the power level parameter, then enter the new power level using the keypad and appropriate terminator key. To close the open power level parameter, press **Edit L1** or make another menu selection.

NOTE

You can also select any of the preset power levels for a frequency sweep or a power level step for analog and step sweeps. For instructions, refer to paragraphs 3-9 (Fixed Power Level Operation) and 3-10 (Power Level Sweep Operation).

**Frequency
Markers**

The 682XXB/683XXB provides up to 20 independent, pre-settable markers, F0-F9 and M0-M9, that can be used in the analog and step sweep frequency modes for precise frequency identification. Marker frequency accuracy is the same as sweep frequency accuracy. The markers are visible on a CRT display.

The 683XXB generates video and intensity markers. The 682XXB produces only video markers.

- ❑ **Video Marker**—produces a pulse on a CRT display at each marker frequency. The video marker is either a +5V or a -5V pulse available at the rear panel AUX I/O connector. Pulse polarity is selectable from a system configuration menu.
- ❑ **Intensity Marker**—produces an intensified dot on a CRT display at each marker frequency. Intensity markers are only available in the analog sweep frequency mode. They are obtained by a momentary dwell in the sweep at each marker frequency.

To output markers during a sweep you must first select (tag) the marker frequencies from the Marker List menu, then turn on the marker output. To go to the Marker List menu from an analog or step sweep frequency menu, press

**FREQUENCY
CONTROL**

The Sweep Frequency Control menu (below) is displayed.

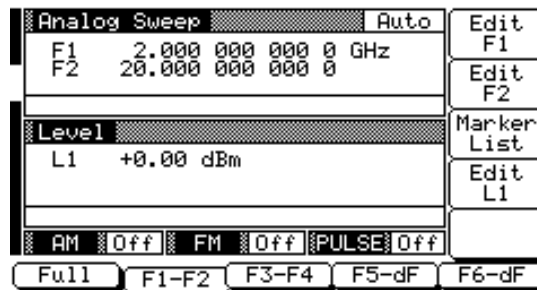

To go to the Marker List menu from this menu, press **Marker List**. The Marker List menu (next page) is displayed. This menu lets you tag or edit marker list frequencies and turn the markers on/off.

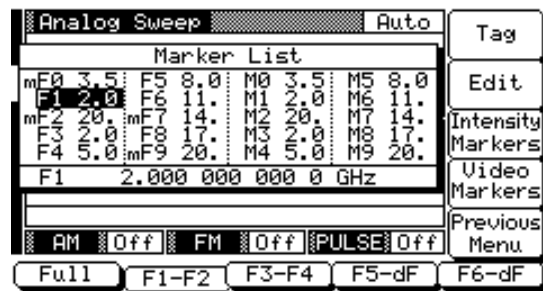

Use the cursor control key to select a frequency parameter from the marker list. The selected frequency parameter is highlighted in reverse video and displayed in full below the marker list.

Editing a Marker List Frequency

If you want to change a selected marker list frequency parameter's value, press **Edit**. This opens the frequency parameter and lets you edit the current frequency or enter a new frequency.

Tagging a Marker List Frequency

Only frequencies on the marker list that have been tagged can be output as markers during a sweep. Press **Tag** to tag a selected frequency parameter (place an **m** in front of it). If a frequency parameter is already tagged, pressing **Tag** will untag it (remove the **m**).

Activating Markers

The soft-keys **Video Markers** and **Intensity Markers** toggle the markers on and off.

Video Markers—To output the tagged marker frequencies as video markers during an analog or step sweep, press **Video Markers**. Video markers will be displayed on the CRT for all tagged marker frequencies that are within the sweep frequency range.

Intensity Markers—(only available in analog sweep frequency mode) To output the tagged marker frequencies as intensity markers during an analog sweep, press **Intensity Markers**. Intensity markers will be displayed on the CRT for all tagged marker frequencies that are within the analog sweep frequency range.

Press **Previous Menu** to return to the Sweep Frequency Control menu.

**Selecting
Alternate
Sweep Mode**

In alternate sweep frequency mode, the 683XXB's output frequency sweeps alternately between any two sweep ranges in analog sweep or any two sweep ranges in step sweep; the 682XXB's output frequency sweeps alternately between any two sweep ranges in step sweep. The process of selecting and activating the alternate sweep is identical for both analog and step sweep frequency modes.

To select the alternate sweep mode for analog sweeps, start with the Analog Sweep Menu display; to select the alternate sweep mode for step sweeps, start with the Step Sweep Menu display (below).

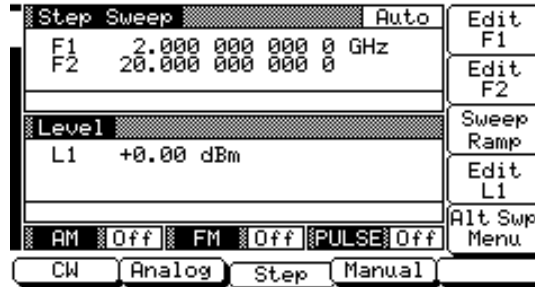

To go to the Alternate Sweep menu (below) from the Step Sweep menu, press **Alt Swp Menu**.

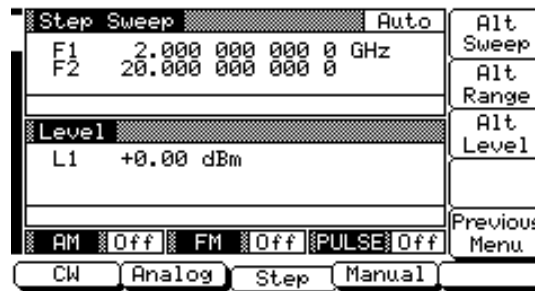

This menu lets you perform the following:

- Turn the alternate sweep mode on/off.
- Go to the alternate range menu to select a sweep range for the alternate sweep.
- Go to the alternate level menu to select a power level for the alternate sweep.

Activating the Alternate Sweep

The Alternate Sweep menu soft-key **Alt Sweep** toggles the alternate sweep mode on and off.

Press **Alt Sweep** to turn on the alternate sweep mode. Notice that the Alternate Sweep menu (on the following page) changes to show that the alternate sweep is now active.

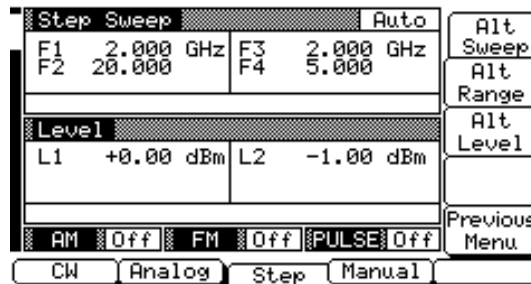

Now, press **Previous Menu** to return to the Step Sweep Menu display (or the Analog Sweep Menu display if operating in analog sweep frequency mode).

Notice the changes to the Step Sweep Menu display (below). These changes indicate that the alternate sweep frequency mode is active.

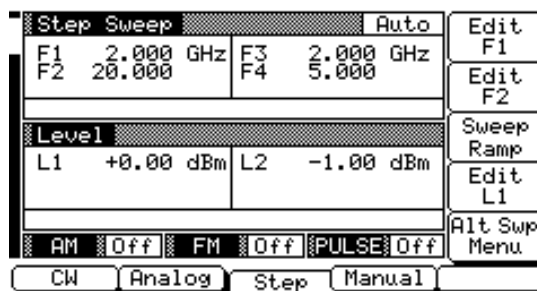

Now, press **Alt Swp Menu** to return to the Alternate Sweep menu.

Selecting an Alternate Sweep Range

To go to the Alternate Range menu (below) from the Alternate Sweep menu, press **Alt Range**.

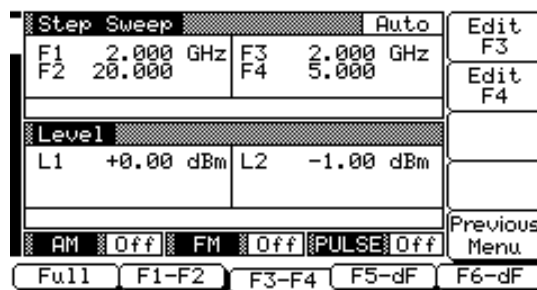

Select the alternate sweep range (Full, F1-F2, F3-F4, F5-dF, or F6-dF). The menu then displays the current frequency parameters for the selected sweep range. If you wish to change a frequency parameter, use the menu edit soft-key to open the parameter, then edit it.

When you are done selecting the alternate sweep range, press **Previous Menu** to return to the Alternate Sweep menu.

Selecting an Alternate Sweep Power Level

To go to the Alternate Level menu (shown below) from the Alternate Sweep menu, press **Alt Level**.

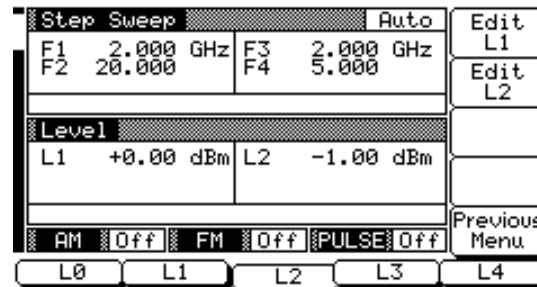

Select the power level for the alternate sweep range (L0, L1, L2, L3, or L4). The menu then displays the current level parameter for the selected power level. If you wish to change the level, use the menu edit soft-key to open the parameter, then edit it.

A menu edit soft-key is also provided to let you change the power level of the main sweep.

CAUTION

Performing alternate sweeps using power levels that cross step attenuator switch points can cause excessive wear on the switches and reduce the life expectancy of the step attenuator.

When you are done selecting the power level for the alternate sweep range and editing the power level of the main sweep, press **Previous Menu** to return to the Alternate Sweep menu.

**3-9 FIXED POWER LEVEL
OPERATION**

The 682XXB/683XXB provides leveled output power over a maximum range of up to 28 dB (up to 131 dB with Option 2) for CW and sweep frequency operations. Instruments with Option 15B provide leveled output power over a maximum range of up to 22 dB (up to 125 dB with Option 2). The following paragraphs describe how to place the signal generator in fixed (non-swept) power level mode, select a power level for output, and activate level offset. Use the Fixed (Non-Swept) Power Level Mode menu map (Chapter 4, Figure 4-6) to follow the menu sequences.

**Selecting
Fixed Power
Level Mode**

To place the 682XXB/683XXB in a fixed power level mode from a CW or sweep (analog, step, or manual) frequency menu, press the main menu key



At the resulting menu display, press **Level**. The Level Menu (below) is displayed.

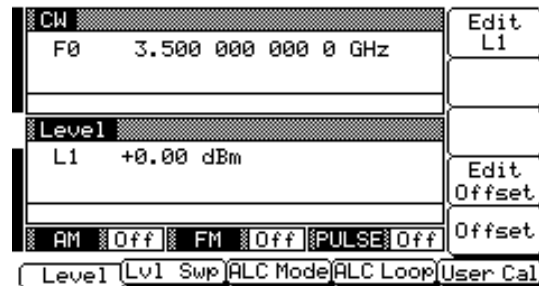

This menu lets you perform the following:

- Edit the power level parameter.
- Edit the level offset parameter.
- Turn level offset on/off.

**Selecting a
Power Level**

There are several ways to select a power level for output. You can (1) edit the current power level, (2) enter a new power level, or (3) select one of the 10 preset power level parameters.

Editing the Current Power Level

Press **Edit L1** to open the power level parameter, then edit the current power level using the cursor control key or the rotary data knob. To close the open power level parameter, press **Edit L1** or make another menu selection.

Entering a New Power Level

Press **Edit L1** to open the power level parameter, then enter the new power level using the keypad

and appropriate terminator key. To close the open power level parameter, press **Edit L1** or make another menu selection.

Selecting a Preset Power Level

To select one of the preset power levels for output, press the main menu key

**LEVEL
CONTROL**

The Level Control menu (below) is displayed.

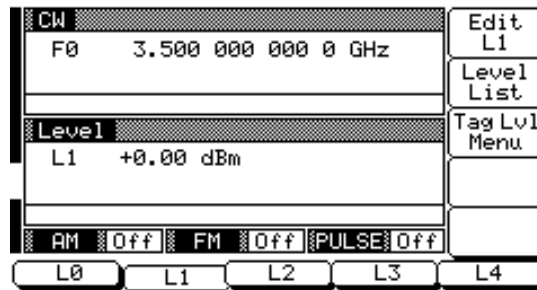

This menu lets you perform the following:

- Select preset power levels L0, L1, L2, L3, or L4 for output.
- Go to the Level List menu.
- Go to the Tagged Levels menu.

Level List– To go to the Level List menu (below), press **Level List**.

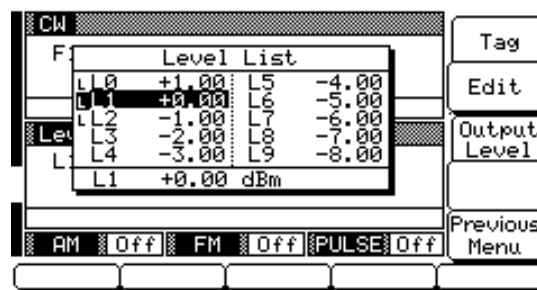

This menu lets you select a power level from the list to tag, edit, or output.

Use the cursor control key to select a power level from the level list. The selected power level is highlighted in reverse video and displayed in full below the level list.

Press **Tag** to mark a selected power level (place an **L** in front of it). If a power level is already tagged, pressing **Tag** will untag it (remove the **L**). Tagging selected power levels lets you quickly switch between them using the scan keys of the Tagged Levels menu.

Press **Edit** to edit the selected power level or enter a new power level.

Press **Output Level** to output the selected level. This power level is output until you select another level from the list and press **Output Level**. On the level list, the output power level selection is marked by a black square or, if tagged, an **L** highlighted in reverse video.

When you are finished, press **Previous Menu** to return to the Level Control menu display.

Scanning Tagged Levels—To go to the Tagged Levels menu (below) from the Level Control menu, press **Tag Lvl Menu**.

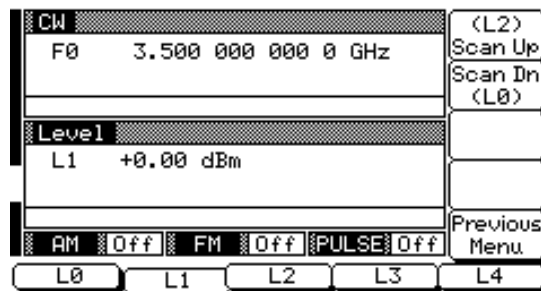

This menu lets you select the tagged power levels for output using the **Scan Up** and **Scan Dn** keys.

Return to the Level Control menu display by pressing **Previous Menu**.

Level Offset

Level offset lets you compensate for a device on the signal generator's output that alters the RF output power level at the point of interest. For example, the power level at the test device may be less or more than the displayed power level because of the loss through an external transmission line or the gain of an amplifier located between the 682XXB/683XXB RF output and the test device. Using the level offset function, you can apply a constant to the displayed power level that compensates for this loss or gain. The displayed power level will then reflect the actual power level at the test device.

To enter an offset value and apply it to the displayed power level, go to the Level Menu. Then press **Edit Offset**. As shown in the following menu, this opens the offset parameter for editing.

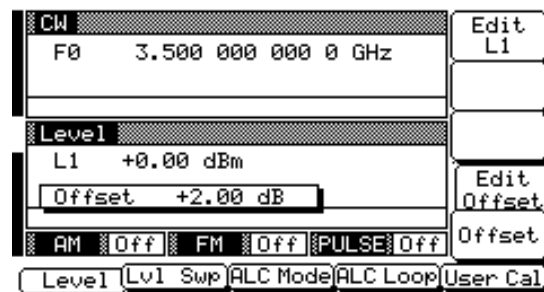

Edit the current offset value using the cursor control key or rotary data knob or enter a new offset value using the keypad and appropriate terminator key. To close the open offset parameter when you are done, press **Edit Offset** or make another menu selection.

Press **Offset** to apply the offset to the displayed power level. In this example, a +2.00 dB offset is applied to L1. L1 then displays a power level of +2.00 dBm.

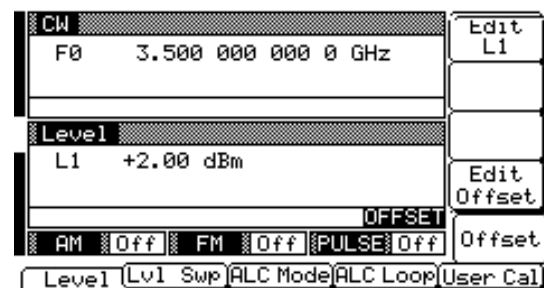

OFFSET

When Offset is selected ON, this status message is displayed on all menu displays to remind the operator that a constant (offset) has been applied to the displayed power level.

**3-10 POWER LEVEL SWEEP
OPERATION**

The 682XXB/683XXB provides leveled output power sweeps at CW frequencies and in conjunction with frequency sweeps (analog and step). Power level sweeps can be from a high level to a low level or vice versa. The following paragraphs provide descriptions and operating instructions for the CW power sweep mode and the sweep frequency/step power modes. Use the CW Power Sweep Mode and Sweep Frequency/Step Power Mode menu maps (Chapter 4, Figures 4-7 and 4-8) to follow the menu sequences.

CAUTION

Performing alternate sweeps using power levels that cross step attenuator switch points can cause excessive wear on the switches and reduce the life expectancy of the step attenuator.

**Selecting CW
Power Sweep
Mode**

In the CW power sweep mode, output power steps between any two power levels at a single CW frequency. Available menus let you set or select the sweep range, the step size, the dwell time-per-step, and the sweep trigger.

To place the signal generator in a CW power sweep mode from a CW frequency menu, press the main menu key

**LEVEL/ALC
SELECT**

At the resulting menu display, press **Lvl Swp**. The CW Level Sweep Menu (below) is displayed.

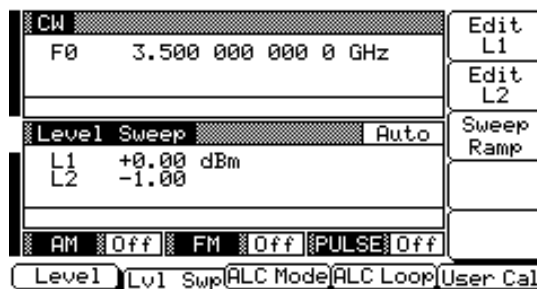

- This menu lets you perform the following:
- ❑ Select a power level sweep range (edit the sweep start and stop power level parameters).
 - ❑ Go to the sweep ramp menu (set the dwell time-per-step, the step size or number of steps, and select a sweep trigger).

**Setting CW
Power Sweep
Step Size and
Dwell Time**

There are two ways to set the size of each step of the CW power sweep—set the step size or set the number of steps. The step size range is 0.01 dB to the full power range of the instrument; the number of steps range is 1 to 10,000. The dwell-time-per-step of the CW power sweep can be set for any time in the range of 1 ms to 99 sec. The step size and dwell-time-per-step are set from the CW Level Sweep Ramp menu (below).

To go to the CW Level Sweep Ramp menu from the CW Level Sweep menu, press **Sweep Ramp**.

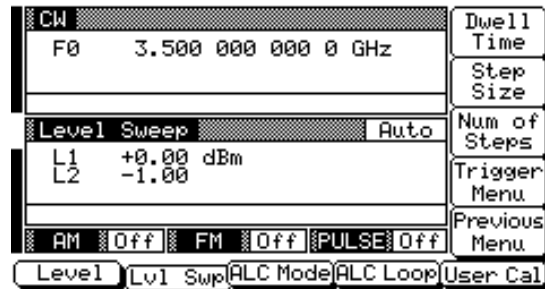

This menu lets you set the dwell time, the step size, the number of steps, and go to the trigger menu.

Press **Dwell Time** to open the dwell-time-per-step parameter.

Press **Step Size** to open the step size parameter.

Press **Num of Steps** to open the number of steps parameter.

Open the parameter you wish to change, then edit the current value using the cursor control key or rotary data knob or enter a new value using the key pad and appropriate termination key. When you have finished setting the open parameter, close it by pressing its menu soft-key or by making another menu selection.

To go to the CW Level Sweep Trigger menu from this menu, press **Trigger Menu**. The trigger menu lets you select a CW power sweep trigger (described on the following page).

Press **Previous Menu** to return to the CW Level Sweep menu.

RANGE

This error message is displayed when (1) the step size value entered is greater than the level sweep range or (2) the number of steps entered results in a step size of less than 0.01 dB. Entering a valid step size will clear the error.

**Selecting a
CW Power
Sweep
Trigger**

There are three modes of triggering provided for the CW power sweep—automatic, external, and single. The sweep trigger is selectable from the CW Level Sweep Trigger menu. The following is a description of each trigger mode.

- ❑ **Auto (Automatic)**—The CW power sweep continually sweeps from its start power level to its stop power level with optimal retrace time.
- ❑ **External**—The CW power sweep recurs when triggered by an external TTL-compatible clock pulse to the rear panel AUX I/O connector.
- ❑ **Single**—A single CW power sweep starts when the trigger key is pressed. If a sweep is in progress when the key is pressed, it aborts and resets.

To go to the CW Level Sweep Trigger menu (below) from the CW Level Sweep Ramp menu, press **Trigger Menu**.

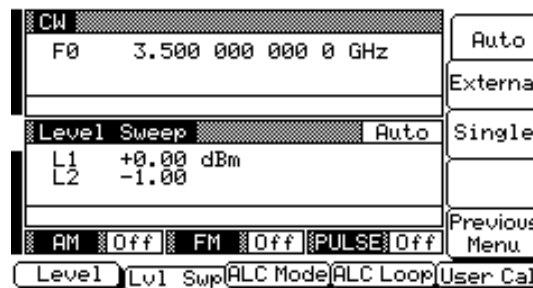

To select a CW power sweep trigger mode, press its menu soft-key. A message showing the CW power sweep trigger mode selected appears on the right side of the level mode title bar.

If you select the single sweep trigger mode, the menu display adds the menu soft-key **Trig**. Pressing **Trig** starts a single CW power sweep. If a single CW power sweep is in progress, pressing **Trig** causes the sweep to abort and reset.

Press **Previous Menu** to return to the CW Level Sweep Ramp menu.

**Selecting a
Power Level
Sweep Range**

Selecting a power level sweep range consists of choosing a start and stop level for the power level sweep. The power level sweep range selection process is identical for all power level sweep modes—CW power sweep, analog sweep frequency/step power, and step sweep frequency/step power. You can select a power level sweep range as follows:

- ❑ Edit the current start and stop power level parameter values.
- ❑ Enter new start and stop power level parameter values.
- ❑ Select one of the preset power level sweep range parameters (L1-L2, L3-L4, L5-L6, L7-L8, or L9-L0).

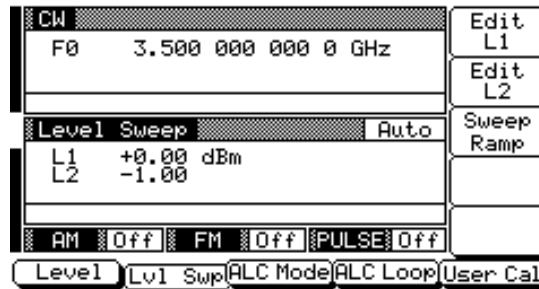

Editing the Current Start / Stop Power Levels

To edit the current power level sweep range, open either the start or stop power level parameter. In the display above, **Edit L1** opens the start power level parameter and **Edit L2** opens the stop power level parameter.

Edit the open power level parameter using the cursor control key or the rotary data knob. When you are finished, close the open parameter by pressing its menu edit soft-key or by making another menu selection.

Entering New Start / Stop Power Levels

To enter a new power level sweep range start by opening either the start or stop power level parameters (press **Edit L1** or **Edit L2**).

Enter a new power level using the keypad and appropriate terminator key. When you are finished, close the open parameter by pressing its menu edit soft-key or by making another menu selection.

Selecting a Preset Power Level Sweep Range

There are five preset power level sweep range parameters selectable in the power level sweep modes. These preset power level sweep range parameters are L1-L2, L3-L4, L5-L6, L7-L8, and L9-L0.

To select one of the preset power level sweep ranges from a Level Sweep menu, press the main menu key

**LEVEL
CONTROL**

The Level Sweep Control menu (below) is displayed.

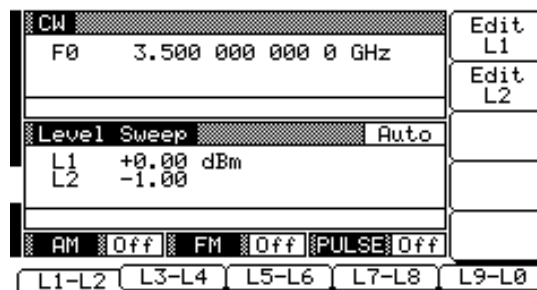

In addition to letting you select one of the preset sweep ranges for the power level sweep, this menu lets you set the start and stop power level parameters for each preset sweep range.

Setting a Preset Power Level Sweep Range—At the Level Sweep Control menu, select the power level sweep range (L1-L2, L3-L4, L5-L6, L7-L8, or L9-L0) that you wish to set. The menu then displays the current power level parameters for the selected power level sweep range. Now use the menu edit soft-keys to open the power level parameters for editing.

Edit the current power level parameter values or enter new power level parameter values for the power level sweep range. To close the open power level parameter when you are finished, press its menu edit soft-key or make another menu selection.

You can set all the preset power level sweep ranges in this manner.

**Selecting a
Sweep Fre-
quency / Step
Power Mode**

In analog sweep frequency/step power mode or step sweep frequency/step power mode, a power level step occurs after each frequency sweep. The power level remains constant for the length of time required to complete each frequency sweep. Available menus let you control the power level sweep range and step size.

To select an analog sweep frequency/step power mode, start with an analog sweep menu display; to select a step sweep frequency/step power mode, start with a step sweep menu display. Then press the main menu key

**LEVEL/ALC
SELECT**

At the resulting menu display, press **Lvl Swp**. The Level Sweep Menu is displayed.

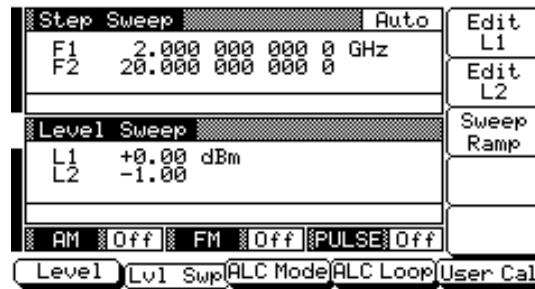

This menu lets you perform the following:

- Select a power level sweep range (edit the sweep start and stop power level parameters).
- Go to the sweep ramp menu (set the step size or number of steps).

**Setting Power
Level Step
Size**

There are two ways to set the step size of the power level step that occurs after each frequency sweep—set the step size or set the number of steps. The step size range is 0.01 dB to the full power range of the signal generator; the number of steps range is 1 to 10,000. The power level step size is set from the level sweep ramp menu.

To go to the Level Sweep Ramp menu (below) from the Level Sweep menu, press **Sweep Ramp**.

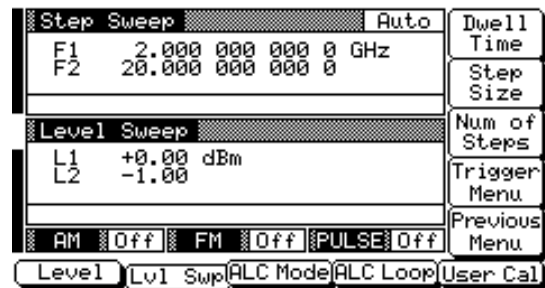

This menu lets you set the step size and the number of steps.

Press **Step Size** to open the step size parameter.

Press **Num of Steps** to open the number of steps parameter.

Open the parameter you wish to change, then edit the current value using the cursor control key or rotary data knob or enter a new value using the keypad and appropriate termination key. When you have finished setting the open parameter, close it by pressing its menu soft-key or by making another menu selection.

Press **Previous Menu** to return to the Level Sweep menu.

RANGE

This error message is displayed when (1) the step size value entered is greater than the level sweep range or (2) the number of steps entered results in a step size of less than 0.01 dB. Entering a valid step size will clear the error.

**3-11 LEVELING
OPERATIONS**

The 682XXB/683XXB generates leveled output power over a maximum range of up to 28 dB (up to 131 dB with Option 2). Instruments with Option 15B provide leveled output power over a maximum range of up to 22 dB (up to 125 dB with Option 2). An automatic level control (ALC) system controls the amplitude and power level of the RF output. The operator can select the ALC mode of operation—internal, external (detector or power meter), or fixed gain (ALC off). In addition, the signal generator provides (1) an ALC power slope function that provides compensation for high frequency system or cable losses, (2) a decouple function that allows decoupling of the step attenuator (if equipped) from the ALC system, and (3) a user level (flatness correction) calibration function that provides compensation for path-variations-with-frequency in a test setup.

The following paragraphs provide descriptions and operating instructions for the power leveling modes and functions. Use the Leveling Modes menu map (Chapter 4, Figure 4-9) to follow the menu sequences.

**Selecting a
Leveling
Mode**

The ALC system is a feedback control system, in which the output power is measured at a detector and compared with the expected power level. If the output and desired power levels do not equal, the ALC adjusts the power output until they do. The ALC feedback signal can come from either the internal detector or an external detector or power meter. Alternatively, the output power can be set to a fixed level without using the normal feedback (ALC off). The ALC mode menu lets you make the selection of a leveling mode.

To go to the ALC Mode menu, first press the main menu key

**LEVEL/ALC
SELECT**

At the Level/ALC Select Menu display, press **ALC Mode**. The ALC Mode Menu (below) is displayed.

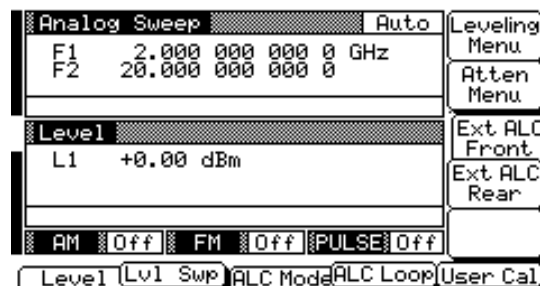

The ALC Mode menu lets you perform the following:

- ❑ Go to the leveling menu (select the ALC mode of operation).
- ❑ Go to the attenuation menu (decouple the attenuator, if equipped, from the ALC system and set the power level and attenuation).
- ❑ Select either the front panel or rear panel external ALC input.

Internal Leveling

This is the normal (default) leveling mode. Output power is sensed by the internal detector in the 682XXB/683XXB. The detector output signal is fed back to the ALC circuitry to adjust the output power level. Internal ALC is selected from the leveling menu.

To go to the Leveling Menu from the ALC Mode menu, press **Leveling Menu**. The Leveling Menu (below) is displayed.

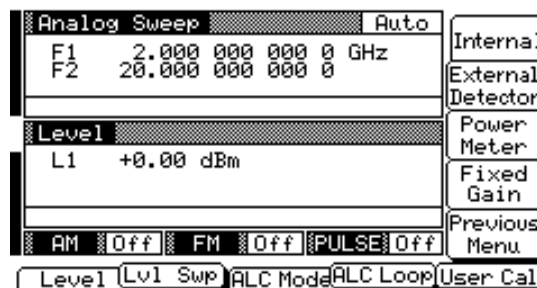

To select internal ALC, press **Internal**.

Pressing one of the other leveling menu soft-keys **External Detector**, **Power Meter**, or **Fixed Gain** will turn off internal leveling.

Press **Previous Menu** to return to the ALC Mode menu.

External Leveling

In external leveling, the output power from the 682XXB/683XXB is detected by an external detector or power meter. The signal from the detector or power meter is returned to the ALC circuitry. The ALC adjusts the output power to keep the power level constant at the point of detection. The external ALC source input is selected from the leveling menu.

Before going to the Leveling Menu from the ALC Mode menu, select whether the external ALC signal is to be connected to the front- or rear-panel EXT ALC IN connector.

At the ALC Mode menu, press **Ext ALC Front** to select front panel input, or **Ext ALC Rear** to select rear panel input.

Now, press **Leveling Menu** to go to the Leveling Menu (below).

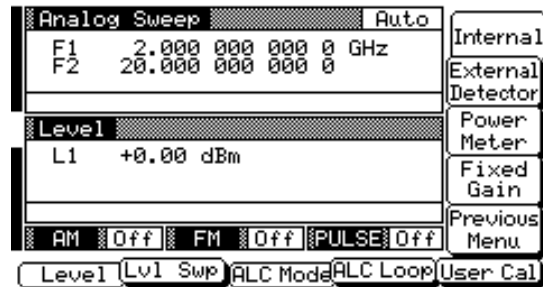

Next, select the type of external sensor you are using to detect the output power.

To select the external ALC input from an external detector, press **External Detector**.

To select the external ALC input from a power meter, press **Power Meter**.

After you have made the external ALC input connection and selected the sensor type, press **ALC Loop**. The ALC Loop Menu (below) is displayed.

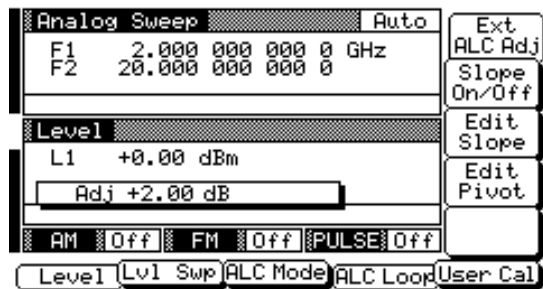

While monitoring the power level at the external detection point, first press **Ext ALC Adj**, then use the cursor control key or rotary data knob to adjust the external ALC signal to obtain the set power level.

To return to the Leveling Menu, press **ALC Mode** then press **Leveling Menu**.

At the Leveling menu, pressing either **Internal** or **Fixed Gain** will turn off external leveling.

Press **Previous Menu** to return to the ALC Mode menu.

Fixed Gain

In the fixed gain mode, the ALC is disabled. The RF Level DAC and step attenuator (if installed) are used to control the relative power level. Power is not detected at any point, and the absolute power level is uncalibrated. Fixed gain mode is selected from the leveling menu.

Press **Leveling Menu** to go to the Leveling menu.

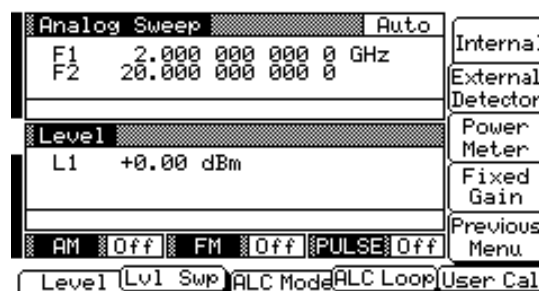

To select fixed gain mode, press **Fixed Gain**.

To return to normal ALC operation, press **Internal**.

Press **Previous Menu** to return to the ALC Mode menu.

***Attenuator
Decoupling***

In 682XXB/683XXBs equipped with option 2 step attenuators, the ALC and attenuator work in conjunction to provide leveled output power down to -120 dBm. In the normal (coupled) leveling mode, when the desired power level is set, the correct combination of ALC level and attenuator setting is determined by the instrument firmware. In some applications, such as receiver sensitivity testing, it is desirable to control the ALC level and attenuator setting separately by decoupling the step attenuator from the ALC. The ALC mode menu lets you select attenuator decoupling.

At the ALC Mode menu, press **Atten Menu**. The Attenuator Menu (below) is displayed.

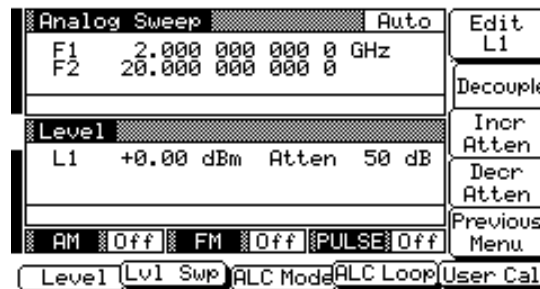

This menu lets you decouple the step attenuator from the ALC, set the power level, and set the attenuation in 10 dB steps.

Press **Decouple** to decouple the step attenuator from the ALC.

Press **Edit L1** to open the power level parameter for editing. Edit the current level using the cursor control key or rotary data knob or enter a new value using the key pad and appropriate termination key. When you have finished setting the power level, press **Edit L1** to close the open parameter.

To change the attenuation setting, press **Incr Atten** or **Decr Attn**. Pressing these soft-keys changes the attenuation in 10 dB steps.

Press **Previous Menu** to return to the ALC Mode menu.

NOTE

The set power level may not be maintained when switching between attenuator coupling modes.

**ALC Power
Slope**

The ALC power slope function lets you compensate for system, cable, and waveguide variations due to changes in frequency. This is accomplished by linearly increasing or decreasing power output as the frequency increases. As shown in the following illustration, the power slope function provides you with the ability to set both the power slope and the pivot point. The ALC loop menu lets you activate the ALC power slope function.

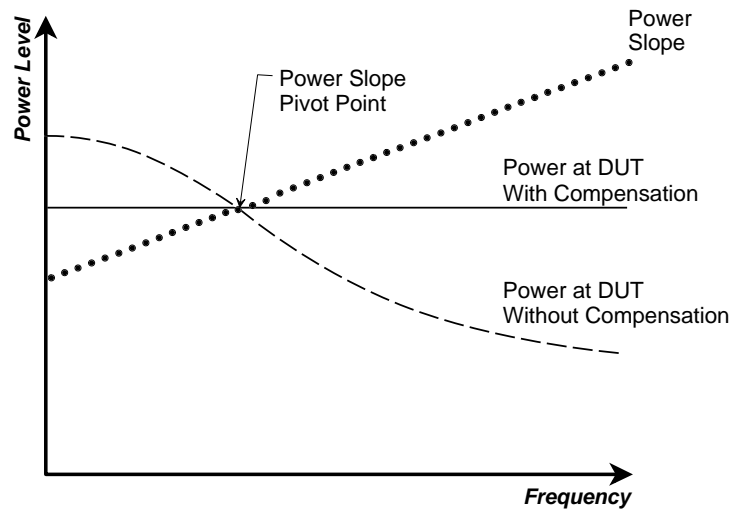

To go to the ALC Loop Menu from the Level/ALC Control Menu display, press **ALC Loop**. The ALC Loop Menu (below) is displayed.

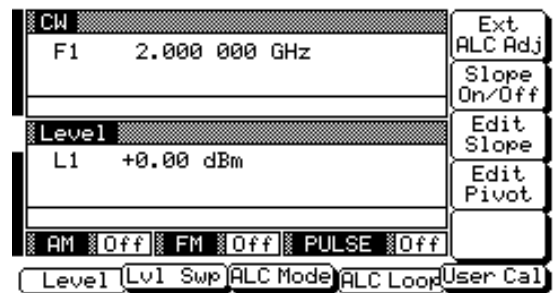

This menu lets you turn the power slope on or off and edit the slope value and pivot point frequency.

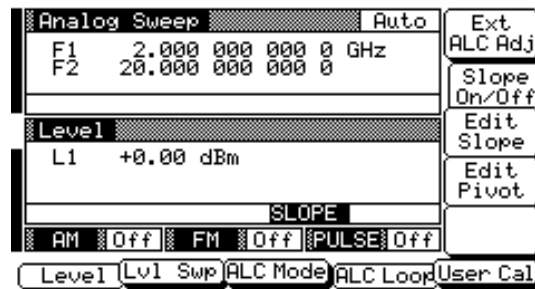

Press **Slope On/Off** to activate the ALC power slope function.

Press **Edit Pivot** to open the pivot point frequency parameter for editing. Edit the current frequency using the cursor control key or rotary data knob or enter a new value using the keypad and appropriate termination key. When you have finished setting the open parameter, close it by pressing **Edit Pivot** again or by making another menu selection.

Press **Edit Slope** to open the slope parameter for editing. Edit the current slope value using the cursor control key or rotary data knob or enter a new value using the key pad and the STEPS termination key. When you have finished setting the open parameter, close it by pressing **Edit Slope** again or by making another menu selection.

While monitoring the power level at the device-under-test (DUT), adjust the power slope and pivot point to level the power at the DUT.

SLOPE

When Power Slope is selected ON, this status message is displayed on all menu displays to remind the operator that a power slope correction has been applied to the ALC.

**User Cal
(User Level
Flatness
Correction)**

The User Cal (user level flatness correction) function lets you compensate for path-variations-with-frequency that are caused by external switching, amplifiers, couplers, and cables in the test setup. This is done by means of an entered power-offset table from a GPIB power meter or calculated data. When user level flatness correction is activated, the set power level is delivered at the point in the test setup where the calibration was performed. This “flattening” of the test point power level is accomplished by summing a power-offset word (from the power-offset table) with the signal generator’s normal power level DAC word at each frequency point.

Up to five user level flatness correction power-offset tables from 2 to 801 frequency points/table can be created and stored in 682XXB/683XXB memory for recall. The GPIB power meters supported are the ANRITSU Model ML4803A and the Hewlett-Packard Models 437B, 438A, and 70100A.

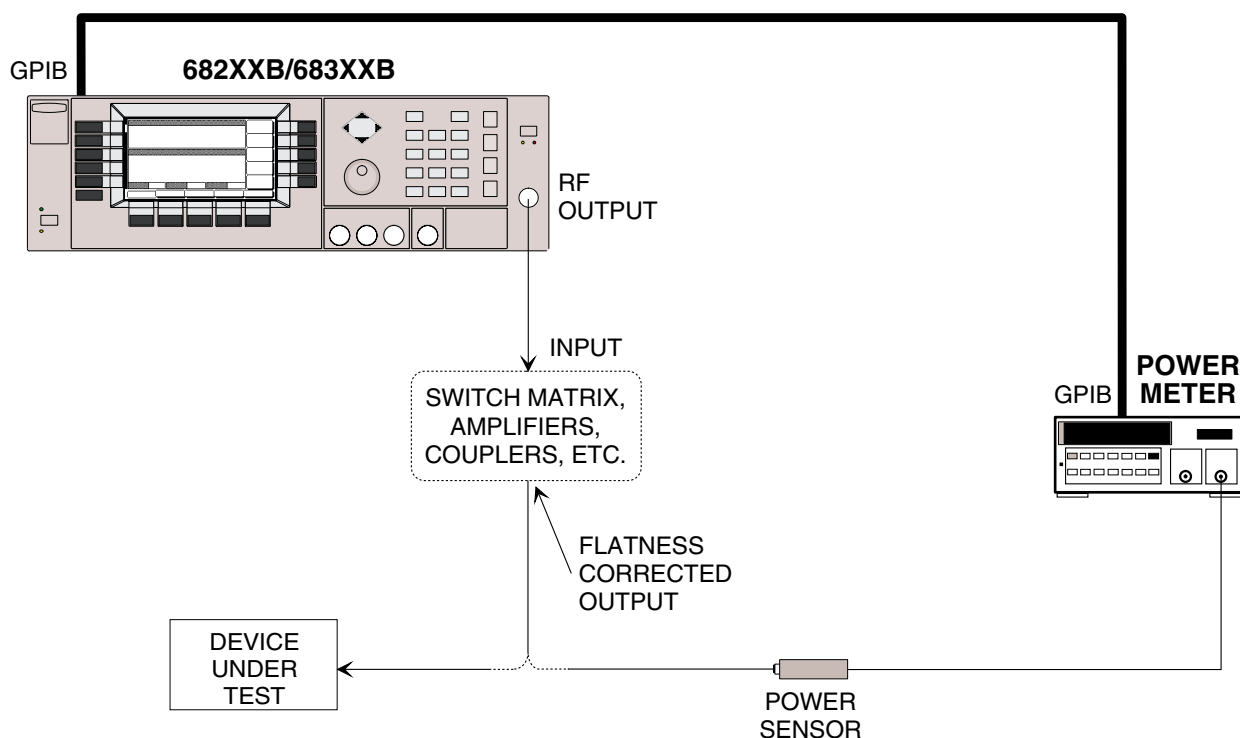

Figure 3-4. Setup for Creating a Power-Offset Table (User Level Flatness Correction)

Equipment Setup

To create a power-offset table for user level flatness correction, connect the equipment (shown in Figure 3-4) as follows:

- Step 1** Using a GPIB cable, connect the Power Meter to the 682XXB/683XXB.
- Step 2** Calibrate the Power Meter with the Power Sensor.
- Step 3** Connect the Power Sensor to the point in the test setup where the corrected power level is desired.

Power Meter Model and GPIB Address

In order for the 682XXB/683XXB to control the power meter, the GPIB address and power meter model must be selected from the Configure GPIB menu.

Press **SYSTEM** to go to the System Menu display. At the System Menu display, press **Config**. The System Configuration Menu (below) is displayed.

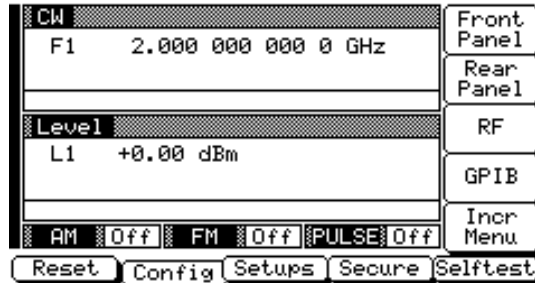

Next, press **GPIB**. The Configure GPIB menu (below) is displayed.

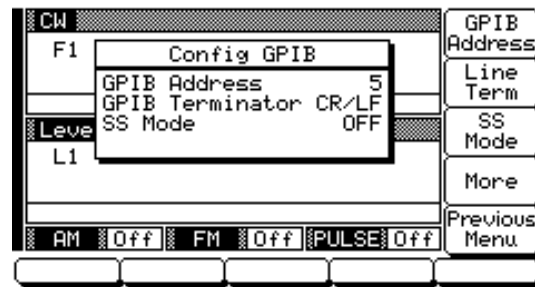

At the Configure GPIB menu, press **More** to go to an additional Configure GPIB menu (below).

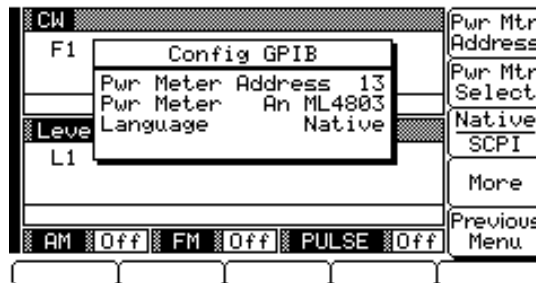

Press **Pwr Mtr Address** to change the address of the power meter on the GPIB (the power meter's default address is 13). Enter the new address, between 1 and 30, using the cursor control key or the data entry key pad and the terminator key



The new GPIB address will appear on the display.

Press **Pwr Mtr Select** to select the power meter model being used. (Supported power meters are the ANRITSU ML4803A and Hewlett-Packard 437B, 438A, and 70100A.)

Press **Previous Menu** to return to the main Configure GPIB menu display.

At the Configure GPIB menu, press **Previous Menu** to return to the System Configuration menu display.

Creating a Power-Offset Table

The 682XXB/683XXB must be in CW frequency mode and fixed (non-swept) power level mode in order to create a power-offset table for user level flatness correction.

Place the signal generator in CW frequency mode by pressing the main menu key



At the resulting menu display, press **CW**. The 682XXB/683XXB is now in CW frequency mode.

Place the signal generator in a fixed power level mode by pressing the main menu key

**LEVEL/ALC
SELECT**

At the resulting menu display, press **Level**. The 682XXB/683XXB is now in fixed (non-swept) power level mode.

At the Level Menu, press **User Cal**. The User Level Cal menu (below) is displayed.

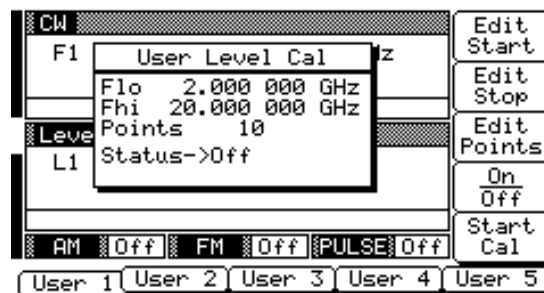

This menu lets you perform the following:

- Create a power-offset table.
- Select a measurement frequency range (edit the start and stop frequency parameters).
- Select the number of points at which correction information is to be taken.
- Apply a power-offset table to the test setup.

First, press the menu soft-key to select the power-offset table (User 1, User 2, User 3, User 4, or User 5) that you wish to create.

Next, set the measurement frequency range by pressing **Edit Start** or **Edit Stop** to open the start (Flo) or stop (Fhi) frequency parameter for editing. Edit the current frequency using the cursor control key or rotary data knob or enter a new value using the keypad and appropriate termination key. When you have finished setting the open parameter, close it by pressing its menu edit soft-key again or by making another menu selection.

Then, select the number of frequency points at which correction information is to be taken by pressing **Edit Points** to open the number-of-points parameter for editing. Edit the current number-of-points using the cursor control key or rotary data knob or enter a new value using the keypad and the STEPS termination key. (The number of points

range is 2 to 801.) When you have finished setting the open number-of-points parameter, close it by pressing **Edit Points** again or by making another menu selection.

Now, press **Start Cal** to begin automatically taking power level correction information at each frequency point. During this process the menu displays the status: Calibrating along with the current measurement frequency point.

NOTE

To terminate the measurement process at any time before completion, press **Abort**.

Once the power-offset table has been created, it is stored in non-volatile memory. The power-offset table is now ready to be applied to the test setup. Disconnect the Power Sensor and Power Meter from the test setup.

Applying User Level Flatness Correction

Whenever user level flatness correction is applied to the test setup by activating the power-offset table, the set power level is delivered at the point where the calibration was performed.

To activate the selected power-offset table and apply user level flatness correction to the test setup, press **On/Off**. The User Level Cal menu will display the status: On.

To turn off the selected power-offset table and remove user level flatness correction from the test setup, press **On/Off** again. The User Level Cal menu will display the status: Off.

Entering a Power-Offset Table via GPIB

User level flatness correction can be applied to the test setup using a power-offset table created from calculated data and entered via the GPIB. Refer to the 682XXB/683XXB GPIB Programming Manual (P/N 10370-10286) for information and instructions on creating a power-offset table and entering it via the GPIB.

USER 1...5

When a power-offset table is selected ON, this status message is displayed on all menu displays to remind the operator that user level flatness correction has been applied to the ALC.

NOTE

The master reset function overwrites all information stored in the non-volatile memory with default values. This includes the nine stored front panel setups.

Erasing the Power-Offset Tables from Memory

The power-offset tables are stored in non-volatile memory. A master reset is required to erase the contents of the tables and reprogram them with default data.

To perform a master reset, proceed as follows:

- Step 1** With the 682XXB/683XXB in standby, press and hold the RF OUTPUT ON/OFF key.
- Step 2** Press the LINE OPERATE/STANDBY key to turn the instrument on.
- Step 3** When the first menu is displayed (after the start-up display), release the RF OUTPUT ON/OFF key.

The contents of non-volatile memory have now been erased and reprogrammed with default data.

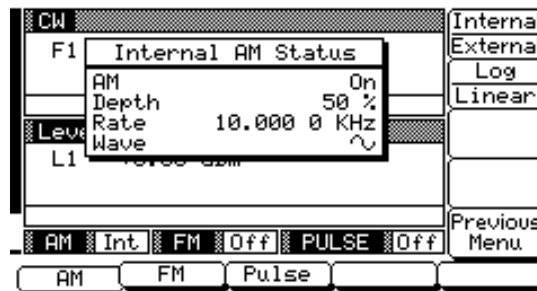

This menu lets you perform the following:

- ❑ Select the modulating signal source.
- ❑ Select the Linear AM or Log AM operating mode.

Press **Internal / External** to select the source of the modulating signal. Internal selects the modulating signal from the internal AM generator; external selects the modulating signal from an external source. The AM status display will reflect your selection.

Press **Log / Linear** to select the AM operating mode. When Internal AM is active, the AM Depth display will reflect your selection as XX dB (Log) or XX % (Linear). When External AM is active, the AM Sensitivity display will reflect your selection as XX dB/V (Log) or XX %/V (Linear).

Press **Previous Menu** to return to the main AM Status Menu display.

Internal AM Source

Once you have pressed **Internal / External** to select the internal AM generator as the modulating signal source, the Internal AM Status Menu (below) is displayed.

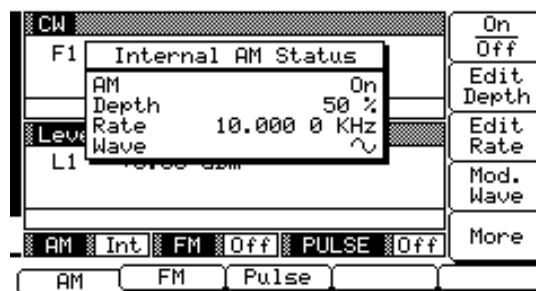

This menu contains the internal AM status window that shows the current menu selections. This menu lets you perform the following:

- Turn AM on and off.
- Set the AM Depth.
- Set the AM Rate.
- Go to the Modulation Waveform Selection menu.

Press **On / Off** to turn AM on and off. The Internal AM status display will reflect your selection as On or Off; the AM modulation status area will reflect your selection as Int (On) or Off.





Press **Edit Depth** to open the AM Depth parameter, then edit the current value using the cursor control key or rotary data knob or enter a new value using the keypad and the appropriate terminator key (kHz/μs/STEPS for Linear; MHz/ms/dB for Log). The AM Depth range is 0–100% in Linear and 0–25 dB in Log. To close the open AM Depth parameter, press **Edit Depth** or make another menu selection.

Press **Edit Rate** to open the AM Rate parameter, then edit the current value using the cursor control key or rotary data knob or enter a new value using the keypad and the appropriate terminator key. The AM rate range is 0.1 Hz to 1 MHz for sine wave and 0.1 Hz to 100 kHz for square, triangle, and ramp waveforms. To close the open AM Rate parameter, press **Edit Rate** or make another menu selection.

Press **Mod. Wave** to go to the Modulation Waveform Selection menu (below).

Reduce Rate

This warning message is displayed when the AM Rate is set >100 kHz for a non-sinewave modulating waveform. Amplitude modulation of the output signal will continue but the modulating waveform may be distorted.

-  — sine wave
-  — square wave
-  — positive ramp
-  — negative ramp
- GN** — Gaussian noise
- UN** — uniform noise
-  — triangle wave

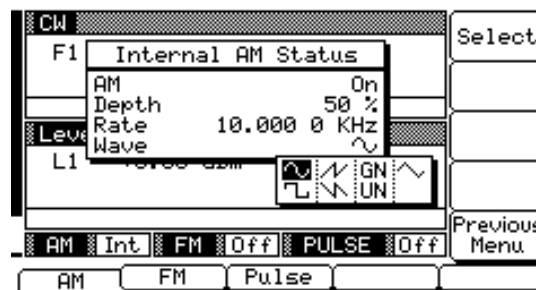

This menu displays the modulation waveforms (on the left) that are available from the AM generator. Use the cursor control key to highlight the desired modulation waveform, then press **Select** to select it. The AM Status display will reflect your selection.

Press **Previous Menu** to return to the main AM Status Menu display.

External AM Source

To provide amplitude modulation of the output signal using a modulating signal from an external source, first set up the external signal generator and connect it to either the 682XXB/683XXB front or rear panel AM IN connector.

Next, go to the additional AM Status Menu (page 3-64) and press **Internal / External** to select the external source for the modulating signal. The External AM Status Menu (below) is then displayed.

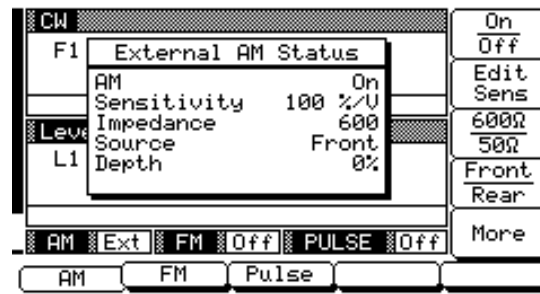

This menu contains the external AM status window that shows the current menu selections and the measured AM Depth (The AM depth measurement function measures the voltage of the external modulation signal and calculates the percentage modulation value). The menu lets you perform the following:

- Turn AM on and off.
- Set the AM Sensitivity.
- Select the input impedance (600Ω or 50Ω) of the input connector.
- Select the input connector (front panel or rear panel AM IN) that is connected to the external signal source.

ERR

This error message is displayed when the external AM modulating signal exceeds the input voltage range. The message “**Reduce AM Input Level**” also appears at the bottom of the AM status display. AM is turned off until the modulating signal is within the input voltage range.

Press **On / Off** to turn AM on and off. The External AM status display will reflect your selection as On or Off; the AM modulation status area will reflect your selection as Ext (On) or Off.

Press **Edit Sens** to open the AM Sensitivity parameter, then edit the current value using the cursor control key or rotary data knob or enter a new value using the keypad and the appropriate terminator key (kHz/μs/STEPS for Linear; MHz/ms/dB for Log). The AM Sensitivity range is 0 %/V to 100 %/V

in Linear and 0 dB/V to 25 dB/V in Log. To close the open AM Sensitivity parameter, press **Edit Sens** or make another menu selection.

Press **600Ω / 50Ω** to select the input impedance of the input connector. The AM status display will reflect your selection.

Press **Front / Rear** to select the front panel or rear panel AM IN connector. The AM status display will reflect your selection.

**Frequency
Modulation
Operating
Modes**

The signal generator has four FM operating modes—Locked, Locked Low-Noise, Unlocked Narrow, and Unlocked Wide. In the Locked and Locked Low-Noise FM modes, frequency modulation of the output signal is accomplished by summing the modulating signal into the FM control path of the YIG phase-lock loop.

In Locked FM mode, the maximum FM deviation is the lesser of ± 10 MHz or rate $\times 300$ for 1 kHz to 8 MHz rates; in Locked Low-Noise FM mode, the maximum FM deviation is the lesser of ± 10 MHz or rate $\times 3$ for 50 kHz to 8 MHz rates.

In Unlocked FM modes, the YIG phase-lock loop is disabled to allow for peak FM deviations of up to 100 MHz. In Unlocked Narrow mode, frequency modulation is obtained by applying the modulating signal to the fine tuning coil of the YIG-tuned oscillator. Unlocked Narrow FM mode allows maximum deviations of ± 10 MHz for DC to 8 MHz rates.

In Unlocked Wide mode, frequency modulation is accomplished by applying the modulating signal to the main tuning coil of the YIG-tuned oscillator. Unlocked Wide FM mode allows maximum deviations of ± 100 MHz for DC to 100 Hz rates.

NOTE

Refer to Appendix B, page B-8, for the maximum FM deviation specifications for 682X5B models. Refer to Appendix B, page B-18, for the maximum FM deviation specifications for 683X5B models.

**Providing
Frequency
Modulation**

The following are the menu selections necessary to provide frequency modulation of the output signal using a modulating signal from both the internal FM generator and an external source.

Press **MODULATION**. At the resulting menu display, press **FM**. The main FM Status Menu (below) is displayed.

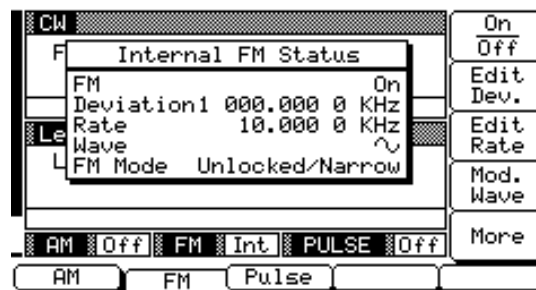

Now, press the menu soft-key **More**. The additional FM Status Menu (below) is displayed.

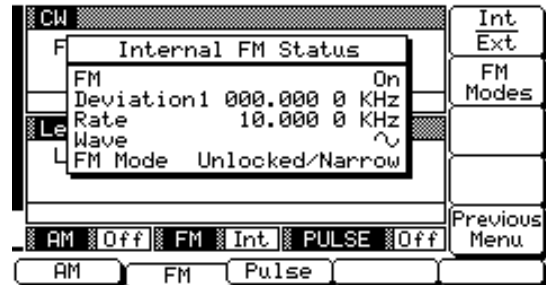

This menu lets you perform the following:

- Select the modulating signal source.
- Go to the FM Mode Selection menu.

Press **Int / Ext** to select the source of the modulating signal. Int selects the modulating signal from the internal FM generator; Ext selects the modulating signal from an external source. The FM status display will reflect your selection.

Press **FM Modes** to go to the FM Mode Selection menu (below).

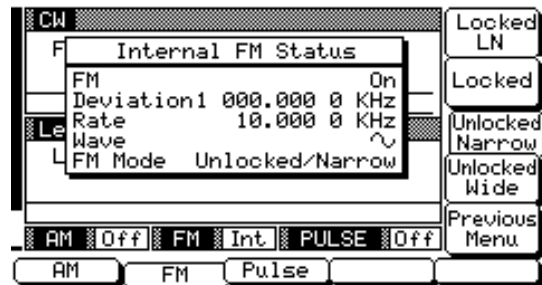

This menu lets you select the FM operating mode.

Press **Locked LN** to select the Locked Low-Noise FM operating mode; press **Locked** to select the Locked FM operating mode; press **Unlocked Narrow** to select the Unlocked Narrow FM operating mode; or press **Unlocked Wide** to select the Unlocked Wide FM operating mode. The FM status display will reflect your selection.

Press **Previous Menu** to return to the additional FM Status Menu display.

At this display, press **Previous Menu** to return to the main FM status display.

UNLOCKED

When Unlocked Narrow FM or Unlocked Wide FM is selected ON, this warning message is displayed on all menu displays to remind the operator that the carrier frequency is not phase-locked.

Internal FM Source

Once you have pressed **Int / Ext** to select the internal FM generator as the modulating signal source, the Internal FM Status Menu (below) is displayed.

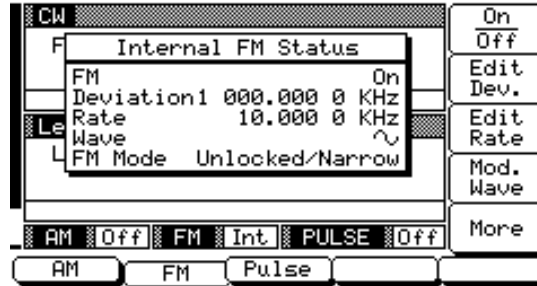

This menu contains the internal FM status window that shows the current menu selections. This menu lets you perform the following:

- Turn FM on and off.
- Set the FM Deviation.
- Set the FM Rate.
- Go to the Modulation Waveform Selection menu.

Press **On / Off** to turn FM on and off. The Internal FM status display will reflect your selection as On or Off; the FM modulation status area will reflect your selection as Int (On) or Off.

Press **Edit Dev.** to open the FM Deviation parameter, then edit the current value using the cursor control key or rotary data knob or enter a new value using the keypad and the appropriate terminator key. The FM Deviation range is 10 kHz to 20 MHz for Locked, Locked Low-Noise, and Unlocked Narrow FM modes and 100 kHz to 100 MHz for Unlocked Wide FM mode. To close the open FM Deviation parameter, press **Edit Dev.** or make another menu selection.

Press **Edit Rate** to open the FM Rate parameter, then edit the current value using the cursor control key or rotary data knob or enter a new value using the keypad and the appropriate terminator key. The FM rate range is 0.1 Hz to 1 MHz for sine wave and 0.1 Hz to 100 kHz for square, triangle, and ramp waveforms. To close the open FM Rate parameter, press **Edit Rate** or make another menu selection.

Reduce Rate

This warning message is displayed when the FM Rate is set >100 kHz for a non-sinewave modulating waveform. Frequency modulation of the output signal will continue but the modulating waveform may be distorted.

Press **Mod. Wave** to go to the Modulation Waveform Selection menu (below).

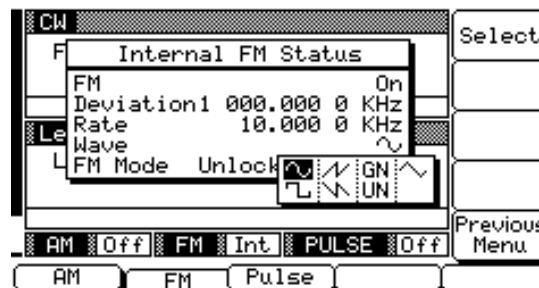
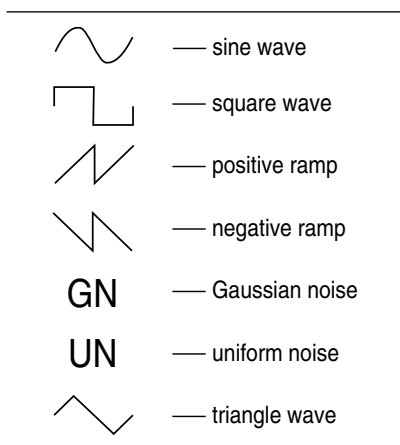

This menu displays the modulation waveforms (on the left) that are available from the FM generator. Use the cursor control key to highlight the desired modulation waveform, then press **Select** to select it. The FM Status display will reflect your selection.

Press **Previous Menu** to return to the main FM Status Menu display.

External FM Source

To provide frequency modulation of the output signal using a modulating signal from an external source, first set up the external signal generator and connect it to either the 682XXB/683XXB front or rear panel FM IN connector.

Next, go to the additional FM Status Menu (page 3-69) and press **Int / Ext** to select the external source for the modulating signal. The External FM Status Menu (below) is then displayed.

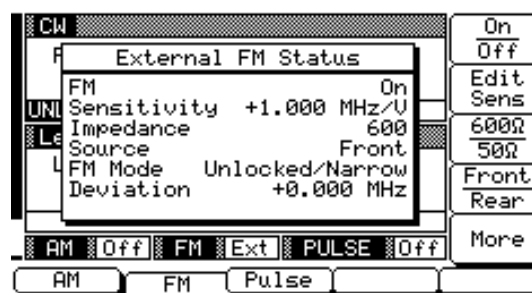

This menu contains the external FM status window that shows the current menu selections and the measured FM Deviation (The FM deviation measurement function measures the voltage of the external modulation signal and calculates the peak frequency deviation). The menu lets you perform the following:

- ❑ Turn FM on and off.
- ❑ Set the FM Sensitivity.
- ❑ Select the input impedance (600Ω or 50Ω) of the input connector.
- ❑ Select the input connector (front panel or rear panel FM IN) that is connected to the external signal source.

Press **On / Off** to turn FM on and off. The External FM status display will reflect your selection as On or Off; the FM modulation status area will reflect your selection as Ext (On) or Off.

Press **Edit Sens** to open the FM Sensitivity parameter, then edit the current value using the cursor control key or rotary data knob or enter a new value using the keypad and the appropriate terminator key. The FM Sensitivity range is ± 10 kHz/V to ± 20 MHz/V for Locked, Locked Low-Noise, and Unlocked Narrow FM modes and ± 100 kHz/V to ± 100 MHz/V for Unlocked Wide FM mode. To close the open FM Sensitivity parameter, press **Edit Sens** or make another menu selection.

Press **600Ω / 50Ω** to select the input impedance of the input connector. The FM status display will reflect your selection.

Press **Front / Rear** to select the front panel or rear panel FM IN connector. The FM status display will reflect your selection.

ERR

This error message is displayed when the external FM modulating signal exceeds the input voltage range. The message "Reduce FM Input Level" also appears at the bottom of the FM status display. FM is turned off until the modulating signal is within the input voltage range.

**Phase
Modulation
Operating
Modes**

When Option 6 is added to the instrument, the 682XXB/683XXB provides phase modulation (Φ M) of the output signal using modulating signals from either its internal Φ M generator or an external source.

NOTE

Refer to Appendix B, page B-8, for the maximum Φ M deviation specifications for 682X5B models. Refer to Appendix B, page B-18, for the maximum Φ M deviation specifications for 683X5B models.

The 682XXB/683XXB has two Φ M operating modes—Narrow Φ M and Wide Φ M. In Narrow Φ M mode, the maximum Φ M deviation is the lesser of ± 3 radians or ± 5 MHz/rate for DC to 8 MHz rates. In Wide Φ M mode, the maximum Φ M deviation is the lesser of ± 400 radians or ± 10 MHz/rate for DC to 1 MHz rates.

NOTE

FM and Φ M can not be active simultaneously. FM and Φ M share the same front and rear panel input connectors and internal signal generator.

**Providing
Phase
Modulation**

The following are the menu selections necessary to provide phase modulation of the output signal using a modulating signal from both the internal Φ M generator and an external source.

Press MODULATION. At the resulting menu display, press Φ M. The main Φ M Status Menu (below) is displayed.

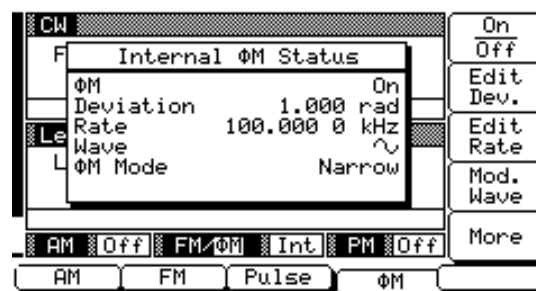

Now, press the menu soft-key **More**. The additional Φ M Status Menu (below) is displayed.

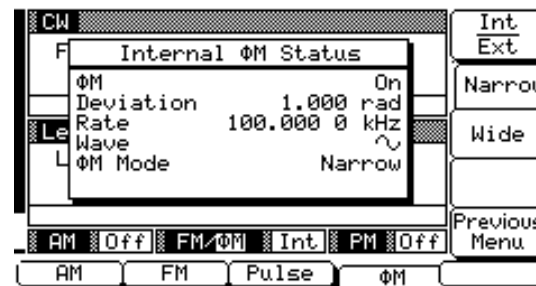

This menu lets you perform the following:

- Select the modulating signal source.
- Select the Φ M operating mode (Narrow or Wide).

Press **Int / Ext** to select the source of the modulating signal. Int selects the modulating signal from the internal Φ M generator; Ext selects the modulating signal from an external source. The Φ M status display will reflect your selection.

Next, select the Φ M operating mode. Press **Narrow** to select the Narrow Φ M operating mode; press **Wide** to select the Wide Φ M operating mode. The Φ M status display will reflect your selection.

Press **Previous Menu** to return to the Main Φ M Status Menu display.

Internal Φ M Source

Once you have pressed **Int / Ext** to select the internal Φ M generator as the modulating signal source, the Internal Φ M Status Menu (below) is displayed.

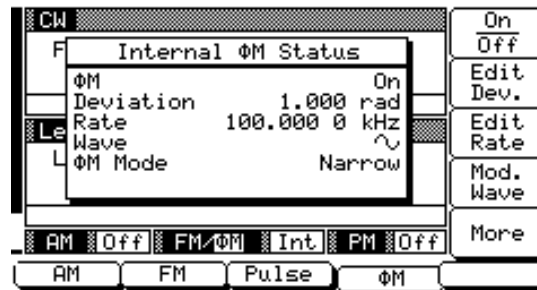

This menu contains the internal Φ M status window that shows you the current menu selections. This menu lets you perform the following:





- Turn Φ M on and off.
- Set the Φ M Deviation.
- Set the Φ M Rate.
- Go to the Modulation Waveform Selection menu.

Press **On / Off** to turn the Φ M on and off. The Internal Φ M status display will reflect your selection as On or Off; the Φ M modulation status area will reflect your selection as Int (On) or Off.

Press **Edit Dev.** to open the Φ M Deviation parameter, then edit the current value using the cursor con-

Reduce Rate

This warning message is displayed when the Φ M Rate is set >100 kHz for a non-sinewave modulating waveform. Phase modulation of the output signal will continue but the modulating waveform may be distorted.

-  — sine wave
-  — square wave
-  — positive ramp
-  — negative ramp
- GN** — Gaussian noise
- UN** — uniform noise
-  — triangle wave

trol key or rotary data knob or enter a new value using the keypad and the appropriate terminator key. The Φ M Deviation range is 0.0025 to 5 radians in Narrow Φ M mode and 0.25 to 500 radians in Wide Φ M mode. To close the open Φ M Deviation parameter, press **Edit Dev.** or make another menu selection.

Press **Edit Rate** to open the Φ M Rate parameter, then edit the current value using the cursor control key or rotary data knob or enter a new value using the keypad and the appropriate terminator key. The Φ M Rate range is 0.1 Hz to 1 MHz for sine wave and 0.1 Hz to 100 kHz for square, triangle, and ramp waveforms. To close the open Φ M Rate parameter, press **Edit Rate** or make another menu selection.

Press **Mod. Wave** to go to the Modulation Waveform Selection menu (below).

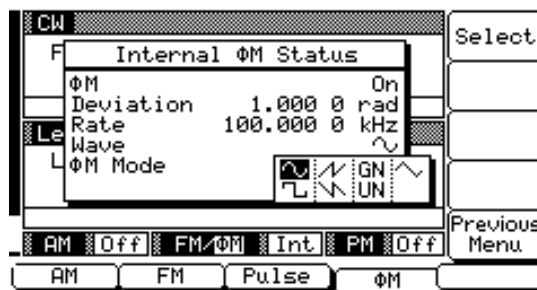

This menu displays the modulation waveforms (on the left) that are available from the Φ M generator. Use the cursor control key to highlight the desired modulation waveform, then press **Select** to select it. The Φ M Status display will reflect your selection.

Press **Previous Menu** to return to the main Φ M Status Menu display.

External Φ M Source

To provide phase modulation of the output signal using a modulating signal from an external source, first setup the external signal generator and connect it to either the 682XXB/683XXB front or rear panel FM/ Φ M IN connector.

Next, go to the additional Φ M Status Menu (page 3-73) and press **Int / Ext** to select the external source for the modulating signal. The External Φ M Status Menu is then displayed.

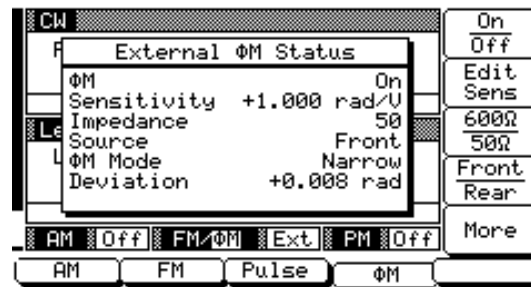

This menu contains the external FM status window that shows the current menu selections and the measured FM Deviation (The FM deviation measurement function measures the voltage of the external modulation signal and calculates the peak frequency deviation). The menu lets you perform the following:

- Turn FM on and off.
- Set the FM Sensitivity.
- Select the input impedance (600Ω or 50Ω) of the input connector.
- Select the input connector (front panel or rear panel FM/FM IN) that is connected to the external signal source.

Press **On / Off** to turn FM on and off. The External FM status display will reflect your selection as On or Off; the FM modulation status area will reflect your selection as Ext (On) or Off.

Press **Edit Sens** to open the FM Sensitivity parameter, then edit the current value using the cursor control key or rotary data knob or enter a new value using the keypad and the appropriate terminator key. The FM Sensitivity range is ± 0.0025 radians/V to ± 5 radians/V for Narrow FM mode and ± 0.25 radians/V to ± 500 radians/V for Wide FM mode. To close the open FM Sensitivity parameter, press **Edit Sens** or make another menu selection.

Press **600Ω / 50Ω** to select the input impedance of the input connector. The FM status display will reflect your selection.

Press **Front / Rear** to select the front or rear panel FM/FM IN connector. The FM status display will reflect your selection.

ERR

This error message is displayed when the external FM modulating signal exceeds the input voltage range. The message "Reduce FM Input Level" also appears at the bottom of the FM status display. FM is turned off until the modulating signal is within the input voltage range.

**Pulse
Modulation
Operating
Modes**

The 682XXB/683XXB provides pulse modulation of the output signal using modulating signals from either its internal pulse generator or an external source.

The internal pulse generator has four pulse modes—single, doublet (double pulse), triplet (triple pulse), and quadruplet (quadruple pulse). Individual pulse widths (W1, W2, W3, and W4) and delays (D1, D2, D3, and D4) can be set for each of the pulses in a mode.

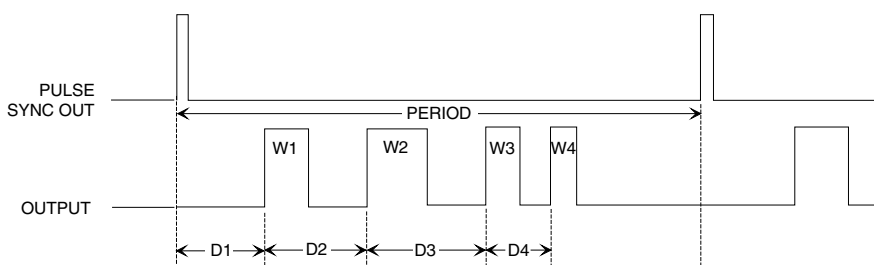

The internal pulse generator can be internally triggered, externally triggered, internally and externally triggered with delay, and externally gated. There is also a composite mode in which an external pulse is summed with the internal pulse to pulse modulate the output signal.

Whenever the internal pulse generator is internally triggered, a TTL compatible signal that is synchronized to the internal pulse modulation output is available at the rear panel PULSE SYNC OUT connector.

The internal pulse generator has two selectable clock rates—40 MHz and 10 MHz. The 40 MHz clock rate produces higher resolution pulses (25 ns) and allows higher PRFs; the 10 MHz clock rate produces lower resolution pulses (100 ns) and lower PRFs.

External signals or pulses to trigger or gate the internal pulse generator can be applied to either the front panel or rear panel PULSE TRIGGER IN connector.

**Providing
Pulse
Modulation**

The following are the menu selections necessary to provide pulse modulation of the output signal using a modulating signal from both the internal pulse generator and an external source.

Internal Pulse Source

Press **MODULATION**. At the resulting menu display, press **Pulse**. The Internal Pulse Status Menu (below) is displayed.

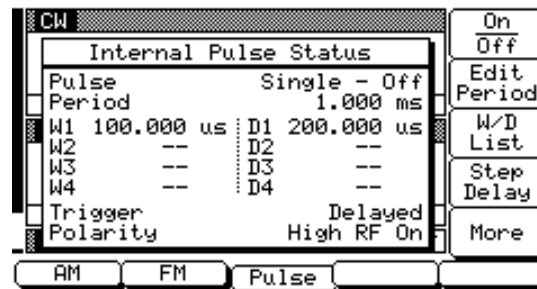

This menu contains the internal pulse status window that shows the current menu selections. This menu lets you perform the following:

- Turn pulse modulation on and off.
- Set the pulse period (or PRF).
- Set the pulse widths (W1-W4) and delays (D1-D4) in Single, Doublet, Triplet, and Quadruplet pulse modes.
- Set the parameters for the Step Delay mode.
- Go to an additional Internal Pulse Status menu (to select the pulse mode, trigger mode, and pulse configuration).

Press **On / Off** to turn pulse modulation on and off. The Internal Pulse status display will reflect your selection as On or Off.

Press **Edit Period** to open the Pulse Period parameter. (If you had selected PRF instead of Period at the Internal Pulse Configuration menu, the soft-key would read **Edit PRF** and pressing it would open the Pulse PRF parameter.) Edit the current value using the cursor control key or rotary data knob or enter a new value using the keypad and the appropriate terminator key. To close the Pulse Period parameter, press **Edit Period** or make another menu selection.

Press **W/D List** to display the list of current Pulse Width (W1-W4) and Delay (D1-D4) parameter settings. To change the current value of a parameter,

ERR
This error message is displayed when a pulse parameter setting is invalid for the current pulse modulation state. A listing of invalid parameter settings is provided in Table 6-2, beginning on page 6-8.

NOTE
At a 40 MHz pulse clock rate, the pulse period must be 125 ns longer than the pulse widths + delays; at a 10 MHz pulse clock rate, the pulse period must be 500 ns longer than the pulse widths + delays.

NOTE

Pulse Delay (D1) is only active when Delayed, Triggered w/delay, or Composite triggering mode is selected.

use the cursor control key to select the parameter, then press **Edit**. Edit the current value using the cursor control key or rotary data knob or enter a new value using the keypad and the appropriate terminator key. To close the open parameter, press **Edit** or **Previous Menu**.

When the Delayed or Triggered w/delay trigger mode is selected, the menu display adds the soft-key **Step Delay**. This soft-key lets you access menus for setting the step delay parameters and turning the Stepped Delay Mode on and off. The Stepped Delay Mode is described on page 3-83.

Press **More** to go to the additional Internal Pulse Status menu (below).

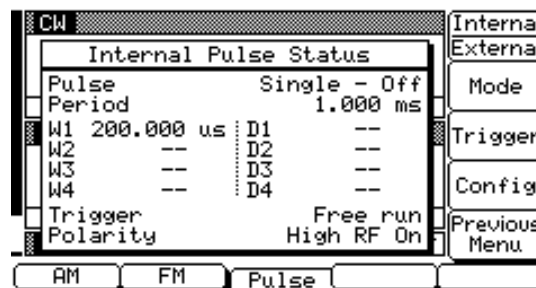

- This menu lets you perform the following:
- Select the modulating signal source.
 - Go to the Pulse Mode Selection menu.
 - Go to the Trigger Mode Selection menu.
 - Go to the Internal Pulse Configuration menu.

Press **Internal / External** to select the source of the modulating signal. Internal selects the modulating signal from the internal pulse generator; external selects the modulating signal from an external source. The Pulse status display will reflect your selection.

Press **Mode** to go to the Pulse Mode Selection menu (below).

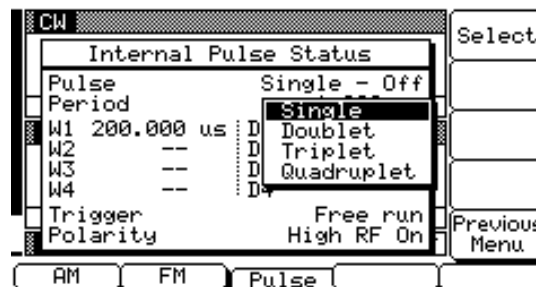

This menu displays the pulse modes (Single, Doublet, Triplet, and Quadruplet) that are available from the pulse generator. Use the cursor control key to highlight the desired pulse mode, then select it by pressing **Select**. The Internal Pulse Status display will reflect your selection.

Press **Previous Menu** to return to the previous Internal Pulse Status Menu display.

At the additional Internal Pulse Status menu, press **Trigger** to go to the Trigger Mode Selection menu (below).

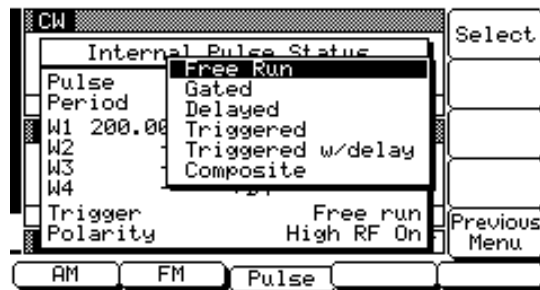

This menu lets you select the mode of triggering the internal pulse generator. (Each trigger mode is described and illustrated on page 3-81.)

Use the cursor control key to highlight the desired trigger mode, then press **Select** to select it. The Internal Pulse Status display will reflect your selection.

When you select the Gated, Triggered, or Triggered w/delay mode, the menu display adds the menu soft-keys **Trig. ↑** and **Trig. ↓**. Press these keys to select whether the pulse generator is triggered by the rising or falling edge of the external trigger pulse.

Press **Previous Menu** to return to the previous Internal Pulse Status Menu display.

Free Run—The pulse generator produces Single, Doublet, Triplet, or Quadruplet pulse modulation waveforms at the internal pulse repetition rate. Pulse delay (D1) is *not* available in this trigger mode.

Delayed—The pulse generator produces Single, Doublet, Triplet, or Quadruplet pulse modulation waveforms delayed by pulse delay (D1) at the internal pulse repetition rate.

Triggered—The pulse generator is triggered by an external trigger to produce Single, Doublet, Triplet, or Quadruplet pulse modulation waveforms. Pulse delay (D1) is *not* available in this trigger mode.

Triggered w/delay—The pulse generator is triggered by an external trigger to produce Single, Doublet, Triplet, or Quadruplet pulse modulation waveforms delayed by pulse delay (D1).

Gated— An external pulse gates the internal pulse generator on and off. When gated on, the pulse generator produces a Single pulse modulation waveform at the internal pulse repetition rate. Doublet, Triplet, and Quadruplet pulse modes are *not* available in this trigger mode.

NOTE

For proper operation, the period of the external pulse must be greater than the sum of the pulse repetition rate and pulse width of the internal pulse modulation waveform. To prevent relative timing jitter, the external gating pulse source can be synchronized with the internal pulse generator by using the 10 MHz REF OUT signal output (682XXB/683XXB rear panel) as a frequency reference for the external generator.

Composite—In this mode, an external pulse triggers the internal pulse generator and also pulse modulates the RF output signal. The internal pulse generator produces a Single pulse (W1) delayed by pulse delay (D1) which also pulse modulates the RF output signal. This effectively sums the external and internal pulses to pulse modulate the output signal. Doublet, Triplet, and Quadruplet pulse modes are *not* available in this trigger mode.

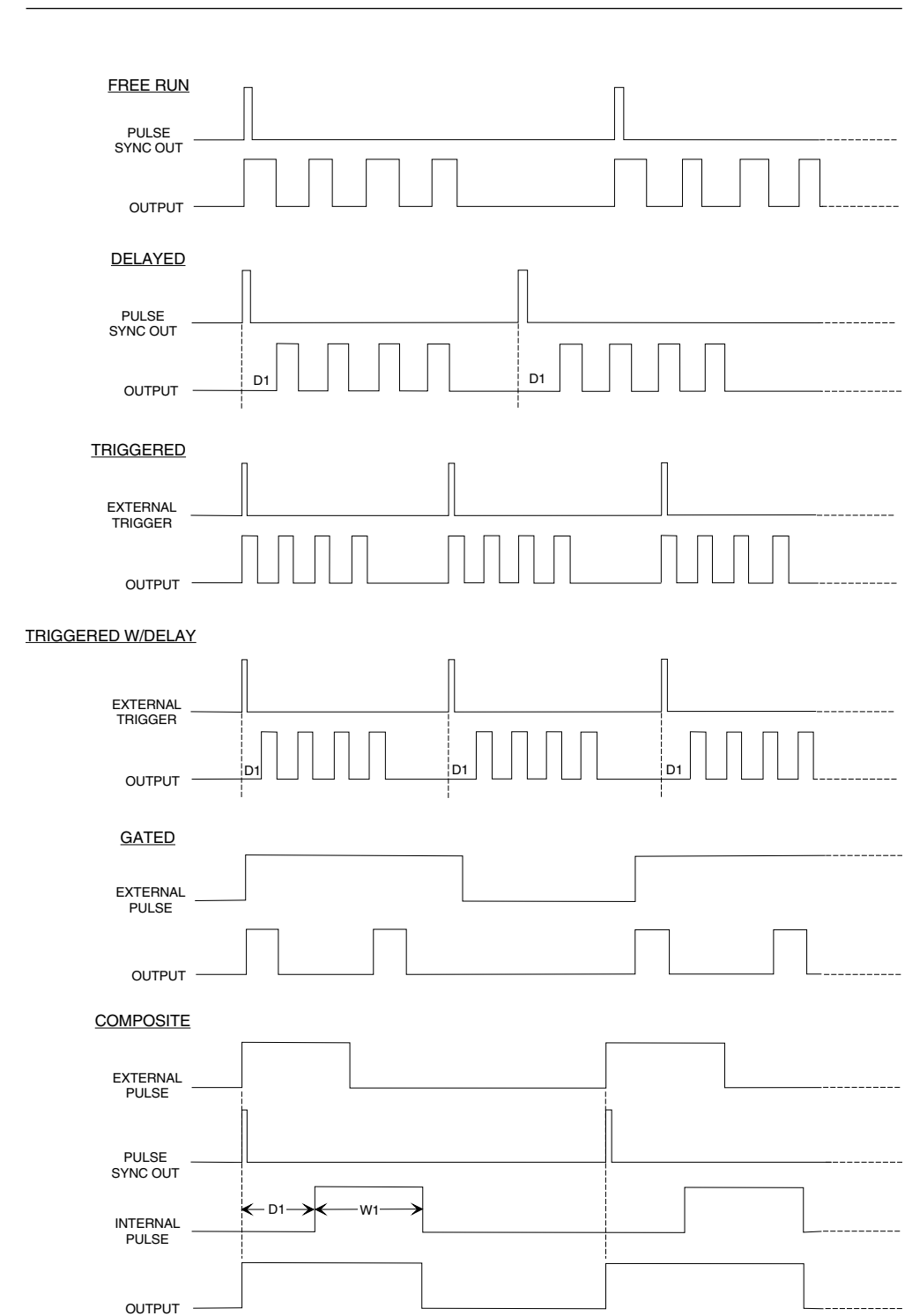
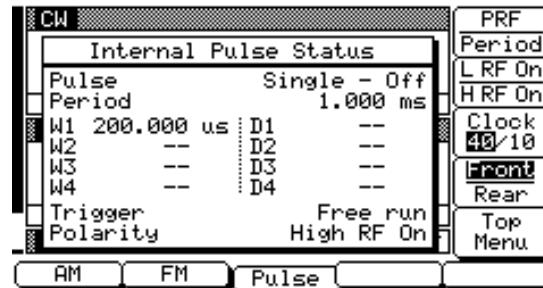

Figure 3-5. Pulse Modulation Triggering Modes

At the additional Internal Pulse Status menu, press **Config.** to go to the Internal Pulse Configuration menu (below).



This menu lets you perform the following:

- Select the display of PRF or Period on the Internal Pulse status display.
- Select the polarity of the signal (Low or High) that turns the RF on.
- Select the pulse generator's clock rate (40 MHz or 10 MHz).
- Select the input connector (front panel or rear panel PULSE TRIGGER IN) that is connected to the external trigger pulse source.

Press **PRF / Period** to select the display of Pulse PRF or Pulse Period on the Internal Pulse Status display.

Press **L RF On / H RF On** to select the polarity of the signal (Low or High) that turns the RF on. The Internal Pulse Status display will reflect your selection.

Press **Clock 40 / 10** to select the pulse generator's clock rate (40 MHz or 10 MHz). The soft-key label is highlighted (in reverse video) to reflect your selection.

Press **Front / Rear** to select the front or rear panel PULSE TRIGGER IN connector. The soft-key label is highlighted (in reverse video) to reflect your selection.

Press **Top Menu** to return to the main Internal Pulse Status Menu.

Stepped Delay Mode

The Stepped Delay Mode lets you automatically increment or decrement the Pulse Delay 1 (D1) value according to step delay parameters. The mode is *only* available when the Delayed or Triggered w/delay triggering mode is selected. Selecting either triggering mode adds the soft-key **Step Delay** to the Internal Pulse Status Menu.

At the Internal Pulse Status Menu (page 3-78), press **Step Delay** to access the Step Delay Mode menu (below).

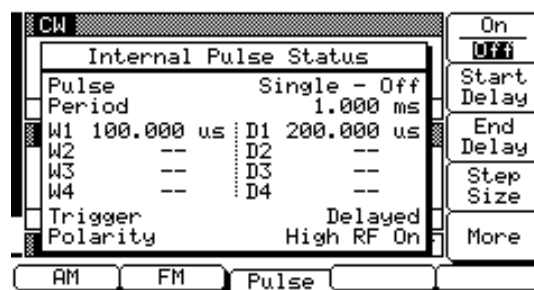

This menu lets you turn step delay on/off and edit the step delay parameters.

Press **On/Off** to turn the Stepped Delay Mode on and off.

Press **Start Delay** to open the Delay 1 (D1) start time parameter.

Press **End Delay** to open the Delay 1 (D1) end time parameter.

Press **Step Size** to open the step size time parameter.

Open the parameter you wish to change, then edit the current value using the cursor control key or the rotary data knob or enter a new value using the key pad and appropriate termination key. When you have finished setting the open parameter, close it by pressing its menu soft-key or make another menu selection.

Press **More** to go to the additional Step Delay Mode menu, shown on the following page.

NOTE
If the Step Delay parameters that are set result in a fractional number of increments, then the last (fractional) one is not taken.

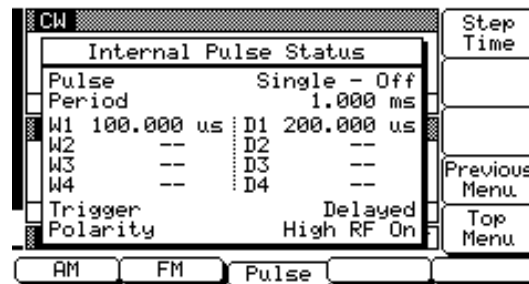

This menu lets you set the length of time a Delay 1 (D1) time is applied before it is incremented or decremented by the step size.

Press **Step Time** to open the dwell-time-per-step parameter, then edit the current value using the cursor control key or rotary data knob or enter a new value using the keypad and appropriate termination key. To close the open parameter, press **Step Time** or make another menu selection.

Press **Previous Menu** to return to the previous Step Delay Menu display.

Press **Top Menu** to return to the Internal Pulse Status Menu display.

Start Delay and End Delay times may be from lower to higher times or vice versa.

The Step Size time will be applied as an increment or a decrement as appropriate.

During pulse modulation when the step delay mode is on, both Start Delay and End Delay times are error checked as Delay 1 (D1) times, in the usual manner against other pulse parameters. Step Size time is checked against the Start Delay and End Delay times and must be no greater than the difference between Start Delay and End Delay.

External Pulse Source

To provide pulse modulation of the output signal using a modulating signal from an external source, first set up the external pulse generator and connect it to either the 682XXB/683XXB front or rear panel PULSE TRIGGER IN connector.

Next go to the additional Internal Pulse Status Menu (page 3-79) and press **Internal / External** to select the external source for the modulating signal. The External Pulse Status Menu (below) is then displayed.

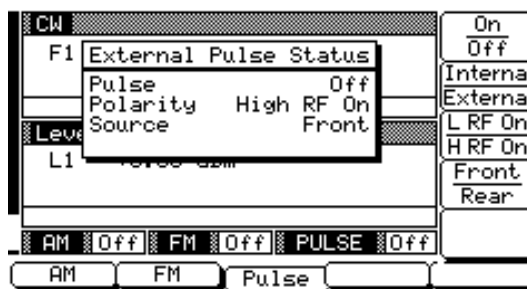

This menu contains the external pulse status window that shows the current menu selections. This menu lets you perform the following:

- Turn pulse modulation on and off.
- Select the modulating signal source.
- Select the polarity of the signal (Low or High) that turns the RF on.
- Select the input connector (front panel or rear panel PULSE TRIGGER IN) that is connected to the external pulse source.

Press **On / Off** to turn pulse modulation on and off. The External Pulse status display will reflect your selection as On or Off; the Pulse modulation status area will reflect your selection as Ext (On) or Off.

Press **Internal / External** to select the source of the modulating signal. The Pulse status display will reflect your selection.

Press **L RF On / H RF On** to select the polarity of the signal (Low or High) that turns the RF on. The External Pulse Status display will reflect your selection.

Press **Front / Rear** to select the front or rear panel PULSE TRIGGER IN connector. The External Pulse Status display will reflect your selection.

**3-13 SYSTEM
CONFIGURATION**

The system configuration function provides menus that let you set or select instrument configuration items; for example, display intensity, frequency scaling, polarity of blanking and video marker outputs, RF on or off during retrace or between steps, GPIB operating parameters, external interface language, and increment sizes for frequency, power level, and time parameters. Use the System Configuration menu map (Chapter 4, Figure 4-14) to follow the menu sequences.

To go to the System Configuration menu, first press **SYSTEM**. At the System Menu display, press **Config**. The System Configuration Menu (below) is displayed.

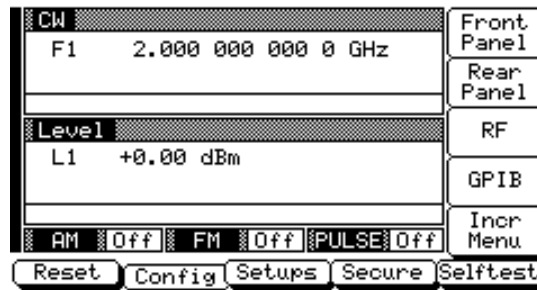

This menu lets you go to the Front Panel, Rear Panel, RF, GPIB, and Increment Configuration menus.

**Configuring
the Front
Panel**

Configuring the front panel of the signal generator involves adjusting the intensity level of the data display and setting the frequency scaling as required.

To go to the Configure Front Panel menu from the System Configuration menu, press **Front Panel**. The Configure Front Panel Menu (below) is displayed.

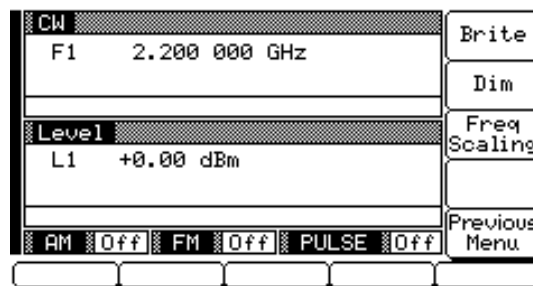

Display Intensity

Press **Brite** (repeatedly) to increase the intensity of the data display to the desired level.

Press **Dim** (repeatedly) to decrease the intensity of the data display.

Frequency Scaling

Frequency scaling lets you set a reference multiplier value and apply it to all frequency parameters. The reference multiplier can be any value between 0.1 and 14. Changing the multiplier value changes the entered and displayed frequencies, but it does not affect the output of the signal generator.

For example:

- Frequency scaling set to 4
- CW frequency set to 20 GHz
- 682XXB/683XXB output frequency is 5 GHz (20 GHz ÷ 4)

Press **Freq Scaling** to open the reference multiplier parameter. then edit the current value using the cursor control key or rotary data knob or enter a new value using the data entry key pad and any terminator key. To close the open multiplier parameter, press **Freq Scaling** or make another menu selection.

When done, press **Previous Menu** to return to the System Configuration menu.

NOTE
Resetting the 682XXB/683XXB sets the frequency scaling reference multiplier value to 1.

**Configuring
the Rear
Panel**

Configuring the rear panel of the signal generator consists of selecting the polarity of the retrace blanking, bandswitch blanking, retrace penlift, and video marker outputs.

To go to the Configure Rear Panel menu from the System Configuration menu, press **Rear Panel**. The Configure Rear Panel Menu (below) is displayed.

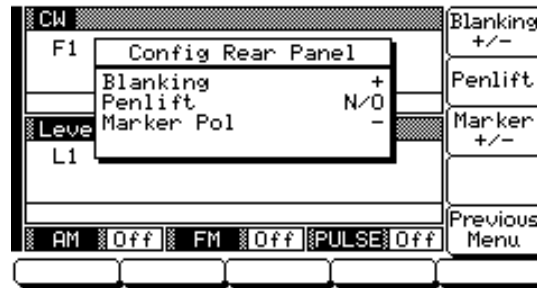

Press **Blanking +/-** to select a +5V or -5V level for the retrace and bandswitch blanking outputs. The retrace blanking and bandswitch blanking signal outputs are both available at the rear panel AUX I/O connector. The display will reflect your selection.

Press **Penlift** to select normally-open (N/O) or normally-closed (N/C) contacts on the internal penlift relay. The penlift relay output, optionally available at the rear panel, is used to lift a plotter pen during retrace. The display will reflect your selection.

Press **Marker +/-** to select a +5V or -5V level for the video marker output when video markers are selected ON. The video marker signal output is available at the rear panel AUX I/O connector. The display will reflect your selection.

When done, press **Previous Menu** to return to the System Configuration menu.

**Configuring
the RF**

Configuring the RF of the 682XXB/683XXB involves the following:

- ❑ Selecting whether the RF should be on or off during retrace.
- ❑ Selecting whether the RF should be on or off during frequency switching in CW and step sweep modes.
- ❑ Selecting whether a sweep triggered by a single or external trigger should rest at the top or bottom of the sweep ramp.
- ❑ Selecting whether the RF should be on or off at reset.
- ❑ Selecting 40 dB or 0 dB of attenuation when RF is switched off in units with a step attenuator (Option 2) installed.

To go to the Configure RF menu (below) from the System Configuration menu, press **RF**.

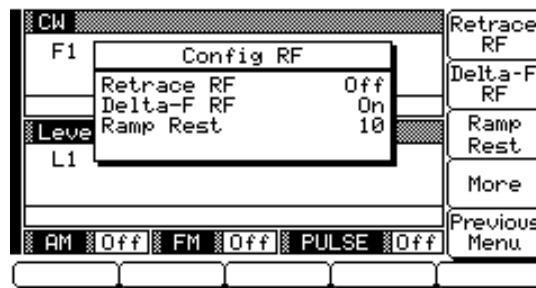

Press **Retrace RF** to select RF On or Off during retrace. The display will reflect your selection.

Press **Delta-F RF** to select RF On or Off during frequency switching in CW or step sweep modes. The display will reflect your selection.

Press **Ramp Rest** to select 0 or 10 for the ramp rest point for sweeps triggered a single or external trigger. 0 indicates that the sweep will rest at the bottom of the sweep ramp; 10 indicates that the sweep will rest at the top of the sweep ramp. The display will reflect your selection.

Press **More** to go to the Additional Configure RF menu for more selections.

Press **Previous Menu** to return to the System Configuration Menu display.

Additional Configure RF Menu

When you press **More**, the Additional Configure RF Menu (below) is displayed.

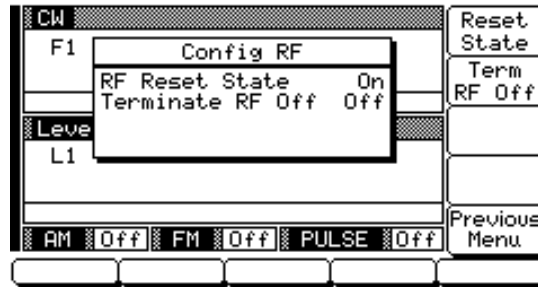

This menu lets you perform the following:

- Select whether the RF should be on or off at reset.
- Select 40 dB or 0 dB of attenuation when RF is switched off in units with a step attenuator (Option 2) installed.

NOTE

The Term RF Off selection is **only** available in those 682XXB models having Option 2 and Firmware Version 2.44 and above; 682X5B models having Option 2 and Firmware Version 1.33 and above; 683XXB models having Option 2 and Firmware Version 2.55 and above; and 683X5B models having Option 2 and Firmware Version 1.37 and above.

Press **Reset State** to select RF On or Off at reset. The display will reflect your selection.

Press **Term RF Off** to select 40 dB (minimum) of attenuation when RF is switched off in units with a step attenuator (Option 2) installed. This provides a better output source match. The display will reflect On to indicate the 40 dB of attenuation is applied. Press **Term RF Off** again to select 0 dB of attenuation when RF is switched off. This display will reflect Off to indicate 0 dB of attenuation is applied.

Press **Previous Menu** to return to the main Configuration RF Menu display.

**Configuring
the GPIB**

The GPIB configuration menus let you select the following:

- ❑ The GPIB address and the GPIB line terminator for the signal generator.
- ❑ The source lock mode for operation with a Anritsu Model 360B Vector Network Analyzer.
- ❑ The model and GPIB address for the power meter that is used to create a user level flatness correction power-offset table.
- ❑ The external interface language for remote operation of units with Option 19.
- ❑ Scalar mode for operation with a Giga-tronics Model 8003 Scalar Network Analyzer or a Hewlett Packard Model 8757D Scalar Network Analyzer.

NOTE

The HP8757D Scalar selection is **only** available in those 682XXB models having Firmware Version 2.42 and above; 682X5B models having Firmware Version 1.31 and above; 683XXB models having Firmware Version 2.53 and above; and 683X5B models having Firmware Version 1.35 and above.

To go to the Configure GPIB menu from the System Configuration menu, press **GPIB**. The Configure GPIB Menu (below) is displayed.

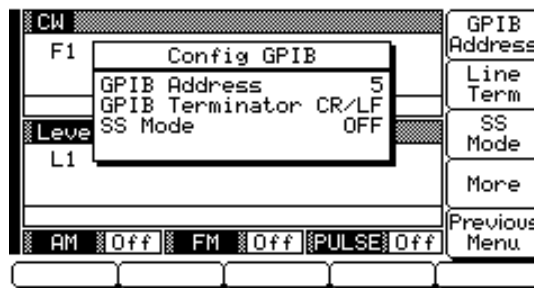

Press **GPIB Address** to change the address of the 682XXB/683XXB on the bus (the default GPIB address is 5). Enter a new address, between 1 and 30, using the cursor control key or the data entry keypad and the terminator key

Hz
ns
ADRS

The new GPIB address will appear on the display.

Press **Line Term** to select a carriage return (CR) or a carriage return and line feed (CR/LF) as the GPIB data delimiter. Consult the GPIB controller's manual to determine which data delimiter is required.

SS MODE

When SS Mode is selected on, this message is displayed (in the frequency mode title bar) on all menu displays to remind the operator that the 682XXB/683XXB is in a source lock mode.

Press **SS Mode** to turn on the source lock mode for operation with a Anritsu Model 360B Vector Network Analyzer. (Refer to paragraph 7-4 for information pertaining to operating the 682XXB/683XXB with a 360B VNA.) Press **SS Mode** again to turn off the source lock mode.

Press **More** to go to the First Additional Configure GPIB menu for more selections.

Press **Previous Menu** to return to the System Configuration menu.

First Additional Configure GPIB Menu

When you press **More**, the First Additional Configure GPIB menu (below) is displayed.

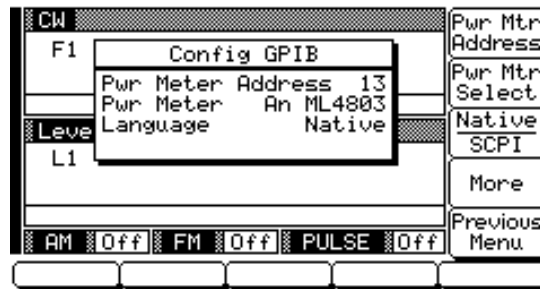

This menu lets you select the following:

- ❑ The model and GPIB address for the power meter that is used to create a user level flatness correction power-offset table. (Refer to page 3-57 for a description of this function.)
- ❑ The external interface language for remote operation of 682XXB/683XXBs with Option 19 installed. (Refer to page 2-9 for more information.)

Press **Pwr Mtr Address** to change the address of the power meter on the GPIB (the default GPIB address is 13). Enter a new address, between 1 and 30, using the cursor control key or the data entry keypad and the terminator key

Hz
ns
ADRS

The new GPIB address will appear on the display.

Press **Pwr Mtr Select** to select the power meter model being used. (Supported power meters are the Anritsu ML4803A and Hewlett-Packard 437B, 438A, and 70100A.)

Press **Native SCPI** to select the external interface language to be used for remote operation of the 682XXB/683XXB. (Language selection is only available on instruments that have Option 19 installed.)

Press **More** to go to the Second Additional Configuration GPIB Menu display.

Press **Previous Menu** to return to the main Configure GPIB menu display.

Second Additional Configure GPIB Menu

When you press **More** the Second Additional Configure GPIB Menu (below) is displayed.

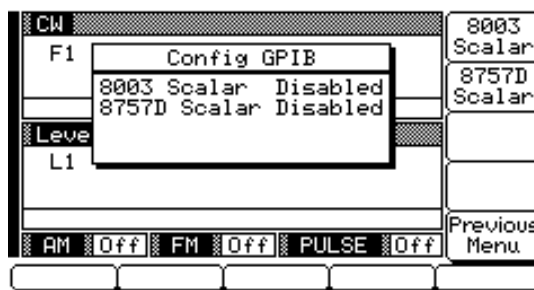

This menu lets you select the following:

- Scalar mode of operation with a Giga-tronics Model 8003 Scalar Network Analyzer.
- Scalar mode of operation with a Hewlett Packard Model 8757D Scalar Network Analyzer.

Press **8003 Scalar** to enable operations with a Giga-tronics Model 8003 Scalar Network Analyzer. (Refer to paragraph 7-5 for procedures.) Press **8003 Scalar** again to disable the operation.

Press **8757D Scalar** to enable operations with a Hewlett Packard Model 8757D Scalar Network Analyzer. (Refer to paragraph 7-6 for procedures.) Press **8757D Scalar** again to disable the operation.

Press **Previous Menu** to return to the First Additional Configure GPIB Menu display.

**Setting
Increment
Sizes**

The Increment menu lets you set the incremental size for editing frequency, power level, and time parameters. When the increment mode is selected on, these parameter values will increase or decrease by the set amount each time the \wedge or \vee pad is pressed or the rotary data knob is turned clockwise or counter-clockwise. The menu also lets you turn the increment mode on and off.

To go to the Increment menu from the System Configuration menu, press **Incr Menu**. The Increment Menu (below) is displayed.

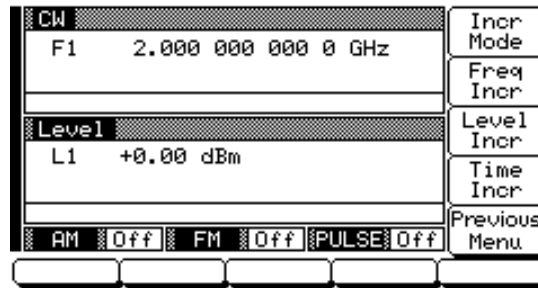

Press **Freq Incr** to open the frequency increment parameter.

Press **Level Incr** to open the power level increment parameter.

Press **Time Incr** to open the time increment parameter.

Open the parameter you wish to change, then edit the current value using the cursor control key or rotary data knob or enter a new value using the key pad and appropriate termination key. When you have finished setting the open parameter, close it by pressing its menu soft-key or by making another menu selection.

Press **Incr Mode** to turn the increment mode on. Press again to turn it off.

When done, press **Previous Menu** to return to the System Configuration menu.

**3-14 SAVING/RECALLING
INSTRUMENT SETUPS**

The 682XXB/683XXB offers the capability to store up to ten complete front panel setups. The setups are numbered 0 through 9. The following paragraphs describe how to save and recall front panel setups.

***Saving
Setups***

Once you have decided that an instrument setup should be retained for future use, follow the procedure below to save it.

First, press **SYSTEM** to display the System Menu.

Now, press **Setups**. The Setups Menu (below) is displayed.

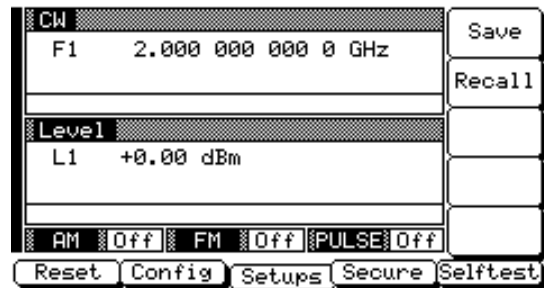

Press **Save**, then enter the desired setup number (between 0 and 9) on the keypad. The setup is now saved.

NOTE

Setup #0 automatically saves the current front panel settings when the instrument is shutdown using the front panel LINE key. Therefore, it is recommended that you use only setups #1 through #9 to save front panel setups.

When instrument shutdown occurs because of main power interruptions, the current front panel settings are not saved.

***Recalling
Setups***

To recall a previously saved setup, first access the Setups Menu as described above.

At the Setups Menu, press **Recall**, then enter the setup number on the keypad.

The instrument resets itself to the recalled configuration.

***Erasing
Stored Setups***

The front panel setups are stored in non-volatile memory. A master reset is required to erase the contents of the setups and reprogram them with default data.

To perform a master reset, proceed as follows:

- Step 1** With the 682XXB/683XXB in standby, press and hold the RF OUTPUT ON/OFF key.
- Step 2** Press the LINE OPERATE/STANDBY key to turn the instrument on.
- Step 3** When the first menu is displayed (after the start-up display), release the RF OUTPUT ON/OFF key.

The contents of non-volatile memory have now been erased and reprogrammed with default data.

NOTE

The master reset function overwrites all information stored in the non-volatile memory with default values. This includes the five power-offset tables used for the user level flatness correction function.

3-15 SECURE OPERATION

The 682XXB/683XXB can be operated in a secure mode of operation. In this secure mode, the display of all frequency, power level, and modulation parameters is disabled during both local (front panel) and remote (GPIB) operations. The instrument will continue to function normally in all other respects. The following paragraphs describe how to place the signal generator in secure mode and how to return to normal operation.

To place the 682XXB/683XXB in the secure mode, first press **SYSTEM** to display the System Menu.

Next, press **Secure**. This places the signal generator in the secure mode and the Secure Menu (below) is displayed.

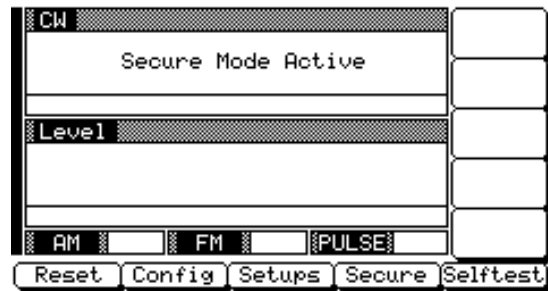

NOTE

During secure mode, all main menu keys and menu soft-keys operate normally. The menu soft-key labels are displayed and change with menu selections. Only the parameter display is disabled.

To return the 682XXB/683XXB to unsecured (normal) operation, press **SYSTEM**, then press **Reset**.

3-16 **SCAN MODULATION
(OPTION 20)**

The internal scan modulator, added by Option 20, lets you amplitude modulate output signals from 1 to 20 GHz at modulation depths up to 60 dB. Scan modulation is accomplished using a modulating signal from an external source and is in addition to the normal amplitude modulation described in paragraph 3-12.

To provide amplitude modulation of the output signal using the internal scan modulator, first set up the external modulating signal generator and connect it to the 682XXB/683XXB rear panel SCAN MOD IN connector.

Next, press **MODULATION**, then **Scan** to go to the Scan Status Menu (below).

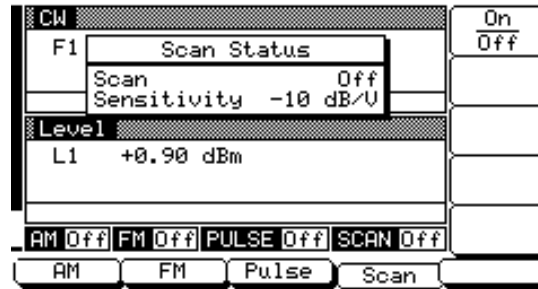

Press **On/Off** to turn scan modulation on and off. The Scan status display and the Scan modulation status area will reflect your selection as On or Off.

Control the scan modulation depth by varying the level of the external modulating signal. (Since the scan modulator has a fixed sensitivity of -10 dB/V, an external modulating signal level of 6 volts produces the maximum modulation depth of -60 dB.)

**3-17 INTERNAL POWER
METER (OPTION 8)**

The internal power meter function, added by Option 8, lets you measure the power from a test device and display its value in the lower right corner of the level parameters area of the front panel LCD. The internal power meter has a range of +16 dBm to -35 dBm and is compatible with ANRITSU 560-7, 5400-71, and 6400-71 series detectors.

To make a measurement of the power from a test device using the internal power meter function, first connect the detector to the test device and to the rear panel POWER METER connector.

Next, press the **SYSTEM** main menu key. At the System Menu display (below), press **Meas. Power** to enable the power measurement function.

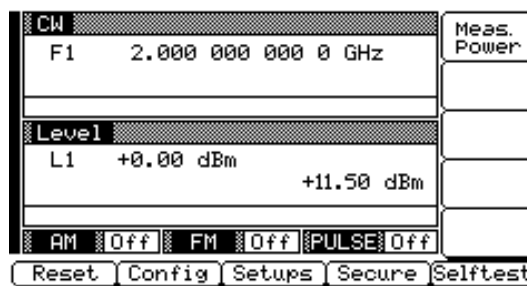

NOTE

During operation, the word Pwr Under-range is displayed to indicate an under-range condition; the word Pwr Overrange is displayed to indicate an overrange condition.

To disable the power measurement function, press **Meas. Power** again.

**3-18 REFERENCE
OSCILLATOR
CALIBRATION**

The reference oscillator calibration function lets you calibrate the internal 100 MHz crystal reference oscillator of the 682XXB/683XXB using an external 10 MHz, 0 to +10 dBm reference signal.

NOTES

1. The calibration function is *only* available in those 682XXB models having Firmware Version 2.44 and above; 682X5B models having Firmware Version 1.33 and above; 683XXB models having Firmware Version 2.55 and above; and 683X5B models having Firmware Version 1.37 and above.
2. This calibration is not applicable to units having Option 16, High Stability Time Base, installed.

NOTE

Before beginning calibration, always let the 682XXB/683XXB warm up for a minimum of 120 hours.

To perform calibration of the internal reference oscillator, first connect the external 10 MHz reference signal to the 682XXB/683XXB rear panel 10 MHz REF IN connector.

Next, press the **SYSTEM** main menu key. At the System Menu display, press **Cal Menu** to go to the Calibration Menu (below).

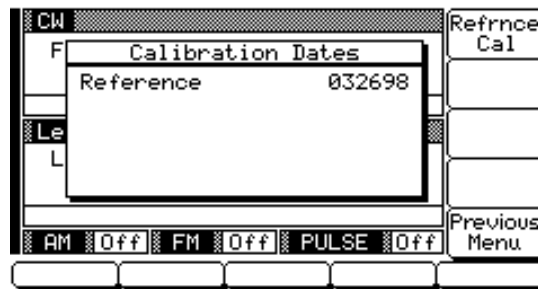

Press **Refrnce Cal** to begin calibration.

Press **Previous Menu** to return to the System Menu display.

When **Refrnce Cal** is pressed, the Calibration Status Menu (below) is displayed.

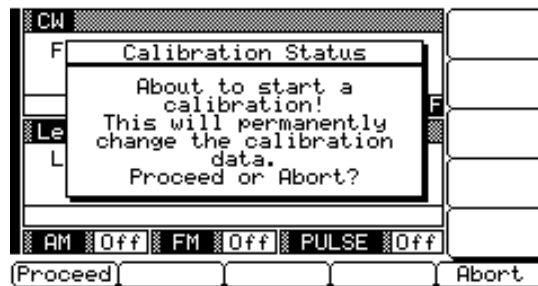

Press **Proceed** to start the calibration.

Press **Abort** to cancel the calibration and return to the Calibration Menu display.

When **Proceed** is pressed, the date parameter opens for data entry.

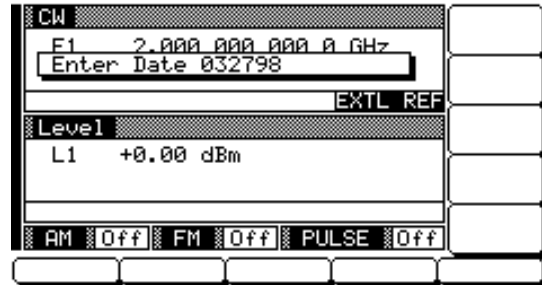

Using the key pad, enter the current date (in any desired format). Then, press any terminator key. The Calibration Status Menu display changes to indicate calibration is in progress.

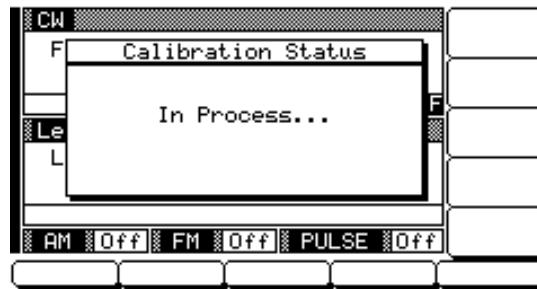

When the reference oscillator calibration is complete, the Calibration Menu is displayed.

External Reference Not Connected

If calibration is attempted without an external 10 MHz reference signal connected to the rear panel 10 MHz REF IN connector, the Calibration Status Menu displays the following.

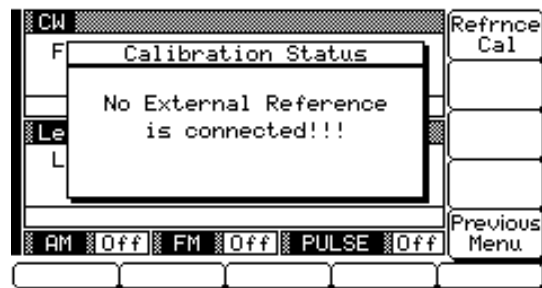

Chapter 4

Local Operation–Menu Maps

Table of Contents

4-1	INTRODUCTION	4-3
4-2	MENU MAP DESCRIPTION	4-3

Chapter 4

Local Operation–Menu Maps

4-1 INTRODUCTION

This chapter provides menu maps that support the 682XXB/683XXB front panel operating instructions found in Chapter 3. It includes menu maps for all of the frequency, power level, and modulation modes of operation. In addition, a menu map for system configuration is also provided.

4-2 MENU MAP DESCRIPTION

A menu map shows the menu key selections and instrument menu displays for a particular mode of signal generator operation. The menu displays are shown as they appear on the instrument and are linked together to show the sequence of menu selection. A brief description of the function of each menu's soft-keys is provided. If a menu soft-key selects another menu, then it is shown linked to that menu. Figure 4-1, on page 4-5, is a sample menu map annotated to identify the key elements.

The following is a list of the menu maps contained in this chapter.

Figure	Title	Page
4-1	Sample Menu Map	4-5
4-2	CW Frequency Mode Menu Map	4-6
4-3	Analog Sweep Frequency Mode Menu Map	4-7
4-4	Step Sweep Frequency Mode Menu Map.	4-8
4-5	Manual Sweep Frequency Mode Menu Map.	4-9
4-6	Fixed Power Level Mode Menu Map	4-10
4-7	CW Power Sweep Mode Menu Map	4-11
4-8	Sweep Frequency/Step Power Mode Menu Map	4-12
4-9	Leveling Modes Menu Map	4-13
4-10	Amplitude Modulation Mode Menu Map	4-14
4-11	Frequency Modulation Mode Menu Map	4-15
4-12	Phase Modulation Mode Menu Map	4-16
4-13	Pulse Modulation Mode Menu Map.	4-17
4-14	System Configuration Menu Map.	4-18

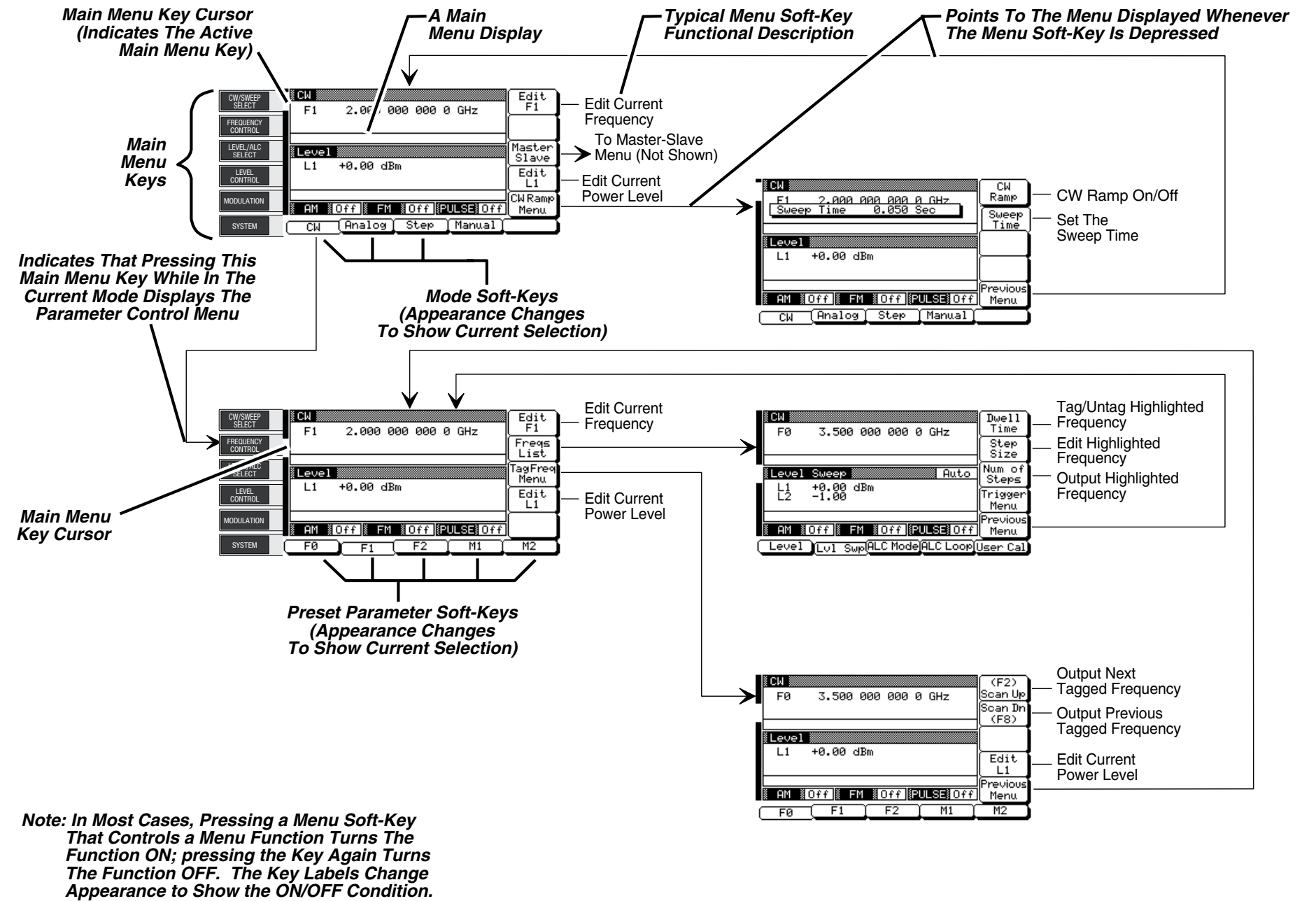
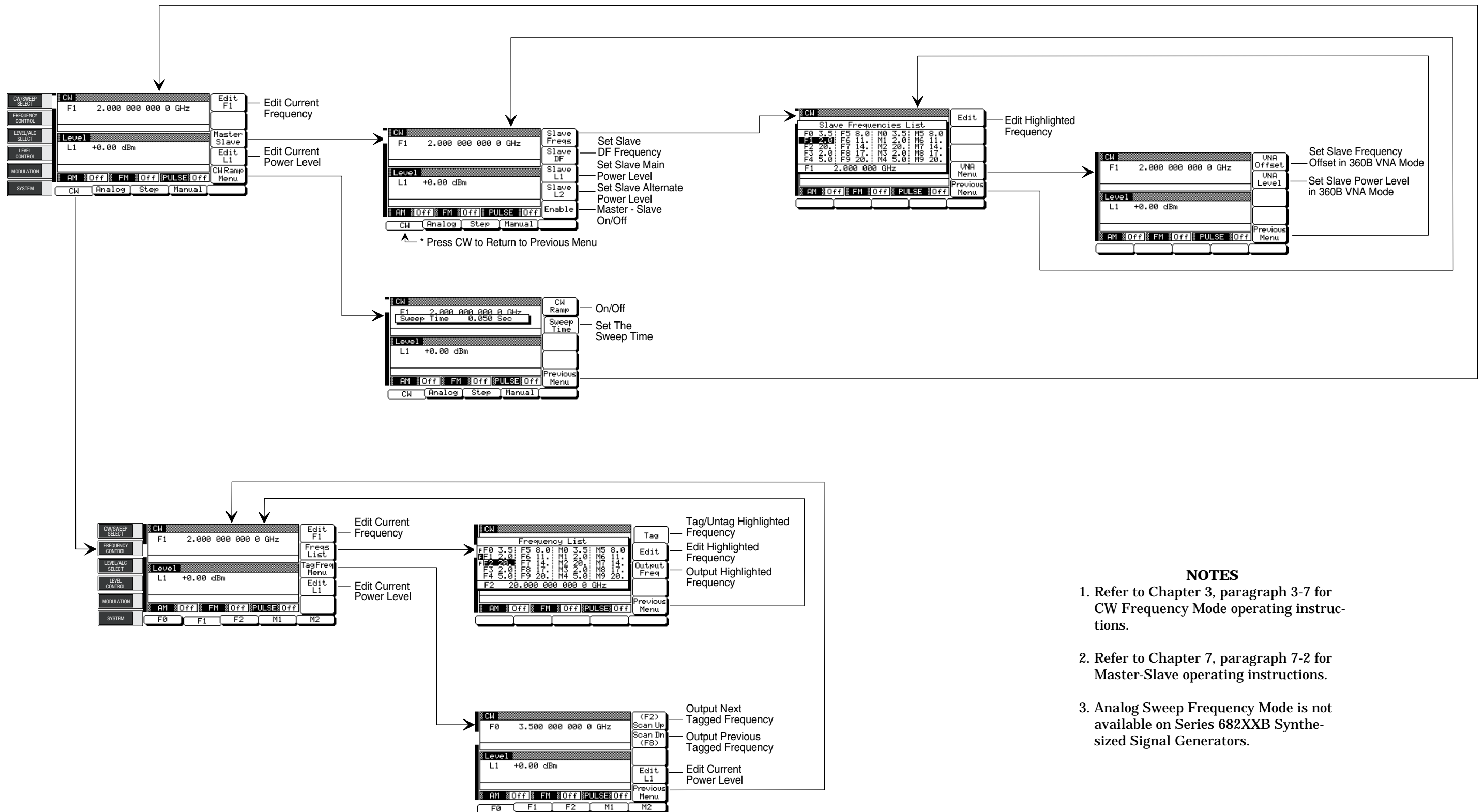
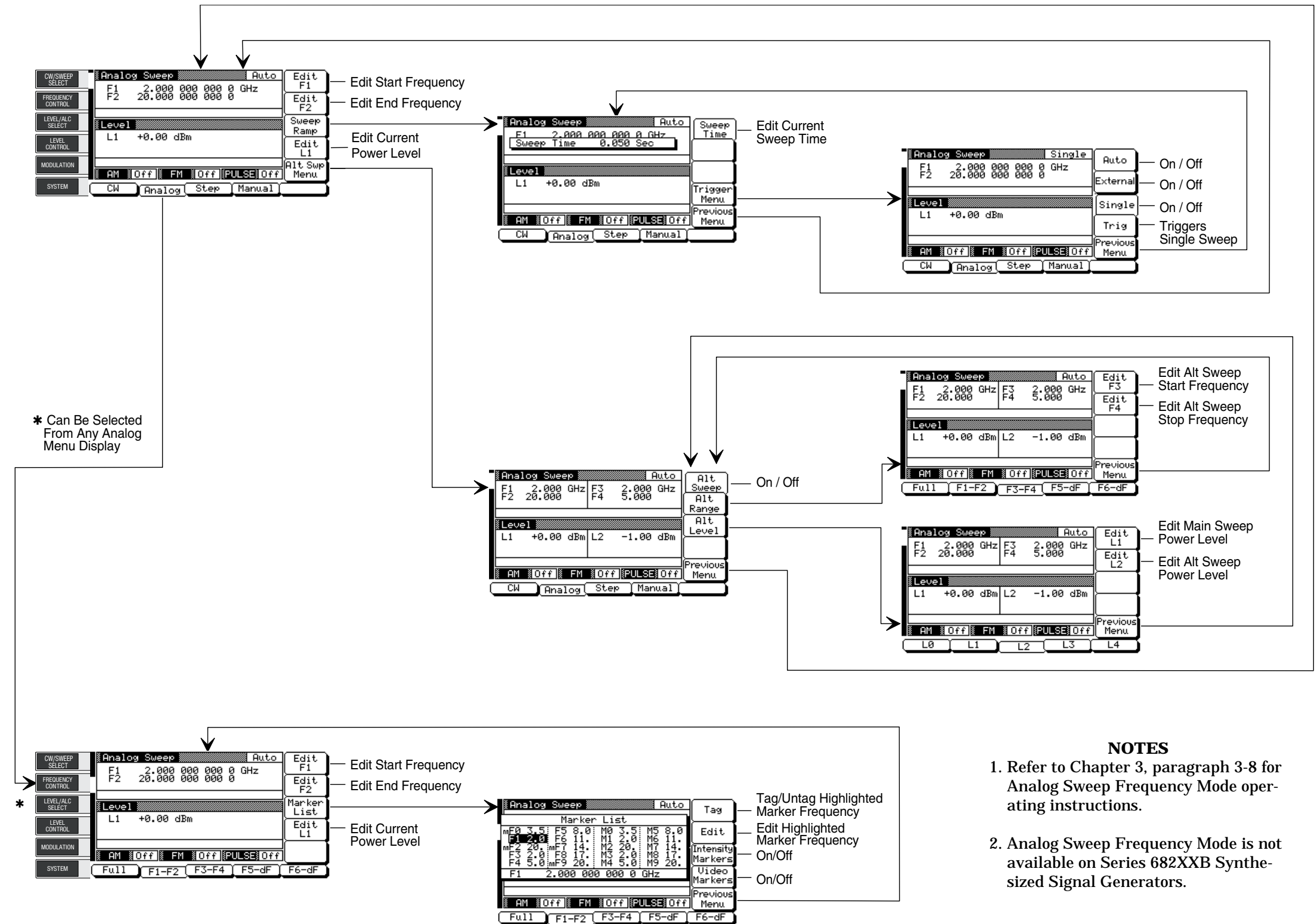

Figure 4-1. Sample Menu Map (Annotated)



- NOTES**
1. Refer to Chapter 3, paragraph 3-7 for CW Frequency Mode operating instructions.
 2. Refer to Chapter 7, paragraph 7-2 for Master-Slave operating instructions.
 3. Analog Sweep Frequency Mode is not available on Series 682XXB Synthesized Signal Generators.

Figure 4-2. CW Frequency Mode Menu Map



- NOTES**
1. Refer to Chapter 3, paragraph 3-8 for Analog Sweep Frequency Mode operating instructions.
 2. Analog Sweep Frequency Mode is not available on Series 682XXB Synthesized Signal Generators.

Figure 4-3. Analog Sweep Frequency Mode Menu Map

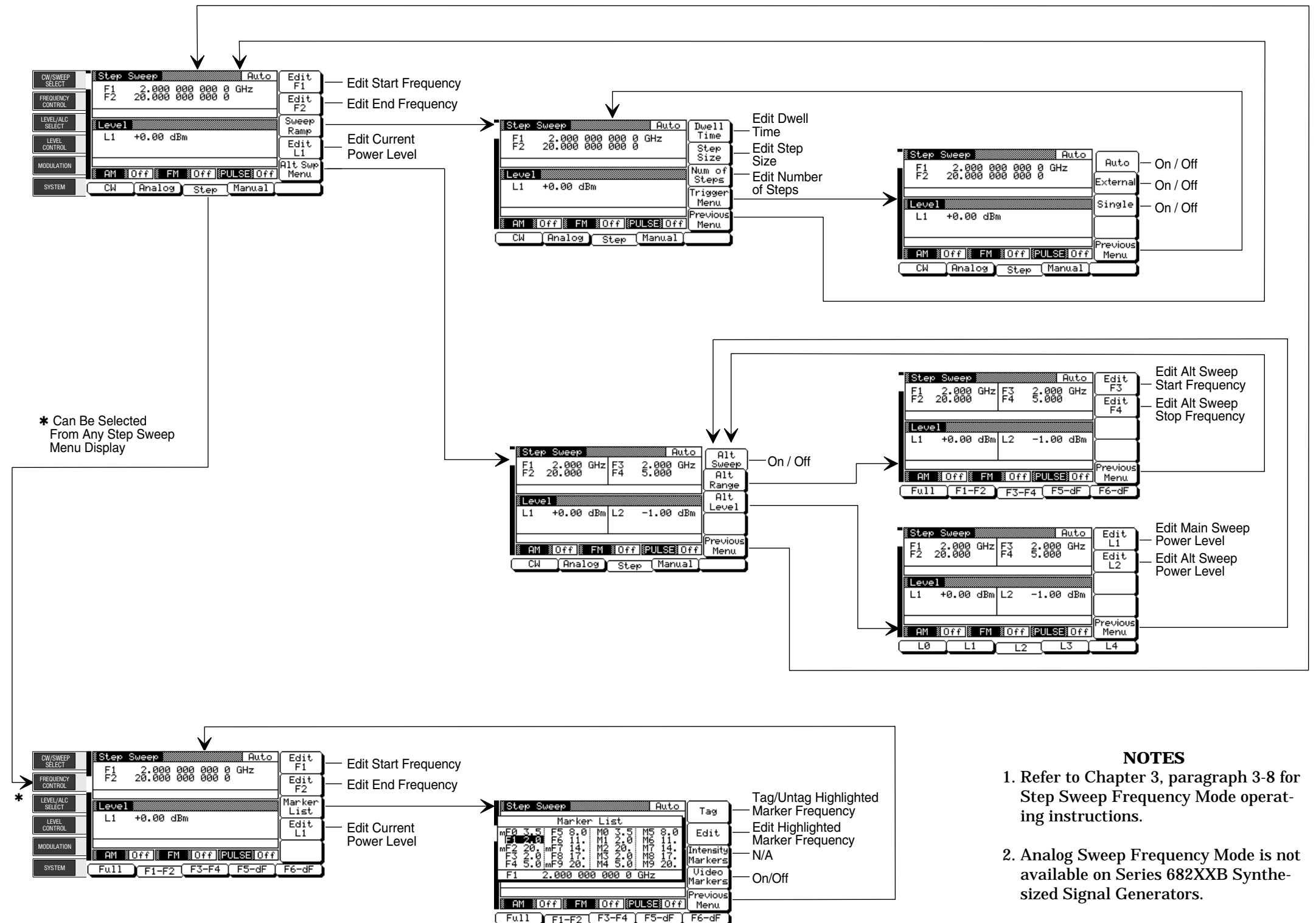
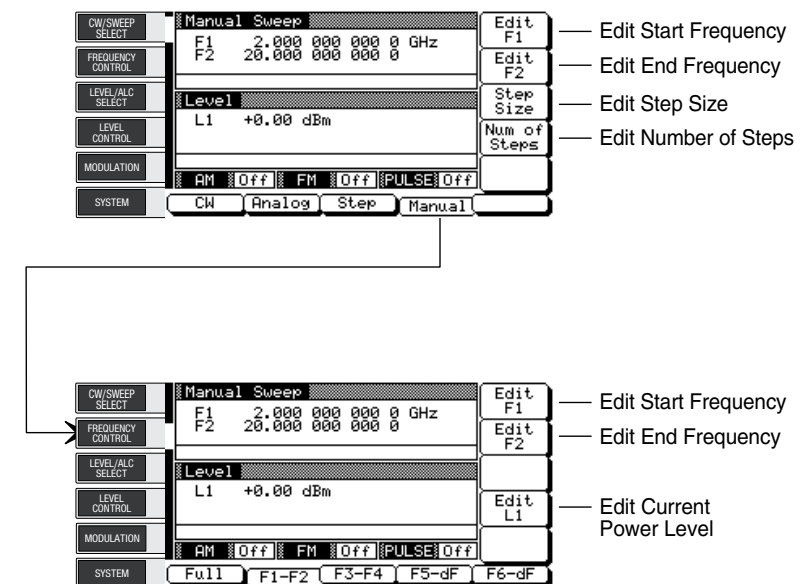

Figure 4-4. Step Sweep Frequency Mode Menu Map



NOTES

1. Refer to Chapter 3, paragraph 3-8 for Manual Sweep Frequency Mode operating instructions.
2. Analog Sweep Frequency Mode is not available on Series 682XXB Synthesized Signal Generators.

Figure 4-5. Manual Sweep Frequency Mode Menu Map

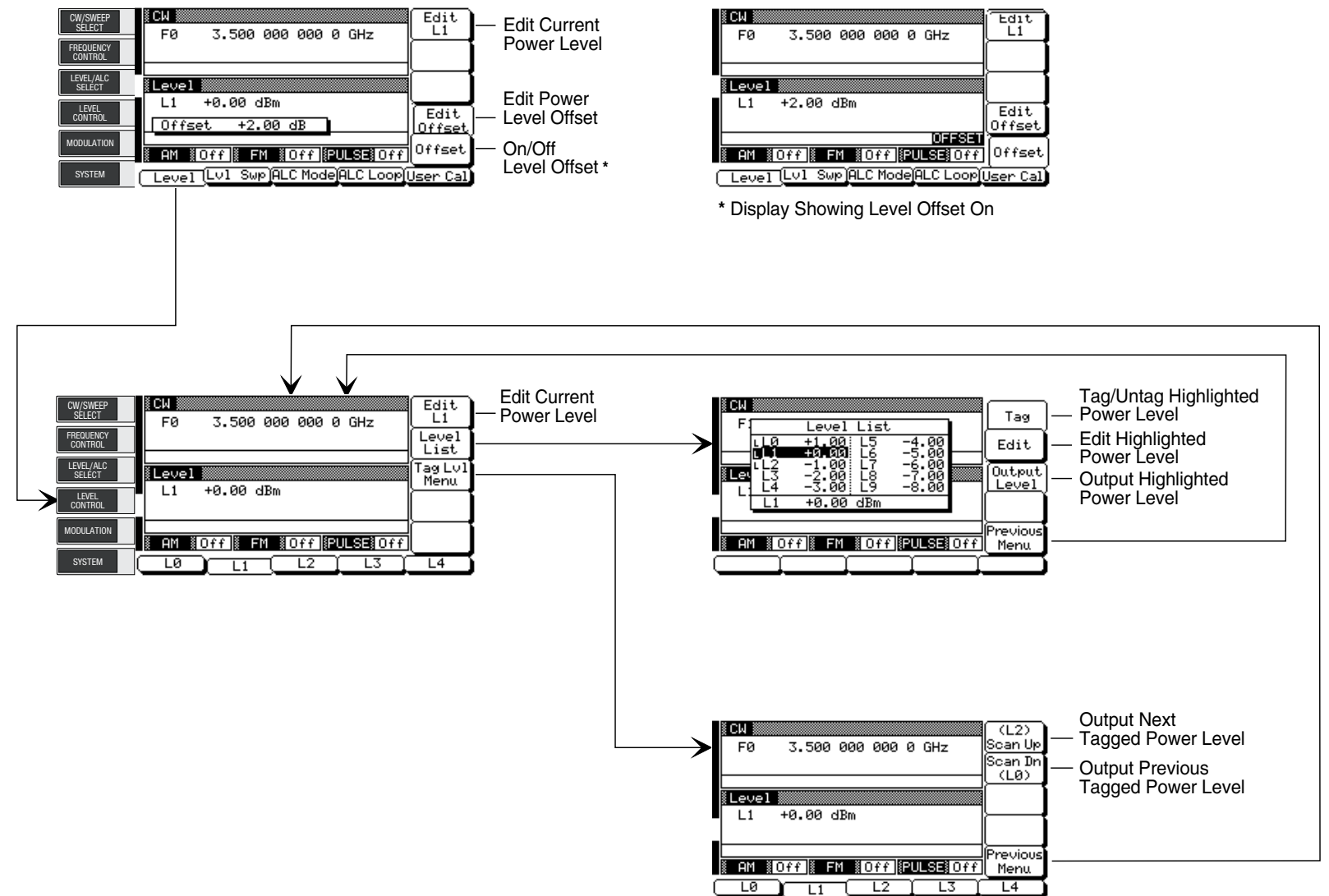

NOTE
Refer to Chapter 3, paragraph 3-9 for Fixed Power Level Mode operating instructions.

Figure 4-6. Fixed Power Level Mode Menu Map

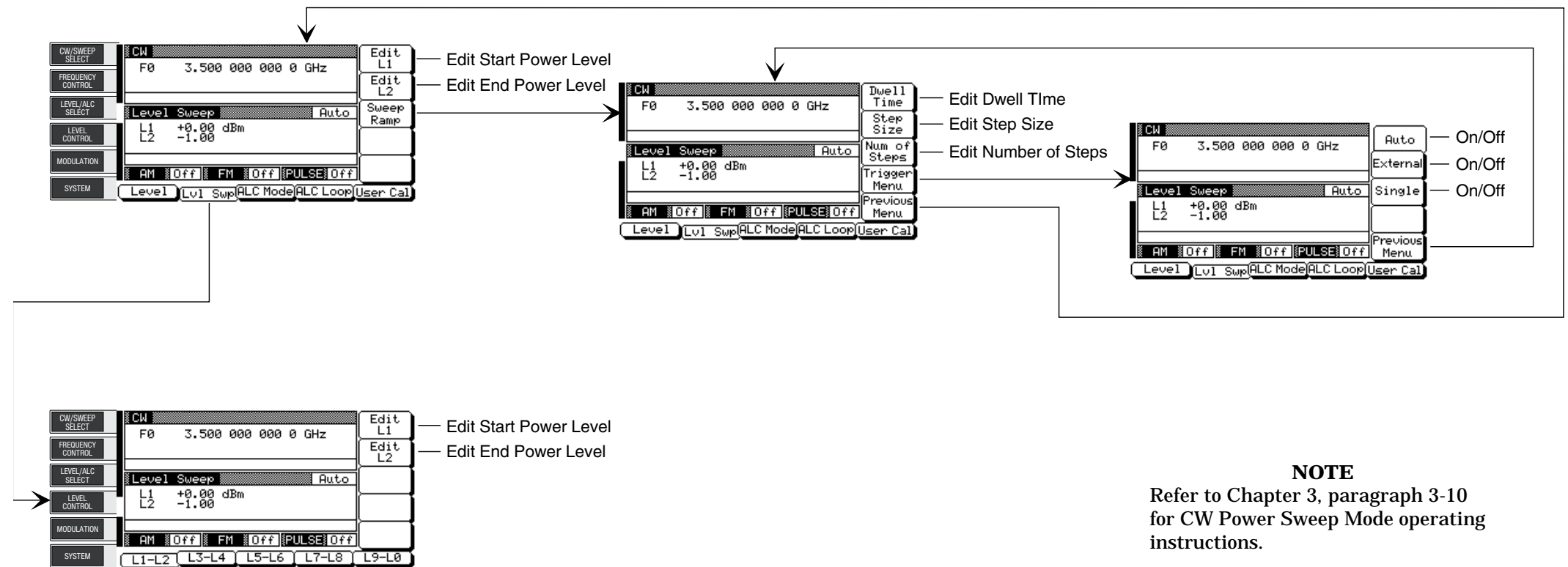

NOTE
Refer to Chapter 3, paragraph 3-10
for CW Power Sweep Mode operating
instructions.

Figure 4-7. CW Power Sweep Mode Menu Map

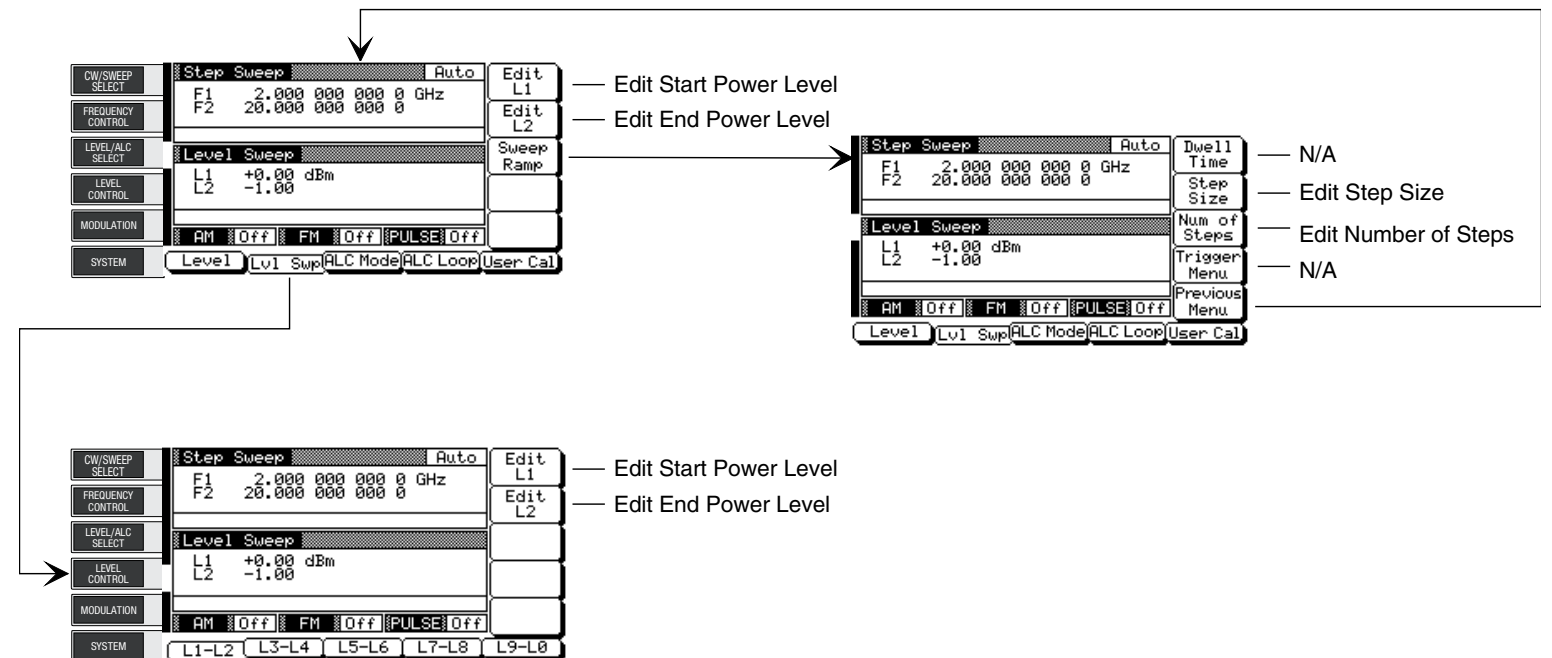

NOTE

Refer to Chapter 3, paragraph 3-10 for Sweep Frequency/Step Power Mode operating instructions.

Figure 4-8. Sweep Frequency/Step Power Mode Menu Map

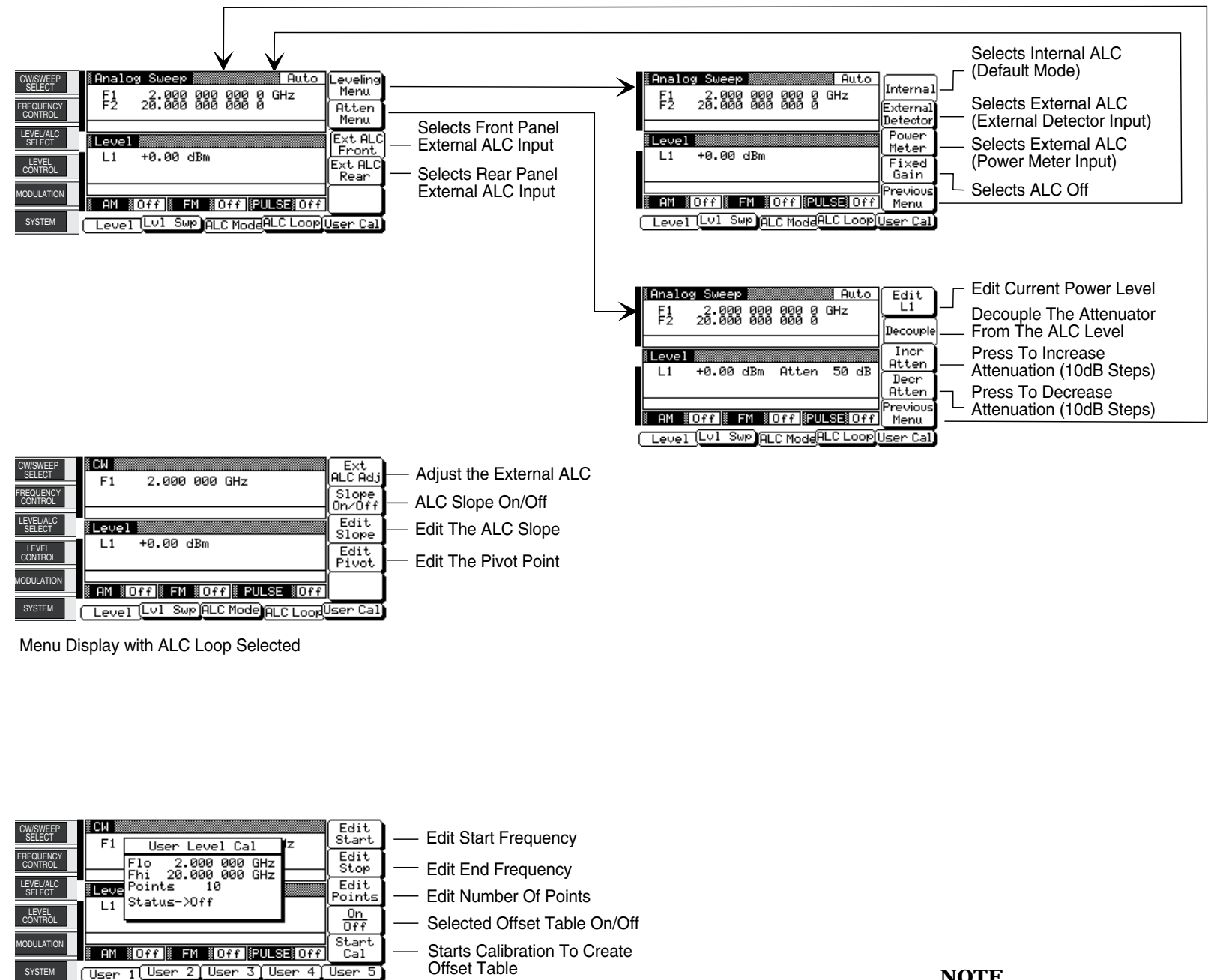

Menu Display with ALC Loop Selected

* Menu Display with User Cal Selected

NOTE
Refer to Chapter 3, paragraph 3-11 for Leveling Modes operating instructions.

Figure 4-9. Leveling Modes Menu Map

INTERNAL AM SOURCE SELECTED

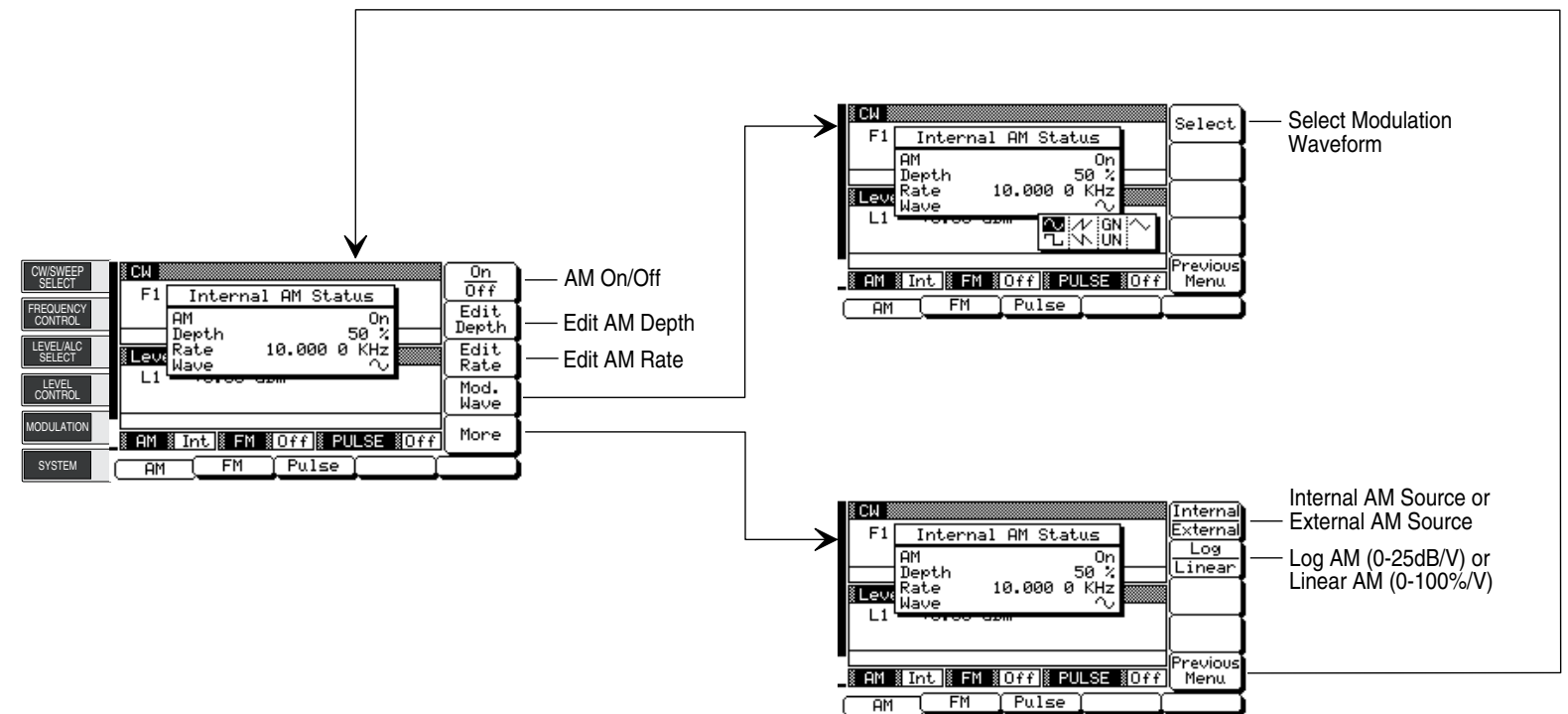

EXTERNAL AM SOURCE SELECTED

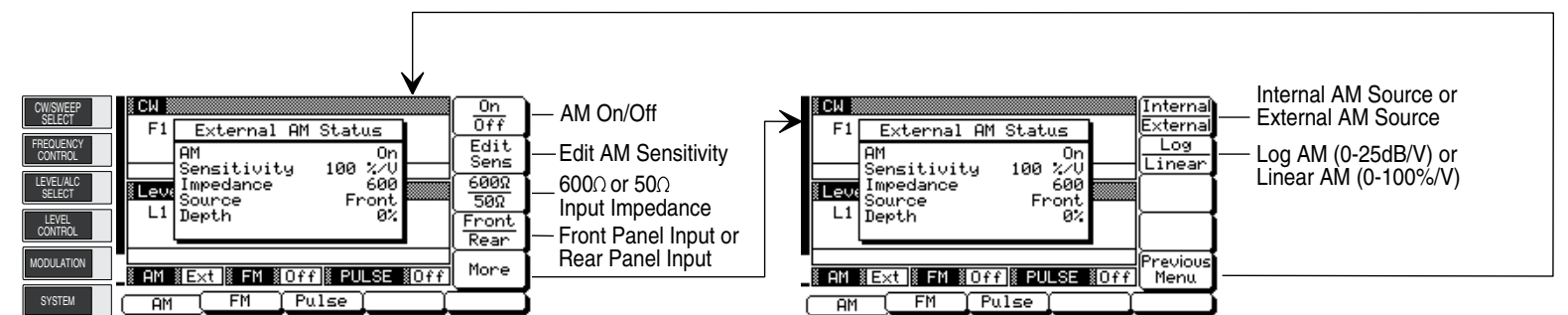

NOTE
Refer to Chapter 3, paragraph 3-12 for AM Mode operating instructions.

Figure 4-10. Amplitude Modulation Mode Menu Map

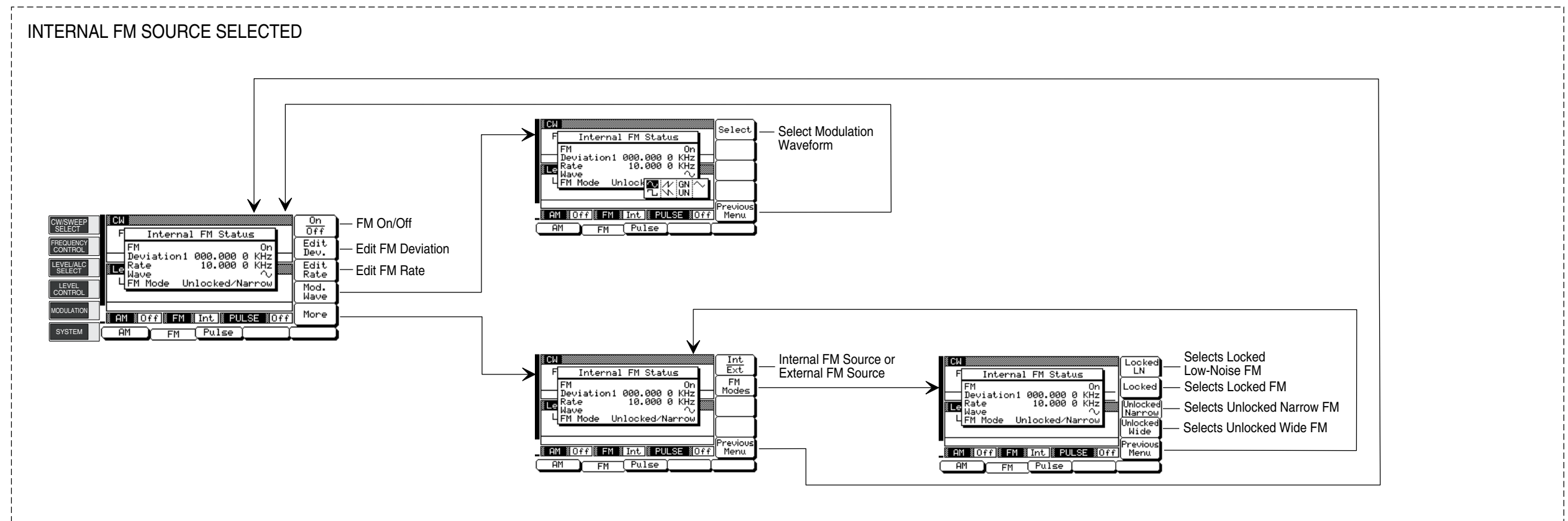

NOTE
Refer to Chapter 3, paragraph 3-12
for FM Mode operating instructions.

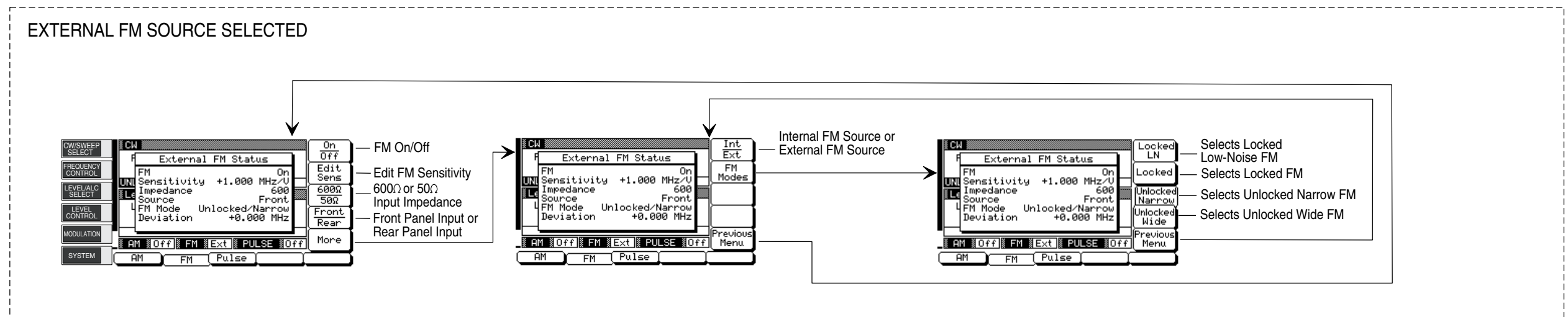

Figure 4-11. Frequency Modulation Mode Menu Map

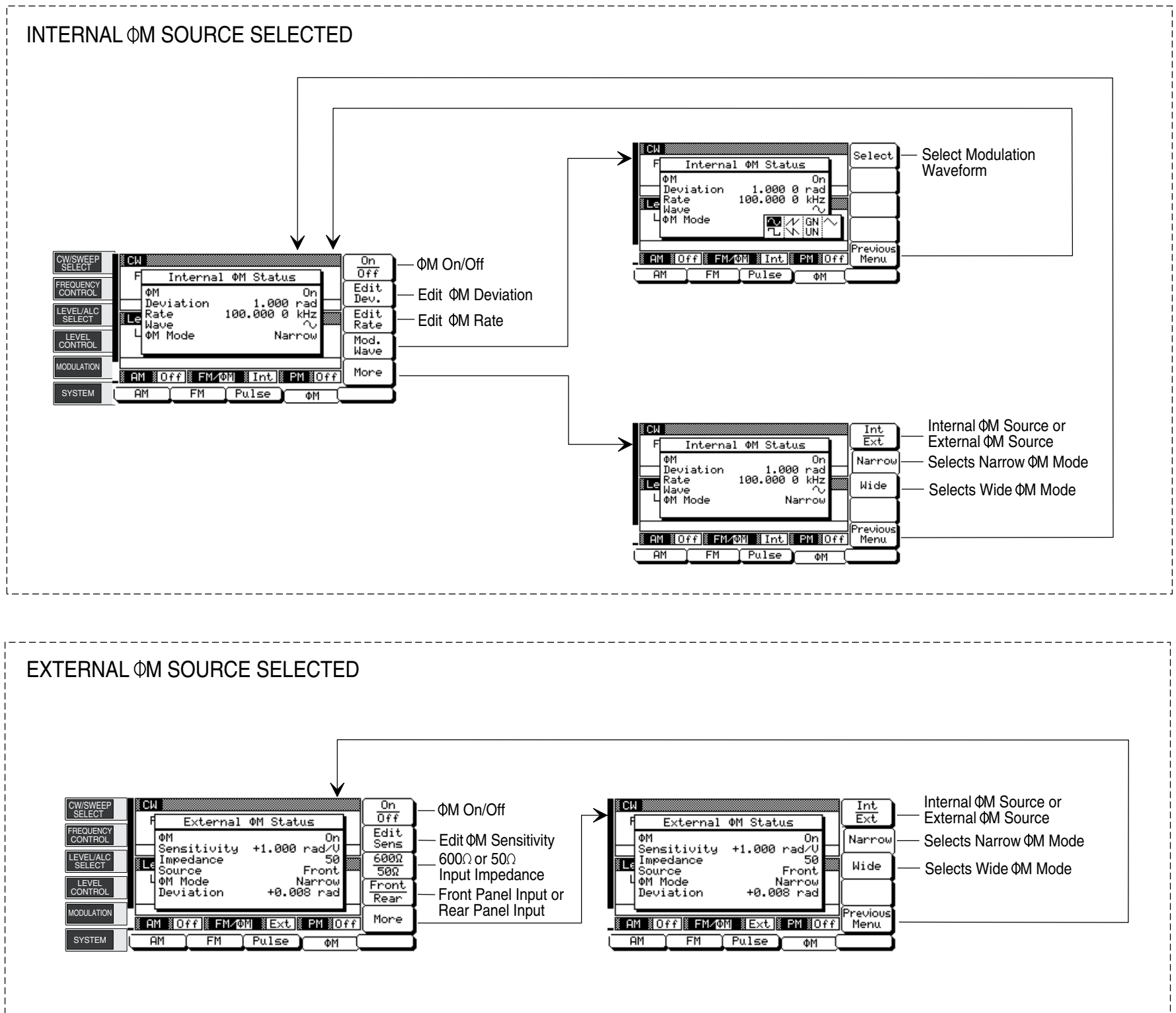
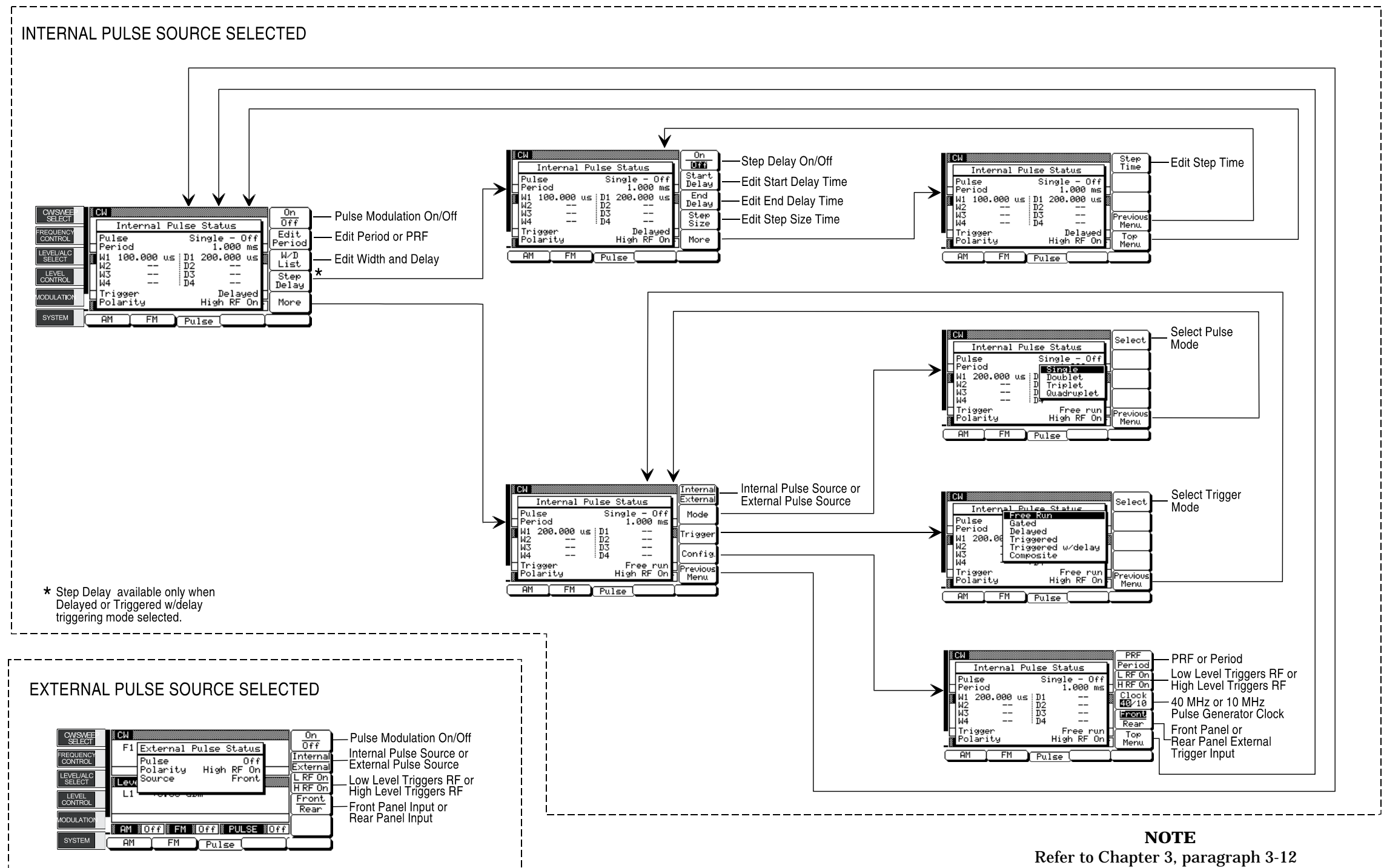

Figure 4-12. Phase Modulation Mode (Option 6) Menu Map



NOTE
Refer to Chapter 3, paragraph 3-12 for Pulse Modulation Mode operating instructions.

Figure 4-13. Pulse Modulation Mode Menu

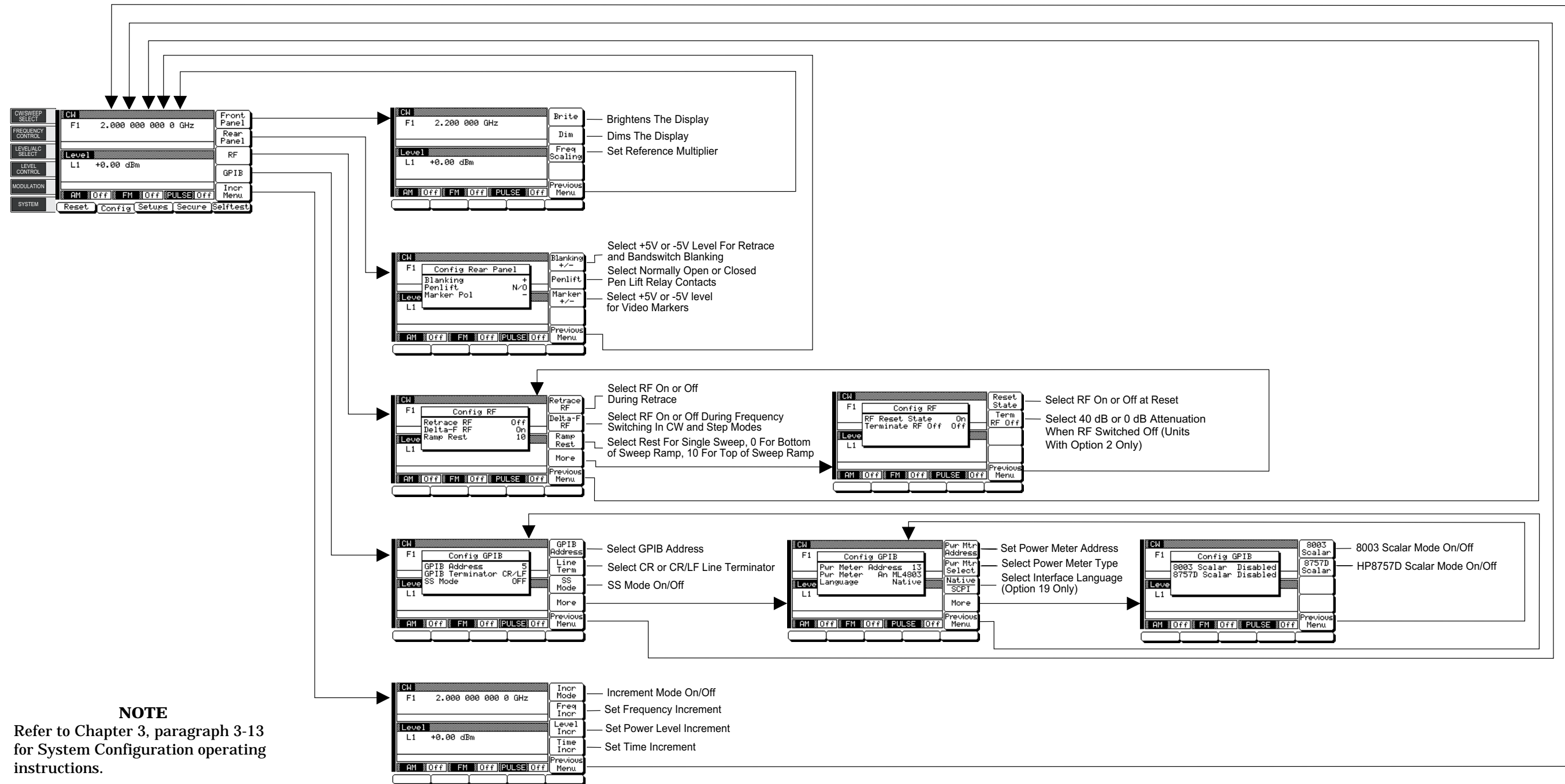

Figure 4-14. System Configuration Menu Map

Chapter 5

Operation Verification

Table of Contents

5-1	INTRODUCTION	5-3
5-2	TEST EQUIPMENT.	5-3
5-3	TEST RECORDS	5-3
5-4	INITIAL 681XXB/683XXB CHECKOUT.	5-4
	Power Up	5-4
	Self Test.	5-4
	Resetting the Signal Generator	5-4
	Warmup Time	5-4
5-5	CW FREQUENCY ACCURACY TEST.	5-5
	Test Setup.	5-5
	Test Procedure.	5-6
5-6	POWER LEVEL ACCURACY AND FLATNESS TESTS.	5-13
	Test Setup	5-13
	Power Level Accuracy Test Procedure	5-14
	Power Level Flatness Test Procedure	5-15

Chapter 5

Operation Verification

5-1 INTRODUCTION

This chapter contains three tests that can be used to verify the operation of the Series 682XXB/683XXB Synthesized Signal Generators.

Setup instructions and performance procedures are included for each test. The results can be compared with the specified limits that are shown on the test record forms that are provided for each test.

5-2 TEST EQUIPMENT

Table 5-1 lists the recommended test equipment for performing the operation verification tests in this chapter.

Table 5-1. Recommended Test Equipment

Instrument	Critical Specification	Recommended Manufacturer/Model
Frequency Counter, with Cable Kit and External Mixer	<i>Range:</i> 0.01 to 65 GHz <i>Input Z:</i> 50Ω <i>Resolution:</i> 1 Hz <i>Other:</i> External Time Base Input	EIP Microwave, Inc. Models 538B, 548B, or 578B, with Cable Kit: Option 590 and External Mixer: Option 91 (26.5 to 40 GHz) Option 92 (40 to 60 GHz) Option 93 (60 to 90 GHz)
Power Meter, with Power Sensor	<i>Range:</i> -30 to +20 dBm (1μW to 100 mW)	Hewlett-Packard Model 437B, with Power Sensor: HP 8487A (0.01 to 50 GHz)
Oscilloscope	<i>Bandwidth:</i> DC to 150 MHz <i>Vertical Sensitivity:</i> 2 mV/ division <i>Horiz Sensitivity:</i> 50 ns/ division	Tektronix, Inc. Model TAS485
Adapter	K (male) to 2.4 mm (female) Adapts the Power Sensor, HP 8487A, to the 682XXB/683XXB RF OUTPUT connector (≤40 GHz models)	Hewlett-Packard Part Number: HP 11940D

5-3 TEST RECORDS

Tables 5-2 and 5-3 contain test record forms that can be copied and used to record the results of operational verification testing of your 682XXB/683XXB. These tables are included as part of the operational

verification test procedures and contain test information for all 682XXB/683XXB models.

5-4 INITIAL 682XXB/683XXB CHECKOUT

Before starting the operation verification tests in this chapter, perform an initial checkout of the 682XXB/683XXB to be tested. This initial checkout consists of applying power to the signal generator, verifying that it passes self-test, and resetting it to the factory default parameters.

Power Up

First, verify that the rear panel line voltage selector is set for the correct line voltage, then connect the 682XXB/683XXB to the power source. This automatically places the signal generator in operation (front panel OPERATE LED on).

During power up, the signal generator loads its operating program then returns to the exact setup it was in when last turned off.

Self Test

Next, perform a self-test of the signal generator to insure proper operation of the instrument PCBs and other internal assemblies.

To self-test the instrument, first press **SYSTEM**, then press **Selftest**. When the self-test is complete, the signal generator displays the main CW menu.

NOTE

Error conditions detected during self-test are displayed as error messages on the data display. They should be corrected before continuing. Refer to Chapter 6 for a listing of error messages and descriptions.

Resetting the Signal Generator

The 682XXB/683XXB should be reset to the factory-selected default parameters before commencing operation verification testing.

To reset the instrument, first press **SYSTEM**, then press **Reset**. The signal generator resets to the CW frequency mode and displays the CW Menu.

Warmup Time

When the signal generator is turned on, allow one hour of warmup time before performing operational verification testing. This will assure stable operation of the instrument.

**5-5 CW FREQUENCY
ACCURACY TEST**

The following test verifies that the CW frequency output of the signal generator is within accuracy specifications. Table 5-2, beginning on page 5-7, contains test records that you can copy and use to record test results for this test. Test records for standard 682XXB/683XXB models are contained in Table 5-2A ; test records for 682XXB/683XXB models with Option 11 are contained in Table 5-2B.

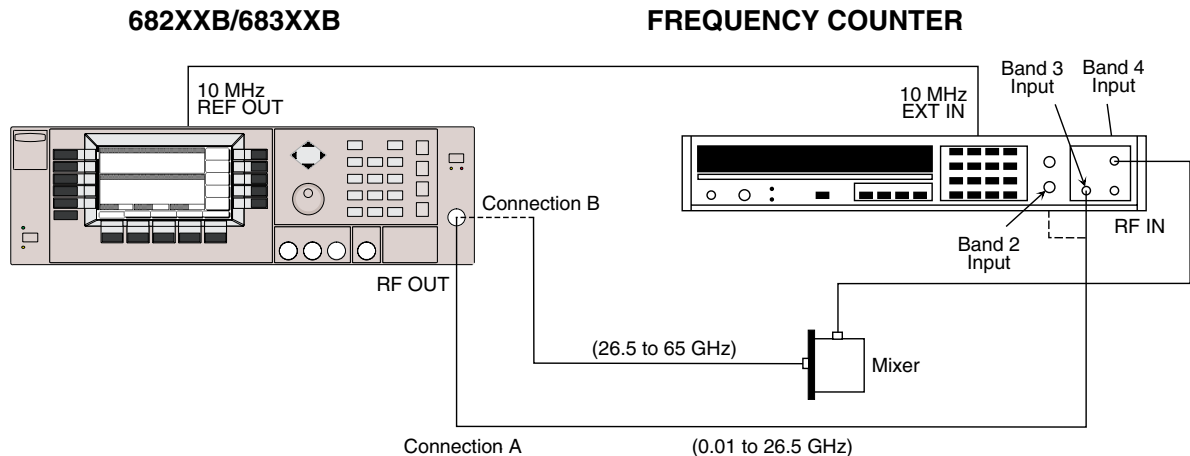

Figure 5-1. Equipment Setup for CW Frequency Accuracy Test

Test Setup

Connect the equipment, shown in Figure 5-1, as follows:

- Step 1** Connect the 682XXB/683XXB rear panel 10 MHz REF OUT to the Frequency Counter 10 MHz External Reference input. If the Frequency Counter has an INT/EXT toggle switch, set it to EXT.
- Step 2** Connect the 682XXB/683XXB RF OUTPUT to the Frequency Counter RF Input as follows:
 - a.** For measuring frequencies of 0.01 to 1.0 GHz, connect to the Band 2 input (Connection A).
 - b.** For measuring frequencies of 1.0 to 26.5 GHz, connect to the Band 3 input (Connection A).
 - c.** For measuring frequencies of 26.5 to 65.0 GHz, connect to the Band 4 input as shown in Connection B using the appropriate waveguide mixer; Option 91 (26.5 to 40 GHz), Option 92 (40 to 60 GHz), or Option 93 (60 to 90 GHz).

**Test
Procedure**

The following procedure tests both the coarse and fine loops to verify the accuracy of the CW frequency output.

Step 1 Set up the 682XXB/683XXB as follows:

- a. Reset the instrument by pressing **SYSTEM**, then **Reset**. Upon reset, the CW Menu (below) is displayed.

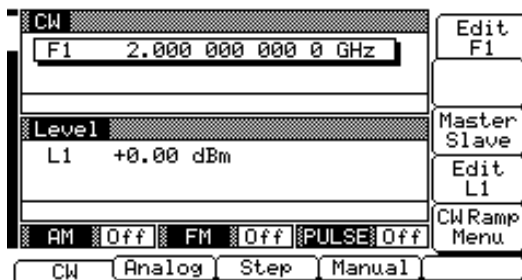

- b. Press **Edit F1** to open the current frequency parameter for editing.
- c. Set F1 to the first test frequency for the model being tested (Table 5-2A is the test record for standard models; Table 5-2B for models with Option 11).

Step 2 Verify that the Frequency Counter reading meets specifications (± 100 Hz of the value shown on the test record for standard models; ± 10 Hz for instruments with Option 11).

Step 3 Record the Frequency Counter reading on the test record (Table 5-2A or Table 5-2B).

NOTE

The Frequency Counter reading is typically within ± 1 Hz. Differences of a few Hertz can be caused by noise or counter limitations. Differences of $\geq \pm 100$ Hz ($\geq \pm 10$ Hz for instruments with Option 11) indicate a frequency synthesis problem.

Step 4 Set F1 to the next test frequency on the test record and record the Frequency Counter reading.

Step 5 Repeat step 4 until all frequencies listed on the test record have been recorded.

**OPERATION
VERIFICATION**

**CW FREQUENCY
ACCURACY TEST**

Table 5-2A. CW Frequency Accuracy Test Record (for Standard Models) (1 of 3)

Model 68__ _ B	Serial No. _____	Date _____
68237B / 68337B, 68245B / 68345B, 68247B / 68347B		68253B / 68353B, 68255B / 68355B, 68259B / 68359B
2.000 000 000*	_____	2.000 000 000* _____
5.000 000 000	_____	5.000 000 000 _____
8.000 000 000	_____	8.000 000 000 _____
11.000 000 000	_____	11.000 000 000 _____
14.000 000 000	_____	14.000 000 000 _____
17.000 000 000	_____	17.000 000 000 _____
20.000 000 000	_____	20.000 000 000 _____
		23.000 000 000 _____
		26.500 000 000 _____
2.000 001 000	_____	
2.000 002 000	_____	
2.000 003 000	_____	2.000 001 000 _____
2.000 004 000	_____	2.000 002 000 _____
2.000 005 000	_____	2.000 003 000 _____
2.000 006 000	_____	2.000 004 000 _____
2.000 007 000	_____	2.000 005 000 _____
2.000 008 000	_____	2.000 006 000 _____
2.000 009 000	_____	2.000 007 000 _____
2.000 010 000	_____	2.000 008 000 _____
		2.000 009 000 _____
		2.000 010 000 _____

* Specification for all frequencies listed above is ± 100 Hz. All frequencies are in GHz.

**OPERATION
VERIFICATION**

**CW FREQUENCY
ACCURACY TEST**

Table 5-2A. CW Frequency Accuracy Test Record (for Standard Models) (2 of 3)

Model 68__ B	Serial No. _____	Date _____
68263B / 68363B, 68265 / 68365B, 68269B / 68369B		68275B / 68375B and 68277B / 68377B
2.000 000 000* _____		2.000 000 000* _____
5.000 000 000 _____		6.000 000 000 _____
8.000 000 000 _____		10.000 000 000 _____
11.000 000 000 _____		14.000 000 000 _____
14.000 000 000 _____		18.000 000 000 _____
17.000 000 000 _____		22.000 000 000 _____
20.000 000 000 _____		26.000 000 000 _____
23.000 000 000 _____		30.000 000 000 _____
26.000 000 000 _____		34.000 000 000 _____
29.000 000 000 _____		38.000 000 000 _____
32.000 000 000 _____		42.000 000 000 _____
35.000 000 000 _____		46.000 000 000 _____
38.000 000 000 _____		50.000 000 000 _____
40.000 000 000 _____		
2.000 001 000 _____		2.000 001 000 _____
2.000 002 000 _____		2.000 002 000 _____
2.000 003 000 _____		2.000 003 000 _____
2.000 004 000 _____		2.000 004 000 _____
2.000 005 000 _____		2.000 005 000 _____
2.000 006 000 _____		2.000 006 000 _____
2.000 007 000 _____		2.000 007 000 _____
2.000 008 000 _____		2.000 008 000 _____
2.000 009 000 _____		2.000 009 000 _____
2.000 010 000 _____		2.000 010 000 _____

* Specification for all frequencies listed above is ± 100 Hz. All frequencies are in GHz.

**OPERATION
VERIFICATION**

**CW FREQUENCY
ACCURACY TEST**

Table 5-2A. CW Frequency Accuracy Test Record (for Standard Models) (3 of 3)

Model 68__B	Serial No. _____	Date _____
68285B / 68385B and 68287B / 68387B		68295B / 68395B and 68297B/ 68397B
2.000 000 000*	_____	2.000 000 000* _____
6.000 000 000	_____	6.000 000 000 _____
10.000 000 000	_____	10.000 000 000 _____
14.000 000 000	_____	14.000 000 000 _____
18.000 000 000	_____	18.000 000 000 _____
22.000 000 000	_____	22.000 000 000 _____
26.000 000 000	_____	26.000 000 000 _____
30.000 000 000	_____	30.000 000 000 _____
34.000 000 000	_____	34.000 000 000 _____
38.000 000 000	_____	38.000 000 000 _____
42.000 000 000	_____	42.000 000 000 _____
46.000 000 000	_____	46.000 000 000 _____
50.000 000 000	_____	50.000 000 000 _____
54.000 000 000	_____	54.000 000 000 _____
58.000 000 000	_____	58.000 000 000 _____
60.000 000 000	_____	62.000 000 000 _____
		65.000 000 000 _____
2.000 001 000	_____	2.000 001 000 _____
2.000 002 000	_____	2.000 002 000 _____
2.000 003 000	_____	2.000 003 000 _____
2.000 004 000	_____	2.000 004 000 _____
2.000 005 000	_____	2.000 005 000 _____
2.000 006 000	_____	2.000 006 000 _____
2.000 007 000	_____	2.000 007 000 _____
2.000 008 000	_____	2.000 008 000 _____
2.000 009 000	_____	2.000 009 000 _____
2.000 010 000	_____	2.000 010 000 _____

* Specification for all frequencies listed above is ±100 Hz. All frequencies are in GHz.

**OPERATION
VERIFICATION**

**CW FREQUENCY
ACCURACY TEST**

Table 5-2B. CW Frequency Accuracy Test Record (for Models with Option 11) (1 of 3)

Model 68__ B	Serial No. _____	Date _____
68237B / 68337B, 68245B / 68345B, 68247B / 68347B		68253B / 68353B, 68255B / 68355B, 68259B / 68359B
2.000 000 000 0*	_____	2.000 000 000 0* _____
5.000 000 000 0	_____	5.000 000 000 0 _____
8.000 000 000 0	_____	8.000 000 000 0 _____
11.000 000 000 0	_____	11.000 000 000 0 _____
14.000 000 000 0	_____	14.000 000 000 0 _____
17.000 000 000 0	_____	17.000 000 000 0 _____
20.000 000 000 0	_____	20.000 000 000 0 _____
		23.000 000 000 0 _____
		26.500 000 000 0 _____
2.000 000 100 0	_____	
2.000 000 200 0	_____	
2.000 000 300 0	_____	2.000 000 100 0 _____
2.000 000 400 0	_____	2.000 000 200 0 _____
2.000 000 500 0	_____	2.000 000 300 0 _____
2.000 000 600 0	_____	2.000 000 400 0 _____
2.000 000 700 0	_____	2.000 000 500 0 _____
2.000 000 800 0	_____	2.000 000 600 0 _____
2.000 000 900 0	_____	2.000 000 700 0 _____
2.000 001 000 0	_____	2.000 000 800 0 _____
		2.000 000 900 0 _____
		2.000 001 000 0 _____

* Specification for all frequencies listed above is ± 10 Hz. All frequencies are in GHz.

**OPERATION
VERIFICATION**

**CW FREQUENCY
ACCURACY TEST**

Figure 5-2B. CW Frequency Accuracy Test Record (for Models with Option 11) (2 of 3)

Model 68__ _ B	Serial No. _____	Date _____
68263B / 68363B, 68265B / 68365B, 68269B / 68369B		68275B / 68375B and 68277B / 68377B
2.000 000 000 0*	_____	2.000 000 000 0* _____
5.000 000 000 0	_____	6.000 000 000 0 _____
8.000 000 000 0	_____	10.000 000 000 0 _____
11.000 000 000 0	_____	14.000 000 000 0 _____
14.000 000 000 0	_____	18.000 000 000 0 _____
17.000 000 000 0	_____	22.000 000 000 0 _____
20.000 000 000 0	_____	26.000 000 000 0 _____
23.000 000 000 0	_____	30.000 000 000 0 _____
26.000 000 000 0	_____	34.000 000 000 0 _____
29.000 000 000 0	_____	38.000 000 000 0 _____
32.000 000 000 0	_____	42.000 000 000 0 _____
35.000 000 000 0	_____	46.000 000 000 0 _____
38.000 000 000 0	_____	50.000 000 000 0 _____
40.000 000 000 0	_____	
2.000 000 100 0	_____	2.000 000 100 0 _____
2.000 000 200 0	_____	2.000 000 200 0 _____
2.000 000 300 0	_____	2.000 000 300 0 _____
2.000 000 400 0	_____	2.000 000 400 0 _____
2.000 000 500 0	_____	2.000 000 500 0 _____
2.000 000 600 0	_____	2.000 000 600 0 _____
2.000 000 700 0	_____	2.000 000 700 0 _____
2.000 000 800 0	_____	2.000 000 800 0 _____
2.000 000 900 0	_____	2.000 000 900 0 _____
2.000 001 000 0	_____	2.000 001 000 0 _____

* Specification for all frequencies listed above is ± 10 Hz. All frequencies are in GHz.

**OPERATION
VERIFICATION**

**CW FREQUENCY
ACCURACY TEST**

Table 5-2B. CW Frequency Accuracy Test Record (for Models with Option 11) (3 of 3)

Model 68__ B	Serial No. _____	Date _____
68285B / 68385B and 68287B / 68387B		68295B / 68395B and 68287B / 68397B
2,000 000 000 0*	_____	2,000 000 000 0* _____
6.000 000 000 0	_____	6.000 000 000 0 _____
10,000 000 000 0	_____	10,000 000 000 0 _____
14.000 000 000 0	_____	14.000 000 000 0 _____
18.000 000 000 0	_____	18.000 000 000 0 _____
22.000 000 000 0	_____	22.000 000 000 0 _____
26.000 000 000 0	_____	26.000 000 000 0 _____
30.000 000 000 0	_____	30.000 000 000 0 _____
34.000 000 000 0	_____	34.000 000 000 0 _____
38.000 000 000 0	_____	38.000 000 000 0 _____
42.000 000 000 0	_____	42.000 000 000 0 _____
46.000 000 000 0	_____	46.000 000 000 0 _____
50.000 000 000 0	_____	50.000 000 000 0 _____
54.000 000 000 0	_____	54.000 000 000 0 _____
58.000 000 000 0	_____	58.000 000 000 0 _____
60.000 000 000 0	_____	62.000 000 000 0 _____
		65.000 000 000 0 _____
2.000 000 100 0	_____	2.000 000 100 0 _____
2.000 000 200 0	_____	2.000 000 200 0 _____
2.000 000 300 0	_____	2.000 000 300 0 _____
2.000 000 400 0	_____	2.000 000 400 0 _____
2.000 000 500 0	_____	2.000 000 500 0 _____
2.000 000 600 0	_____	2.000 000 600 0 _____
2.000 000 700 0	_____	2.000 000 700 0 _____
2.000 000 800 0	_____	2.000 000 800 0 _____
2.000 000 900 0	_____	2.000 000 900 0 _____
2.000 001 000 0	_____	2.000 001 000 0 _____

* Specification for all frequencies listed above is ± 10 Hz. All frequencies are in GHz.

**5-6 POWER LEVEL
ACCURACY AND
FLATNESS TESTS**

These tests verify that the power level accuracy and flatness of the signal generator meet specifications. Table 5-3, beginning on page 5-19, contains test records that you can copy and use to record test results for these tests. Test records are provided for each 682XXB/683XXB model configuration.

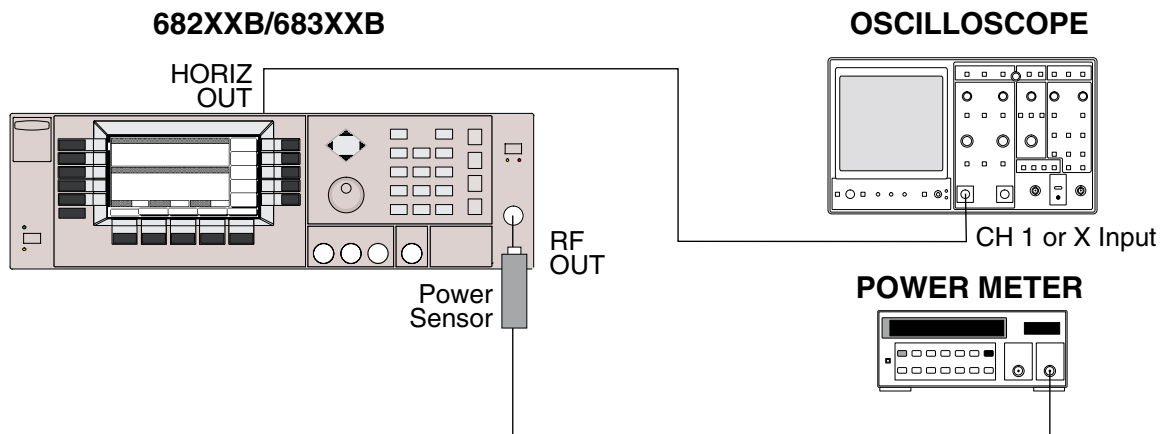

Figure 5-2. Equipment Setup for Power Level Accuracy and Flatness Tests

Test Setup

Connect the equipment, shown in Figure 5-2, as follows:

- Step 1** Calibrate the Power Meter with the Power Sensor.
- Step 2** Connect the Power Sensor to the RF OUTPUT of the 682XXB/683XXB.

NOTE

For ≤ 40 GHz models, use the K (male) to 2.4 mm (female) adapter to connect the Power Sensor to the RF OUTPUT connector.

- Step 3** Connect the 682XXB/683XXB rear panel HORIZ OUT to the Oscilloscope CH.1 input (X input).

NOTE

Before starting these procedures, locate the test record in Table 5-3 for the particular 682XXB/683XXB model configuration being tested.

**Power Level
Accuracy Test
Procedure**

Power level accuracy is checked by stepping the power down in 1 dB increments from its maximum rated power level.

Step 1 Set up the 682XXB/683XXB as follows:

- a. Reset the instrument by pressing **SYSTEM**, then **Reset**. The CW Menu (below) is displayed.

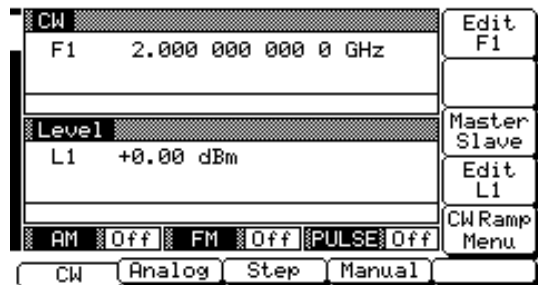

- b. Press **Edit F1** to open the current frequency parameter for editing.
- c. Set F1 to the CW frequency noted on the test record for the model being tested.
- d. Press **Edit L1** to open the current power level parameter for editing.
- e. Set L1 to the power level noted on the test record.

Step 2 Measure the output power level with the Power Meter and record the reading on the test record.

Step 3 Verify that the Power Meter reading meets the specifications stated on the test record.

Step 4 Set L1 to the next test power level. Record the Power Meter reading on the test record.

Step 5 Repeat step 4 for the other levels listed on the test record for the current CW frequency.

Step 6 Repeat steps 1 thru 5 for all CW frequencies listed on the test record.

**Power Level
Flatness Test
Procedure**

Power level flatness is checked by measuring the power level variation during a full band sweep; first in the step sweep mode (682XXB/683XXB models), then in the analog sweep mode (683XXB models only).

- Step 1** Set up the 682XXB/683XXB as follows for a step sweep power level flatness test.
- a. Reset the instrument by pressing **SYSTEM**, then **Reset**. The CW Menu is displayed.
 - b. Press **Step** to place the instrument in the step sweep frequency mode and display the Step Sweep Menu (below).

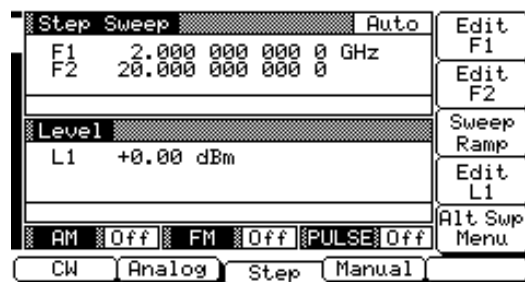

- c. With the Step Sweep menu displayed, press the main menu key

FREQUENCY CONTROL

The Sweep Frequency Control menu (below) is displayed.

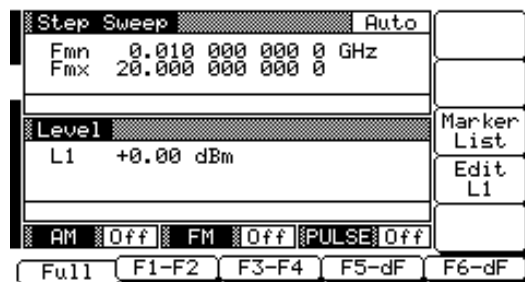

- d. Press **Full** to select a full range frequency sweep.
- e. Press **Edit L1** to open the current power level parameter for editing.
- f. Set L1 to the power level noted on the test record.

- g. Now, return to the Step Sweep menu by pressing the main menu key

**CW/SWEEP
SELECT**

- h. At the Step Sweep menu, press **Sweep Ramp** to go to the Step Sweep Ramp menu (below).

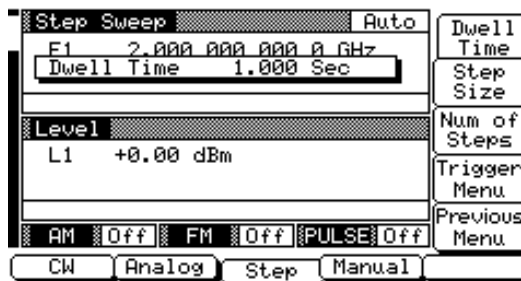

- i. Press **Dwell Time** to open the dwell time-per-step parameter for editing.
- j. Set the dwell time to 1 second.

NOTE

Monitor the 682XXB/683XXB's Horizontal Output on the Oscilloscope to determine sweep start and stop.

Step 2 As the 682XXB/683XXB steps through the full frequency range, measure the maximum and minimum Power Meter readings and record the values on the test record. Verify that the variation (difference between the maximum and minimum readings) does not exceed the value noted on the test record.

NOTE

This concludes power level testing for series 682XXB signal generators. For series 683XXB signal generators, continue on to step 3 to test power level flatness in the analog sweep mode.

- Step 3** Set up the 683XXB as follows for an analog sweep power level flatness test:
- Reset the instrument by pressing **SYSTEM**, then **Reset**. The CW Menu is displayed.
 - Press **Analog** to place the 683XXB in the analog sweep frequency mode and display the Analog Sweep Menu.

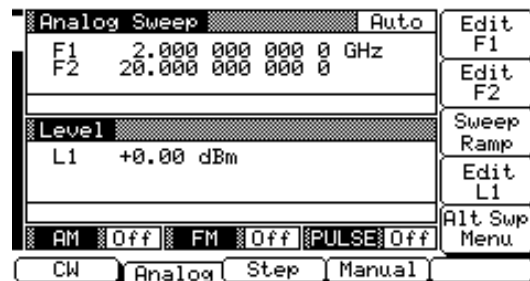

- With the Analog Sweep menu displayed, press the main menu key

FREQUENCY CONTROL

The Sweep Frequency Control menu (below) is displayed.

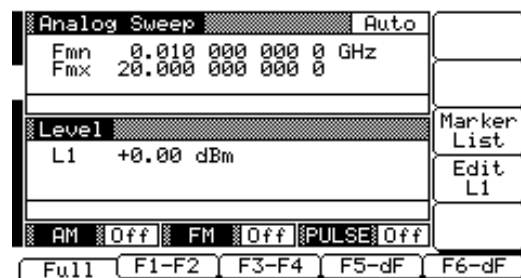

- Press **Full** to select a full range frequency sweep.
- Press **Edit L1** to open the current power level parameter for editing.
- Set L1 to the power level noted on the test record.
- Now, return to the Analog Sweep menu by pressing the main menu key

CW/SWEEP SELECT

- h.** At the Analog Sweep menu, press the menu soft-key **Sweep Ramp** to go to the Analog Sweep Ramp menu.

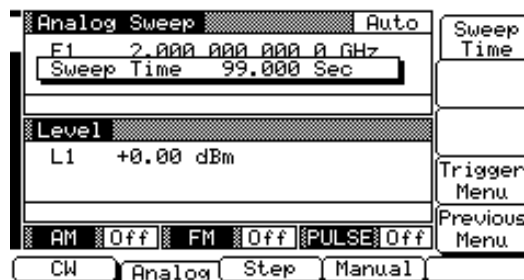

- i.** Press **Sweep Time** to open the sweep time parameter for editing.
- j.** Set the sweep time to 99 seconds.

NOTE

Monitor the 683XXB's Horizontal Output on the Oscilloscope to determine sweep start and stop.

- Step 4** During the analog sweep, measure the maximum and minimum Power Meter readings and record the values on the test record. Verify that the variation (difference between the maximum and minimum readings) does not exceed the value noted on the test record.

Table 5-3. Power Level Accuracy and Flatness Test Record (1 of 46)

Model 68_37B	Serial No. _____	Date _____
---------------------	-------------------------	-------------------

**Model 68237B/68337B
(without Option 2A Step Attenuator)**

**Power Level Accuracy *
(CW Frequency = 5.0 GHz)**

Set Power	Measured Power
+13 dBm	_____dBm
+12 dBm	_____dBm
+11 dBm	_____dBm
+10 dBm	_____dBm
+ 9 dBm	_____dBm
+ 8 dBm	_____dBm
+ 7 dBm	_____dBm
+ 6 dBm	_____dBm
+ 5 dBm	_____dBm
+ 4 dBm	_____dBm
+ 3 dBm	_____dBm
+ 2 dBm	_____dBm
+ 1 dBm	_____dBm

* Specification is ± 1.0 dB.

Power Level Flatness (Step Sweep)

Set Power	Max Power	Min Power	Variation **
+13 dBm	_____dBm	_____dBm	_____dB

** Maximum variation is 1.6 dB.

Power Level Flatness (Analog Sweep)(Model 68337B only)

Set Power	Max Power	Min Power	Variation ***
+13 dBm	_____dBm	_____dBm	_____dB

*** Maximum variation is 2.0 dB (typical, not a specification).

Table 5-3. Power Level Accuracy and Flatness Test Record (2 of 46)

Model 68_37B	Serial No. _____	Date _____
---------------------	-------------------------	-------------------

**Model 68237B/68337B
(with Option 2A Step Attenuator)**

**Power Level Accuracy *
(CW Frequency = 5.0 GHz)**

Set Power	Measured Power
+11 dBm	_____dBm
+10 dBm	_____dBm
+ 9 dBm	_____dBm
+ 8 dBm	_____dBm
+ 7 dBm	_____dBm
+ 6 dBm	_____dBm
+ 5 dBm	_____dBm
+ 4 dBm	_____dBm
+ 3 dBm	_____dBm
+ 2 dBm	_____dBm
+ 1 dBm	_____dBm
+ 0 dBm	_____dBm
- 1 dBm	_____dBm

* Specification is ± 1.0 dB.

Power Level Flatness (Step Sweep)

Set Power	Max Power	Min Power	Variation **
+11 dBm	_____dBm	_____dBm	_____dB

** Maximum variation is 1.6 dB.

Power Level Flatness (Analog Sweep)(Model 68337B only)

Set Power	Max Power	Min Power	Variation ***
+11 dBm	_____dBm	_____dBm	_____dB

*** Maximum variation is 6.0 dB (typical, not a specification).

Table 5-3. Power Level Accuracy and Flatness Test Record (3 of 46)

Model 68_37B w/Option 15B **Serial No.** _____ **Date** _____

**Model 68237B/68337B with Option 15B High Power
(without Option 2A Step Attenuator)**

**Power Level Accuracy *
(CW Frequency = 5.0 GHz)**

Set Power	Measured Power
+17 dBm	_____dBm
+16 dBm	_____dBm
+15 dBm	_____dBm
+14 dBm	_____dBm
+13 dBm	_____dBm
+12 dBm	_____dBm
+11 dBm	_____dBm
+10 dBm	_____dBm
+ 9 dBm	_____dBm
+ 8 dBm	_____dBm
+ 7 dBm	_____dBm
+ 6 dBm	_____dBm
+ 5 dBm	_____dBm

* Specification is ± 1.0 dB.

Power Level Flatness (Step Sweep)

Set Power	Max Power	Min Power	Variation **
+17 dBm	_____dBm	_____dBm	_____dB

** Maximum variation is 1.6 dB.

Power Level Flatness (Analog Sweep)(Model 68337B only)

Set Power	Max Power	Min Power	Variation ***
+17 dBm	_____dBm	_____dBm	_____dB

*** Maximum variation is 2.0 dB (typical, not a specification).

Table 5-3. Power Level Accuracy and Flatness Test Record (4 of 46)

Model 68_37B w/Option 15B **Serial No.** _____ **Date** _____

**Model 68237B/68337B with Option 15B High Power
(with Option 2A Step Attenuator)**

Power Level Accuracy *
(CW Frequency = 5.0 GHz)

Set Power	Measured Power
+15 dBm	_____dBm
+14 dBm	_____dBm
+13 dBm	_____dBm
+12 dBm	_____dBm
+11 dBm	_____dBm
+10 dBm	_____dBm
+ 9 dBm	_____dBm
+ 8 dBm	_____dBm
+ 7 dBm	_____dBm
+ 6 dBm	_____dBm
+ 5 dBm	_____dBm
+ 4 dBm	_____dBm
+ 3 dBm	_____dBm

* Specification is ± 1.0 dB.

Power Level Flatness (Step Sweep)

Set Power	Max Power	Min Power	Variation **
+15 dBm	_____dBm	_____dBm	_____dB

** Maximum variation is 1.6 dB.

Power Level Flatness (Analog Sweep)(Model 68337B only)

Set Power	Max Power	Min Power	Variation ***
+15 dBm	_____dBm	_____dBm	_____dB

*** Maximum variation is 6.0 dB (typical, not a specification).

Table 5-3. Power Level Accuracy and Flatness Test Record (5 of 46)

Model 68_45B		Serial No. _____		Date _____	
Model 68245B/68345B (without Option 2A Step Attenuator)					
Power Level Accuracy * (CW Frequency = 1.0 GHz)			Power Level Accuracy * (CW Frequency = 5.0 GHz)		
Set Power	Measured Power	Set Power	Measured Power		
+13 dBm	_____dBm	+13 dBm	_____dBm		
+12 dBm	_____dBm	+12 dBm	_____dBm		
+11 dBm	_____dBm	+11 dBm	_____dBm		
+10 dBm	_____dBm	+10 dBm	_____dBm		
+ 9 dBm	_____dBm	+ 9 dBm	_____dBm		
+ 8 dBm	_____dBm	+ 8 dBm	_____dBm		
+ 7 dBm	_____dBm	+ 7 dBm	_____dBm		
+ 6 dBm	_____dBm	+ 6 dBm	_____dBm		
+ 5 dBm	_____dBm	+ 5 dBm	_____dBm		
+ 4 dBm	_____dBm	+ 4 dBm	_____dBm		
+ 3 dBm	_____dBm	+ 3 dBm	_____dBm		
+ 2 dBm	_____dBm	+ 2 dBm	_____dBm		
+ 1 dBm	_____dBm	+ 1 dBm	_____dBm		
* Specification is ± 1.0 dB.			* Specification is ± 1.0 dB.		
Power Level Flatness (Step Sweep)					
Set Power	Max Power	Min Power	Variation **		
+13 dBm	_____dBm	_____dBm	_____dB		
** Maximum variation is 1.6 dB.					
Power Level Flatness (Analog Sweep)(Model 68345B only)					
Set Power	Max Power	Min Power	Variation ***		
+13 dBm	_____dBm	_____dBm	_____dB		
*** Maximum variation is 2.0 dB (typical, not a specification).					

OPERATION VERIFICATION

POWER LEVEL ACCURACY AND FLATNESS TESTS

Table 5-3. Power Level Accuracy and Flatness Test Record (6 of 46)

Model 68_45B		Serial No. _____		Date _____	
Model 68245B/68345B (with Option 2A Step Attenuator)					
Power Level Accuracy * (CW Frequency = 1.0 GHz)			Power Level Accuracy * (CW Frequency = 5.0 GHz)		
Set Power	Measured Power	Set Power	Measured Power		
+11 dBm	_____dBm	+11 dBm	_____dBm		
+10 dBm	_____dBm	+10 dBm	_____dBm		
+ 9 dBm	_____dBm	+ 9 dBm	_____dBm		
+ 8 dBm	_____dBm	+ 8 dBm	_____dBm		
+ 7 dBm	_____dBm	+ 7 dBm	_____dBm		
+ 6 dBm	_____dBm	+ 6 dBm	_____dBm		
+ 5 dBm	_____dBm	+ 5 dBm	_____dBm		
+ 4 dBm	_____dBm	+ 4 dBm	_____dBm		
+ 3 dBm	_____dBm	+ 3 dBm	_____dBm		
+ 2 dBm	_____dBm	+ 2 dBm	_____dBm		
+ 1 dBm	_____dBm	+ 1 dBm	_____dBm		
+ 0 dBm	_____dBm	+ 0 dBm	_____dBm		
- 1 dBm	_____dBm	- 1 dBm	_____dBm		
* Specification is ± 1.0 dB.			* Specification is ± 1.0 dB.		
Power Level Flatness (Step Sweep)					
Set Power	Max Power	Min Power	Variation **		
+11 dBm	_____dBm	_____dBm	_____dB		
** Maximum variation is 1.6 dB.					
Power Level Flatness (Analog Sweep)(Model 68345B only)					
Set Power	Max Power	Min Power	Variation ***		
+11 dBm	_____dBm	_____dBm	_____dB		
*** Maximum variation is 6.0 dB (typical, not a specification).					

OPERATION VERIFICATION

POWER LEVEL ACCURACY AND FLATNESS TESTS

Table 5-3. Power Level Accuracy and Flatness Test Record (7 of 46)

Model 68_45B w/Option 15B		Serial No. _____		Date _____	
Model 68245B/68345B with Option 15B High Power (without Option 2A Step Attenuator)					
Power Level Accuracy * (CW Frequency = 1.0 GHz)		Power Level Accuracy * (CW Frequency = 5.0 GHz)			
Set Power	Measured Power	Set Power	Measured Power		
+13 dBm	_____dBm	+17 dBm	_____dBm		
+12 dBm	_____dBm	+16 dBm	_____dBm		
+11 dBm	_____dBm	+15 dBm	_____dBm		
+10 dBm	_____dBm	+14 dBm	_____dBm		
+ 9 dBm	_____dBm	+13 dBm	_____dBm		
+ 8 dBm	_____dBm	+ 12dBm	_____dBm		
+ 7 dBm	_____dBm	+11 dBm	_____dBm		
+ 6 dBm	_____dBm	+10 dBm	_____dBm		
+ 5 dBm	_____dBm	+ 9 dBm	_____dBm		
+ 4 dBm	_____dBm	+ 8 dBm	_____dBm		
+ 3 dBm	_____dBm	+ 7dBm	_____dBm		
+ 2 dBm	_____dBm	+ 6 dBm	_____dBm		
+ 1 dBm	_____dBm	+ 5 dBm	_____dBm		
* Specification is ± 1.0 dB.		* Specification is ± 1.0 dB.			
Power Level Flatness (Step Sweep)					
Set Power	Max Power	Min Power	Variation **		
+13 dBm	_____dBm	_____dBm	_____dB		
** Maximum variation is 1.6 dB.					
Power Level Flatness (Analog Sweep)(Model 68345B only)					
Set Power	Max Power	Min Power	Variation ***		
+13 dBm	_____dBm	_____dBm	_____dB		
*** Maximum variation is 2.0 dB(typical, not a specification).					

OPERATION VERIFICATION

POWER LEVEL ACCURACY AND FLATNESS TESTS

Table 5-3. Power Level Accuracy and Flatness Test Record (8 of 46)

Model 68_45B w/Option 15B		Serial No. _____		Date _____	
Model 68245B/68345B with Option 15B High Power (with Option 2A Step Attenuator)					
Power Level Accuracy * (CW Frequency = 1.0 GHz)			Power Level Accuracy * (CW Frequency = 5.0 GHz)		
Set Power	Measured Power	Set Power	Measured Power		
+11 dBm	_____dBm	+15 dBm	_____dBm		
+10 dBm	_____dBm	+14 dBm	_____dBm		
+ 9 dBm	_____dBm	+13 dBm	_____dBm		
+ 8 dBm	_____dBm	+12 dBm	_____dBm		
+ 7 dBm	_____dBm	+11 dBm	_____dBm		
+ 6 dBm	_____dBm	+10 dBm	_____dBm		
+ 5 dBm	_____dBm	+ 9 dBm	_____dBm		
+ 4 dBm	_____dBm	+ 8 dBm	_____dBm		
+ 3 dBm	_____dBm	+ 7 dBm	_____dBm		
+ 2 dBm	_____dBm	+ 6 dBm	_____dBm		
+ 1 dBm	_____dBm	+ 5 dBm	_____dBm		
+ 0 dBm	_____dBm	+ 4 dBm	_____dBm		
- 1 dBm	_____dBm	+ 3 dBm	_____dBm		
* Specification is ± 1.0 dB.			* Specification is ± 1.0 dB.		
Power Level Flatness (Step Sweep)					
Set Power	Max Power	Min Power	Variation **		
+11 dBm	_____dBm	_____dBm	_____dB		
** Maximum variation is 1.6 dB.					
Power Level Flatness (Analog Sweep)(Model 68345B only)					
Set Power	Max Power	Min Power	Variation ***		
+11 dBm	_____dBm	_____dBm	_____dB		
*** Maximum variation is 6.0 dB (typical, not a specification).					

OPERATION VERIFICATION

POWER LEVEL ACCURACY AND FLATNESS TESTS

Table 5-3. Power Level Accuracy and Flatness Test Record (9 of 46)

Model 68_47B	Serial No. _____	Date _____
---------------------	-------------------------	-------------------

**Model 68247B/68347B
(without Option 2A Step Attenuator)**

Power Level Accuracy * (CW Frequency = 1.0 GHz)		Power Level Accuracy * (CW Frequency = 5.0 GHz)	
Set Power	Measured Power	Set Power	Measured Power
+13 dBm	_____dBm	+13 dBm	_____dBm
+12 dBm	_____dBm	+12 dBm	_____dBm
+11 dBm	_____dBm	+11 dBm	_____dBm
+10 dBm	_____dBm	+10 dBm	_____dBm
+ 9 dBm	_____dBm	+ 9 dBm	_____dBm
+ 8 dBm	_____dBm	+ 8 dBm	_____dBm
+ 7 dBm	_____dBm	+ 7 dBm	_____dBm
+ 6 dBm	_____dBm	+ 6 dBm	_____dBm
+ 5 dBm	_____dBm	+ 5 dBm	_____dBm
+ 4 dBm	_____dBm	+ 4 dBm	_____dBm
+ 3 dBm	_____dBm	+ 3 dBm	_____dBm
+ 2 dBm	_____dBm	+ 2 dBm	_____dBm
+ 1 dBm	_____dBm	+ 1 dBm	_____dBm

* Specification is ±1.0 dB.

* Specification is ±1.0 dB.

Power Level Flatness (Step Sweep)

Set Power	Max Power	Min Power	Variation **
+13 dBm	_____dBm	_____dBm	_____dB

** Maximum variation is 4.0 dB (0.01 to 0.05 GHz); 1.6 dB (0.05 to 20 GHz).

Power Level Flatness (Analog Sweep)(Model 68347B only)

Set Power	Max Power	Min Power	Variation ***
+13 dBm	_____dBm	_____dBm	_____dB

*** Maximum variation is 4.0 dB (0.01 to 0.05 GHz); 2.0 dB (0.05 to 20 GHz)(typical, not a specification).

OPERATION VERIFICATION

POWER LEVEL ACCURACY AND FLATNESS TESTS

Table 5-3. Power Level Accuracy and Flatness Test Record (10 of 46)

Model 68_47B		Serial No. _____		Date _____	
Model 68247B/68347B (with Option 2A Step Attenuator)					
Power Level Accuracy * (CW Frequency = 1.0 GHz)			Power Level Accuracy * (CW Frequency = 5.0 GHz)		
Set Power	Measured Power	Set Power	Measured Power		
+11 dBm	_____dBm	+11 dBm	_____dBm		
+10 dBm	_____dBm	+10 dBm	_____dBm		
+ 9 dBm	_____dBm	+ 9 dBm	_____dBm		
+ 8 dBm	_____dBm	+ 8 dBm	_____dBm		
+ 7 dBm	_____dBm	+ 7 dBm	_____dBm		
+ 6 dBm	_____dBm	+ 6 dBm	_____dBm		
+ 5 dBm	_____dBm	+ 5 dBm	_____dBm		
+ 4 dBm	_____dBm	+ 4 dBm	_____dBm		
+ 3 dBm	_____dBm	+ 3 dBm	_____dBm		
+ 2 dBm	_____dBm	+ 2 dBm	_____dBm		
+ 1 dBm	_____dBm	+ 1 dBm	_____dBm		
+ 0 dBm	_____dBm	+ 0 dBm	_____dBm		
- 1 dBm	_____dBm	- 1 dBm	_____dBm		
* Specification is ± 1.0 dB.			* Specification is ± 1.0 dB.		
Power Level Flatness (Step Sweep)					
Set Power	Max Power	Min Power	Variation **		
+11 dBm	_____dBm	_____dBm	_____dB		
** Maximum variation is 4.0 dB (0.01 to 0.05 GHz); 1.6 dB (0.05 to 20 GHz).					
Power Level Flatness (Analog Sweep)(Model 68347B only)					
Set Power	Max Power	Min Power	Variation ***		
+11 dBm	_____dBm	_____dBm	_____dB		
*** Maximum variation is 7.0 dB (0.01 to 0.05 GHz); 6.0 dB (0.05 to 20 GHz)(typical, not a specification).					

OPERATION VERIFICATION

POWER LEVEL ACCURACY AND FLATNESS TESTS

Table 5-3. Power Level Accuracy and Flatness Test Record (11 of 46)

Model 68_47B w/Option 15B **Serial No.** _____ **Date** _____

**Model 68247B/68347B with Option 15B High Power
(without Option 2A Step Attenuator)**

Power Level Accuracy * (CW Frequency = 1.0 GHz)		Power Level Accuracy * (CW Frequency = 5.0 GHz)	
Set Power	Measured Power	Set Power	Measured Power
+13 dBm	_____dBm	+17 dBm	_____dBm
+12 dBm	_____dBm	+16 dBm	_____dBm
+11 dBm	_____dBm	+15 dBm	_____dBm
+10 dBm	_____dBm	+14 dBm	_____dBm
+ 9 dBm	_____dBm	+13 dBm	_____dBm
+ 8 dBm	_____dBm	+ 12dBm	_____dBm
+ 7 dBm	_____dBm	+11 dBm	_____dBm
+ 6 dBm	_____dBm	+10 dBm	_____dBm
+ 5 dBm	_____dBm	+ 9 dBm	_____dBm
+ 4 dBm	_____dBm	+ 8 dBm	_____dBm
+ 3 dBm	_____dBm	+ 7dBm	_____dBm
+ 2 dBm	_____dBm	+ 6 dBm	_____dBm
+ 1 dBm	_____dBm	+ 5 dBm	_____dBm

* Specification is ± 1.0 dB.

* Specification is ± 1.0 dB.

Power Level Flatness (Step Sweep)

Set Power	Max Power	Min Power	Variation **
+13 dBm	_____dBm	_____dBm	_____dB

** Maximum variation is 4.0 dB (0.01 to 0.05 GHz); 1.6 dB (0.05 to 20 GHz).

Power Level Flatness (Analog Sweep)(Model 68347B only)

Set Power	Max Power	Min Power	Variation ***
+13 dBm	_____dBm	_____dBm	_____dB

*** Maximum variation is 4.0 dB (0.01 to 0.05 GHz); 2.0 dB (0.05 to 20 GHz)(typical, not a specification).

OPERATION VERIFICATION

POWER LEVEL ACCURACY AND FLATNESS TESTS

Table 5-3. Power Level Accuracy and Flatness Test Record (12 of 46)

Model 68_47B w/Option 15B		Serial No. _____	Date _____	
Model 68247B/68347B with Option 15B High Power (with Option 2A Step Attenuator)				
Power Level Accuracy * (CW Frequency = 1.0 GHz)		Power Level Accuracy * (CW Frequency = 5.0 GHz)		
Set Power	Measured Power	Set Power	Measured Power	
+11 dBm	_____dBm	+15 dBm	_____dBm	
+10 dBm	_____dBm	+14 dBm	_____dBm	
+ 9 dBm	_____dBm	+13 dBm	_____dBm	
+ 8 dBm	_____dBm	+12 dBm	_____dBm	
+ 7 dBm	_____dBm	+11 dBm	_____dBm	
+ 6 dBm	_____dBm	+10 dBm	_____dBm	
+ 5 dBm	_____dBm	+ 9 dBm	_____dBm	
+ 4 dBm	_____dBm	+ 8 dBm	_____dBm	
+ 3 dBm	_____dBm	+ 7 dBm	_____dBm	
+ 2 dBm	_____dBm	+ 6 dBm	_____dBm	
+ 1 dBm	_____dBm	+ 5 dBm	_____dBm	
+ 0 dBm	_____dBm	+ 4 dBm	_____dBm	
- 1 dBm	_____dBm	+ 3 dBm	_____dBm	

* Specification is ±1.0 dB.

* Specification is ±1.0 dB.

Power Level Flatness (Step Sweep)

Set Power	Max Power	Min Power	Variation **
+11 dBm	_____dBm	_____dBm	_____dB

** Maximum variation is 4.0 dB (0.01 to 0.05 GHz); 1.6 dB (0.05 to 20 GHz).

Power Level Flatness (Analog Sweep)(Model 68347B only)

Set Power	Max Power	Min Power	Variation ***
+11 dBm	_____dBm	_____dBm	_____dB

*** Maximum variation is 7.0 dB (0.01 to 0.05 GHz); 6.0 dB (0.05 to 20 GHz)(typical, not a specification).

OPERATION VERIFICATION

POWER LEVEL ACCURACY AND FLATNESS TESTS

Table 5-3. Power Level Accuracy and Flatness Test Record (13 of 46)

Model 68_53B	Serial No. _____	Date _____	
Model 68253B/68353B (without Option 2A Step Attenuator)			
Power Level Accuracy * (CW Frequency = 5.0 GHz)		Power Level Accuracy * (CW Frequency = 22.0 GHz)	
Set Power	Measured Power	Set Power	
Measured Power		Measured Power	
+ 9 dBm	_____dBm	+ 6 dBm	
+ 8 dBm	_____dBm	+ 5 dBm	
+ 7 dBm	_____dBm	+ 4 dBm	
+ 6 dBm	_____dBm	+ 3 dBm	
+ 5 dBm	_____dBm	+ 2 dBm	
+ 4 dBm	_____dBm	+ 1 dBm	
+ 3 dBm	_____dBm	+ 0 dBm	
+ 2 dBm	_____dBm	- 1 dBm	
+ 1 dBm	_____dBm	- 2 dBm	
+ 0 dBm	_____dBm	- 3 dBm	
- 1 dBm	_____dBm	- 4 dBm	
- 2 dBm	_____dBm	- 5 dBm	
- 3 dBm	_____dBm	- 6 dBm	
* Specification is ± 1.0 dB.		* Specification is ± 1.0 dB.	
Power Level Flatness (Step Sweep)			
Set Power	Max Power	Min Power	Variation **
+ 6 dBm	_____dBm	_____dBm	_____dB
** Maximum variation is 1.6 dB.			
Power Level Flatness (Analog Sweep)(Model 68353B only)			
Set Power	Max Power	Min Power	Variation ***
+ 6 dBm	_____dBm	_____dBm	_____dB
*** Maximum variation is 2.0 dB (2 to 20 GHz); 4.0 dB (20 to 26.5 GHz)(typical, not a specification).			

OPERATION VERIFICATION

POWER LEVEL ACCURACY AND FLATNESS TESTS

Table 5-3. Power Level Accuracy and Flatness Test Record (14 of 46)

Model 68_53B	Serial No. _____	Date _____	
Model 68253B/68353B (with Option 2A Step Attenuator)			
Power Level Accuracy * (CW Frequency = 5.0 GHz)		Power Level Accuracy * (CW Frequency = 22.0 GHz)	
Set Power	Measured Power	Set Power	Measured Power
+ 7 dBm	_____dBm	+ 3.5 dBm	_____dBm
+ 6 dBm	_____dBm	+ 2.5 dBm	_____dBm
+ 5 dBm	_____dBm	+ 1.5 dBm	_____dBm
+ 4 dBm	_____dBm	+ 0.5 dBm	_____dBm
+ 3 dBm	_____dBm	- 0.5 dBm	_____dBm
+ 2 dBm	_____dBm	- 1.5 dBm	_____dBm
+ 1 dBm	_____dBm	- 2.5 dBm	_____dBm
+ 0 dBm	_____dBm	- 3.5 dBm	_____dBm
- 1 dBm	_____dBm	- 4.5 dBm	_____dBm
- 2 dBm	_____dBm	- 5.5 dBm	_____dBm
- 3 dBm	_____dBm	- 6.5 dBm	_____dBm
- 4 dBm	_____dBm	- 7.5 dBm	_____dBm
- 5 dBm	_____dBm	- 8.5 dBm	_____dBm
* Specification is ± 1.0 dB.		* Specification is ± 1.0 dB.	
Power Level Flatness (Step Sweep)			
Set Power	Max Power	Min Power	Variation **
+ 3.5 dBm	_____dBm	_____dBm	_____dB
** Maximum variation is 1.6 dB.			
Power Level Flatness (Analog Sweep)(Model 68353B only)			
Set Power	Max Power	Min Power	Variation ***
+ 3.5 dBm	_____dBm	_____dBm	_____dB
*** Maximum variation is 6.0 dB (2 to 20 GHz); 8.2 dB (20 to 26.5 GHz)(typical, not a specification).			

Table 5-3. Power Level Accuracy and Flatness Test Record (15 of 46)

Model 68_53B w/Option 15B	Serial No. _____	Date _____	
Model 68253B/68353B with Option 15B High Power (without Option 2A Step Attenuator)			
Power Level Accuracy * (CW Frequency = 5.0 GHz)		Power Level Accuracy * (CW Frequency = 22.0 GHz)	
Set Power	Measured Power	Set Power	Measured Power
+13 dBm	_____dBm	+10 dBm	_____dBm
+12 dBm	_____dBm	+ 9 dBm	_____dBm
+11 dBm	_____dBm	+ 8 dBm	_____dBm
+10 dBm	_____dBm	+ 7 dBm	_____dBm
+ 9 dBm	_____dBm	+ 6 dBm	_____dBm
+ 8 dBm	_____dBm	+ 5 dBm	_____dBm
+ 7 dBm	_____dBm	+ 4 dBm	_____dBm
+ 6 dBm	_____dBm	+ 3 dBm	_____dBm
+ 5 dBm	_____dBm	+ 2 dBm	_____dBm
+ 4 dBm	_____dBm	+ 1 dBm	_____dBm
+ 3 dBm	_____dBm	+ 0 dBm	_____dBm
+ 2 dBm	_____dBm	- 1 dBm	_____dBm
+ 1 dBm	_____dBm	- 2 dBm	_____dBm
* Specification is ± 1.0 dB.		* Specification is ± 1.0 dB.	
Power Level Flatness (Step Sweep)			
Set Power	Max Power	Min Power	Variation **
+ 10 dBm	_____dBm	_____dBm	_____dB
** Maximum variation is 1.6 dB.			
Power Level Flatness (Analog Sweep)(Model 68353B only)			
Set Power	Max Power	Min Power	Variation ***
+ 10 dBm	_____dBm	_____dBm	_____dB
*** Maximum variation is 2.0 dB (2 to 20 GHz); 4.0 dB (20 to 26.5 GHz)(typical, not a specification).			

OPERATION VERIFICATION

POWER LEVEL ACCURACY AND FLATNESS TESTS

Table 5-3. Power Level Accuracy and Flatness Test Record (16 of 46)

Model 68_53B w/Option 15B **Serial No.** _____ **Date** _____

**Model 68253B/68353B with Option 15B High Power
(with Option 2A Step Attenuator)**

Power Level Accuracy * (CW Frequency = 5.0 GHz)		Power Level Accuracy * (CW Frequency = 22.0 GHz)	
Set Power	Measured Power	Set Power	Measured Power
+11 dBm	_____dBm	+ 7.5 dBm	_____dBm
+10 dBm	_____dBm	+ 6.5 dBm	_____dBm
+ 9 dBm	_____dBm	+ 5.5 dBm	_____dBm
+ 8 dBm	_____dBm	+ 4.5 dBm	_____dBm
+ 7 dBm	_____dBm	+ 3.5 dBm	_____dBm
+ 6 dBm	_____dBm	+ 2.5 dBm	_____dBm
+ 5 dBm	_____dBm	+ 1.5 dBm	_____dBm
+ 4 dBm	_____dBm	+ 0.5 dBm	_____dBm
+ 3 dBm	_____dBm	- 0.5 dBm	_____dBm
+ 2 dBm	_____dBm	- 1.5 dBm	_____dBm
+ 1 dBm	_____dBm	- 2.5 dBm	_____dBm
+ 0 dBm	_____dBm	- 3.5 dBm	_____dBm
- 1 dBm	_____dBm	- 4.5 dBm	_____dBm

* Specification is ± 1.0 dB.

* Specification is ± 1.0 dB.

Power Level Flatness (Step Sweep)

Set Power	Max Power	Min Power	Variation **
+ 7.5 dBm	_____dBm	_____dBm	_____dB

** Maximum variation is 1.6 dB.

Power Level Flatness (Analog Sweep)(Model 68353B only)

Set Power	Max Power	Min Power	Variation ***
+ 7.5 dBm	_____dBm	_____dBm	_____dB

*** Maximum variation is 6.0 dB (2 to 20 GHz); 8.2 dB (20 to 26.5 GHz)(typical, not a specification).

Table 5-3. Power Level Accuracy and Flatness Test Record (17 of 46)

Model 68_55B		Serial No. _____		Date _____	
Model 68255B/68355B (without Option 2A Step Attenuator)					
Power Level Accuracy * (CW Frequency = 1.0 GHz)		Power Level Accuracy * (CW Frequency = 5.0 GHz)		Power Level Accuracy * (CW Frequency = 22.0 GHz)	
Set Power	Measured Power	Set Power	Measured Power	Set Power	Measured Power
+13 dBm	_____dBm	+ 9 dBm	_____dBm	+ 6 dBm	_____dBm
+12 dBm	_____dBm	+ 8 dBm	_____dBm	+ 5 dBm	_____dBm
+11 dBm	_____dBm	+ 7 dBm	_____dBm	+ 4 dBm	_____dBm
+10 dBm	_____dBm	+ 6 dBm	_____dBm	+ 3 dBm	_____dBm
+ 9 dBm	_____dBm	+ 5 dBm	_____dBm	+ 2 dBm	_____dBm
+ 8 dBm	_____dBm	+ 4 dBm	_____dBm	+ 1 dBm	_____dBm
+ 7 dBm	_____dBm	+ 3 dBm	_____dBm	+ 0 dBm	_____dBm
+ 6 dBm	_____dBm	+ 2 dBm	_____dBm	- 1 dBm	_____dBm
+ 5 dBm	_____dBm	+ 1 dBm	_____dBm	- 2 dBm	_____dBm
+ 4 dBm	_____dBm	+ 0 dBm	_____dBm	- 3 dBm	_____dBm
+ 3 dBm	_____dBm	- 1 dBm	_____dBm	- 4 dBm	_____dBm
+ 2 dBm	_____dBm	- 2 dBm	_____dBm	- 5 dBm	_____dBm
+ 1 dBm	_____dBm	- 3 dBm	_____dBm	- 6 dBm	_____dBm
* Specification is ±1.0 dB.		* Specification is ±1.0 dB.		* Specification is ±1.0 dB.	
Power Level Flatness (Step Sweep)					
Set Power	Max Power	Min Power	Variation **		
+ 6 dBm	_____dBm	_____dBm	_____dB		
** Maximum variation is 1.6 dB.					
Power Level Flatness (Analog Sweep)(Model 68355B only)					
Set Power	Max Power	Min Power	Variation ***		
+ 6 dBm	_____dBm	_____dBm	_____dB		
*** Maximum variation is 2.0 dB (0.5 to 20 GHz); 4.0 dB (20 to 26.5 GHz)(typical, not a specification).					

OPERATION VERIFICATION

POWER LEVEL ACCURACY AND FLATNESS TESTS

Table 5-3. Power Level Accuracy and Flatness Test Record (18 of 46)

Model 68_55B		Serial No. _____		Date _____	
Model 68255B/68355B (with Option 2A Step Attenuator)					
Power Level Accuracy * (CW Frequency = 1.0 GHz)		Power Level Accuracy * (CW Frequency = 5.0 GHz)		Power Level Accuracy * (CW Frequency = 22.0 GHz)	
Set Power	Measured Power	Set Power	Measured Power	Set Power	Measured Power
+11 dBm	_____dBm	+ 7 dBm	_____dBm	+ 3.5 dBm	_____dBm
+10 dBm	_____dBm	+ 6 dBm	_____dBm	+ 2.5 dBm	_____dBm
+ 9 dBm	_____dBm	+ 5 dBm	_____dBm	+ 1.5 dBm	_____dBm
+ 8 dBm	_____dBm	+ 4 dBm	_____dBm	+ 0.5 dBm	_____dBm
+ 7 dBm	_____dBm	+ 3 dBm	_____dBm	- 0.5 dBm	_____dBm
+ 6 dBm	_____dBm	+ 2 dBm	_____dBm	- 1.5 dBm	_____dBm
+ 5 dBm	_____dBm	+ 1 dBm	_____dBm	- 2.5 dBm	_____dBm
+ 4 dBm	_____dBm	+ 0 dBm	_____dBm	- 3.5 dBm	_____dBm
+ 3 dBm	_____dBm	- 1 dBm	_____dBm	- 4.5 dBm	_____dBm
+ 2 dBm	_____dBm	- 2 dBm	_____dBm	- 5.5 dBm	_____dBm
+ 1 dBm	_____dBm	- 3 dBm	_____dBm	- 6.5 dBm	_____dBm
+ 0 dBm	_____dBm	- 4 dBm	_____dBm	- 7.5 dBm	_____dBm
- 1 dBm	_____dBm	- 5 dBm	_____dBm	- 8.5 dBm	_____dBm
* Specification is ± 1.0 dB.		* Specification is ± 1.0 dB.		* Specification is ± 1.0 dB.	

Power Level Flatness (Step Sweep)

Set Power	Max Power	Min Power	Variation **
+ 3.5 dBm	_____dBm	_____dBm	_____dB

** Maximum variation is 1.6 dB.

Power Level Flatness (Analog Sweep)(Model 68355B only)

Set Power	Max Power	Min Power	Variation ***
+ 3.5 dBm	_____dBm	_____dBm	_____dB

*** Maximum variation is 6.0 dB (0.5 to 20 GHz); 8.2 dB (20 to 26.5 GHz)(typical, not a specification).

Table 5-3. Power Level Accuracy and Flatness Test Record (19 of 46)

Model 68_55B w/Option 15B		Serial No. _____		Date _____	
Model 68255B/68355B with Option 15B High Power (without Option 2A Step Attenuator)					
Power Level Accuracy * (CW Frequency = 1.0 GHz)		Power Level Accuracy * (CW Frequency = 5.0 GHz)		Power Level Accuracy * (CW Frequency = 22.0 GHz)	
Set Power	Measured Power	Set Power	Measured Power	Set Power	Measured Power
+13 dBm	_____dBm	+13 dBm	_____dBm	+10 dBm	_____dBm
+12 dBm	_____dBm	+12 dBm	_____dBm	+ 9 dBm	_____dBm
+11 dBm	_____dBm	+11 dBm	_____dBm	+ 8 dBm	_____dBm
+10 dBm	_____dBm	+10 dBm	_____dBm	+ 7 dBm	_____dBm
+ 9 dBm	_____dBm	+ 9 dBm	_____dBm	+ 6 dBm	_____dBm
+ 8 dBm	_____dBm	+ 8 dBm	_____dBm	+ 5 dBm	_____dBm
+ 7 dBm	_____dBm	+ 7 dBm	_____dBm	+ 4 dBm	_____dBm
+ 6 dBm	_____dBm	+ 6 dBm	_____dBm	+ 3 dBm	_____dBm
+ 5 dBm	_____dBm	+ 5 dBm	_____dBm	+ 2 dBm	_____dBm
+ 4 dBm	_____dBm	+ 4 dBm	_____dBm	+ 1 dBm	_____dBm
+ 3 dBm	_____dBm	+ 3 dBm	_____dBm	+ 0 dBm	_____dBm
+ 2 dBm	_____dBm	+ 2 dBm	_____dBm	- 1 dBm	_____dBm
+ 1 dBm	_____dBm	+ 1 dBm	_____dBm	- 2 dBm	_____dBm
* Specification is ±1.0 dB.		* Specification is ±1.0 dB.		* Specification is ±1.0 dB.	
Power Level Flatness (Step Sweep)					
Set Power	Max Power	Min Power	Variation **		
+ 10 dBm	_____dBm	_____dBm	_____dB		
** Maximum variation is 1.6 dB.					
Power Level Flatness (Analog Sweep)(Model 68355B only)					
Set Power	Max Power	Min Power	Variation ***		
+ 10 dBm	_____dBm	_____dBm	_____dB		
*** Maximum variation is 2.0 dB (0.5 to 20 GHz); 4.0 dB (20 to 26.5 GHz)(typical, not a specification).					

OPERATION VERIFICATION

POWER LEVEL ACCURACY AND FLATNESS TESTS

Table 5-3. Power Level Accuracy and Flatness Test Record (20 of 46)

Model 68_55B w/Option 15B		Serial No. _____		Date _____	
Model 68255B/68355B with Option 15B High Power (with Option 2A Step Attenuator)					
Power Level Accuracy * (CW Frequency = 1.0 GHz)		Power Level Accuracy * (CW Frequency = 5.0 GHz)		Power Level Accuracy * (CW Frequency = 22.0 GHz)	
Set Power	Measured Power	Set Power	Measured Power	Set Power	Measured Power
+11 dBm	_____dBm	+11 dBm	_____dBm	+ 7.5 dBm	_____dBm
+10 dBm	_____dBm	+10 dBm	_____dBm	+ 6.5 dBm	_____dBm
+ 9 dBm	_____dBm	+ 9 dBm	_____dBm	+ 5.5 dBm	_____dBm
+ 8 dBm	_____dBm	+ 8 dBm	_____dBm	+ 4.5 dBm	_____dBm
+ 7 dBm	_____dBm	+ 7 dBm	_____dBm	+ 3.5 dBm	_____dBm
+ 6 dBm	_____dBm	+ 6 dBm	_____dBm	+ 2.5 dBm	_____dBm
+ 5 dBm	_____dBm	+ 5 dBm	_____dBm	+ 1.5 dBm	_____dBm
+ 4 dBm	_____dBm	+ 4 dBm	_____dBm	+ 0.5 dBm	_____dBm
+ 3 dBm	_____dBm	+ 3 dBm	_____dBm	- 0.5 dBm	_____dBm
+ 2 dBm	_____dBm	+ 2 dBm	_____dBm	- 1.5 dBm	_____dBm
+ 1 dBm	_____dBm	+ 1 dBm	_____dBm	- 2.5 dBm	_____dBm
+ 0 dBm	_____dBm	+ 0 dBm	_____dBm	- 3.5 dBm	_____dBm
- 1 dBm	_____dBm	- 1 dBm	_____dBm	- 4.5 dBm	_____dBm
* Specification is ±1.0 dB.		* Specification is ±1.0 dB.		* Specification is ±1.0 dB.	
Power Level Flatness (Step Sweep)					
Set Power	Max Power	Min Power	Variation **		
+ 7.5 dBm	_____dBm	_____dBm	_____dB		
** Maximum variation is 1.6 dB.					
Power Level Flatness (Analog Sweep)(Model 68355B only)					
Set Power	Max Power	Min Power	Variation ***		
+ 7.5 dBm	_____dBm	_____dBm	_____dB		
*** Maximum variation is 6.0 dB (0.5 to 20 GHz); 8.2 dB (20 to 26.5 GHz)(typical, not a specification).					

OPERATION VERIFICATION

POWER LEVEL ACCURACY AND FLATNESS TESTS

Table 5-3. Power Level Accuracy and Flatness Test Record (21 of 46)

Model 68_59B		Serial No. _____		Date _____	
Model 68259B/68359B (without Option 2A Step Attenuator)					
Power Level Accuracy * (CW Frequency = 1.0 GHz)		Power Level Accuracy * (CW Frequency = 5.0 GHz)		Power Level Accuracy * (CW Frequency = 22.0 GHz)	
Set Power	Measured Power	Set Power	Measured Power	Set Power	Measured Power
+13 dBm	_____dBm	+ 9 dBm	_____dBm	+ 6 dBm	_____dBm
+12 dBm	_____dBm	+ 8 dBm	_____dBm	+ 5 dBm	_____dBm
+11 dBm	_____dBm	+ 7 dBm	_____dBm	+ 4 dBm	_____dBm
+10 dBm	_____dBm	+ 6 dBm	_____dBm	+ 3 dBm	_____dBm
+ 9 dBm	_____dBm	+ 5 dBm	_____dBm	+ 2 dBm	_____dBm
+ 8 dBm	_____dBm	+ 4 dBm	_____dBm	+ 1 dBm	_____dBm
+ 7 dBm	_____dBm	+ 3 dBm	_____dBm	+ 0 dBm	_____dBm
+ 6 dBm	_____dBm	+ 2 dBm	_____dBm	- 1 dBm	_____dBm
+ 5 dBm	_____dBm	+ 1 dBm	_____dBm	- 2 dBm	_____dBm
+ 4 dBm	_____dBm	+ 0 dBm	_____dBm	- 3 dBm	_____dBm
+ 3 dBm	_____dBm	- 1 dBm	_____dBm	- 4 dBm	_____dBm
+ 2 dBm	_____dBm	- 2 dBm	_____dBm	- 5 dBm	_____dBm
+ 1 dBm	_____dBm	- 3 dBm	_____dBm	- 6 dBm	_____dBm
* Specification is ±1.0 dB.		* Specification is ±1.0 dB.		* Specification is ±1.0 dB.	
Power Level Flatness (Step Sweep)					
Set Power	Max Power	Min Power	Variation **		
+ 6 dBm	_____dBm	_____dBm	_____dB		
** Maximum variation is 4.0 dB (0.01 to 0.05 GHz); 1.6 dB (0.05 to 26.5 GHz).					
Power Level Flatness (Analog Sweep)(Model 68359B only)					
Set Power	Max Power	Min Power	Variation ***		
+ 6 dBm	_____dBm	_____dBm	_____dB		
*** Maximum variation is 4.0 dB (0.01 to 0.05 GHz) 2.0 dB (0.05 to 20 GHz); 4.0 dB (20 to 26.5 GHz)(typical, not a specification).					

Table 5-3. Power Level Accuracy and Flatness Test Record (22 of 46)

Model 68_59B		Serial No. _____		Date _____	
Model 68259B/68359B (with Option 2A Step Attenuator)					
Power Level Accuracy * (CW Frequency = 1.0 GHz)		Power Level Accuracy * (CW Frequency = 5.0 GHz)		Power Level Accuracy * (CW Frequency = 22.0 GHz)	
Set Power	Measured Power	Set Power	Measured Power	Set Power	Measured Power
+11 dBm	_____dBm	+ 7 dBm	_____dBm	+ 3.5 dBm	_____dBm
+10 dBm	_____dBm	+ 6 dBm	_____dBm	+ 2.5 dBm	_____dBm
+ 9 dBm	_____dBm	+ 5 dBm	_____dBm	+ 1.5 dBm	_____dBm
+ 8 dBm	_____dBm	+ 4 dBm	_____dBm	+ 0.5 dBm	_____dBm
+ 7 dBm	_____dBm	+ 3 dBm	_____dBm	- 0.5 dBm	_____dBm
+ 6 dBm	_____dBm	+ 2 dBm	_____dBm	- 1.5 dBm	_____dBm
+ 5 dBm	_____dBm	+ 1 dBm	_____dBm	- 2.5 dBm	_____dBm
+ 4 dBm	_____dBm	+ 0 dBm	_____dBm	- 3.5 dBm	_____dBm
+ 3 dBm	_____dBm	- 1 dBm	_____dBm	- 4.5 dBm	_____dBm
+ 2 dBm	_____dBm	- 2 dBm	_____dBm	- 5.5 dBm	_____dBm
+ 1 dBm	_____dBm	- 3 dBm	_____dBm	- 6.5 dBm	_____dBm
+ 0 dBm	_____dBm	- 4 dBm	_____dBm	- 7.5 dBm	_____dBm
- 1 dBm	_____dBm	- 5 dBm	_____dBm	- 8.5 dBm	_____dBm

* Specification is ±1.0 dB.

* Specification is ±1.0 dB.

* Specification is ±1.0 dB.

Power Level Flatness (Step Sweep)

Set Power	Max Power	Min Power	Variation **
+ 3.5 dBm	_____dBm	_____dBm	_____dB

** Maximum variation is 4.0 dB (0.01 to 0.05 GHz); 1.6 dB (0.05 to 26.5 GHz).

Power Level Flatness (Analog Sweep)(Model 68359B only)

Set Power	Max Power	Min Power	Variation ***
+ 3.5 dBm	_____dBm	_____dBm	_____dB

*** Maximum variation is 7.0 dB (0.01 to 0.05 GHz); 6.0 dB (0.05 to 20 GHz); 8.2 dB (20 to 26.5 GHz)(typical, not a specification).

Table 5-3. Power Level Accuracy and Flatness Test Record (24 of 46)

Model 68_59B w/Option 15B **Serial No.** _____ **Date** _____

**Model 68259B/68359B with Option 15B High Power
(with Option 2A Step Attenuator)**

Power Level Accuracy * (CW Frequency = 1.0 GHz)		Power Level Accuracy * (CW Frequency = 5.0 GHz)		Power Level Accuracy * (CW Frequency = 22.0 GHz)	
Set Power	Measured Power	Set Power	Measured Power	Set Power	Measured Power
+11 dBm	_____dBm	+11 dBm	_____dBm	+ 7.5 dBm	_____dBm
+10 dBm	_____dBm	+10 dBm	_____dBm	+ 6.5 dBm	_____dBm
+ 9 dBm	_____dBm	+ 9 dBm	_____dBm	+ 5.5 dBm	_____dBm
+ 8 dBm	_____dBm	+ 8 dBm	_____dBm	+ 4.5 dBm	_____dBm
+ 7 dBm	_____dBm	+ 7 dBm	_____dBm	+ 3.5 dBm	_____dBm
+ 6 dBm	_____dBm	+ 6 dBm	_____dBm	+ 2.5 dBm	_____dBm
+ 5 dBm	_____dBm	+ 5 dBm	_____dBm	+ 1.5 dBm	_____dBm
+ 4 dBm	_____dBm	+ 4 dBm	_____dBm	+ 0.5 dBm	_____dBm
+ 3 dBm	_____dBm	+ 3 dBm	_____dBm	- 0.5 dBm	_____dBm
+ 2 dBm	_____dBm	+ 2 dBm	_____dBm	- 1.5 dBm	_____dBm
+ 1 dBm	_____dBm	+ 1 dBm	_____dBm	- 2.5 dBm	_____dBm
+ 0 dBm	_____dBm	+ 0 dBm	_____dBm	- 3.5 dBm	_____dBm
- 1 dBm	_____dBm	- 1 dBm	_____dBm	- 4.5 dBm	_____dBm

* Specification is ±1.0 dB.

* Specification is ±1.0 dB.

* Specification is ±1.0 dB.

Power Level Flatness (Step Sweep)

Set Power	Max Power	Min Power	Variation **
+ 7.5 dBm	_____dBm	_____dBm	_____dB

** Maximum variation is 4.0 dB (0.01 to 0.05 GHz); 1.6 dB (0.05 to 26.5 GHz).

Power Level Flatness (Analog Sweep)(Model 68359B only)

Set Power	Max Power	Min Power	Variation ***
+ 7.5 dBm	_____dBm	_____dBm	_____dB

*** Maximum variation is 7.0 dB (0.01 to 0.05 GHz); 6.0 dB (0.05 to 20 GHz); 8.2 dB (20 to 26.5 GHz)(typical, not a specification).

Table 5-3. Power Level Accuracy and Flatness Test Record (25 of 46)

Model 68_63B	Serial No. _____	Date _____
Model 68263B/68363B (without Option 2B Step Attenuator)		
Power Level Accuracy * (CW Frequency = 5.0 GHz)		Power Level Accuracy * (CW Frequency = 25.0 GHz)
Set Power	Measured Power	Set Power
Measured Power		Measured Power
+ 9 dBm	_____dBm	+ 6 dBm
+ 8 dBm	_____dBm	+ 5 dBm
+ 7 dBm	_____dBm	+ 4 dBm
+ 6 dBm	_____dBm	+ 3 dBm
+ 5 dBm	_____dBm	+ 2dBm
+ 4 dBm	_____dBm	+ 1 dBm
+ 3 dBm	_____dBm	+ 0 dBm
+ 2 dBm	_____dBm	- 1 dBm
+ 1 dBm	_____dBm	- 2 dBm
+ 0 dBm	_____dBm	- 3 dBm
- 1 dBm	_____dBm	- 4 dBm
- 2 dBm	_____dBm	- 5 dBm
- 3 dBm	_____dBm	- 6 dBm
* Specification is ± 1.0 dB.		* Specification is ± 1.0 dB.

Power Level Flatness (Step Sweep)

Set Power	Max Power	Min Power	Variation **
+ 6 dBm	_____dBm	_____dBm	_____dB

** Maximum variation is 1.6 dB.

Power Level Flatness (Analog Sweep)(Model 68363B only)

Set Power	Max Power	Min Power	Variation ***
+ 6 dBm	_____dBm	_____dBm	_____dB

*** Maximum variation is 2.0 dB (2 to 20 GHz); 4.0 dB (20 to 40 GHz)(typical, not a specification).

OPERATION VERIFICATION

POWER LEVEL ACCURACY AND FLATNESS TESTS

Table 5-3. Power Level Accuracy and Flatness Test Record (26 of 46)

Model 68_63B		Serial No. _____		Date _____	
Model 68263B/68363B (with Option 2B Step Attenuator)					
Power Level Accuracy * (CW Frequency = 5.0 GHz)			Power Level Accuracy * (CW Frequency = 25.0 GHz)		
Set Power	Measured Power	Set Power	Measured Power		
+ 7 dBm	_____dBm	+ 3 dBm	_____dBm		
+ 6 dBm	_____dBm	+ 2 dBm	_____dBm		
+ 5 dBm	_____dBm	+ 1 dBm	_____dBm		
+ 4 dBm	_____dBm	+ 0 dBm	_____dBm		
+ 3 dBm	_____dBm	- 1 dBm	_____dBm		
+ 2 dBm	_____dBm	- 2 dBm	_____dBm		
+ 1 dBm	_____dBm	- 3 dBm	_____dBm		
+ 0 dBm	_____dBm	- 4 dBm	_____dBm		
- 1 dBm	_____dBm	- 5 dBm	_____dBm		
- 2 dBm	_____dBm	- 6 dBm	_____dBm		
- 3 dBm	_____dBm	- 7 dBm	_____dBm		
- 4 dBm	_____dBm	- 8 dBm	_____dBm		
- 5 dBm	_____dBm	- 9 dBm	_____dBm		
	* Specification is ± 1.0 dB.		* Specification is ± 1.0 dB.		
Power Level Flatness (Step Sweep)					
Set Power	Max Power	Min Power	Variation **		
+ 3 dBm	_____dBm	_____dBm	_____dB		
** Maximum variation is 1.6 dB.					
Power Level Flatness (Analog Sweep)(Model 68363B only)					
Set Power	Max Power	Min Power	Variation ***		
+ 3 dBm	_____dBm	_____dBm	_____dB		
*** Maximum variation is 6.0 dB (2 to 20 GHz); 8.2 dB (20 to 40 GHz)(typical, not a specification).					

Table 5-3. Power Level Accuracy and Flatness Test Record (27 of 46)

Model 68_63B w/Option 15B		Serial No. _____		Date _____	
Model 68263B/68363B with Option 15B High Power (without Option 2B Step Attenuator)					
Power Level Accuracy * (CW Frequency = 5.0 GHz)			Power Level Accuracy * (CW Frequency = 25.0 GHz)		
Set Power	Measured Power	Set Power	Measured Power		
+13 dBm	_____dBm	+ 6 dBm	_____dBm		
+12 dBm	_____dBm	+ 5 dBm	_____dBm		
+11 dBm	_____dBm	+ 4 dBm	_____dBm		
+10 dBm	_____dBm	+ 3 dBm	_____dBm		
+ 9 dBm	_____dBm	+ 2 dBm	_____dBm		
+ 8 dBm	_____dBm	+ 1 dBm	_____dBm		
+ 7 dBm	_____dBm	+ 0 dBm	_____dBm		
+ 6 dBm	_____dBm	- 1 dBm	_____dBm		
+ 5 dBm	_____dBm	- 2 dBm	_____dBm		
+ 4 dBm	_____dBm	- 3 dBm	_____dBm		
+ 3 dBm	_____dBm	- 4 dBm	_____dBm		
+ 2 dBm	_____dBm	- 5 dBm	_____dBm		
+ 1 dBm	_____dBm	- 6 dBm	_____dBm		
* Specification is ± 1.0 dB.			* Specification is ± 1.0 dB.		
Power Level Flatness (Step Sweep)					
Set Power	Max Power	Min Power	Variation **		
+ 6 dBm	_____dBm	_____dBm	_____dB		
** Maximum variation is 1.6 dB.					
Power Level Flatness (Analog Sweep)(Model 68363B only)					
Set Power	Max Power	Min Power	Variation ***		
+ 6 dBm	_____dBm	_____dBm	_____dB		
*** Maximum variation is 2.0 dB (2 to 20 GHz); 4.0 dB (20 to 40 GHz)(typical, not a specification).					

OPERATION VERIFICATION

POWER LEVEL ACCURACY AND FLATNESS TESTS

Table 5-3. Power Level Accuracy and Flatness Test Record (28 of 46)

Model 68_63B w/Option 15B Serial No. _____ Date _____

**Model 68263B/68363B with Option 15B High Power
(with Option 2B Step Attenuator)**

Power Level Accuracy *		Power Level Accuracy *	
(CW Frequency = 5.0 GHz)		(CW Frequency = 25.0 GHz)	
Set Power	Measured Power	Set Power	Measured Power
+11 dBm	_____dBm	+ 3 dBm	_____dBm
+10 dBm	_____dBm	+ 2 dBm	_____dBm
+ 9 dBm	_____dBm	+ 1 dBm	_____dBm
+ 8 dBm	_____dBm	+ 0 dBm	_____dBm
+ 7 dBm	_____dBm	- 1 dBm	_____dBm
+ 6 dBm	_____dBm	- 2 dBm	_____dBm
+ 5 dBm	_____dBm	- 3 dBm	_____dBm
+ 4 dBm	_____dBm	- 4 dBm	_____dBm
+ 3 dBm	_____dBm	- 5 dBm	_____dBm
+ 2 dBm	_____dBm	- 6 dBm	_____dBm
+ 1 dBm	_____dBm	- 7 dBm	_____dBm
+ 0 dBm	_____dBm	- 8 dBm	_____dBm
- 1 dBm	_____dBm	- 9 dBm	_____dBm

* Specification is ± 1.0 dB.

* Specification is ± 1.0 dB.

Power Level Flatness (Step Sweep)

Set Power	Max Power	Min Power	Variation **
+ 3 dBm	_____dBm	_____dBm	_____dB

** Maximum variation is 1.6 dB.

Power Level Flatness (Analog Sweep)(Model 68363B only)

Set Power	Max Power	Min Power	Variation ***
+ 3 dBm	_____dBm	_____dBm	_____dB

*** Maximum variation is 6.0 dB (2 to 20 GHz); 8.2 dB (20 to 40 GHz)(typical, not a specification).

**OPERATION
VERIFICATION**

**POWER LEVEL ACCURACY
AND FLATNESS TESTS**

Table 5-3. Power Level Accuracy and Flatness Test Record (29 of 46)

Model 68_65B		Serial No. _____		Date _____	
Model 68265B/68365B (without Option 2B Step Attenuator)					
Power Level Accuracy * (CW Frequency = 1.0 GHz)		Power Level Accuracy * (CW Frequency = 5.0 GHz)		Power Level Accuracy * (CW Frequency = 25.0 GHz)	
Set Power	Measured Power	Set Power	Measured Power	Set Power	Measured Power
+13 dBm	_____dBm	+ 9 dBm	_____dBm	+ 6 dBm	_____dBm
+12 dBm	_____dBm	+ 8 dBm	_____dBm	+ 5 dBm	_____dBm
+11 dBm	_____dBm	+ 7 dBm	_____dBm	+ 4 dBm	_____dBm
+10 dBm	_____dBm	+ 6 dBm	_____dBm	+ 3 dBm	_____dBm
+ 9 dBm	_____dBm	+ 5 dBm	_____dBm	+ 2 dBm	_____dBm
+ 8 dBm	_____dBm	+ 4 dBm	_____dBm	+ 1 dBm	_____dBm
+ 7 dBm	_____dBm	+ 3 dBm	_____dBm	+ 0 dBm	_____dBm
+ 6 dBm	_____dBm	+ 2 dBm	_____dBm	- 1 dBm	_____dBm
+ 5 dBm	_____dBm	+ 1 dBm	_____dBm	- 2 dBm	_____dBm
+ 4 dBm	_____dBm	+ 0 dBm	_____dBm	- 3 dBm	_____dBm
+ 3 dBm	_____dBm	- 1 dBm	_____dBm	- 4 dBm	_____dBm
+ 2 dBm	_____dBm	- 2 dBm	_____dBm	- 5 dBm	_____dBm
+ 1 dBm	_____dBm	- 3 dBm	_____dBm	- 6 dBm	_____dBm
* Specification is ±1.0 dB.		* Specification is ±1.0 dB.		* Specification is ±1.0 dB.	
Power Level Flatness (Step Sweep)					
Set Power	Max Power	Min Power	Variation **		
+ 6 dBm	_____dBm	_____dBm	_____dB		
** Maximum variation is 1.6 dB.					
Power Level Flatness (Analog Sweep)(Model 68365B only)					
Set Power	Max Power	Min Power	Variation ***		
+ 6 dBm	_____dBm	_____dBm	_____dB		
*** Maximum variation is 2.0 dB (0.5 to 20 GHz); 4.0 dB (20 to 40 GHz)(typical, not a specification).					

OPERATION VERIFICATION

POWER LEVEL ACCURACY AND FLATNESS TESTS

Table 5-3. Power Level Accuracy and Flatness Test Record (30 of 46)

Model 68_65B		Serial No. _____		Date _____	
Model 68265B/68365B (with Option 2B Step Attenuator)					
Power Level Accuracy * (CW Frequency = 1.0 GHz)		Power Level Accuracy * (CW Frequency = 5.0 GHz)		Power Level Accuracy * (CW Frequency = 25.0 GHz)	
Set Power	Measured Power	Set Power	Measured Power	Set Power	Measured Power
+11 dBm	_____dBm	+ 7 dBm	_____dBm	+ 3 dBm	_____dBm
+10 dBm	_____dBm	+ 6 dBm	_____dBm	+ 2 dBm	_____dBm
+ 9 dBm	_____dBm	+ 5 dBm	_____dBm	+ 1 dBm	_____dBm
+ 8 dBm	_____dBm	+ 4 dBm	_____dBm	+ 0 dBm	_____dBm
+ 7 dBm	_____dBm	+ 3 dBm	_____dBm	- 1 dBm	_____dBm
+ 6 dBm	_____dBm	+ 2 dBm	_____dBm	- 2 dBm	_____dBm
+ 5 dBm	_____dBm	+ 1 dBm	_____dBm	- 3 dBm	_____dBm
+ 4 dBm	_____dBm	+ 0 dBm	_____dBm	- 4 dBm	_____dBm
+ 3 dBm	_____dBm	- 1 dBm	_____dBm	- 5 dBm	_____dBm
+ 2 dBm	_____dBm	- 2 dBm	_____dBm	- 6 dBm	_____dBm
+ 1 dBm	_____dBm	- 3 dBm	_____dBm	- 7 dBm	_____dBm
+ 0 dBm	_____dBm	- 4 dBm	_____dBm	- 8 dBm	_____dBm
- 1 dBm	_____dBm	- 5 dBm	_____dBm	- 9 dBm	_____dBm
* Specification is ±1.0 dB.		* Specification is ±1.0 dB.		* Specification is ±1.0 dB.	
Power Level Flatness (Step Sweep)					
Set Power	Max Power	Min Power	Variation **		
+ 3 dBm	_____dBm	_____dBm	_____dB		
** Maximum variation is 1.6 dB.					
Power Level Flatness (Analog Sweep)(Model 68365B only)					
Set Power	Max Power	Min Power	Variation ***		
+ 3 dBm	_____dBm	_____dBm	_____dB		
*** Maximum variation is 6.0 dB (0.5 to 20 GHz) 8.2 dB (20 to 40 GHz)(typical, not a specification).					

Table 5-3. Power Level Accuracy and Flatness Test Record (31 of 46)

Model 68_65B w/Option 15B		Serial No. _____		Date _____	
Model 68265B/68365B with Option 15B High Power (without Option 2B Step Attenuator)					
Power Level Accuracy * (CW Frequency = 1.0 GHz)		Power Level Accuracy * (CW Frequency = 5.0 GHz)		Power Level Accuracy * (CW Frequency = 25.0 GHz)	
Set Power	Measured Power	Set Power	Measured Power	Set Power	Measured Power
+13 dBm	_____dBm	+13 dBm	_____dBm	+ 6 dBm	_____dBm
+12 dBm	_____dBm	+12 dBm	_____dBm	+ 5 dBm	_____dBm
+11 dBm	_____dBm	+11 dBm	_____dBm	+ 4 dBm	_____dBm
+10 dBm	_____dBm	+10 dBm	_____dBm	+ 3 dBm	_____dBm
+ 9 dBm	_____dBm	+ 9 dBm	_____dBm	+ 2 dBm	_____dBm
+ 8 dBm	_____dBm	+ 8 dBm	_____dBm	+ 1 dBm	_____dBm
+ 7 dBm	_____dBm	+ 7 dBm	_____dBm	+ 0 dBm	_____dBm
+ 6 dBm	_____dBm	+ 6 dBm	_____dBm	- 1 dBm	_____dBm
+ 5 dBm	_____dBm	+ 5 dBm	_____dBm	- 2 dBm	_____dBm
+ 4 dBm	_____dBm	+ 4 dBm	_____dBm	- 3 dBm	_____dBm
+ 3 dBm	_____dBm	+ 3 dBm	_____dBm	- 4 dBm	_____dBm
+ 2 dBm	_____dBm	+ 2 dBm	_____dBm	- 5 dBm	_____dBm
+ 1 dBm	_____dBm	+ 1 dBm	_____dBm	- 6 dBm	_____dBm
* Specification is ± 1.0 dB.		* Specification is ± 1.0 dB.		* Specification is ± 1.0 dB.	

Power Level Flatness (Step Sweep)

Set Power	Max Power	Min Power	Variation **
+ 6 dBm	_____dBm	_____dBm	_____dB

** Maximum variation is 1.6 dB.

Power Level Flatness (Analog Sweep)(Model 68365B only)

Set Power	Max Power	Min Power	Variation ***
+ 6 dBm	_____dBm	_____dBm	_____dB

*** Maximum variation is 2.0 dB (0.5 to 20 GHz); 4.0 dB (20 to 40 GHz)(typical, not a specification).

OPERATION VERIFICATION

POWER LEVEL ACCURACY AND FLATNESS TESTS

Table 5-3. Power Level Accuracy and Flatness Test Record (32 of 46)

Model 68_65B w/Option 15B		Serial No. _____		Date _____	
Model 68265B/68365B with Option 15B High Power (with Option 2B Step Attenuator)					
Power Level Accuracy * (CW Frequency = 1.0 GHz)		Power Level Accuracy * (CW Frequency = 5.0 GHz)		Power Level Accuracy * (CW Frequency = 25.0 GHz)	
Set Power	Measured Power	Set Power	Measured Power	Set Power	Measured Power
+11 dBm	_____dBm	+11 dBm	_____dBm	+ 3 dBm	_____dBm
+10 dBm	_____dBm	+10 dBm	_____dBm	+ 2 dBm	_____dBm
+ 9 dBm	_____dBm	+ 9 dBm	_____dBm	+ 1 dBm	_____dBm
+ 8 dBm	_____dBm	+ 8 dBm	_____dBm	+ 0 dBm	_____dBm
+ 7 dBm	_____dBm	+ 7 dBm	_____dBm	- 1 dBm	_____dBm
+ 6 dBm	_____dBm	+ 6 dBm	_____dBm	- 2 dBm	_____dBm
+ 5 dBm	_____dBm	+ 5 dBm	_____dBm	- 3 dBm	_____dBm
+ 4 dBm	_____dBm	+ 4 dBm	_____dBm	- 4 dBm	_____dBm
+ 3 dBm	_____dBm	+ 3 dBm	_____dBm	- 5 dBm	_____dBm
+ 2 dBm	_____dBm	+ 2 dBm	_____dBm	- 6 dBm	_____dBm
+ 1 dBm	_____dBm	+ 1 dBm	_____dBm	- 7 dBm	_____dBm
+ 0 dBm	_____dBm	+ 0 dBm	_____dBm	- 8 dBm	_____dBm
- 1 dBm	_____dBm	- 1 dBm	_____dBm	- 9 dBm	_____dBm

* Specification is ± 1.0 dB. * Specification is ± 1.0 dB. * Specification is ± 1.0 dB.

Power Level Flatness (Step Sweep)

Set Power	Max Power	Min Power	Variation **
+ 3 dBm	_____dBm	_____dBm	_____dB

** Maximum variation is 1.6 dB.

Power Level Flatness (Analog Sweep)(Model 68365B only)

Set Power	Max Power	Min Power	Variation ***
+ 3 dBm	_____dBm	_____dBm	_____dB

*** Maximum variation is 6.0 dB (0.5 to 20 GHz); 8.2 dB (20 to 40 GHz)(typical, not a specification).

Table 5-3. Power Level Accuracy and Flatness Test Record (33 of 46)

Model 68_69B		Serial No. _____		Date _____	
Model 68269B/68369B (without Option 2B Step Attenuator)					
Power Level Accuracy * (CW Frequency = 1.0 GHz)		Power Level Accuracy * (CW Frequency = 5.0 GHz)		Power Level Accuracy * (CW Frequency = 25.0 GHz)	
Set Power	Measured Power	Set Power	Measured Power	Set Power	Measured Power
+13 dBm	_____dBm	+ 9 dBm	_____dBm	+ 6 dBm	_____dBm
+12 dBm	_____dBm	+ 8 dBm	_____dBm	+ 5 dBm	_____dBm
+11 dBm	_____dBm	+ 7 dBm	_____dBm	+ 4 dBm	_____dBm
+10 dBm	_____dBm	+ 6 dBm	_____dBm	+ 3 dBm	_____dBm
+ 9 dBm	_____dBm	+ 5 dBm	_____dBm	+ 2 dBm	_____dBm
+ 8 dBm	_____dBm	+ 4 dBm	_____dBm	+ 1 dBm	_____dBm
+ 7 dBm	_____dBm	+ 3 dBm	_____dBm	+ 0 dBm	_____dBm
+ 6 dBm	_____dBm	+ 2 dBm	_____dBm	- 1 dBm	_____dBm
+ 5 dBm	_____dBm	+ 1 dBm	_____dBm	- 2 dBm	_____dBm
+ 4 dBm	_____dBm	+ 0 dBm	_____dBm	- 3 dBm	_____dBm
+ 3 dBm	_____dBm	- 1 dBm	_____dBm	- 4 dBm	_____dBm
+ 2 dBm	_____dBm	- 2 dBm	_____dBm	- 5 dBm	_____dBm
+ 1 dBm	_____dBm	- 3 dBm	_____dBm	- 6 dBm	_____dBm
* Specification is ±1.0 dB.		* Specification is ±1.0 dB.		* Specification is ±1.0 dB.	

Power Level Flatness (Step Sweep)

Set Power	Max Power	Min Power	Variation **
+ 6 dBm	_____dBm	_____dBm	_____dB

** Maximum variation is 4.0 dB (0.01 to 0.05 GHz) 1.6 dB (0.05 to 40 GHz).

Power Level Flatness (Analog Sweep)(Model 68369B only)

Set Power	Max Power	Min Power	Variation ***
+ 6 dBm	_____dBm	_____dBm	_____dB

*** Maximum variation is 4.0 dB (0.01 to 0.05 GHz); 2.0 dB (0.05 to 20 GHz); 4.0 dB (20 to 40 GHz)(typical, not a specification).

Table 5-3. Power Level Accuracy and Flatness Test Record (34 of 46)

Model 68_69B		Serial No. _____		Date _____	
Model 68269B/68369B (with Option 2B Step Attenuator)					
Power Level Accuracy * (CW Frequency = 1.0 GHz)		Power Level Accuracy * (CW Frequency = 5.0 GHz)		Power Level Accuracy * (CW Frequency = 25.0 GHz)	
Set Power	Measured Power	Set Power	Measured Power	Set Power	Measured Power
+11 dBm	_____dBm	+ 7 dBm	_____dBm	+ 3 dBm	_____dBm
+10 dBm	_____dBm	+ 6 dBm	_____dBm	+ 2 dBm	_____dBm
+ 9 dBm	_____dBm	+ 5 dBm	_____dBm	+ 1 dBm	_____dBm
+ 8 dBm	_____dBm	+ 4 dBm	_____dBm	+ 0 dBm	_____dBm
+ 7 dBm	_____dBm	+ 3 dBm	_____dBm	- 1 dBm	_____dBm
+ 6 dBm	_____dBm	+ 2 dBm	_____dBm	- 2 dBm	_____dBm
+ 5 dBm	_____dBm	+ 1 dBm	_____dBm	- 3 dBm	_____dBm
+ 4 dBm	_____dBm	+ 0 dBm	_____dBm	- 4 dBm	_____dBm
+ 3 dBm	_____dBm	- 1 dBm	_____dBm	- 5 dBm	_____dBm
+ 2 dBm	_____dBm	- 2 dBm	_____dBm	- 6 dBm	_____dBm
+ 1 dBm	_____dBm	- 3 dBm	_____dBm	- 7 dBm	_____dBm
+ 0 dBm	_____dBm	- 4 dBm	_____dBm	- 8 dBm	_____dBm
- 1 dBm	_____dBm	- 5 dBm	_____dBm	- 9 dBm	_____dBm
* Specification is ± 1.0 dB.		* Specification is ± 1.0 dB.		* Specification is ± 1.0 dB.	

Power Level Flatness (Step Sweep)

Set Power	Max Power	Min Power	Variation **
+ 3 dBm	_____dBm	_____dBm	_____dB

** Maximum variation is 4.0 dB (0.01 to 0.05 GHz) 1.6 dB (0.05 to 40 GHz).

Power Level Flatness (Analog Sweep)(Model 68369B only)

Set Power	Max Power	Min Power	Variation ***
+ 3 dBm	_____dBm	_____dBm	_____dB

*** Maximum variation is 7.0 dB (0.01 to 0.05 GHz); 6.0 dB (0.05 to 20 GHz) 8.2 dB (20 to 40 GHz)(typical, not a specification).

OPERATION VERIFICATION

POWER LEVEL ACCURACY AND FLATNESS TESTS

Table 5-3. Power Level Accuracy and Flatness Test Record (35 of 46)

Model 68_69B w/Option 15B		Serial No. _____		Date _____	
Model 68269B/68369B with Option 15B High Power (without Option 2B Step Attenuator)					
Power Level Accuracy * (CW Frequency = 1.0 GHz)		Power Level Accuracy * (CW Frequency = 5.0 GHz)		Power Level Accuracy * (CW Frequency = 25.0 GHz)	
Set Power	Measured Power	Set Power	Measured Power	Set Power	Measured Power
+13 dBm	_____dBm	+13 dBm	_____dBm	+ 6 dBm	_____dBm
+12 dBm	_____dBm	+12 dBm	_____dBm	+ 5 dBm	_____dBm
+11 dBm	_____dBm	+11 dBm	_____dBm	+ 4 dBm	_____dBm
+10 dBm	_____dBm	+10 dBm	_____dBm	+ 3 dBm	_____dBm
+ 9 dBm	_____dBm	+ 9 dBm	_____dBm	+ 2 dBm	_____dBm
+ 8 dBm	_____dBm	+ 8 dBm	_____dBm	+ 1 dBm	_____dBm
+ 7 dBm	_____dBm	+ 7 dBm	_____dBm	+ 0 dBm	_____dBm
+ 6 dBm	_____dBm	+ 6 dBm	_____dBm	- 1 dBm	_____dBm
+ 5 dBm	_____dBm	+ 5 dBm	_____dBm	- 2 dBm	_____dBm
+ 4 dBm	_____dBm	+ 4 dBm	_____dBm	- 3 dBm	_____dBm
+ 3 dBm	_____dBm	+ 3 dBm	_____dBm	- 4 dBm	_____dBm
+ 2 dBm	_____dBm	+ 2 dBm	_____dBm	- 5 dBm	_____dBm
+ 1 dBm	_____dBm	+ 1 dBm	_____dBm	- 6 dBm	_____dBm
* Specification is ±1.0 dB.		* Specification is ±1.0 dB.		* Specification is ±1.0 dB.	
Power Level Flatness (Step Sweep)					
Set Power	Max Power	Min Power	Variation **		
+ 6 dBm	_____dBm	_____dBm	_____dB		
** Maximum variation is 4.0 dB (0.01 to 0.05 GHz) 1.6 dB (0.05 to 40 GHz).					
Power Level Flatness (Analog Sweep)(Model 68369B only)					
Set Power	Max Power	Min Power	Variation ***		
+ 6 dBm	_____dBm	_____dBm	_____dB		
*** Maximum variation is 4.0 dB (0.01 to 0.05 GHz); 2.0 dB (0.05 to 20 GHz); 4.0 dB (20 to 40 GHz)(typical, not a specification).					

Table 5-3. Power Level Accuracy and Flatness Test Record (36 of 46)

Model 68_69B w/Option 15B **Serial No.** _____ **Date** _____

**Model 68269B/68369B with Option 15B High Power
(with Option 2B Step Attenuator)**

Power Level Accuracy * (CW Frequency = 1.0 GHz)		Power Level Accuracy * (CW Frequency = 5.0 GHz)		Power Level Accuracy * (CW Frequency = 25.0 GHz)	
Set Power	Measured Power	Set Power	Measured Power	Set Power	Measured Power
+11 dBm	_____dBm	+11 dBm	_____dBm	+ 3 dBm	_____dBm
+10 dBm	_____dBm	+10 dBm	_____dBm	+ 2 dBm	_____dBm
+ 9 dBm	_____dBm	+ 9 dBm	_____dBm	+ 1 dBm	_____dBm
+ 8 dBm	_____dBm	+ 8 dBm	_____dBm	+ 0 dBm	_____dBm
+ 7 dBm	_____dBm	+ 7 dBm	_____dBm	- 1 dBm	_____dBm
+ 6 dBm	_____dBm	+ 6 dBm	_____dBm	- 2 dBm	_____dBm
+ 5 dBm	_____dBm	+ 5 dBm	_____dBm	- 3 dBm	_____dBm
+ 4 dBm	_____dBm	+ 4 dBm	_____dBm	- 4 dBm	_____dBm
+ 3 dBm	_____dBm	+ 3 dBm	_____dBm	- 5 dBm	_____dBm
+ 2 dBm	_____dBm	+ 2 dBm	_____dBm	- 6 dBm	_____dBm
+ 1 dBm	_____dBm	+ 1 dBm	_____dBm	- 7 dBm	_____dBm
+ 0 dBm	_____dBm	+ 0 dBm	_____dBm	- 8 dBm	_____dBm
- 1 dBm	_____dBm	- 1 dBm	_____dBm	- 9 dBm	_____dBm

* Specification is ± 1.0 dB.

* Specification is ± 1.0 dB.

* Specification is ± 1.0 dB.

Power Level Flatness (Step Sweep)

Set Power	Max Power	Min Power	Variation **
+ 3 dBm	_____dBm	_____dBm	_____dB

** Maximum variation is 4.0 dB (0.01 to 0.05 GHz) 1.6 dB (0.05 to 40 GHz).

Power Level Flatness (Analog Sweep)(Model 68369B only)

Set Power	Max Power	Min Power	Variation ***
+ 3 dBm	_____dBm	_____dBm	_____dB

*** Maximum variation is 7.0 dB (0.01 to 0.05 GHz); 6.0 dB (0.05 to 20 GHz); 8.2 dB (20 to 40 GHz)(typical, not a specification).

OPERATION VERIFICATION

POWER LEVEL ACCURACY AND FLATNESS TESTS

Table 5-3. Power Level Accuracy and Flatness Test Record (37 of 46)

Model 68_75B		Serial No. _____		Date _____	
Model 68275B/68375B (without Option 2C Step Attenuator)					
Power Level Accuracy * (CW Frequency = 5.0 GHz)		Power Level Accuracy * (CW Frequency = 25.0 GHz)		Power Level Accuracy * (CW Frequency = 45.0 GHz)	
Set Power	Measured Power	Set Power	Measured Power	Set Power	Measured Power
+10 dBm	_____dBm	+ 2.5 dBm	_____dBm	+ 2.5 dBm	_____dBm
+ 9 dBm	_____dBm	+ 1.5 dBm	_____dBm	+ 1.5 dBm	_____dBm
+ 8 dBm	_____dBm	+ 0.5 dBm	_____dBm	+ 0.5 dBm	_____dBm
+ 7 dBm	_____dBm	- 0.5 dBm	_____dBm	- 0.5 dBm	_____dBm
+ 6 dBm	_____dBm	- 1.5 dBm	_____dBm	- 1.5 dBm	_____dBm
+ 5 dBm	_____dBm	- 2.5 dBm	_____dBm	- 2.5 dBm	_____dBm
+ 4 dBm	_____dBm	- 3.5 dBm	_____dBm	- 3.5 dBm	_____dBm
+ 3 dBm	_____dBm	- 4.5 dBm	_____dBm	- 4.5 dBm	_____dBm
+ 2 dBm	_____dBm	- 5.5 dBm	_____dBm	- 5.5 dBm	_____dBm
+ 1 dBm	_____dBm	- 6.5 dBm	_____dBm	- 6.5 dBm	_____dBm
+ 0 dBm	_____dBm	- 7.5 dBm	_____dBm	- 7.5 dBm	_____dBm
- 1 dBm	_____dBm	- 8.5 dBm	_____dBm	- 8.5 dBm	_____dBm
- 2 dBm	_____dBm	- 9.5 dBm	_____dBm	- 9.5 dBm	_____dBm
* Specification is ± 1.0 dB.		* Specification is ± 1.0 dB.		* Specification is ± 1.5 dB.	
Power Level Flatness (Step Sweep)					
Set Power	Max Power	Min Power	Variation **		
+ 2.5 dBm	_____dBm	_____dBm	_____dB		
** Maximum variation is 1.6 dB (0.5 to 40 GHz); 2.2 dB (40 to 50 GHz).					
Power Level Flatness (Analog Sweep)(Model 68375B only)					
Set Power	Max Power	Min Power	Variation ***		
+ 2.5 dBm	_____dBm	_____dBm	_____dB		
*** Maximum variation is 2.0 dB (0.5 to 20 GHz); 4.0 dB (20 to 40 GHz); 5.0 dB (40 to 50 GHz)(typical, not a specification).					

OPERATION VERIFICATION

POWER LEVEL ACCURACY AND FLATNESS TESTS

Table 5-3. Power Level Accuracy and Flatness Test Record (38 of 46)

Model 68_75B		Serial No. _____		Date _____	
Model 68275B/68375B (with Option 2C Step Attenuator)					
Power Level Accuracy * (CW Frequency = 5.0 GHz)		Power Level Accuracy * (CW Frequency = 25.0 GHz)		Power Level Accuracy * (CW Frequency = 45.0 GHz)	
Set Power	Measured Power	Set Power	Measured Power	Set Power	Measured Power
+ 8.5 dBm	_____dBm	+ 0 dBm	_____dBm	- 1 dBm	_____dBm
+ 7.5 dBm	_____dBm	- 1 dBm	_____dBm	- 2 dBm	_____dBm
+ 6.5 dBm	_____dBm	- 2 dBm	_____dBm	- 3 dBm	_____dBm
+ 5.5 dBm	_____dBm	- 3 dBm	_____dBm	- 4 dBm	_____dBm
+ 4.5 dBm	_____dBm	- 4 dBm	_____dBm	- 5 dBm	_____dBm
+ 3.5 dBm	_____dBm	- 5 dBm	_____dBm	- 6 dBm	_____dBm
+ 2.5 dBm	_____dBm	- 6 dBm	_____dBm	- 7 dBm	_____dBm
+ 1.5 dBm	_____dBm	- 7 dBm	_____dBm	- 8 dBm	_____dBm
+ 0.5 dBm	_____dBm	- 8 dBm	_____dBm	- 9 dBm	_____dBm
- 0.5 dBm	_____dBm	- 9 dBm	_____dBm	- 10 dBm	_____dBm
- 1.5 dBm	_____dBm	- 10 dBm	_____dBm	- 11 dBm	_____dBm
- 2.5 dBm	_____dBm	- 11 dBm	_____dBm	- 12 dBm	_____dBm
- 3.5 dBm	_____dBm	- 12 dBm	_____dBm	- 13 dBm	_____dBm
* Specification is ± 1.0 dB.		* Specification is ± 1.0 dB.		* Specification is ± 1.5 dB.	
Power Level Flatness (Step Sweep)					
Set Power	Max Power	Min Power	Variation **		
- 1 dBm	_____dBm	_____dBm	_____dB		
** Maximum variation is 1.6 dB (0.5 to 40 GHz); 2.2 dB (40 to 50 GHz).					
Power Level Flatness (Analog Sweep)(Model 68375B only)					
Set Power	Max Power	Min Power	Variation ***		
- 1 dBm	_____dBm	_____dBm	_____dB		
*** Maximum variation is 6.0 dB (0.5 to 20 GHz); 8.2 dB (20 to 40 GHz); 10.2 dB (40 to 50 GHz)(typical, not a specification).					

Table 5-3. Power Level Accuracy and Flatness Test Record (39 of 46)

Model 68_77B		Serial No. _____		Date _____	
Model 68277B/68377B (without Option 2C Step Attenuator)					
Power Level Accuracy * (CW Frequency = 5.0 GHz)		Power Level Accuracy * (CW Frequency = 25.0 GHz)		Power Level Accuracy * (CW Frequency = 45.0 GHz)	
Set Power	Measured Power	Set Power	Measured Power	Set Power	Measured Power
+10 dBm	_____dBm	+ 2.5 dBm	_____dBm	+ 2.5 dBm	_____dBm
+ 9 dBm	_____dBm	+ 1.5 dBm	_____dBm	+ 1.5 dBm	_____dBm
+ 8 dBm	_____dBm	+ 0.5 dBm	_____dBm	+ 0.5 dBm	_____dBm
+ 7 dBm	_____dBm	- 0.5 dBm	_____dBm	- 0.5 dBm	_____dBm
+ 6 dBm	_____dBm	- 1.5 dBm	_____dBm	- 1.5 dBm	_____dBm
+ 5 dBm	_____dBm	- 2.5 dBm	_____dBm	- 2.5 dBm	_____dBm
+ 4 dBm	_____dBm	- 3.5 dBm	_____dBm	- 3.5 dBm	_____dBm
+ 3 dBm	_____dBm	- 4.5 dBm	_____dBm	- 4.5 dBm	_____dBm
+ 2 dBm	_____dBm	- 5.5 dBm	_____dBm	- 5.5 dBm	_____dBm
+ 1 dBm	_____dBm	- 6.5 dBm	_____dBm	- 6.5 dBm	_____dBm
+ 0 dBm	_____dBm	- 7.5 dBm	_____dBm	- 7.5 dBm	_____dBm
- 1 dBm	_____dBm	- 8.5 dBm	_____dBm	- 8.5 dBm	_____dBm
- 2 dBm	_____dBm	- 9.5 dBm	_____dBm	- 9.5 dBm	_____dBm

* Specification is ±1.0 dB.

* Specification is ±1.0 dB.

* Specification is ±1.5 dB.

Power Level Flatness (Step Sweep)

Set Power	Max Power	Min Power	Variation **
+ 2.5 dBm	_____dBm	_____dBm	_____dB

** Maximum variation is 4.0 dB (0.01 to 0.05 GHz); 1.6 dB (0.05 to 40 GHz); 2.2 dB (40 to 50 GHz).

Power Level Flatness (Analog Sweep)(Model 68377B only)

Set Power	Max Power	Min Power	Variation ***
+ 2.5 dBm	_____dBm	_____dBm	_____dB

*** Maximum variation is 4.0 dB (0.01 to 0.05 GHz); 2.0 dB (0.05 to 20 GHz); 4.0 dB (20 to 40 GHz); 5.0 dB (40 to 50 GHz)(typical, not a specification).

OPERATION VERIFICATION

POWER LEVEL ACCURACY AND FLATNESS TESTS

Table 5-3. Power Level Accuracy and Flatness Test Record (40 of 46)

Model 68_77B		Serial No. _____		Date _____	
Model 68277B/68377B (with Option 2C Step Attenuator)					
Power Level Accuracy * (CW Frequency = 5.0 GHz)		Power Level Accuracy * (CW Frequency = 25.0 GHz)		Power Level Accuracy * (CW Frequency = 45.0 GHz)	
Set Power	Measured Power	Set Power	Measured Power	Set Power	Measured Power
+ 8.5 dBm	_____dBm	+ 0 dBm	_____dBm	- 1 dBm	_____dBm
+ 7.5 dBm	_____dBm	- 1 dBm	_____dBm	- 2 dBm	_____dBm
+ 6.5 dBm	_____dBm	- 2 dBm	_____dBm	- 3 dBm	_____dBm
+ 5.5 dBm	_____dBm	- 3 dBm	_____dBm	- 4 dBm	_____dBm
+ 4.5 dBm	_____dBm	- 4 dBm	_____dBm	- 5 dBm	_____dBm
+ 3.5 dBm	_____dBm	- 5 dBm	_____dBm	- 6 dBm	_____dBm
+ 2.5 dBm	_____dBm	- 6 dBm	_____dBm	- 7 dBm	_____dBm
+ 1.5 dBm	_____dBm	- 7 dBm	_____dBm	- 8 dBm	_____dBm
+ 0.5 dBm	_____dBm	- 8 dBm	_____dBm	- 9 dBm	_____dBm
- 0.5 dBm	_____dBm	- 9 dBm	_____dBm	- 10 dBm	_____dBm
- 1.5 dBm	_____dBm	- 10 dBm	_____dBm	- 11 dBm	_____dBm
- 2.5 dBm	_____dBm	- 11 dBm	_____dBm	- 12 dBm	_____dBm
- 3.5 dBm	_____dBm	- 12 dBm	_____dBm	- 13 dBm	_____dBm
* Specification is ± 1.0 dB.		* Specification is ± 1.0 dB.		* Specification is ± 1.5 dB.	

Power Level Flatness (Step Sweep)

Set Power	Max Power	Min Power	Variation **
- 1 dBm	_____dBm	_____dBm	_____dB

** Maximum variation is 4.0 dB (0.01 to 0.05 GHz); 1.6 dB (0.05 to 40 GHz); 2.2 dB (40 to 50 GHz).

Power Level Flatness (Analog Sweep)(Model 68377B only)

Set Power	Max Power	Min Power	Variation ***
- 1 dBm	_____dBm	_____dBm	_____dB

*** Maximum variation is 7.0 dB (0.01 to 0.05 GHz); 6.0 dB (0.05 to 20 GHz); 8.2 dB (20 to 40 GHz); 10.2 dB (40 to 50 GHz)(typical, not a specification).

Table 5-3. Power Level Accuracy and Flatness Test Record (41 of 46)

Model 68_85B		Serial No. _____		Date _____	
Model 68285B / 68385B (without Option 2D Step Attenuator)					
Power Level Accuracy * (CW Frequency = 5.0 GHz)		Power Level Accuracy * (CW Frequency = 25.0 GHz)		Power Level Accuracy * (CW Frequency = 50.0 GHz)	
Set Power	Measured Power	Set Power	Measured Power	Set Power	Measured Power
+10 dBm	_____dBm	+ 2.5 dBm	_____dBm	+ 2 dBm	_____dBm
+ 9 dBm	_____dBm	+ 1.5 dBm	_____dBm	+ 1 dBm	_____dBm
+ 8 dBm	_____dBm	+ 0.5 dBm	_____dBm	0 dBm	_____dBm
+ 7 dBm	_____dBm	- 0.5 dBm	_____dBm	- 1 dBm	_____dBm
+ 6 dBm	_____dBm	- 1.5 dBm	_____dBm	- 2 dBm	_____dBm
+ 5 dBm	_____dBm	- 2.5 dBm	_____dBm	- 3 dBm	_____dBm
+ 4 dBm	_____dBm	- 3.5 dBm	_____dBm	- 4 dBm	_____dBm
+ 3 dBm	_____dBm	- 4.5 dBm	_____dBm	- 5 dBm	_____dBm
+ 2 dBm	_____dBm	- 5.5 dBm	_____dBm	- 6 dBm	_____dBm
+ 1 dBm	_____dBm	- 6.5 dBm	_____dBm	- 7 dBm	_____dBm
+ 0 dBm	_____dBm	- 7.5 dBm	_____dBm	- 8 dBm	_____dBm
- 1 dBm	_____dBm	- 8.5 dBm	_____dBm	- 9 dBm	_____dBm
- 2 dBm	_____dBm	- 9.5 dBm	_____dBm	- 10 dBm	_____dBm

* Specification is ±1.0 dB.

* Specification is ±1.0 dB.

* Specification is ±1.5 dB.

Power Level Flatness (Step Sweep)

Set Power	Max Power	Min Power	Variation **
+ 2 dBm	_____dBm	_____dBm	_____dB

** Maximum variation is 1.6 dB (0.5 to 40 GHz); 2.2 dB (40 to 60 GHz).

Power Level Flatness (Analog Sweep)(Model 68385B only)

Set Power	Max Power	Min Power	Variation ***
+ 2 dBm	_____dBm	_____dBm	_____dB

*** Maximum variation is 2.0 dB (0.5 to 20 GHz); 4.0 dB (20 to 40 GHz); 5.0 dB (40 to 60 GHz)(typical, not a specification).

OPERATION VERIFICATION

POWER LEVEL ACCURACY AND FLATNESS TESTS

Table 5-3. Power Level Accuracy and Flatness Test Record (42 of 46)

Model 68_85B		Serial No. _____		Date _____	
Model 68285B / 68385B (with Option 2D Step Attenuator)					
Power Level Accuracy * (CW Frequency = 5.0 GHz)		Power Level Accuracy * (CW Frequency = 25.0 GHz)		Power Level Accuracy * (CW Frequency = 50.0 GHz)	
Set Power	Measured Power	Set Power	Measured Power	Set Power	Measured Power
+ 8.5 dBm	_____dBm	+ 0 dBm	_____dBm	- 1.5 dBm	_____dBm
+ 7.5 dBm	_____dBm	- 1 dBm	_____dBm	- 2.5 dBm	_____dBm
+ 6.5 dBm	_____dBm	- 2 dBm	_____dBm	- 3.5 dBm	_____dBm
+ 5.5 dBm	_____dBm	- 3 dBm	_____dBm	- 4.5 dBm	_____dBm
+ 4.5 dBm	_____dBm	- 4 dBm	_____dBm	- 5.5 dBm	_____dBm
+ 3.5 dBm	_____dBm	- 5 dBm	_____dBm	- 6.5 dBm	_____dBm
+ 2.5 dBm	_____dBm	- 6 dBm	_____dBm	- 7.5 dBm	_____dBm
+ 1.5 dBm	_____dBm	- 7 dBm	_____dBm	- 8.5 dBm	_____dBm
+ 0.5 dBm	_____dBm	- 8 dBm	_____dBm	- 9.5 dBm	_____dBm
- 0.5 dBm	_____dBm	- 9 dBm	_____dBm	-10.5 dBm	_____dBm
- 1.5 dBm	_____dBm	-10 dBm	_____dBm	-11.5 dBm	_____dBm
- 2.5 dBm	_____dBm	-11 dBm	_____dBm	-12.5 dBm	_____dBm
- 3.5 dBm	_____dBm	-12 dBm	_____dBm	-13.5 dBm	_____dBm
* Specification is ± 1.0 dB.		* Specification is ± 1.0 dB.		* Specification is ± 1.5 dB.	
Power Level Flatness (Step Sweep)					
Set Power	Max Power	Min Power	Variation **		
- 2 dBm	_____dBm	_____dBm	_____dB		
** Maximum variation is 1.6 dB (0.5 to 40 GHz); 2.2 dB (40 to 60 GHz).					
Power Level Flatness (Analog Sweep)(Model 68385B only)					
Set Power	Max Power	Min Power	Variation ***		
- 2 dBm	_____dBm	_____dBm	_____dB		
*** Maximum variation is 6.0 dB (0.5 to 20 GHz); 8.2 dB (20 to 40 GHz); 10.2 dB (40 to 60 GHz)(typical, not a specification).					

Table 5-3. Power Level Accuracy and Flatness Test Record (43 of 46)

Model 68_87B		Serial No. _____		Date _____	
Model 68287B / 68387B (without Option 2D Step Attenuator)					
Power Level Accuracy * (CW Frequency = 5.0 GHz)		Power Level Accuracy * (CW Frequency = 25.0 GHz)		Power Level Accuracy * (CW Frequency = 50.0 GHz)	
Set Power	Measured Power	Set Power	Measured Power	Set Power	Measured Power
+10 dBm	_____dBm	+ 2.5 dBm	_____dBm	+ 2 dBm	_____dBm
+ 9 dBm	_____dBm	+ 1.5 dBm	_____dBm	+ 1 dBm	_____dBm
+ 8 dBm	_____dBm	+ 0.5 dBm	_____dBm	0 dBm	_____dBm
+ 7 dBm	_____dBm	- 0.5 dBm	_____dBm	- 1 dBm	_____dBm
+ 6 dBm	_____dBm	- 1.5 dBm	_____dBm	- 2 dBm	_____dBm
+ 5 dBm	_____dBm	- 2.5 dBm	_____dBm	- 3 dBm	_____dBm
+ 4 dBm	_____dBm	- 3.5 dBm	_____dBm	- 4 dBm	_____dBm
+ 3 dBm	_____dBm	- 4.5 dBm	_____dBm	- 5 dBm	_____dBm
+ 2 dBm	_____dBm	- 5.5 dBm	_____dBm	- 6 dBm	_____dBm
+ 1 dBm	_____dBm	- 6.5 dBm	_____dBm	- 7 dBm	_____dBm
+ 0 dBm	_____dBm	- 7.5 dBm	_____dBm	- 8 dBm	_____dBm
- 1 dBm	_____dBm	- 8.5 dBm	_____dBm	- 9 dBm	_____dBm
- 2 dBm	_____dBm	- 9.5 dBm	_____dBm	- 10 dBm	_____dBm
* Specification is ± 1.0 dB.		* Specification is ± 1.0 dB.		* Specification is ± 1.5 dB.	
Power Level Flatness (Step Sweep)					
Set Power	Max Power	Min Power	Variation **		
+ 2 dBm	_____dBm	_____dBm	_____dB		
** Maximum variation is 4.0 dB (0.01 to 0.05 GHz); 1.6 dB (0.05 to 40 GHz); 2.2 dB (40 to 60 GHz).					
Power Level Flatness (Analog Sweep)(Model 68387B only)					
Set Power	Max Power	Min Power	Variation ***		
+ 2 dBm	_____dBm	_____dBm	_____dB		
*** Maximum variation is 4.0 dB (0.01 to 0.05 GHz); 2.0 dB (0.05 to 20 GHz); 4.0 dB (20 to 40 GHz); 5.0 dB (40 to 60 GHz)(typical, not a specification).					

OPERATION VERIFICATION

POWER LEVEL ACCURACY AND FLATNESS TESTS

Table 5-3. Power Level Accuracy and Flatness Test Record (44 of 46)

Model 68_87B		Serial No. _____		Date _____	
Model 68287B / 68387B (with Option 2D Step Attenuator)					
Power Level Accuracy * (CW Frequency = 5.0 GHz)		Power Level Accuracy * (CW Frequency = 25.0 GHz)		Power Level Accuracy * (CW Frequency = 50.0 GHz)	
Set Power	Measured Power	Set Power	Measured Power	Set Power	Measured Power
+ 8.5 dBm	_____dBm	+ 0 dBm	_____dBm	- 1.5 dBm	_____dBm
+ 7.5 dBm	_____dBm	- 1 dBm	_____dBm	- 2.5 dBm	_____dBm
+ 6.5 dBm	_____dBm	- 2 dBm	_____dBm	- 3.5 dBm	_____dBm
+ 5.5 dBm	_____dBm	- 3 dBm	_____dBm	- 4.5 dBm	_____dBm
+ 4.5 dBm	_____dBm	- 4 dBm	_____dBm	- 5.5 dBm	_____dBm
+ 3.5 dBm	_____dBm	- 5 dBm	_____dBm	- 6.5 dBm	_____dBm
+ 2.5 dBm	_____dBm	- 6 dBm	_____dBm	- 7.5 dBm	_____dBm
+ 1.5 dBm	_____dBm	- 7 dBm	_____dBm	- 8.5 dBm	_____dBm
+ 0.5 dBm	_____dBm	- 8 dBm	_____dBm	- 9.5 dBm	_____dBm
- 0.5 dBm	_____dBm	- 9 dBm	_____dBm	-10.5 dBm	_____dBm
- 1.5 dBm	_____dBm	-10 dBm	_____dBm	-11.5 dBm	_____dBm
- 2.5 dBm	_____dBm	-11 dBm	_____dBm	-12.5 dBm	_____dBm
- 3.5 dBm	_____dBm	-12 dBm	_____dBm	-13.5 dBm	_____dBm
* Specification is ± 1.0 dB.		* Specification is ± 1.0 dB.		* Specification is ± 1.5 dB.	

Power Level Flatness (Step Sweep)

Set Power	Max Power	Min Power	Variation **
- 2 dBm	_____dBm	_____dBm	_____dB

** Maximum variation is 4.0 dB (0.01 to 0.05 GHz); 1.6 dB (0.05 to 40 GHz); 2.2 dB (40 to 60 GHz).

Power Level Flatness (Analog Sweep)(Model 68387B only)

Set Power	Max Power	Min Power	Variation ***
- 2 dBm	_____dBm	_____dBm	_____dB

*** Maximum variation is 7.0 dB (0.01 to 0.05 GHz); 6.0 dB (0.05 to 20 GHz); 8.2 dB (20 to 40 GHz); 10.2 dB (40 to 60 GHz)(typical, not a specification).

Table 5-3. Power Level Accuracy and Flatness Test Record (45 of 46)

Model 68_95B		Serial No. _____		Date _____	
Model 68295B / 68395B					
Power Level Accuracy * (CW Frequency = 5.0 GHz)		Power Level Accuracy * (CW Frequency = 25.0 GHz)		Power Level Accuracy * (CW Frequency = 50.0 GHz)	
Set Power	Measured Power	Set Power	Measured Power	Set Power	Measured Power
+10 dBm	_____dBm	+ 2.5 dBm	_____dBm	0 dBm	_____dBm
+ 9 dBm	_____dBm	+ 1.5 dBm	_____dBm	- 1 dBm	_____dBm
+ 8 dBm	_____dBm	+ 0.5 dBm	_____dBm	- 2 dBm	_____dBm
+ 7 dBm	_____dBm	- 0.5 dBm	_____dBm	- 3 dBm	_____dBm
+ 6 dBm	_____dBm	- 1.5 dBm	_____dBm	- 4 dBm	_____dBm
+ 5 dBm	_____dBm	- 2.5 dBm	_____dBm	- 5 dBm	_____dBm
+ 4 dBm	_____dBm	- 3.5 dBm	_____dBm	- 6 dBm	_____dBm
+ 3 dBm	_____dBm	- 4.5 dBm	_____dBm	- 7 dBm	_____dBm
+ 2 dBm	_____dBm	- 5.5 dBm	_____dBm	- 8 dBm	_____dBm
+ 1 dBm	_____dBm	- 6.5 dBm	_____dBm	- 9 dBm	_____dBm
+ 0 dBm	_____dBm	- 7.5 dBm	_____dBm	- 10 dBm	_____dBm
- 1 dBm	_____dBm	- 8.5 dBm	_____dBm	- 11 dBm	_____dBm
- 2 dBm	_____dBm	- 9.5 dBm	_____dBm	- 12 dBm	_____dBm

* Specification is ±1.0 dB.

* Specification is ±1.0 dB.

* Specification is ±1.5 dB.

Power Level Flatness (Step Sweep)

Set Power	Max Power	Min Power	Variation **
- 2 dBm	_____dBm	_____dBm	_____dB

** Maximum variation is 1.6 dB (0.5 to 40 GHz); 2.2 dB (40 to 65 GHz).

Power Level Flatness (Analog Sweep)(Model 68395B only)

Set Power	Max Power	Min Power	Variation ***
- 2 dBm	_____dBm	_____dBm	_____dB

*** Maximum variation is 2.0 dB (0.5 to 20 GHz); 4.0 dB (20 to 40 GHz); 5.0 dB (40 to 65 GHz)(typical, not a specification).

OPERATION VERIFICATION

POWER LEVEL ACCURACY AND FLATNESS TESTS

Table 5-3. Power Level Accuracy and Flatness Test Record (46 of 46)

Model 68_97B		Serial No. _____		Date _____	
Model 68297B / 68397B					
Power Level Accuracy * (CW Frequency = 5.0 GHz)		Power Level Accuracy * (CW Frequency = 25.0 GHz)		Power Level Accuracy * (CW Frequency = 50.0 GHz)	
Set Power	Measured Power	Set Power	Measured Power	Set Power	Measured Power
+10 dBm	_____dBm	+ 2.5 dBm	_____dBm	0 dBm	_____dBm
+ 9 dBm	_____dBm	+ 1.5 dBm	_____dBm	- 1 dBm	_____dBm
+ 8 dBm	_____dBm	+ 0.5 dBm	_____dBm	- 2 dBm	_____dBm
+ 7 dBm	_____dBm	- 0.5 dBm	_____dBm	- 3 dBm	_____dBm
+ 6 dBm	_____dBm	- 1.5 dBm	_____dBm	- 4 dBm	_____dBm
+ 5 dBm	_____dBm	- 2.5 dBm	_____dBm	- 5 dBm	_____dBm
+ 4 dBm	_____dBm	- 3.5 dBm	_____dBm	- 6 dBm	_____dBm
+ 3 dBm	_____dBm	- 4.5 dBm	_____dBm	- 7 dBm	_____dBm
+ 2 dBm	_____dBm	- 5.5 dBm	_____dBm	- 8 dBm	_____dBm
+ 1 dBm	_____dBm	- 6.5 dBm	_____dBm	- 9 dBm	_____dBm
+ 0 dBm	_____dBm	- 7.5 dBm	_____dBm	- 10 dBm	_____dBm
- 1 dBm	_____dBm	- 8.5 dBm	_____dBm	- 11 dBm	_____dBm
- 2 dBm	_____dBm	- 9.5 dBm	_____dBm	- 12 dBm	_____dBm

* Specification is ± 1.0 dB.

* Specification is ± 1.0 dB.

* Specification is ± 1.5 dB.

Power Level Flatness (Step Sweep)

Set Power	Max Power	Min Power	Variation **
- 2 dBm	_____dBm	_____dBm	_____dB

** Maximum variation is 4.0 dB (0.01 to 0.05 GHz); 1.6 dB (0.05 to 40 GHz); 2.2 dB (40 to 65 GHz).

Power Level Flatness (Analog Sweep)(Model 68397B only)

Set Power	Max Power	Min Power	Variation ***
- 2 dBm	_____dBm	_____dBm	_____dB

*** Maximum variation is 4.0 dB (0.01 to 0.05 GHz); 2.0 dB (0.05 to 20 GHz); 4.0 dB (20 to 40 GHz); 5.0 dB (40 to 65 GHz)(typical, not a specification).

Chapter 6

Operator Maintenance

Table of Contents

6-1	INTRODUCTION	6-3
6-2	ERROR AND WARNING/STATUS MESSAGES. . .	6-3
	Self-Test Error Messages.	6-3
	Normal Operation Error and Warning/Status Messages.	6-8
6-3	TROUBLESHOOTING	6-11
6-4	ROUTINE MAINTENANCE	6-14
	Cleaning the Fan Filter.	6-14
	Cleaning the Data Display	6-14
	Replacing the Line Fuse	6-15

Chapter 6

Operator Maintenance

6-1 INTRODUCTION

This chapter provides the information necessary for operator maintenance of the signal generator. Operator maintenance is limited to troubleshooting and repairs that can be made without removing the instrument covers.

6-2 ERROR AND WARNING/STATUS MESSAGES

During normal operation, the 682XXB/683XXB generates error messages to indicate internal malfunctions, abnormal signal generator operations, or invalid signal inputs or data entries. It also displays warning messages to alert the operator to conditions that could result in inaccurate signal generator output. In addition, status messages are displayed to remind the operator of current menu selections or settings.

Self-Test Error Messages

The 682XXB/683XXB firmware includes internal diagnostics that self-test the instrument. These self-test diagnostics perform a brief go/no-go test of most of the instrument PCBs and other internal assemblies.

CAUTION

During self-test with RF OUTPUT set to ON, the output power level is set to 0 dBm. Always disconnect sensitive equipment from the unit before performing self-test.

You can perform an instrument self-test at any time during normal operation by pressing **SYSTEM** and then **Selftest**.

If the signal generator fails self-test, an error message(s) is displayed on the front panel data display. These error messages describe the malfunction and, in most cases, provide an indication of what has failed. Table 6-1, next page, is a summary listing of the self-test error messages. Included for each is a description of the probable cause(s), whether or not the 682XXB/683XXB is still operable, and if operable, what operational degradation can be expected.

WARNING

Self-test error messages normally indicate the failure of an internal component or assembly of the CW generator. There are no operator serviceable components inside. Refer servicing of the instrument to qualified service technicians.

To prevent the risk of electrical shock or damage to precision components, **do not** remove the equipment covers.

Error Message	Description/Remarks
Error 100 DVM Ground Offset Failed	Indicates a calibration-related problem. Do Not Attempt to Operate! Refer the instrument to a qualified service technician.
Error 101 DVM Positive 10V Reference	Indicates either a calibration-related problem or a defective +10 Volt reference. Do not Attempt to Operate! Refer the instrument to a qualified service technician.
Error 102 DVM Negative 10V Reference	Indicates either a calibration-related problem or a defective –10 Volt reference. Do not Attempt to Operate! Refer the instrument to a qualified service technician.
Error 105 Power Supply Voltage(s) out of Regulation	Indicates one or more of the voltages from the power supply are out of regulation. Do Not Attempt to Operate! Refer the instrument to a qualified service technician.
Error 106 Power Supply not Locked	Indicates the power supply is not phase-locked to the 400 kHz reference frequency. The 682XXB/683XXB is still operable in a degraded mode. The RF output may contain more spurious signals than normal.
Error 107 Sweep Time Check Failed	Indicates the sweep timing is out of tolerance or has failed. If analog sweeps can be obtained, the 682XXB/683XXB is still operable in a degraded mode. If analog sweeps can not be obtained, the 682XXB/683 is operable only in CW or step sweep frequency modes.
Error 108 Crystal Oven Cold	Indicates the 100 MHz crystal oven or the Option 16 high-stability 10 MHz crystal oscillator has not reached operating temperature. The 682XXB/683XXB is still operable, but frequency accuracy and stability may be degraded.
Error 109 The 100MHz Reference is not Locked to the External Reference	Indicates the reference loop is not phase-locked to the external 10 MHz reference. The reference loop may phase-lock to the internal 100 MHz time base; consequently, the 682XXB/683XXB would continue to operate normally.
Error 110 The 100MHz Reference is not Locked to the High Stability 10MHz Crystal Oscillator	Indicates the reference loop is not phase-locked to the optional, high stability 10 MHz crystal oscillator. The reference loop may phase-lock to the internal 100 MHz time base; consequently, the 682XXB/683XXB would continue to operate normally.
Error 111 Fine Loop Osc Failed	Indicates one or more of the oscillators within the fine loop is not phase-locked. The 682XXB/683XXB is still operable but the accuracy and stability of frequency outputs are greatly reduced.

Error Message	Description/Remarks
Error 112 Coarse Loop Osc Failed	Indicates the coarse loop oscillator is not phase-locked. The 682XXB/683XXB is still operable but the accuracy and stability of the frequency outputs are greatly reduced.
Error 113 Yig Loop Osc Failed	Indicates the YIG loop is not phase-locked. The 682XXB/683XXB is still operable but the accuracy and stability of the frequency outputs are greatly reduced.
Error 114 Down Converter LO not Locked	Indicates the local oscillator in the down converter assembly is not phase-locked. The 682XXB/683XXB is still operable but the accuracy and stability of frequency outputs below 2 GHz is greatly reduced.
Error 115 Not Locked Indicator Failed	Indicates failure of the not phase-locked indicator circuit. The 682XXB/683XXB is still operable but an error message will not appear on the data display when the output frequency is not phase-locked.
Error 116 FM Loop Gain Check Failed	Indicates FM loop has failed or the loop gain is out of tolerance. The 682XXB/683XXB is still operable but frequency accuracy and stability are degraded.
Error 117 Linearizer Check Failed	Indicates a failure of the Linearizer DAC on the A12 PCB. The 682XXB/683XXB is still operable but frequency accuracy of the RF output is degraded.
Error 118 Switchpoint DAC Failed	Indicates a failure of the Switchpoint DAC on the A12 PCB. The 682XXB is still operable but will not generate a CW ramp. The 683XXB will not produce analog sweeps but should operate normally in CW and step sweep modes.
Error 119 Center Frequency Circuits Failed	Indicates a failure of the center frequency circuitry on the A12 PCB. Do Not Attempt to Operate! Refer the instrument to a qualified service technician.
Error 120 Delta-F Circuits Failed	Indicates a failure of the ΔF Width DAC on the A12 PCB. The 683XXB will not generate ΔF analog sweeps but should produce ΔF step sweeps.
Error 121 Unleveled Indicator Failed	Indicates failure of the not leveled detector circuitry on the A10 PCB. The 682XXB/683XXB is still operable but a warning message will not appear when the RF output goes unleveled.
Error 122 Level Reference Failed	Indicates a failure of the level reference circuitry on the A10 PCB. Use caution and always determine the output power level when operating the 682XXB/683XXB in this condition.
Error 123 Detector Log Amp Failed	Indicates a failure of the level detector log amplifier circuitry on the A10 PCB. Use caution and always determine the output power level when operating the 682XXB/683XXB in this condition.
Error 124 Full Band Unlocked and Unleveled	Indicates a failure of both YIG-tuned oscillators. Do Not Attempt to Operate! Refer the instrument to a qualified service technician.
Error 125 8.4 – 20 GHz Unlocked and Unleveled	Indicates a failure of the 8.4 to 20 GHz YIG-tuned oscillator. Do Not Attempt to Operate! Refer the instrument to a qualified service technician.

Error Message	Description/Remarks
Error 126 2 – 8.4 GHz Unlocked and Unleveled	Indicates a failure of the 2 to 8.4 GHz YIG-tuned oscillator. Do Not Attempt to Operate! Refer the instrument to a qualified service technician.
Error 127 Detector Input Circuit Failed	Indicates a failure of the level detector input circuitry on the A10 PCB. Use caution and always determine the output power level when operating the 682XXB/683XXB in this condition.
Error 128 .01 – 2 GHz Unleveled	Indicates a failure of the Down Converter leveling circuitry. The 682XXB/683XXB operates normally but will have unleveled RF output in the 0.01 – 2 GHz frequency range.
Error 129 Switched Filter or Level Detector Failed	Indicates a failure of either the switched filter or level detector circuitry. The 682XXB/683XXB may or may not produce an RF output. Use caution and always determine the output power level when operating the instrument in this condition.
Error 130 2 – 3.3 GH Switched Filter	Indicates a failure in the 2 – 3.3 GHz switched filter path within the switched filter assembly. The 682XXB/683XXB may or may not produce an RF output in this frequency range. Use caution and always determine the output power level when operating the instrument in this condition.
Error 131 3.3 – 5.5 GH Switched Filter	Indicates a failure in the 3.3 – 5.5 GHz switched filter path within the switched filter assembly. The 682XXB/683XXB may or may not produce an RF output in this frequency range. Use caution and always determine the output power level when operating the instrument in this condition.
Error 132 5.5 – 8.4 GH Switched Filter	Indicates a failure in the 5.5 – 8.4 GHz switched filter path within the switched filter assembly. The 682XXB/683XXB may or may not produce an RF output in this frequency range. Use caution and always determine the output power level when operating the instrument in this condition.
Error 133 8.4 – 13.25 GH Switched Filter	Indicates a failure in the 8.4 – 13.25 GHz switched filter path within the switched filter assembly. The 682XXB/683XXB may or may not produce an RF output in this frequency range. Use caution and always determine the output power level when operating the instrument in this condition.
Error 134 13.25 – 20 GH Switched Filter	Indicates a failure in the 13.25 – 20 GHz switched filter path within the switched filter assembly. The 682XXB/683XXB may or may not produce an RF output in this frequency range. Use caution and always determine the output power level when operating the instrument in this condition.
Error 135 Modulator or Driver Failed	Indicates a failure of the modulator in the switched filter assembly or the modulator driver circuitry on the A9 PCB. The 682XXB/683XXB may or may not produce an RF output. Use caution and always determine the output power level when operating the instrument in this condition.
Error 138 SDM Unit or Driver Failed	Indicates a failure of the switched doubler module (SDM) or SDM bias regulator circuitry on the A14 PCB. The 682XXB/683XXB is still operable but it will not produce an RF output in the 20 – 40 GHz frequency range.

Table 6-1. *Self-Test Error Messages (4 of 4)*

Error Message	Description/Remarks
Error 139 32 – 40 GHz SDM Section Failed	Indicates a failure in the 32 – 40 GHz switched doubler filter path within the SDM. The 682XXB/683XXB is still operable but it will not produce an RF output in the 32 – 40 GHz frequency range.
Error 140 25 – 32 GHz SDM Section Failed	Indicates a failure in the 25 – 32 GHz switched doubler filter path within the SDM. The 682XXB/683XXB is still operable but it will not produce an RF output in the 25 – 32 GHz frequency range.
Error 141 20 – 25 GHz SDM Section Failed	Indicates a failure in the 20 – 25 GHz switched doubler filter path within the SDM. The 682XXB/683XXB is still operable but it will not produce an RF output in the 20 – 25 GHz frequency range.
Error 142 Sample and Hold Circuit Failed	Indicates a failure of the sample and hold circuitry on the A10 PCB. The 682XXB/683XXB still operates normally but the RF output may be unlevelled during pulse modulation.
Error 143 Slope DAC Failed	Indicates a failure of the level slope DAC on the A10 PCB. The 682XXB/683XXB still operates normally but RF output level flatness may be affected during frequency sweeps.
Error 144 RF was Off when Selftest started. Some tests were not performed.	Indicates that some self-tests were not performed because RF Output was selected OFF on the 682XXB/683XXB front panel. Press the OUTPUT key to turn RF Output ON and run the instrument self-test again.
Error 145 AM meter or associated circuitry failed	Indicates a failure of the internal AM circuitry and loss of the capability to provide amplitude modulation of the RF output signal using modulating signals from the internal AM generator. The 682XXB/683XXB may or may not provide amplitude modulation of the output signal using modulating signals from an external source.
Error 147 Internal FM circuitry failed	Indicates a failure of the internal FM circuitry and loss of the capability to provide frequency modulation of the RF output signal using modulating signals from the internal FM generator. The 682XXB/683XXB may or may not provide frequency modulation of the output signal using modulating signals from an external source.
Error 148 Pulse 40 MHz reference circuitry failed	Indicates a failure of the pulse generator 40 MHz oscillator circuitry. The pulse generator may still function; however, the 40 MHz oscillator is not phase locked to the 10 MHz reference timebase. The pulse modulation function may or may not operate.

***Normal
Operation
Error and
Warning/
Status
Messages***

When an abnormal condition is detected during operation, the 682XXB/683XXB displays an error message to indicate that the output is abnormal or that a signal input or data entry is invalid. It also displays warning messages to alert the operator to conditions that could cause an inaccurate signal generator output. Status messages to remind the operator of current menu selections or settings are also generated. Table 6-2 is a summary list of possible error messages that can be displayed during normal operations. Table 6-3 is a summary list of possible warning/status messages.

Table 6-2. *Possible Error Messages during Normal Operations (1 of 2)*

Error Message	Description
ERROR	Displayed (on the frequency mode title bar) when (1) the output frequency is not phase-locked, (2) an invalid frequency parameter entry causes a frequency range error, or (3) an invalid pulse parameter entry causes a pulse modulation error.
LOCK ERROR	Displayed (in the frequency parameters area) when the output frequency is not phase-locked. The frequency accuracy and stability of the RF output is greatly reduced. Normally caused by an internal component failure. Run self-test to verify malfunction.
RANGE	Displayed (in the frequency parameters area) when (1) the analog sweep start frequency entered is greater than the stop frequency (683XXB models only), (2) the dF value entered results in a sweep outside the range of the instrument, (3) the step size value entered is greater than the sweep range, or (4) the number of steps entered results in a step size of less than 1 kHz (0.1 Hz with Option 11) or 0.1 dB. Entering valid values usually clears the error.
SLAVE	Displayed (in the frequency parameters area of the Master 68XXXB) during master-slave operation in VNA mode when the slave frequency offset value entered results in a CW frequency or frequency sweep outside the range of the slave 68XXXB. Entering a valid offset value clears the error.
ERR	Displayed (in the modulation status area) when one or more of the following error conditions occurs: (1) The external AM modulating signal exceeds the input voltage range. In addition, the message " Reduce AM Input Level " appears at the bottom of the AM status display. <i>(Continued on next page)</i>

Table 6-2. Possible Error Messages during Normal Operations (2 of 2)

Error Message	Description
ERR	<p><i>Continued:</i></p> <p>(2) The external FM (or ΦM) modulating signal exceeds the input voltage range. In addition, the message "Reduce FM (or ΦM) Input Level" appears at the bottom of the FM (or ΦM) status display.</p> <p>(3) A pulse parameter setting is invalid for the current pulse modulation state, as follows:</p> <p>Pulse Period: <125 ns (40 MHz clock) or <500 ns (10 MHz clock) longer than pulse widths + delays</p> <p>Single Pulse Mode: Free Run or Gated Trigger: $Width1 > PRI$ Delayed Trigger: $Delay1 + Width1 > PRI$</p> <p>Doublet Pulse Mode: Free Run Trigger: $Width1 > Delay2$ or $Width1 + (Delay2 - Width1) + Width2 > PRI$ Delayed Trigger: $Width1 > Delay2$ or $Delay1 + Width1 + (Delay2 - Width1) + Width2 > PRI$</p> <p>External Trigger with or without Delay: $Width1 > Delay2$</p> <p>Triplet Pulse Mode: Free Run Trigger: $Width1 > Delay2$ or $Width2 > Delay3$ or $Width1 + (Delay2 - Width1) + Width2 + (Delay3 - Width2) + Width3 > PRI$ Delayed Trigger: $Width1 > Delay2$ or $Width2 > Delay3$ or $Delay1 + Width1 + (Delay2 - Width1) + Width2 + (Delay3 - Width2) + Width3 > PRI$</p> <p>External Trigger with or without Delay: $Width1 > Delay2$ or $Width2 > Delay3$</p> <p>Quadruplet Pulse Mode: Free Run Trigger: $Width1 > Delay2$ or $Width2 > Delay3$ or $Width3 > Delay4$ or $Width1 + (Delay2 - Width1) + Width2 + (Delay3 - Width2) + Width3 + (Delay4 - Width3) + Width4 > PRI$ Delayed Trigger: $Width1 > Delay2$ or $Width2 > Delay3$ or $Width3 > Delay4$ or $Delay1 + Width1 + (Delay2 - Width1) + Width2 + (Delay3 - Width2) + Width3 + (Delay4 - Width3) + Width4 > PRI$</p> <p>External Trigger with or without Delay: $Width1 > Delay2$ or $Width2 > Delay3$ or $Width3 > Delay4$</p>

Table 6-3. *Possible Warning/Status Messages during Normal Operation*

Warning/Status Message	Description
OVN COLD	This warning message indicates that the 100 MHz Crystal oven (or the 10 MHz Crystal oven if Option 16 is installed) has not reached operating temperature. Normally displayed during a cold start of the sweep generator. If the message is displayed during normal operation, it could indicate a malfunction. Run self-test to verify.
UNLEVELED	Displayed when the RF output goes unleveled. Normally caused by exceeding the specified leveled-power rating. Reducing the power level usually clears the warning message. If the warning message is displayed only when AM is selected ON, the modulating signal may be driving the RF output unleveled. Reducing the modulating signal or adjusting the power level usually clears the warning.
UNLOCKED	When Unlocked/Narrow FM or Unlocked/Wide FM is selected ON, this warning message appears indicating that the instrument is not phase-locked during this FM mode of operation.
Reduce Rate	This warning message is displayed when the AM rate, FM rate, or Φ M rate is set >100 kHz for a non-sinewave modulating waveform. Amplitude, frequency, or phase modulation of the output signal will continue but the modulating waveform may be distorted.
EXT REF	This status message indicates that an external 10 MHz signal is being used as the reference signal for the 682XXB/683XXB.
OFFSET	This status message indicates that a constant (offset) has been applied to the displayed power level.
SLOPE	This status message indicates that a power slope correction has been applied to the ALC.
USER 1...5	This status message indicates that a user level flatness correction power-offset table has been applied to the ALC.
SS MODE	This status message indicates that the 682XXB/683XXB has been placed in a source lock mode for operation with a 360B Vector Network Analyzer.

6-3 TROUBLESHOOTING

Table 6-4 provides procedures for troubleshooting common malfunctions encountered during signal generator operation. Included are procedures for troubleshooting faults that do not produce error messages, such as, failure to power up and unexpected shutdown.

Table 6-4. Troubleshooting (1 of 3)

**Signal Generator will not turn on
(OPERATE light is OFF)**

Normal Operation: When the 682XXB/683XXB is connected to the power source, the OPERATE light should illuminate and the instrument should power up.

- Step 1** Disconnect the 682XXB/683XXB from the power source, then check the line fuse on the rear panel.
- If the fuse is defective, replace (page 6-15).
 - If the fuse is good, go to the next step.
- Step 2** Check to see if power is available at the power receptacle.
- If not, move to a working receptacle.
 - If power is available, go to the next step.
- Step 3** Check the power cable.
- If defective, replace.
 - If good, call a service technician.

**Signal Generator will not turn on
(OPERATE light is ON)**

Normal Operation: When the 682XXB/683XXB is connected to the power source, the OPERATE light should illuminate and the instrument should power up.

- If the OPERATE light illuminates but the unit fails to power up, the 682XXB/683XXB has an internal component failure. Call a service technician.
-

Table 6-4. Troubleshooting (2 of 3)

Signal Generator Quits During Operation (OPERATE light remains on)

Trouble Description: The signal generator operates for some time, then shuts down (OPERATE light remains on). After a short period, the signal generator resumes normal operation. This is an indication that the 682XXB/683XXB has reached an excessive operating temperature.

- Step 1** Check that the fan is still operating during the time that the instrument is shut down.
- ❑ If the fan is still operating, clean the air filter (page 6-14).
 - ❑ If the fan is not operating, call a service technician.

LOCK ERROR is Displayed

Trouble Description: This message is displayed in the frequency parameters area to indicate that the output frequency is not phase-locked. It is normally caused by an internal component failure.

- Step 1** Perform a self-test of the signal generator by pressing the System Menu soft-key **Selftest**.
- ❑ If self-test does not result in an error message(s), resume normal operation.
 - ❑ If an error message(s) is displayed, call a service technician.
-

Table 6-4. Troubleshooting (3 of 3)

UNLEVELED is Displayed

Trouble Description: This message is displayed to indicate that the RF output is unlevelled.

Step 1 Check that the output power does not exceed the specified levelled-power rating and that the RF OUTPUT connector is terminated into a 50Ω load.

- ❑ Reduce the power level to not exceed the specified levelled-power rating or terminate the RF OUTPUT connector with a 50Ω load.
- ❑ If error message remains displayed, call a service technician.

RANGE is Displayed

Trouble Description: This message is displayed in the frequency parameters area to indicate that (1) the analog sweep start frequency entered is greater than the stop frequency (Model 683XXB only), (2) the dF value entered results in a sweep outside the range of the instrument, (3) the step size value entered is greater than the sweep range, or (4) the number of steps entered results in a step size of less than 1 kHz (0.1 Hz with Option 11) or 0.1 dB.

Step 1 Check that (1) the analog sweep start frequency entered is not greater than the stop frequency (Model 683XXB only), (2) the dF value entered does not try to set the frequency sweep outside the range of the signal generator, (3) the step size entered is not greater than F2 minus F1, or (4) the number of steps entered does not result in a step size that is smaller than the resolution of the instrument.

- ❑ Enter a valid sweep start frequency, dF value, step size, or number of steps.
 - ❑ If the error message remains displayed, call a service technician.
-

6-4 ROUTINE MAINTENANCE

Routine maintenance that can be performed by the operator consists of cleaning the fan filter, cleaning the data display, and replacing a defective line fuse.

***Cleaning the
Fan Filter***

The signal generator must always receive adequate ventilation. A blocked fan filter can cause the instrument to overheat and shut down. Check and clean the rear panel fan honeycomb filter periodically. Clean the filter more frequently in dusty environments. Clean the filter as follows:

- Step 1** Remove the filter guard from the rear panel by pulling out on the four panel fasteners holding them in place (Figure 6-2).
- Step 2** Vacuum the honeycomb filter to clean it.
- Step 3** Install the filter guard back on the rear panel.
- Step 4** Press in on the panel fasteners to secure the filter guard to the rear panel.

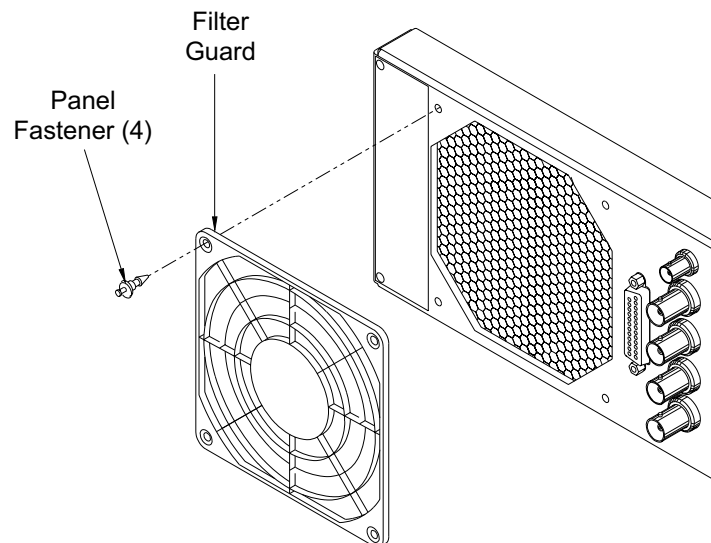

Figure 6-2. Removing/Replacing the Fan Filter

***Cleaning the
Data Display***

The data display of the signal generator is protected by a plastic display filter. To clean the display filter, use mild soap or detergent and water, or a commercial window cleaner. When cleaning use a soft, lint-free cloth. Do *not* use abrasive cleaners, tissues, or paper towels which can scratch the plastic surface.

***Replacing the
Line Fuse***

The value of the line fuse used in the 682XXB/683XXB is determined by the line voltage selection—a 5A line fuse for 110 Vac line voltage; a 2.5A line fuse for 220 Vac line voltage. These line fuse values are printed on the rear panel next to the fuse holder.



WARNING

Before changing the fuse, ***always*** remove the power cord from the power outlet. There is the risk of receiving a fatal electric shock if the fuse is replaced with the power cord connected.

Always use a new fuse of the type and rating specified by the fuse markings on the rear panel of the instrument.

- Step 1*** Disconnect the signal generator from the power source.
- Step 2*** Using a small flat-blade screwdriver, turn the fuse cap counter-clockwise and remove the fuse holder.
- Step 3*** Replace the fuse in the fuse holder.
- Step 4*** Install the fuse holder in the rear panel. Using the screwdriver, rotate the fuse cap clockwise to secure the fuse holder in place.
- Step 5*** Reconnect the signal generator to the power source.

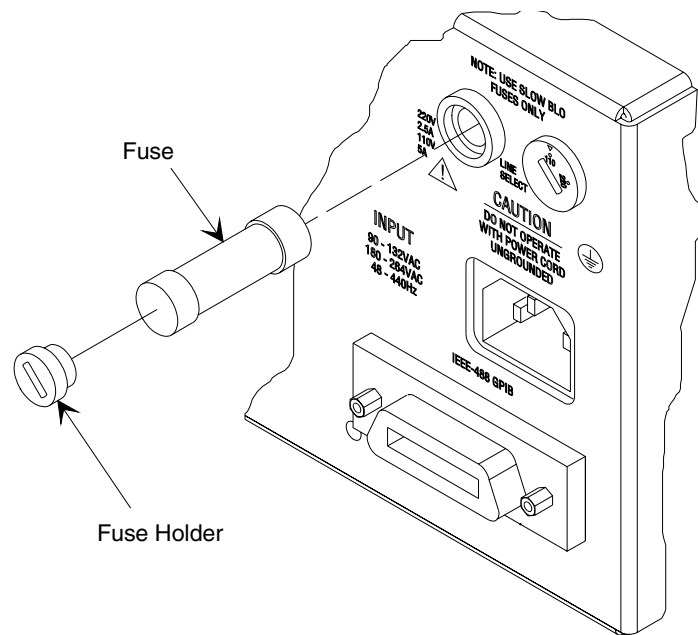

Figure 6-1. Replacing the Line Fuse

Chapter 7

Use With Other Instruments

Table of Contents

7-1	INTRODUCTION	7-3
7-2	MASTER-SLAVE OPERATION	7-4
	Connecting the 68XXXBs	7-4
	Initiating Master-Slave Operation	7-5
	Master-Slave Operation	7-7
	Master-Slave Operation in VNA Mode	7-7
	Terminating Master-Slave Operation	7-9
7-3	USE WITH A 562 SNA	7-10
	Connecting the 682XXB/683XXB to the 562	7-10
7-4	USE WITH A 360B VNA.	7-11
	Connecting the 682XXB/683XXB to the 360B	7-11
	Modes of Operation.	7-12
	Source Lock Mode	7-12
	Tracking Mode	7-14
7-5	USE WITH A 8003 SNA	7-16
	Connecting the 682XXB/683XXB to the 8003	7-16
	Setting Up the 682XXB/683XXB	7-17
	Initiating 8003 SNA Operation	7-18
7-6	USE WITH A HP8757D SNA (682XXB Models with Firmware Version 2.42 and above; 682X5B Models with Firmware Version 1.31 and above; 683XXB Models with Firmware Version 2.53 and above; 683X5B Models with Firmware Version 1.35 and above.	7-20
	Connecting the 682XXB/683XXB to the HP8757D	7-20
	Setting up the 682XXB/683XXB.	7-21
	Initiating HP8757D SNA Operation.	7-23

Chapter 7

Use With Other Instruments

7-1 INTRODUCTION

This chapter provides information and instructions for using the Series 682XXB/683XXB Synthesized Signal Generators with other instruments. It contains the following:

- ❑ Instructions for interconnecting and operating any two 68XXXBs in a master-slave configuration.
- ❑ Instructions for connecting the 682XXB/683XXB to a ANRITSU Model 562 Scalar Network Analyzer so that it can be used as a signal source for the analyzer.
- ❑ Instructions for connecting the 682XXB/683XXB to a ANRITSU Model 360B Vector Network Analyzer and configuring the signal generator so that it can be used as a signal source for the analyzer.
- ❑ Instructions for connecting the 682XXB/6893XXB to a Gigatronics Model 8003 Scalar Network Analyzer and setting up the signal generator so that it can be used as a signal source for the analyzer.
- ❑ Instructions for connecting 682XXB models with Firmware Version 2.42 and above (682X5B models with Firmware Version 1.31 and above) and 683XXB models with Firmware Version 2.53 and above (683X5B models with Firmware Version 1.35 and above) to a Hewlett Packard Model 8757D Scalar Network Analyzer and setting up the signal generator so that it can be used as a signal source for the analyzer.

**7-2 MASTER-SLAVE
OPERATION**

Master-slave operation consists of connecting any two 68XXXBs together and configuring them so that they produce CW and synchronized, swept output signals at an operator-selectable frequency offset. One 68XXXB (the Master) controls the other (the Slave) via interface cables between their rear panel AUX I/O and SERIAL I/O connectors. The two units are phase-locked together by connecting them to the same 10 MHz reference time base.

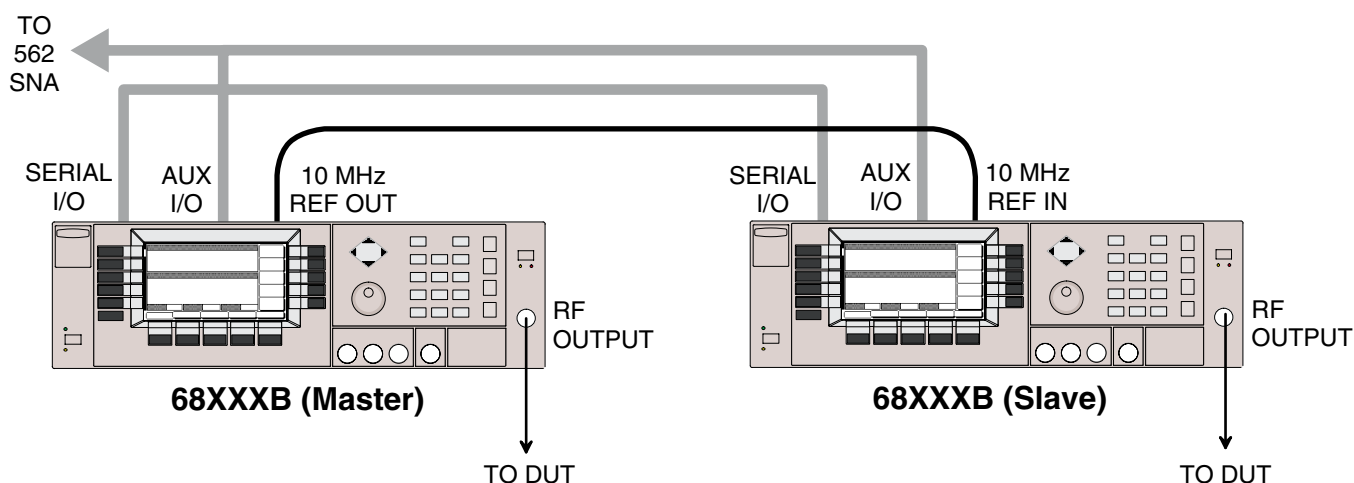

Figure 7-1. 68XXXB Configuration for Master-Slave Operation

**Connecting
the 68XXXBs**

Connect the two 68XXXBs, shown in Figure 7-1, as follows:

NOTES

When connecting two 68XXXBs together for Master-Slave operations, **always** use a ANRITSU Master-Slave interface cable set, Part No. ND36329.

If a Model 562 Scalar Network Analyzer is being used with the master-slave configuration, (1) connect the AUX I/O cable end labeled “SNA” to the rear panel AUX I/O connector on the 562 SNA and (2) connect a dedicated system bus cable (P/N 2100-1) between the Master 68XXXB rear panel IEEE-488 GPIB connector and the 562 SNA rear panel DEDICATED GPIB connector.

- Step 1** Connect the 3-port AUX I/O cable end labeled “MASTER” to the rear panel AUX I/O connector on the Master 68XXXB. Connect the AUX I/O cable labeled “SLAVE” to the rear panel AUX I/O connector on the Slave 68XXXB.
- Step 2** Connect the ends of the flat interface cable to the rear panel Serial I/O connectors on the Master and Slave 68XXXBs.
- Step 3** Connect one end of a coaxial cable to the rear panel 10 MHz REF OUT connector on the Master 68XXXB. Connect the other end to the rear panel 10 MHz REF IN connector on the Slave 683XXB.

Step 4 Connect the Master 68XXXB RF OUTPUT and the Slave 68XXXB RF OUTPUT to the appropriate connections on the DUT.

**Initiating
Master-Slave
Operation**

The following paragraphs describe how to set up both 68XXXBs to perform master-slave operations. Use the CW Frequency Mode menu map (Chapter 4, Figure 4-2) to follow the menu sequences.

To initiate master-slave operation, turn on both 68XXXBs and place them in CW mode. The CW Menu (below) is displayed.

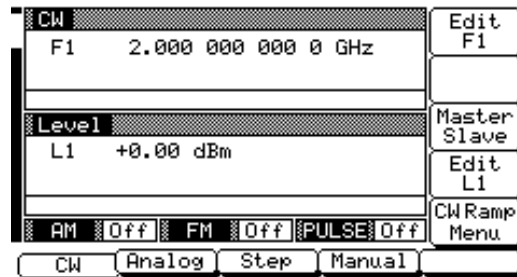

NOTE
Master-slave operations are *always* initiated in the CW frequency mode. Once initiated, you then can change to a sweep frequency mode of operation by selecting the desired frequency mode on the Master 68XXXB.

On the Master 68XXXB, press **Master Slave** to go to the Master-Slave Menu display (below).

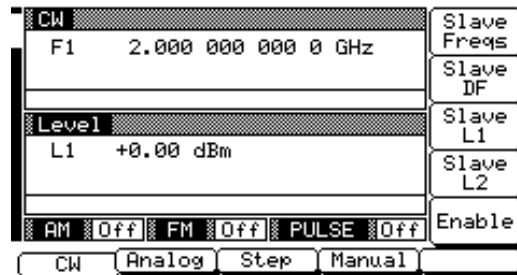

This menu lets you perform the following:

- Go to the Slave Frequencies List menu.
- Set the dF frequency for the Slave unit.
- Set the Slave unit's main power level (L1).
- Set the alternate sweep power level (L2) for the Slave unit.
- Turn master/slave operation on and off.

Press **Slave Freqs** to go to the Slave Frequencies List menu (next page).

NOTE

Upon reset, the slave frequencies (F0 - F9 and M0 - M9) return to the default values shown here.

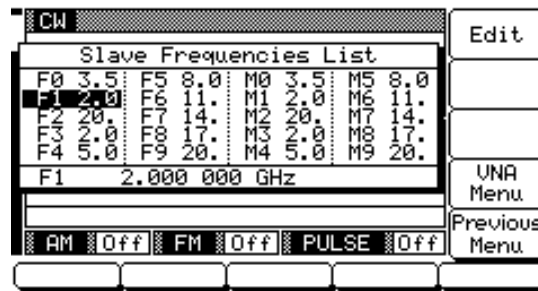

This menu lets you edit the listed frequencies for the Slave 68XXXB.

Use the cursor control key to select a frequency parameter from the list, then press **Edit** to edit its value. Edit the current frequency parameter value using the cursor control key or rotary data knob or enter a new value using the key pad and appropriate termination key. Press **Edit** again to close the open frequency parameter.

When you are finished editing the slave frequencies, press **Previous Menu** to return to the Master-Slave menu (below).

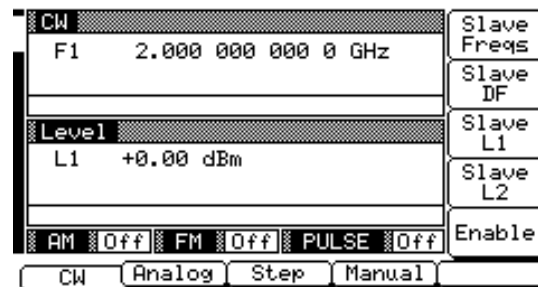

The Master-Slave menu lets you set the dF frequency and L1 and L2 power level parameters for the Slave unit.

Press **Slave DF** to open the dF frequency parameter.

Press **Slave L1** to open the main power level parameter.

Press **Slave L2** to open the alternate sweep power level parameter.

Open the parameter you wish to change, then edit the current value using the cursor control key or rotary data knob or enter a new value using the key

pad and appropriate termination key. When you have finished setting the open parameter, close it by pressing its menu soft-key or by making another menu selection.

Press **Enable** to begin master-slave operation.

Press **CW** to return to the CW menu.

Master-Slave Operation

During master-slave operation, the Slave unit is in remote mode under the direct control of the Master 68XXXB. The Slave unit displays the following:

- ❑ Its output CW frequency or sweep frequency range.
- ❑ Its output power level.
- ❑ The messages Remote and Local Lockout.

NOTE

The 562 SNA, when being used with the master-slave configuration, will not display markers.

The CW/sweep frequency settings on the Master 68XXXB define the master sweep, and the corresponding frequency settings on the Slave unit define the slave sweep. For example, if slave frequency F1 is set to 4 GHz and slave frequency F2 is set to 12 GHz, then the Slave unit will sweep from 4 to 12 GHz whenever the F1-F2 sweep range is selected on the Master 68XXXB. The Master 68XXXB will sweep from F1-F2 with the values of F1 and F2 defined in the Master unit's frequency list.

Master-Slave Operation in VNA Mode

In the VNA mode of master-slave operation, a Slave unit is coupled to a Master 68XXXB that is connected to a Model 360B Vector Network Analyzer in a source or dual source configuration. (Operating instructions for the vector network analyzer can be found in the Model 360B VNA Operation Manual, P/N 10410-00110.) The following paragraphs describe how to set up both 68XXXBs to perform master-slave operations in the VNA mode.

Place both 68XXXBs in CW mode. Then, on the Master unit, press **Master Slave** to go to the Master Slave Menu display (page 7-5).

At the Master Slave menu, press **Slave Freqs** to go to the Slave Frequencies List Menu display (next page).

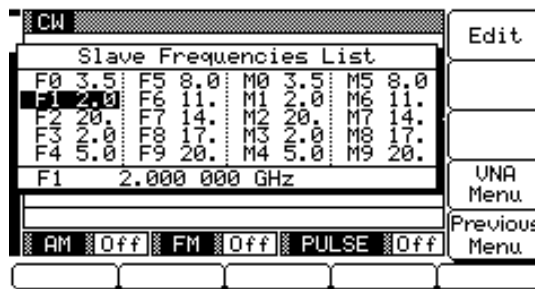

Press **VNA Menu** to go to the VNA Menu display (below).

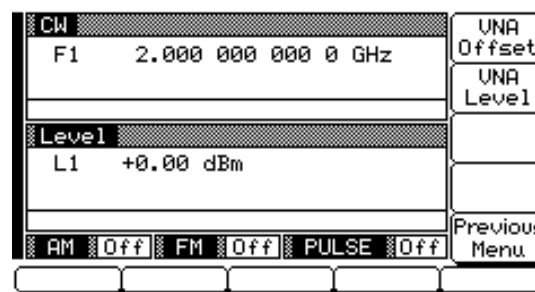

This menu lets you set the frequency offset and output power level for the Slave 68XXXB in the VNA mode.

Press **VNA Offset** to open the slave frequency offset parameter.

Press **VNA Level** to open the slave output power level parameter.

SLAVE

During master-slave operations in VNA mode, this error message is displayed on the Master 68XXXB whenever the slave offset value entered results in a CW frequency or frequency sweep outside the range of the Slave unit. Entering a valid offset value clears the error.

Open the parameter you wish to change, then edit the current value using the cursor control key or rotary data knob or enter a new value using the key pad and appropriate termination key. When you have finished setting the open parameter, close it by pressing its menu soft-key or by making another menu selection.

Press **Previous Menu** to return to the Slave Frequencies List menu.

Return to the Master-Slave menu and press **Enable** to begin master-slave operation.

***Terminating
Master-Slave
Operation***

The following describes how to terminate master-slave operation and return the Slave 68XXXB to local (front panel) control.

On the Master 68XXXB, select CW mode.

At the CW Menu, press **Master Slave** to go to the Master-Slave Menu display.

At the Master-Slave Menu display, press **Enable**. This terminates master-slave operation and returns the Slave 68XXXB to local (front panel) control.

**7-3 USE WITH A 562 SCALAR
NETWORK ANALYZER**

The 682XXB/683XXB is directly compatible with the ANRITSU Model 562 Scalar Network Analyzer (SNA). The following paragraphs provide instructions for connecting the signal generator to the 562 SNA so that it can be used as a signal source for the analyzer. Operating instructions for the network analyzer can be found in the Model 562 Scalar Network Analyzer Operation Manual, P/N 10410-00046.

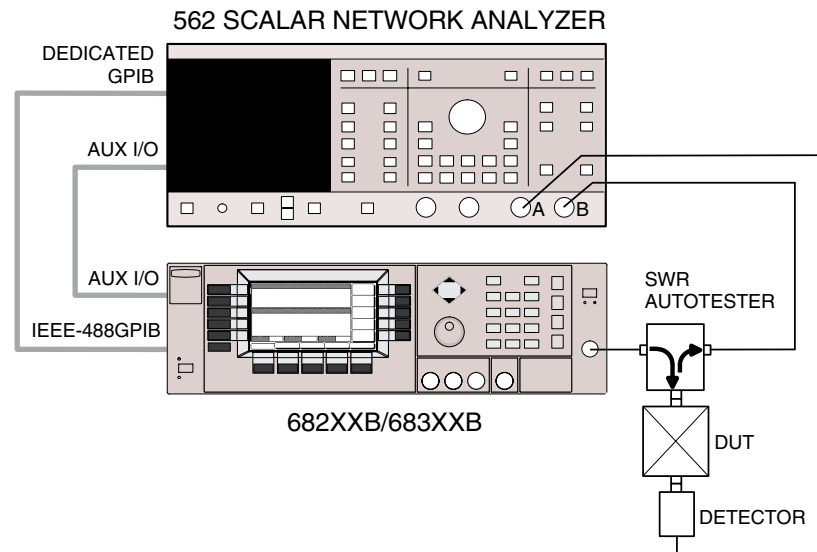

Figure 7-2. 682XXB/683XXB to 562 SNA Connections

**Connecting
the 682XXB/
683XXB to the
562**

Connect the 682XXB signal generator or 683XXB signal generator to the 562 SNA as shown in Figure 7-2.

NOTE
The 682XXB/683XXB's GPIB address should be set to 5 (the default address setting) for operation with a 562 SNA. To verify or change the GPIB address setting refer to Configuring the GPIB on page 3-81.
The 562 SNA will *only* accept and display nine video markers, F1 thru F9, from the 682XXB/683XXB.
When performing amplifier testing *only* use the 682XXB/683XXB power level, L1.

- Step 1** Connect one end of the Auxiliary I/O cable (P/N 806-7) to the 562 rear panel AUX I/O connector. Connect the other end of the cable to the 682XXB/683XXB rear panel AUX I/O connector.
- Step 2** Connect one end of the dedicated system bus cable (P/N 2100-1) to the 562 rear panel DEDICATED GPIB connector. Connect the other end of the cable to the 682XXB/683XXB rear panel IEEE-488 GPIB connector.
- Step 3** Turn on the 682XXB/683XXB and the 562. The system is now ready to operate.

**7-4 USE WITH A 360B
VECTOR NETWORK
ANALYZER**

The 682XXB/683XXB signal generator is compatible with the AN-RITSU Model 360B Vector Network Analyzer (VNA). The following paragraphs provide instructions for connecting the 682XXB/683XXB to the 360B VNA and configuring the signal generator so that it can operate as a signal source for the analyzer. Operating instructions for the vector network analyzer can be found in the Model 360B Vector Network Analyzer Operation Manual, P/N 10410-00110.

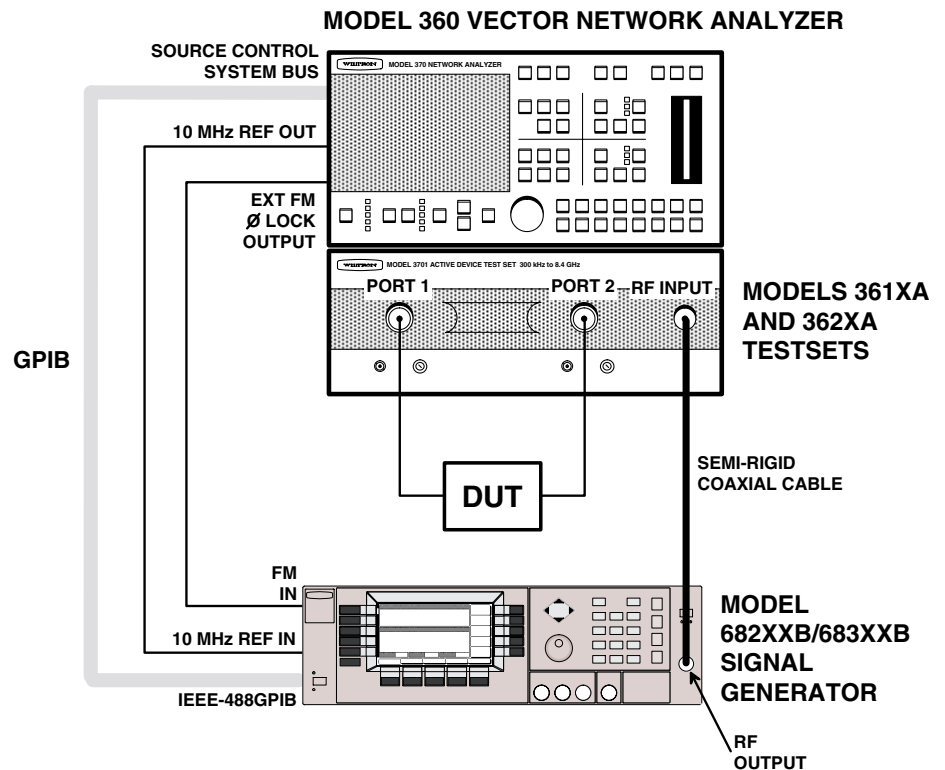

Figure 7-3. 682XXB/683XXB to 360B VNA Connections

**Connecting
the 682XXB/
683XXB to the
360B**

Connect the 682XXB signal generator or 683XXB signal generator to the 360B vector network analyzer as shown in Figure 7-3.

Step 1 Connect one end of a coaxial cable to the 682XXB/683XXB rear panel FM IN connector. Connect the other end to the 360B rear panel EXT FM \emptyset LOCK OUTPUT connector.

Step 2 Connect one end of a coaxial cable to the 682XXB/683XXB rear panel 10 MHz REF

NOTE

If the 682XXB/683XXB contains an Option 16 high-stability time base, connect the coaxial cable in step 2 between the 682XXB/683XXB rear panel 10 MHz REF OUT connector and the 360B rear panel 10 MHz REF IN connector.

IN connector. Connect the other end to the 360B rear panel 10 MHz REF OUT connector.

Step 3 Connect one end of a GPIB cable, 1 meter in length, to the 682XXB/683XXB rear panel IEEE-488 GPIB connector. Connect the other end of the cable to the 360B rear panel SOURCE CONTROL SYSTEM BUS connector.

Step 4 Turn on the 682XXB/683XXB and configure it as described in the following paragraphs.

**Modes of
Operation**

There are two 360B VNA receiver modes of operation that are used with the 682XXB/683XXB—the 360B source lock mode and the 360B tracking mode. The configuration and operation of the signal generator for both modes of operation are described in the following paragraphs.

**Source Lock
Mode**

When operating in source lock mode, the 360B phase locks the frequency output of the signal generator. This is accomplished by sending a dc control voltage to the FM input on the 682XXB/683XXB. Frequency resolution is limited to 100 kHz intervals. This is because of the inherent resolution of the 360B's synthesized local oscillators.

Source Lock Mode Configuration

In order for the 682XXB/683XXB to operate with a 360B in source lock mode, the signal generator must be placed in the SS Mode of operation.

To place the signal generator in SS Mode, first press the main menu key **SYSTEM**. At the System Menu display, press **Config**. The System Configuration Menu (shown below) is displayed.

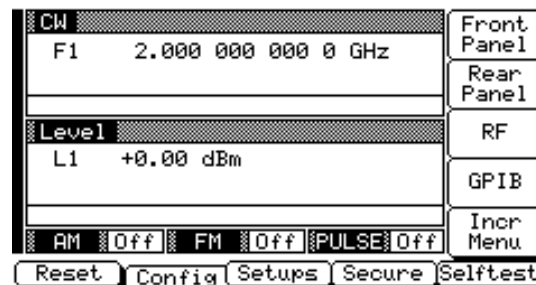

At the System Configuration menu, press **GPIB**. The Configure GPIB Menu (shown below) is displayed.

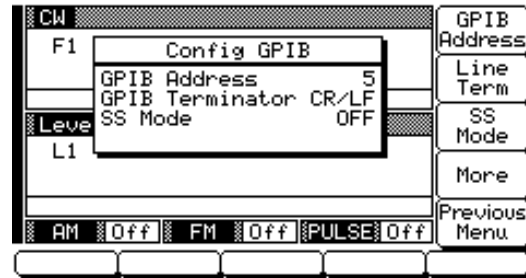

Verify that the GPIB address and terminator shown on the display match the System Bus source address and data terminator that are set on the 360B VNA.

If the GPIB address of the 682XXB/683XXB needs changing, press **GPIB Address**. Enter the new address using the cursor control key or the data entry keypad and the terminator key

HZ
ns
ADRS

The new GPIB address will appear on the display.

To change the data terminator, press **Line Term** to select the correct GPIB data delimiter.

Press **SS Mode** to turn on SS mode. This places the 682XXB/683XXB in a source lock mode.

The signal generator is now configured for 360B source lock mode operation.

Initiating 360B Source Lock Mode Operations

Turn on the 360B and configure it for source lock mode of operation. (Refer to the 360B VNA operation manual.) Once configured, the 360B takes control of the signal generator.

When the 360B takes control, the display of all parameters on the 682XXB/683XXB is disabled and the messages SS MODE, Secure Mode Active, and Remote appear on the front panel display.

SS MODE

When SS Mode is selected on, this message is displayed (in the frequency mode title bar) on all menu displays to remind the operator that the 682XXB/683XXB is in a source lock mode.

NOTES

A 360B VNA and a 68237B/68337B, 68253B/68353B, or 68263B/68363B Source in SS Mode should not be operated below 2.1 GHz because it may fail to lock.

A 360B VNA and a 682X5B/683X5B Source in SS Mode should not be operated below 600 MHz because it may fail to lock.

A 360B VNA that is using a 3612A, 3613A, 3622A, 3623A, or 3631A Test Set and a 682XXB/683XXB Source in SS Mode should not be operated above 60 GHz because it will fail to lock. For operations above 60 GHz, use the 682XXB/683XXB Source in tracking mode.

Terminating 360B Source Lock Mode Operations

To terminate 360B VNA source lock mode operations, you must first return the 682XXB/683XXB to local control and then turn off the SS Mode.

To return the 682XXB/683XXB to local control, turn off the 360B VNA.

On the 682XXB/683XXB, press **SYSTEM**, then **Reset**. This turns off the Secure mode.

Next, press **SYSTEM**, then **Config** to access the System Configuration Menu display.

At the System Configuration Menu, press **GPIB**. When the Configure GPIB Menu (shown below) is displayed, press **SS Mode** to turn the SS mode off.

Tracking Mode

When operating in tracking mode, the 360B steers its second local oscillator frequency and phase signal so as to phase-lock itself to the reference signal from the 682XXB/683XXB. Frequency resolution is limited to 1 kHz intervals. This is because of the inherent resolution of the 360B's frequency readout.

Tracking Mode Configuration

In order for the 682XXB/683XXB to operate with a 360B in tracking mode, the signal generator must be operating in normal mode (SS Mode off). In addition, its GPIB address and data terminator must match the System Bus source address and data terminator that are set on the 360B VNA.

To verify the GPIB address and data terminator or to turn the SS mode off, press **SYSTEM**. At the System Menu display, press **Config**. When the System Configuration Menu is displayed, press **GPIB**. The Configure GPIB Menu (below) is displayed.

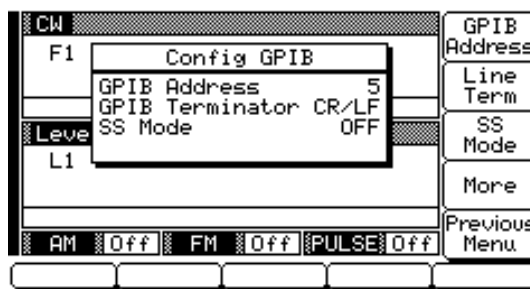

If the GPIB address of the 682XXB/683XXB needs changing, press **GPIB Address** . Enter the new address using the cursor control key or the data entry keypad and the terminator key

HZ
ns
ADRS

The new GPIB address will appear on the display.

To change the data terminator, press **Line Term** to select the correct GPIB data delimiter.

To turn SS mode off, press **SS Mode** .

The signal generator is now configured for 360B tracking mode operation.

Initiating 360B Tracking Mode Operations

Turn on the 360B and configure it for tracking mode of operation. (Refer to the 360B VNA operation manual.) Once configured, the 360B should take control of the signal generator.

When the 360B takes control, the display of all parameters on the 682XXB/683XXB is disabled and the messages Secure Mode Active and Remote appear on the front panel display.

Terminating 360B Tracking Mode Operations

To terminate 360B VNA tracking mode operations, you must first return the 682XXB/683XXB to local control and then turn off the Secure mode.

To return the 682XXB/683XXB to local control, turn off the 360B VNA.

On the 682XXB/683XXB, press **SYSTEM**, then **Reset** . This turns off the Secure mode and returns the signal generator to local control.

**7-5 USE WITH A 8003
SCALAR NETWORK
ANALYZER**

The 682XXB/683XXB signal generator is compatible with the Giga-tronics Model 8003 Scalar Network Analyzer (SNA). The following paragraphs provide instructions for connecting the 682XXB/683XXB to the 8003 SNA and setting up the signal generator so that it can operate as a signal source for the analyzer. Operating instructions for the scalar network analyzer can be found in the Giga-tronics Model 8003 Scalar Network Analyzer Operation Manual.

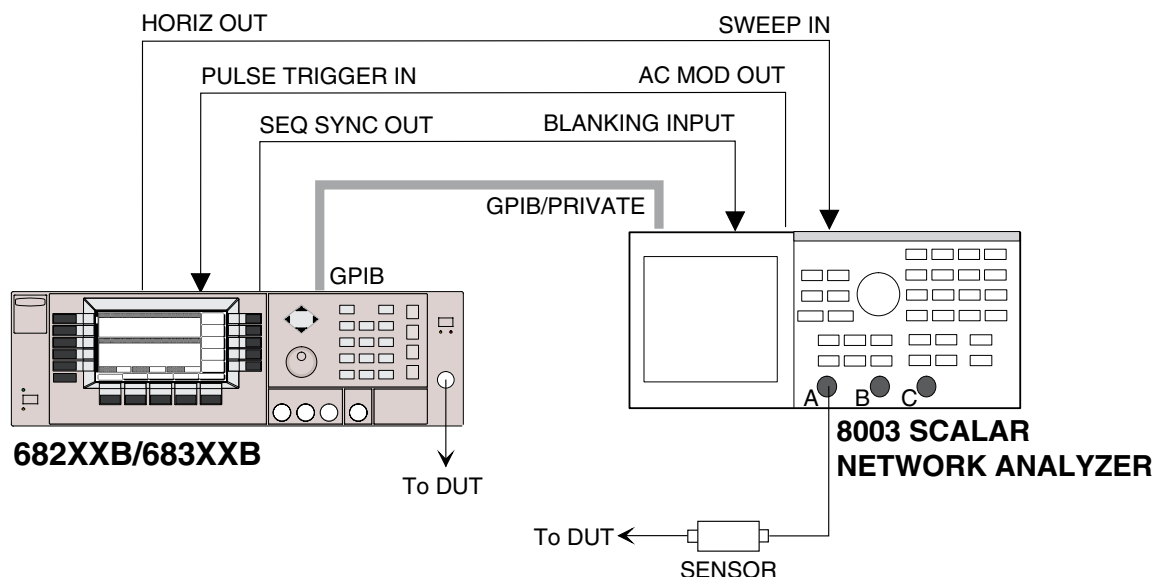

Figure 7-4. 682XXB/683XXB to 8003 SNA Connections

**Connecting
the 682XXB/
683XXB to the
8003**

Connect the 682XXB signal generator or 683XXB signal generator to the 8003 scalar network analyzer as shown in Figure 7-4.

- Step 1.** Connect one end of a GPIB cable to the 682XXB/683XXB rear panel IEEE-488 GPIB connector. Connect the other end of the cable to the 8003 rear panel GPIB/PRIVATE connector.
- Step 2.** Connect one end of a coaxial cable having BNC connectors to the 682XXB/683XXB rear panel HORIZ OUT connector. Connect the other end of the cable to the 8003 rear panel SWEEP IN connector.
- Step 3.** Connect one end of a coaxial cable having BNC connectors to the 682XXB/683XXB

rear panel PULSE TRIGGER IN connector. Connect the other end of the cable to the 8003 rear panel AC MOD OUT connector.

Step 4. Connect one end of a coaxial cable having BNC connectors to the 682XXB/683XXB rear panel SEQ SYNC OUT connector. Connect the other end of the cable to the 8003 rear panel BLANKING INPUT connector.

**Setting Up
the 682XXB/
683XXB**

The 682XXB/683XXB must be in the 8003 Scalar GPIB mode of operation in order to operate as a signal source for the SNA. The following paragraphs describe how to set up the 682XXB/683XXB to *enable* the 8003 Scalar GPIB mode.

On the 682XXB/683XXB front panel, press **LINE** to place the signal generator in operation.

Allow the signal generator to warm up, then press the **SYSTEM** main menu key. At the System Menu display, press **Config**. The System Configuration Menu (shown below) is displayed.

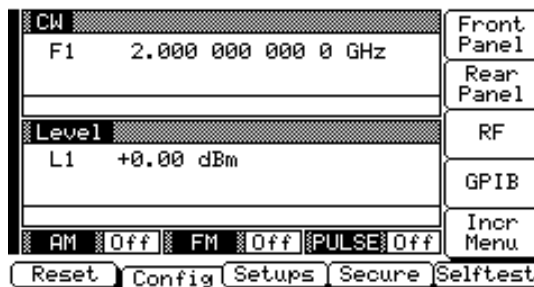

At the System Configuration menu, press **GPIB**. The Configure GPIB Menu (shown below) is displayed.

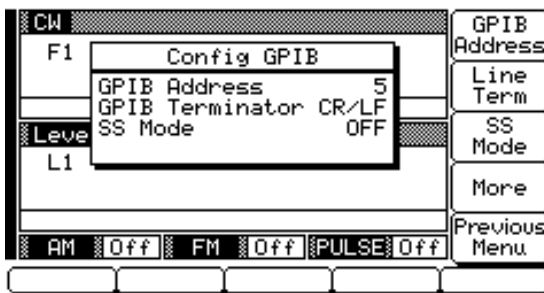

At the Configure GPIB menu, press **More** to go to the First Additional Configure GPIB Menu (below).

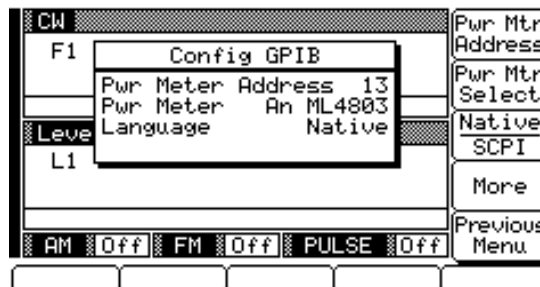

At this menu, press **More** to go to the Second Additional Configure GPIB Menu (below).

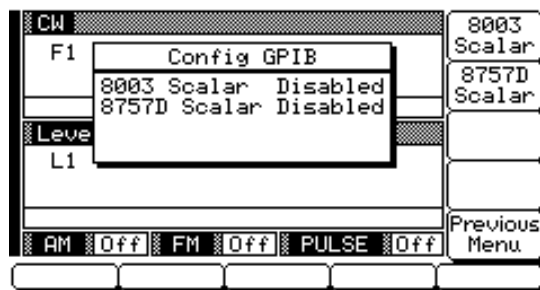

Press **8003 Scalar** to enable the 8003 Scalar GPIB mode. The display will reflect your selection.

The 682XXB/683XXB signal generator is now ready to operate as a signal source for the 8003 SNA.

***Initiating
8003 SNA
Operation***

To initiate SNA operation, turn ON the Model 8003 and calibrate a 8003 sensor(s). (Refer to the Model 8003 Scalar Network Analyzer Operation Manual for the calibration procedure.)

Use the following procedure to set the 8003 Source Address to "5". (The default address is "6".)

- Step 1** On the 8003 front panel, press the CONFIG key.
- Step 2** Select GPIB DEVICES from the menu displayed on the CRT screen.
- Step 3** Select SOURCE, then SOURCE ADDRESS.
- Step 4** Enter 5 on the keypad, then press the dB/GHz termination key.

The 8003 will search for a source at address "5". (The default GPIB address of the series 682XXB/683XXB signal generators is "5".) When the 8003 has properly identified the 682XXB/683XXB, the message "Initializing W6700" will be displayed on the 8003 CRT screen. (The 682XXB/683XXB emulates the ANRITSU 6700B Swept Frequency Synthesizer GPIB command codes.)

**7-6 USE WITH A HP8757D
SCALAR NETWORK
ANALYZER**

**Models 682XXB with Firmware Version 2.42 and above
(Models 682X5B with Firmware Version 1.31 and above)
Models 683XXB with Firmware Version 2.53 and above
(Models 683X5B with Firmware Version 1.35 and above)**

The 682XXB/683XXB signal generator is compatible with the Hewlett Packard Model 8757D Scalar Network Analyzer (SNA). The following paragraphs provide instructions for connecting the 682XXB/683XXB to the HP8757D SNA and setting up the signal generator so that it can operate as a signal source for the analyzer. Operating instructions for the scalar network analyzer can be found in the Hewlett Packard Model 8757D Scalar Network Analyzer Operation Manual.

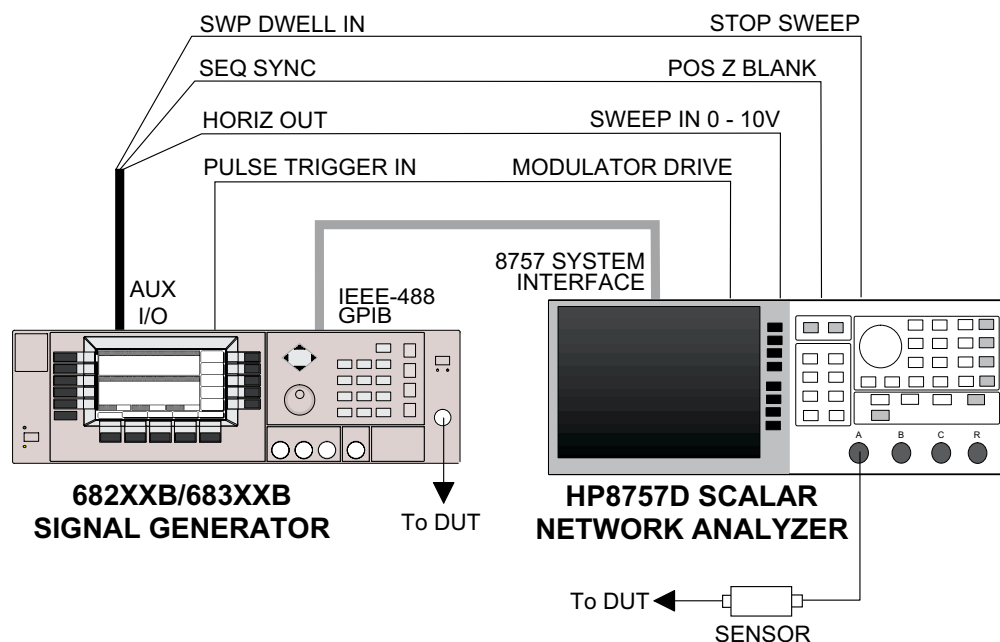

Figure 7-5. 682XXB/683XXB to HP8757D SNA Connections

**Connecting
the 682XXB/
683XXB to the
HP8757D**

Connect the 682XXB/683XXB signal generator to the HP8757D scalar network analyzer as shown in Figure 7-5.

- Step 1** Connect one end of a GPIB cable to the 682XXB/683XXB rear panel IEEE-488 GPIB connector. Connect the other end to the HP8757D rear panel 8757 SYSTEM INTERFACE connector.

Step 2 Connect one end of a coaxial cable having BNC connectors to the 682XXB/683XXB rear panel PULSE TRIGGER IN connector. Connect the other end of the cable to the HP8757D rear panel MODULATOR DRIVE connector.

Step 3 Connect the special AUX I/O interface cable (Anritsu Part No. 806-90) to the 682XXB/683XXB rear panel AUX I/O connector. Connect the cable end having BNC connectors as follows:

- a. Connect the cable end labeled "SEQ SYNC" to the HP8757D rear panel POS Z BLANK connector.
- b. Connect the cable end labeled "SWP DWELL IN" to the HP8757D rear panel STOP SWEEP connector.
- c. Connect the cable end labeled "HORIZ OUT" to the HP8757D rear panel SWEEP IN 0 - 10V connector.

**Setting up the
682XXB/
683XXB**

The 682XXB/683XXB must be set to GPIB address 19 and in the 8757D Scalar mode of operation to function as a signal source for the SNA. The following paragraphs describe how to set up the 682XXB/683XXB to enable 8757D Scalar GPIB mode.

On the 682XXB/683XXB front panel, press **LINE** to place the signal generator in operation.

Allow the signal generator to warm up, then press the **SYSTEM** main menu key. At the System Menu display, press **Config**. The System Configuration Menu (below) is displayed.

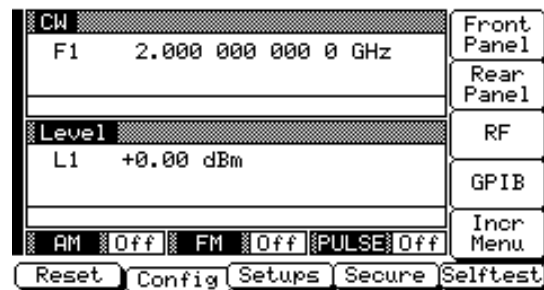

At the System Configuration menu, press **GPIB**. The Configure GPIB Menu (on the following page) is displayed.

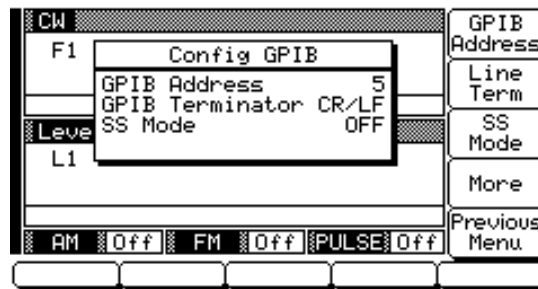

Press **GPIB Address** to change the address of the 682XXB/683XXB on the bus. Enter 19 using the cursor control key or the data entry keypad and the terminator key.



The new GPIB address (19) will appear on the display.

Press **More** to go to the First Additional Configure GPIB menu (below).

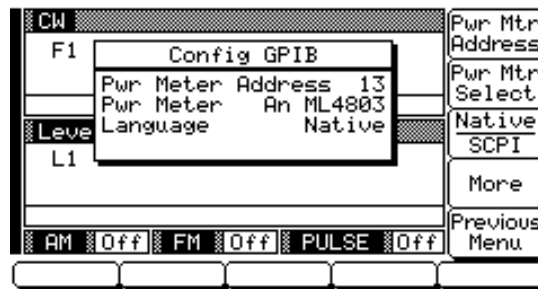

At this menu, press **More** to go to the Second Additional Configure GPIB menu (below).

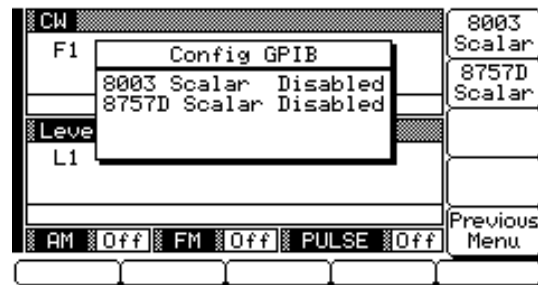

Press **8757D Scalar** to enable the 8757D Scalar GPIB mode. When enabled, the 683XXB will shift to the analog sweep frequency mode (the 682XXB will shift to step sweep frequency mode) sweeping at the full range of the instrument.

***Initiating
HP8757D
SNA
Operation***

Turn ON the HP8757D to initiate scalar network analyzer operation. (Refer to the Hewlett Packard Model 8757D Scalar Network Analyzer Operation Manual for operating instructions.)

Appendix A

Rear Panel Connectors

A-1 INTRODUCTION

This appendix provides descriptions for the rear panel connectors on a typical Series 682XXB/683XXB Synthesized Signal Generator.

A-2 REAR PANEL CONNECTORS

Figure A-1 provides a illustration of the rear panel and describes the rear panel connectors.

A-3 CONNECTOR PINOUT DIAGRAMS

Figures A-2 and A-3 provide pinout diagrams and descriptions for the AUX I/O and IEEE-488 GPIB multipin connectors on the rear panel.

REAR PANEL CONNECTORS

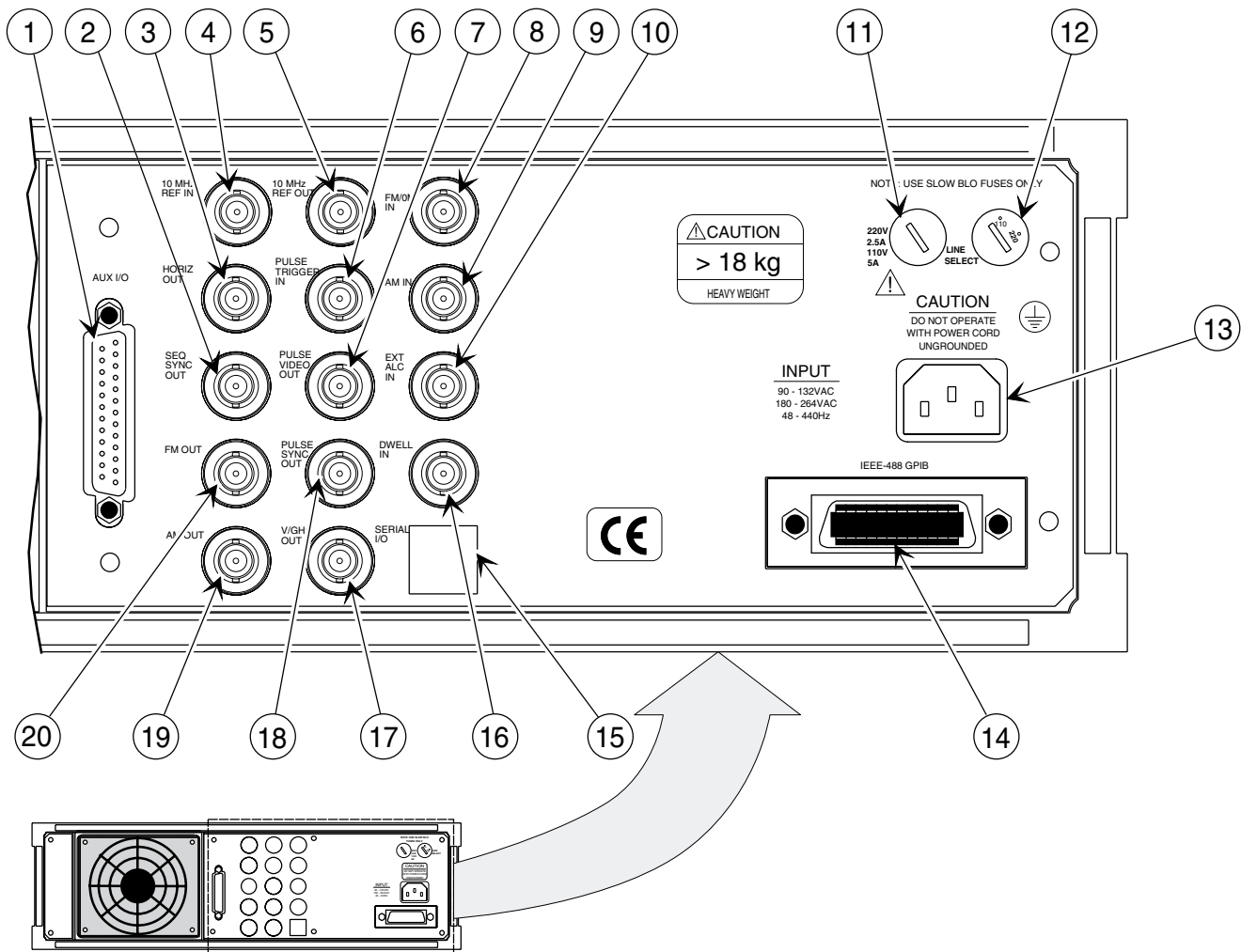

- ① **AUX I/O:** 25-pin connector that provides for single cable interface with another signal generator (master-slave operation) and with other ANRITSU instruments such as the ANRITSU 562 Scalar Network Analyzer. A connector pin-out diagram is shown in Figure A-2.
- ② **SEQ SYNC OUT:** Provides a +5V signal during sweep retrace, at bandswitching points, and during each frequency step in step sweep mode. Also, when video markers are selected, provides -5V marker pulses and a -10V selected marker pulse during forward sweep. BNC connector.
- ③ **HORIZ OUT:** Provides a 0V to 10V ramp during all sweep modes, regardless of sweep width. In the CW mode, provides a voltage between 0V and 10V proportional to the full frequency range of the instrument. When the CW Ramp is enabled, connector provides a repetitive 0V to 10V ramp. BNC connector, 50Ω impedance.
- ④ **10 MHz REF IN:** Accepts an external 10 MHz ±100 Hz, 0 to 10 dBm time-base signal. Automatically disconnects the internal high-stability, time-base option, if installed. BNC connector, 50Ω impedance.

Figure A-1. Rear Panel, Series 682XXB/683XXB Synthesized Signal Generator (1 of 2)

REAR PANEL CONNECTORS

- ⑤ **10 MHz REF OUT:** Provides a 0.5 V_{p-p}, AC coupled, 10 MHz signal derived from the internal frequency standard of the signal generator. BNC connector, 50Ω impedance.
- ⑥ **PULSE TRIGGER IN:** Accepts an external TTL compatible signal to pulse modulate the RF output signal or to trigger or gate the internal pulse generator. BNC connector.
- ⑦ **PULSE VIDEO OUT:** Provides video modulating signal from the internal pulse generator or external pulse input. BNC connector.
- ⑧ **FM/ΦM IN:** Accepts an external modulating signal to produce FM/(ΦM with Option 06) on the RF output. FM/ΦM sensitivity, FM/ΦM mode, and input impedance (50Ω or 600Ω) are selectable via front panel menu or GPIB. BNC connector.
- ⑨ **AM IN:** Accepts an external modulating signal to produce AM on the RF output. AM sensitivity (Linear or Log) and input impedance (50Ω or 600Ω) are selectable via front panel menu or GPIB. BNC connector.
- ⑩ **EXT ALC IN:** Provides for leveling the RF output signal externally with either a remote detector or a power meter. Connector accepts a positive or negative 0.5—500 mV signal from a remote detector or a ±1V signal from a remote power meter. BNC connector.
- ⑪ **Line Fuse:** Provides over-voltage/current protection for signal generator circuits during operation and standby. Unit requires a 5A, slow blow fuse for 110 Vac line voltage or a 2.5A, slow blow fuse for 220 Vac line voltage.
- ⑫ **LINE SELECT Switch:** Provides selection of 110 or 220 Vac line voltages. When 110 Vac is selected, the 682XXB/683XXB accepts 90-132 Vac, 48-440 Hz line voltage; when 220 Vac is selected, the 682XXB/683XXB accepts 180-264 Vac, 48-440 Hz line voltage.
- ⑬ **Input Line Voltage Receptacle:** Provides for connecting line voltage to the 682XXB/683XXB signal generator.
- ⑭ **IEEE-488 GPIB:** 24-pin connector that provides for remotely controlling the signal generator from an external controller via the IEEE-488 bus (GPIB). A connector pinout diagram is shown in Figure A-3.
- ⑮ **SERIAL I/O:** Provides access to two RS-232 terminal ports to support service and calibration functions and master-slave operations. RJ45 connector.
- ⑯ **DWELL IN:** Accepts an external TTL low-level signal to pause the sweep in both analog and step sweep modes. The sweep resumes when the signal is removed. BNC connector.
- ⑰ **V/GHz OUT:** Provides a reference voltage relative to the frequency of the RF output (see table below). BNC connector.

Model Number	V/GHz Output
68X37B, 68X45B, 68X47B	1.0V/GHz
68X53B, 68X55B, 68X59B	0.5V/GHz
68X63B, 68X65B, 68X69B	0.5V/GHz
68X75B, 68X77B	0.25V/GHz
68X85B, 68X87B	0.25V/GHz
68X95B, 68X97B	0.25V/GHz

- ⑱ **PULSE SYNC OUT:** Provides a TTL compatible signal synchronized to the internal pulse modulation output. BNC connector.
- ⑲ **AM OUT:** Provides video modulating signal from the internal AM generator. BNC connector.
- ⑳ **FM OUT:** Provides video modulating signal from the internal FM generator. BNC connector.

Figure A-1. Rear Panel, Series 682XXB/683XXB Synthesized Signal Generator (2 of 2)

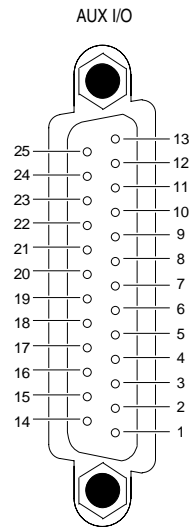

PIN	SIGNAL NAME	SIGNAL DESCRIPTION
1	HORIZ OUTPUT	<i>Horizontal Sweep Output:</i> Provides a 0V at beginning and +10V at end of sweep for all sweep modes, regardless of sweep width. In the CW mode, the voltage is proportional to frequency between 0V at low end and +10V at the high end of range. In CW mode, if CW Ramp is enabled, a repetitive, 0V to +10V ramp is provided. The ramp speed is adjusted by the Sweep Time function.
2	GND	Chassis Ground
3	SEQ SYNC	<i>Sequential Sync Output:</i> Provides a +5V signal during sweep retrace, at band-switching points, and during each frequency step in step sweep mode, -5V during markers, and -10V during the selected marker.
4	L ALT ENABLE	<i>L-Alternate Enable Output:</i> Provides a TTL low-level signal which indicates that the alternate sweep mode is active.
5	MARKER OUTPUT	<i>Marker Output:</i> Provides a +5V or -5V signal during a marker. Signal polarity selected from a front panel menu.
6	RETRACE BLANKING	<i>Retrace Blanking Output:</i> Provides a +5V or -5V signal coincident with sweep retrace. Signal polarity selected from a front panel menu.
7	L ALT SWP	<i>L-Alternate Sweep Output:</i> Provides a TTL low-level signal to indicate that the primary sweep is in progress or a TTL high-level signal to indicate that the alternate sweep is in progress.
8	Shield	Cable Shield/Chassis Ground
9	TRIGGER OUTPUT	<i>Trigger Output:</i> Provides a TTL low-level trigger signal for external devices or instruments.
10	SWP DWELL OUT	<i>Sweep Dwell Output:</i> Provides an open-collector output which goes to ground when the sweep is dwelled at the start, stop, and bandswitching frequencies, and at the markers.
11	LOCK STATUS	<i>Lock Status Output:</i> Provides a TTL high-level signal when the frequency is phase-locked.
12	RXb	<i>RXb:</i> Serial Data Input to the processor (/t1).
13	EXT TRIGGER	<i>External Trigger:</i> Accepts a TTL low-level signal of 1 μ s width to trigger a sweep.

Figure A-2. Pinout Diagram, AUX I/O Connector (1 of 2)

PIN	SIGNAL NAME	SIGNAL DESCRIPTION
14	V/GHz	<i>V/GHz Output:</i> Provides a reference voltage relative to the RF output frequency (1.0 V/GHz for Models 68X37B, 68X45B, and 68X47B; 0.5 V/GHz for Models 68X53B, 68X55B, 68X59B, 68X63B, 68X65B, and 68X69B; 0.25V/GHz for Models 68X75B, 68X77B, 68X85B, 68X87B, 68X95B, and 68X97B).
15	EOS INPUT	<i>End-of-Sweep Input:</i> Accepts a TTL high-level signal to tell the signal generator to begin the end of sweep dwell.
16	EOS OUTPUT	<i>End-of-Sweep Output:</i> Provides a TTL high-level signal when the signal generator has begun the end of sweep dwell.
17	AUX 1	<i>Aux 1:</i> Auxiliary input/output to the processor (PB6).
18	SWP DWELL IN	<i>Sweep Dwell Input:</i> Permits a TTL low-level signal to stop the sweep in both analog- and step-sweep modes. The sweep resumes when the signal is removed.
19	AUX 2	<i>Aux 2:</i> Auxiliary input/output to the processor (PC3).
20	BANDSWITCH BLANK	<i>Bandswitch Blanking Output:</i> Provides a +5V or -5V signal coincident with band-switching points. Signal polarity is selected from a front panel menu.
21	SPARE	
22	HORIZ IN	<i>Horizontal Sweep Input:</i> Accepts a 0V to 10V external sweep ramp from a Master signal generator. This input is automatically selected when the signal generator is in the Slave Mode.
23	Return	Horizontal Sweep Input return.
24	TXb	<i>TXb:</i> Serial Data Output from the processor.
25	MEMORY SEQ	<i>Memory Sequencing Input:</i> Accepts a TTL low-level signal to sequence through nine stored, front panel setups.

Figure A-2. Pinout Diagram, AUX I/O Connector (2 of 2)

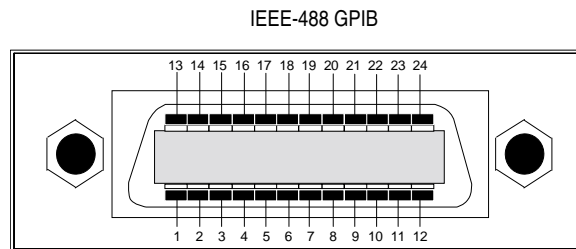

PIN	SIGNAL NAME	SIGNAL DESCRIPTION
1-4	DIO 1 thru DIO 4	<i>Data Input/Output:</i> Bits are HIGH when the data is logical 0 and LOW when the data is logical 1.
5	EOI	<i>End or Identify:</i> A low-true state indicates that the last byte of a multibyte message has been placed on the line.
6	DAV	<i>Data Valid:</i> A low-true state indicates that the active talker has (1) sensed that NRFD is high-false and NDAC is low-true, (2) placed the data byte on the bus, and (3) waited an appropriate length of time for the data to settle.
7	NRFD	<i>Not Ready For Data:</i> A high-false state indicates that all active listeners are ready to accept new data.
8	NDAC	<i>Not Data Accepted:</i> A low-true state indicates that all addressed listeners have accepted the current data byte for internal processing.
9	IFC	<i>Interface Clear:</i> A low-true state places all bus instruments in a known, quiescent state—unaddressed to talk, unaddressed to listen, and service request idle.
10	SRQ	<i>Service Request:</i> A low-true state indicates that a bus instrument desires the immediate attention of the controller.
11	ATN	<i>Attention:</i> A low-true state indicates that the bus is in the command mode (data lines are carrying bus commands). A high-false state indicates that the bus is in the data mode (data lines are carrying device-dependent instructions or data).
12	Shield	Chassis Ground
13-16	DIO5 thru DIO6	<i>Data Input/Output:</i> Bits are HIGH when the data is logical 0 and LOW when the data is logical 1.
17	REN	<i>Remote Enable:</i> A low-true state enables bus instruments to be operated remotely, when addressed.
18-24	GND	Logic Ground

Figure A-3. Pinout Diagram, IEEE-488 GPIB Connector

Appendix B

Performance Specifications

B-1 INTRODUCTION

This appendix contains the following performance specifications:

- Series 682XXB Synthesized Signal Generator performance specifications beginning on page B-3.
- Series 683XXB Synthesized Signal Generator performance specifications beginning on page B-13.

Series 682XXB

Synthesized Signal Generator

Performance Specifications

MODEL SUMMARY

Model	Frequency Range
68237B	2.0 to 20.0 GHz
68245B	0.5 to 20.0 GHz
68247B	0.01 to 20.0 GHz
68253B	2.0 to 26.5 GHz
68255B	0.5 to 26.5 GHz
68259B	0.01 to 26.5 GHz
68263B	2.0 to 40.0 GHz
68265B	0.5 to 40.0 GHz
68269B	0.01 to 40.0 GHz
68275B	0.5 to 50.0 GHz
68277B	0.01 to 50.0 GHz
68285B	0.5 to 60.0 GHz
68287B	0.01 to 60.0 GHz
68295B	0.5 to 65.0 GHz (with usable output to 67 GHz)
68297B	0.01 to 65.0 GHz (with usable output to 67 GHz)

FREQUENCY

CW MODE

Output: Twenty independent, presettable CW frequencies (F0 – F9 and M0 – M9).

Accuracy: Same as internal or external 10 MHz time base.

Internal Time Base Stability:

With Aging: $<2 \times 10^{-8}$ /day
($<5 \times 10^{-10}$ /day with Option 16)

With Temperature: $<2 \times 10^{-8}$ /°C over 0°C to 55°C
($<2 \times 10^{-10}$ /°C with Option 16)

Resolution:

1 kHz (0.1 Hz with Option 11)

External 10 MHz Reference Input: Accepts external 10 MHz ± 100 Hz, 0 to +10 dBm time base signal. Automatically disconnects the internal high-stability time-base option, if installed. BNC, rear panel, 50 Ω impedance.

10 MHz Reference Output: 0.5 Vp-p into 50 Ω , AC coupled. Rear panel BNC; 50 Ω impedance.

Switching Time (typical maximum): <40 ms to be within 1 kHz of final frequency.

PHASE-LOCKED STEP SWEEP MODE

Sweep Width: Independently selected, 1 kHz (0.1 Hz with Option 11) to full range. Every frequency step in sweep range is phase-locked.

Accuracy: Same as internal or external 10 MHz time base.

Resolution (Minimum Step Size):

1 kHz (0.1 Hz with Option 11)

Steps: User-selectable number of steps or step size.

Number of Steps: Variable from 1 to 10,000

Step Size: 1 kHz (0.1 Hz with Option 11) to the full frequency range of the instrument. (If the step size does not divide into the selected frequency range, the last step is truncated.)

Dwell Time Per Step: Variable from 1 ms to 99 seconds

Switching Time (typical maximum): <15 ms + 1 ms/GHz step size or <40 ms, whichever is less.

ALTERNATE SWEEP MODE

Sweeps alternately in step sweep between any two sweep ranges. Each sweep range may be associated with a different power level.

MANUAL SWEEP MODE

Provides stepped, phase-locked adjustment of frequency between sweep limits. User-selectable number of steps or step size.

360B VNA SOURCE LOCK MODE

Under control of the ANRITSU 360B Vector Network Analyzer, the synthesized signal generator is phase-locked at a typical <8.5 ms/step sweep speed. Frequency resolution is limited to 100 kHz.

Minimum specified frequency is 0.6 GHz for 682X5B units and 2.1 GHz for models 68237B, 68253B, and 68263B.

PROGRAMMABLE FREQUENCY AGILITY

Under GPIB control, up to 1000 non-sequential frequencies can be stored and then addressed as a phase-locked step sweep. Data stored in volatile memory.

MARKERS

Up to 20 independent, settable markers (F0 – F9 and M0 – M9).

Video Markers: +5V or –5V marker output, selectable from system menus. AUX I/O connector, rear panel.

Marker Accuracy: Same as sweep frequency accuracy.

Marker Resolution:
1 kHz (0.1 Hz with Option 11)

SWEEP TRIGGERING

Sweep triggering is provided for Step Frequency Sweep and CW Power Sweep.

Auto: Triggers sweep automatically.

External: Triggers a sweep on the low to high transition of an external TTL signal. AUX I/O connector, rear panel.

Single: Triggers, aborts, and resets a single sweep. Reset sweep may be selected to be at the top or bottom of the sweep. The pen lift will activate at sweep speeds ≥ 1 second.

SPECTRAL PURITY

All specifications apply to the phase-locked CW and Step Sweep modes at the lesser of +10 dBm output or maximum specified leveled output power, unless otherwise noted.

SPURIOUS SIGNALS

Harmonic and Harmonic Related:

- 500 MHz to ≤ 2.2 GHz (682X5B): ≤ -50 dBc
- 10 MHz to ≤ 50 MHz: ≤ -30 dBc
- >50 MHz to ≤ 2 GHz: ≤ -40 dBc
- >2 GHz (2.2 GHz for 682X5B) to ≤ 20 GHz: ≤ -60 dBc
- >20 GHz to ≤ 40 GHz: ≤ -40 dBc

Harmonic and Harmonic Related (Models having an high-end frequency of >40 GHz and units with Option 15B at maximum specified leveled output power):

- 500 MHz to ≤ 2.2 GHz (682X5B): ≤ -50 dBc
- 10 MHz to ≤ 50 MHz: ≤ -30 dBc
- >50 MHz to ≤ 2 GHz: ≤ -40 dBc
- >2 GHz (2.2 GHz for 682X5B) to ≤ 20 GHz: ≤ -50 dBc
- >20 GHz to ≤ 40 GHz: ≤ -40 dBc
- 50 GHz units; >40 GHz to ≤ 50 GHz: ≤ -40 dBc
- 60 GHz units; >40 GHz to ≤ 60 GHz: ≤ -30 dBc
- 65 GHz units; >40 GHz to ≤ 45 GHz: ≤ -25 dBc
- >45 GHz to ≤ 65 GHz: ≤ -30 dBc

Nonharmonics:

- 500 MHz to ≤ 2.2 GHz (682X5B): ≤ -50 dBc
- 10 MHz to ≤ 2 GHz: ≤ -40 dBc
- >2 GHz (2.2 GHz for 682X5B) to ≤ 65 GHz: ≤ -60 dBc

**SINGLE-SIDEBAND PHASE NOISE
(dBc/Hz)**

Frequency (GHz)	Offset From Carrier			
	100 Hz	1 kHz	10 kHz	100 kHz
0.6 (682X5B)	-87	-100	-98	-115
0.6	-77	-88	-86	-100
2.0 (682X5B)	-81	-94	-92	-109
2.0	-80	-88	-86	-102
6.0	-78	-88	-86	-102
10.0	-73	-86	-83	-102
20.0	-66	-78	-78	-100
26.5	-63	-78	-76	-96
40.0	-60	-75	-72	-94
50.0	-54	-69	-66	-88
65.0	-54	-69	-64	-88

POWER LINE and FAN ROTATION SPURIOUS EMISSIONS (dBc)

Frequency Range (GHz)	Offset From Carrier		
	<300 Hz	300Hz to 1 kHz	>1 kHz
0.5 to ≤ 1.0 (682X5B)	≤ -62	≤ -72	≤ -72
>1.0 to ≤ 2.2 (682X5B)	≤ -56	≤ -66	≤ -66
0.01 (>2.2 for 682X5B) to ≤ 8.4	≤ -50	≤ -60	≤ -60
>8.4 to ≤ 20	≤ -46	≤ -56	≤ -60
>20 to ≤ 40	≤ -40	≤ -50	≤ -54
>40 to ≤ 65	≤ -34	≤ -44	≤ -48

PERFORMANCE SPECIFICATIONS

SERIES 682XXB SYNTHESIZED SIGNAL GENERATOR

RESIDUAL FM (50 Hz - 15 kHz BW)

Frequency Range (GHz)	Residual FM (Hz RMS)
0.5 to ≤1.0 (682X5B)	<30
>1.0 to ≤2.2 (682X5B)	<60
0.01 (>2.2 for 682X5B) to ≤8.4	<120
>8.4 to ≤20	<220
>20 to ≤40	<440
>40 to ≤65	<880

RESIDUAL FM (Unlocked FM modes, 50 Hz - 15 kHz BW)

Frequency Range (GHz)	Unlocked Narrow FM Mode (kHz RMS)	Unlocked Wide FM Mode (kHz RMS)
0.5 to ≤1.0 (682X5B)	<1.25	<6.3
>1.0 to ≤2.2 (682X5B)	<2.5	<12.5
0.01 (>2.2 for 682X5B) to ≤20	<5	<25
>20 to ≤40	<10	<50
>40 to ≤65	<20	<100

AM Noise Floor:

Typically -145 dBm/Hz at 0 dBm output and offsets >5 MHz from carrier.

RF OUTPUT

Power level specifications apply at 25° ±10° C.

MAXIMUM LEVELED OUTPUT POWER

Model Number	Frequency Range (GHz)	Output Power (dBm)	Output Power with Step Attenuator (dBm)
68237B	2.0 to ≤20.0	+13.0	+11.0
68245B	0.5 to ≤20.0	+13.0	+11.0
68247B	0.01 to ≤20.0	+13.0	+11.0
68253B	2.0 to ≤20.0 >20.0 to ≤26.5	+9.0 +6.0	+7.0 +3.5
68255B	0.5 to ≤2.2 >2.2 to ≤20.0 >20.0 to ≤26.5	+13.0 +9.0 +6.0	+11.0 +7.0 +3.5
68259B	0.01 to ≤2.0 >2.0 to ≤20.0 >20.0 to ≤26.5	+13.0 +9.0 +6.0	+11.0 +7.0 +3.5
68263B	2.0 to ≤20.0 >20.0 to ≤40.0	+9.0 +6.0	+7.0 +3.0
68265B	0.5 to ≤2.2 >2.2 to ≤20.0 >20.0 to ≤40.0	+13.0 +9.0 +6.0	+11.0 +7.0 +3.0
68269B	0.01 to ≤2.0 >2.0 to ≤20.0 >20.0 to ≤40.0	+13.0 +9.0 +6.0	+11.0 +7.0 +3.0
68275B	0.5 to ≤2.2 >2.2 to ≤20.0 >20.0 to ≤40.0 >40.0 to ≤50.0	+11.0 +10.0 +2.5 +2.5	+10.0 +8.5 0.0 -1.0
68277B	0.01 to ≤2.0 >2.0 to ≤20.0 >20.0 to ≤40.0 >40.0 to ≤50.0	+12.0 +10.0 +2.5 +2.5	+10.0 +8.5 0.0 -1.0
68285B	0.5 to ≤2.2 >2.2 to ≤20.0 >20.0 to ≤40.0 >40.0 to ≤50.0 >50.0 to ≤60.0	+11.0 +10.0 +2.5 +2.0 +2.0	+10.0 +8.5 0.0 -1.5 -2.0
68287B	0.5 to ≤2.0 >2.0 to ≤20.0 >20.0 to ≤40.0 >40.0 to ≤50.0 >50.0 to ≤60.0	+12.0 +10.0 +2.5 +2.0 +2.0	+10.0 +8.5 0.0 -1.5 -2.0
68295B	0.5 to ≤2.2 >2.2 to ≤20.0 >20.0 to ≤40.0 >40.0 to ≤50.0 >50.0 to ≤65.0	+11.0 +10.0 +2.5 0.0 -2.0	Not Available

MAXIMUM LEVELED OUTPUT POWER (Continued)

Model Number	Frequency Range (GHz)	Output Power (dBm)	Output Power with Step Attenuator (dBm)
68297B	0.5 to ≤2.0	+12.0	Not Available
	>2.0 to ≤20.0	+10.0	
	>20.0 to ≤40.0	+2.5	
	>40.0 to ≤50.0	0.0	
	>50.0 to ≤65.0	-2.0	
With Option 15B (High Power) Installed			
68237B	2.0 to 20.0	+17.0	+15.0
68245B	0.5 to ≤2.2	+13.0	+11.0
	>2.2 to ≤20.0	+17.0	+15.0
68247B	0.5 to ≤2.2	+13.0	+11.0
	>2.2 to ≤20.0	+17.0	+15.0
68253B	2.0 to ≤20.0	+13.0	+11.0
	>20.0 to ≤26.5	+10.0	+7.5
68255B	0.5 to ≤20.0	+13.0	+11.0
	>20.0 to ≤26.5	+10.0	+7.5
68259B	0.01 to ≤20.0	+13.0	+11.0
	>20.0 to ≤26.5	+10.0	+7.5
68263B	2 to ≤20.0	+13.0	+11.0
	>20 to ≤40.0	+6.0	+3.0
68265B	0.5 to ≤20.0	+13.0	+11.0
	>20 to ≤40.0	+6.0	+3.0
68269B	0.01 to ≤20.0	+13.0	+11.0
	>20 to ≤40.0	+6.0	+3.0
68275B	0.5 to 50.0	Standard	Standard
68277B	0.01 to 50.0	Standard	Standard
68285B	0.5 to 60.0	Standard	Standard
68287B	0.01 to 60.0	Standard	Standard
68295B	0.5 to 65.0	Standard	Not Available
68297B	0.01 to 65.0	Standard	Not Available

LEVELED OUTPUT POWER RANGE

Without an Attenuator: Maximum leveled power to -15 dBm (-20 dBm typical). For units with Option 15B installed, minimum settable power is -5 dBm (-10 dBm typical).

With an Attenuator: Maximum leveled power to -115 dBm (-120 dBm typical). For 68275B, 68277B, 68285B, 68287B, and units with Option 15B installed, minimum settable power is -105 dBm (-110 dBm typical)

UNLEVELED OUTPUT POWER RANGE (typical)

Without an Attenuator: >40 dB below max power.

With an Attenuator: >130 dB below max power.

POWER LEVEL SWITCHING TIME (to within specified accuracy):

Without Change in Step Attenuator: <1 ms typical

With Change in Step Attenuator: <20 ms typical

ACCURACY AND FLATNESS

Attenuation Below Max Power	Frequency (GHz)					
	0.01-0.05	0.05-20	20-40	40-50	50-60	60-65
Accuracy:						
0-25 dB [Ⓢ]	±2.0 dB	±1.0 dB	±1.0 dB	±1.5 dB	±1.5 dB	±1.5 dB
25-60 dB	±2.0 dB	±1.0 dB	±1.0 dB	±1.5 dB	±3.5 dB [Ⓢ]	N/A
>60 dB	±2.0 dB	±1.0 dB	±1.0 dB	±2.5 dB [Ⓢ]	±3.5 dB [Ⓢ]	N/A
Flatness:						
0-25 dB [Ⓢ]	±2.0 dB	±0.8 dB	±0.8 dB	±1.1 dB	±1.1 dB	±1.1 dB
25-60 dB	±2.0 dB	±0.8 dB	±0.8 dB	±1.1 dB	±3.1 dB [Ⓢ]	N/A
>60 dB	±2.0 dB	±0.8 dB	±0.8 dB	±2.1 dB [Ⓢ]	±3.1 dB [Ⓢ]	N/A

OTHER OUTPUT POWER SPECIFICATIONS

Output Power Resolution: 0.01 dB

Source Impedance: 50Ω nominal

Source SWR (Internal Leveling):

Without Attenuator: <1.7 at <2 GHz typical
<1.6 at 2 to 20 GHz typical
<2.0 at >20 GHz typical

With Attenuator: <2.0 typical

Power Level Stability with Temperature:

0.04 dB/°C typical

Level Offset: Offsets the displayed power level to establish a new reference level.

OUTPUT ON/OFF: Toggles the RF output between an Off and On state. During the Off state, the RF oscillator is turned off. The On or Off state is indicated by two LEDs located below the OUTPUT ON/OFF key on the front panel.

RF On/Off Between Frequency Steps: System menu selection of RF On or RF Off during frequency switching in CW or Step Sweep modes.

RF On/Off During Retrace: System menu selection of RF On or RF Off during retrace.

Internal Leveling: Power is leveled at the output connector in all modes.

[Ⓢ] Typical

[Ⓢ] 0 to 25 dB or to minimum rated power, whichever is higher

External Leveling:

External Detector: Levels output power at a remote detector location. Accepts a positive or negative 0.5 mV to 500 mV input signal from the remote detector. EXT ALC ADJ adjusts the input signal range to an optimum value. BNC connector, front and rear panel.

External Power Meter: Levels output power at a remote power meter location. Accepts a $\pm 1V$ full scale input signal from the remote power meter. EXT ALC ADJ adjusts the input signal range to an optimum value. BNC connector, front and rear panel.

External Leveling Bandwidth:

30 kHz typical in Detector mode.

0.7 Hz typical in Power Meter mode.

User Level Flatness Correction:

Number of points: 2 to 801 points per table

Number of tables: 5 available

Entry modes: GPIB power meter or computed data

CW POWER SWEEP

Range: Sweeps between any two power levels at a single CW frequency.

Resolution: 0.01 dB/step

Accuracy: Same as CW power accuracy.

Step Size: User-controlled, 0.01 dB to the full power range of the instrument.

Step Dwell Time: Variable from 1 ms to 99 seconds. If the sweep crosses a step attenuator setting, there will be a sweep dwell of approximately 20 ms to allow setting of the step attenuator.

SWEEP FREQUENCY/STEP POWER

A power level step occurs after each frequency sweep. Power level remains constant for the length of time required to complete each sweep.

POWER METER (Option 8) ^③

Internal Power Meter Range: +16 dBm to -35 dBm. Compatible with ANRITSU 560-7, 5400-71, or 6400-71 Series Detectors. Rear panel input.

Power Meter Accuracy:

± 1 dB (+10 dBm to -10 dBm)

± 2 dB (-10 dBm to -35 dBm)

Power Meter Resolution: 0.1 dB minimum

MODULATION**AMPLITUDE MODULATION**

All amplitude modulation specifications apply at 50% depth, 1 kHz rate, with RF level set 6 dB below maximum specified leveled output power, unless otherwise noted.

External AM Input: Log AM or Linear AM input, front or rear-panel BNC, 50 Ω or 600 Ω input impedance. All options selectable from modulation menu.

AM Sensitivity:

Log AM: Continuously variable from 0 dB/volt to 25 dB/volt

Linear AM: Continuously variable from 0% per volt to 100% per volt

AM Depth (typical): 0-90% linear; 20 dB log

AM Bandwidth (3 dB):

DC to 50 kHz minimum

DC to 100 kHz typical

Flatness (DC to 10 kHz rates): ± 0.3 dB

Accuracy: $\pm 5\%$

Distortion : $< 5\%$ typical

Incidental Phase Modulation

(30% depth, 10 kHz rate): < 0.2 radians

Maximum Input: $\pm 1V$

INTERNAL AM GENERATOR

Waveforms: Sine, square, triangle, positive ramp, negative ramp, Gaussian noise, uniform noise, user-defined ^④.

Rate:

0.1 Hz to 1 MHz for sine wave

0.1 Hz to 100 kHz for square, triangle, and ramp waveforms

Resolution: 0.1 Hz

Accuracy: Same as instrument timebase.

Output: BNC connector, rear panel

SCAN MODULATOR (Option 20) ^④

Frequency Range: 1 to 20 GHz

Attenuation Range ^⑤: 0 to 60 dB

Flatness: ± 2.0 dB, 0 to 40 dB

± 3.5 dB, 40 to 60 dB

Step Response: < 1 μ s

Sensitivity: -10 dB/V

Insertion Loss (when on): < 6 dB, 1 to 18 GHz
 < 8 dB, 18 to 20 GHz

Input: Rear-panel BNC connector

^③ When Option 8 Power Meter is installed, Option 7 (Delete AM/FM Generators) is not available.

^④ Option 20 SCAN Modulator is available on models 68237B, 68245B, and 68247B only. When Option 20 SCAN Modulator is installed, Option 7 (Delete AM/FM Generators) and Option 18 (mmWave Module Bias Output) are not available.

^⑤ Maximum attenuation = attenuation range \pm flatness.

^⑥ User-defined waveforms are available with Option 10 Complex Modulation Capability.

FREQUENCY MODULATION

External FM Input: Front or rear panel BNC, 50 Ω or 600 Ω input impedance. All options selectable from modulation menu.

FM Sensitivity: Continuously variable from ± 10 kHz per volt to ± 20 MHz per volt (Locked, Locked Low-Noise, and Unlocked Narrow FM modes) or ± 100 kHz per volt to ± 100 MHz per volt (Unlocked Wide FM mode), selectable from modulation menu.

(For 682X5B units, maximum sensitivity is divided by 2 from 1.0 to 2.2 GHz and divided by 4 from 0.5 to 1.0 GHz.)

Maximum FM Deviation:**Locked Mode (1 kHz to 8 MHz rates):**

The lesser of ± 10 MHz or rate x 300

Locked Low-Noise Mode (DC to 500 kHz rates):

The lesser of ± 10 MHz or rate x 3

Unlocked Narrow Mode (DC to 8 MHz rates):

± 10 MHz

Unlocked Wide Mode (DC to 100 Hz rates):

± 100 MHz

(For 682X5B units, maximum deviation is divided by 2 from 1.0 to 2.2 GHz and divided by 4 from 0.5 to 1.0 GHz.)

FM Bandwidth (3 dB):

Locked Mode: 1 kHz to 10 MHz

Locked Low-Noise Mode: 30 kHz to 10 MHz

Unlocked Narrow Mode: DC to 10 MHz

Unlocked Wide Mode: DC to 100 Hz

Flatness (Locked Mode 10 kHz to 1 MHz rates): ± 1 dB

Accuracy (100 kHz rate):^⑦ 10% (5% typical)

Incidental AM (± 1 MHz deviation, 1 MHz rate): <2%

Harmonic Distortion (± 1 MHz deviation, 10 kHz rate): <1%

Maximum Input: ± 1 V

INTERNAL FM GENERATOR

Waveforms: Sine, square, triangle, positive ramp, negative ramp, Gaussian noise, uniform noise, user-defined^⑥.

Rate:

0.1 Hz to 1 MHz for sine wave

0.1 Hz to 100 kHz for square, triangle, and ramp waveforms

Resolution: 0.1 Hz

Accuracy: Same as instrument timebase.

Output: BNC connector, rear panel

PHASE MODULATION (Φ M) (Option 6)

External Φ M Input: Front or rear panel BNC (shares the FM input), 50 Ω or 600 Ω input impedance. All options selectable from modulation menu.

Φ M Sensitivity: Continuously variable from ± 0.0025 radians per volt to ± 5.0 radians per volt (Narrow Φ M mode) or ± 0.25 radians per volt to ± 500.0 radians per volt (Wide Φ M mode), selectable from modulation menu.

(For 682X5B units, maximum sensitivity is divided by 2 from 1.0 to 2.2 GHz and divided by 4 from 0.5 to 1.0 GHz.)

 Φ M Deviation:**Narrow Mode (DC to 8 MHz rates):**

The lesser of ± 3 radians or ± 5 MHz/rate

Wide Mode (DC to 1 MHz rates):

The lesser of ± 400 radians or ± 10 MHz/rate

(For 682X5B units, maximum deviation is divided by 2 from 1.0 to 2.2 GHz and divided by 4 from 0.5 to 1.0 GHz.)

 Φ M Bandwidth (3 dB, relative to 100 kHz rate):

Narrow Mode: DC to 10 MHz

Wide Mode: DC to 1 MHz

 Φ M Flatness:

Narrow Mode (DC to 1 MHz rates): ± 1 dB

Wide Mode (DC to 500 kHz rates): ± 1 dB

Φ M Accuracy (at 100 kHz sine wave):^⑦ 10%

Maximum Input: ± 1 V

INTERNAL Φ M GENERATOR

(Shares the Internal FM Generator)

Waveforms: Sine, square, triangle, positive ramp, negative ramp, Gaussian noise, uniform noise, user-defined^⑥.

Rate:

0.1 Hz to 1 MHz for sine wave

0.1 Hz to 100 kHz for square, triangle, and ramp waveforms

Resolution: 0.1 Hz

Accuracy: Same as instrument timebase.

Output: BNC connector, rear panel

^⑥ User-defined waveforms are available with Option 10 Complex Modulation Capability.

^⑦ In external mode, accuracy applies at 1V peak input.

PULSE MODULATION

Pulse modulation specifications apply at maximum rated power, unless otherwise noted.

On/Off Ratio: >80 dB

Rise/Fall Time (10 to 90%): <10 ns (<5 ns typical) [Ⓢ]

Minimum Leveled Pulse Width:

<100 ns, ≥2 GHz

<1 μs, <2 GHz

Minimum Unleveled Pulse Width: <10 ns

Pulse Overshoot: <10% [Ⓢ]

Level Accuracy Relative to CW (100 Hz to 1 MHz PRF):

±0.5 dB, ≥1 μs pulse width

±1.0 dB, <1 μs pulse width

Video Feedthrough: <±10 mV, ≥2 GHz

Pulse Width Compression: <8 ns typical

Pulse Delay (typical):

Mode	Pulse Delay (ns)
External	50
Triggered	100
Triggered with delay	200

PRF Range: DC to 10 MHz unleveled
100 Hz to 5 MHz leveled

External Input: Front or rear-panel BNC, selectable from modulation menu.

Drive Level: TTL compatible input

Input Logic: Positive-true or negative-true, selectable from modulation menu.

INTERNAL PULSE GENERATOR

Modes: Free-run, triggered, gated, delayed, doublet, triplet, quadruplet. All modes selectable from modulation menus.

Parameter	Clock Rate (Selectable)	
	40 MHz	10 MHz
Pulse Width	25 ns to 419 ms	100 ns to 1.6s
Pulse Period [Ⓢ]	250 ns to 419 ms	600 ns to 1.6s
Variable Delay		
Single	0 to 419 ms	0 to 1.6s
Doublet	100 ns to 419 ms	300 ns to 1.6s
Triplet	100 ns to 419 ms	300 ns to 1.6s
Quadruplet	100 ns to 419 ms	300 ns to 1.6s
Resolution	25 ns	100 ns

[Ⓢ] For 682X5B units, when operating below 1 GHz, rise/fall time is <15 ns.

[Ⓢ] For 50 GHz, 60 GHz, and 65 GHz units, when operating above 40 GHz, pulse overshoot is <20% typical at rated power.

[Ⓢ] Period must be at least 5 clock cycles longer than pulse widths + delays.

Accuracy: 10 ns (5 ns typical)

Output: Video pulse and sync out, rear-panel BNC connectors.

REMOTE OPERATION

All instrument functions, settings, and operating modes (except for power on/standby) are controllable using commands sent from an external computer via the GPIB (IEEE-488 interface bus).

GPIB Address: Selectable from a system menu

IEEE-488 Interface Function Subset:

Source Handshake: SH1

Acceptor Handshake: AH1

Talker: T6

Listener: L4

Service Request: SR1

Remote/Local: RL1

Parallel Poll: PP1

Device Clear: DC1

Device Trigger: DT1

Controller Capability: C0, C1, C2, C3, C28

Tri-State Driver: E2

GPIB Status Annunciators: When the instrument is operating in Remote, the GPIB status annunciators (listed below) will appear in a window on the front panel LCD.

REMOTE: Operating on the GPIB (all instrument front panel keys except for the SYSTEM key and the RETURN TO LOCAL soft-key will be ignored).

LLO (LOCAL LOCKOUT): Disables the RETURN TO LOCAL soft-key. Instrument can be placed in local mode only via GPIB or by cycling line power.

Emulations: The instrument responds to the published GPIB commands and responses of the ANRITSU Models 6600, 6700, and 6XX00-series signal sources. When emulating another signal source, the instrument will be limited to the capabilities, mnemonics, and parameter resolutions of the emulated instrument.

GENERAL

Stored Setups: Stores front panel settings and nine additional front-panel setups in a non-volatile RAM. A system menu allows saving and recalling of instrument setups. Whenever the instrument is turned on, control settings come on at the same functions and values existing when the instrument was turned off.

Memory Sequencing Input: Accepts a TTL low-level signal to sequence through nine stored setups. AUX I/O connector, rear panel.

Self-Test: Instrument self-test is performed when Selftest soft-key is selected. If an error is detected, an error message is displayed in a window on the LCD identifying the probable cause.

Secure Mode: Disables all frequency, power level, and modulation state displays. Stored setups saved in secure mode remain secured when recalled. Mode selectable from a system menu and GPIB.

Parameter Entry: Instrument-controlled parameters can be entered in three ways—keypad, rotary data knob, or the \wedge and \vee touch pads of the cursor-control key.

The keypad is used to enter new parameter values; the rotary data knob and the cursor-control key are used to edit existing parameter values. The < and > touch pads of the cursor-control key move the cursor left and right one digit under the open parameter. The rotary data knob or the \wedge and \vee touch pads will increment or decrement the digit position over the cursor.

Controlled parameters are frequency, power level, sweep time, dwell time, and number of steps.

Keypad entries are terminated by pressing the appropriate unit key (GHz/Sec/dBm, MHz/ms/dB, kHz/ μ s/STEPS, or Hz/ns/ADRS). Edits are terminated by exiting the edit menu.

Reset: Returns all instrument parameters to predefined default states or values. Any pending GPIB I/O is aborted. Selectable from the system menu.

Master/Slave Operation: Allows two 68XXXB output signals to be swept with a user-selected frequency offset. One 68XXXB synthesizer controls the other via AUX I/O and SERIAL I/O connections. Requires a Master/Slave Interface Cable Set (Part No. ND36329).

User Level Flatness Correction: Allows user to calibrate out path loss due to external switching and cables via entered power table from a GPIB power meter or calculated data. When user level correction is activated, entered power levels are delivered at the point where calibration was performed. Supported power meters are ANRITSU ML4803A and HP 437B, 438A, and 70100A. Five user tables are available with up to 801 points/table.

Warm Up Time (Standard Time Base):

From Standby: 30 minutes.

From Cold Start (0°C): 120 hours to achieve $<2 \times 10^{-8}$ per day frequency stability.

Warm Up Time (Option 16 Time Base):

From Standby: 30 minutes

From Cold Start (0°C): 120 hours to achieve $<5 \times 10^{-10}$ per day frequency stability.

Instruments disconnected from AC power for more than 72 hours require 30 days to return to specified aging

Power:

90-132 Vac or 180-264 Vac, 48–440 Hz, 400 VA maximum

Standby: With ac line power connected, unit is placed in standby when front panel power switch is released from the OPERATE position.

Weight: 23 kg (50 lb) maximum

Dimensions:

133 H x 429 W x 597 D mm

(5.25 H x 16.875 W x 23.5 D in)

RF Output Connector:

Type K female, ≤ 40 GHz models

Type V female, > 40 GHz models.

ENVIRONMENTAL

Storage Temperature Range: -40°C to $+75^{\circ}\text{C}$.

Operating Temperature Range: 0°C to $+50^{\circ}\text{C}$.

Relative Humidity: 5% to 95% at 40°C .

Altitude: 4,600 meters (15,000 ft) 17.3" Hg.

EMI: Meets the radiated emission requirements of:

EN55011:1991/CISPR-11:1990 Group 1 Class A

EN50082:1992/

IEC 801-2:1992 - 4 kV CD, 8 kV AD

IEC 1000-4-3:1995 - 3 V/m

IEC 801-4/1988 - 0.5 kV SL, 1 kV PL

IEC 1000-4-5:1995 - 0.5 kV - 1 kV LN

0.5 kV - 1 kV NG

0.5 kV - 1 kV GL

MIL-STD-461C Part2 RE01, RE02, CE01, CE03,
CS01, CS02, CS06, RS03

INPUTS and OUTPUTS

Input/Output Connectors		
Nomenclature	Type	Location
AM IN	BNC	Front & Rear Panel
FM/φM IN	BNC	Front & Rear Panel
PULSE TRIGGER IN	BNC	Front & Rear Panel
EXT ALC IN	BNC	Front & Rear Panel
RF OUTPUT	K-Connector V-Connector	Standard-Front Panel Option 9-Rear Panel
10 MHz REF IN	BNC	Rear Panel
10 MHz REF OUT	BNC	Rear Panel
HORIZ OUT	BNC	Rear Panel
SEQ SYNC OUT	BNC	Rear Panel
AM OUT	BNC	Rear Panel
FM OUT	BNC	Rear Panel
PULSE VIDEO OUT	BNC	Rear Panel
PULSE SYNC OUT	BNC	Rear Panel
DWELL IN	BNC	Rear Panel
V/GHz OUT	BNC	Rear Panel
AUX I/O	25-pin D-type	Rear Panel
SERIAL I/O	RJ45	Rear Panel
IEEE-488 GPIB	Type 57	Rear Panel

AM IN: Accepts an external signal to amplitude modulate the RF output signal. Front or rear-panel input, 50Ω or 600Ω impedance, both selectable from front-panel modulation menu.

FM/φM IN: Accepts an external signal to frequency/phase modulate the RF output signal. Front or rear-panel input, 50Ω or 600Ω impedance, both selectable from front-panel modulation menu.

PULSE TRIGGER IN: Accepts an external TTL compatible signal to pulse modulate the RF output signal or trigger or gate the internal pulse generator. Front or rear-panel input, selectable from front-panel modulation menu.

EXT ALC IN (External ALC Input): Provides for leveling the RF output signal externally with either a detector or power meter. Signal requirements are shown in the RF Output specifications on page B-6.

RF OUTPUT: Provides for RF output from 50Ω impedance source. K or V Connector, female. Option 9 moves the RF Output connector to the rear panel.

10 MHz REF IN: Accepts an external 10 MHz ±100 Hz, 0 to +10 dBm time-base signal. Automatically disconnects the internal high-stability time-base option, if installed. 50Ω impedance.

10 MHz REF OUT: Provides a 0.5 Vp-p, AC coupled, 10 MHz signal derived from the internal frequency standard. 50Ω impedance.

HORIZ OUT (Horizontal Sweep Output): Provides 0V at beginning and +10V at end of sweep for all sweep modes, regardless of sweep width. In CW mode, the voltage is proportional to frequency between 0V at low end and +10V at the high end of range. In CW mode, if CW RAMP is enabled, a repetitive, 0V to +10V ramp is provided.

SEQ SYNC OUT (Sequential Sync Output): Provides a +5V signal during retrace, at bandswitching points, and during each frequency step in step sweep mode, -5V during markers, and -10V during the selected marker.

AM OUT: Provides video modulating signal from the internal AM generator.

FM OUT: Provides video modulating signal from the internal FM generator.

PULSE VIDEO OUT: Provides video modulating signal from the internal pulse generator or external pulse input.

PULSE SYNC OUT: Provides a TTL compatible signal synchronized to the internal pulse modulation output.

DWELL IN: Accepts an external TTL low-level signal to pause the sweep in step sweep mode. The sweep resumes when the signal is removed.

V/GHz OUT: Provides a reference voltage relative to the RF output frequency (refer to the table below).

Model Number	V/GHz Output
68237B, 68245B, 68247B	1.0V/GHz
68253B, 68255B, 68259B	0.5V/GHz
68263B, 68265B, 68269B	0.5V/GHz
68275B, 68277B	0.25V/GHz
68285B, 68287B	0.25V/GHz
68295B, 68297B	0.25V/GHz

AUX I/O (Auxiliary Input/Output): Provides for most of the rear panel BNC connections through a single, 25-pin, D-type connector. Supports master-slave operation with another 682XXB signal generator or allows for a single-cable interface with the Model 562 Scalar Network Analyzer and other ANRITSU instruments. For a pinout diagram and descriptions, see Appendix A, Figure A-2.

SERIAL I/O (Serial Input/Output): Provides access to RS-232 terminal ports to support service and calibration functions and master-slave operations.

IEEE-488 GPIB: Provides input/output connections for the General Purpose Interface Bus (GPIB). For a pinout diagram, see Appendix A, Figure A-3.

OPTIONS

Option 1, Rack Mounting: Rack mount kit containing a set of track slides (90° tilt capability), mounting ears, and front panel handles to let the instrument be mounted in a standard 19-inch equipment rack.

Option 2A, 110 dB Step Attenuator: Adds a 10 dB/step attenuator with 110 dB range for models having a high-end frequency of ≤ 26.5 GHz. Rated RF output power is reduced.

Option 2B, 110 dB Step Attenuator: Adds a 10 dB/step attenuator with 110 dB range for models having a high-end frequency of ≤ 40 GHz. Rated RF output power is reduced.

Option 2C, 90 dB Step Attenuator: Adds a 10 dB/step attenuator with 90 dB range for models having a high-end frequency of ≤ 50 GHz. Rated RF output power is reduced.

Option 2D, 90 dB Step Attenuator: Adds a 10 dB/step attenuator with 90 dB range for models having a high-end frequency of ≤ 60 GHz. Rated RF output power is reduced.

Option 6, Phase Modulation (Φ M): Adds phase modulation capability. The internal FM generator becomes the FM/ Φ M generator. (Not available in combination with Option 7.)

Option 7, Delete AM/FM Generator: Deletes the internal AM and FM generators. External AM and FM capability remains unchanged. (Not available in combination with Option 6, 8, or 20.)

Option 8, Internal Power Meter: Adds an internal power meter that is compatible with ANRITSU 560-7, 5400-71, or 6400-71 series detectors. (Not available in combination with Option 7.)

Option 9, Rear Panel RF Output: Moves the RF output connector to the rear panel.

Option 10, Complex Modulation Capability: Provides user-defined waveform capability for complex modulation. Requires computer/controller (not included). Includes cable and Windows based software. (Not available in combination with Option 7.)

Option 11, 0.1 Hz Frequency Resolution: Provides frequency resolution of 0.1 Hz.

Option 14, ANRITSU 360B VNA Compatibility: Modifies rack mounting hardware to mate unit in a ANRITSU 360B VNA console.

Option 15B, High Power Output: Adds high-power RF components to the instrument in the 2-26.5 GHz frequency range. Option 15B is standard in models having a high-end frequency that is >40 GHz.

Option 16, High-Stability Time Base: Adds an ovenized, 10 MHz crystal oscillator as a high-stability time base.

Option 17A, Delete Front Panel: Deletes the front panel for use in remote control applications where a front panel display and keyboard control are not needed.

Option 18, mmWave Module Bias Output: Provides bias output for 54000-xWRxx Millimeter Wave Source Modules. BNC Twinax connector, rear panel. (Not available in combination with Option 20.)

Option 19, SCPI Programmability: Adds GPIB command mnemonics complying with Standard Commands for Programmable Instruments (SCPI), Version 1993.0 SCPI programming complies with IEEE 488.2-1987.

Option 20, SCAN Modulator: Adds an internal SCAN modulator for simulating high-depth amplitude modulated signals in models 68237B, 68245B, and 68247B only. Requires an external modulating signal input. (Not available in combination with Option 7 or 18.)

Series 683XXB

Synthesized Signal Generator

Performance Specifications

MODEL SUMMARY

Model	Frequency Range
68337B	2.0 to 20.0 GHz
68345B	0.5 to 20.0 GHz
68347B	0.01 to 20.0 GHz
68353B	2.0 to 26.5 GHz
68355B	0.5 to 26.5 GHz
68359B	0.01 to 26.5 GHz
68363B	2.0 to 40.0 GHz
68365B	0.5 to 40.0 GHz
68369B	0.01 to 40.0 GHz
68375B	0.5 to 50.0 GHz
68377B	0.01 to 50.0 GHz
68385B	0.5 to 60.0 GHz
68387B	0.01 to 60.0 GHz
68395B	0.5 to 65.0 GHz (with usable output to 67 GHz)
68397B	0.01 to 65.0 GHz (with usable output to 67 GHz)

FREQUENCY

CW MODE

Output: Twenty independent, presettable CW frequencies (F0 – F9 and M0 – M9).

Accuracy: Same as internal or external 10 MHz time base.

Internal Time Base Stability:

With Aging: $<2 \times 10^{-8}$ /day
($<5 \times 10^{-10}$ /day with Option 16)

With Temperature: $<2 \times 10^{-8}$ /°C over 0°C to 55°C
($<2 \times 10^{-10}$ /°C with Option 16)

Resolution:

1 kHz (0.1 Hz with Option 11)

External 10 MHz Reference Input: Accepts external 10 MHz ± 100 Hz, 0 to +10 dBm time base signal. Automatically disconnects the internal high-stability time-base option, if installed. BNC, rear panel, 50 Ω impedance.

10 MHz Reference Output: 0.5 Vp-p into 50 Ω , AC coupled. Rear panel BNC; 50 Ω impedance.

Switching Time (typical maximum): <40 ms to be within 1 kHz of final frequency.

ANALOG SWEEP MODE

Sweep Width: Independently selected from 1 MHz to full range continuous sweep.

Accuracy: The lesser of:

± 30 MHz or $\pm(2$ MHz + 0.25% of sweep width) for sweep speeds of ≤ 50 MHz/ms.

Sweep Time Range: 30 ms to 99 seconds

PHASE-LOCKED STEP SWEEP MODE

Sweep Width: Independently selected, 1 kHz (0.1 Hz with Option 11) to full range. Every frequency step in sweep range is phase-locked.

Accuracy: Same as internal or external 10 MHz time base.

Resolution (Minimum Step Size):

1 kHz (0.1 Hz with Option 11)

Steps: User-selectable number of steps or the step size.

Number of Steps: Variable from 1 to 10,000

Step Size: 1 kHz (0.1 Hz with Option 11) to the full frequency range of the instrument. (If the step size does not divide into the selected frequency range, the last step is truncated.)

Dwell Time Per Step: Variable from 1 ms to 99 seconds

Switching Time (typical maximum): <15 ms + 1 ms/GHz step size or <40 ms, whichever is less.

ALTERNATE SWEEP MODE

Sweeps alternately in analog or step sweep between any two sweep ranges. Each sweep range may be associated with a different power level.

MANUAL SWEEP MODE

Provides stepped, phase-locked adjustment of frequency between sweep limits. User-selectable number of steps or step size.

360B VNA SOURCE LOCK MODE

Under control of the ANRITSU 360B Vector Network Analyzer, the synthesized signal generator is phase-locked at a typical <8.5 ms/step sweep speed. Frequency resolution is limited to 100 kHz.

PROGRAMMABLE FREQUENCY AGILITY

Under GPIB control, up to 1000 non-sequential frequencies can be stored and then addressed as a phase-locked step sweep. Data stored in volatile memory.

MARKERS

Up to 20 independent, settable markers (F0 – F9 and M0 – M9).

Video Markers: +5V or –5V marker output, selectable from system menus. AUX I/O connector, rear panel.

Intensity Markers (Available in Analog Sweeps of <1 Second Sweep Time): Produces an intensified dot on trace, obtained by momentary dwell in RF sweep.

Marker Accuracy: Same as sweep frequency accuracy.

Marker Resolution (Analog Sweep):

1 MHz or Sweep Width/4096, whichever is greater.

Marker Resolution (Step Sweep):

1 kHz (0.1 Hz with Option 11)

SWEEP TRIGGERING

Sweep triggering is provided for Analog Frequency Sweep, Step Frequency Sweep, and CW Power Sweep.

Auto: Triggers sweep automatically.

External: Triggers a sweep on the low to high transition of an external TTL signal. AUX I/O connector, rear panel.

Single: Triggers, aborts, and resets a single sweep. Reset sweep may be selected to be at the top or bottom of the sweep. The pen lift will activate at sweep speeds ≥ 1 second.

SPECTRAL PURITY

All specifications apply to the phase-locked CW or Step Sweep modes at the lesser of +10 dBm output or maximum specified leveled output power, unless otherwise noted.

SPURIOUS SIGNALS

Harmonic and Harmonic Related:

500 MHz to ≤ 2.2 GHz (683X5B): < -50 dBc
 10 MHz to ≤ 50 MHz: < -30 dBc
 >50 MHz to ≤ 2 GHz: < -40 dBc
 >2 GHz (2.2 GHz for 683X5B) to ≤ 20 GHz: < -60 dBc
 >20 GHz to ≤ 40 GHz: < -40 dBc

Harmonic and Harmonic Related (Models having a high-end frequency of >40 GHz and units with Option 15B at maximum specified leveled output power):

500 MHz to ≤ 2.2 GHz (683X5B): < -50 dBc
 10 MHz to ≤ 50 MHz: < -30 dBc
 >50 MHz to ≤ 2 GHz: < -40 dBc
 >2 GHz (2.2 GHz for 683X5B) to ≤ 20 GHz: < -50 dBc
 >20 GHz to ≤ 40 GHz: < -40 dBc
 50 GHz units; >40 GHz to ≤ 50 GHz: < -40 dBc
 60 GHz units; >40 GHz to ≤ 60 GHz: < -30 dBc
 65 GHz units; >40 GHz to ≤ 45 GHz: < -25 dBc
 >45 GHz to ≤ 65 GHz: < -30 dBc

Nonharmonics:

500 MHz to ≤ 2.2 GHz (683X5B): < -50 dBc
 10 MHz to ≤ 2 GHz: < -40 dBc
 >2 GHz (2.2 GHz for 683X5B) to ≤ 65 GHz: < -60 dBc

**SINGLE-SIDEBAND PHASE NOISE
(dBc/Hz)**

Frequency (GHz)	Offset From Carrier			
	100 Hz	1 kHz	10 kHz	100 kHz
0.6 (683X5B)	-87	-100	-98	-115
0.6	-77	-88	-86	-100
2.0 (683X5B)	-81	-94	-92	-109
2.0	-80	-88	-86	-102
6.0	-78	-88	-86	-102
10.0	-73	-86	-83	-102
20.0	-66	-78	-78	-100
26.5	-63	-78	-76	-96
40.0	-60	-75	-72	-94
50.0	-54	-69	-66	-88
65.0	-54	-69	-64	-88

PERFORMANCE SPECIFICATIONS

SERIES 683XXB SYNTHESIZED SIGNAL GENERATOR

POWER LINE and FAN ROTATION SPURIOUS EMISSIONS (dBc)

Frequency Range (GHz)	Offset From Carrier		
	<300 Hz	300Hz to 1 kHz	>1 kHz
0.5 to ≤1.0 (683X5B)	<-62	<-72	<-72
>1.0 to ≤2.2 (683X5B)	<-56	<-66	<-66
0.01 (>2.2 to 683X5B) to ≤8.4	<-50	<-60	<-60
>8.4 to ≤20	<-46	<-56	<-60
>20 to ≤40	<-40	<-50	<-54
>40 to ≤65	<-34	<-44	<-48

RESIDUAL FM (50 Hz - 15 kHz BW)

Frequency Range (GHz)	Residual FM (Hz RMS)
0.5 to ≤1.0 (683X5B)	<30
>1.0 to ≤2.2 (683X5B)	<60
0.01 (>2.2 to 683X5B) to ≤8.4	<120
>8.4 to ≤20	<220
>20 to ≤40	<440
>40 to ≤65	<880

RESIDUAL FM (Analog Sweep and Unlocked FM modes, 50 Hz - 15 kHz BW)

Frequency Range (GHz)	Unlocked Narrow FM Mode (kHz RMS)	Unlocked Wide FM Mode or Analog Sweep (kHz RMS)
0.5 to ≤1.0 (683X5B)	<1.25	<6.3
>1.0 to ≤2.2 (683X5B)	<2.5	<12.5
0.01 (>2.2 for 683X5B) to ≤20	<5	<25
>20 to ≤40	<10	<50
>40 to ≤65	<20	<100

AM Noise Floor:

Typically -145 dBm/Hz at 0 dBm output and offsets >5 MHz from carrier.

RF OUTPUT

Power level specifications apply at 25° ±10°C.

MAXIMUM LEVELED OUTPUT POWER

Model Number	Frequency Range (GHz)	Output Power (dBm)	Output Power with Step Attenuator (dBm)
68337B	2.0 to ≤20.0	+13.0	+11.0
68345B	0.5 to ≤20.0	+13.0	+11.0
68347B	0.01 to ≤20.0	+13.0	+11.0
68353B	2.0 to ≤20.0	+9.0	+7.0
	>20.0 to ≤26.5	+6.0	+3.5
68355B	0.5 to ≤2.2	+13.0	+11.0
	>2.2 to ≤20.0	+9.0	+7.0
	>20.0 to ≤26.5	+6.0	+3.5
68359B	0.01 to ≤2.0	+13.0	+11.0
	>2.0 to ≤20.0	+9.0	+7.0
	>20.0 to ≤26.5	+6.0	+3.5
68363B	2.0 to ≤20.0	+9.0	+7.0
	>20.0 to ≤40.0	+6.0	+3.0
68365B	0.5 to ≤2.2	+13.0	+11.0
	>2.2 to ≤20.0	+9.0	+7.0
68369B	>20.0 to ≤40.0	+6.0	+3.0
	0.01 to ≤2.0	+13.0	+11.0
68375B	>2.0 to ≤20.0	+9.0	+7.0
	>20.0 to ≤40.0	+6.0	+3.0
	>40.0 to ≤50.0	+2.5	+10.0 +8.5 0.0 -1.0
68377B	0.5 to ≤2.2	+11.0	+10.0
	>2.2 to ≤20.0	+10.0	+8.5
	>20.0 to ≤40.0	+2.5	0.0
	>40.0 to ≤50.0	+2.5	-1.0
68385B	0.01 to ≤2.0	+12.0	+10.0
	>2.0 to ≤20.0	+10.0	+8.5
	>20.0 to ≤40.0	+2.5	0.0
	>40.0 to ≤50.0	+2.0	-1.5
68387B	>50.0 to ≤60.0	+2.0	-2.0
	0.5 to ≤2.2	+12.0	+10.0
	>2.0 to ≤20.0	+10.0	+8.5
	>20.0 to ≤40.0	+2.5	0.0
68388B	>40.0 to ≤50.0	+2.0	-1.5
	>50.0 to ≤60.0	+2.0	-2.0
	>60.0 to ≤70.0	+2.0	-2.0

MAXIMUM LEVELED OUTPUT POWER (Continued)

Model Number	Frequency Range (GHz)	Output Power (dBm)	Output Power with Step Attenuator (dBm)
68395B	0.5 to 2.2	+11.0	Not Available
	>2.2 to ≤20.0	+10.0	
	>20.0 to ≤40.0	+2.5	
	>40.0 to ≤50.0	0.0	
	>50.0 to ≤65.0	-2.0	
68397B	0.5 to ≤2.0	+12.0	Not Available
	>2.0 to ≤20.0	+10.0	
	>20.0 to ≤40.0	+2.5	
	>40.0 to ≤50.0	0.0	
	>50.0 to ≤65.0	-2.0	
With Option 15B (High Power) Installed			
68337B	2.0 to 20.0	+17.0	+15.0
68345B	0.5 to ≤2.2	+13.0	+11.0
	>2.2 to ≤20.0	+17.0	+15.0
68347B	0.5 to ≤2.2	+13.0	+11.0
	>2.2 to ≤20.0	+17.0	+15.0
68353B	2.0 to ≤20.0	+13.0	+11.0
	>20.0 to ≤26.5	+10.0	+7.5
68355B	0.5 to ≤20.0	+13.0	+11.0
	>20.0 to ≤26.5	+10.0	+7.5
68359B	0.01 to ≤20.0	+13.0	+11.0
	>20.0 to ≤26.5	+10.0	+7.5
68363B	2 to ≤20.0	+13.0	+11.0
	>20 to ≤40.0	+6.0	+3.0
68365B	0.5 to ≤20.0	+13.0	+11.0
	>20 to ≤40.0	+6.0	+3.0
68369B	0.01 to ≤20.0	+13.0	+11.0
	>20 to ≤40.0	+6.0	+3.0
68375B	0.5 to 50.0	Standard	Standard
68377B	0.01 to 50.0	Standard	Standard
68385B	0.5 to 60.0	Standard	Standard
68387B	0.01 to 60.0	Standard	Standard
68395B	0.5 to 65.0	Standard	Not Available
68397B	0.01 to 65.0	Standard	Not Available

UNLEVELED OUTPUT POWER RANGE (typical)

Without an Attenuator: >40 dB below max power.

With an Attenuator: >130 dB below max power.

POWER LEVEL SWITCHING TIME (to within specified accuracy):

Without Change in Step Attenuator: <1 ms typical

With Change in Step Attenuator: <20 ms typical

ACCURACY AND FLATNESS

Step Sweep and CW Modes

Attenuation Below Max Power	Frequency (GHz)					
	0.01-0.05	0.05-20	20-40	40-50	50-60	60-65
Accuracy:						
0-25 dB [Ⓜ]	±2.0 dB	±1.0 dB	±1.0 dB	±1.5 dB	±1.5 dB	±1.5 dB
25-60 dB	±2.0 dB	±1.0 dB	±1.0 dB	±1.5 dB	±3.5 dB [Ⓜ]	N/A
>60 dB	±2.0 dB	±1.0 dB	±1.0 dB	±2.5 dB [Ⓜ]	±3.5 dB [Ⓜ]	N/A
Flatness:						
0-25 dB [Ⓜ]	±2.0 dB	±0.8 dB	±0.8 dB	±1.1 dB	±1.1 dB	±1.1 dB
25-60 dB	±2.0 dB	±0.8 dB	±0.8 dB	±1.1 dB	±3.1 dB [Ⓜ]	N/A
>60 dB	±2.0 dB	±0.8 dB	±0.8 dB	±1.1 dB [Ⓜ]	±3.1 dB [Ⓜ]	N/A

Analog Sweep Mode (typical)

Attenuation Below Max Power	Frequency (GHz)			
	0.01-0.05	0.05-20	20-40	40-65
Accuracy				
0-12 dB	±2.0 dB	±2.0 dB	±2.0 dB	±3.0 dB
0-30 dB	±3.5 dB	±3.5 dB	±4.6 dB	±5.6 dB
30-60 dB	±4.0 dB	±4.0 dB	±5.2 dB	±6.2 dB
60-122 dB	±5.0 dB	±5.0 dB	±6.2 dB	±7.2 dB
Flatness				
0-12 dB	±2.0 dB	±1.0 dB	±2.0 dB	±2.5 dB
0-30 dB	±3.5 dB	±3.0 dB	±4.1 dB	±5.1 dB
30-60 dB	±3.5 dB	±3.5 dB	±4.6 dB	±5.6 dB

LEVELED OUTPUT POWER RANGE

Without an Attenuator: Maximum leveled power to -15 dBm (-20 dBm typical). For units with Option 15B installed, minimum settable power is -5 dBm (-10 dBm typical).

With an Attenuator: Maximum leveled power to -115 dBm (-120 dBm typical). For 68375B, 68377B, 68385B, 68387B, and units with Option 15B installed, minimum settable power is -105 dBm (-110 dBm typical).

[Ⓜ] Typical

[Ⓜ] 0 to 25 dB or to minimum rated power, whichever is higher

OTHER OUTPUT POWER SPECIFICATIONS**Output Power Resolution:** 0.01 dB**Source Impedance:** 50Ω nominal**Source SWR (Internal Leveling):**

Without Attenuator: <1.7 at <2 GHz typical
<1.6 at 2 to 20 GHz typical
<2.0 at >20 GHz typical

With Attenuator: <2.0 typical

Power Level Stability with Temperature:

0.04 dB/°C typical

Level Offset: Offsets the displayed power level to establish a new reference level.**OUTPUT ON/OFF:** Toggles the RF output between an Off and On state. During the Off state, the RF oscillator is turned off. The On or Off state is indicated by two LEDs located below the OUTPUT ON/OFF key on the front panel.**RF On/Off Between Frequency Steps:** System menu selection of RF On or RF Off during frequency switching in CW or Step Sweep modes.**RF On/Off During Retrace:** System menu selection of RF On or RF Off during retrace.**Internal Leveling:** Power is leveled at the output connector in all modes.**External Leveling:**

External Detector: Levels output power at a remote detector location. Accepts a positive or negative 0.5 mV to 500 mV input signal from the remote detector. EXT ALC ADJ adjusts the input signal range to an optimum value. BNC connector, front and rear panel.

External Power Meter: Levels output power at a remote power meter location. Accepts a ±1V full scale input signal from the remote power meter. EXT ALC ADJ adjusts the input signal range to an optimum value. BNC connector, front and rear panel.

External Leveling Bandwidth:

30 kHz typical in Detector mode.
0.7 Hz typical in Power Meter mode.

User Level Flatness Correction:

Number of points: 2 to 801 points per table
Number of tables: 5 available
Entry modes: GPIB power meter or computed data

CW POWER SWEEP**Range:** Sweeps between any two power levels at a single CW frequency.**Resolution:** 0.01 dB/step**Accuracy:** Same as CW power accuracy.**Step Size:** User-controlled, 0.01 dB to the full power range of the instrument.**Step Dwell Time:** Variable from 1 ms to 99 seconds. If the sweep crosses a step attenuator setting, there will be a sweep dwell of approximately 20 ms to allow setting of the step attenuator.**SWEEP FREQUENCY/STEP POWER**

A power level step occurs after each frequency sweep. Power level remains constant for the length of time required to complete each sweep.

POWER METER (Option 8) ③

Internal Power Meter Range: +16 dBm to -35 dBm. Compatible with ANRITSU 560-7, 5400-71, and 6400-71 Series Detectors. Rear panel input.

Power Meter Accuracy:

±1 dB (+10 dBm to -10 dBm)
±2 dB (-10 dBm to -35 dBm)

Power Meter Resolution: 0.1 dB minimum**MODULATION****AMPLITUDE MODULATION**

All amplitude modulation specifications apply at 50% depth, 1 kHz rate, with RF level set 6 dB below maximum specified leveled output power, unless otherwise noted.

External AM Input: Log AM or Linear AM input, front or rear-panel BNC, 50Ω or 600Ω input impedance. All options selectable from modulation menu.

AM Sensitivity:

Log AM: Continuously variable from 0 dB/volt to 25 dB/volt

Linear AM: Continuously variable from 0% per volt to 100% per volt

AM Depth (typical): 0-90% linear; 20 dB log

AM Bandwidth (3 dB): DC to 50 kHz minimum
DC to 100 kHz typical

Flatness (DC to 10 kHz rates): (0.3 dB**Accuracy:** ±5%**Distortion:** <5% typical

Incidental Phase Modulation (30% depth, 10 kHz rate):
<0.2 radians typical

Maximum Input: ±1V**INTERNAL AM GENERATOR**

Waveforms: Sine, square, triangle, positive ramp, negative ramp, Gaussian noise, uniform noise, user-defined ④.

Rate:

0.1 Hz to 1 MHz for sine wave

0.1 Hz to 100 kHz for square, triangle, and ramp waveforms

Resolution: 0.1 Hz**Accuracy:** Same as instrument timebase.**Output:** BNC connector, rear panel

③ When Option 8 Power Meter is installed, Option 7 (Delete AM/FM Generators) is not available.

④ User-defined waveforms are available with Option 10, Complex Modulation Capability.

FREQUENCY MODULATION

External FM Input: Front or rear panel BNC, 50 Ω or 600 Ω input impedance. All options selectable from modulation menu.

FM Sensitivity: Continuously variable from ± 10 kHz per volt to ± 20 MHz per volt (Locked, and Unlocked Narrow FM modes) or ± 100 kHz per volt to ± 100 MHz per volt (Unlocked Wide FM mode), selectable from modulation menu. (For 683X5B units, maximum sensitivity is divided by 2 from 1.0 to 2.2 GHz and divided by 4 from 0.5 to 1.0 GHz)

Maximum FM Deviation:**Locked Mode (1 kHz to 8 MHz rates):**

The lesser of ± 10 MHz or rate x 300

Locked Low-Noise Mode (50 kHz to 8 MHz rates):

The lesser of ± 10 MHz or rate x 3

Unlocked Narrow Mode (DC to 8 MHz rates):

± 10 MHz

Unlocked Wide Mode (DC to 100 Hz rates):

± 100 MHz

(For 683X5B units, maximum deviation is divided by 2 from 1.0 to 2.2 GHz and is divided by 4 from 500 MHz to 1 GHz.)

FM Bandwidth (3 dB):

Locked Mode: 1 kHz to 10 MHz

Locked Low-Noise Mode: 30 kHz to 10 MHz

Unlocked Narrow Mode: DC to 10 MHz

Unlocked Wide Mode: DC to 100 Hz

Flatness (Locked Mode 10 kHz to 1 MHz rates): ± 1 dB

Accuracy (100 kHz rate): ^⑤ 10% (5% typical)

Incidental AM (± 1 MHz deviation, 1 MHz rate): <2%

Harmonic Distortion (± 1 MHz deviation, 10 kHz rate): <1%

Maximum Input: $\pm 1V$

INTERNAL FM GENERATOR

Waveforms: Sine, square, triangle, positive ramp, negative ramp, Gaussian noise, uniform noise, user-defined ^④.

Rate:

0.1 Hz to 1 MHz for sine wave

0.1 Hz to 100 kHz for square, triangle, and ramp waveforms

Resolution: 0.1 Hz

Accuracy: Same as instrument timebase.

Output: BNC connector, rear panel

PHASE MODULATION (ΦM) (Option 6)

External ΦM Input: Front or rear panel BNC (shares the FM input), 50 Ω or 600 Ω input impedance. All options selectable from modulation menu.

ΦM Sensitivity: Continuously variable from ± 0.0025 radians per volt to ± 5.0 radians per volt (Narrow ΦM mode) or ± 0.25 radians per volt to ± 500.0 radians per volt (Wide ΦM mode), selectable from modulation menu.

(For 683X5B units, maximum sensitivity is divided by 2 from 1.0 to 2.2 GHz and divided by 4 from 0.5 to 1.0 GHz.)

 ΦM Deviation:**Narrow Mode (DC to 8 MHz rates):**

The lesser of ± 3 radians or ± 5 MHz/rate

Wide Mode (DC to 1 MHz rates):

The lesser of ± 400 radians or ± 10 MHz/rate

(For 683X5B units, maximum deviation is divided by 2 from 1.0 to 2.2 GHz and divided by 4 from 0.5 to 1.0 GHz.)

 ΦM Bandwidth (3 dB, relative to 100 kHz rate):

Narrow Mode: DC to 10 MHz

Wide Mode: DC to 1 MHz

 ΦM Flatness:

Narrow Mode (DC to 1 MHz rates): ± 1 dB

Wide Mode (DC to 500 kHz rates): ± 1 dB

ΦM Accuracy (at 100 kHz sine wave): ^⑤ 10%

Maximum Input: $\pm 1V$

INTERNAL ΦM GENERATOR

(Shares the Internal FM Generator)

Waveforms: Sine, square, triangle, positive ramp, negative ramp, Gaussian noise, uniform noise, user-defined ^④.

Rate:

0.1 Hz to 1 MHz for sine wave

0.1 Hz to 100 kHz for square, triangle, and ramp waveforms

Resolution: 0.1 Hz

Accuracy: Same as instrument timebase.

Output: BNC connector, rear panel

^④ User-defined waveforms are available with Option 10, Complex Modulation Capability.

^⑤ In external mode, accuracy applies at 1V peak input.

PULSE MODULATION

Pulse modulation specifications apply at maximum rated power, unless otherwise noted.

On/Off Ratio: >80 dB

Rise/Fall Time (10 to 90%): <10 ns (<5 ns typical) ^⑥

Minimum Leveled Pulse Width:

<100 ns, ≥2 GHz

<1 μs, <2 GHz

Minimum Unleveled Pulse Width: <10 ns

Pulse Overshoot: <10% ^⑦

Level Accuracy Relative to CW (100 Hz to 1 MHz PRF):

±0.5 dB, ≥1 μs pulse width

±1.0 dB, <1 μs pulse width

Video Feedthrough: <±10 mV, ≥2 GHz

Pulse Width Compression: <8 ns typical

Pulse Delay (typical):

Mode	Pulse Delay (ns)
External	50
Triggered	100
Triggered with delay	200

PRF Range: DC to 10 MHz unleveled
100 Hz to 5 MHz leveled

External Input: Front or rear-panel BNC, selectable from modulation menu.

Drive Level: TTL compatible input

Input Logic: Positive-true or negative-true, selectable from modulation menu.

INTERNAL PULSE GENERATOR

Modes: Free-run, triggered, gated, delayed, doublet, triplet, quadruplet. All modes selectable from modulation menus.

Parameter	Clock Rate (Selectable)	
	40 MHz	10 MHz
Pulse Width	25 ns to 419 ms	100 ns to 1.6s
Pulse Period ^⑧	250 ns to 419 ms	600 ns to 1.6s
Variable Delay		
Single	0 to 419 ms	0 to 1.6s
Doublet	100 ns to 419 ms	300 ns to 1.6s
Triplet	100 ns to 419 ms	300 ns to 1.6s
Quadruplet	100 ns to 419 ms	300 ns to 1.6s
Resolution	25 ns	100 ns

^⑥ For 683X5B units, operating below 1.0 GHz, rise/fall time is <15 ns.

^⑦ For 50 GHz, 60 GHz, and 65 GHz units, when operating above 40 GHz, pulse overshoot is <20% typical at rated power.

^⑧ Period must be at least 5 clock cycles longer than pulse widths + delays.

Accuracy: 10 ns (5 ns typical)

Output: Video pulse and sync out, rear-panel BNC connectors.

SCAN MODULATOR (Option 20) ^⑨

Frequency Range: 1 to 20 GHz

Attenuation Range: ^⑩ 0 to 60 dB

Flatness: ±2.0 dB, 0 to 40 dB

±3.5 dB, 40 to 60 dB

Sensitivity: -10 dB/V

Insertion Loss (when on): <6 dB, 1 to 18 GHz

<8 dB, 18 to 20 GHz

Input: Rear-panel BNC connector

REMOTE OPERATION

All instrument functions, settings, and operating modes (except for power on/standby) are controllable using commands sent from an external computer via the GPIB (IEEE-488 interface bus).

GPIB Address: Selectable from a system menu

IEEE-488 Interface Function Subset:

Source Handshake: SH1

Acceptor Handshake: AH1

Talker: T6

Listener: L4

Service Request: SR1

Remote/Local: RL1

Parallel Poll: PP1

Device Clear: DC1

Device Trigger: DT1

Controller Capability: C0, C1, C2, C3, C28

Tri-State Driver: E2

GPIB Status Annunciators: When the instrument is operating in Remote, the GPIB status annunciators (listed below) will appear in a window on the front panel LCD.

REMOTE: Operating on the GPIB (all instrument front panel keys except for the SYSTEM key and the RETURN TO LOCAL soft-key will be ignored).

LLO (LOCAL LOCKOUT): Disables the RETURN TO LOCAL soft-key. Instrument can be placed in local mode only via GPIB or by cycling line power.

Emulations: The instrument responds to the published GPIB commands and responses of the ANRITSU Models 6600, 6700, 6XX00-series signal sources. When emulating another signal source, the instrument will be limited to the capabilities, mnemonics, and parameter resolutions of the emulated instrument.

^⑨ Option 20 SCAN Modulator is available on models 68337B, 68345B, and 68347B only. When Option 20 SCAN Modulator is installed, Option 7 (Delete AM/FM Generators) and Option 18 (mmWave Module Bias Output) are not available.

^⑩ Maximum attenuation = attenuation range ± flatness.

GENERAL

Stored Setups: Stores front panel settings and nine additional front-panel setups in a non-volatile RAM. A system menu allows saving and recalling of instrument setups. Whenever the instrument is turned on, control settings come on at the same functions and values existing when the instrument was turned off.

Memory Sequencing Input: Accepts a TTL low-level signal to sequence through nine stored setups. AUX I/O connector, rear panel.

Self-Test: Instrument self-test is performed when Selftest soft-key is selected. If an error is detected, an error message is displayed in a window on the LCD identifying the probable cause and remedy.

Secure Mode: Disables all frequency, power level, and modulation state displays. Stored setups saved in secure mode remain secured when recalled. Mode selectable from a system menu.

Parameter Entry: Instrument-controlled parameters can be entered in three ways—keypad, rotary data knob, or the \wedge and \vee touch pads of the cursor-control key.

The keypad is used to enter new parameter values; the rotary data knob and the cursor-control key are used to edit existing parameter values. The < and > touch pads of the cursor-control key move the cursor left and right one digit under the open parameter. The rotary data knob or the \wedge and \vee touch pads will increment or decrement the digit position over the cursor.

Controlled parameters are frequency, power level, sweep time, dwell time, and number of steps.

Keypad entries are terminated by pressing the appropriate unit key (GHz/Sec/dBm, MHz/ms/dB, kHz/ μ s/STEPS, or Hz/ns/ADRS). Edits are terminated by exiting the edit menu.

Reset: Returns all instrument parameters to predefined default states or values. Any pending GPIB I/O is aborted. Selectable from the system menu.

Master/Slave Operation: Allows two 68XXXB output signals to be swept with a user-selected frequency offset. One 68XXXB synthesizer controls the other via AUX I/O and SERIAL I/O connections. Requires a Master/Slave Interface Cable Set (Part No. ND36329).

User Level Flatness Correction: Allows user to calibrate out path loss due to external switching and cables via entered power table from a GPIB power meter or calculated data. When user level correction is activated, entered power levels are delivered at the point where calibration was performed. Supported power meters are ANRITSU ML4803A and HP 437B, 438A, and 70100A. Five user tables are available with up to 801 points/table.

Warm Up Time (Standard Time Base):

From Standby: 30 minutes.

From Cold Start (0°C): 120 hours to achieve $<2 \times 10^{-8}$ per day frequency stability.

Warm Up Time (Option 16 Time Base):

From Standby: 30 minutes

From Cold Start (0°C): 120 hours to achieve $<5 \times 10^{-10}$ per day frequency stability.

Instruments disconnected from AC power for more than 72 hours require 30 days to return to specified aging.

Power:

90-132 Vac or 180-264 Vac, 48–440 Hz, 400 VA maximum

Standby: With ac line power connected, unit is placed in standby when front panel power switch is released from the OPERATE position.

Weight: 23 kg (50 lb) maximum

Dimensions:

133 H x 429 W x 597 D mm

(5.25 H x 16.875 W x 23.5 D in)

RF Output Connector:

Type K female, ≤ 40 GHz models

Type V female, > 40 GHz models

ENVIRONMENTAL

Storage Temperature Range: -40°C to $+75^{\circ}\text{C}$.

Operating Temperature Range: 0°C to $+50^{\circ}\text{C}$.

Relative Humidity: 5% to 95% at 40°C .

Altitude: 4,600 meters (15,000 ft), 17.3" Hg.

EMI: Meets the radiated emission requirements of:

EN55011:1991/CISPR-11:1990 Group 1 Class A

EN50082:1992/

IEC 801-2:1992 - 4 kV CD, 8 kV AD

IEC 1000-4-3:1995 - 3 V/m

IEC 801-4/1988 - 0.5 kV SL, 1 kV PL

IEC 1000-4-5:1995 - 0.5 kV - 1 kV LN

0.5 kV - 1 kV NG

0.5 kV - 1 kV GL

MIL-STD-461C Part 2 RE01, RE02, CE01, CE03, CS01, CS02, CS06, RS03

INPUTS and OUTPUTS

Input/Output Connectors		
Nomenclature	Type	Location
AM IN	BNC	Front & Rear Panel
FM/ Φ M IN	BNC	Front & Rear Panel
PULSE TRIGGER IN	BNC	Front & Rear Panel
EXT ALC IN	BNC	Front & Rear Panel
RF OUTPUT	K-Connector V-Connector	Standard-Front Panel Option 9-Rear Panel
10 MHz REF IN	BNC	Rear Panel
10 MHz REF OUT	BNC	Rear Panel
HORIZ OUT	BNC	Rear Panel
SEQ SYNC OUT	BNC	Rear Panel
AM OUT	BNC	Rear Panel
FM OUT	BNC	Rear Panel
PULSE VIDEO OUT	BNC	Rear Panel
PULSE SYNC OUT	BNC	Rear Panel
DWELL IN	BNC	Rear Panel
V/GHz OUT	BNC	Rear Panel
AUX I/O	25-pin D-type	Rear Panel
SERIAL I/O	RJ45	Rear Panel
IEEE-488 GPIB	Type 57	Rear Panel

AM IN: Accepts an external signal to amplitude modulate the RF output signal. Front or rear-panel input, 50 Ω or 600 Ω impedance, both selectable from front-panel modulation menu.

FM/ Φ M IN: Accepts an external signal to frequency/phase modulate the RF output signal. Front or rear-panel input, 50 Ω or 600 Ω impedance, both selectable from front-panel modulation menu.

PULSE TRIGGER IN: Accepts an external TTL compatible signal to pulse modulate the RF output signal or trigger or gate the internal pulse generator. Front or rear-panel input, selectable from front-panel modulation menu.

EXT ALC IN (External ALC Input): Provides for leveling the RF output signal externally with either a detector or power meter. Signal requirements are shown in the RF Output specifications on page B-16.

RF OUTPUT: Provides for RF output from 50 Ω impedance source. K and V Connector, female. Option 9 moves the RF Output connector to the rear panel.

10 MHz REF IN: Accepts an external 10 MHz \pm 100 Hz, 0 to +10 dBm time-base signal. Automatically disconnects the internal high-stability time-base option, if installed. 50 Ω impedance.

10 MHz REF OUT: Provides a 0.5 Vp-p, AC coupled, 10 MHz signal derived from the internal frequency standard. 50 Ω impedance.

HORIZ OUT (Horizontal Sweep Output): Provides 0V at beginning and +10V at end of sweep for all sweep modes, regardless of sweep width. In CW mode, the voltage is proportional to frequency between 0V at low end and +10V at the high end of range. In CW mode, if CW RAMP is enabled, a repetitive, 0V to +10V ramp is provided.

SEQ SYNC OUT (Sequential Sync Output): Provides a +5V signal during retrace, at bandswitching points, and during each frequency step in step sweep mode, -5V during markers, and -10V during the selected marker.

AM OUT: Provides video modulating signal from the internal AM generator.

FM OUT: Provides video modulating signal from the internal FM generator.

PULSE VIDEO OUT: Provides video modulating signal from the internal pulse generator or external pulse input.

PULSE SYNC OUT: Provides a TTL compatible signal synchronized to the internal pulse modulation output.

DWELL IN: Accepts an external TTL low-level signal to pause the sweep in both analog and step sweep modes. The sweep resumes when the signal is removed.

V/GHz OUT: Provides a reference voltage relative to the RF output frequency (refer to the table below).

Model Number	V/GHz Output
68337B, 68345B, 68347B	1.0V/GHz
68353B, 68355B, 68359B	0.5V/GHz
68363B, 68365B, 68369B	0.5V/GHz
68375B, 68377B	0.25V/GHz
68385B, 68387B	0.25V/GHz
68395B, 68397B	0.25V/GHz

AUX I/O (Auxiliary Input/Output): Provides for most of the rear panel BNC connections through a single, 25-pin, D-type connector. Supports master-slave operation with another 68XXXB synthesizer or allows for a single-cable interface with the Model 562 Scalar Network Analyzer and other ANRITSU instruments. For a pinout diagram and descriptions, see Appendix A, Figure A-2.

SERIAL I/O (Serial Input/Output): Provides access to RS-232 terminal ports to support service and calibration functions and master-slave operations.

IEEE-488 GPIB: Provides input/output connections for the General Purpose Interface Bus (GPIB). For a pinout diagram, see Appendix A, Figure A-3.

OPTIONS

Option 1, Rack Mounting: Rack mount kit containing a set of track slides (90° tilt capability), mounting ears, and front panel handles to let the instrument be mounted in a standard 19-inch equipment rack.

Option 2A, 110 dB Step Attenuator: Adds a 10 dB/step attenuator with 110 dB range for models having a high-end frequency of ≤ 26.5 GHz. Rated RF output power is reduced.

Option 2B, 110 dB Step Attenuator: Adds a 10 dB/step attenuator with 110 dB range for models having a high-end frequency of ≤ 40 GHz. Rated RF output power is reduced.

Option 2C, 90 dB Step Attenuator: Adds a 10 dB/step attenuator with 90 dB range for models having a high-end frequency of ≤ 50 GHz. Rated RF output power is reduced.

Option 2D, 90 dB Step Attenuator: Adds a 10 dB/step attenuator with 90 dB range for models having a high-end frequency of ≤ 60 GHz. Rated RF output power is reduced.

Option 6, Phase Modulation (Φ M): Adds phase modulation capability. The internal FM generator becomes the FM/ Φ M generator. (Not available in combination with Option 7.)

Option 7, Delete AM/FM Generator Deletes the internal AM and FM generators. External AM and FM capability remains unchanged. (Not available in combination with Option 6, 8, or 20.)

Option 8, Internal Power Meter: Adds an internal power meter that is compatible with ANRITSU 560-7, 5400-71, or 6400-71 series detectors. (Not available in combination with Option 7.)

Option 9, Rear Panel RF Output: Moves the RF output connector to the rear panel.

Option 10, Complex Modulation Capability: Provides user defined wave capability for complex modulation. Requires computer/controller (not included). Includes cable and Windows based software. (Not available in combination with Option 7.)

Option 11, 0.1 Hz Frequency Resolution: Provides frequency resolution of 0.1 Hz.

Option 14, ANRITSU 360B VNA Compatibility: Modifies rack mounting hardware to mate unit in a ANRITSU 360B VNA console.

Option 15B, High Power Output: Adds high-power RF components to the instrument in the 2-26.5 GHz frequency range. Option 15B is standard in models having a high-end frequency that is >40 GHz.

Option 16, High-Stability Time Base: Adds an ovenized, 10 MHz crystal oscillator as a high-stability time base.

Option 17A, Delete Front Panel: Deletes the front panel for use in remote control applications where a front panel display and keyboard control are not needed.

Option 18, mmWave Module Bias Output: Provides bias output for 54000-xWRxx Millimeter Wave Source Modules. BNC Twinax connector, rear panel. (Not available in combination with Option 20.)

Option 19, SCPI Programmability: Adds GPIB command mnemonics complying with Standard Commands for Programmable Instruments (SCPI), Version 1993.0 SCPI programming complies with IEEE 488.2-1987.

Option 20, SCAN Modulator: Adds an internal SCAN modulator for simulating high-depth amplitude modulated signals in models 68337B, 68345B, and 68347B only. Requires an external modulating signal input. (Not available in combination with Option 7 or 18.)

Subject Index

0 - 9

682XXB/683XXB

- Front Panel Layout, 3-6
- General Description, 1-3
- Manual, Electronic, 1-8
- Manuals, Related, 1-8
- Models, List of, 1-4 - 1-7
- Options, List of, 1-9
- Performance Specifications, B-1
- Rear Panel Layout, A-2

A

ALC, 3-50

Alternate Sweep Frequency Mode

- Activating the Alternate Sweep, 3-36
- Selecting a Power Level, 3-38
- Selecting a Sweep Range, 3-37
- Selecting Alternate Sweep, 3-36

AM Mode

- Menu Map, 4-14
- Operating Modes, 3-63
- Providing AM, 3-63

Analog Sweep Frequency Mode

- Menu Map, 4-7
- Selecting a Power Level, 3-33
- Selecting a Sweep Range, 3-31
- Selecting Alternate Sweep, 3-36
- Selecting Analog Sweep Mode, 3-25
- Setting a Sweep Trigger, 3-27
- Setting the Sweep Time, 3-26
- Using Frequency Markers, 3-34

C

Calibration, Reference Oscillator, 3-100

Connectors

- Front Panel, 3-7
- Rear Panel, A-1

CW Frequency Accuracy Test

- Test Procedure, 5-6
- Test Records, 5-7 - 5-12
- Test Setup, 5-5

CW Frequency Mode

- Menu Map, 4-6
- Selecting a CW Frequency, 3-21
- Selecting a Power Level, 3-23
- Selecting CW Mode, 3-21

CW Power Sweep Mode

- Menu Map, 4-11
- Selecting a Sweep Range, 3-46
- Selecting a Sweep Trigger, 3-45
- Selecting CW Power Sweep Mode, 3-43
- Setting Dwell Time, 3-44
- Setting Step Size, 3-44

CW Ramp, 3-24

D

Data Display

- Description, 3-8
- Menu Display Format, 3-9
- Menu Keys, 3-10

Data Entry Area

- Description, 3-12

Default (Reset) Parameters, 3-16 - 3-17

E

Entering Data

- Editing the Current Value, 3-19
- Entering a New Value, 3-20
- Opening the Parameter, 3-18
- Setting Increment Sizes, 3-94

Error Messages

- Operation Related, 6-8
- Self Test, 6-3 - 6-7

F

Fixed Power Level Mode

- Menu Map, 4-10
- Selecting a Power Level, 3-39
- Selecting Fixed Power Level Mode, 3-39

FM Mode

- Menu Map, 4-15
- Operating Modes, 3-68
- Providing FM, 3-68

Frequency Control
 Frequency List, 3-22
 Selecting a Preset Frequency, 3-22
 Selecting a Preset Sweep Range, 3-32
 Setting a Preset Sweep Range, 3-33

Frequency Markers
 Intensity Markers, 3-34
 Marker List, 3-34
 Video Markers, 3-34

Frequency Modes
 Analog Sweep Frequency Mode, 3-25
 CW Frequency Mode, 3-21
 Manual Sweep Frequency Mode, 3-25
 Step Sweep Frequency Mode, 3-25

Frequency Scaling, 3-87

Front Panel
 Connectors, 3-7
 Data Display Area, 3-6, 3-8
 Data Entry Area, 3-7, 3-12
 Description, 3-6
 Layout, 3-6

G

General Description, 1-3

General Purpose Interface Bus (GPIB)
 Address, 2-7
 Cable Length Restrictions, 2-7
 Interface Connector, 2-7
 Line Terminator, 2-9
 Native Interface Language, 2-9
 SCPI Interface Language, 2-9
 Setup and Interconnection, 2-7

I

Identification Number, 1-8

Initial Inspection, 2-3

L

Level Offset, 3-42

Leveling Operations
 ALC Power Slope, 3-55
 Attenuator Decoupling, 3-54
 External Leveling, 3-51
 Fixed Gain, 3-53
 Internal Leveling, 3-51
 Menu Map, 4-13
 Selecting a Leveling Mode, 3-50
 User Cal (User Level Flatness Correction), 3-57

M

Maintenance, Routine
 Display Cleaning, 6-15
 Fan Filter Cleaning, 6-14
 Line Fuse Replacement, 6-15

Manual Sweep Frequency Mode
 Menu Map, 4-9
 Selecting a Power Level, 3-33
 Selecting a Sweep Range, 3-31
 Selecting Manual Sweep Mode, 3-30

Manual, Electronic, 1-8

Manual, GPIB Programming, 1-8

Manual, Maintenance, 1-9

Manual, SCPI Programming, 1-8

Markers, Frequency, 3-34

Master-Slave Operation, 7-4

Menu Maps
 AM Mode, 4-14
 Analog Sweep Frequency Mode, 4-7
 CW Frequency Mode, 4-6
 CW Power Sweep Mode, 4-11
 Description, 4-3
 Fixed Power Level Mode, 4-10
 FM Mode, 4-15
 Leveling Modes, 4-13
 Manual Sweep Frequency Mode, 4-9
 Phase Modulation Mode (Option 6), 4-16
 Pulse Modulation Mode, 4-17
 Sample Menu Map, 4-5
 Step Sweep Frequency Mode, 4-8
 Sweep Frequency/Step Power Mode, 4-12
 System Configuration, 4-18

Messages
 Error, 6-3 - 6-8
 Status, 6-10
 Warning, 6-10

Models, List of
 Series 682XXB, 1-4 - 1-5
 Series 683XXB, 1-6 - 1-7

Modulation Modes
 AM Mode, 3-63
 FM Mode, 3-63
 Phase Modulation Mode (Option 6), 3-63
 Pulse Modulation Mode, 3-63
 Scan Modulation (Option 20), 3-98

O

Operating Environment, 2-6
Operational Verification Tests, 5-3
Operator Maintenance
 Error and Warning/Status Messages, 6-3
 Routine Maintenance, 6-14
 Troubleshooting, 6-11
Options. List of, 1-9

P

Performance Specifications, 1-10, B-1
 682XXB, B-3
 683XXB, B-13
Phase Modulation Mode (Option 6)
 Menu Map, 4-16
 Operating Modes, 3-73
 Providing Phase Modulation, 3-73
Power Level Accuracy and Flatness Tests
 Accuracy Test Procedure, 5-14
 Flatness Test Procedure, 5-15
 Test Records, 5-19 - 5-64
 Test Setup, 5-13
Power Level Control
 Level List, 3-40
 Selecting a Preset Power Level, 3-40
 Selecting a Preset Sweep Range, 3-47
 Setting a Preset Sweep Range, 3-47
Power Level Modes
 CW Power Sweep Mode, 3-43
 Fixed Power Level Mode, 3-39
 Sweep Frequency/Step Power Mode, 3-43
Power Level Offset, 3-42
Power Meter, Internal (Option 8), 3-99
Power Requirements, 2-4
Preparation for Storage/Shipment, 2-13
Preparation for Use, 2-4
 Line Voltage Selection, 2-4
 Operating Environment, 2-6
 Power Requirements, 2-4
 Standby Operation, 2-5
 Warmup Time, 2-6
Pulse Modulation Mode
 Menu Map, 4-17
 Operating Modes, 3-77
 Providing Pulse Modulation, 3-78

R

Rear Panel Connectors, A-1
Recommended Test Equipment, 1-11
Reference Oscillator Calibration, 3-100
Reset (Default) Parameters, 3-16 - 3-17

S

Saving/Recalling Instrument Setups, 3-95
Scan Modulation (Option 20), 3-98
Scope of Manual, 1-3
Secure Operation, 3-97
Self Test
 Error Messages, 6-3 - 6-7
 From System Menu, 3-15
Service Centers, 2-14
Specifications, Performance
 682XXB, B-3
 683XXB, B-13
SS Mode Operation, 7-12
Start Up, 3-14
Start-Up Display, 3-14
Step Sweep Frequency Mode
 Menu Map, 4-8
 Selecting a Power Level, 3-33
 Selecting a Sweep Range, 3-31
 Selecting Alternate Sweep, 3-36
 Selecting Step Sweep Mode, 3-28
 Setting a Sweep Trigger, 3-27
 Setting Dwell Time, 3-29
 Setting Step Size, 3-29
 Using Frequency Markers, 3-34
Sweep Frequency Modes
 Analog Sweep Frequency Mode, 3-25
 Manual Sweep Frequency Mode, 3-25
 Step Sweep Frequency Mode, 3-25
Sweep Frequency/Step Power Mode
 Menu Map, 4-12
 Selecting a Sweep Frequency/Step
 Power Mode, 3-48
 Selecting a Sweep Range, 3-46
 Setting Step Size, 3-49
System Configuration
 Configuring the Front Panel, 3-87
 Configuring the GPIB, 3-91
 Configuring the Rear Panel, 3-88
 Configuring the RF, 3-89
 Frequency Scaling, 3-87
 Menu Map, 4-18
 Setting Increment Sizes, 3-94

T

Test Equipment, 1-11, 5-3
Testing, Operational Verification
 CW Frequency Accuracy, 5-5
 Initial 682XXB/683XXB Checkout, 5-4
 Power Level Accuracy and Flatness, 5-13
 Test Equipment, 5-3
 Test Records, 5-3, 5-7 - 5-12, 5-19 - 5-64
Troubleshooting Tables, 6-11 - 6-13

U

Use With Other Instruments
 Master-Slave Operation with a 68XXB, 7-4
 Use with a 360B Vector Network Analyzer, 7-11
 Use with a 562 Scalar Network Analyzer, 7-10
 Use with a 8003 Scalar Network Analyzer, 7-16
 Use with a HP8757D Scalar Network
 Analyzer, 7-20