



Advanced Test Equipment Rentals
www.atecorp.com 800-404-ATEC (2832)

Model 705 Scanner

Contains Operating and Servicing Information

KEITHLEY

WARRANTY

Keithley Instruments, Inc. warrants this product to be free from defects in material and workmanship for a period of 1 year from date of shipment.

Keithley Instruments, Inc. warrants the following items for 90 days from the date of shipment: probes, cables, rechargeable batteries, diskettes, and documentation.

During the warranty period, we will, at our option, either repair or replace any product that proves to be defective.

To exercise this warranty, write or call your local Keithley representative, or contact Keithley headquarters in Cleveland, Ohio. You will be given prompt assistance and return instructions. Send the product, transportation prepaid, to the indicated service facility. Repairs will be made and the product returned, transportation prepaid. Repaired or replaced products are warranted for the balance of the original warranty period, or at least 90 days.

LIMITATION OF WARRANTY

This warranty does not apply to defects resulting from product modification without Keithley's express written consent, or misuse of any product or part. This warranty also does not apply to fuses, software, non-rechargeable batteries, damage from battery leakage, or problems arising from normal wear or failure to follow instructions.

THIS WARRANTY IS IN LIEU OF ALL OTHER WARRANTIES, EXPRESSED OR IMPLIED, INCLUDING ANY IMPLIED WARRANTY OF MERCHANTABILITY OR FITNESS FOR A PARTICULAR USE. THE REMEDIES PROVIDED HEREIN ARE BUYER'S SOLE AND EXCLUSIVE REMEDIES.

NEITHER KEITHLEY INSTRUMENTS, INC. NOR ANY OF ITS EMPLOYEES SHALL BE LIABLE FOR ANY DIRECT, INDIRECT, SPECIAL, INCIDENTAL OR CONSEQUENTIAL DAMAGES ARISING OUT OF THE USE OF ITS INSTRUMENTS AND SOFTWARE EVEN IF KEITHLEY INSTRUMENTS, INC., HAS BEEN ADVISED IN ADVANCE OF THE POSSIBILITY OF SUCH DAMAGES. SUCH EXCLUDED DAMAGES SHALL INCLUDE, BUT ARE NOT LIMITED TO: COSTS OF REMOVAL AND INSTALLATION, LOSSES SUSTAINED AS THE RESULT OF INJURY TO ANY PERSON, OR DAMAGE TO PROPERTY.

KEITHLEY

Keithley Instruments, Inc. • 28775 Aurora Road • Cleveland, OH 44139 • 440-248-0400 • Fax: 440-248-6168 • <http://www.keithley.com>

BELGIUM:	Keithley Instruments B.V.	Bergensesteenweg 709 • B-1600 Sint-Pieters-Leeuw • 02/363 00 40 • Fax: 02/363 00 64
CHINA:	Keithley Instruments China	Yuan Chen Xin Building, Room 705 • 12 Yumin Road, Dewai, Madian • Beijing 100029 • 8610-62022886 • Fax: 8610-62022892
FRANCE:	Keithley Instruments Sarl	B.P. 60 • 3, allée des Garays • 91122 Palaiseau Cédex • 01 64 53 20 20 • Fax: 01 60 11 77 26
GERMANY:	Keithley Instruments GmbH	Landsberger Strasse 65 • D-82110 Germering • 089/84 93 07-40 • Fax: 089/84 93 07-34
GREAT BRITAIN:	Keithley Instruments Ltd	The Minster • 58 Portman Road • Reading, Berkshire RG30 1EA • 0118-9 57 56 66 • Fax: 0118-9 59 64 69
INDIA:	Keithley Instruments GmbH	Flat 2B, WILOCRISSA • 14, Rest House Crescent • Bangalore 560 001 • 91-80-509-1320/21 • Fax: 91-80-509-1322
ITALY:	Keithley Instruments s.r.l.	Viale S. Gimignano, 38 • 20146 Milano • 02/48 30 30 08 • Fax: 02/48 30 22 74
NETHERLANDS:	Keithley Instruments B.V.	Postbus 559 • 4200 AN Gorinchem • 0183-635333 • Fax: 0183-630821
SWITZERLAND:	Keithley Instruments SA	Kriesbachstrasse 4 • 8600 Dübendorf • 01-821 94 44 • Fax: 01-820 30 81
TAIWAN:	Keithley Instruments Taiwan	I Fl. 85 Po Ai Street • Hsinchu, Taiwan, R.O.C. • 886-3572-9077 • Fax: 886-3572-903

Model 705 Scanner Instruction Manual

©1982, Keithley Instruments, Inc.
All rights reserved.
Cleveland, Ohio, U.S.A.
Sixth Printing, April 2000
Document Number: 705-901-01 Rev. F

SPECIFICATIONS

CAPACITY: Two plug-in cards per mainframe.

EXPANSION CAPACITY: Daisy chain allows up to 4 SLAVE units with 1 MASTER unit.

SWITCHING RATE: 100 channels/second (10ms), programmable to 1 channel/16 minutes (999.999s).

RELAY DRIVE: 350mA minimum.

INTERNAL CLOCK: Displays hours/minutes/seconds or date/month; less than 1 minute/month error (typical).

BATTERY BACKUP: Rechargeable 3.6V nickel-cadmium. 1 month retention of data (typical) with unit turned off.

IEEE-488 BUS IMPLEMENTATION

Multiline Commands: DCL, LLO, SDC, GET, GTL, UNT, UNL, SPE, SPD.

Uniline Commands: IFC, REN, EOI, SRQ, ATN.

Interface Functions: SH1, AH1, T6, TE0, L4, LE0, SR1, RL1, PP0, DC1, DT1, C0, E1.

Programmable Parameters: Display Mode, Output Format, EOI, SRQ, First, Last, Open, Close, Display Channel, Alternate Output, Pole Mode, Date Format, Save/Restore, Reset, I/O Port, Time, Date, Settling Time, Interval Time, Alarm Time, Program Mode, Trigger Mode, Terminator, Self Test.

Digital I/O Port: A separate I/O port consisting of eight input and eight output lines as well as common (IEEE-488) and +5VDC. Outputs will drive one TTL load. Inputs represent one TTL load. Mating connector supplied.

FRONT PANEL PROGRAMS

0 - Digital I/O	Read or change state on digital I/O port.
1* - Date Format	Changes date display between MM.DD and DD.MM.
2* - Settle Time	Time to output CHANNEL READY pulse after closing relay.
3* - IEEE Address	Set bus address; cannot be programmed from bus.
4* - Save Setup	Stores present relay setup in numbered (1 - 5) buffer.
5* - Restore Setup	Recalls relay setup in buffer 1 - 5.
6* - Poles	1, 2 or 4-pole configuration for switching.
7 - Alarm Time	Set time for Alarm output pulse; repeats daily.
8 - Self Test	Check RAM, ROM, LEDs.
90* - Stand Alone	Single 705 configuration.
91* - Master	Daisy chain configuration.
92* - Slave	Daisy chain configuration.
99 - Reset	Reset battery backup parameters to factory values.

*Battery backed up.

GENERAL

DISPLAY: Six 0.5" LED digits with decimal point, function and IEEE status annunciators.

OPERATING ENVIRONMENT: 0° to 50°C, 0% to 80% relative humidity up to 35°C.

STORAGE ENVIRONMENT: -25° to 65°C.

CONNECTORS: Four BNC; External Trigger, Alarm Out/Serial-In, Channel Ready, Serial Out (TTL compatible).

POWER: 105-125V or 210-250V (internal switch selected), 50Hz to 400Hz, 25 V•A maximum. 90-110V and 180-220V version available.

DIMENSIONS, WEIGHT: 127mm high × 216mm wide × 359mm deep (5" × 8½" × 14½"). Net weight 3kg (6½ lbs.).

ACCESSORIES AVAILABLE:

Model 1019A: 5¼" Universal Fixed Rack Mounting Kit

Model 1019S: 5¼" Universal Slide Rack Mounting Kit

Model 4801: BNC-to-BNC Cable

Model 7008-3: IEEE-488 Cable, 0.9m (3 ft.)

Model 7008-6: IEEE-488 Cable, 1.8m (6 ft.)

Model 7010: IEEE-488 Adapter for Model 85 Computer

Model 7024-3: Triaxial Cable, 0.9m (3 ft.)

Model 7024-10: Triaxial Cable, 3.0m (10 ft.)

Model 7055: Quick Disconnect Card

Model 7056: General Purpose Scanner Card

Model 7057: Thermocouple Scanner Card

Model 7058: Low Current Scanner Card

Model 7059: Low Voltage Scanner Card

Specifications subject to change without notice.

SPECIFICATION ADDENDUM

1. Battery back-up time is for unit at 23°C. Operation or storage at higher temperatures could reduce this time below 1 month. Even under extremes a fully charged system should last a week.
2. Note that some plug-in card specifications may limit mainframe performance when installed (e.g. Humidity).
3. Relay drive capability at 400Hz is limited to 200mA typical and a maximum ambient temperature of 35°C.

Table of Contents

1 General Information

Introduction	1-1
Features	1-1
Warranty Information.....	1-1
Manual Addenda	1-1
Safety Symbols and Terms.....	1-1
Unpacking and Inspection.....	1-1
Specifications	1-1
Accessories.....	1-1
Repacking for Shipment.....	1-2

2 Operation

Introduction	2-1
Preparation for Use	2-1
Correct Line Voltage.....	2-1
Plug-In Card (Scanner) Installation	2-1
Power-up	2-1
Environmental Conditions	2-3
Operating Instructions	2-3
Front Panel Controls	2-3
Rear Panel Description.....	2-5
Basic Front Panel Operation	2-7
Front Panel Programs	2-13
Program 0 Digital I/O	2-13
Program 1 Date Format.....	2-13
Program 2 Settle Time	2-14
Program 3 Primary Address.....	2-14
Program 4 Save Present Relay Set Up.....	2-15
Program 5 Recall Stored Relay Set Up.....	2-15
Program 6 Pole Modes.....	2-16
Program 7 Set Alarm Time	2-17
Program 8 Self Test.....	2-18
Program 90 Stand Alone	2-18
Program 91 Master.....	2-18
Program 92 Slave	2-19
Program 99 Reset	2-19

3 IEEE Bus Operation

Introduction	3-1
Software Considerations.....	3-1
HP-85 BASIC Statements	3-1
Interface Function Codes.....	3-2
Model 705 Interface Commands	3-3
IEEE-488 Bus Lines	3-3
Bus Management Lines	3-3
Handshake Lines	3-4
Data Lines.....	3-4
System Set up Procedure	3-4
Bus Commands.....	3-5
Uniline Commands.....	3-5
Universal Commands	3-6
Addressed Commands.....	3-7
Device-Dependent Commands.....	3-8
Display Mode	3-8
Program (Scan) Mode.....	3-12
Prefix	3-12
EOI	3-12
Bus Response Mode (SRQ).....	3-13
Trigger Modes	3-15
Programmable Terminator (Y).....	3-15
Inputs	3-15
Status Byte Format	3-23
Status Word (UO).....	3-23
Front Panel Programs	3-24
Front Panel Error Messages.....	3-24
IDDC Error.....	3-25
No Remote Error	3-25
Scanning Program	3-25

4 Theory of Operation

Introduction	4-1
Power Supply.....	4-1
Microcomputer	4-1
Display Circuit.....	4-3
IEEE-488 Interface Circuitry	4-3

5 Maintenance

Introduction	5-1
Fuse Replacement.....	5-1
Line Voltage Selection	5-1
Disassembly.....	5-1
Troubleshooting.....	5-3
Digital Self Test.....	5-3
Battery Charge	5-3

6 Replaceable Parts

Introduction	6-1
Parts List	6-1
Ordering Information	6-1
Factory Service.....	6-1
Schematic Diagrams and Component Location Drawings	6-1

List of Illustrations

2 Operation

Figure 2-1	Scanner Card Installation	2-2
Figure 2-2	Model 705 Front and Rear Panels.....	2-6
Figure 2-3	Daisy Chaining Three Model 705's	2-9

3 IEEE Bus Operation

Figure 3-1	Bus Structure	3-3
Figure 3-2	Handshake Sequence.....	3-4
Figure 3-3	Contact Assignment	3-5
Figure 3-4	Model 705 IEEE Bus Connector.....	3-5
Figure 3-5	Digital I/O Port Pin Assignments.....	3-19
Figure 3-6	U and G Modes Sequence	3-23
Figure 3-7	Status Byte Format.....	3-23
Figure 3-8	U4 Status Word (Reset conditions shown)	3-24
Figure 3-9	IEEE Display Error Messages.....	3-25

4 Theory of Operation

Figure 4-1	Model 705 Block Diagram	4-2
Figure 4-2	Memory Map.....	4-1

5 Maintenance

Figure 5-1	Model 705 Exploded View	5-2
------------	-------------------------------	-----

6 Replaceable Parts

Figure 6-1	Interconnect Board, Component Location Drawing, Dwg. No. 705-160	6-7
Figure 6-2	Display Board, Component Location Drawing, Dwg. No. 705-110.....	6-9
Figure 6-3	I/O Board, Component Location Drawing, Dwg. No. 705-173.....	6-11
Figure 6-4	Mother Board, Component Location Drawing, Dwg. No. 705-100	6-13
Figure 6-5	Mother Board, Schematic Diagram, Dwg. No. 705-106.....	6-17
Figure 6-6	Display Board, Schematic Diagram, Dwg. No. 705-116.....	6-23
Figure 6-7	I/O Board, Schematic Diagram, Dwg. No. 705-176.....	6-25
Figure 6-8	Interconnect Board, Schematic Diagram, Dwg. No. 705-166	6-27

List of Tables

2 Operation

Table 2-1	Line Voltage Setting	2-1
Table 2-2	Power Up Default Conditions (Front Panel Operation).....	2-3
Table 2-3	Summary of Front Panel Programs.....	2-13
Table 2-4	Switching Card Pole Modes.....	2-16
Table 2-5	Program 99 Reset Conditions	2-20

3 IEEE Bus Operation

Table 3-1	HP-85 IEEE-488 BASIC Statements.....	3-2
Table 3-2	Model 705 Interface Function Codes.....	3-3
Table 3-3	IEEE Command Groups.....	3-3
Table 3-4	IEEE Bus Connector Contact Designations.....	3-5
Table 3-5	Power-Up Default Values	3-6
Table 3-6	SDC Set Conditions	3-7
Table 3-7	Device-Dependent Commands	3-9
Table 3-8	Hierarchy of Command Execution	3-10
Table 3-9	SRQ Commands and Conditions	3-13
Table 3-10	Digital I/O Port Contact Pin Assignments	3-20

5 Maintenance

Table 5-1	Fuse Replacement, 3AG size	5-1
Table 5-2	Fuse Replacement, 5mm size.....	5-1
Table 5-3	Line Voltage Selection.....	5-1

6 Replaceable Parts

Table 6-1	Index of Model 705 Schematics and Component Layouts	6-1
Table 6-2	Display Board 705-110, Parts List.....	6-2
Table 6-3	Mother Board 705-103, Parts List.....	6-3
Table 6-4	Digital I/O Board 705-173, Parts List.....	6-5
Table 6-5	Model 705 Mechanical Parts List	6-6

SECTION 1 GENERAL INFORMATION

1.1 INTRODUCTION

The Model 705 is a low cost IEEE compatible scanner. The basic mainframe can accommodate two plug-in scanner cards. Each card can have different pole configurations. In the 1-pole configuration the card has 20 channels. The 4-pole configuration allows 10 channels with two cards (for four-wire ohms). Using the "daisy chain" method the Model 705, along with four additional Model 705's, can provide up to 100 2-pole channels. The time and the date are kept internally with a battery backed up clock allowing time dependent procedures to be performed.

The controls on the front panel allow opening a selected channel, closing the channel, scanning between a selectable first and last channel, selectable scan rate and mode. There are 13 internal programs that are accessible from the front panel. The programs can select primary address, dwell time, store a relay set up, recall the stored relay set up, control the digital I/O port, switch from International to American date format, control interval stop/start and select 1-, 2- or 4- pole measurement modes.

The Model 705 Scanner adheres to standard IEEE-488 interface bus protocol. This enables the Model 705 to be incorporated into any measurement system that uses programmed control through the IEEE-488 bus.

1.2 FEATURES

The Model 705 Scanner includes the following features:

- IEEE-488 bus operation.
- Selectable scan rate from 10ms to 999.999sec.
- Selectable scan modes that allow the operator to scan the first channel to the last channel once, continuously or manually.
- Thirteen internal programs that are available through the front panel.
- Model 705 mainframe can accommodate two scanner plug-in cards.
- Several different scanner relay cards are available as options. They include: a general purpose relay card; a thermocouple relay card; a low voltage relay card; and a low current relay card.
- Time and date are kept with a battery backed up clock.
- Digital I/O port with eight lines as inputs and eight lines as outputs.

1.3 WARRANTY INFORMATION

Warranty information is provided on the inside front cover of this manual. If there is a need to exercise the warranty, contact the Keithley representative in your area to determine the proper

action to be taken. Keithley maintains complete repair and calibration facilities in the United States, West Germany, Great Britain, France, the Netherlands, Switzerland and Austria. Information concerning the application, operation or service of your instrument may be directed to the applications engineer at any of the above locations. Check the inside front cover of this manual for addresses.

1.4 MANUAL ADDENDA

Improvements or changes to this manual will be explained on an addendum included with this manual.

1.5 SAFETY SYMBOLS AND TERMS

Safety symbols used in this manual are as follows:

The symbol  on the instrument denotes that the user should refer to the operating instructions.

The symbol  on the instrument denotes that 1000V or more may be present on the terminal(s).

The **WARNING** used in this manual explains dangers that could result in personal injury or death.

The **CAUTION** used in this manual explains hazards that could damage the instrument.

1.6 UNPACKING AND INSPECTION

The Model 705 is inspected both mechanically and electrically before shipment. Upon receiving the Model 705 unpack all items from the shipping container and check for any obvious damage that may have occurred during transit. Report any damage to the shipping agent. Retain and use the original packaging materials if reshipment is necessary. The following items are shipped with all Model 705 orders:

- Model 705 Scanner
- Model 705 Instruction Manual
- Optional accessories per request.

1.7 SPECIFICATIONS

For Model 705 detailed specifications, refer to the specifications that precede this section.

1.8 ACCESSORIES

Model 1019A Rack Mounting Kit—The Model 1019A rack mounting kit can accommodate one or two Model 705's. The dimensions are 133mm × 483mm (5 ¼ × 19in).

Model 1019S Slide Rack Mounting Kit—Enables one or two half rack size instruments to be rack mounted with the added feature of sliding the instrument(s) for easy access. The dimensions are 133mm × 483mm (5 ¼ × 19in.).

Model 7055 Quick Disconnect Card—The Model 7055 is an integral part of the Model 7056 General Purpose Scanner Card. The Model 7055 is the section of the Model 7056 that provides the input and output connections. Several Model 7055s can be prewired for particular applications. When that particular application is required the present Model 7055 can be replaced with another Model 7055.

Model 7056 General Purpose Scanner Plug-In Card—The Model 7056 is field installable in the Model 705 Scanner mainframe. The general purpose card will switch up to 10 2-pole channels. The card can be used as a voltage scanner, independent relay card or a matrix card. The 2-pole switching is accomplished in less than 10ms and the expected relay life is 10^6 closures at the maximum contact ratings. Barrier strips are used to facilitate input and output connections to the relay scanner plug-in card. The plug-in card can be easily removed through the rear panel of the Model 705.

Model 7057 Thermocouple Scanner Plug-In Card—The Model 7057 is a low voltage scanner card which is field installable in the Model 705 scanner mainframe. Since it combines the functions of a thermocouple scanner and uniform temperature reference it is especially useful for scanning thermocouples. The input terminals are #110 alloy-copper set in an isothermal block to minimize temperature differences. A thermistor sensor within the isothermal block is used with a bridge network on a Model 7057 to give an indication of the temperature reference or cold junction. The temperature of the heat sink is used to calculate the corrected thermocouple output. The output voltages of each thermocouple must be converted to temperature ($^{\circ}\text{C}$ or $^{\circ}\text{F}$) using appropriate thermocouple tables or polynomial equations. In addition any channel may be used to monitor low level signals. The Model 7057 uses two form A contacts for scanning of signals up to 35V peak or 100mA peak. Input and output connections are made through the rear panel of the scanner mainframe using #4 screw terminals on the Model 7057.

Model 7058 Low Current Scanner Plug-In Card—The Model 7058 is field installable in the Model 705 Scanner Mainframe. The low current card will switch up to 10 1-pole channels. For optimum low level current switching, the Model 7058 is designed to minimize offset current error (less than 1pA), while guarding ensures that high isolation is maintained between input signals. The break-before-make, single pole switching of the Model 7058 is designed to maintain current paths for signals not connected to the output, or when internal jumpers are removed to provide high input resistance for making voltage measurements. AC or DC signals up to 28V or 100mA may be scanned. Triaxial input and output connections to the scanner plug-in card are easily made through the rear panel of the Model 705 Scanner mainframe.

Model 7059 Low Voltage Plug-In Card—The Model 7059 is a low voltage scanner plug-in card which is field installable in the Model 705 Scanner mainframe. The Model 7059 will switch up to 10 channels. For low level transducer and thermocouple output switching the Model 7059 is designed to minimize thermal error voltage (less than $1\mu\text{V}$ with respect to copper) and ensure that high isolation ($10^{12}\Omega$) is maintained between input signals. The break-before-make, 2-pole switching is accomplished in less than 5ms. Expected relay life (10^8 closures) is obtained when signals less than 10V or less than 10mA are scanned. However, peak signals up to 200V or 100mA may be scanned. Barrier strips are used to facilitate input and output connections to the scanner plug-in card. The Model 7059 is easily removed through the rear panel of the Model 705 Scanner mainframe.

Model 7008-3 IEEE-488 Cable—The Model 7008-3 is a three foot (1 meter) IEEE-488 cable. The cable has 24 stranded wire conductors and is terminated with IEEE-488 standard connectors.

Model 7008-6 IEEE-488 Cable—The Model 7008-6 is a six foot (2 meter) IEEE-488 cable. The cable has 24 stranded wire conductors and is terminated with IEEE-488 standard connectors.

Model 4801 Low Noise BNC to BNC Cable—The Model 4801 is a low noise BNC-to-BNC cable which is especially useful for "daisy chain" wiring configurations of multiple Model 705's.

Model 7010 Cable Adapter—The Model 7010 is an IEEE-488 cable adapter. The adapter extends the IEEE-488 connector by one connector width.

1.9 REPACKING FOR SHIPMENT

The Model 705 should be packed in its original carton. Before packaging, wrap the instrument in plastic. After it is placed in the box, surround the instrument with styrofoam packaging material.

If the Model 705 is to be returned to Keithley Instruments for calibration or repair, include the following:

- ATTENTION REPAIR DEPARTMENT on the address label.
- Warranty status of the instrument.
- Completed service form.

SECTION 2 OPERATION

2.1 INTRODUCTION

This section contains information necessary to operate the Model 705 Scanner. Information is arranged as follows:

- Preparation For Use
- Power-Up
- Environmental Conditions
- Front and Rear Panels Description
- Front Panel Operation
- Front Panel Programs

2.2 PREPARATION FOR USE

2.2.1 Correct Line Voltage

Plug the Model 705 into the proper power receptacle, (See Table 2-1). For fuse replacement or line voltage switch setting, refer to the maintenance section.

WARNING

Ground the instrument through a properly earth grounded receptacle before operation. Failure to ground the instrument can result in severe injury or death in the event of short circuit or malfunction.

Table 2-1. Line Voltage Setting

Input Voltage	Switch Setting (S102)	Fuse F101	
		3AG	5mm
90V-110V*	115VAC	3/16A, 250V	2/10A, 250V
105V-125V	115VAC	3/16A, 250V	2/10A, 250V
180V-220V*	230VAC	1/10A, 250V	1/16A, 250V
210-V-250V	230VAC	1/10A, 250V	1/16A, 250V

*Requires special factory installed transformer.

2.2.2 Plug-In Card (Scanner) Installation

Before operating the Model 705, the necessary plug-in cards must be installed into the mainframe. The scanner plug-in card is installed via the opening on the Model 705 rear panel. Refer to Figure 2-1 for an overall picture of plug-in card installation.

WARNING

To prevent a possible shock hazard, turn the instrument off and remove the line cord before removing or installing any scanner plug-in card.

1. To install a plug-in card, slide the plug-in card into the rear panel opening with the component side facing up. Make certain the card edges are aligned with the grooves in the receptacle. When the card is fully inserted, the locking tabs

on the card should be snapped into the locked position as shown in Figure 2-1.

2. To remove a plug-in card, unfasten the locking tabs by pulling both tabs outward. Grasp the end of the card and pull it out of the mainframe.

NOTE

Handle the plug in cards by the edges to avoid contaminating them with dirt, body oil etc.

2.3 POWER-UP

NOTE

Battery B101 is charging while the unit is on. Refer to paragraph 5.7.

Immediately after turning on the Model 705 via the power switch, the display indicates the following for several seconds:

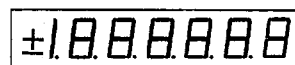

1. This is a display test. The operator can note inoperative display segments by comparing the Model 705's display with the figure above.
2. In addition, the push button and the TALK, LISTEN and REMOTE indicators turn on. All indicators turn on simultaneously if operating correctly.

After the test is complete, the Model 705 displays the software revision level for approximately one second.

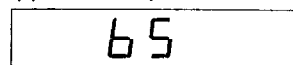

After the software revision level is displayed, the Model 705 displays the primary address of the instrument for approximately one second. The primary address of the Model 705 is factory set at 17.

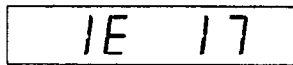

During the display test the Model 705 performs a digital self test of the RAM circuitry and a cyclic redundancy check of the ROM circuitry. If the self test or CRC reveals a problem with the ROM or RAM circuitry the Model 705 displays a diagnostic number. This number, and its meaning, is explained in detail in Section 5.

After all the displays and tests of the power up cycle, the Model 705 comes up to the default conditions. Refer to Table 2-2 for default conditions.

NOTE

If upon power-up the Model 705 displays the slave or broken loop message (refer to paragraphs 2.6.10, 2.6.11 and 2.6.12) activate program 90 to return the Model 705 to normal operating conditions. To activate program 90, press PRGM, 9, 0.

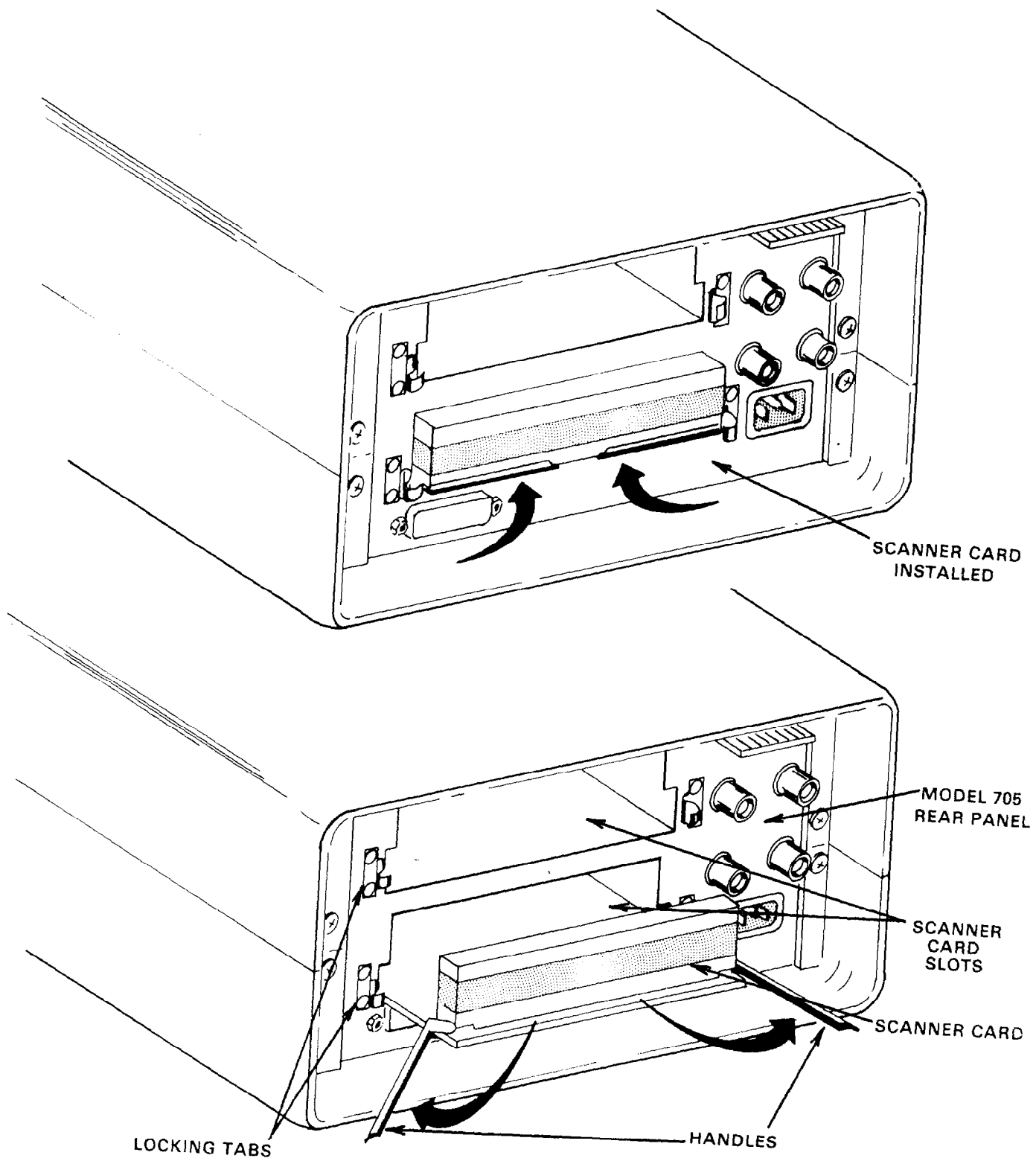

Figure 2-1. Scanner Card Installation

Table 2-2. Power Up Default Conditions (Front Panel Operation)

Function or Program	Default Conditions
CHANNEL	Channel mode is selected, Channel 1 is displayed and all channels are open.*
TIME	Time is not affected by power up.
DATE	Date is not affected by power up.
RESET	Reset is not affected by power up.
INTERVAL	Interval time is not affected by power up.
SINGLE	Single scan mode is set to inactive.
CONTINUOUS	Continuous scan mode is set to inactive.
START/STOP	Start/Stop function is set to Stop.
Program 0	Digital I/O outputs are set to 000, inputs are not affected by power up.
Program 1	Date format is not affected by power up.
Program 2	Settle time is not affected by power up.
Program 3	Primary address is not affected by power up.
Program 4	Save relay set up is cleared.
Program 5	Recall relay set up is cleared.
Program 6	Number of poles is not affected by power up.
Program 7	Alarm time is set to 00.00.00.
Program 8	Self test is not activated.
Program 90	Program 90 is not affected by power up.
Program 91	Program 91 is not affected by power up.
Program 92	Program 92 is not affected by power up.
Program 99	Program 99 is not activated.
FIRST	The First function is not affected by power up.
LAST	The Last function is not affected by power up.

*If Channel 1 was previously programmed as the first channel, last channel or both it is displayed as such. This is because the FIRST and LAST functions are battery backed up and therefore not affected by power up.

NOTE

To identify the previous state of the functions that are not affected by power up simply activate the desired function. When the function is activated the previous state for that function is displayed. Refer to paragraph 2.5.1 Front Panel Controls for information concerning the actuation of the desired function.

2.4 ENVIRONMENTAL CONDITIONS

All operation of the Model 705 should take place at an ambient temperature within the range of 0°C to 50°C, up to 35°C at 80% noncondensing relative humidity. Environmental conditions for storage are -25°C to +65°C.

2.5 OPERATING INSTRUCTIONS

2.5.1 Front Panel Controls

1. The power ON/OFF switch operates on the push-push principle. Depressing this button turns the instrument on. Once the instrument is on, pressing (releasing) this button turns the instrument off. When the Model 705 is turned on it goes through a power-up sequence as outlined in paragraph 2.3. When the power-up sequence is complete the Model 705 displays the following:

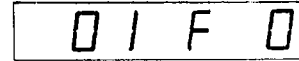

01 = Channel Number One

F = First Channel*

0 = Channel Open

The CHANNEL LED lights, indicating that the Model 705 is in the channel mode.

*If Channel 1 was previously programmed as the first channel, last channel or both, it is displayed as such. This is because the FIRST and LAST functions are battery backed up and not affected by power up.

2. The CHANNEL button selects the channel mode for display. The channel number is displayed on the front panel as a two digit number. Upon power-up, the Model 705 reverts to the channel mode. Pressing the CHANNEL button while the Model 705 is in the channel mode increments the channel number by one. Pressing the CLOCK, DATE, PRGM, SINGLE, CONTINUOUS or INTERVAL buttons takes the Model 705 out of the channel mode. Pressing the RESET button during any of the front panel programs except Programs 90, 91, 92 and 99 (see paragraph 2.6 for front panel program information) reverts the Model 705 to the channel mode.

3. The OPERATION group consists of four buttons: FIRST, LAST, CLOSE and OPEN. The buttons are described as follows:

A. The CLOSE button when activated, closes the presently displayed channel. If the presently displayed channel is already closed, pressing the CLOSE button has no effect on the channel. When the presently displayed channel is open and the CLOSE button is pressed, the open and closed digit (furthest digit on the right of the display) changes as follows.



0 Indicates a channel is open, and that C indicates a channel is closed.

B. The OPEN button when activated, opens the presently displayed channel. If the presently displayed channel is already open, pressing the OPEN button has no effect on the channel. When the presently displayed channel is closed, and the OPEN button is pressed, the open and close digit (furthest digit on the right of the display) changes as follows.



C Indicates a closed channel, and that 0 indicates an open channel.

NOTE

Close and open for each channel remain valid even when not viewing the channel or the display.

- C. The FIRST button, when pressed, specifies the presently displayed channel as the first channel of a multichannel configuration. If the presently displayed channel has already been specified as the first channel, pressing the FIRST button has no effect on the channel or the display. If the presently displayed channel has not been specified as the first channel, the display format is shown as follows:

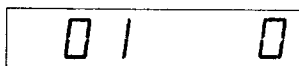

01 = Present Channel
0 = Channel Open

Pressing the FIRST button specifies the channel as the first channel and the display format is shown as follows:

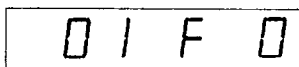

01 = Present Channel
F = First channel of a multichannel configuration
0 = Channel open

NOTE

There are two ways to change the specified first channel, one is to select the desired new channel and then press the FIRST button; the other way is to activate front panel Program 99 (refer to paragraph 2.6). Powering the unit down will not change the specified first channel.

- D. The LAST button when pressed specifies the presently displayed channel as the last channel of a multichannel configuration. If the presently displayed channel has already been specified as the last channel, pressing the LAST button has no effect on the channel or the display. If the presently displayed channel has not been specified as the last channel of a multichannel configuration, the display format is as follows:

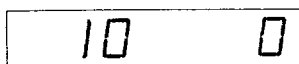

10 = Present Channel
0 = Channel Open

Pressing the LAST button specifies the channel as the last channel of a multichannel configuration and the display format is as follows:

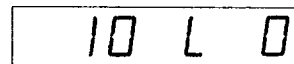

10 = Present Channel
L = Last Channel of a Multichannel Configuration
0 = Channel Open

NOTE

There are two ways to change the specified last channel, one is to select the desired new channel and then press the LAST button, the other way is to activate front panel Program 99 (refer to paragraph 2.6). Powering the unit down will not change the specified last channel.

- 4. The CONTROL group of buttons consist of the RESET button and the INTERVAL button. The buttons are described as follows:

- A. The RESET button opens all channels of the Model 705 and reverts the display to the specified first channel. The RESET button is inactive in the time, interval and date modes. Pressing the RESET button during a Single or Continuous scan mode sequence stops the scan mode, opens all the channels, and reverts the display to the specified first channel.

- B. The INTERVAL button selects the programmed interval time for display. The interval time is the programmed time each channel is closed when using the single, continuous, or step scanning modes. The interval time ranges from 5msec to 999.999sec in 1msec increments. Upon the actuation of front panel Program 99 the interval time is reverted to the default condition of 10msec (displayed as 000.010). Powering the unit down will not change the programmed interval time. Two ways the interval time can be changed is either, activate front panel Program 99; (see paragraph 2.6) or press the INTERVAL button, and then press the appropriate numbers from 000.010 to 999.999 and the ENTER button.

- 5. The DATA group of buttons consist of the 0-9, CANCEL and ENTER buttons. They are described as follows:

- A. The 0-9 data keys allow entry of numerical data onto the display. The 0-9 keys can be used to enter numerical constants on the display for certain functions such as interval time, channel number, front panel programs, time and date.

- B. The ENTER button loads the displayed data for the interval time, date and program modes into the Model 705. In the PRGM mode, the ENTER button initiates the selected program (0, 1, 2, 3, 6 or 7) after the necessary data is entered onto the display. Refer to paragraph 2.6 for information concerning the front panel programs.

- C. During the entry of data (c segment cursor is flashing) the CANCEL button cancels the present display and reverts the instrument to the previous display. The CANCEL button is functional only when entering data onto the display in the interval, time, date and program modes.

6. The SCAN group of buttons consists of the SINGLE, CONTINUOUS and START/STOP buttons. These three buttons select the different scan modes. The SCAN group of buttons are described as follows:

A. The CONTINUOUS button selects the continuous scan mode. The continuous scan mode allows the user to scan through the programmed channels at the programmed interval rate continuously. The continuous scan mode is initiated upon the actuation of the START/STOP button or upon receiving the appropriate external trigger pulse. Pressing the START/STOP button while the continuous scan mode is running stops the scan at the presently displayed channel. Pressing the START/STOP button again starts the continuous scan at the channel in which it was stopped.

B. The SINGLE button selects the single scan mode. The single scan mode allows the user to scan through the programmed channels at the programmed interval rate one time. The single scan mode is initiated upon the actuation of the START/STOP button or upon receiving the appropriate external trigger pulse. Pressing the START/STOP button while the single scan mode is running stops the scan at the presently displayed channel. Unless interrupted, the single scan mode will scan through the programmed channels at the programmed interval rate and then stop at the programmed first channel.

C. The START/STOP button is an alternate action control that has three functions. The three functions are the START function, the STOP function and the STEP scan mode. They are described as follows:

a. The start function of the START/STOP button initiates the selected scan mode. When all the parameters (interval, time, first and last channels, scan mode, etc.) of a multichannel configuration have been programmed and the user is ready to scan the channels, press the START/STOP button to initiate the scan. During the scan mode the START/STOP LED is activated.

b. The stop function of the START/STOP button stops the previously initiated scan mode. That is, pressing the START/STOP button during a scan stops the sequence at the presently displayed channel and turns off the START/STOP LED. The stop function of the START/STOP button is active only when a scanning sequence is scanning.

c. The step scan mode allows the user to manually step through the programmed channels. The step scan mode is selected by pressing the channel button, programming the interval time and pressing the START/STOP button. When the interval time has been programmed and the user is ready to manually scan the channels, press the START/STOP button to scan (closed and open channel at the programmed interval time) one channel. Upon initiating the step scan mode the START/STOP LED turns on, the presently displayed channel is closed for the programmed interval rate, the channel is opened, the START/STOP

LED turns off and the Model 705 advances to the next channel. To scan the next channel press the START/STOP button and the Model 705 will go through the same sequence.

7. The CLOCK group consists of two buttons that control the display of the time function and the date function. The clock continues to run after the instrument is powered down because the clock's power circuitry is backed up by battery BT101. The two clock buttons are described as follows:

A. The TIME button selects for display the 24 hour time clock. The format showing 2:45 p.m. is as follows:

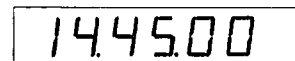
A rectangular digital display showing the time 14.45.00 in a monospace font.

The time can be set by pressing the TIME button, entering the appropriate time onto the display and then pressing the ENTER button.

B. The DATE button selects the date mode for display. The date display has two formats. The formats showing August 18th are as follows:

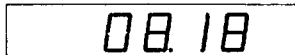
American date format 

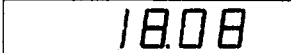
International date format 

The formats are selected by front panel Program 1. Refer to paragraph 2.5 6 for information concerning the front panel programs. The date can be set by pressing the DATE button, entering the appropriate date onto the display and then pressing ENTER.

8. The PRGM button when pressed shows a display that prompts the user to select one of the 13 front panel programs. Refer to paragraph 2.6 for complete details and examples of the front panel programs.

9. The IEEE bus indicators (TALK, LISTEN and REMOTE) identify the present status of the IEEE-488 bus. The indicators are described as follows:

A. The TALK LED when lit indicates that the Model 705 is in the talk mode. The Model 705 does not have to be in the remote mode for it to be in the talk mode.

B. The LISTEN LED when lit indicates that the Model 705 is in the listen mode. The Model 705 must also be in the remote mode for it to be in the listen mode.

C. The REMOTE LED when lit indicates that the Model 705 is in the remote mode.

2.5.2 Rear Panel Description

1. The two plug-in slots in the Model 705 mainframe can accommodate two relay scanner cards. The Model 705 with two relay scanner cards has up to 20 2-pole individual channels. Refer to paragraph 2.2.2 for instructions on how to remove or install the various plug-in cards.

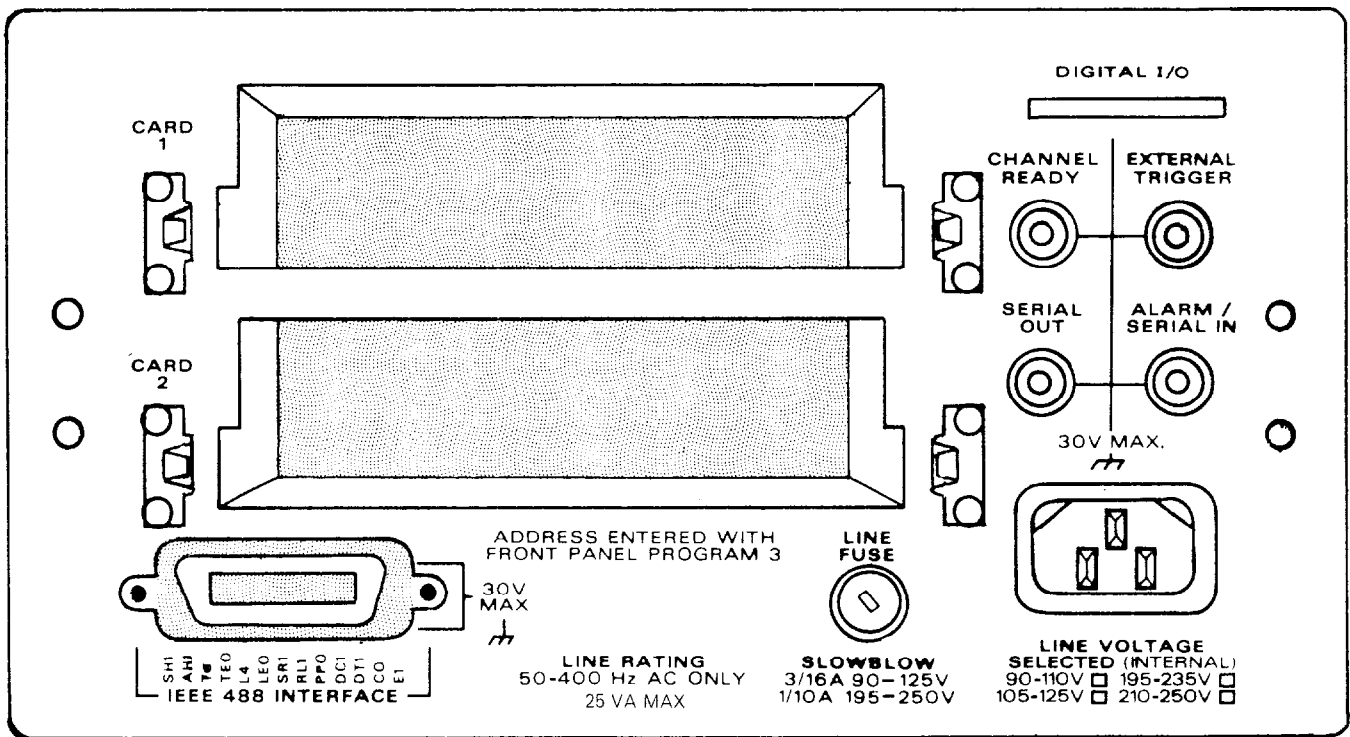
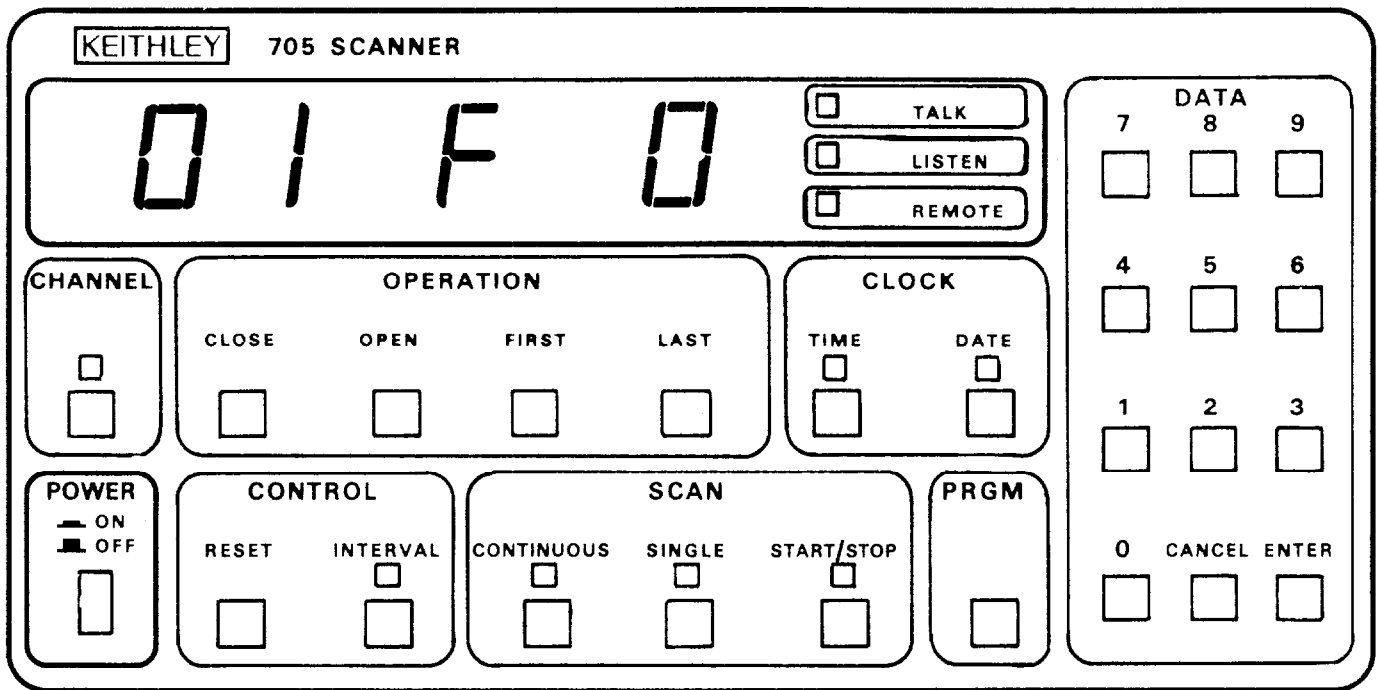

Figure 2-2. Model 705 Front and Rear Panels

2. The EXTERNAL TRIGGER is a BNC connector that initiates the selected scan mode (single, step or continuous) in the same manner as the START/STOP button. The input trigger pulse must be a negative going pulse at a TTL level with a minimum duration of $2\mu\text{sec}$. The selected program mode is initiated upon the negative transition of the pulse. This feature can be used to trigger the Model 705 into the selected scan mode using another instrument.
3. CHANNEL READY is a BNC output connector that provides a negative going TTL level pulse of greater than $10\mu\text{sec}$ at the completion of the programmed channel settling time. This feature can be used to inform another instrument (e.g. DMM, Source, etc.) that the present channel settling time is completed.
4. The ALARM/SERIAL IN connector has two functions. The Alarm out function and the SERIAL IN function. As the Alarm out function the Model 705 outputs a negative going TTL level greater than $10\mu\text{sec}$ pulse to the ALARM/SERIAL IN connector. When the Alarm time is set to 00.00.00 the pulse does not appear. The SERIAL IN function is used in a daisy chain configuration where the SERIAL IN connector is connected to the SERIAL OUT connector of another Model 705. Refer to paragraph 2.5.3 example 4 for more information.
5. SERIAL OUT is a BNC output connector that provides connection to another Model 705 for a daisy chain configuration. Refer to Figure 2-3 for a typical daisy chain configuration. The SERIAL OUT connector is applied to the ALARM/SERIAL IN connector of another Model 705.
6. The Digital I/O port consists of 16 digital input/output lines along with four lines that are +5V and IEEE common. Eight of the I/O lines can be used for inputs and eight can be used for outputs. This allows the user a limited number of control lines to the IEEE bus. The outputs will drive one TTL load and the inputs are TTL compatible. For more information concerning the digital I/O port refer to paragraph 3.5.8/16.
7. The IEEE bus connector provides bus connection to the Model 705. The connector mates with the Keithley Model 7008-3 and Model 7008-6 cables. For more detailed information concerning the IEEE connector refer to paragraph 3.3.
8. The line power fuse is rated as specified in Table 5-1.
9. The line power receptacle mates with three wire line cord which provides connections to line voltage. For correct line voltage selection refer to paragraph 5.3.

2.5.3 Basic Front Panel Operation

This section provides the information necessary for basic front panel operation of the Model 705. There are a number of steps to follow in order to get the Model 705 ready for scanning operation. These steps are as follows:

1. Install the desired scanner card(s). Refer to paragraph 2.2.2 for information concerning the installation of the scanner cards into the Model 705.
2. Select appropriate line voltage. Refer to paragraph 2.2.1 for information concerning the selection of the appropriate line voltage. Turn the Model 705 on. The instrument goes through the power-up sequence described in paragraph 2.3 and displays the following:

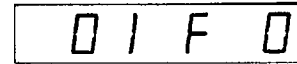

NOTE

Channel 1 is set as the programmed first channel, unless the unit was previously programmed for another channel then that channel is displayed.

3. Program the desired channel.
 - A. Select the first channel.
 - a. Press the desired channel number from the DATA group buttons 0-9.
 - b. Press the FIRST button to program the present channel as the first channel.

NOTE

Selecting a channel that does not exist in the present set up causes the Model 705 to display the following message.

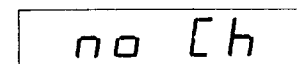

- B. Select the last channel:
 - a. Press the desired number from the DATA group buttons 0-9.
 - b. Press the LAST button to program the present channel as the last channel.
4. Program the desired number of poles (1-, 2- or 4-pole).
 - A. Press PRGM.
 - B. Press 6 (refer to paragraph 2.6.7).
 - C. Select number of poles 1-, 2- or 4-pole.
 - D. Press ENTER.
5. Program the interval time
 - A. Press the INTERVAL button to select the interval mode for display.
 - B. Enter the interval time on the display by pressing from the DATA group, desired time 000.010 to 999.999 seconds.
 - C. Press the ENTER button.
6. Program the desired scan mode. Press the SINGLE or CONTINUOUS button to select one of these two scanning modes. To select the step scan mode press the channel button and the START/STOP button.
7. Press the START/STOP button to start the scanning sequence. For the step scan mode press the START/STOP button each time a single channel is to be scanned.

Steps 1 through 7 show how to get the Model 705 into a scanning sequence. The next examples show how to use the different scan modes, how to daisy chain several Model 705's for an extended number of channels, and scanning using different scanner cards.

Example 1 Manual Scan—The Model 705 can be programmed for the step scan mode, if it is desired to scan through the programmed channels manually. In the step scan mode the programmed channels can be scanned (closed for the programmed interval rate and then opened) one channel at a time. Upon the actuation of the START/STOP button a single channel will be scanned. For this example, choose the following parameters:

1. First channel is 1.
2. Last channel is 10.
3. Interval time is two seconds.
4. Number of poles is two.
5. Use the step scan mode.

Use the following procedure to program the Model 705 for the preceding parameters:

1. Install the desired scanner card into the Model 705. Refer to paragraph 2.2.2.
2. Select the appropriate line voltage and turn the Model 705 on. Refer to paragraphs 2.2.1 and 2.3 respectively.
3. Press PRGM, 6, 2, ENTER. For more complete information refer to paragraph 2.6.7.
4. Press 0, 1, FIRST. (Programs channel 1 as the first channel.)
5. Press 1, 0, LAST. (Programs channel 10 as the last channel.)
6. Press INTERVAL, 0, 0, 2, 0, 0, 0, ENTER. (Programs the interval time for two seconds.)
7. Press CHANNEL, RESET. (Selects the channel mode for display and resets to the first channel.)
8. Press the START/STOP button to initiate the step scan mode.

Upon the actuation of the START/STOP button in step 8, channel 1 is closed and the START/STOP LED is turned on. Channel 1 remains closed for two seconds (programmed interval rate) and then opens. The START/STOP LED turns off and the Model 705 advances to the next channel. To scan the remaining channels press START/STOP button each time a channel is to be scanned. When the last programmed channel is scanned, in this example, it goes through the same procedure as previously stated. The difference is that after the channel opens up and turns off the START/STOP LED, the Model 705 resets to the first programmed channel.

To stop the scanning sequence and reset the Model 705 to the programmed first channel simply press the RESET button.

Example 2 Single Scan—In the Single Scan mode all the channels are scanned one time. The Scan runs as follows: the first channel is closed for the programmed interval rate and then opened. The Model 705 advances to the next channel, closes it for the programmed interval rate and then opens the channel. The sequence is repeated up to and including the pro-

grammed last channel, at this point the Model 705 reverts to the programmed first channel and stops. Upon the actuation of the START/STOP button all the programmed channels are scanned at the programmed interval rate. For this example let us choose the following parameters:

1. First channel is 3.
2. Last channel is 15.
3. Interval time is 0.5 seconds.
4. Number of poles is 2.
5. Use the single scan mode.

Use the following procedure to program the Model 705 for the preceding parameters:

1. Install the desired scanner card into the Model 705. Refer to paragraph 2.2.2
2. Select appropriate line voltage and turn the Model 705 on. Refer to paragraphs 2.2.1 and 2.3 respectively.
3. Press PRGM, 6, 2, ENTER. For more complete details refer to paragraph 2.6.7.
4. Press 0, 3, FIRST. (Programs channel 3 as the first channel.)
5. Press 1, 5, LAST. (Programs channel 15 as the last channel.)
6. Press INTERVAL, 0, 0, 0, 5, 0, 0, ENTER (Programs the interval time for 0.5 seconds.)
7. Press CHANNEL, RESET. (Turns on the CHANNEL LED, selects the channel mode for display and resets to the programmed first channel.)
8. Press SINGLE. (Selects the single scan mode and turns on the SINGLE LED.)
9. Press the START/STOP button to initiate the single scan mode.

Upon the actuation of the START/STOP button in step 9, channel 3 is closed for 0.5 seconds (programmed interval rate and the START/STOP LED turns on). Channel 3 is opened and the Model 705 advances to the next channel. Channel 4 is closed for 0.5 seconds and then opens. The Model 705 then advances to channel 5 and the cycle repeats itself until the last channel is scanned (closed for the programmed interval rate and then opened). At the end of the scan of the last channel, the Model 705 resets to the programmed first channel and turns off the START/STOP LED. At this point the single mode has been completed.

Pressing the START/STOP button during a single scan stops the scan at the presently displayed channel. The channel remains closed and turns off the START/STOP LED. To start the scanning sequence from the presently displayed channel press the START/STOP button.

To stop the scanning sequence and reset the Model 705 to the programmed first channel simply press the RESET button.

Example 3 Continuous Scan—In the Continuous scan mode all the programmed channels are scanned continuously. The scan runs as follows: the first channel is closed for the programmed interval rate and then opened. The Model 705 then advances to the next channel, closes it for the programmed interval rate and then opens the channel. The sequence is

repeated until the START/STOP button is pressed. Upon actuation of the START/STOP button all the programmed channels are scanned continuously at the programmed interval rate.

For this example choose the following parameters:

1. First channel is 5.
2. Last channel is 20.
3. Interval time is one second.
4. Number of poles is 2.
5. Use continuous scan mode.

Use the following procedure to program the Model 705 for the preceding parameters:

1. Install the desired scanner card into the Model 705. Refer to paragraph 2.2.2.
2. Select appropriate line voltage and turn the Model 705 on. Refer to paragraphs 2.2.1 and 2.3 respectively.
3. Press PRGM, 6, 2, ENTER. For more complete details refer to paragraph 2.6.7.
4. Press 0, 5, FIRST. (Programs channel 5 as the first channel.)
5. Press 2, 0, LAST. (Programs channel 20 as the last channel.)
6. Press INTERVAL, 0, 0, 1, 0, 0, 0, ENTER. (Programs the interval time for one second.)
7. Press CHANNEL, RESET. (Turns on the channel LED, selects the channel mode for display and resets to the programmed first channel.)
8. Press CONTINUOUS. (Selects the continuous scan mode and turns on the continuous LED.)
9. Press the START/STOP button to initiate the continuous scan mode.

Upon the actuation of the START/STOP button in step 9, channel 5 is closed for one second (programmed interval rate) and the START/STOP LED turns on. Channel 5 is then opened and the Model 705 advances to the next channel. Channel 6 closes for one second and then opens. The Model 705 advances to the next channel and the cycle repeats itself until the last channel is scanned (closed for the programmed interval rate and then opened). At the end of the scan of the last channel, the Model 705 resets to the programmed first channel and then repeats the scanning sequence.

The scanning sequence can be stopped at any programmed channel by simply pressing the START/STOP button. Pressing the START/STOP button during a continuous scan stops the scan at the presently displayed channel, the channel remains closed, and turns off the START/STOP LED. To start the scanning sequence from the presently displayed channel press the START/STOP button. After the scanning sequence has stopped, pressing the START/STOP button starts the sequence from the presently displayed channel and turns on the START/STOP LED.

To stop the scanning sequence and reset the Model 705 to the programmed first channel simply press the RESET button.

Example 4 Daisy Chaining—The Model 705 can be connected to other Model 705's to increase the number of available

channels. A total of five Model 705's can be daisy chained together to increase the number of channels up to a maximum of 100. Each Model 705 has the capability to support the plug-in scanner cards. By daisy chaining the Model 705's together, there is one instrument designated as the master while the rest of the Model 705's are designated as slaves. The Model 705's are designated either master or slaves by front panel Programs 91 and 92 respectively. For complete details concerning front panel programs refer to paragraph 2.6.

In this example the Model 705 will be programmed to scan 60 separate channels. Two additional Model 705 scanner mainframes are needed to implement this example. The three Model 705's must be daisy chained together in order to have the capability of the 60 2-pole channels. To daisy chain the Model 705's, refer to the circuit shown in Figure 2-3.

Each Model 705 will require two scanner cards in order to get the channels needed for this example. To simplify, use six Model 7056 general purpose scanner cards and select the following parameters:

1. First channel is 1.
2. Last channel is 60.
3. Interval time is two seconds.
4. Number of poles is 2.
5. Use continuous scan mode.

Use the following procedure to program the Model 705 for the preceding parameters:

1. Set up the circuit in Figure 2-3.
2. Install the plug-in scanner cards, two to each Model 705. Refer to paragraph 2.2.2 for installation instructions.

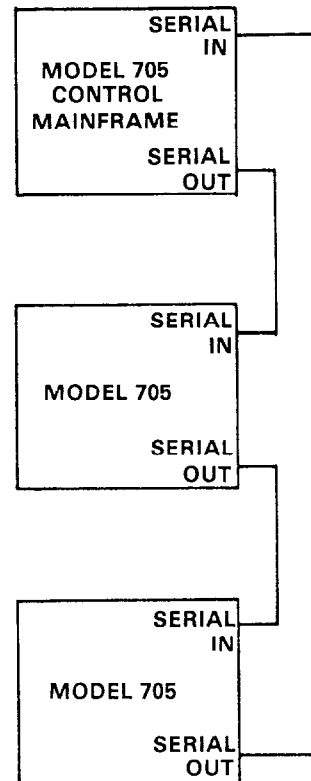

Figure 2-3. Daisy Chaining Three Model 705's

3. Select appropriate line voltage and turn the Model 705's on. Refer to paragraphs 2.2.1 and 2.3 respectively.
4. Press PRGM, 6, 2, ENTER. For complete details refer to paragraph 2.6.7.
5. Program one Model 705 as the master by initiating front panel Program 91. For complete details concerning the front panel programs refer to paragraph 2.6.
6. Program remaining Model 705's as slaves by initiating front panel Program, 92 for each of the remaining Model 705's. To do this press PRGM button and then press 9, 2.

All remaining Model 705's will have to be programmed in the same way. For complete details concerning the front panel programs refer to paragraph 2.6.

NOTE

Initiating front panel Program 92 locks up the Model 705 front panel except for program 90 and 91 which allow you to go to stand alone or master. The following message is displayed while the front panel is locked up.

SLAUE

7. Press 0, 1, FIRST. (Programs channel 1 as the first channel.)
8. Press 6, 0, LAST. (Programs channel 60 as the last channel.)

NOTE

If the Model 705's are not daisy chained together, pressing 6, 0 in step 8 causes the Model 705 to display the following message for approximately 0.5 seconds.

no [h

The display message indicates that there is no channel 60.

9. Press INTERVAL, 0, 0, 2, 0, 0, 0, ENTER. (Programs the interval time for two seconds.)
10. Press CHANNEL, RESET. (Turns on the channel LED, selects the channel mode for display and resets the Model 705 to the programmed first channel.)
11. Press CONTINUOUS. (Selects the continuous scan mode and turns on the continuous LED.)
12. Press the START/STOP button to initiate the continuous scan mode.

Upon the actuation of the START/STOP button in step 12, the continuous scan sequence starts from the programmed first channel. The continuous scan mode operates in the same way as in Example 3. That is, the first channel is closed for the programmed interval time and the START/STOP LED is turned on; then the channel is opened, and the Model 705 advances to the next channel. This sequence is repeated up to the last channel and then instead of advancing to the next channel the Model 705 resets to the programmed first channel and the entire sequence is repeated.

The scanning sequence can be stopped at any programmed channel by simply pressing the START/STOP button. Pressing the START/STOP button during a continuous scan stops the scan at the presently displayed channel, the channel remains closed, and turns off the START/STOP LED. To start the scanning sequence from the presently displayed channel, press the START/STOP button. The START/STOP LED turns on when resuming the scan.

To stop the scanning sequence, and reset the Model 705 to the programmed first channel, simply press the RESET button.

Example 5 Temperature Scan—With the Model 7057 thermocouple plug in card, the Model 705 can scan separate temperature points. The Model 7057 thermocouple scanner card is field installable in the Model 705 Scanner mainframe. Since the Model 7057 combines the functions of a thermocouple scanner and uniform temperature reference it is especially useful for scanning thermocouples. The input terminals are #10 alloy-copper set in an isothermal block to minimize temperature differences. A thermistor sensor within the isothermal block is used with a bridge network located on the Model 7057 to give an indication of the temperature reference or cold junction. The temperature of the heat sink is used to calculate the corrected thermocouple output. The output voltages of each thermocouple must be converted to temperature (°C or °F) using appropriate thermocouple tables or polynomial equations. Input and output connections are made through the rear panel of the Model 705 Scanner mainframe using #4 screw terminals on the Model 7057. For complete details concerning the Model 7057 thermocouple scanner card refer to the Model 7057 Instruction Manual.

In this example, the Model 705 will be programmed to scan five separate temperatures. Also, the following parameters will be programmed into the Model 705.

1. First channel is 1.
2. Last channel is 6.
3. Number of poles is 2.
4. Interval time is three seconds.
5. Use the continuous scan mode.

Use the following procedure to program the Model 705 for this example:

1. If Example 4 is still set up, disconnect it. Connect the five temperature sources to the Model 7057 via the #4 screw terminals at the rear of the card.
2. Install the Model 7057 into the Model 705 Scanner mainframe. Refer to paragraph 2.2.2 for scanner card installation instructions.
3. Select appropriate line voltage and turn on the Model 705. Refer to paragraphs 2.2.1 and 2.3 respectively.
4. Press PRGM, 6, 2, ENTER. For complete details concerning front panel programs refer to paragraph 2.6.
5. Press 0, 1, FIRST. (Programs channel 1 as the first channel.) Channel 1 is used to monitor the temperature of the input terminals with the thermistor bridge.
6. Press 0, 6, LAST, (Programs channel 6 as the last channel.)

7. Press INTERVAL, 0, 0, 3, 0, 0, 0, ENTER. (Programs the interval time for three seconds.)
8. Press CHANNEL, RESET. (Turns on the CHANNEL LED, selects the channel mode for display and resets the Model 705 to the programmed first channel.)
9. Press CONTINUOUS. (Selects the continuous scan mode and turns on the CONTINUOUS LED.)
10. Press START/STOP. (Initiates the continuous scan mode and turns on the START/STOP LED.)

As in the previous examples, the scanning sequence can be stopped at any programmed channel by pressing the START/STOP button. Pressing the START/STOP button during a continuous scan stops the scan at the presently displayed channel, the channel remains closed, and turns off the START/STOP LED. To resume the scanning sequence from the presently displayed channel, press the START/STOP button. The START/STOP LED turns on when resuming the scan.

To stop the scanning sequence and reset the Model 705 to the programmed first channel, simply press the RESET button.

NOTE

The output voltages of each thermocouple on the Model 7057 must be converted to temperature ($^{\circ}\text{C}$ or $^{\circ}\text{F}$) using the appropriate thermocouple tables or polynomial equations. Consult the Model 7057 Instruction Manual for more information concerning the thermocouple tables and/or polynomial equations.

Example 6 Low Current Scan—With the Model 7058 installed, the Model 705 is capable of scanning currents in the range of picoamps. The Model 7058 is a low current scanner plug-in card which is field installable in the Model 705 Scanner mainframe. The card is capable of switching up to 10 channels. The Model 7058 is designed to introduce a minimum of offset current ($< 1\text{pA}$), while guarding ensures that high isolation ($10^{15}\Omega$) is maintained between input signals. Triaxial input and output connections to the scanner are located at the rear of the card.

The actual measurement of the low current should be done with a high quality electrometer such as the Keithley Model 614 or Model 619. A good quality picoammeter could also be used such as the Keithley Model 480. All three of these instruments are capable of measuring in the range of picoamps with high accuracy. To measure such low currents a number of measurement parameters must be taken into consideration (input impedance, measurement configuration etc.). While this example does not attempt to give instructions on measuring low current, the instruction manual provided with each of previously mentioned electrometer and picoammeter gives step by step instructions on how to measure low currents accurately.

For detailed information concerning the Model 7058, refer to the Model 7058 Instruction Manual, document number 7058-901-01A. In this example, the Model 705 will be pro-

grammed to scan five separate low current sources. Also, the following parameters will be programmed into the Model 705.

1. First channel is 1.
2. Last channel is 5.
3. Interval time is 2 seconds.
4. Use the single scan mode.

Use the following procedure to program the Model 705 for this example:

1. Assume that there are the five low current sources to be scanned. Connect the five low current sources to the Model 7058 via the triax connectors.
2. Install the Model 7058 into the Model 705 Scanner mainframe. Refer to paragraph 2.2.2 for scanner card installation instructions.
3. Select appropriate line voltage and turn on the Model 705. Refer to paragraphs 2.2.1 and 2.3 respectively.
4. Press 0, 1, FIRST. (Programs channel 1 as the first channel.)
5. Press 0, 5, LAST. (Programs channel 5 as the last channel.)
6. Press INTERVAL, 0, 0, 2, 0, 0, 0, ENTER. (Programs the interval time for two seconds.)
7. Press CHANNEL, RESET. (Turns on the channel LED, selects the channel mode for display and resets the Model 705 to the programmed first channel.)
8. Press SINGLE. (Selects the single scan mode and turns on the SINGLE LED.)
9. Press START/STOP. (Initiates the single scan mode and turns on the START/STOP LED.)

Upon actuation of step 9 the Model 705 scans through the programmed channels at the programmed interval rate one time. As in the previous examples the scanning sequence can be stopped at any programmed channel by simply pressing the START/STOP button. Pressing the START/STOP button during a scan stops the sequence at the presently displayed channel, the channel remains closed, and turns off the CHANNEL LED. To resume the scanning sequence from the presently displayed channel, press the START/STOP button. The START/STOP LED turns on when resuming the scan.

To stop the scanning sequence reset the Model 705 to the programmed first channel, simply press the RESET button.

The interval time programmed into the Model 705 for this example was chosen at random. The interval time can easily be programmed for a much longer or much shorter time. Generally, the interval time should be sufficient to allow the measurement to settle. The parameters that dictate how long the measurement needs to settle include source resistance, input impedance, measurement configuration etc. Consult the low current measuring devices' instruction manual for details concerning these measurement parameters.

Example 7 Low Voltage Scan—With the Model 7059 installed, the Model 705 is capable of scanning voltage in the sub-millivolt region. The Model 7059 is low voltage plug-in scanner

card which is field installable in the Model 705 Scanner main-frame. The card is capable of switching up to 10 channels. For low level transducer and thermocouple output switching, the Model 7059 is designed to introduce a minimum of thermal voltage error ($< 1\mu\text{V}$ input to output with copper leads) and ensure that high isolation ($10^{12}\Omega$) is maintained between input signals. Quick disconnect screw terminals are used to facilitate input and output connections to the scanner plug-in card.

The actual measurement of the low voltage should be done with a high quality microvoltmeter such as the Keithley Model 177 or the Model 181 digital nanovoltmeter. These instruments are capable of measuring in the range of microvolts with high accuracy. To measure such low voltage a number of measurement parameters must be taken into consideration. The measurement parameters include source resistance, thermal emf's ground loops etc. While this example does not attempt to educate the user in low voltage measurements, the instruction manual provided with each of the previously mentioned instruments gives step by step instructions on how to measure low voltage accurately.

For detailed information concerning the Model 7059, refer to the Model 7059 Instruction Manual, document number 7059-901-01A. In this example, it will be assumed that the user needs to scan five separate voltage sources. Also, the following parameters will be programmed into the Model 705.

1. First channel is 1.
2. Last channel is 5.
3. Interval time is one second.
4. Use the single scan mode.

Use the following procedure to program the Model 705 for this example:

1. Assume that there are five low voltage sources to be scanned. Connect the five low voltage sources to the Model 7059 via the quick disconnect screw terminals located on the card.
2. Install the Model 7059 into the Model 705 Scanner main-frame. Refer to paragraph 2.2.2 for scanner card installation instructions.
3. Select the appropriate line voltage and turn on the Model 705. Refer to paragraphs 2.2.1 and 2.3 respectively.
4. Press 0, 1, FIRST. (Programs channel 1 as the first channel.)
5. Press 0, 5, LAST. (Programs channel 5 as the last channel.)
6. Press INTERVAL, 0,0, 1, 0, 0, 0, ENTER. (Programs the interval time for one second.)
7. Press CHANNEL, RESET. (Turns on the CHANNEL LED, selects the channel mode for display and resets the Model 705 to the programmed first channel.)
8. Press SINGLE. (Selects the single scan mode and turns on the SINGLE LED.)
9. Press START/STOP. (Initiates the single scan mode and turns on the START/STOP LED.)

Upon actuation of step 9 the Model 705 scans through the programmed channel at the programmed interval rate one time. As in the previous examples, the scanning sequence can be stopped at any programmed channel by simply pressing the

START/STOP button. Pressing the START/STOP button during a scan stops the sequence at the presently displayed channel, the channel remains closed, and turns off the CHANNEL LED. To resume the scanning sequence from the presently displayed channel, press the START/STOP button. The START/STOP LED turns on when resuming the scan.

To stop the scanning sequence and reset the Model 705 to the programmed first channel, simply press the RESET button.

The parameters that were programmed into the Model 705 for this example were chosen at random. The parameters can be easily changed to suit the particular measurement and/or scanning configuration at hand by reprogramming the Model 705.

OPERATING THE CLOCK

The CLOCK group on the Front Panel contains the TIME and DATE buttons. The clock continues to run after the Model 705 is powered down. This is because the clock's power circuitry is backed up by battery BT101. The time is displayed in a 24 hour display, refer to paragraph 2.5.2 step 6 for time display format. The date is displayed in one of two formats (See paragraph 2.5.2 step 6). To display the time mode simply press the TIME button. To set the time, use the following procedure:

1. Press TIME (selects the time mode for display and turns on the time LED).
2. Press the DATA buttons (0-9) that correspond to the desired time: For example, to set the time of 7:30 A.M. press 0, 7, 3, 0, 0, 0, ENTER.

Upon the actuation of the ENTER button, the time is set to 7:30 AM. As another example, set the time to 7:30 PM by pressing 1, 9, 3, 0, 0, 0, ENTER.

To display the DATE mode, simply press the DATE button. The date, as mentioned before, is displayed in one of two formats. The formats are the American date format and the International date format. These formats are depicted in paragraph 2.5.2 step 6. The formats are selected exclusively by front panel program 1. Refer to paragraph 2.6 for complete details on the front panel programs.

1. Press DATE. (Selects the date mode for display and turns on the DATE LED.)
2. Press the DATA buttons (0-9) that correspond to the desired date. For example, set the date to August 18th for the American date format by pressing:
 - A. PRGM, 1. (Selects front panel Program 1 for display.)
 - B. 0, ENTER. (Selects the American date format.)
 - C. 0, 8, 1, 8, ENTER. (Enters 08.18 for the date August 18.)

Another example, set the date to August 18th for the International date format by pressing:

1. PRGM, 1. (Selects front panel Program 1 for display.)
2. 1, ENTER. (Selects the International date format.)
3. 1, 8, 0, 8, ENTER. (Enters 18.08 for the date August 18.)

2.6 FRONT PANEL PROGRAMS

This section contains instructions necessary for operating the 13 internal programs of the Model 705. The programs are activated by pressing the PRGM button along with the button representing the appropriate program number. The programs do a number of various tasks which are summarized in Table 2-3.

Program Notes

1. Each program is entered by pressing the PRGM button followed by the desired program number.
2. Pressing the PRGM button selects the program mode and displays the following:

Pr o ?

As you have noticed, the question mark is flashing. This is prompting the operator to enter the desired program number (refer to Table 2-3). After entering the program number the Model 705 goes into the program and then prompts the operator to enter numerical data. Numerical data varies with each program.

3. New programs may be entered without clearing a program that is presently running. To do so, press the PRGM button followed by the desired program number.
4. Data is entered into the digit whose "c" segment is flashing by pressing the desired number button. The "c" segment of a display digit is shown below:

8 ← "c" segment

As each digit is entered, the blinking segment moves one place to the right until all the necessary digits have been entered.

5. Only as many significant digits as necessary need to be entered. The Model 705 will complete the constants with trailing zeroes where necessary.
6. Invalid keys will be ignored. If an invalid key is pressed the blinking "c" segment remains at the current digit.
7. If an incorrect digit is entered, the complete constant must be re-entered. The new value may be entered by cycling the display around to the beginning by repeatedly pressing one of the number buttons.

Table 2-3. Summary of Front Panel Programs

Program	Operation
0	Digital I/O (Input/Output)
1	American/International Date Format
2	Settling Time
3	Set Primary Address
4	Save Present Relay Set Up
5	Recall Stored Relay Set Up
6	Pole Configuration (1, 2 or 4)
7	Set Alarm
8	Self Test
90	Stand Alone Instrument
91	Master
92	Slave
99	Reset

8. If too many digits are entered, the display begins again at the first digit on the left. All the digits in the constant must then be entered again. This applies only to Programs 0, 2, 3, 6 and 7.
9. Once all the digits of the desired constants are shown on the display, the constant is entered into the program by pressing the ENTER button. This applies only to Programs 0, 1, 2, 3, 4, 5, 6 and 7.

2.6.1 Program 0 Digital I/O

Program 0 allows the user to control the outputs on the digital I/O port. The I/O port is located on the rear panel of the Model 705. The output code is displayed in base eight (octal) on the front panel. The actual I/O port output data is in 8 bit form. The range of octal data that can be entered on the front panel is 0 to 377. The maximum octal data is 377 which corresponds to 11111111 in BCD. If the front panel data is entered as 377 then the digital I/O output data is 11111111. To initiate Program 0 use the following procedure:

1. Press PRGM and the following is displayed:

Pr o ?

2. Press 0 and the following is displayed for approximately 0.5 seconds:

Out In

After the out in message is displayed, the Model 705 displays the following:

000000

Where the first three digits represent the digital output (in octal) and the last three digits represent the digital inputs (in octal).

NOTE

The digital I/O inputs are defined by the connections on the input pins. With no connections on the input pins the inputs are undefined. The digital I/O outputs are programmed by using Program 0.

3. Press 0, 7, 7, ENTER. (Programs the output bits on the digital I/O port for 00111111.)

2.6.2 Program 1 Date Format

Program 1 is used to select one of two date formats. The two formats are the American date format and the International date format. They are displayed as follows:

American—mm.dd where mm = month dd = day
International—dd.mm

To enable Program 1 and select the international date format use the following procedure:

1. Press PRGM. (Selects program mode and displays Pro ?).

NOTE

The flashing question mark on the display prompts the user for the decimal program number.

2. Press 1. (Selects program number 1 and displays the following.)

AOE 1 0

AOEI—American or International

0—Indicates which format. 0= American 1= International

3. Press 1. (Selects the International date format.)
4. Press ENTER. (Displays the date in the International date format and turns on the DATE LED.)

To enable program 1 and select the American date format use the following procedure:

1. Press PRGM. (Selects program mode, displays Pro ? and turns off the DATE LED.)
2. Press 1. (Selects Program 1 and displays the following.)

AOE 1 1

1—Selected from previous procedure.

3. Press 0. (Selects American date format.)
4. Press ENTER. (Displays the date in the American date format and turns on the DATE LED.)

NOTE

The date format is battery backed up. Shutting off the power to the unit does not affect the format. It will remain as programmed until it is reprogrammed.

The date, as well as the time, keeps on running even when power to the instrument is shut off. The reason for this is that the clock's power circuitry is backed up by battery BT101.

Setting or changing the date is as simple as selecting the date formats. For example, use the following procedure to set the date in American date format for November 24.

1. Press PRGM. (Selects program mode and displays Pro ?.)
2. Press 1. (Selects program 1, turns off the DATE LED and displays the following:

AOE 1 0

3. Press ENTER. (The American date format was selected in the previous procedure. Pressing ENTER displays the date in the American date format and turns on the DATE LED.)
4. Press 1, 1, 2, 4, ENTER. (Programs the date for November 24 and displays the following.)

11.24

11 = month 24 = day

2.6.3 Program 2 Settle Time

Program 2 is used to program the amount of time (up to 999.99sec) the relays and all the measurement equipment con-

nected to a particular channel has to settle out. At the end of the programmed settle time the Model 705 outputs a negative going, TTL level not less than 2μsec pulse at the CHANNEL READY output. The CHANNEL READY output is a BNC connector located on the rear panel of the Model 705. The purpose of the settle time program is to have a selectable settle time for all instruments connected to a particular channel. Then, the pulse that appears at the CHANNEL READY output can be used to inform another instrument (e.g. DMM, printer etc,) that the settle time is complete. To initiate program 2 use the following procedure.

1. Press PRGM. (Selects the program mode and displays.) Pro ?.
2. Press 2. (Selects Program 2 and displays the following for approximately 0.5 sec.)

SETTLE

After the settle message is displayed, the Model 705 displays:

000005

This display is shown in seconds. The minimum settle time is 5msec and the maximum settle time is 999.999sec.

Setting the settle time is a simple procedure. For example, use the following procedure to set the settle time to 001.010sec.

1. Press PRGM. (Selects program mode and displays.)

Pro ?

2. Press 2. (Selects Program 2 and displays the settle message described in step 2 of the previous procedure. Then the minimum settle time is displayed.)
3. Press 0, 0, 1, 0, 1, 0, ENTER. (Loads 1.01sec as the settle time on the display. Pressing ENTER programs 1.01sec as the settle time and the Model 705 reverts to the channel mode at the previously displayed channel.)

NOTE

Initiating a new interval time resets the settle time counter. If the settling time is greater than the interval time the output pulse does not appear until the end of the scan.

2.6.4 Program 3 Primary Address

Program 3 is used to program the primary address of the Model 705 for IEEE-488 bus operation. The primary address of the Model 705 is factory set at 17, but it may be set to any value between 0 and 31 via front panel Program 3. The primary address specified in the controller's programming language must agree with the primary address of the Model 705. Front panel Program 3 is the only way to change the Model 705's primary address.

NOTE

If other instrumentation is connected to the bus, be sure that each device has a different primary address. If this precaution is not observed, erratic operation may result.

To initiate Program 3, and change the primary address to 22 use the following procedure:

1. Press PRGM. (Selects the program mode and displays.)

Pr o P

2. Press 3. (Selects Program 3 and displays the following:)

IE 17

IE = IEEE Indicator 17 = Primary Address

3. Press 2, 2, ENTER. (Loads 22 onto the display. Pressing ENTER programs the primary address to 22 and reverts the Model 705 to the channel mode at the previously displayed channel).
4. Press PRGM, 3. (Shows the user that the primary address has indeed changed to 22.)

2.6.5 Program 4 Save Present Relay Set Up

Program 4 is used to save (store) the present relay set up for future use. This program is capable of storing five separate relay set ups. This means, the user can program five different relay set ups, save the set ups, then use the stored set ups when the need arises without reprogramming. Program 4 is very helpful in a situation where the instrument is going to be shut down for a period of time and the user does not want to reprogram the relay set up the power is returned to the unit. The program is also helpful when the user has programmed one relay set up and needs to go to another completely different set up without clearing the existing one. In this case, it's possible to program one relay set up and store it with Program 4, then program a different set up, store it with program 4. This way has both relay set ups are stored for future use.

NOTE

The Model 705 can only use one relay set up at a time, they cannot be used simultaneously.

An example of using Program 4, program the Model 705 for five channels with the odd numbered channels closed and the even numbered channels open. When the set up is complete, save the set up by using Program 4. Use the following procedure to implement this example:

1. Press RESET. (Selects channel mode and resets to the programmed first channel.)
2. Press 0, 1, FIRST. (Selects channel one as the first channel.)
3. Press 0, 5, LAST. (Selects channel five as the last channel.)
4. Press RESET. (Resets to the programmed first channel.)
5. Press CLOSE. (Closes presently displayed channel.)
6. Press CHANNEL, CHANNEL, CLOSE. (Advances the Model 705 to channel 3 and closes it.)

7. Press CHANNEL, CHANNEL, CLOSE. (Advances the Model 705 to channel 5 and closes it.)
8. Press PRGM, 4. (Selects program mode, selects Program 4 and displays the following.

SAUE 1

9. Press 1, ENTER. (Selects relay set up 1 to be stored and when ENTER is pressed the set up is stored.)

Upon the actuation of step 9, the relay set up that was programmed in steps 1 through 8 is now stored in nonvolatile RAM (NVRAM). The Model 705 then reverts to the previously displayed channel which is in this case channel 5. To verify that the relay set up has been stored use the following procedure.

1. Press RESET. (Resets to the programmed first channel and opens all relays.)
2. Press PRGM, 5, 1. (Selects Program 5, which recalls the stored relay set up. Refer to paragraph 2.6.6.)
3. Press CHANNEL four times and notice that the odd numbered channel are all closed and the even numbered channels are all open. This shows that the relay set up was indeed stored using program 4.

For another test of the relay set up, shut off power to the Model 705 for a few minutes. Turn the Model 705 back on and press PRGM, 5. Notice the programmed first channel is closed and all the odd channels are closed. All the even channels should be open. Thus, power to the instrument was shut off, and the relay set up remained stored.

To store an additional relay set up, program the set up and press PRGM, 4, 2. This action saves the relay set up without disturbing the previously stored set up. This can be done with up to five separate set ups. To clear a stored relay set up press RESET, PRGM, 4. This stores the reset condition for the relay set up.

NOTE

Program 4 does not save just the relay set up between the programmed first and last channels. The program saves the entire relay set up of the Model 705.

2.6.6 Program 5 Recall Stored Relay Set Up

Program 5 is used to recall a previously stored relay set up. Program 4 and 5 work in conjunction with each other. Program 4 is used to store a relay set up, while Program 5 is used to recall the relay set up that was stored using Program 4. Program 5 also recalls the programmed first and last channels along with the relay set up that was stored in the example of Program 4.

In the example of Program 4, five channels were selected with the odd channels closed and the even channels open. The channels were stored and then the Model 705 was reverted to the reset condition. This is where we will start the example of Program 5. To recall the stored relay set up, use the following procedure:

1. Press RESET. (Reverts instrument to programmed first channel and opens all the channels.)
2. Press PRGM, 5. (Selects program mode and Program 5. After the five button is pressed the Model 705 displays the following.)

r E C L L 1

3. Press 1, ENTER (Selects relay set up 1 to be recalled and when ENTER is pressed the set up is recalled.)

This display indicates that the recall program has been activated. The display prompts the user for the specific relay set up that was stored (set up 1, 2, 3, 4 or 5). In this case the procedure recalled relay set up 1. After the 1 button is pressed, the Model 705 recalls relay set up 1 and displays the channel that was shown previous to pressing PRGM. In this case, the following is displayed because step 1 reset the display to the programmed first channel:

0 1 F C

In order to verify that the stores set up was recalled proceed to step 3.

4. Press CHANNEL, CHANNEL, CHANNEL, CHANNEL. (While going through each channel notice that the odd channels (1, 3 and 5) are closed and the even channels (2 and 4) are open. This shows that the stored relay set up was indeed recalled by program 5).

2.6.7 Program 6 Pole Modes

In general, Keithley switching cards for the Model 705 are configured as 10-channel, 20-channel, or matrix cards. The Model 705 uses pole modes to address the various channel configurations, as listed below:

Pole Mode	Card Configuration
0	Matrix
1	20-channel
2	10-channel
4	4-pole switching with two 10-channel cards

The pole mode can be displayed and changed with front panel Program 6. Power-up does not affect pole mode; front panel Program 99 resets the pole mode to 2. Table 2-4 lists the recommended pole modes to address a system of like cards (up to 10 cards in a 5-unit master/slave setup).

Table 2-4. Switching Card Pole Modes

Switching Card	Channels	Recommended Pole Mode
7052, 7152, 7153	Note 1	0-pole (matrix)
7053	10	2 or 4-pole
7054	10	2-pole
7056, 7156	10, 20	1, 2 or 4-pole
7057A, 7402	Note 2	2-pole
7058, 7158	10	2-pole
7059	10	2 or 4-pole
7062, 7063	Note 3	0-pole (matrix) or 2-pole
7064, 7164	20	1-pole
7065	Note 1	0-pole (matrix)
7066, 7166	10	2 or 4-pole
7067	10	2-pole
7154	10	2 or 4-pole
7168	8	2-pole
7169	20	0-pole (matrix)

- Notes: 1. Four row by five column matrix.
 2. Nine channels plus temperature reference.
 3. Two switches per card of 1-pole, 5-throw.

To display and change the pole mode, use the following procedure:

1. Select Program 6 by pressing the PRGM key and then the number 6 key. The present pole mode is displayed.
2. Select the 4-pole mode by pressing the 4 key and then the ENTER key. The Model 705 then reverts to the channel mode, turns on the channel LED, and displays the programmed first channel.

To verify that the pole mode was changed and to return to the 2-pole mode, perform the following steps:

1. Select Program 6 by pressing PRGM and 6. The display shows that the pole mode was changed to 4.
2. Revert to the 2-pole mode by pressing 2 and ENTER.

Mixing Card Types

When intermixing Keithley switching cards in a Model 705 mainframe, complications arise from the need to address 10-channel, 20-channel, and matrix cards in the same mainframe or master/slave setup. In general, the rules for choosing different pole modes are:

- 0-pole (matrix) — If a matrix card is present.
- 1-pole — If a 20-channel card is present, but no matrix card.
- 2-pole — If a 10-channel card is present, but no 20-channel or matrix cards.
- 4-pole — If 4-pole switching is desired with two 2-pole, 10-channel cards.

CAUTION

When using 10-channel cards in the 1-pole mode, close one channel at a time. Otherwise, other channels are closed on the card and show up on the mainframe display. For example, when channels 2 and 5 are closed, channels 1 and 6 also close.

NOTE

When using 20-channel cards in the 0-pole (matrix) mode, two crosspoints must be closed for each of the card channels.

CAUTION

When a Model 705 mainframe contains a mix of cards (matrix, 10-channel, 20-channel), you can use more than one pole mode to address the cards. In other words, use the 0-pole mode for a matrix card, the 1-pole mode for a 20-channel card, and the 2-pole mode for a 10-channel card. In cases where a 0-pole mode card is used with a 10 or 20-channel card, you must place the Model 705 into the 0-pole mode before using the 1-pole or 2-pole mode. This action will properly initialize the 0-pole mode card. Then you can place the Model 705 into the 1-pole or 2-pole mode to address the other card. This operation is not necessary if the mainframe powers up in the 0-pole mode.

0-pole (Matrix) Mode

Using a matrix card with the Model 705 requires that the 0-pole (matrix) mode be selected. To place the mainframe in the 0-pole mode from the front panel, perform the following steps:

1. Select Program 6 by pressing the PRGM key and then the number 6 key.
2. Select the 0-pole (matrix) mode by pressing the 0 key and then the ENTER key.

With the Model 705 mainframe in the 0-pole mode, the display format is as follows:

mm n x

where: "mm n" is the crosspoint assignment number.

mm = 2-digit ID number from 01 to 50. This number identifies the mainframe and slot the card is located in, and also indicates the matrix card column number.

n = Matrix card row from 1 to 4.

x = Status of the crosspoint. An O indicates that the crosspoint is open, while a C indicates that the crosspoint is closed.

Controlling the matrix from the front panel consists of displaying the desired matrix crosspoint assignment number and closing (or opening) the crosspoint relay. The following table provides 2-digit ID numbers that make up the "mm" portion of the crosspoint assignment number:

Mainframe	Matrix Card Column					
	Slot	1	2	3	4	5
Master	1	01	02	03	04	05
	2	06	07	08	09	10
Slave #1	1	11	12	13	14	15
	2	16	17	18	19	20
Slave #2	1	21	22	23	24	25
	2	26	27	28	29	30
Slave #3	1	31	32	33	34	35
	2	36	37	38	39	40
Slave #4	1	41	42	43	44	45
	2	46	47	48	49	50

2.6.8 Program 7 Set Alarm Time

Program 7 is used to set the alarm time. The alarm time is the preprogrammed time that the Model 705 outputs a negative going, TTL level pulse with a duration of greater than 10µsec at the ALARM/SERIAL IN connector. The ALARM/SERIAL IN connector is located on the rear panel of the Model 705. This pulse can be used to inform another instrument to start a measurement sequence. The external instrument (e.g. controller "smart" DMM, printer etc.) can then start on its own function in the measurement system. The alarm time is displayed as a 24 hour clock format. The format is displayed as follows:

00.00.00

For an example of programming the alarm time, use the following procedure to program the alarm time for 2:45 pm.

1. Press PRGM, 7. (Selects 7 and displays the following message for approximately 0.5 seconds.)

ALAr n

- After the alarm message is displayed, the 24 hour clock format is displayed. If nothing was previously programmed for the alarm time, the alarm time is set to all zeroes. When the time is set to 00.00.00 no output pulse will appear on the ALARM/SERIAL IN connector on the rear panel.
2. Press 1, 4, 4, 5, 0, 0, ENTER. (Loads 14.45.00 onto the display and when the ENTER button is pressed, the alarm time is set to 2:45 pm. The Model 705 then reverts to the channel mode which turns on the CHANNEL LED and displays the previously displayed channel.)

NOTE

The alarm time is now set to 2:45 pm. The alarm will go off everyday at 2:45 pm outputting the negative going TTL level pulse to the ALARM/SERIAL IN connector.

To verify that the alarm time was set to 2:45 pm by the preceding example, press PRGM, 7 and the display shows that the alarm time was set to 2:45 pm.

NOTE

Upon power-up or upon activating front panel Program 99, the Model 705 sets the alarm time to 00.00.00. When the Alarm time is set for 00.00.00, no pulse appears.

2.6.9 Program 8 Self Test

Program 8 is used to run a test on the ROM, RAM circuitry and also to test the front panel LED's. This test is also performed upon power-up. If it is desired to run the test without powering the unit down then up, Program 8 can be used. Use the following procedure to activate Program 8.

1. Press PRGM (selects program mode).
2. Press 8 (selects program 8).

Once step 2 is completed the Model 705 performs the following sequence:

First the Model 705 turns on all the segments in the display as shown:

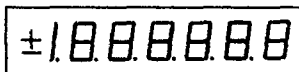

This is a display test. The operator can note inoperative display segments by comparing the Model 705 display with the figure above. In addition, the push button and the TALK, LISTEN, and REMOTE indicators turn on. All indicators are on simultaneously if operating correctly. While all the LEDs are on, the Model 705 is performing a cyclic redundancy check (CRC) of the ROM circuitry. A digital self test of the RAM circuitry is also performed at this time. If the digital self test reveals a problem with the RAM circuitry the Model 705 displays the following for approximately 0.5 seconds.

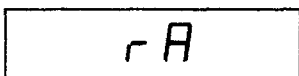

After this display the Model 705 displays the following:

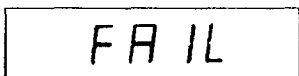

If the CRC reveals a problem with the ROM circuitry the Model 705 displays the following for approximately 0.5 seconds.

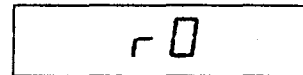

After this display the Model 705 displays the following:

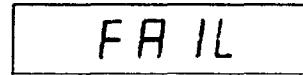

If the self test and the CRC both reveal a problem the Model 705 displays the RAM and ROM error messages and then displays the fail message.

When either test does not reveal a problem the Model 705 displays the following message which indicates both tests have passed:

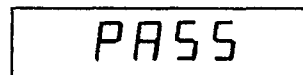

2.6.10 Program 90 Stand Alone

Program 90 is used to program a Model 705, out of the Master and Slave programs and into normal front panel operation.

1. Press PRGM. (Selects program mode.)
2. Press 9, 0. (After pressing the 0 button the Model 705 displays the following two messages and reverts to the channel mode. The channel LED turns on and the channel previously displayed before pressing PRGM is displayed.)

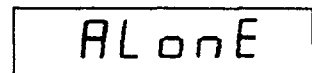
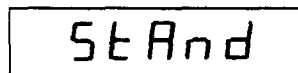

Program 90 takes the Model out of the Master condition and also out of the Slave condition. Program 90 also set the programmed first channel to 1 and the programmed last channel to 1.

NOTE

After actuating Program 90 cycle power to the instrument or activate Program 99 in order to set the instrument's ALARM/SERIAL IN connector to alarm output.

2.6.11 Program 91 Master

Program 91 sets the Model 705 as the master control of a daisy chain configuration. The designated master Model 705 is the only unit in the configuration that has front panel control. All the controls on the front panel control the master unit as well as the slave units of the configuration.

If the Model 705 is not connected in a daisy chain configuration or the other daisy chained Model 705s are not programmed as slaves, activating program 91 (Master) produces the following two messages.

(Control)

Control

(no loop)

noLoop

The Model 705 will remain in the no loop display condition until all other daisy chained Model 705s are connected and programmed as slaves or any front panel program other than 91 (Master) is activated.

To activate program 91 use the following procedures:

1. Connect the Model 705 to at least one other Model 705 in a daisy chain configuration (see Figure 2-3).
2. Install the appropriate scanner cards.
3. Turn the units on.
4. Select one Model 705 as the master of the configuration.
5. Press PRGM, 9, 1, of the selected master Model 705. The following message is displayed upon pressing 1.

Control

After the control display, the Model 705 reverts to the channel mode and displays the programmed first channel. At this point the Model 705 is programmed as the master control of the daisy chain configuration. To program the Model 705 for a relay configuration, refer to paragraph 2.5.3. The only difference is the extended number of channels provided by the daisy chain configuration. To program the Master 705 out of the Master condition activate program 90.

2.6.12 Program 92 Slave

Program 92 sets the Model 705 as a slave of a daisy chain configuration. The slave responds to the commands of the designated master in the configuration. The slave unit or units do not have any control in the set up, except power on/off, master and stand alone programs. The slave unit's primary function is to increase the number of channels in a configuration.

To activate program 92 use the following procedure.

1. Connect the Model 705 to at least one other Model 705 in a daisy chain configuration (see Figure 2-3).
2. Install the appropriate scanner cards.
3. Turn the units on.
4. Select a Model 705 as a slave.

NOTE

Select any Model 705 to be a slave in the daisy chain configuration except the Model 705 that is designated as the master.

5. Press PRGM, 9, 2 of the selected slave Model 705. The following message is displayed upon pressing 2.

SLAVE

The previous display message remains on the display as long as the unit is programmed as a slave unit. To get the Model 705 out of the slave program one of the following actions can be used.

1. Activate front panel program 90 (Stand Alone).
2. Activate front panel program 91 (Master).

2.6.13 Program 99 Reset

Program 99 resets the Model 705 to the conditions listed in Table 2-5. To activate program 99 use the following procedure:

1. Press PRGM.
2. Press 9, 9.

Upon pressing the 9 button a second time the Model 705 goes through a reset sequence that is described as follows:

1. After pressing the 9 button a second time the Model 705 displays the following message:

RESET

2. After the reset message, all the front panel LEDs turn on for approximately two seconds.

±1.000000

The push button and TALK, LISTEN, and REMOTE LED's also turn on at this time. During this time the Model 705 does a cyclic redundancy check (CRC) of the ROM circuitry and a digital self test of the RAM circuitry. Refer to program 8.

- After all the front panel LED's are turned on then off, the Model 705 displays the current software level for approximately 0.5 seconds. The following display is an example of software revision level A5.



- After the software revision level is displayed the Model 705 displays the primary address for approximately 0.5 seconds. The following display is an example of primary address 17.

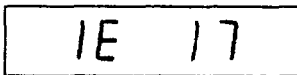

Once the preceding display is shown the Model 705 is in the program 99 reset condition as defined by Table 2-5.

Table 2-5. Program 99 Reset Conditions

Function or Program	Reset Condition
CHANNEL	All channels are open and the display is set to* 
TIME	Time is not affected by program 99.
DATE	Date is not affected by program 99.
RESET	Reset is not affected by program 99.
INTERVAL	Interval is set to 000.010.
SINGLE	Single scan mode is set to inactive.
CONTINUOUS	Continuous scan mode is set to inactive.
START/STOP	Start/Stop function is set to stop.
Program 0	Digital I/O outputs are set to 000, the inputs are not affected by program 99.
Program 1	Date is set to American format.
Program 2	Settle time is set to 000.005 seconds.
Program 3	Primary address is not affected by program 99.
Program 4	Save relay set up is cleared.
Program 5	Recall relay set up is cleared.
Program 6	Number of poles is set to 2.
Program 7	Alarm time is set to 00.00.00.
Program 8	Self test is not affected by program 99.
Program 90	Program 90 is performed.
Program 91	Program 91 is not performed.
Program 92	Program 92 is not performed.
Program 99	Used to reset the Model 705.
FIRST	Set to Channel 1.
Last	Set to highest available channel.

* When the Model 705 is in the slave mode (program 92), activating program 99 has no effect.

SECTION 3 IEEE BUS OPERATION

3.1 INTRODUCTION

This section contains information necessary to operate the Model 705 over the IEEE-488 bus. The Model 705 has a standard IEEE-488 interface that allows the user to give commands and read data via an external device. All front panel programs and functions are available to the bus (except Programs 3, 90, 91 and 92).

A typical bus set up for controlled operation is shown in Figure 3-1. Generally, a system will contain one controller and a number of other instruments to which the commands are given. Device operation is categorized into three operators: controller, talker and listener. The controller does what its name implies; it controls the instrument on the bus. The talker sends data while a listener receives data. Depending on the type of instrument, any particular device can be a talker only, a listener only or both a talker and a listener.

Any given system can have only one active controller, but any number of talkers or listeners may be presented up to the hardware limitations of the bus. Generally, the bus is limited to 15 devices, but this number may be reduced if higher than normal data transfer rates are required or if longer than normal cables are used.

Only one device on the bus may be a talker at any given time while several devices can be commanded to listen. Before a device can talk or listen it must be appropriately addressed. Devices are selected by their primary address. Usually, each device on the bus has its own primary address so that each device may be addressed individually. The primary address of the Model 705 is factory set at 17. The factory set primary address may be changed via front panel program number 3. Refer to paragraph 2.6 for more information about the front panel programs.

Once a device is addressed to talk or listen, the appropriate bus transactions take place. For example, if the Model 705 is addressed to talk, it places the data string on the bus one byte at a time. The controller reads the information and the appropriate software can then be used to direct the information to the desired location.

3.1.1 Software Considerations

The most sophisticated computer in the world would be useless without the necessary software. This basic requirement is also true of the IEEE-488 bus, which requires the use of handler routines as described in this section.

Before a controller can be used with the IEEE-488 interface, the user must make certain that appropriate handler software is present within the controller. With the HP-85 computer, for

example, the HP-85 interface card must be used with an additional I/O ROM, which contains the necessary handler software.

Other small computers that can be used as controllers have limited IEEE command capability. The PET/CBM computers, for example, are incapable of sending multiline commands from BASIC, although these commands can be sent through machine-language routines. The capabilities of other small computers depends on the particular interface being used. Often, little software "tricks" are required to achieve the desired results.

From the preceding discussion, the message is clear: make sure the proper software is being used with the interface. Often, the user may incorrectly suspect that a hardware problem is causing fault, when it was the software that was causing the problem all along.

3.1.2 HP-85 BASIC Statements

Many of the programming instructions covered in Section 3 use examples written in Hewlett-Packard Model 85 BASIC. The HP-85 was chosen for these examples because it has a large number of BASIC statements that control IEEE-488 operation. This section covers those HP-85 BASIC statements that are essential to Model 705 operation.

A complete list of HP-85 BASIC statements is shown in Table 3-1. All the statements in the table have one or three digit arguments that must be specified. The first digit is the HP-85 interface select code, which is set to 7 at the factory. The last two digits of those statements that require a three digit argument specify the primary address. Generally, only those commands that actually require an address to be sent over the bus require that the primary address be specified in the BASIC statement.

Those statements in the table with three digit arguments assume that the primary address of the device is set at 17. Other primary addresses require that the last two digits be set to the corresponding value. For example, to send a GTL command to device 22, the following BASIC statement would be used: LOCAL 722.

Some of the statements in the table have two forms; the exact configuration used depends on the desired command. For example, CLEAR 7 will cause a DCL to be sent, while CLEAR 717 causes an SDC to be transmitted to device 717.

The third column of Table 3-1 lists the mnemonics for the command sequences. While most of these are covered elsewhere, a couple of points should be noted. The ATN line is set low by the controller if the data bus contains a multiline command.

This is indicated in the table by ANDing the ATN mnemonic with the first command on the bus. For example, ATN•GET means that ATN and GET are sent simultaneously.

Two commands not previously covered are MLA (My Listen Address) and MTA (My Talk Address). These are ordinary PCG (Primary Command Group) addresses sent by the HP-85 to facilitate bus operation in some situations. The Model 705 will essentially ignore these commands (the Model 705 triggers on MTA in the T0 and T1 modes), but other devices may require that MLA and MTA be present in the command sequence under certain circumstances.

NOTE

The HP-85 address is set to 21 at the factory. Since each device on the bus must have a unique primary address, do not set the Model 705 to the controller's address to avoid possible conflicts.

3.1.3 Interface Function Codes

The interface function codes are part of the IEEE-488-1978 standards. These codes define an instrument's ability to support various functions and should not be confused with programming commands found elsewhere in this manual.

Table 3-2 lists the codes for the Model 705. These codes are also listed for convenience on the rear panel of the instrument immediately above the IEEE connector. The numeric value following each one or two letter code defines Model 705 capabilities as follows:

1. SH (Source Handshake Function)—The ability for the Model 705 to initiate the transfer of message/data on the data bus is provided by the SH function.

2. AH (Acceptor Handshake Function)—The ability for the Model 705 to guarantee proper reception of message/data on the data bus is provided by the AH function.
3. T (Talker Function)—The ability for the Model 705 to send device-dependent data over the bus (to other devices) is provided by the T function. Model 705 talker capabilities exist only after it has been addressed to talk.
4. L (Listener Function)—The ability for the Model 705 to receive device-dependent data over the bus (from other devices) is provided by the L function. Listener function capabilities of the Model 705 exist only after it has been addressed to listen.
5. SR (Service Request Function)—The ability for the Model 705 to request service from the controller is provided by the SR function.
6. RL (Remote-Local Function)—The ability for the Model 705 to be placed in the remote or local modes is provided by the RL function.
7. PP (Parallel Poll Function)—The Model 705 does not have parallel polling capabilities.
8. DC (Device Clear Function)—The ability for the Model 705 to be cleared (initialized) is provided by the DC function.
9. DT (Device Trigger Function)—The ability for the Model 705 to have its basic operation is provided by the DT function.
10. C (Controller Function)—The Model 705 does not have controller capabilities.
11. TE (Extended Talker Capabilities)—The Model 705 does not have extended talker capabilities.
12. LE (Extended Listener Capabilities)—The Model 705 does not have extended listener capabilities.

Table 3-1. HP-85 IEEE-488 BASIC Statements

Statement	Action	Bus Command Sequence
ABORTIO 7 CLEAR 7 CLEAR 717 ENTER 717;A\$	Send IFC. Send DCL. Send SDC to device 17. Device 17 addressed to talk. Data placed in A\$.	IFC ATN•DCL ATN•UNL;MTA;LAG;SDC ATN•UNL;MLA;TAG;ATN;data
LOCAL 7 LOCAL 717 LOCAL LOCKOUT 7 OUTPUT 717;A\$	Set REN False Send GTL to device 17. Send LLO. Device 17 addressed to listen. Transmit A\$.	$\overline{\text{REN}}$ ATN•UNL;MTA;LAG;GTL ATN•LLO ATN•MTA;UNL;LAG; $\overline{\text{ATN}}$;data
REMOTE 7 REMOTE 717	Set REN true. Set REN true. Address device 17 to listen.	REN REN;ATN•UNL;MTA;LAG
RESET 7 SPOLL(717)	Send IFC, cancel REN. Address device 17 to talk. Conduct serial poll.	IFC;REN; $\overline{\text{REN}}$ ATN•UNL;MLA;TAG;SPE; $\overline{\text{ATN}}$; status byte;ATN•SPD;UNT
TRIGGER 7 TRIGGER 717	Send GET without addressing. Address device 17 to listen. Send GET.	ATN•GET ATN•UNL;MTA;LAG;GET

Table 3-2 Model 705 Interface Function Codes

Code	Interface Function
SH1	Source Handshake Capability
AH1	Acceptor Handshake Capability
T6	Talker (Basic Talker, Serial Poll, Unaddressed To Talk On LAG)
L4	Listener (Basic Listener, Unaddressed To Listen On TAG)
SR1	Service Request Capability
RL0	Remote/Local Capability
PP0	No Parallel Poll Capability
DC1	Device Clear Capability
DT1	Device Trigger Capability
C0	No Controller Capability
E1	Open Collector Bus Drivers
TE0	No Extended Talker Capabilities
LE0	No Extended Listener Capabilities

3.1.4 Model 705 Interface Commands

Interface commands controlling Model 705 operation are listed in Table 3-3. Not included in the table are device-dependent commands, which are covered in detail in paragraph 3.5.

Table 3-3. IEEE Command Groups

HANDSHAKE COMMAND GROUP	
	DAC = DATA ACCEPTED
	RFD = READY FOR DATA
	DAV = DATA VALID
UNIVERSAL COMMAND GROUP	
	ATN = ATTENTION
	DCL = DEVICE CLEAR
	IFC = INTERFACE CLEAR
	LLO = LOCAL LOCKOUT
	REN = REMOTE ENABLE
	SPD = SERIAL POLL DISABLE
	SPE = SERIAL POLL ENABLE
ADDRESS COMMAND GROUP	
LISTEN:	LAG = LISTEN ADDRESS GROUP
	MLA = MY LISTEN ADDRESS
	UNL = UNLISTEN
TALK:	TAG = TALK ADDRESS GROUP
	MTA = MY TALK ADDRESS
	UNT = UNTALK
	OTA = OTHER TALK ADDRESS
ADDRESSED COMMAND GROUP	
	ACG = ADDRESSED COMMAND GROUP
	GET = GROUP EXECUTE TRIGGER
	GTL = GO TO LOCAL
	SDC = SELECTIVE DEVICE CLEAR
STATUS COMMAND GROUP	
	RQS = REQUEST SERVICE
	SRQ = SERIAL POLL REQUEST
	STB = STATUS BYTE
	END = EOI

3.2 IEEE-488 BUS LINES

As shown in Figure 3-1, the signal lines on the IEEE-488 bus are divided into three groups: management, handshake and data lines. The management and handshake lines ensure that proper data transfer and bus operation takes place while the data lines handle the bus information. Each of the bus lines are low true.

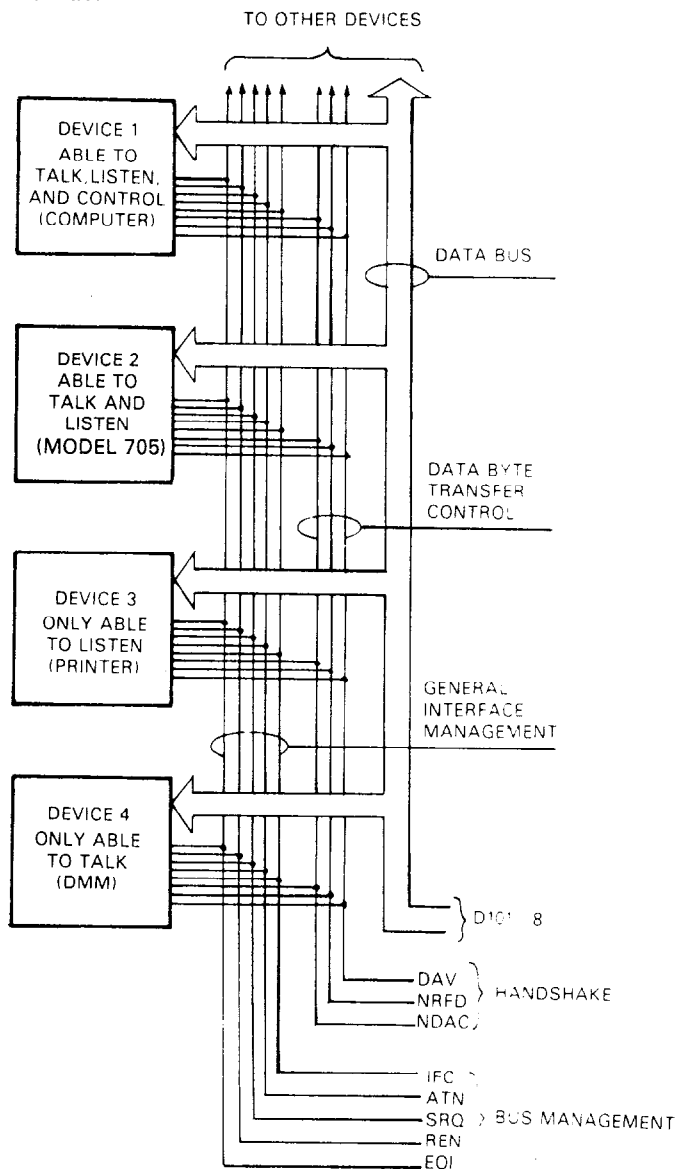

Figure 3-1 Bus Structure

3.2.1 Bus Management Lines

The bus management groups consists of five signal lines that send certain single line bus commands and ensure an orderly transfer of data. The five signal lines are:

1. ATN (Attention)—The state of the ATN line determines whether information placed on the data bus by the controller is to be considered data or a command.

2. IFC (Interface Clear)—The IFC command is sent by the controller to set the Model 705 to the talk and listen idle states. The instrument responds to the IFC command by cancelling the front panel TALK or LISTEN lights if the instrument was previously in one of those modes. No other state changes occur within the instrument. To send the IFC command, the controller only has to set the IFC line true.

Programming Example—Before demonstrating the IFC command, turn on the front panel REMOTE and TALK indicators by entering the following statements into the HP-85.

```
REMOTE 717 (END LINE)
A$ = "TOX"
OUTPUT 717; A$
ENTER 717; A$
```

The front panel TALK and REMOTE indicators should now be on. The IFC command may now be sent by entering the following statement into the HP-85.

```
ABORTIO 7 (END LINE)
```

After the END LINE key is pressed, the TALK indicator turns off, indicating the Model 705 is in the talk idle state. Note that the remote mode is not cancelled.

3. REN (Remote Enable)—Setting the REN line low (true) sends the REN command setting up instruments on the bus for remote operation. If REN is followed by the primary address of the Model 705 then it will be the only instrument to be placed in remote.

Programming Example—This sequence is automatically sent by the HP-85 when the following is entered into the HP-85:

```
REMOTE 717 (END LINE)
```

When the END LINE key is pressed the Model 705 is placed in the remote mode and the front panel REMOTE indicator turns on.

- 4. EOI (End Or Identify)—The EOI is used to identify the last byte of a multi-byte transfer sequence.
- 5. SRQ (Service Request)—The SRQ line is set low (true) by a device when it requires service. SRQ can be identified by reading the status word.

3.2.2 Handshake Lines

The handshake group consists of three handshake lines which operate in an interlocked sequence. The interlocked sequence ensures reliable data transfer regardless of the transfer sequence. The slowest device on the bus usually determines the transfer rate.

DAV (Data Valid), NRFD (Not Ready For Data) and NDAC (Not Data Accepted) are the three handshake lines. The DAV line is controlled by the source. The NRFD and NDAC lines are controlled by the accepting devices. The complete handshake sequence is shown in Figure 3-2. This sequence handles information one byte at a time.

Once the data is on the bus, the source checks to see that NRFD is high. At the same time NDAC should be low from the

previous byte transfer. Once the NRFD and NDAC lines are properly set, the source sets the DAV line low (Data Valid). The NRFD line goes low; the NDAC then goes high once all the devices on the bus have accepted the data. Each device releases the NDAC line at its own rate, but the NDAC line will not go high until the slowest device on the bus has accepted the data.

After the NDAC line goes high, the source sets the DAV line high indicating that the data is no longer valid. At this point, the NDAC line goes low. The NRFD line is released by each device on the bus, but does not go high until the slowest device on the bus has released the line. The bus is now set to repeat the sequence with the next data byte.

The sequence just described is used to transfer both data and multiline commands. The state of the ATN line determines whether the data bus contains data or commands.

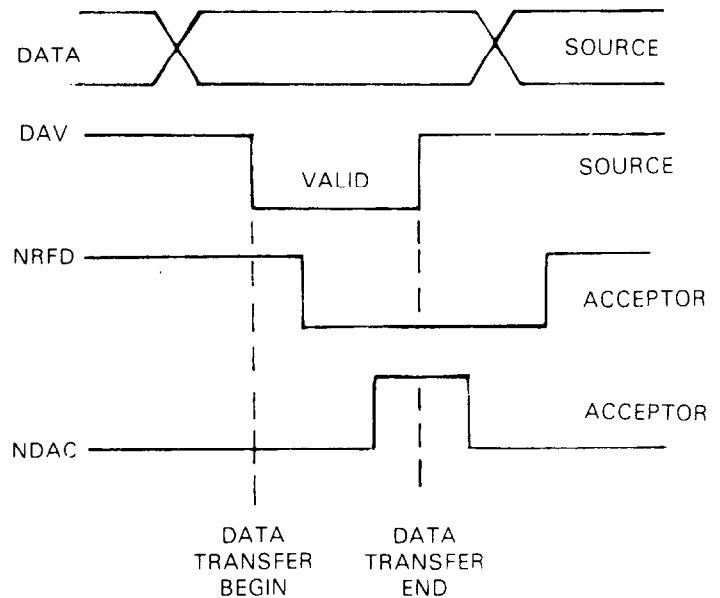

Figure 3-2. Handshake Sequence

3.2.3 Data Lines

The IEEE-488 bus uses eight data lines that transfer data one byte at a time. DIO1 (Data Input Output 1) through DIO8 (Data Input Output 8) are the eight data lines used to transmit both data and multiline commands, and are bi-directional. The data lines operate with low true logic.

3.3 SYSTEM SET UP PROCEDURE

There are three primary set up steps that prepare the system for operation. The three steps are:

- 1. Bus Connections—The Model 705 is connected to the bus via rear panel connector (J1002). J1002 is a standard IEEE bus connector. Maximum cable length for any device on the bus is 20 meters. The Keithley Models 7008-3 and 7008-6 are ideal for connecting instruments to the bus.

Figure 3-3 shows the connector pin assignments. The connector contact designations are listed in Table 3-4.

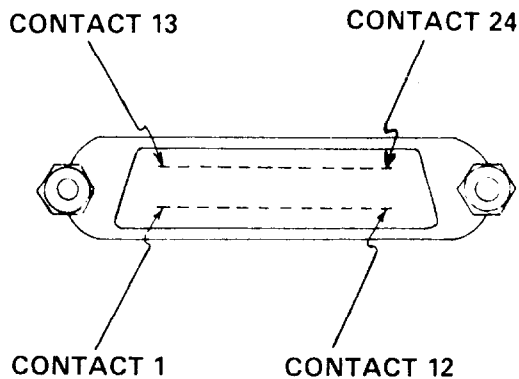

Figure 3-3. Contact Assignments

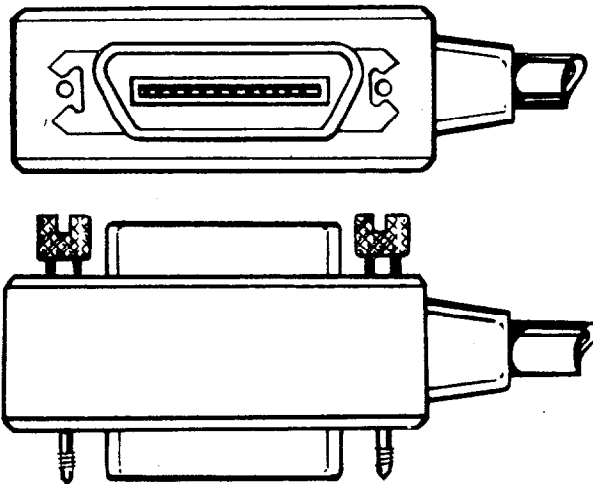

Figure 3-4. Model 705 IEEE Bus Connector

2. Primary Address Selection—The primary address must be set to the appropriate value when using the Model 705 in the addressable mode (refer to step 3).
3. The primary address is selected by front panel program number three. For more information concerning the primary address selection refer to paragraph 2.6.4.

3.4 BUS COMMANDS

The Model 705 may be given a number of special bus commands through the IEEE-488 interface. This section briefly describes the purpose of the bus commands which are grouped into the following three categories:

1. Uniline Commands: Sent by setting the associated bus lines low.
2. Multiline Commands: General commands are sent with the ATN line low.
3. Device Dependent Commands: Special commands that depend on device configurations; sent with ATN high.

Table 3-4. IEEE Bus Connector Contact Designations

Contact Number	IEEE-488 Designation	Type
1	DIO1	Data
2	DIO2	Data
3	DIO3	Data
4	DIO4	Data
5	EOI (24)*	Management
6	DAV	Handshake
7	NRFD	Handshake
8	NDAC	Handshake
9	IFC	Management
10	SRQ	Management
11	ATN	Management
12	SHIELD**	Ground
13	DIO5	Data
14	DIO6	Data
15	DIO7	Data
16	DIO8	Data
17	REN (24)*	Management
18	Gnd, (6)*	Ground
19	Gnd, (7)*	Ground
20	Gnd, (8)*	Ground
21	Gnd, (9)*	Ground
22	Gnd, (10)*	Ground
23	Gnd, (11)*	Ground
24	Gnd, LOGIC	Ground

*Numbers in parentheses refer to signal ground return of referenced contact number. EOI and REN signal lines return on contact 24.

**The cable shield is normally connected to contact 12. This shield should be connected to ground only at the controller end to avoid ground loop problems.

3.4.1 Uniline Commands

As stated previously, uniline commands are sent by setting the associated bus line low (true). The five uniline (single line) commands are:

1. ATN (Attention)—The ATN command is sent when the information on the data bus is a universal or addressed command. Universal and addressed commands are described in paragraphs 3.4.2 and 3.4.3. When the ATN line is high, the byte on the data bus is considered to be data. The Model 705 responds to the appropriate universal and addressed commands when the ATN line is low, and to the device-dependent commands when the ATN line is high, assuming it is properly addressed.
2. REN (Remote Enable)—The controller sends this command to all devices on the bus when remote operation is desired. The Model 705 responds by setting itself up for remote operation as indicated by the front panel REMOTE LED.
3. EOI (End Or Identify)—EOI is sent during the last byte of a multibyte transfer by setting the EOI line low. In this way, the last byte is identified allowing variable length data words to be transmitted. The Model 705 implements this command when in the appropriate bus response mode, as stated in paragraph 3.5.

4. IFC (Interface Clear)—The IFC command sets the bus to a known state by setting the IFC line (true).
5. SRQ (Service Request)—The SRQ line is pulled low by an external device thereby informing the controller the device requires service. The Model 705 implements this command when in the appropriate bus response mode, as stated in paragraph 3.5.3.

3.4.2 Universal Commands

The IEEE-488 universal commands are sent when the ATN line is low (true). There are six universal commands and their effect on the Model 705 operation is described as follows:

1. DCL (Device Clear)—The DCL command is used to clear the Model 705 setting it to a known state. Program memory is cleared of all previously stored data when a DCL or SDC command is received. The buffer is set to location one.

Programming Example—Using front panel controls enter five channels on the Model 705 and select the continuous program mode. Now enter the following statements into the HP-85:

```
REMOTE 717 (END LINE)
CLEAR 7 (END LINE)
```

When END LINE is pressed the second time, the Model 705 is set to its power-up default conditions which are listed in Table 3-5.

2. LLO (Local Lockout)—The LLO command is sent by the controller to remove the Model 705 from the local operating mode. Once the instrument receives the LLO command all

front panel controls (except POWER) are locked out. The REN bus line must be low (true) before the instrument responds to an LLO command.

Programming Example—This sequence is automatically performed by the HP-85 when the following statements are entered into the keyboard:

```
REMOTE 717 (END LINE)
LOCAL LOCKOUT 7 (END LINE)
```

NOTE

To get the Model 705 out of LLO refer to paragraph 3.4.3 step 3.

3. SPE (Serial Poll Enable)—The serial poll enable sequence is used to obtain the Model 705 status byte. Usually, the serial polling sequence is used to determine which of several devices has requested service over the SRQ line. The serial polling sequence is conducted as follows:
 - A. The controller sets the ATN line true.
 - B. The SPE command is placed on the bus by the controller.
 - C. The Model 705 is addressed to talk.
 - D. The controller sets the ATN line false.
 - E. The instrument then places its status byte on the bus to be read by the controller.
 - F. The controller then sets the ATN line low and places SPD on the bus to end the serial polling sequence.

Programming Example—The HP-85 SPOLL statement automatically performs the serial polling sequence. To demonstrate serial polling momentarily power the unit down and enter

Table 3-5. Power-Up Default Values

Mode	Value	Status
Poles	A2	2-Pole Configuration
Display Channel	B001	Display Channel One
Channel Displayed	D0	Display Channel Mode
Date Format	E0	American Date Format
First Channel	F1	Set First Channel
Prefix	G000	Channel Data Transmitted with Prefix
Channel Settle Time	H000.010	Channel Settle Time = 10msec
ROM and LED Test	J1	Check ROM and LEDs
EOI	K0	EOI sent during last byte
Set Last Channel	L1	Last Channel set to one.
SRQ	M000	Send no SRQ
Open Channel	N1	Channel one open.
Program	P0	Step Program Mode
	Q	Previously programmed state.
	R	
	S	
Trigger Mode	T6	Start on External.
	U	Previously programmed state.
	V	Previously programmed state.
Interval Time	W000.010	Interval time set to 10msec.
Terminator	:	(CR)(LF)

the following statements into the HP-85 keyboard.

```
REMOTE 717 (END LINE)
S = SPOLL (717) (END LINE)
DISP S (END LINE)
```

When END LINE is pressed the second time, the computer performs the serial polling sequence. When END LINE is pressed the third time, the status byte value is displayed on the CRT. The status byte has a value of 0 with this example because no bits in the byte are set.

4. SPD (Serial Poll Disable)—The controller automatically sends the SPD command on the bus to end the serial polling sequence described in SPE.
5. UNT (Untalk)—The controller sends the UNT command to clear the bus of any talkers.
6. UNL (Unlisten)—The controller sends the UNL command to clear the bus of any listeners.

3.4.3 Addressed Commands

Each of the addressed commands are sent to a specific device on the bus. Each device is selected on the basis of its primary address. The Model 705 responds to these commands only if the primary address sent over the bus preceding these commands is the same as programmed via front panel Program 3. All these commands are implemented by addressing the Model 705 to listen.

1. SDC (Selected Device Clear)—The SDC command performs the same functions as the DCL command except that only the addressed device responds. The instrument returns to the set conditions listed in Table 3-6 when responding to an SDC command. The program memory is cleared of all previously stored data when a DCL command is received. Also, buffer and display pointers are set to location one.

Programming Example—Using front panel controls select five channels and also select the single program mode. Enter the following statements into the HP-85:

```
REMOTE 717 (END LINE)
CLEAR 712 (END LINE)
```

Note that the instrument did not respond to the SDC because

the command was sent with a primary address of 12. Now enter the following statement into the HP-85:

```
CLEAR 717 (END LINE)
```

This time the instrument returns to the power-up default conditions. Note that program memory is cleared of previously stored data.

2. GET (Group Execute Trigger)—The GET command is sent to the Model 705 to trigger the instrument. Using the GET command is only one of several methods that can be used to start or stop the Model 705 program operation.

Programming Example—Type in the following statements into the HP-85:

```
REMOTE 717 (END LINE)
CLEAR 717 (END LINE)
```

The Model 705 returns to the power-up default conditions. Place the instrument in the continuous program mode and start on GET trigger mode with the following statement:

```
OUTPUT 717; "P2T2X" (END LINE)
```

When END LINE is pressed the instrument is placed in the continuous program mode. The instrument may be triggered to start with the following statement:

```
TRIGGER 717 (END LINE)
```

The front panel START/STOP indicator will turn on, indicating the instrument has been triggered. To stop the instrument, enter the following statements into the HP-85:

```
OUTPUT 717; "T3X" (END LINE)
TRIGGER 717 (END LINE)
```

When END LINE is pressed the first time the scan sequence is stopped. Outputting any valid command while the Model 705 is scanning stops the scan.

When END LINE is pressed the second time, the front panel START/STOP LED goes out, showing the instrument has received the trigger.

NOTE

The Model 705 also responds to GET without addressing. This command is sent with the following HP-85 statement:

```
TRIGGER 7
```

Table 3-6. SDC Set Conditions

Parameter	Command	Notes
SRQ	M0	No SRQ
Display Mode	D0	Channel
Prefix	G0	Channel Data transmitted with prefix.
Trigger Modes	T6	Start on External.
Program	P0	Step Mode
Alarm Time	Q00:00:00	Disabled
I/O Port	O000	All outputs low.
EOI	K0	EOI is transmitted on the last byte out.
Terminator	Y(LF) = CR LF	
Display Channel	B1	Channel 1
Turn off the Alarm Timer. All channels open.		

3. GTL (Go To Local)—The GTL command is used to remove the instrument from the remote mode.

NOTE

The GTL command does not restore operation of locked out Model 705 front panel controls. With some instruments however, local control operation may be restored by the GTL command. To restore front panel control operation of the Model 705, the controller must set the REN line false.

Programming Example—If the instrument is not in the remote and lockout modes, enter the following statements into the HP-85:

```
REMOTE 717 (END LINE)
LOCAL LOCKOUT 7 (END LINE)
```

Check to see that the REMOTE indicator is on and the front panel controls are locked out. The GTL command sequence is automatically sent by the HP-85 with the following statement:

```
LOCAL 717 (END LINE)
```

Note that the REMOTE indicator on the front panel turns off, but the front panel controls are still locked out. Front panel control can be restored by setting the REN line false with the following statement:

```
LOCAL 7 (END LINE)
```

After executing this statement, the front panel controls will again operate. Setting REN false with the LOCAL 7 statement will also take the instrument out of the remote mode.

3.5 DEVICE-DEPENDENT COMMANDS

The device-dependent commands allow the user to send the Model 705 commands that perform the same operations as the front panel controls switches except for power ON/OFF. There are a number of commands that control parameters which are not available from the front panel. Each command is entered as an ASCII character followed by a specific parameter that is then sent over the bus by the controller. The bus treats these commands as data in that the ATN line is high (false) when the commands are transmitted.

Several commands may be grouped together. Before a command or command string is executed, the ASCII character X must be sent. Commands sent without an X (execute) are retained within the Model 705 command buffer until the execute character is received.

The condition of the status word within the Model 705 is affected by the device-dependent commands. The status word may be obtained from the unit by using commands covered in this section. Refer to paragraph 3.7 for status word information. Illegal commands do not change the mode of the Model 705 but the status byte condition changes as described in paragraph 3.6. Normal Model 705 commands are covered in the following paragraphs. All the device-dependent commands for the Model 705 are listed in Table 3-7.

The Model 705 executes the programmed commands in the order listed in Table 3-8. This means that if a statement is entered into the HP-85 as follows:

```
OUTPUT 717; "P1 W3.5 D1X" (END LINE)
```

The Model 705 executes the commands in the following order (according to Table 3-8):

1. Displays interval time (D1).
2. Select single scan mode (P1).
3. Programs interval time for 3.5 seconds (W3.5).

There are three types of commands that make up the device-dependent commands in Table 3-8.

1. Independent Commands—Commands that do not interact with each other.
2. Timer Commands—Commands that control the date and time.
3. Channel Commands—Commands that directly affect the channels.

3.5.1 Display Mode

The following four commands set the display mode for the channel, time, date or interval mode.

1. D0—The D0 command sets the Model 705 for the channel display mode.
2. D1—The D1 command sets the Model 705 for the interval time display mode. The interval time is the programmed time the channel is closed. The interval time can be altered by programming inputs, refer to section 3.5.8.
3. D2—The D2 command sets the Model 705 for the time display mode. The time in hours, minutes and seconds is displayed on the front panel, refer to paragraph 2.5.1 step 6 for time display format.
4. D3—The D3 command sets the Model 705 for the date display mode. The date in month and day is displayed on the front panel, refer to paragraph 2.5.1 step 6 for date display format.
5. D4—The D4 command sets the Model 705 for the display message mode. The display message mode allows the user to display a customized message on the Model 705's front panel display.

Programming Example—To transmit the channel data with a prefix and display the data on the HP-85's CRT enter the following program into the HP-85:

PROGRAM	COMMENTS
10 REMOTE 717 (END LINE)	Sets the Model 705 for the remote mode.
20 CLEAR 7 (END LINE)	Clear the Model 705.
30 OUTPUT 717; "G0X" (END LINE)	Send channel data with prefix.
40 ENTER 717;A\$ (END LINE)	Obtain data string.
50 DISP A\$ (END LINE)	Display data string.
60 END (END LINE)	End of program.

Table 3-7. Device-Dependent Commands

Command	Definition	Notes
A	Set Number of Poles	A0 = Matrix Mode A1 = 1-pole A2 = 2-pole A3 or A4 = 4-pole
B	Display Channel	Bnnn
C	Close Channel	Cnnn
D	Display Mode	D0 = Channel D1 = Interval Time D2 = Time D3 = Date D4 = Display Message
E	Date Format	E0 = American Date Format E1 = International Date Format
F	Set First Channel	Fnnn
G	Prefix	G0 = Channel Data sent with prefix. G1 = Channel Data sent without prefix. G2 = Buffer State sent with prefix. G3 = Buffer State sent without prefix. G4 = I/O Port sent with prefix. G5 = I/O Port sent without prefix. G6 = Time/Date sent with prefix. G7 = Time/Date sent without prefix. G8 = Status Word sent with prefix. G9 = Status Word sent without prefix. G10 = Settle Time sent with prefix. G11 = Settle Time sent without prefix. G12 = Alarm Time sent with prefix. G13 = Alarm Time sent without prefix. G14 = Interval Time sent with prefix. G15 = Interval Time sent without prefix. G16 = First/Last sent with prefix. G17 = First/Last sent without prefix.
H	Settle Time	Hnnn.nnn
I	Save	I1, I2, I3, I4, I5
J	Debug Test	J0 = Run Debug Test
K	EOI	K0 = EOI transmitted on last byte out K1 = Send no EOI
L	Set Last Channel	Lnnn
M	SRQ	Mnnn
N	Open Channel	Nnnn
O	I/O Port	Onnn
P	Program	P0 = Step P1 = Single P2 = Continuous
Q	Set Alarm Time	Qhh:mm:ss
R	Reset	Opens all channels and displays FIRST channel.
S	Set Time	Shh:mm:s
T	Trigger	T0 = Start on Talk T1 = Stop on Talk T2 = Start on GET T3 = Stop on GET T4 = Start on "X" T5 = Stop on "X" T6 = Start on External T7 = Stop on External

Table 3-7. Device-Dependent Commands (Cont.)

Command	Definition	Notes
U	Alternate Output	U0 = Channel U1 = All Channels U2 = I/O U3 = Date U4 = Status U5 = Settling U6 = Alarm U7 = Interval U8 = First/Last
V	Set Date	Vmm:dd
W	Set Interval Time	Wnnn.nnn
Y	Terminator	Yc
Z	Recall	Z1, Z2, Z3, Z4, Z5

Table 3-8. Hierarchy of Command Execution

Command	Definition	Notes
D	Display Mode	D0-Channel D1-Interval Time D2-Time D3-Date D4-Display Message
P*	Program	P0-Step P1-Single P2-Continuous
T*	Trigger Modes	T0-Start on Talk T1-Stop on Talk T2-Start on GET T3-Stop on GET T4-Start on "X" T5-Stop on "X" T6-Start on External T7-Stop on External
G*	Prefix Modes	G0-Channel Data sent with prefix. G1-Channel Data sent without prefix. G2-Buffer State sent with prefix. G3-Buffer State sent without prefix. G4-I/O Port sent with prefix. G5-I/O Port sent without prefix. G6-Time/Date sent with prefix. G7-Time/Date sent without prefix. G8-Status Word sent with prefix. G9-Status Word sent without prefix. G10-Settle Time sent with prefix. G11-Settle Time sent without prefix. G12-Alarm Time sent with prefix. G13-Alarm Time sent without prefix. G14-Interval Time sent with prefix. G15-Interval Time sent without prefix. G16-First/Last sent with prefix. G17-First/Last sent without prefix.
U*	Alternate Output	U0-Channel U1-All Channels U2-I/O U3-Date and Time

Table 3-8. Hierarchy of Command Execution (Cont.)

Command	Definition	Notes
.		U4-Status U5-Setting U6-Alarm U7-Interval U8-First/Last
J*	ROM and LED Test	J0-Run Debug Test
K*	EOI	K0-EOI sent on last byte out K1-Send no EOI
M*	SRQ	See Table 3-9
O*	I/O Port	0nnn where 0 = command n = 0 to 377 octal
E**	Date Format	E0-American Date Format E1-International Date Format
S**	Time	Set Time
V**	Date	Set Date
Q**	Alarm Time	Set Alarm Time
H*	Settling Time	Set Settling Time
W*	Interval Time	Set Interval Time
Y*	Terminator	IEEE Terminator Character
B*	Channel	Display Channel
I***	Channel Save	I1, I2, I3, I4 and I5 save a relay set up
C***	Close Channel	Close Channel
N***	Open Channel	Open Channel
Z***	Channel Recall	Z1, Z2, Z3, Z4 and Z5 recall a saved relay set up. Overrides close.
F***	Set First Channel	Set First Channel
L***	Set Last Channel	Set Last Channel
A***	Set Number of Poles	If changed First = 1 Last = last channel (20 to 200) and displays channel one.
R***	Reset	Opens all channels, displays first channel and over-rides close, open and recall.

*Independent Commands
 **Timer Commands
 ***Channel Commands

After typing in the program press the RUN key on the HP-85 to run the program. After the RUN key is pressed the channel data with a prefix is displayed as follows:

C001.S0

This program can be used for any of the prefix (G) commands.

To illustrate the D4 (display message) mode, read the following paragraphs and do the programming example.

The ASCII message is of course limited to the display of the 7-segment LED's on the front panel of the Model 705. The messages may be controlled with the following commands:

1. D4aaaaaX—The command is D4 while the letter a represents an ASCII character (up to 8 characters may be sent).
2. D0, D1, D2 or D3—Takes the Model 705 out of the display message mode. The Model 705 goes into the display mode programmed.

NOTES

For the following notes, refer to the display numbering sequence shown below:

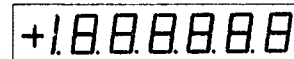

1. The first character must be a minus sign (-), decimal point or a 1 or it will be ignored.
2. Characters 2 through 8 will accept any displayable ASCII character. Any undisplayable characters will appear as a "d" segment. A "d" segment is shown below.

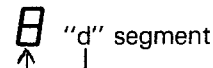

3. The maximum number of characters that can be sent is 8.

Programming Example—To display the message "use Single Scan" enter the following program into the HP-85.

PROGRAM	COMMENTS
10 REMOTE 717 (END LINE)	Set Model 705 to remote.
20 CLEAR 7 (END LINE)	Clears Model 705.
30 OUTPUT 717; "D4 USE X" (END LINE)	Displays USE on the Model 705 display.
40 WAIT 1000 (END LINE)	Wait one second.
50 OUTPUT 717; "D4 SINGLE X" (END LINE)	Displays SINGLE on the Model 705 display.
60 WAIT 1000 (END LINE)	Wait one second.
70 OUTPUT 717; "D4 SCAN X" (END LINE)	Displays SCAN on the Model 705 display.
80 WAIT 1000 (END LINE)	Wait one second.
90 GO TO 30	Go to line 30.
100 END	End of program.

When the END LINE key is pressed the second time the Model 705 displays the following:

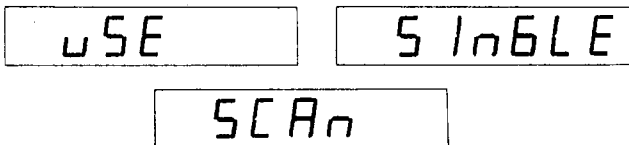

Display operation may be restored by entering the following statement into the HP-85:

OUTPUT 717; "D0X" (END LINE)

3.5.2 Program (Scan) Mode

The following three commands set the Model 705 to the single, continuous or step scan mode.

1. P0—The P0 command sets the Model 705 to the step scan mode. The step scan mode permits the user to scan through the programmed channels one at a time upon sending the P0 command. In using the step scan mode over the IEEE bus the interval time must be greater than 10msec.
2. P1—The P1 command sets the Model 705 to the single scan mode. The single scan mode permits one complete scan of the programmed channels.
3. P2—The P2 command sets the Model 705 to the continuous scan mode. The continuous scan mode permits a continuous scan of the programmed channels.

3.5.3 Prefix

1. G0—Sending the G0 command transmits the channel data with a prefix. The format is as follows:

Cnnn,Sn

where C = Present Channel

S = Status of Present Channel

0 = open 1 = closed

2. G1—Sending the G1 command transmits the channel data without a prefix. The format is as follows:

nnn,n

3. G2—Sending the G2 command transmits the entire channel buffer state with a prefix. The format is as follows:

C001,Sn,

C002,Sn,

Cnnn,Sn

4. G3—Sending the G3 command transmits the entire channel buffer state without a prefix. The format is as follows:

001,n,

002,n,

nnn,n

5. G4—Sending the G4 command transmits the status of the I/O port with a prefix. The format is as follows:

I/Oiii,ooo

where i = the input from 0 to 377 octal.

o = the output form 0 to 377 octal.

6. G5—Sending the G5 command transmits the status of the I/O status port without a prefix. The format is as follows:

iii,ooo

7. G6—Sending the G6 command transmits the time and date with a prefix. The format is as follows:

Thh:mm:ss,Dmm:dd

8. G7—Sending the G7 command transmits the time and date without a prefix. The format is as follows:

hh:mm:ss,mm:dd

9. G8—Sending the G8 command transmits the status word with a prefix. The status word format is covered in detail in paragraph 3.7.

10. G9—Sending the G9 command transmits the status word without a prefix. The status word format is covered in detail in paragraph 3.7.

11. G10—Sending the G10 command transmits the channel settling time with a prefix. The format is as follows:

Hnnn.nnn

12. G11—Sending the G11 command transmits the channel settling time without a prefix. The format is as follows:

nnn.nnn

13. G12—Sending the G12 command transmits the alarm time with a prefix. The format is as follows:

Qhh:mm:ss

14. G13—Sending the G13 command transmits the alarm time without a prefix. The format is as follows:

hh:mm:ss

15. G14—Sending the G14 command transmits the interval time with a prefix. The format is as follows:

Wnnn.nnn

16. G15—Sending the G15 command transmits the interval time without a prefix. The format is as follows:

nnn.nnn

17. G16—Sending the G16 command transmits the selected first and last channel numbers with a prefix. The format is as follows:

Fnnn,Lnnn

18. G17—Sending the G17 command transmits the selected first and last channel numbers without a prefix. The format is as follows:

nnn,nnn

3.5.4 EOI

The EOI line on the bus is usually set low by a device during the

last byte of its data transfer sequence. In this way, the last byte is properly identified allowing variable length data words to be transmitted. The Model 705 normally sends EOI during the last byte of its data string or status word. The EOI response of the instrument may be set with one of the following commands:

1. K0—Send EOI during last byte
2. K1—Send no EOI

NOTE

Upon power-up the K0 mode is enabled.

Programming Example—The EOI response is suppressed with the following HP-85 statement sequence:

```
REMOTE 717 (END LINE)
OUTPUT 717; "K1X" (END LINE)
```

3.5.5 Bus Response Mode (SRQ)

The bus response mode determines whether or not the Model

705 requests service from the controller through the SRQ line. When the appropriate mode is selected, the instrument generates a SRQ under the data or error conditions described as follows:

1. If the instrument receives an illegal device-dependent command (IDDC) or illegal device-dependent command option (IDDCO), or if the instrument is not in remote when programmed.
2. If the end of the buffer is encountered when running a program.
3. At the end of interval time.
4. Execution of time alarm.
5. End of settling time.
6. Broken Serial loop.

Upon power-up, or after a DCL or SDC, SRQ is disabled. The bus response made may be programmed as follows:

1. M0—No SRQ
2. M1 through 63—Send SRQ

Refer to Table 3-9 for conditions that generate a SRQ.

Table 3-9. SRQ Commands and Conditions

SRQ Command	Broken Serial Loop	End of * Settling Time	Interval* Time	End of* Scan	Timer* Alarm	IDDC, IDDCO, * No Remote
M0**						
M1						X
M2					X	
M3					X	X
M4				X		
M5				X		X
M6				X	X	
M7				X	X	X
M8			X			
M9			X			X
M10			X		X	
M11			X		X	X
M12			X	X		
M13			X	X		X
M14			X	X	X	
M15			X	X	X	X
M16		X				
M17		X			X	
M18		X		X		
M19		X		X	X	
M20		X		X		
M21		X		X		X
M22		X		X	X	
M23		X		X	X	X
M24		X	X			
M25		X	X		x	
M26		X	X		X	
M27		X	X		X	X
M28		X	X	X		
M29		X	X	X		X
M30		X	X	X	X	
M31		X	X	X	X	X
M32	X					
M33	X					X

Table 3-9. SRQ Commands and Conditions

SRQ Command	Broken Serial Loop	End of * Settling Time	Interval* Time	End of* Scan	Timer* Alarm	IDDC, IDDCO, * No Remote
M34	X				X	
M35	X				X	X
M36	X			X		
M37	X			X		X
M38	X			X	X	
M39	X			X	X	X
M40	X		X			
M41	X		X			X
M42	X		X		X	
M43	X		X		X	X
M44	X		X	X		
M45	X		X	X		X
M46	X		X	X	X	
M47	X		X	X	X	X
M48	X	X				
M49	X	X				X
M50	X	X			X	
M51	X	X			X	X
M52	X	X		X		
M53	X	X		X		X
M54	X	X		X	X	
M55	X	X		X	X	X
M56	X	X	X			
M57	X	X	X			X
M58	X	X	X		X	
M59	X	X	X		X	X
M60	X	X	X	X		
M61	X	X	X	X		X
M62	X	X	X	X	X	
M63	X	X	X	X	X	X

*Indicates conditions that generate an SRQ.
 **M0 disables SRQ.

NOTE

Upon power-up, the M0 mode is selected. The SRQ byte is cleared on a read of the serial poll byte.

Programming Example—The bus response mode may be programmed as follows:

```
REMOTE 717 (END LINE)
OUTPUT 717; "M1X" (END LINE)
```

The SRQ format is as follows:

Mnnn

where M = Bus Response Mode
 n = 0 to 255 (base 10) in base 2 NNNNNNNN

SRQ MASK

MSB							LSB
7	6	5	4	3	2	1	0
N/A	N/A	1 = BROKEN SERIAL LOOP	1 = END OF SETTling TIME	1 = END OF INTERVAL TIME	1 = END OF SCAN	1 = TIMER ALARM	1 = IDDCO, IDDC OR NO REMOTE

SRQ BYTE

MSB							LSB
7	6	5	4	3	2	1	0
N/A	SRQ	0	END OF SETTling TIME	END OF INTERVAL TIME	END OF SCAN	TIMER ALARM	N/A
DATA							0
ERROR	N/A	SRQ	1	N/A	BROKEN SERIAL LOOP	NO RE MOTE	IDDCO IDDC
							1

SRQ Mask—In order to facilitate SRQ programming, the Model 705 makes use of a mask when generating a SRQ. When the appropriate bit in the mask is set, the instrument generates a SRQ when those particular conditions exist. The SRQ mask byte format is shown above. Bits within the mask can be controlled by sending the ASCII character "M" followed by a decimal number from 0 to 63. Table 3-9 lists the conditions that cause a SRQ for each command parameter. Note that the instrument can be programmed for one or more conditions simultaneously.

3.5.6 Trigger Modes

Triggering is used to tell the Model 705 to initiate the program mode sequence (single, continuous or step). The trigger stimulus may come from commands sent over the bus, through the external input or by the front panel START/STOP button. Triggering may be to either start the program mode sequence or stop the program mode sequence. The trigger modes are as follows:

1. T0 — In the T0 mode a Talk command initiates the program mode sequence.
2. T1 — In the T1 mode a Talk command stops the program mode sequence.
3. T2 — In the T2 mode a GET command initiates the program mode sequence.
4. T3 — In the T3 mode a GET command stops the program mode sequence.
5. T4 — In the T4 mode an execute command "X" initiates the program mode sequence.
6. T5 — In the T5 mode an execute command "X" stops the program mode sequence.
7. T6 — In the T6 mode an external trigger initiates the program mode sequence.
8. T7 — In the T7 mode an external trigger stops the program mode sequence.

Programming Example — Set the instrument to its default condition by turning the unit off then on and enter the following statements into the HP-85 keyboard:

```
REMOTE 717 (END LINE)
OUTPUT 717; "T2X" (END LINE)
```

After the END LINE key is pressed the second time, the instrument is placed in the start on GET trigger mode. When a GET command is sent by the controller the Model 705 triggers. To send a GET type the following into the HP-85.

```
TRIGGER 717 (END LINE)
```

Trigger Mode T0 — If the Model 705 is in trigger mode T0 (Start on Talk), either of the following HP-85 BASIC statements will initiate a scan:

```
SEND 7; TALK 17
S=SPOLL (717)
```

Requesting data from the Model 705 will stop the scan. The statement:

```
ENTER 717; AS
```

does not initiate a scan since the controller addresses the Model 705 to talk and then requests data in the same statement.

3.5.7 Programmable Terminator (Y)

The Model 705 uses special terminator characters to mark the end of its data string. To allow a wide variety of controllers to be used, the terminator can be changed by sending the appropriate command over the bus. The power-up default value is the commonly used carriage return, line feed (CR LF) sequence. The terminator assumes this default value upon power-up or after the instrument receives a DCL (Device Clear) or SDC (Selected Device Clear).

The terminator may be programmed by sending the ASCII character Y followed by the desired terminator character. Any ASCII character except one of the following may be used:

1. All capital letters
2. All numbers
3. Blank
4. +
5. -
6. /
7. ,
8. .
9. e
10. :

Special command characters will program the instrument for special terminator sequences as follows:

1. Y(LF) = CR LF (Two terminators)
2. Y(CR) = LF CR (Two terminators)
3. Y(DEL) = No terminator.

NOTE

Most controllers use the CR or LF character to terminate their input sequences. Using a nonstandard terminator may cause the controller to hang up unless special programming is used.

Programming Example — Enter the following statements into the HP-85 keyboard:

```
REMOTE 717 (END LINE)
OUTPUT 717; "YtX" (END LINE)
ENTER 717; t$ (END LINE)
```

After END LINE is pressed the first time the Model 705 is placed in the remote mode. After END LINE is pressed the second time the terminator is changed to the ASCII character T. After END LINE is pressed the third time, the HP-85 ceases to operator because it is waiting for the standard terminator sequence. The HP-85 may be reset by holding down the SHIFT key and then pressing RESET on the keyboard.

3.5.8 Inputs

NOTE

Refer to paragraph 2.6.7 for more details on using Program 6, including recommendations on mixing card types.

CAUTION

When a Model 705 mainframe contains a mix of cards (matrix, 10-channel, 20-channel), you can use more than one pole mode to address the cards. In other words, use the 0-pole mode for a matrix card, the 1-pole mode for a 20-channel card, and the 2-pole mode for a 10-channel card. In cases where a 0-pole mode card is used with a 10 or 20-channel card, you must place the Model 705 into the 0-pole mode before using the 1-pole or 2-pole mode. This action will properly initialize the 0-pole mode card. Then you can place the Model 705 into the 1-pole or 2-pole mode to address the other card. This operation is not necessary if the mainframe powers up in the 0-pole mode.

1. Set Number of Poles (A)

The letter A is the command to set the Model 705 into one of the pole configurations or the matrix mode. There are three different pole configurations and they are as follows:

- A0 = Matrix Mode
- A1 = 1-pole
- A2 = 2-pole
- A3 or A4 = 4-pole

Programming Example — Enter the following statements into the HP-85 to program the Model 705 into the 4-pole mode.

```
REMOTE 717 (END LINE)
OUTPUT 717; "A3X" (END LINE)
```

When END LINE is pressed the second time, the Model 705 goes into the 4-pole mode. To verify the Model 705 is programmed into the 4-pole mode, press PRGM, 6 and note the front panel display.

Once the mainframe has been programmed into the matrix mode the display uses the following format:

nn m O or C

where:

nn — is a two digit number displaying the column (five columns per card, two cards per unit, five daisy chained units maximum).

m — is the row from 1 to 4.

O or C — denotes open or closed.

For example:

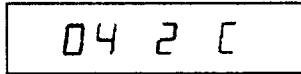

- Which means:
- 1st unit (1-10 = unit one)
 - 1st card (1-5 = first card)
 - 4th column
 - 2nd row
 - closed

Programming Example — Enter the following statements into the HP-85 to program the Model 705 to the first unit, first card, fourth column, second row, and close this channel.

```
REMOTE 717 (END LINE)
OUTPUT 717; "C042X" (END LINE)
```

To display the previously programmed channel on the mainframe's display enter the following statement into the HP-85.

```
OUTPUT 717; "B042X" (END LINE)
```

2. Display Channel (B)

The letter B is the command to program the Model 705 to display a particular channel. The format for the display channel command is as follows:

Bnnn

where B = Display Channel Command
n = Number of Channel

Programming Example — Enter the following statements into the HP-85 to program the Model 705 to display channel 7.

```
REMOTE 717 (END LINE)
OUTPUT 717; "B7X" (END LINE)
```

The number of channels for a particular configuration is determined by the number of poles, and Model 705's daisy chained

together. If the channel specified in the statement is greater than the programmed last channel, the Model 705 gives an IDDCO and then returns to the previously displayed channel. Take note of the front panel display upon pressing END LINE the second time. Channel 7 should be displayed.

3. Close Channel (C)

The letter C is the command to close a particular channel. The format for the close channel command is as follows:

Cnnn

where C = Close Channel command
n = Number of Channel

Programming Example — Enter the following statements into the HP-85 to program the Model 705 to close channel 7.

```
REMOTE 717 (END LINE)
OUTPUT 717; "C7X" (END LINE)
```

Take note of the front panel display upon pressing END LINE the second time. Channel 7 should be closed.

NOTE

The number of channels for a particular configuration is determined by the number of poles, and Model 705's daisy chained together. If the channel specified in the statement is greater than the programmed last channel, the Model 705 gives an IDDCO and returns to the previous displayed channel.

4. Display Mode (D)

The letter D is the command to set a particular display mode. There are five display modes and they are as follows:

- D0 = Display Channel
- D1 = Display Interval Time
- D2 = Display Time
- D3 = Display Date
- D4 = Display Message

Programming Example — Enter the following statements into the HP-85 to display the date.

```
REMOTE 717 (END LINE)
OUTPUT 717; "D3X" (END LINE)
```

When END LINE is pressed the second time, the Model 705 displays the date.

5. Set Date Format (E)

The letter E is the command to program the Model 705 to set the date format for american date format or the international date format. The two formats are as follows:

- E0 = American Date Format: mm.dd
- E1 = International Date Format: dd.mm

Programming Example — Enter the following statements into the HP-85 to set the date format for the international date format.

```
REMOTE 717 (END LINE)
OUTPUT 717; "E1X" (END LINE)
```

When END LINE is pressed the second time, the Model 705 is programmed for the international date format.

NOTE

Do not place the Set Date Format (E) command after another command in the same string. The Model 705 will process the "E" command as an exponent for scientific notation and create an invalid condition. Use the "E" command in a separate string.

6. Set First Channel (F)

The letter F is the command to program a specific channel as the first channel. Any channel within the limits of the specified channels can be programmed as the first channel. The format for the set first channel command is as follows:

Fnnn

where F = Set First Channel Command
n = Number of Channel

Programming Example — Enter the following statements into the HP-85 to set channel five as the first channel.

```
REMOTE 717 (END LINE)
OUTPUT 717; "F5X" END LINE
```

When END LINE is pressed the second time, the Model 705 sets channel five as the first channel. To display the channel mode send a D0 command. To display channel 5 send a B5.

NOTE

The number of channels for a particular configuration is determined by the number of poles, and Model 705's daisy chained together.

7. Prefix (G)

When the Model 705 is addressed to talk, the instrument sends a data string containing information on programmed channel data. Through the use of the prefix command, the operator has control whether or not the instrument sends the appropriate prefixes imbedded in the data string. The 17 prefix commands are as follows:

G0 — channel data transmitted with prefix.

Cnnn,Sn

where C = Present Channel

S = Status of Present Channel

n = 0 = Open

n = 1 = Closed

nnn = Number of Present Channel

G1 — Channel data transmitted without prefix.
nnn,n

G2 — Entire channel buffer state transmitted with prefix.
C000,Sn,
C001,Sn,

Cnn,SN

G3 — Entire channel buffer state transmitted without prefix.
000,n,
001,n,

nnn, n

G4 — I/O status port transmitted with prefix.
I/O iii,ooo

where i = input from 0 to 377 octal
o = output from 0 to 377 octal

G5 — I/O status port transmitted without prefix.
iii,ooo

G6 — Time and date transmitted with prefix.
(AMR/INT) Thh:mm:ss, Ddd:mm
where T = Time in hours, minutes, and seconds
D = Date in days and months

G7 — Time and date transmitted without prefix.
hh:mm:dd, mm:dd

G8 — Status word transmitted with prefix.
705 ADEJKPTG M Y
705 1100000000000:

G9 — Status word transmitted without a prefix.
ADEJKPTG M Y
1100000000000:

G10 — Channel settling time transmitted with prefix.
Hnnn.nnn

G11 — Channel settling time transmitted without prefix.
nnn.nnn

G12 — Alarm time transmitted with prefix.
Qhh:mm:ss

G13 — Alarm time transmitted with prefix.
hh:mm:ss

G14 — Interval time transmitted with prefix.
Wnnn.nnn

G15 — Interval time transmitted without prefix.
nnn.nnn

G16 — First and last channel numbers transmitted with prefix.
Fnnn,Lnnn

G17 — First and last channel numbers transmitted without prefix.
nnn,nnn

8. Set Channel Settling Time (H)

The letter H is the command to set the channel settling time. The channel settling time is the programmed time each channel has to settle. The format for this command is in seconds and is as follows:

Hnnn.nnn

Programming Example — Enter the following statements into the HP-85 to program settling time of each channel to 50.05 seconds.

```
REMOTE 717 (END LINE)
OUTPUT 717; "H050.050X" (END LINE)
```

When END LINE is pressed the second time, the settling time of each channel is set to 50.05 seconds. Upon completion of the programmed settling time the Model 705 outputs a negative going TTL level pulse of greater than 2µsec to the channel ready output. The pulse can be used to inform another device or instrument that the programmed settling time is completed for one channel. To display the settling time on the controller's display use the six line program in paragraph 3.5.1. Use G10 instead of G11 to send the settling time with a prefix.

9. Channel Save/Recall (I) and (Z)

The letter I is the command to save the present relay set up or recall the stored relay set up. Refer to paragraphs 2.6.5 and 2.6.6 (front panel Programs 4 and 5) for more information concerning saving and recalling relay set ups. The format for the save/recall command is as follows:

I1, I2, I3, I4 and I5 — Save the present relay set up.

Z1, Z2, Z3, Z4 and Z5 — Recall the stored relay set up.

Programming Example — Enter the following statements into the HP-85 to program the Model 705 to save the present relay set up.

```
REMOTE 717 (END LINE)
OUTPUT 717; "I1X" (END LINE)
```

When END LINE is pressed the second time, the Model 705 saves the present relay set up. To recall the stored relay set up enter the following statements into the HP-85.

```
REMOTE 717 (END LINE)
OUTPUT 717; "Z1X" (END LINE)
```

When END LINE is pressed the second time, the Model 705 recalls the stored relay set up.

Programming Example — Use the following program to store a relay set up of channels 1 through 5 with the programmed first channel being channel 1, and the programmed last channel being channel 5. The odd channels are programmed closed and the even channels are programmed open. Type the following program into the HP-85:

PROGRAM	COMMENTS
10 REMOTE 717 (END LINE)	Sets the Model 705 for the remote mode.
20 CLEAR 7 (END LINE)	Clears the Model 705.
30 OUTPUT 717; "B1 F1 C1X" (END LINE)	Displays, closes and sets channel 1 as the first channel.
40 OUTPUT 717; "B2N2X" (END LINE)	Displays and closes channel 2.
50 OUTPUT 717; "B3C3X" (END LINE)	Displays and closes channel 3.
60 OUTPUT 717; "B4N4X" (END LINE)	Displays and opens channel 4.
70 OUTPUT 717; "B5L5C5I1X" (END LINE)	Displays, closes, sets channel 5 as last channel and saves relay set up.
80 OUTPUT 717; "RX" (END LINE)	Opens all channels and displays the first channel.
90 END	

Press the Run key on the HP-85 to run the program. After the run key is activated the Model 705 displays the reset condition

0 1 F 0

Use the following programming example to recall and display the saved relay set up.

PROGRAM	COMMENTS
Output 717; "Z1X" (END LINE)	Recalls saved relay set up.

This program and the previous nine step program saved and recalled one relay set up. The Model 705 is capable of saving and recalling five set ups. The commands to save and recall the relay set ups are as follows:

I1 saves a set up and Z1 recalls the I1 set up.

I2 saves a set up and Z2 recalls the I2 set up.

I3 saves a set up and Z3 recalls the I3 set up.

I4 saves a set up and Z4 recalls the I4 set up.

I5 saves a set up and Z5 recalls the I5 set up.

It's possible to save a relay set up in any of the I commands without having any of the other save commands programmed to save a set up. For example, I2 can save a set up without having a set up saved by I1, I3, I4 or I5.

10. ROM and LED Test (J)

The letter J is the command that programs the Model 705 to go through many of the testing routines that are automatically performed upon power-up. When the self test command is sent, the following actions are performed:

1. ROM Test
2. LED Test (All front panel LEDs turn on for a short period of time.)
3. If the tests did not find anything wrong, then the self test (J) byte in the status word is set to one. If the test failed then the self test byte (J) is set to two.

The self test command is implemented with the following command sequence:

```
OUTPUT 717; "J0X" (END LINE)
```

NOTES

1. Other operating parameters are not affected by the J0 command.
2. RAM is not tested by the J0 command but is tested upon power-up.

11. EOI (End or Identify) (K)

The letter K is the command that programs the Model 705 to either send or not send EOI on the last byte out on a multiple byte sequence. EOI response of the instrument may be programmed as follows:

K0 — Send EOI during last byte.

K1 — Send no EOI.

Upon power-up, or after receiving an SDC or DCL, the Model 705 will be in the K0 mode.

Programming Example — The EOI will be suppressed with the following statement sequence:

```
REMOTE 717 (END LINE)
OUTPUT 717; "K1X" (END LINE)
```

Note that the HP-85 does not rely on EOI to mark the end of the data transmission. Some controllers, however, may require that EOI be present at the end of transmission.

NOTE

In the G2 and G3 prefix modes, EOI is transmitted only at the end of the complete program memory transmission; not during the last byte of each IEEE buffer or memory location.

12. Set Last Channel (L)

The letter L is the command to program a specific channel as the last channel. The last channel must be at least one channel ahead of the first channel otherwise, the scan sequence will not operate properly. For example, if the first channel is programmed to be five, then the last channel must be specified as at least six. The format for set last channel command is as follows:

Lnnn

where L = Set Last Channel Command
n = Number of Channel

Programming Example — Enter the following statement into the HP-85 to set channel 10 as the last channel.

REMOTE 717 (END LINE)
OUTPUT 717; "L10X" (END LINE)

When END LINE is pressed the second time, the Model 705 sets channel 10 as the last channel. To display channel 10 and verify it is programmed as the last channel type the following statement into the HP-85:

OUTPUT 717; "B10X" (END LINE)

NOTE

The number of channels for a particular configuration is determined by the number of poles, and Model 705 daisy chained together.

13. SRQ (M)

The letter M is the SRQ command mode. The SRQ mode controls which conditions within the instrument generates an SRQ (Service Request). Once an SRQ has been generated, the status can be checked to determine if the SRQ was generated by the Model 705. In addition, other bits in the status byte are sent depending on certain data and error conditions. For more information concerning the SRQ byte and SRQ mask refer to paragraph 3.5.5.

14. Open Channel (N)

The letter N is the command to open a specific channel. The format for the open channel command is as follows:

Nnnn

where N = Open Channel Command
n = Number of Channel

Programming Example — Enter the following statements into the HP-85 to program the Model 705 to open channel 7.

REMOTE 717 (END LINE)
OUTPUT 717; "N7X" (END LINE)

When the END LINE is pressed the second time, the Model 705 opens channel 7. To display channel 7 and verify it is open type the following statement into the HP-85:

OUTPUT 717; "B7X" (END LINE)

NOTE

The number of channels for a particular configuration is determined by the number of poles and Model 705's daisy chained together.

15. I/O Port (O)

The letter O is the I/O port command. It controls the status of the eight output bits on the display I/O port on the rear panel of the Model 705. The format for the I/O port command is as follows:

Oonn

where O = I/O Port Command
n = 0 to 377 Octal

Converting the octal base of n to correspond to base 2, eight outputs for the digital I/O outputs is as follows:

nnn = nnnnnnnn if 0, the bit is low.
(octal) binary) if 1, the bit is high.

Example: 077 = 00111111
(Octal) = (Binary)

The I/O port command consists of the ASCII O character followed by the decimal number that sets the control bits. Upon power-up, or after a DCL or SDC, the eight output lines are set low. Table 3-10 lists the digital I/O port contact pin assignments. Figure 3-5 shows the contact pin locations. The maximum current draw from the digital I/O port is 350mA. This includes the relay card and the output. The current limiting resistor is 68Ω.

NOTE*

The +5V on pins 1 and 2 of the digital I/O port is current limited by the 68Ω resistor.

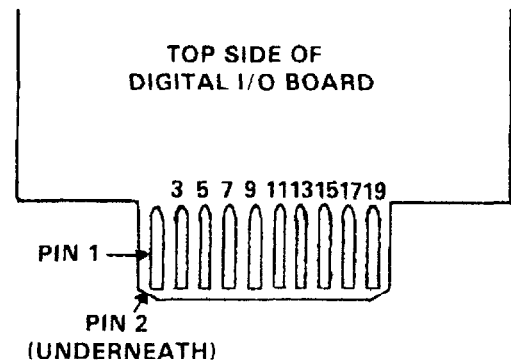

Figure 3-5. Digital I/O Port Pin Assignments

Table 3-10. Digital I/O Port Contact Pin Assignments

Pin Number	Connection
1	+ 5 Volts (for reference only)
2	+ 5 Volts (for reference only)
3	IEEE Common
4	IEEE Common
5	Input (Bit 7)
6	Output (Bit 7)
7	Input (Bit 6)
8	Output (Bit 6)
9	Input (Bit 5)
10	Output (Bit 5)
11	Input (Bit 4)
12	Output (Bit 4)
13	Input (Bit 3)
14	Output (Bit 3)
15	Input (Bit 2)
16	Output (Bit 2)
17	Input (Bit 1)
18	Output (Bit 1)
19	Input (Bit 0)
20	Output (Bit 0)

Programming Example — Enter the following statements into the HP-85 to set the eight output lines high and display the result on the HP-85 CRT.

PROGRAM	COMMENTS
10 REMOTE 717 (END LINE)	Sets Model 705 to remote mode.
20 CLEAR 7 (END LINE)	Clears Model 705.
30 OUTPUT 717; "0377X" (END LINE)	Sets Digital I/O outputs high.
40 OUTPUT 717; "G4X" (END LINE)	Sends I/O status port with prefix.
50 ENTER 717, A\$ (END LINE)	Obtain data string.
60 DISP A\$ (END LINE)	Display data string.
70 END (END LINE)	End of program.

When the run key is pressed the eight output lines will go high and the following is displayed on the HP-85 CRT:

I/O 377,XXX

NOTE

With no connections on the digital I/O inputs they are undefined.

16. Program (P)

The letter P is the command to select one of the three scanning modes. The scanning modes are explained in detail in paragraph 2.5.3. The format for each of the program modes is as follows:

- P0 — Step Mode
- P1 — Single Mode
- P2 — Continuous Mode

Programming Example — Enter the following statements into the HP-85 to program the Model 705 into the continuous mode.

```
REMOTE 717 (END LINE)
OUTPUT 717; "P2X" (END LINE)
```

When the END LINE key is pressed the second time the Model 705 is programmed into the continuous program mode. Look at the front panel continuous LED to verify that the continuous scan mode was activated. The continuous LED should be on.

17. Set Alarm Time (Q)

The letter Q is the command to set the alarm time. For example, if the alarm time is set for 11:30:00 a TTL level negative going pulse of greater than 10µsec appears at the SERIAL OUT output connector on the rear panel of the instrument at 11:30 AM everyday until changed. This pulse can be used to inform another instrument or device to initiate a scan sequence or open a channel on the Model 705. The format for the alarm time command is as follows:

Qhh:mm:ss

- where Q = Alarm Time Command
- h = Hours
- m = Minutes
- s = Seconds

Programming Example — Enter the following statements into the HP-85 to program the alarm time for 2:15 pm and display the alarm time on the HP-85 CRT.

PROGRAM	COMMENTS
10 REMOTE 717 (END LINE)	Sets Model 705 to remote mode.
20 CLEAR 7 (END LINE)	Clears Model 705.
30 OUTPUT 717; Q14:15:00X (END LINE)	Programs alarm time for 2:15 pm.
40 OUTPUT 717; A\$ "G12X" (END LINE)	Transmits alarm time with prefix.
50 ENTER 717, A\$ (END LINE)	Obtains data string.
60 DISP A\$ (END LINE)	Displays data string.
70 END (END LINE)	End of program.

When the RUN key is pressed, the alarm time is set for 2:15 pm. The alarm time is also displayed on the HP-85 CRT.

NOTE

When the format of the programmed time is not the full six digits (hh:mm:ss) the Model 705 truncates the time to what is programmed. If in this example the last two zeroes were left out the time would be programmed for 14 minutes 15 seconds AM. The colons between the hours, minutes and seconds are optional.

18. 18. Reset (R)

The letter R is the command that programs the Model 705 to reset conditions. The reset conditions are: all channels open and display the specified first channel.

Programming Example — Enter the following statements into the HP-85 to reset the Model 705.

```
REMOTE 717 (END LINE)
OUTPUT 717; "RX" (END LINE)
```

When the END LINE key is pressed the second time, the Model 705 goes to the reset condition.

NOTE

The first channel was set to 5 in a previous example. When the END LINE key is pressed the second time the Model 705 should display the following:

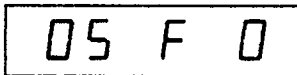

19. Set Time (S)

The letter S is the command to program the Model 705 to set the time. The format is as follows:

```
Shh:mm:ss
```

where S = Set Time Command
 h = Hours
 m = Minutes
 s = Seconds

Programming Example — Enter the following statements into the HP-85 to set the time to 5:00 pm.

```
REMOTE 717 (END LINE)
OUTPUT 717; "D2S17:00:00X" (END LINE)
```

When the END LINE key is pressed the second time, the Model 705 displays the time and sets it to 5:00 pm.

NOTE

When the format of the programmed time is not the full six digits (hh:mm:ss) the Model 705 truncates the time to what is programmed. If in this example the last four zeroes are left out the time would be programmed for 17 seconds not 5:00 pm. The colons between the hours, minutes and seconds are optional.

20. Trigger Modes (T)

The trigger commands control the stimulus to be used to start or stop Model 705 program operation. Basically, the

trigger stimulus controls instrument operation much like the front panel START/STOP button does, except that the trigger stimulus can control either start or stop (not both), depending on the selected trigger mode. Model 705 trigger modes are:

- T0 — Start on Talk
- T1 — Stop on Talk
- T2 — Start on GET
- T3 — Stop on GET
- T4 — Start on "X"
- T5 — Stop on "X"
- T6 — Start on External
- T7 — Stop on External

NOTES

1. In the step (manual) program mode, the instrument advances one channel location with each trigger stimulus.
2. When the instrument is triggered to start, program execution begins at the present channel location.

Programming Example — In the following programming example the Model 705 is programmed to scan channels 1 through 20 at a 500msec rate upon receiving an "X".

PROGRAM	COMMENTS
10 REMOTE 717 (END LINE)	Program the Model 705 into the remote mode.
20 CLEAR 7 (END LINE)	Clears the Model 705.
30 OUTPUT 717; "DOF1L20 W.5P2T4X" (END LINE)	Programs the Model 705 for display channel mode, Channel 1 as first channel, Channel 20 as last channel, Interval time as 500msec, continuous scan mode and start on "X" mode.
40 DISP "TO STOP PRESS CONT"	Displays the message.
50 PAUSE	Program pause.
60 OUTPUT 717; "T5X"	Programs Model 705 to stop on "X".
70 DISP "TO START PRESS CONT"	Displays the message.
80 PAUSE	Program pause.
90 CLEAR	Clears 705.
100 GO TO 20	Go to line 20.
110 END	End of program.

Press the RUN key on the Model 705 to start the program. After the RUN key is pressed the Model 705 scans channels 1 through 20 at the 500msec rate. The start on "X" command (T4) in line 30 programs the Model 705 to start the scan upon receiving an "X". In this program the talk command is provided immediately after T4. To stop the program press the CONT. key. To resume the program press the RUN key immediately after T4.

21. Set Date (V)

The letter V is the command to set the date. The format for the set date command is as follows:

Vmm:dd (American)
Vdd:mm (International)

Programming Example — Enter the following statements into the HP-85 to program the date for July 12th.

```
REMOTE 717 (END LINE)
OUTPUT 717; "V12:07X" (END LINE)
OUTPUT 717; "D2X" (END LINE)
```

When END LINE is pressed the second time, the Model 705 sets the date for July 12th in International format when the END LINE key is pressed the third time the date is displayed on the Model 705. For American format the second statement would be:

```
OUTPUT 717; "V07:12X" (END LINE)
```

The date (American or International) must appear in the statement as a four digit number. If three digits are used instead of four the Model 705 moves the three digits to the right by one place. For example, enter the following statement into the HP-85.

```
OUTPUT 717; "V123X" (END LINE)
```

When the END LINE key is pressed the date is set to 01.23 which is January 23rd in the American format. If two or less digits are used instead of four digits the Model 705 displays an IDDCO (Illegal Device Dependent Command Option) and does not change the present date. The colon between the month and day in the statement is optional.

22. Set Interval Time (W)

The letter W is the command to set the interval time in seconds. The maximum interval time is the programmed time for the channel to be closed. The format for the interval time command is as follows:

```
Wnnn.nnn
```

where W = Set Interval Time Command
n = Number of Seconds

Programming Example — Enter the following statements into the HP-85 to program the interval time to three seconds.

```
REMOTE 717 (END LINE)
OUTPUT 717; "W003.000X" (END LINE)
```

When the END LINE key is pressed the second time, the Model 705 sets the interval time to three seconds. To verify that the interval time has been set to three seconds send a D1 command. This is the command to display the interval time.

In the second statement the leading and trailing zeroes are optional. As long as the decimal point is entered in the appropriate place the leading and trailing zeroes are optional. The interval time format on the Model 705 display is always six digits.

23. Programmable Terminator (Y)

The Model 705 uses special terminator characters to mark the end of its data string. To allow a wide variety of controller's to be used, the terminator can be changed by sending the appropriate command over the bus. For more information and a programming example refer to paragraph 3.5.7.

24. Alternate Outputs (U)

The letter U is the command to program the Model 705 to transmit the status word, settling time, alarm time, interval

time or first/last channel data on talk. The alternate outputs can also transmit the U commands with or without a prefix. The commands are as follows:

U0 — Sending the U0 command outputs the present channel number. The present channel number can be sent with or without a prefix depending on the present prefix mode (G). Refer to the flowchart in Figure 3-6 for the sequence of sending the U and G modes. Refer to paragraph 3.5.8 step 7 for information concerning the prefix modes and their formats.

U1 — Sending the U1 command outputs all the channel numbers. All the channel numbers can be sent with or without a prefix depending on the present prefix mode (G). Refer to the flowchart in Figure 3-6 for the sequence of sending the U and G modes. Refer to paragraph 3.5.8 step 7 for information concerning the prefix modes and their formats.

U2 — Sending the U2 command outputs the digital I/O port status. The digital I/O port status can be sent with or without a prefix depending on the present prefix mode (G). Refer to the flowchart in Figure 3-6 for the sequence of sending the U and G modes. Refer to paragraph 3.5.8 step 7 for information concerning the prefix modes and their formats.

U3 — Sending the U3 command outputs the time and date. The time and date can be sent with or without a prefix depending on the present prefix mode (G). Refer to the flowchart in Figure 3-6 for the sequence of sending the U and G modes. Refer to paragraph 3.5.8 step 7 for information concerning the prefix modes and their formats.

U4 — Sending the U4 command outputs the status word. The status word can be sent with or without a prefix depending on the present prefix mode (G). Refer to the flowchart in Figure 3-6 for the sequence of sending the U and G modes. Refer to paragraph 3.5.8 step 7 for information concerning the prefix modes and their formats.

U5 — Sending the U5 command outputs the channel settling time. The channel settling time can be sent with or without a prefix depending on the present prefix mode (G). Refer to the flowchart in Figure 3-6 for the sequence of sending the U and G modes. Refer to paragraph 3.5.8 step 7 for information concerning the prefix modes and their formats.

U6 — Sending the U6 command outputs the alarm time. The alarm time can be sent with or without a prefix depending on the present prefix mode (G). Refer to the flowchart in Figure 3-6 for the sequence of sending the U and G modes. Refer to paragraph 3.5.8 step 7 for information concerning the prefix modes and their formats.

U7 — Sending the U7 command outputs the interval time. The interval time can be sent with or without a prefix depending on the present prefix mode (G). Refer to the flowchart in Figure 3-6 for the sequence of sending the U and G modes. Refer to paragraph 3.5.8 step 7 for information concerning the prefix modes and their formats.

U8 — Sending the U8 command outputs the programmed first and last channel. The programmed first and last channel can be sent with or without a prefix depending on the present prefix mode (G). Refer to the flowchart in Figure 3-6 for the sequence of sending the U and G modes. Refer to paragraph 3.5.8 step 7 for information concerning the prefix modes and their formats.

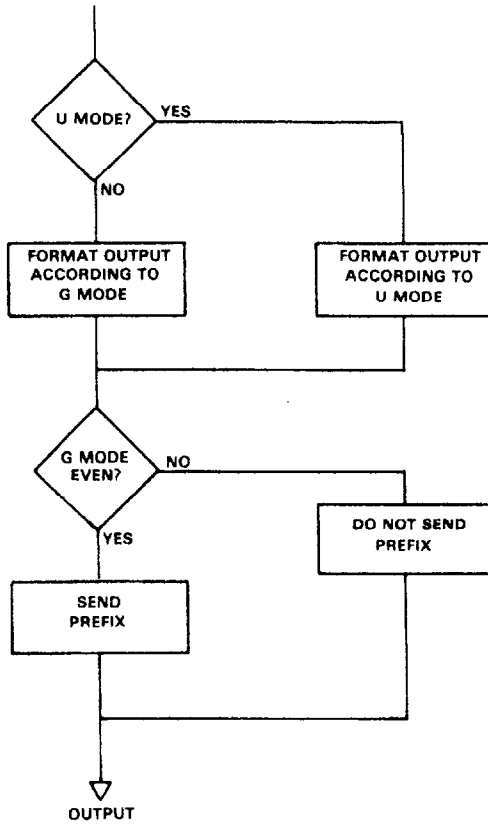

Figure 3-6. U and G Modes Sequence

3.6 STATUS BYTE FORMAT

The status byte contains information relating to data and error conditions within the instrument. The controller obtains the status byte by using the serial polling sequence (SPE) described paragraph 3.4.2. Once the byte resides in the computer, the information in Figure 3-7 can be used when interpreting data and error conditions.

Bit six is the SRQ bit. If this bit is set the service request was made by the Model 705. Bit five determines the meaning of bits zero through three. If bit five is set, the error conditions listed in Table 3-9 apply to bits zero through three. If bit five is cleared, the data conditions listed in the table apply.

To output the status byte in binary form (Figure 3-7) enter the following program into the HP-85.

PROGRAM	COMMENTS
10 REMOTE 717 (END LINE)	Programs the Model 705 into the remote mode.
20 S = SPOLL (717) (END LINE)	Start serial poll sequence.
30 DISPL "B7 B6 B5 B4 B3 B2 B1 B0" (END LINE)	Display contents of quotation marks.
40 FOR I=7 TO 0 STEP -1	Loop eight times.
50 DISP BIT (S,I);	Display status byte.
60 NEXT I	
70 DISP	
80 END	

Press the RUN key to start the program. After the RUN key is pressed the Model 705 outputs the status byte to the controller. The controller then displays the status byte in the form shown in Figure 3-7.

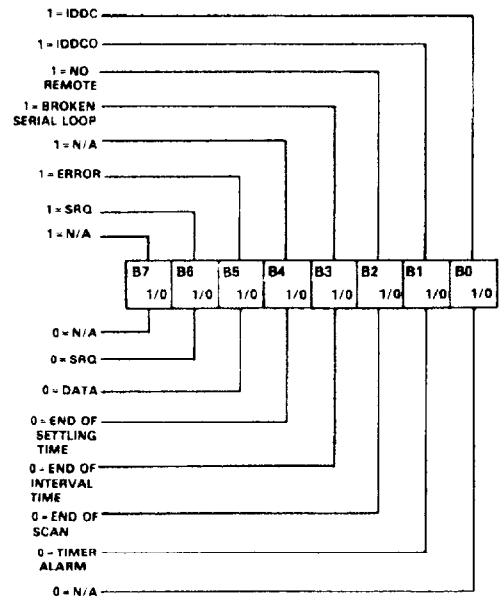

Figure 3-7. Status Byte Format

3.7 STATUS WORD (UO)

The status word commands allow access to information concerning various operating modes of the Model 705. The status word also contains information about the present status of the input and output lines on the digital I/O port. When the correct command is given, the Model 705 outputs the status word or I/O status the next time it is addressed to talk instead of sending its normal data string. Each byte in the status word is a number corresponding the previously programmed parameter with the following sequence:

705 A D E J K P T G M Y

Refer to Figure 3-8 for an example of the status word.
To output the status word enter the following program into the HP-85.

PROGRAM	COMMENTS
10 REMOTE 717 (END LINE)	Program the Model 705 into the remote mode.
20 CLEAR 7 (END LINE)	Clears the Model 705.
30 OUTPUT 717; "U4X" (END LINE)	Outputs status word.
40 ENTER 717; A\$ (END LINE)	Obtains data string.
50 DISP A\$ (END LINE)	Displays data string.
60 END (END LINE)	End of program.

Press the RUN key to implement the program. After pressing the RUN key the Model 705 outputs the status word. In this case the status word is transmitted to the controller with a prefix.

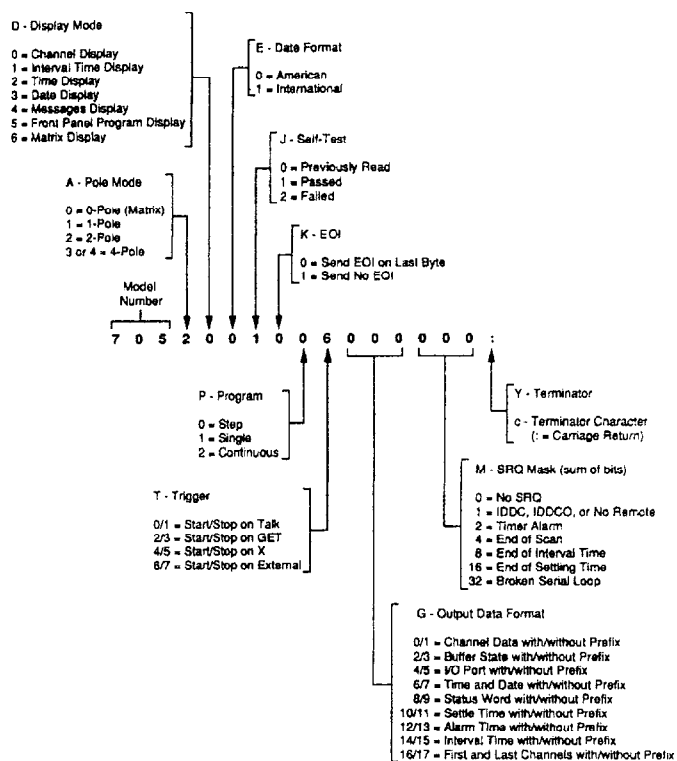

Figure 3-8. U4 Status Word (Reset conditions shown)

NOTES

1. SRQ status information contains three bytes. These three bytes assume the decimal value previously set by the SRQ mode command.
2. To make sure proper status is returned, the status word should be read immediately after sending the command. Otherwise, instrument status may be changed from the front panel, resulting in erroneous status information.

3. The status word should not be confused with the SRQ status byte. The status word contains a number of bytes pertaining to the various operating modes of the instrument. The status byte is a single byte that is read by using the serial poll sequence and contains information on SRQ status and error or data conditions.
4. The pole mode has precedence over the display mode when they are in contention. Attempting to set matrix pole mode (A0) and channel display mode (D0) will yield matrix pole mode and matrix display mode. The U4 status word will read (other bytes shown in reset conditions):

7050601006000000:

3.8 FRONT PANEL PROGRAMS

Table 3-8 outlines the front panel programs that are available to the IEEE-488 interface bus. All the front panel programs described in paragraph 2.6, except Programs 3, 90, 91 and 92 can be controlled over the bus. For detailed examples and explanations of the front panel programs refer to section 2.6.

3.9 FRONT PANEL ERROR MESSAGES

The process of programming the Model 705 involves the proper use of syntax. Syntax is defined as the orderly of systematic arrangement of programming commands or languages. The Model 705 must receive valid commands with proper syntax or it will:

1. Ignore the entire command string in which the invalid command appears.
2. Set appropriate bits in the status byte.
3. Generate an SRQ if programmed to do so.
4. Display an appropriate front panel error message.

Device-dependent commands are sent as a string of several ASCII characters. Some examples of valid command strings include:

- FOX — Single command string.
- F0Q1B2X — Multiple command string.
- B1 X — Space is ignored.

Examples of invalid command strings are:

- @0X — Invalid command; @ is not a command.
- D6X — Invalid command option; 6 is not an option of the D command.

The numbers after the command are each interpreted as a decimal integer. For example:

- T01.0X — interpreted as T1X.
- TX — Means TOX.

Figure 3-9 shows the front panel error messages used by the Model 705. The message in Figure 3-9(a) results from an illegal Device-Dependent Command (IDDC), while the message in Figure 3-9(b) results from an illegal Device-Dependent Command Option (IDDCO). The no remote message in Figure 3-9(c) results from attempting to program the instrument when it is not in the remote mode.

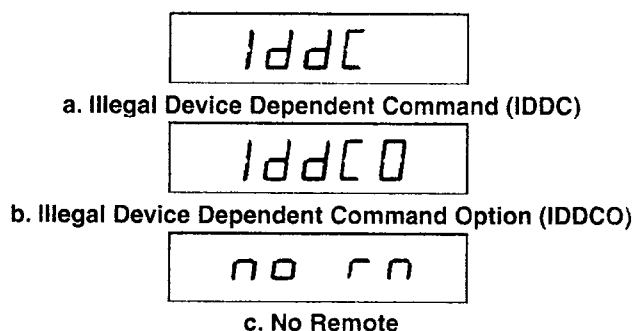

Figure 3-9. IEEE Display Error Message

3.9.1 IDDC Error

An IDDC error results when the Model 705 receives an invalid command such as \$X. This command is invalid because no such letter exists in the instrument's programming language.

Programming Example — To demonstrate an IDDC error, enter the following statements into the HP-85 keyboard:

```
REMOTE 717 (END LINE)
OUTPUT 717; "$X" (END LINE)
```

When END LINE is pressed the second time, the error message in Figure 3-9a is displayed for about one second.

3.9.2 No Remote Error

A front panel no remote error message will be displayed if the Model 705 is not in the remote mode when it receives a command over the bus. If an attempt is made to program the instrument when it is not in the remote mode, the no remote message in Figure 3-9c will be displayed on the front panel for about one second.

Programming Example — To make sure the instrument is not in the remote mode, enter the following statement into the HP-85:

```
LOCAL 7 (END LINE)
```

Now enter the following programming statement into the keyboard:

```
OUTPUT 717; "D1X" (END LINE)
```

When this statement is executed, the no remote error message in Figure 3-9c is displayed on the front panel of the instrument for about one second.

3.10 SCANNING PROGRAM

The following program sets the Model 705 for the following parameters.

1. Sets programmed first channel to 1.
2. Sets programmed last channel to 20.
3. Sets interval time to one second.
4. Sets the unit to the display mode.
5. Use the continuous scan mode.
6. Trigger the scan sequence on "X".
7. Provide a pause and clear statement.

Enter the following statements into the HP-85 to program the Model 705 to scan channels 1 through 20 at a one second interval rate.

PROGRAM	COMMENTS
10 REMOTE 717 (END LINE)	Sets the Model 705 to the remote mode.
20 CLEAR 7 (END LINE)	Clears the Model 705.
30 OUTPUT 717; "D0F1L20W1P2T4X" (END LINE)	Programs the Model 705 for the above parameters.
35 PAUSE (END LINE)	
40 ENTER 717; A\$ (END LINE)	Obtain data string.
50 DISP A\$ (END LINE)	Display data string.
60 PAUSE (END LINE)	Program pause.
70 CLEAR 7 (END LINE)	Clear 705.
80 END (END LINE)	End of program.

To start the program press the RUN key on the HP-85. After the RUN key is pressed the Model 705 scans the programmed channels at the programmed interval rate. To stop the program simply press the CONT key. The program will stop at the presently displayed channel when the CONT key is pressed. To resume the program press the CONT key a second time or press the RUN key. Upon pressing the RUN key or the CONT key (second time) the Model 705 continues the program from the presently displayed channel.

SECTION 4 THEORY OF OPERATION

4.1 INTRODUCTION

This section contains circuit descriptions of the Model 705. The information is arranged to provide a description of individual functional circuit blocks. To facilitate understanding, the descriptions are referenced to Figure 4-1, which is an overall block diagram of the Model 705. Detailed schematics of the Model 705 are located in Section 6.

4.2 POWER SUPPLY

To aid in the understanding of the following discussion, refer to the block diagram in Figure 4-1 and schematic diagram 705-106 sheet 1 of 3.

The power supply is a conventional AC to DC power converter. Transformer T101 has two secondaries that are wired together in series. CR101 is the traditional bridge rectifier and the output of CR101 is filtered by C106 and then fed to VR101. VR102 is a 3-terminal voltage regulator that outputs a well regulated +5V supply.

Battery BT101 is a 3.6V Nicad battery that is used to back up certain features of the Model 705 (date, time, etc). Q101, Q102 and associated circuitry are configured to provide further filtering. VR103 is a 3-terminal voltage regulator that outputs a well regulated +6V. The +6V supply exclusively powers the plug in scanner cards.

4.3 MICROCOMPUTER

To simplify understanding of the following discussion refer to the block diagram in Figure 4-1 and schematic diagram 705-106 sheet 3 of 3.

The microcomputer includes a 6808 microprocessing unit U120, a 6522 versatile interface adapter (VIA) U119, a 2732 and 2764 ROMs U122 and U123. The microcomputer also consists of two 2114 RAMs U124 and U125 an address decoder U112 (LS138) an asynchronous communication interface adapter (ACIA) U118 and assorted buffers and line drivers U117, U105, U106, U110, U111, U116, U126 and U127. The IEEE-488 interface circuitry consists of a 59914 general purpose interface bus adapter U107, a 75161 general purpose interface bus transceiver U108 and a 75160 general purpose bus transceiver. The memory used in this system is shown in the memory map Figure 4-2. Using address lines A13, A14 and A15, U112 sections the 64k of memory space into 8k segments. Interfacing of the microprocessor with the RAMs, ROMs, Front Panel, VIA, ACIA or IEEE-488 interface circuitry is controlled by the address decoder, U112.

Partial address decoding is used in this system. The function selected is determined by the state of the A13, A14 and A15

address lines. These address lines determine which output is selected by the decoder U112 in accordance with the memory map. Only one of these devices (RAM, ROM, VIA, ACIA etc.) will have access to the data bus at any time. The address decoder selects one of the devices only after a valid memory address (VMA) has been asserted at the decoders input G1 (pin 6). The VMA signal is generated by the 6808 microprocessor.

MEMORY ADDRESS IN HEX		PART
0000	1k RAM	2114
1FFF 2000		2732
3FFF 4000	FUTURE EXPANSION ROM	—
5FFF 6000	SERIAL PORT FOR DAISY CHAIN	ACIA
7FFF 8000	I/O, TIMER	VIA
9FFF A000	IEEE	9914
BFFF C000	SWITCH PORT	74LS244
DFFF E000	8k ROM	2764
FFFF	4k ROM	2732

Figure 4-2. Memory Map

Timing for the computing sequences is provided by 4MHz crystal Y102. The 6808 microprocessor divides this signal by four to produce a 1MHz signal at the E (pin 37) output. This is a single phase, TTL compatible clock. The clock may be conditioned by a memory read signal. This output is capable of driving one standard TTL load and 130pF.

U103 A, B, C and D, CR102, CR103 and associated circuitry form a reset network which resets the microprocessor, VIA, ACIA and IEEE-488 interface. The circuit actuates in the event the front panel display is not updated after a specific period of time (e.g. interval time) has elapsed due to a lost program or power line transient.

As seen in schematic 705-106 sheet 3 of 3, the data lines running throughout the microcomputer circuitry are labeled as D0 through D7. The address lines running throughout the microcomputer circuitry are labeled as A0 through A15.

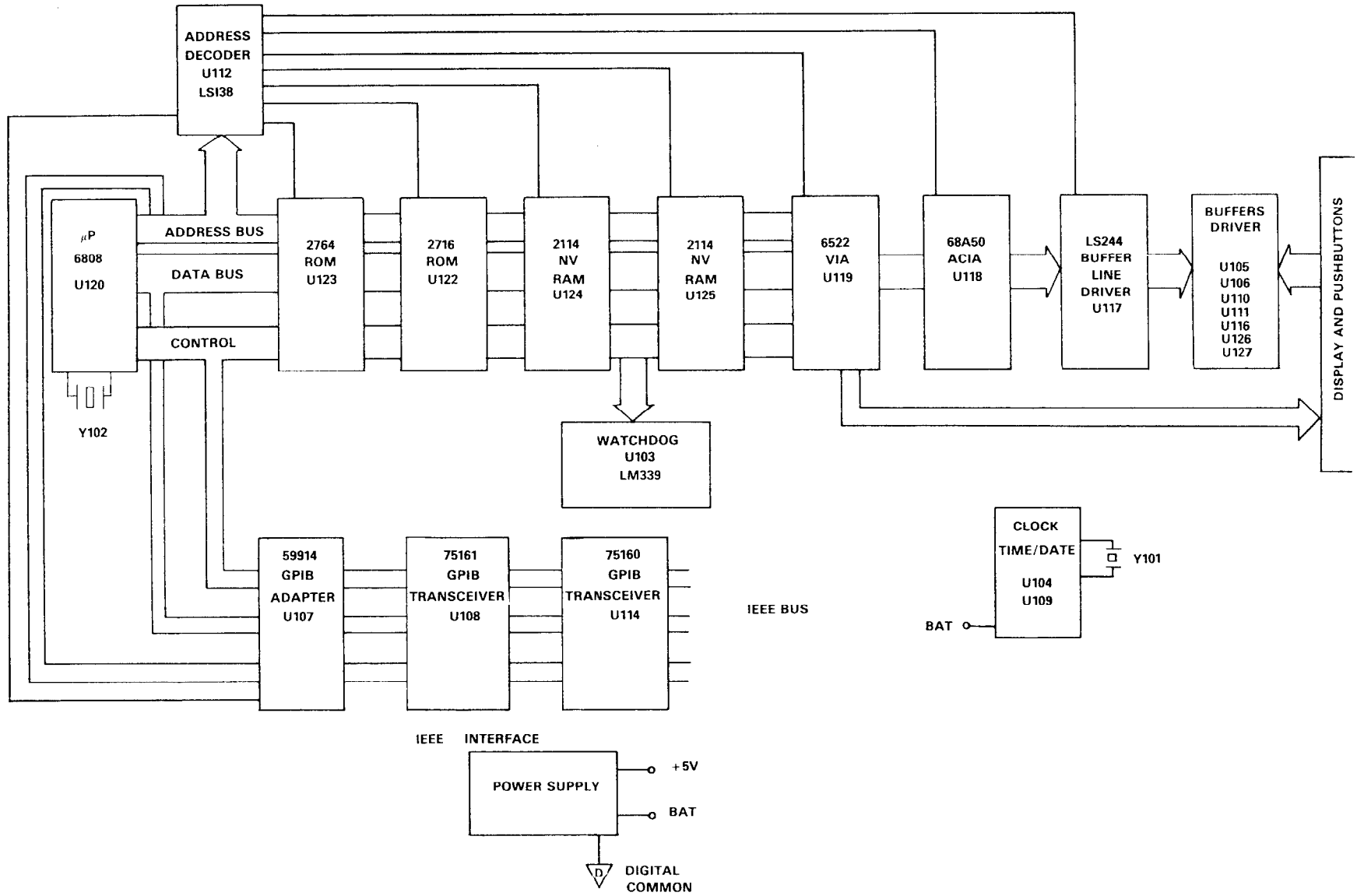

Figure 4-1. Model 705 Block Diagram

The serial out and alarm/serial in outputs are controlled by the ACIA (U118). R123, R124 and CR105 comprise a protection network for these two outputs. The serial out output data is transmitted via R124 and pin 6 of the ACIA (U118). The alarm/serial in data is transmitted/received via R123 and pin 2 of the ACIA (U118). The external trigger input and channel ready output are controlled by the VIA (U119). R121, R122 and CR104 comprise a protection circuit for these two outputs. While R126 is a pull up resistor for the external trigger line. The external trigger input is routed into the circuitry via R121 and pin 40 of the VIA (U119). The channel ready output produces a TTL level negative going pulse of greater than 2 μ sec by way of R122 and pin 15 of the VIA (U119) when programmed to do so.

The control of the relay switching is accomplished by serial to parallel conversion involving shift registers U106, U111 and U127. Also involved are drivers (darlington transistor arrays) U105, U110, U116 and U126. The serial data is clocked into the shift registers by the clock line and the data line from the VIA (U119 pins 18 and 19 respectively). Once the serial data is clocked into the shift registers it does not appear on the outputs of the register until they receive a strobe pulse. The strobe pulse is generated by the BCD to decimal decoder U102. When the fully loaded register receives the strobe pulse the data is outputted simultaneously into the respective drivers (U126, U116, U110 and U105). The drivers provide the necessary current boost while not altering the data and then output the parallel data to the card cage connector (J1011). The scanner cards are plugged into the appropriate slots in connector J1011, and the necessary control to the relays is provided through that connector.

The time and date are kept internally by a battery backed up clock that is comprised of crystal Y101, NAND gates U109 A, B, C and D, shift register U104, clock chip U101 and associated circuitry. The timing is provided by the 32.768kHz crystal Y101.

4.4 DISPLAY CIRCUIT

The display data is outputted on PA0 through PA7 from the VIA (U119) by way of connector J1010. The data is updated at a 1kHz rate which means each digit is on for 1msec. Each update begins by presenting new segment information on the VIA (I/O) bus (PA0-PA7) and outputting a clock pulse on CA2. The clock pulse inputs to U203 and shifts a digit enable bit to the next digit to be enabled. Every eight times the display is updated, a digit enable bit is generated at PB3 and is routed to the enable data input of the shift register.

The first four digit drivers drive the rows of the switch matrix. The switches are arranged in a four by six matrix. The segment drivers are Q201 through Q208. In addition to driving the various segments, they also activate the appropriate LEDs.

4.5 IEEE-488 INTERFACE CIRCUITRY

The IEEE-488 interface circuitry is comprised of GPIB adapter (U107), GPIB octal transceiver (U108) and GPIB octal transceiver (U114) and associated capacitors. The standard bus connector (J1002) is located on the rear panel. The primary address is set from front panel program number 3. There are no primary address dip switches. Refer to paragraph 2.6.4 for complete details concerning the primary address.

GPIB adapter U107 is the heart of IEEE-488 interface circuitry. U107 is capable of performing all IEEE-488 talk/listen protocols. The data bus consists of D0 through D7. The address lines that are routed to the IEEE-488 circuitry are A0, A1 and A2. The REN, IFC, NDAC, NRFD, DAV, EOI, ATN and SRC lines are all controlled by U107. Before the data is transmitted to the IEEE-488 bus via connector J1002 it is buffered by the octal bus transceivers U108 and U114. The REN, IFC, EOI lines etc., are buffered by U114. U108 and U114 operate on the tri-state output principle. That is, the output is either High, Low or in a high impedance state.

SECTION 5 MAINTENANCE

5.1 INTRODUCTION

This section contains information necessary to maintain the Model 705 Scanner. The information in this section includes fuse replacement, line voltage selection, disassembly instructions and troubleshooting information.

5.2 FUSE REPLACEMENT

If power fails, first verify that the fuse (F101) is not defective before disassembling the Model 705. If the line voltage setting is changed (S102) the fuse must be replaced according to Tables 5-1 and 5-2. The fuse is accessible from the rear panel. To replace the fuse proceed as follows:

1. Turn power off and disconnect the line cord.

WARNING

To prevent a shock hazard, always turn the instrument off and disconnect the line cord before replacing the line fuse.

2. The fuse carrier is spring loaded. Using a slotted screwdriver, push the fuse carrier in and rotate 1/4 turn counterclockwise. The carrier and fuse will eject from the hold.
3. Remove the fuse from the carrier and replace per Table 5-1 or Table 5-2.

CAUTION

Do not install a fuse with a higher rating than specified in Table 5-1 or 5-2. Instrument damage may result.

4. To install the fuse and carrier into the holder, reverse the procedure in step 2.

Table 5-1. Fuse Replacement 3AG Size

Line Voltage	Fuse (F101)	Keithley Part Number
90V-110V*	3/16A, 250V, SLO-BLO	FU-29
105V-125V	3/16A, 250V, SLO-BLO	FU-29
180V-220V*	1/10A, 250V, SLO-BLO	FU-40
210V-250V	1/10A, 250V, SLO-BLO	FU-40

*Requires special factory installed transformer.

Table 5-2. Fuse Replacement 5mm Size

Line Voltage	Fuse (F101)	Keithley Part Number
90V-110V*	2/10A, 250V, SLO-BLO	FU-32
105V-125V	2/10A, 250V, SLO-BLO	FU-32
180V-220V*	1/10A, 250V, SLO-BLO	FU-31
210V-250V	1/10A, 250V, SLO-BLO	FU-31

*Requires special factory installed transformer.

5.3 LINE VOLTAGE SELECTION

Set up the Model 705 to operate on the available AC line voltage as follows:

WARNING

To prevent a shock hazard, always turn the instrument off and disconnect the line cord before removing the top cover.

1. Remove the top cover (see paragraph 5.4).
2. Set switch S102 (located at the rear of the mother board) according to Table 5-3.
3. Install proper fuse per paragraph 5.2.

NOTE

The line voltage setting of the instrument is marked on the rear panel. The following procedure can be used either to confirm the factory setting, or to set up the instrument for operating on another voltage range. If the line voltage range is changed, the box next to the selected line voltage should be appropriately marked as an external reminder of the setting. Use a water soluble marking pen.

Table 5-3. Line Voltage Selection

Line Voltage	Line Frequency	Switch (S102)
90V-110V*	50Hz-60Hz	115V
105V-125V	50Hz-60Hz	115V
180V-220V*	50Hz-60Hz	230V
210V-250V	50Hz-60Hz	230V

*Requires special factory installed transformer.

5.4 DISASSEMBLY

If it is necessary to remove or replace, a component, use the following procedure to aid in disassembly of the Model 705. Also refer to Figure 5-1.

1. Remove the top cover as follows:

WARNING

To prevent a shock hazard, always turn the instrument off and disconnect the line cord before removing the top cover.

- A. Remove the top two retaining screws located at the rear of the instrument.
- B. Grasping the top cover at the rear, carefully lift it off of the instrument.
- C. When installing the top cover, make sure that the three tabs located at the front of the cover engage in the front

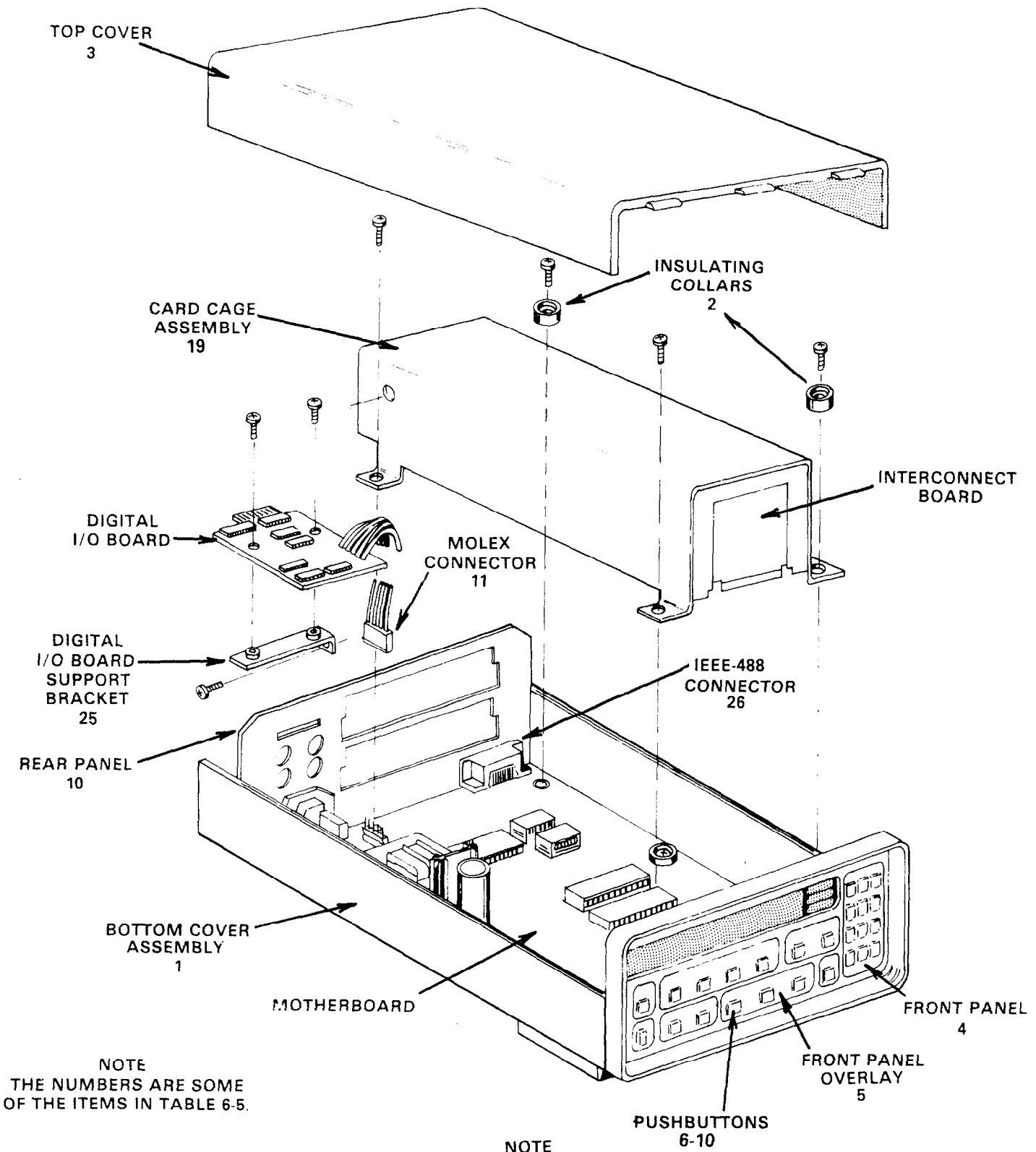

Figure 5-1. Model 705 Exploded View

- panel assembly.
2. Remove the plug-in cards (see paragraph 2.2.2).
 3. Remove the digital I/O board as follows:
 - A. Remove the two retaining screws located on the digital I/O board.
 - B. Unplug the digital I/O board from the mother board and lift it out of the instrument.
 - C. When reinstalling the digital I/O board, make sure the digital I/O connector is insulated from the rear panel.
 4. Remove the plug-in card shield assembly as follows:
 - A. Remove the metal support for the digital I/O board.
 - B. Remove the four screws that secure the shield assembly to the mother board.

NOTE

The screw located underneath the metal support for the digital I/O board also connects the shield to the rear panel (chassis ground).

- C. Lift the shield assembly out of the instrument.
- D. When reinstalling the shield assembly make sure that the connections to the rear panel (chassis ground) is made.
5. Remove the mother board from the bottom cover as follows:
 - A. Remove the remaining four screws that secure the mother board to the bottom cover.
 - B. Remove the bottom two screws on the rear panel that secure the rear panel to the bottom cover.
 - C. Disconnect the ribbon cable that connects the display board to the mother board.
 - D. Grasp the rear panel and the mother board and gently lift the mother board toward the rear of the instrument. Then lift the mother board and rear panel out of the bottom cover.
 - E. When reinstalling the mother board into the bottom cover make sure that pin one of the ribbon cable that connects the display to the mother board is connected to pin one of the mother board connector.
6. Remove the display board from the front panel as follows:
 - A. Remove the front panel buttons.
 - B. Remove the two screws that secure the display board to the front panel.
 - C. Lift the display board out of the instrument.
7. To reassemble the Model 705 reverse the procedures outlined in steps one through six.

5.5 TROUBLESHOOTING

Troubleshooting information will be added later as a supplement to this manual.

5.6 DIGITAL SELF TEST

Upon power-up the Model 705 performs a number of tests and displays several messages. These tests and messages are explained in paragraph 2.3. The Model 705, also upon power-up, and upon activating program 99 performs a digital self test on the RAM circuitry and a cyclic redundancy check (CRC) on the ROM circuitry. If the digital self test of the RAM circuitry

reveals a problem the Model 705 displays the following:

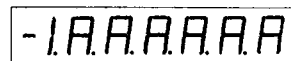

This display indicates that there is a problem with the Model 705's RAM circuitry.

If the CRC reveals a problem the Model 705 displays the following:



This display indicates that there is a problem with the Model 705's ROM circuitry. In either of these two cases, the Model 705's memory circuitry should be checked. The cause of the problem could be that a memory chip is loose in the socket.

Upon actuation of front panel program 8 the Model 705 performs a digital self test and a CRC of the RAM and ROM circuitry respectively. If the digital self test reveals a problem with the RAM circuitry the Model 705 displays the following for approximately 0.5 seconds.

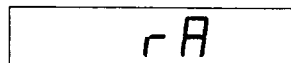

After this display the Model 705 displays the following:

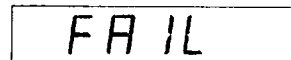

If the CRC reveals a problem with the ROM circuitry the Model 705 displays the following for approximately 0.5 seconds.

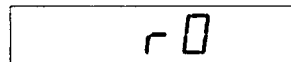

After this display the Model 705 displays the following:

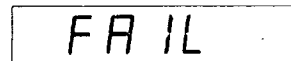

If the self test and the CRC both reveal a problem, the Model 705 displays the RAM and ROM error messages and then displays the failed message.

When either test does not reveal a problem (using program 8) the Model 705 displays the following message that indicates both tests have passed.



5.7 BATTERY CHARGE

The battery backed up functions (Time, Date, Interval etc.) are powered by BT101 and its associated circuitry when the Model 705 is turned off. The retention time of the battery backed up functions and data is typically one month with the unit turned off. The battery is on a trickle charge while the unit is turned on. To fully charge the battery it takes approximately two weeks (8 hours a day) of normal operation.

SECTION 6 REPLACEABLE PARTS

6.1 INTRODUCTION

This section contains replacement parts information, schematic diagrams, and component location drawings for the Model 705.

6.2 PARTS LIST

Parts are listed alpha-numerically in order of their circuit designations. Table 6-1 contains an index of the schematic diagrams and component location drawings included at the end of this section. Table 6-2 contains a parts list for the display board. Table 6-3 contains a parts list for the mother board. Table 6-4 contains a parts list for the digital I/O board. Table 6-5 contains a mechanical parts list for the Model 705.

6.3 ORDERING INFORMATION

To place an order, or to obtain information concerning replacement parts, contact your Keithley representative or the factory. See the inside front cover for addresses. When ordering include the following information:

1. Instrument Model Number
2. Instrument Serial Number
3. Part Description
4. Circuit Description (if applicable)
5. Keithley Part Number

6.4 FACTORY SERVICE

If the instrument is to be returned to the factory for service, complete the service form which follows this section and return it with the instrument.

6.5 SCHEMATIC DIAGRAMS AND COMPONENT LOCATION DRAWINGS

Schematic diagrams and component location drawings follow the replaceable parts list information in the order listed in Table 6-1.

Table 6-1. Index of Model 705 Schematics and Component Layouts

Figure	Title	Page
6-1	Interconnect Board, Component Location Drawing	6-7
6-2	Display Board, Component Location Drawing	6-9
6-3	I/O Board, Component Location Drawing	6-11
6-4	Mother Board, Component Location Drawing	6-13
6-5	Mother Board, Schematic Diagram	6-17
6-6	Display Board, Schematic Diagram	6-23
6-7	I/O Board, Schematic Diagram	6-25
6-8	Interconnect Board, Schematic Diagram	6-27

Table 6-2. Display Board 705-110, Parts List

Circuit Designation	Description	Location		Keithley Part No.
		Sch	PCB	
C201	10 μ F, 25V, Aluminum Electrolytic	D6	C3	C-314-10
C202	1000pF, 1000V, Ceramic Disc	C5	C3	C-64-1000p
DS201	1, Digital Display	B1	B1	DD-31
DS202	"8" Digital Display	C2	B1	DD-30
DS203	"8" Digital Display	C2	C1	DD-30
DS204	"8" Digital Display	D2	C1	DD-30
DS205	"8" Digital Display	D2	D1	DD-30
DS206	"8" Digital Display	E2	D1	DD-30
DS207	"8" Digital Display	E2	D1	DD-30
DS208	Pilot Light	G4	E1	PL-67
DS209	Pilot Light	G3	E2	PL-67
DS210	Pilot Light	F2	E2	PL-67
DS211	Pilot Light	G4	B2	PL-67
DS212	Pilot Light	G4	E2	PL-67
DS213	Pilot Light	G4	E2	PL-67
DS214	Pilot Light	G4	C3	PL-67
DS215	Pilot Light	H3	D3	PL-67
DS216	Pilot Light	G3	D3	PL-67
DS217	Pilot Light	H4	E3	PL-67
R201	Thick Film Resistor Network	SEV	D2	TF-165-1
R202	Thick Film Resistor Network	SEV	F1	TF-77
S201	Switch	A3	B2	SW-435
S202	Switch	B3	B2	SW-435
S203	Switch	B3	C2	SW-435
S204	Switch	A3	D2	SW-435
S205	Switch	A3	D2	SW-435
S206	Switch	B4	E2	SW-435
S207	Switch	B4	E2	SW-435
S208	Switch	A4	B3	SW-435
S209	Switch	A4	C3	SW-435
S210	Switch	B4	D3	SW-435
S211	Switch	B4	D3	SW-435
S212	Switch	A4	E3	SW-435
S213	Switch	A4	E3	SW-435
S214	Switch	B5	F2	SW-435
S215	Switch	B5	F2	SW-435
S216	Switch	A5	G2	SW-435
S217	Switch	A5	F2	SW-435
S218	Switch	A3	F2	SW-435
S219	Switch	B3	G2	SW-435
S220	Switch	B3	F3	SW-435
S221	Switch	A2	F3	SW-435
S222	Switch	A2	G3	SW-435
S223	Switch	B2	F3	SW-435
S224	Switch	B2	F3	SW-435
S225	Switch	A2	G3	SW-435
Q201	PNP, Silicon Transistor, 2N4355	F5	E1	TG-90
Q202	PNP, Silicon Transistor, 2N4355	H5	E1	TG-90
Q203	PNP, Silicon Transistor, 2N4355	H5	E2	TG-90
Q204	PNP, Silicon Transistor, 2N4355	H5	E2	TG-90
Q205	PNP, Silicon Transistor, 2N4355	F5	E2	TG-90
Q206	PNP, Silicon Transistor, 2N4355	G5	E2	TG-90
Q207	PNP, Silicon Transistor, 2N4355	G5	E2	TG-90
Q208	PNP, Silicon Transistor, 2N4355	G5	E2	TG-90
U201	Mos to LED Segment Driver, 75492	SEV	B3	IC-169
U202	Mos to LED Segment Driver, 75492	SEV	C3	IC-169
U203	8-bit Shift Register, 74LS164	SEV	D3	IC-127

Table 6-3. Mother Board 705-103, Parts List

Circuit Designation	Description	Location		Keithley Part No.
		Sch	PCB	
BT101	3.6V, 100mAH Nicad	E3	C1	BA-36
C101	10pF, 1000V, Ceramic Disc	E1	A2	C-64-10p
C102	22pF, 1000V, Ceramic Disc	E1	A2	C-64-22p
C103	1.5μF, 25V, Aluminum Electrolytic	D3	B2	C-314-1.5
C104	1.5μF, 25V, Aluminum Electrolytic	D4	B2	C-314-1.5
C105	4.7μF, 25V, Aluminum Electrolytic	F3	C2	C-314-4.7
C106	10,000μF, 25V, Aluminum Electrolytic	D2	D2	C-342-10,000
C107	.1μF, 50V, Ceramic Film	F2	C2	C-237-.1
C108	NOT USED			
C109	.1μF, 50V, Ceramic Film	E2	A2	C-237-.1
C110	.1μF, 50V, Ceramic Film	B4	B2	C-237-.1
C111	.1μF, 50V, Ceramic Film	G5	B2	C-237-.1
C112	.1μF, 50V, Ceramic Film	G4	B2	C-237-.1
C113	NOT USED			
C114	.1μF, 50V, Ceramic Film	F5	B3	C-237-.1
C115	NOT USED			
C116	10μF, 25V, Aluminum Electrolytic	E4	C3	C-314-10
C117	.1μF, 50V, Ceramic Film	G4	F3	C-237-.1
C118	1000pF, 1000V, Ceramic Disc	D2	A4	C-64-1000p
C119	.1μF, 50V, Ceramic Film	D6	A4	C-237-.1
C120	10μF, 25V, Aluminum Electrolytic	F6	A4	C-314-10
C121	.1μF, 50V, Ceramic Film	E6	B4	C-237-.1
C122	NOT USED			
C123	NOT USED			
C124	.1μF, 50V, Ceramic Film	G1	E4	C-237-.1
C125	.1μF, 50V, Ceramic Film	G6	E4	C-237-.1
C126	.1μF, 50V, Ceramic Film	G6	F4	C-237-.1
C127	.1μF, 50V, Ceramic Film	E2	F4	C-237-.1
C128	.1μF, 50V, Ceramic Film	E6	A5	C-237-.1
C129	.1μF, 50V, Ceramic Film	D6	B4	C-237-.1
C130	.1μF, 50V, Ceramic Film	C6	B4	C-237-.1
C131	.1μF, 50V, Ceramic Film	C5	C5	C-237-.1
C132	.1μF, 50V, Ceramic Film	D5	C5	C-237-.1
C133	33pF, 1000V, Ceramic Disc	A4	D5	C-64-33p
C134	.1μF, 50V, Ceramic Film	F3	D5	C-237-.1
C135	.1μF, 50V, Ceramic Film	A1	D5	C-237-.1
C136	33pF, 1000V, Ceramic Disc	A4	D5	C-64-33p
C137	.1μF, 50V, Ceramic Film	C3	D5	C-237-.1
C138	.1μF, 50V, Ceramic Film	B3	E5	C-237-.1
C139	.1μF, 50V, Ceramic Film	D3	E5	C-237-.1
C140	NOT USED			
C141	NOT USED			
C142	.1μF, 50V, Ceramic Film	D4	C5	C-237-.1
CR101	Rectifier, 5A, PEO5	D2	B1	RF-48
CR102	Diode, Silicon, 1N914	D3	B2	RF-28
CR103	Diode, Silicon, 1N914	D3	B2	RF-28
CR104	Bridge Rectifier, VM18	E6	C3	RF-52
CR105	Bridge Rectifier, VM18	B3	C3	RF-52
CR106	Diode, Silicon, 1N914	B3	D3	RF-28
J1001	AC Receptacle	B3	G2	CS-388
J1002	24 pin right angle mount connector	SEV	G5	CS-377
J1003	BNC, Female	E6		CS-249
J1004	BNC, Female	D6		CS-249
J1007	5 pin Molex	SEV	G2	CS-288-5
J1009	5 pin Molex	G3	F2	CS-288-5
J1011		SEV	B3	CS-454-3
Q101	NPN, Silicon Transistor, 2N3904	E3	C1	TG-47
Q102	PNP, Silicon Transistor, 2N3906	F3	C1	TG-84

Table 6-3. Mother Board 705-103, Parts List (Cont.)

Circuit Designation	Description	Location		Keithley Part No.
		Sch	PCB	
R101	10k, 5%, 1/4W, Composition	E2	B2	R-76-10k
R102	10k, 5%, 1/4W, Composition	D2	B2	R-76-10k
R103	10k, 5%, 1/4W, Composition	D1	B2	R-76-10k
R104	10k, 5%, 1/4W, Composition	D1	B2	R-76-10k
R105	24k, 5%, 1/4W, Composition	D3	B2	R-76-24k
R106	10k, 5%, 1/4W, Composition	D3	B2	R-76-10k
R107	150Ω, 5%, 1/4W, Composition	F3	C2	R-76-150Ω
R108	1k, 5%, 1/4W, Composition	F3	C2	R-76-1k
R109	15k, 5%, 1/4W, Composition	E3	C2	R-76-15k
R110	4.7k, 5%, 1/4W, Composition	E3	C2	R-76-4.7k
R111	10k, 5%, 1/4W, Composition	D4	C2	R-76-10k
R112	10k, 5%, 1/4W, Composition	D4	C2	R-76-10k
R113	10k, 5%, 1/4W, Composition	D5	C2	R-76-10k
R114	10k, 5%, 1/4W, Composition	D4	C2	R-76-10k
R115	10k, 5%, 1/4W, Composition	D4	C2	R-76-10k
R116	1k, 5%, 1/4W, Composition	D4	C3	R-76-1k
R117	10k, 5%, 1/4W, Composition	E4	C3	R-76-10k
R120	220k, 5%, 1/4W, Composition	D2	D3	R-76-220k
R121	100Ω, 5%, 1/4W, Composition	D6	D3	R-76-100Ω
R122	100Ω, 5%, 1/4W, Composition	E6	D3	R-76-100Ω
R123	100Ω, 5%, 1/4W, Composition	C6	D3	R-76-100Ω
R124	100Ω, 5%, 1/4W, Composition	C6	D3	R-76-100Ω
R125	3.3k, 5%, 1/4W, Composition	B3	D3	R-76-3.3k
R126	3.3k, 5%, 1/4W, Composition	D6	D3	R-76-3.3k
R127	3.3k, 5%, 1/4W, Composition	B3	D3	R-76-3.3k
R128	3.3k, 5%, 1/4W, Composition	B3	D3	R-76-3.3k
R129	3.3k, 5%, 1/4W, Composition	B2	D3	R-76-3.3k
R130	100k, 5%, 1/4W, Composition	F1	F3	R-76-100k
R131	Thick Film Resistor Network	SEV	B4	TF-99
R132	33Ω, 10%, 2W, Composition	E1	C2	R-3-33
R133	3.3k, 5%, 1/4W, Composition	G4	F5	R-76-3.3k
R134	10k, 5%, 1/4W, Composition	F1	F3	R-76-10k
R135	10k, 5%, 1/4W, Composition	D2	A4	R-76-10k
S101	Switch, Pushbutton	C1	A1	SW-426
S102	Switch, Slide	B3	F1	SW-397
T101	Transformer	C2	E2	TR-195
U101	Clock/Calendar, UPD 1990 AC	E2	A2	IC-330
U102	BCD to Decimal Decoder, 4028	B4	B2	IC-135
U103	Op Amp, LM339	SEV	B2	IC-219
U104	8 stage shift register, 14094	C2	A3	IC-251
U105	Darlington Transistor Array, ULN2003	F5	B3	IC-206
U106	8 stage shift register, 14094	F4	B3	IC-251
U107	GPIO Adapter, 9914	G5	E3	LSI-49
U108	GPIO Octal Transceiver, SN75161	G4	F3	IC-299
U109	Quad 2 input NAND, 4011	SEV	A3	IC-102
U110	Darlington Transistor Array, ULN2003	E5	B3	IC-206
U111	8 stage shift register, 14095	E4	B3	IC-251
U112	Decoder/Demultiplexer, 74LS138	C1	D4	IC-182
U113	Quad 2 input NAND, 74LS00	SEV	E4	IC-163
U114	Octal GPIO Transceiver, SN75160	G5	F4	IC-298
U115	Quad Bi-lateral Switch, 4066	E1	F4	IC-149
U116	Darlington Transistor Array, ULN2003	E6	B4	IC-206
U117	Octal Buffer/Line Driver, 74LS244	C5	B4	IC-230
U118	ACIA 68A50	D5	C4	LSI-54
U119	VIA, SY6522	E5	C4	LSI-28
U120	Microprocessor 6808	A2	D4	LSI-27
U121	Future, Expansion ROM	C2	D4	Not Used
U122	U.V ROM, 2716	B2	E4	705-800-B5
U123	PROM, 2764	D2	E4	705-800-B5
U124	CMOS RAM 2114	E2	F4	LSI-53

Table 6-3. Mother Board 705-103, Parts List (Cont.)

Circuit Designation	Description	Location		Keithley Part No.
		Sch	PCB	
U125	CMOS RAM 2114	F2	F4	LSI-53
U126	Darlington Transistor Array, ULN2003	D5	B5	IC-206
U127	8 stage shift register, 14094	D4	B5	IC-251
J1010	16 pin dip socket	E6	A4	SO-65
VR102	+ 5V Voltage Regulator, 7805	E2	C1	IC-93
	Heat Sink for VR102		D2	HS-25
VR103	Voltage Regulator, 6V, LM7806	B2	D2	IC-64
	Heat Sink for VR103	—	D2	HS-25
Y101	32.768kHz, Crystal	E1	A2	CR-20
Y102	4MHz, Crystal	A3	D5	CR-10
	Fuse Holder	—	G3	FH-21
	Fuse Holder	—	H3	FH-25
	Fuse Holder	—	H3	FH-26
F101	Fuse, 3/16A, 250V, Slo-Blo, 3AG	A3	G3	FU-29
F101	Fuse, 1/10A, 250V, Slo-Blo, 3AG	A3	G3	FU-40
F101	Fuse, 2/10A, 250V, Slo-Blo, Miniature	A3	G3	FU-32
F101	Fuse, 1/10A, 250V, Slo-Blo, Miniature	A3	G3	FU-31
	Lug, Crimp	—	G2	LU-88

Table 6-4. Digital I/O Board 706-173 Parts List

Circuit Designation	Description	Location		Keithley Part No.
		Sch	PCB	
C301	.1 μ F, 50V, Ceramic Film	E3	C3	C-237-.1
C302	.1 μ F, 50V, Ceramic Film	E2	D3	C-237-.1
C303	.1 μ F, 50V, Ceramic Film	E1	D3	C-237-.1
CR301	Bridge Rectifier, 1A, VM18	D4	C2	RF-52
CR302	Bridge Rectifier, 1A, VM18	D4	C2	RF-52
CR303	Bridge Rectifier, 1A, VM18	E4	D2	RF-52
CR304	Bridge Rectifier, 1A, VM18	D4	D2	RF-52
Q301	NPN, Transistor, 2N3904	B2	C3	TG-47
R301	2.2k, 5%, 1/4W, Composition	C2	C2	R-76-2.2k
R302	5.1k, 5%, 1/4W, Composition	B2	B2	R-76-5.1k
R303	Thick Film Resistor Network	SEV	SEV	TF-39
R304	Thick Film Resistor Network	SEV	SEV	TF-141
R305	Thick Film Resistor Network	SEV		TF-90
R306	68 Ω , 10%, 1/2W, Composition	F1		R-1-68
U301	8 stage shift register, 14094	D3	C3	IC-251
U302	Hex Inverter, 74LS04	SEV	C2	IC-186
U303	Hex Inverter, 74LS04	SEV	C2	IC-186
U304	Quad 2 Input NOR, 74LS02	SEV	C3	IC-179
U305	8 stage shift register, 4021	SEV	D3	IC-130
P1009	5 pin Molex connector	—	B3	CS-287-5
	Female pins for P1009	—	B3	CS-276

Table 6-5. Model 705 Mechanical Parts List

Item	Description	Keithley Part No.
1	Bottom Cover Assembly (contains a through e)	30813
a.	Bottom Cover	30541
b.	Tilt Bail	30544
c.	Tilt Bail Trim Insert	30587
d.	Drive Pin	FA-143-1
e.	Foot (4 per unit)	FE-14
2	Insulating Collar (6 per unit)	30545
a.	#6-32 x 3/8 Phil. Pan Head Screw (6 per unit)	
3	Top Cover	30540
4	Front Panel	220-304
5	Front Panel Overlay	705-305
6	Pushbutton, Yellow Brown (1 per unit)	31470-4
7	Pushbutton, Light Brown (6 per unit)	31470-5
8	Pushbutton, Brown (6 per unit)	31470-6
9	Pushbutton, Dark Brown (12 per unit)	31470-7
10	Pushbutton, Red (1 per unit)	29465-3
11	Rear Panel	705-303
12	Connector (5 pin Molex)	CS-287-5
a.	Contact (5 per connector)	CS-276
13	Lug	LU-100
14	BNC connector (Female) (rear panel 4 per unit)	CS-249
15	Bushing (rear panel)	BU-19
16	Washer (rear panel)	WA-12
17	#8 32 x 1/4 Phil Pan Head Screw (4 per unit) (Rear panel to case.)	
18	Line Cord	CO-7
19	Card Cage Assembly	705-308
20	Shield	705-311
21	#4 x 3/16 Phil Pan Head Screw (8 per unit) (Shield to cage.)	
22	Card Guide	CS-293-1
a.	#4-40 x 3/16 Phil Flat Head Screw (8 per unit) (Guide to cage.)	
23	Card Cage, Rear Panel Assembly	705-313
24	Card Edge Connector #4-40 x 7/16 Phil Pan Head Screw (4 per unit) (Connector to board.) #4-40 x 1/4 Phil Pan Head Screw (4 per unit) (Board to rear panel card cage.) #6-32 x 1/4 Phil Pan Head Screw (4 per unit) (Rear panel to card cage.)	CS-454-2
25	I/O Board Bracket	705-317
26	IEEE-488 Connector	CS-377
a.	Hardware (IEEE-488 Connector)	CS-380
27	Line Power Connector	CS-388
28	Bracket, Heat Sink (Used for VR102 and VR103)	705-321

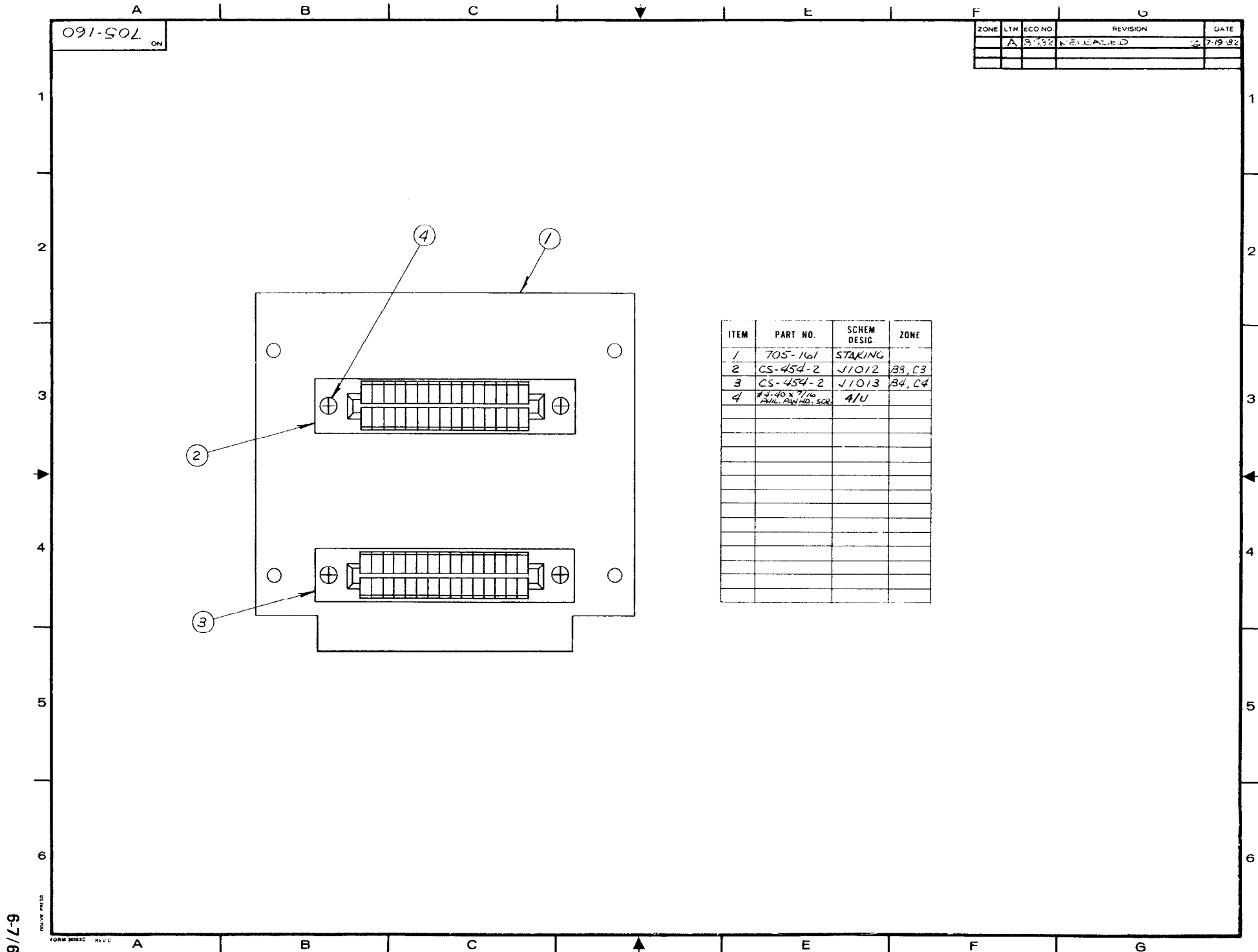

Figure 6-1. Interconnect Board, Component Location Drawing, Dwg. No. 05-160

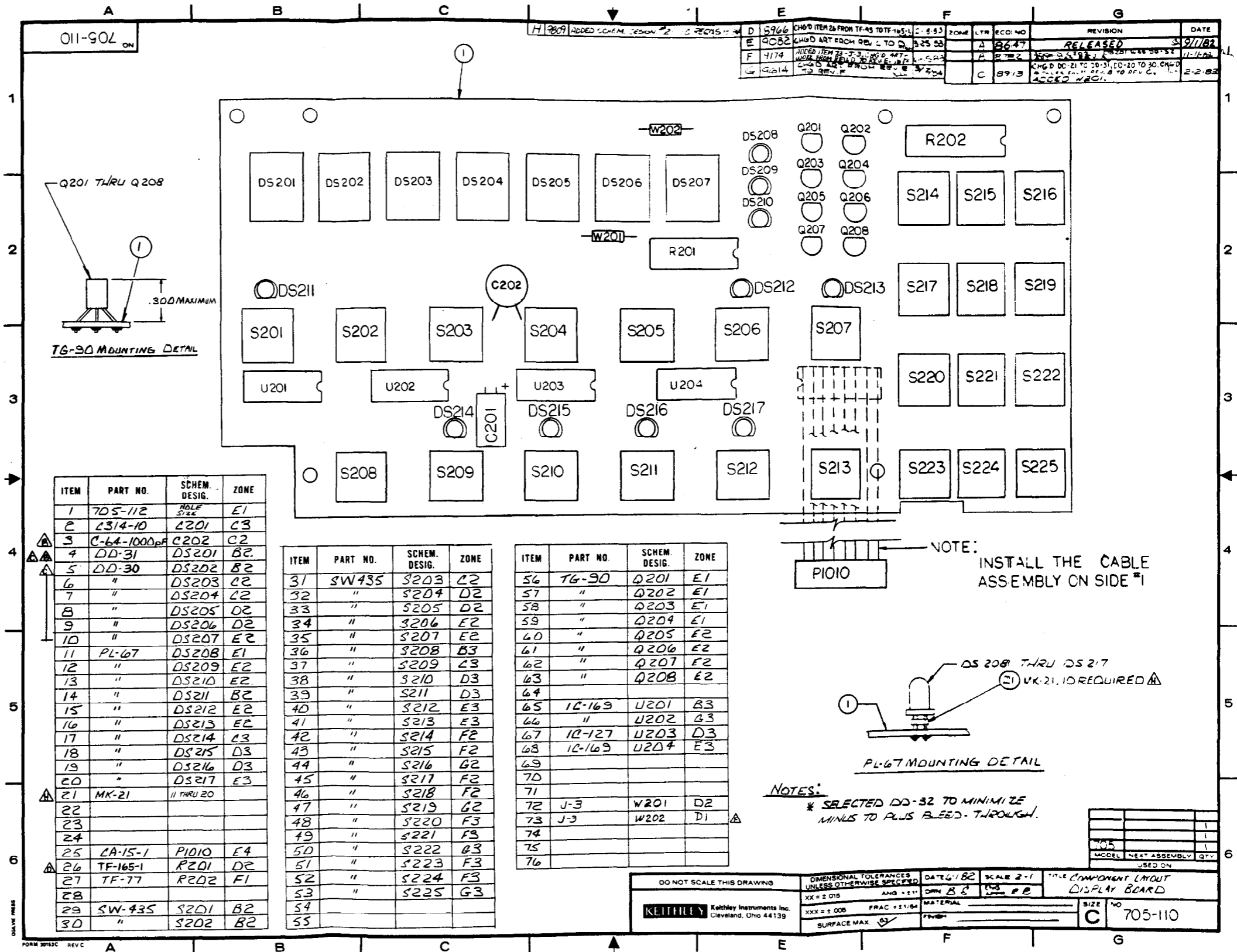
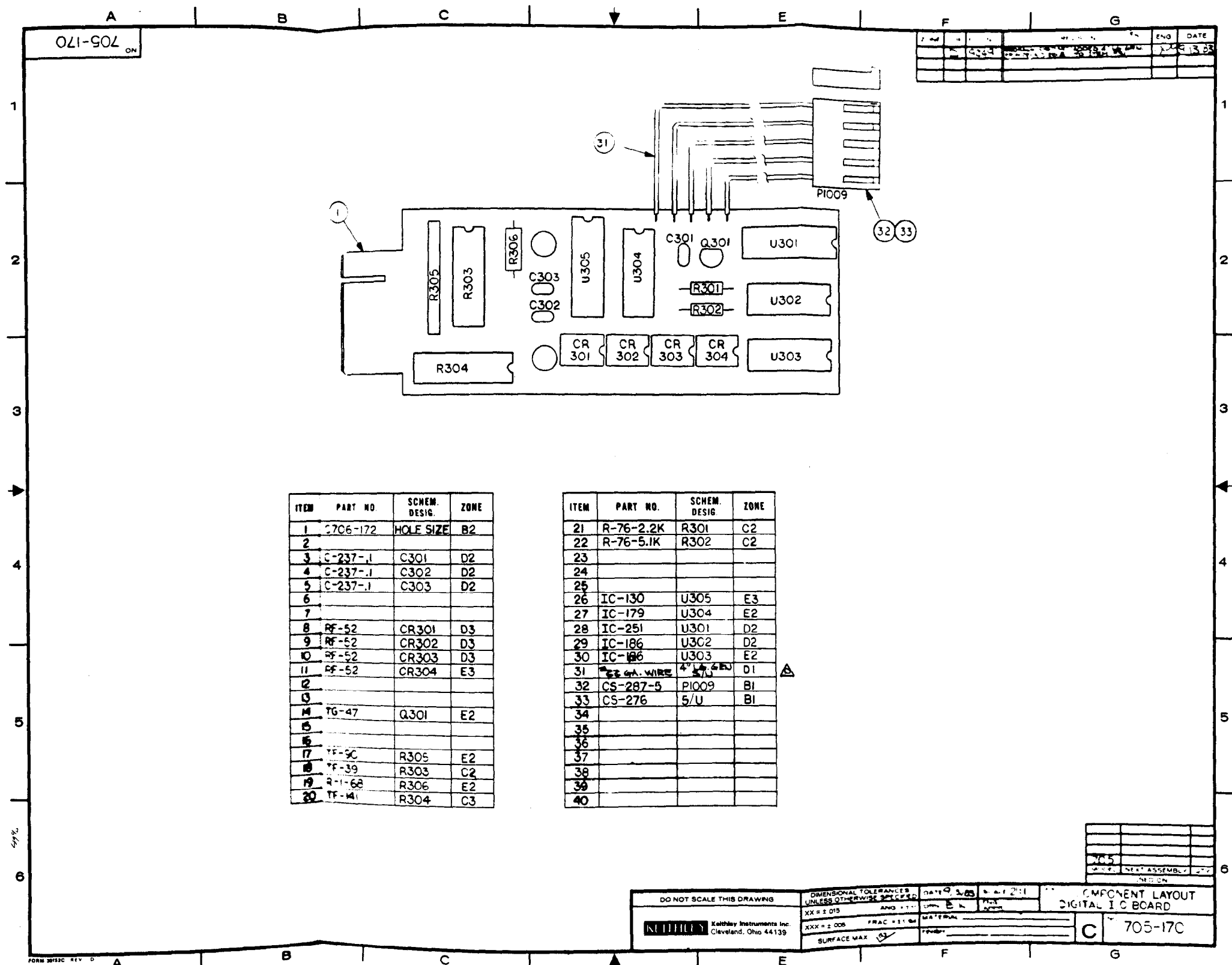

Figure 6-2. Display Board, Component Location Drawing, Dwg. No. 705-110



ITEM	PART NO.	SCHEM. DESIG.	ZONE
1	C706-172	HOLE SIZE	B2
2			
3	C-237-1	C301	D2
4	C-237-1	C302	D2
5	C-237-1	C303	D2
6			
7			
8	RF-52	CR301	D3
9	RF-52	CR302	D3
10	RF-52	CR303	D3
11	RF-52	CR304	E3
12			
13			
14	TG-47	Q301	E2
15			
16			
17	TF-5C	R305	E2
18	TF-39	R303	C2
19	R-1-68	R306	E2
20	TF-M1	R304	C3

ITEM	PART NO.	SCHEM. DESIG.	ZONE
21	R-76-2.2K	R301	C2
22	R-76-5.1K	R302	C2
23			
24			
25			
26	IC-130	U305	E3
27	IC-179	U304	E2
28	IC-251	U301	D2
29	IC-186	U302	D2
30	IC-186	U303	E2
31	22 GA. WIRE	4' L. 4' EU	D1
32	CS-287-5	P1009	B1
33	CS-276	S/U	B1
34			
35			
36			
37			
38			
39			
40			

Figure 6-3. I/O Board, Component Location Drawing, Dwg. No. 705-170

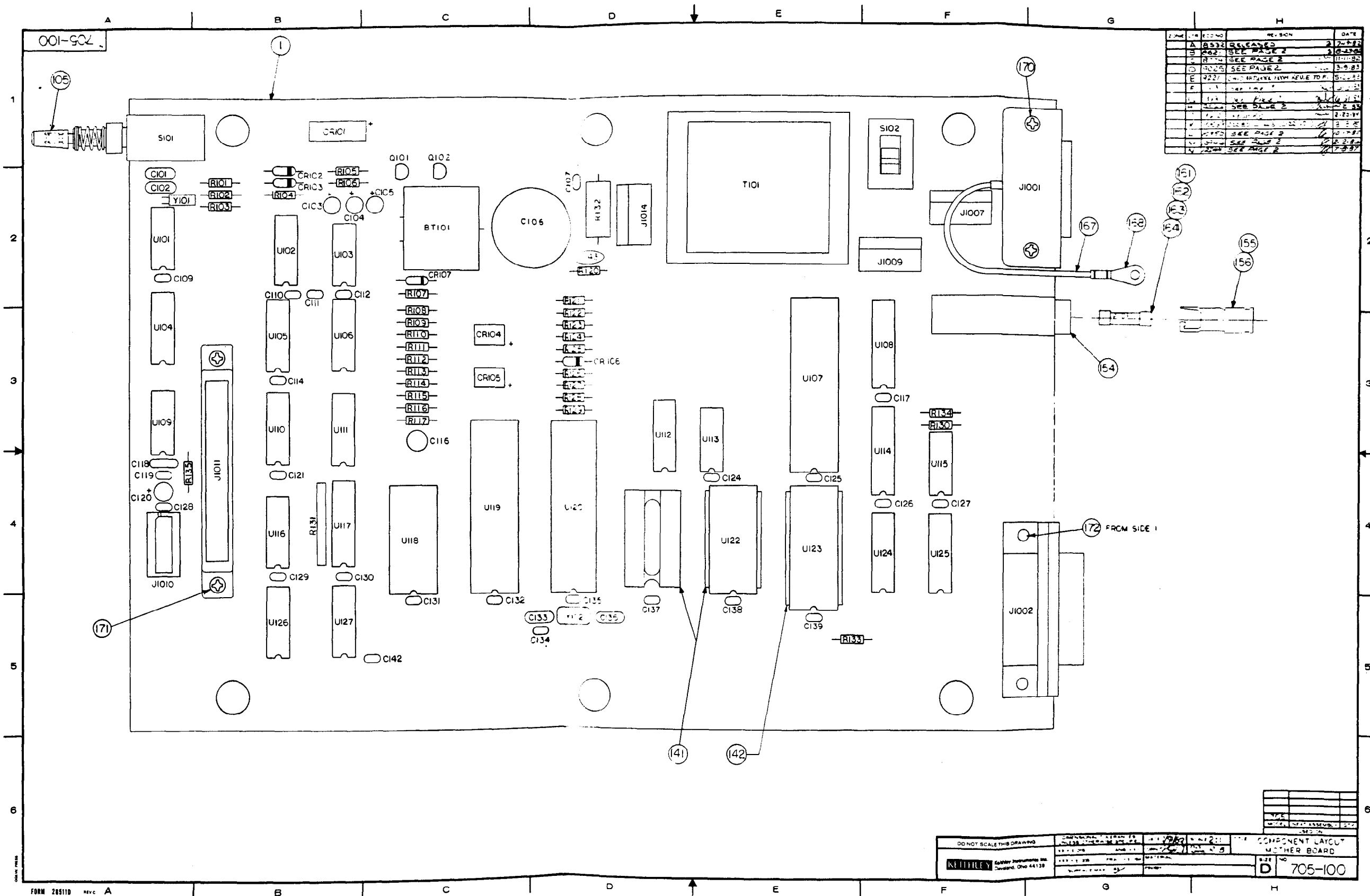
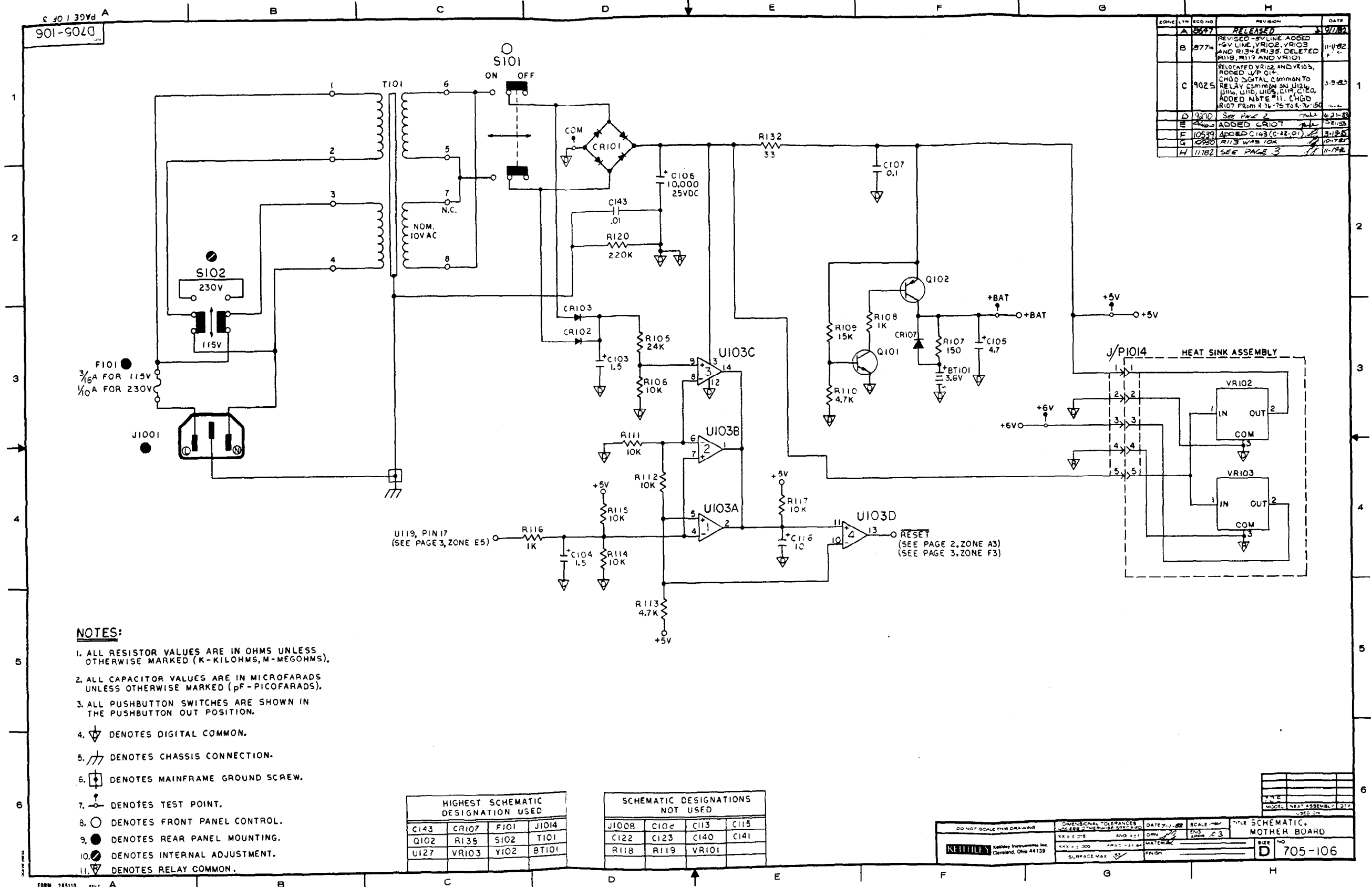

Figure 6-4. Mother Board, Component Location Drawing, Dwg. No. 705-100 (sheet 1 of 2)



ZONE	LYN	REC NO	REVISION	DATE
A	100	1	RELEASED	9/7/62
B	8774		REVISED +5V LINE ADDED +6V LINE, VR102, VR103 AND R13-R135 DELETED R118, R119 AND VR101	11-4-62
C	9025		RELOCATED VR102 AND VR103, ADDED J/P-014. CHGD DIGITAL COMMON TO RELAY COMMON ON VR102 LINE, U103, U104, C100, ADDED NOTE #11. CHGD R107 FROM 2.7K TO 4.7K	3-9-63
D	9270		SEE PAGE 2	6-21-63
E	10539		ADDED CR107	12-1-63
F	10539		ADDED C143 (C-22.0)	3-12-63
G	10550		R118 WAS 70K	10-1-63
H	11782		SEE PAGE 3	11-17-64

- NOTES:**
1. ALL RESISTOR VALUES ARE IN OHMS UNLESS OTHERWISE MARKED (K-KILOHMS, M-MEGOHMS).
 2. ALL CAPACITOR VALUES ARE IN MICROFARADS UNLESS OTHERWISE MARKED (pF-PICOFARADS).
 3. ALL PUSHBUTTON SWITCHES ARE SHOWN IN THE PUSHBUTTON OUT POSITION.
 4. ∇ DENOTES DIGITAL COMMON.
 5. $\text{---}/\text{---}$ DENOTES CHASSIS CONNECTION.
 6. --- DENOTES MAINFRAME GROUND SCREW.
 7. --- DENOTES TEST POINT.
 8. --- DENOTES FRONT PANEL CONTROL.
 9. --- DENOTES REAR PANEL MOUNTING.
 10. --- DENOTES INTERNAL ADJUSTMENT.
 11. --- DENOTES RELAY COMMON.

HIGHEST SCHEMATIC DESIGNATION USED			
C143	CR107	F101	J1014
Q102	R135	S102	T101
U127	VR103	Y102	BT101

SCHEMATIC DESIGNATIONS NOT USED			
J1008	C100	C113	C115
C122	C123	C140	C141
R118	R119	VR101	

DO NOT SCALE THIS DRAWING	DIMENSIONAL TOLERANCES UNLESS OTHERWISE SPECIFIED	DATE: 11-1-62	SCALE: 1" = 1"	TITLE: SCHEMATIC, MOTHER BOARD
KITTELBY	XX ± 0.15 AND ± 0.1	OPN	3/16	NO
	XXX ± 0.300	MATERIAL		SIZE: 705-106
	SURFACE MAX	FINISH		

Figure 6-5. Mother Board, Schematic Diagram, Dwg. No. 705-106 (sheet 1 of 3)

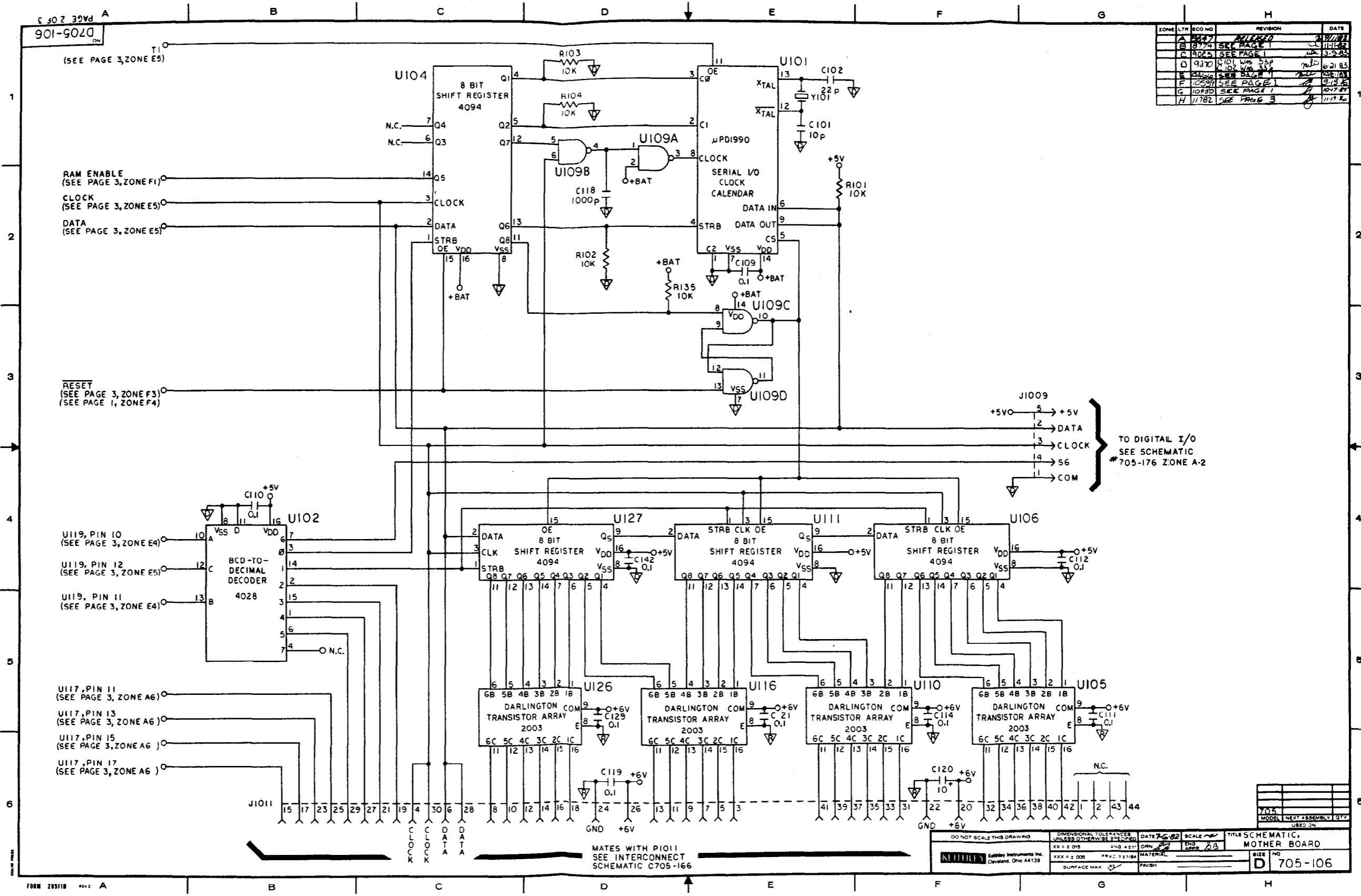

Figure 6-5. Mother Board, Schematic Diagram, Dwg. No. 705-106 (sheet 2 of 3)

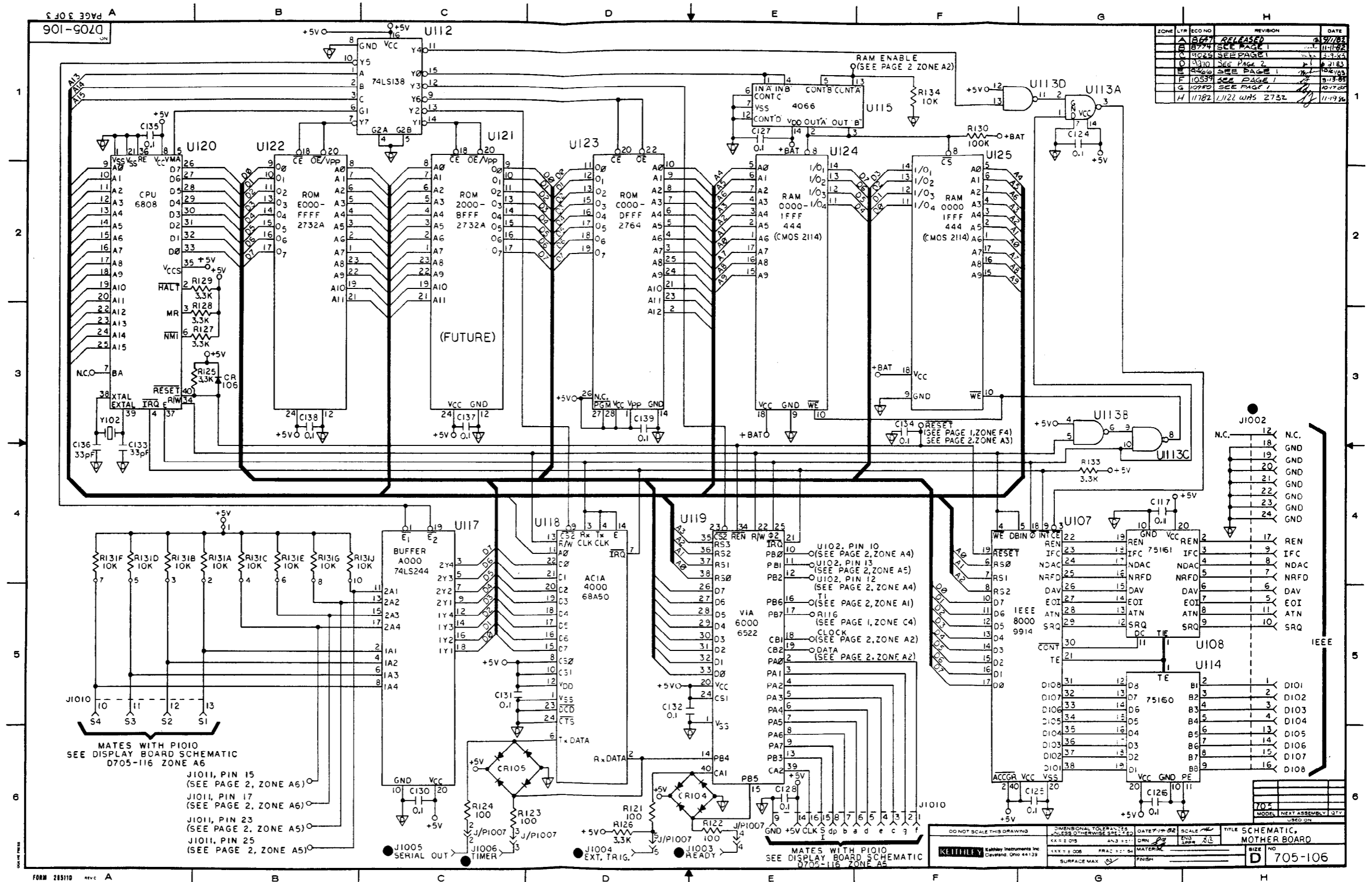

Figure 6-5. Mother Board, Schematic Diagram, Dwg. No. 705-106 (sheet 3 of 3)

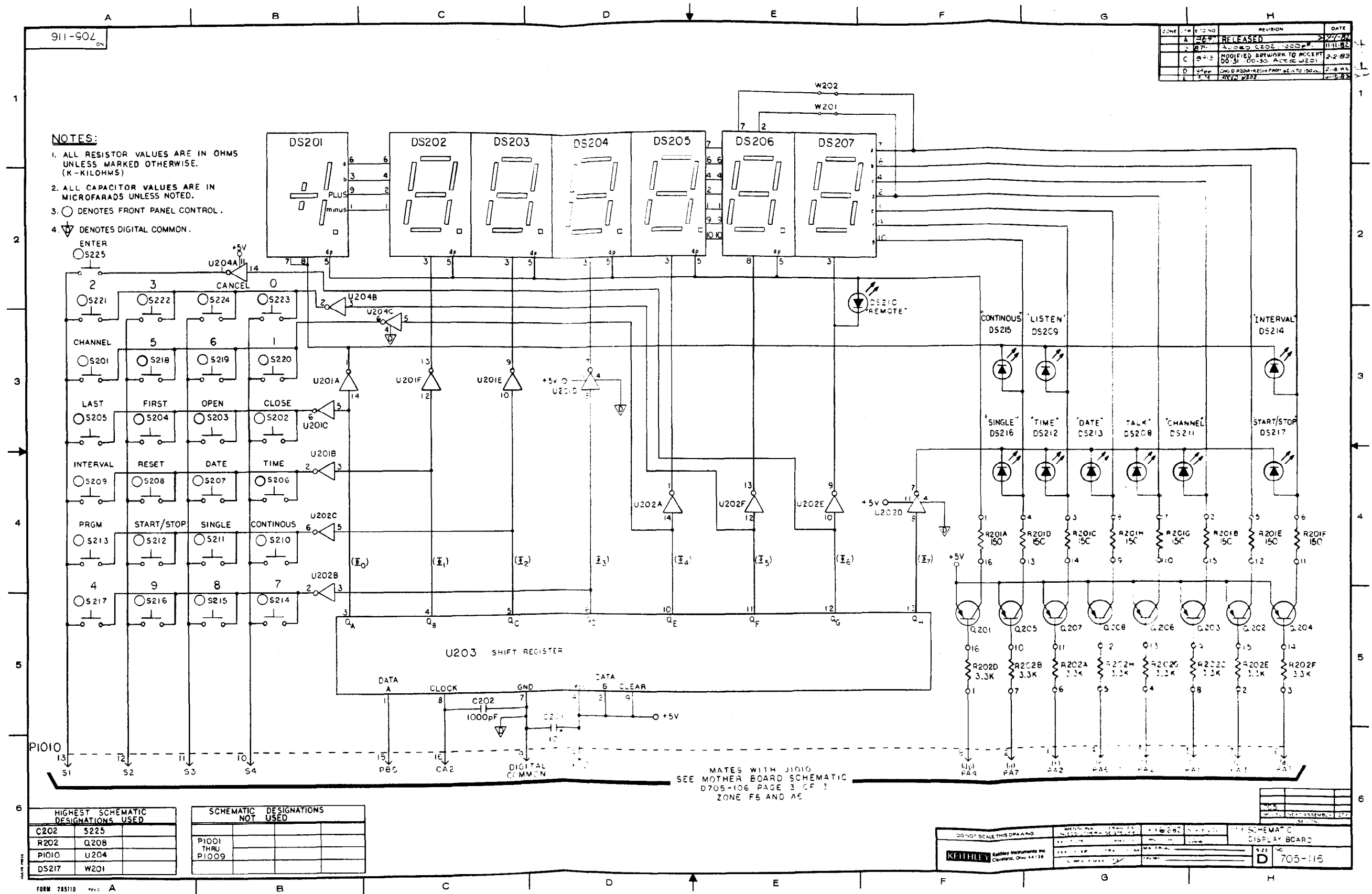
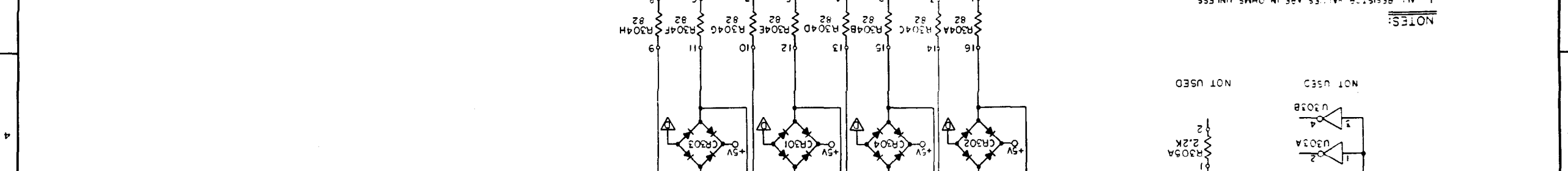
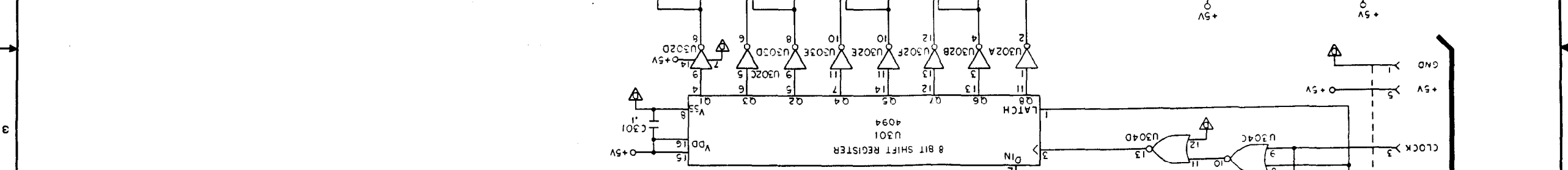
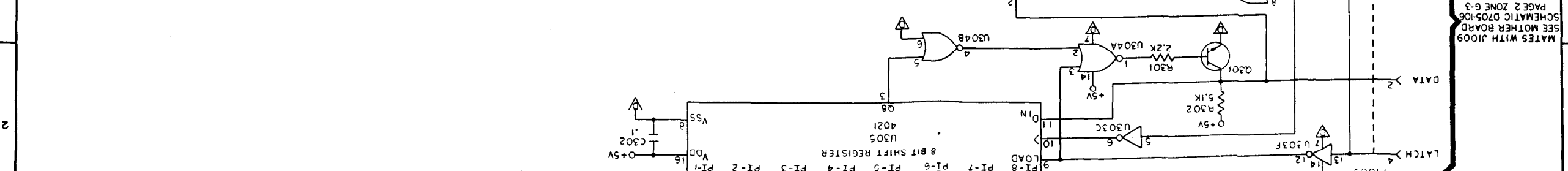
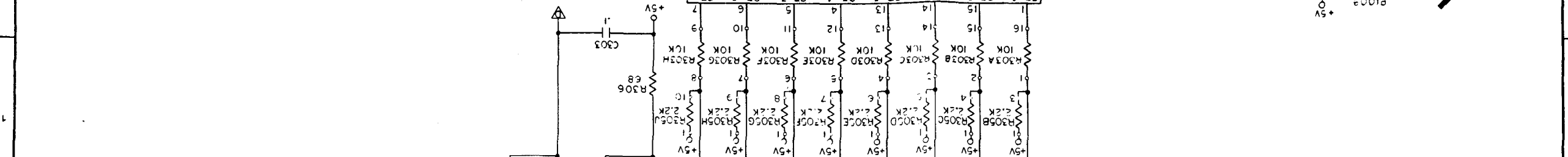

Figure 6-6. Display Board, Schematic Diagram, Dwg. No. 705-116

ZONE	LTR	ECO NO.	REVISION	DATE
A	5671	REL 5/570	1	5/11/83
B	8774	REL 5/570	1	5/11/83



- NOTES:**
1. ALL RESISTOR VALUES ARE IN OHMS UNLESS MARKED OTHERWISE (R=RESISTOR, M=MEG OHMS).
 2. ALL CAPACITOR VALUES ARE IN MICROFARADS UNLESS MARKED OTHERWISE (PF=PICOFARADS).
 3. TRIANGLE SYMBOLS INDICATE COMMON.

HIGHEST SCHEMATIC DESIGNATION USED

U303	C303	P1009
U301	H305	U305

SCHEMATIC DESIGNATIONS NOT USED

U301 THRU J1007	W301
P1001 THRU P1008	

DO NOT SCALE THIS DRAWING

DESIGNER: [Signature]

DATE: 5/11/83

SCALE: 1:1

TITLE: SCHEMATIC

NO. 705

REVISION: 1

DATE: 5/11/83

Figure 6-7. I/O Board, Schematic Diagram, Dwg. No. 705-176

ZONE	LTR	ECO NO	REVISION	DATE
A		8647	RELEASED	3/9/82

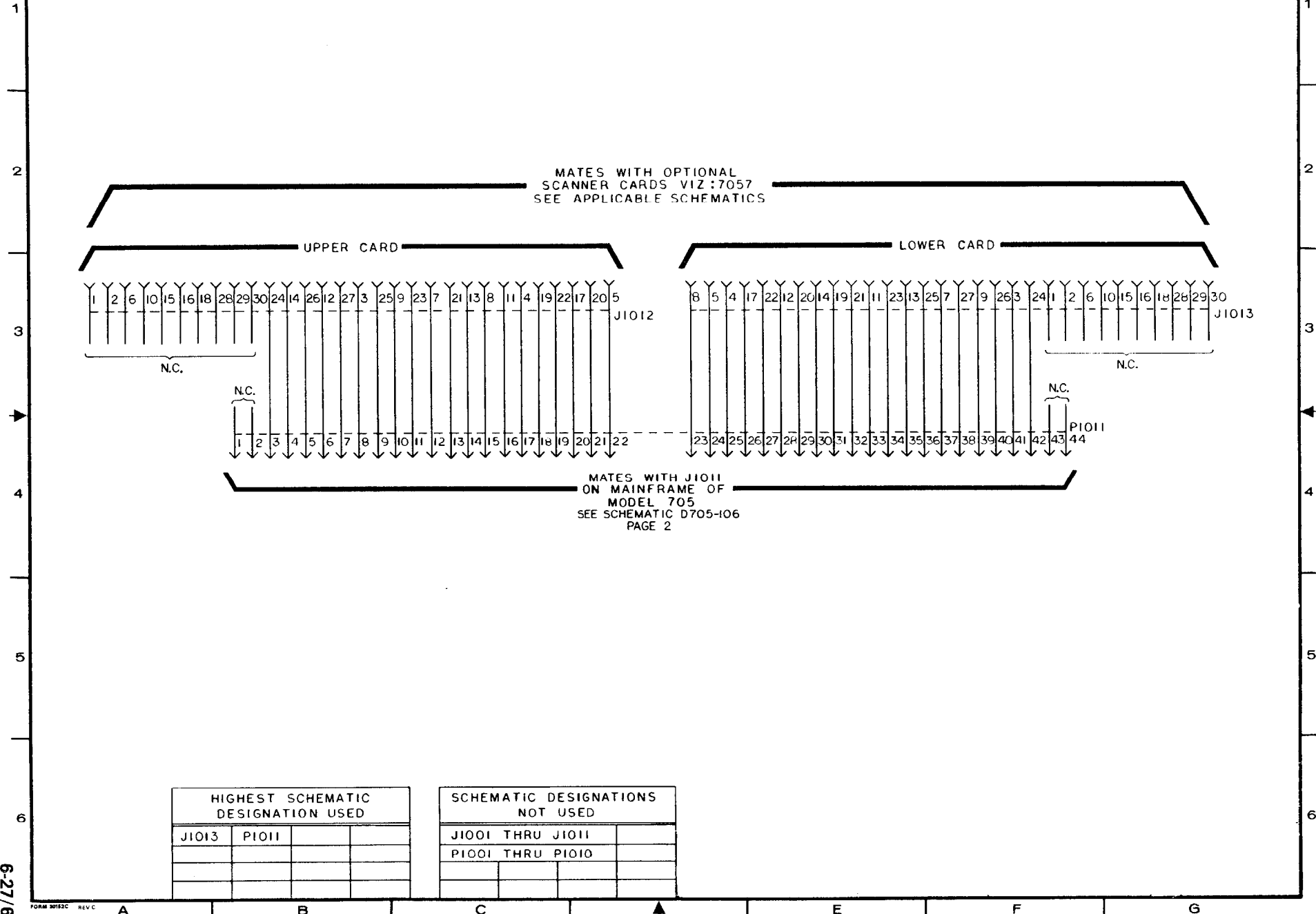

MATES WITH OPTIONAL
SCANNER CARDS VIZ :7057
SEE APPLICABLE SCHFMATICS

UPPER CARD

LOWER CARD

MATES WITH J1011
ON MAINFRAME OF
MODEL 705
SEE SCHEMATIC D705-106
PAGE 2

HIGHEST SCHEMATIC DESIGNATION USED			
J1013	PI011		

SCHEMATIC DESIGNATIONS NOT USED			
J1001 THRU J1011			
PI001 THRU PI010			

6-27/6-28

Figure 6-8. Interconnect Board, Schematic Diagram, Dwg. No. 705-166



SERVICE FORM

Model No. _____ Serial No. _____ Date _____

Name and Telephone No. _____

Company _____

List all control settings, describe problem and check boxes that apply to problem. _____

- Intermittent Analog output follows display Particular range or function bad; specify _____
- IEEE failure Obvious problem on power-up Batteries and fuses are OK
- Front panel operational All ranges or functions are bad Checked all cables

Display or output (circle one)

- Drifts Unable to zero
- Unstable Will not read applied input
- Overload

- Calibration only Certificate of Calibration required
- Data required

(attach any additional sheets as necessary.)

Show a block diagram of your measurement system including all instruments connected (whether power is turned on or not). Also, describe signal source.

Where is the measurement being performed? (factory, controlled laboratory, out-of-doors, etc.)

What power line voltage is used? _____ Ambient Temperature? _____ °F

Relative humidity? _____ Other? _____

Any additional information. (If special modifications have been made by the user, please describe.) _____

Be sure to include your name and phone number on this service form.