

2018 Accessory Catalog

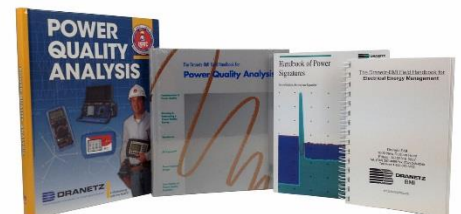

Published by Dranetz
1000 New Durham Road
Edison, NJ 08817 USA
Telephone: 1-800-372-6832 or 732-287-3680
Fax: 732-248-1834
Web site: www.dranetz.com
Copyright ©2017 Dranetz
All rights reserved.

No part of this book may be reproduced, stored in a retrieval system, or transcribed in any form or by any means—electronic, mechanical, photocopying, recording, or otherwise—without prior written permission from the publisher, Dranetz, Edison, NJ 08817.
Printed in the United States of America.

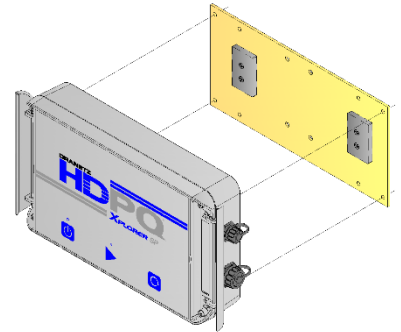

Table of Contents

Dranetz Clamp-on AC only Current Probes	3
Dranetz Clamp-on AC DC Current Probes	4
Dranetz DranFlex Flexible AC Current Probes	5
Dranetz Dranflex Power Supplies	6
HDPQ Miscellaneous Accessories, HDPQ Batteries and Power Adapters	7
HDPQ Measurement Accessories	8
HDPQ Communications Accessories	9
HDPQ Carrying Cases and Enclosures	10
HDPQ Lockable Portable Carrying Case	11
Dranetz IP65 Dranflex Flexible AC Current Probes	12
HDPQ HD Probe Packages	13
HDPQ SP Miscellaneous Accessories, HDPQ SP Battery	14
HDPQ SP Measurement Accessories	15
HDPQ SP Measurement Accessories	16
HDPQ SP Carrying Cases and Enclosures and HDPQ SP Communications Accessories	17
HDPQ SP Mounting Options	18
Portable PX5 Family Measurement Accessories	19
Portable PX5 Family Batteries and Power Adapters	20
Portable PX5 Family Carrying Cases and Enclosures	21
Portable PX5 Family Miscellaneous Accessories and Communications Accessories	22
Encore 61000 Accessories	23
Encore 61000 Batteries and Power Adapters	24
Encore 61000 Voltage and Current Pods	25
Encore 61000 Communication and Time Synchronization Options and Mounting Options	26
Encore 61000 Enclosures Options	27
Dranetz Library	28
Encore Series Software, PQView Software	29
DranView 7 Software	30



Current Probes

Clamp-on - AC only



TR-2500B 10A-500ARMS CT



TR-2501B 100 mA to 1.2ARMS-CT

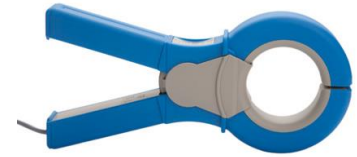

TR-2530B 20A-300ARMS CT

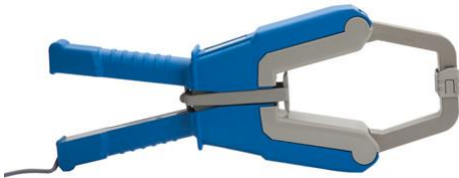

TR-2520B 100A-3000ARMS CT



TR-2510B 1A-10ARMS CT



TR-2550B 1A-100ARMS CT

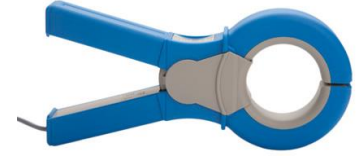

TR-2540B 10A-1000ARMS CT

Model	Range	Amplitude Accuracy ±	Phase Accuracy ±	Frequency Range	Maximum Conductor Size	Rated Voltage	Connector/ Output
Clamp CT's							
TR-2500B	10A to 500Arms	100A to 500A	1%	1.5°	40Hz to 5KHz	50mm dia.	600V Max. Dranetz 1.5V
		10A to 100A	2%	3°			
TR-2501B	100mA to 1.2Arms	1.2A	1.5%	2°	40Hz to 5KHz	15mm dia.	600V Max. Dranetz 1.5V
		100mA	2%	3°			
TR-2510B	1A to 10Arms	5A to 10A	1.2%	1.5°	40Hz to 5KHz	15mm dia.	600V Max. Dranetz 1.5V
		1A to 5A	1.2%	1°			
TR-2520B	100A to 3000Arms	1000A to 3000A	0.5%	0.5°	40Hz to 5KHz	72mm dia.*	600V Max. Dranetz 1.5V
		300A to 1000A	0.75%	0.75°			
		100A to 300A	1.5%	1.5°			
TR-2530B	20A to 300Arms	50A to 300A	1%	0.5°	30Hz to 5KHz	54mm dia.	600V Max. Dranetz 1.5V
		20A to 50A	1.5%	0.6°			
TR-2540B	10A to 1000A	100A to 1000A	1%	0.4°	30Hz to 5KHz	54mm dia.	600V Max. Dranetz 1.5V
		10A to 100A	1.5%	0.5°			
TR-2550B	1A to 100Arms	10A to 100A	1%	2.5°	40Hz to 10KHz	15mm dia.	600V Max. Dranetz 1.5V
		1A to 10A	2%	5°			

Note: These are guidelines only. Many other factors will influence the stated accuracy, including but not limited to, temperature, humidity, frequency, and conductor position. Model numbers and specifications subject to change without notice. TR probes with an "A" suffix have the same specifications as above.

The current probes shown above have a 1.5V output, Dranetz Hypertronics connector, 3 meter cable and are directly compatible with the following Dranetz products:

Portable instruments

Dranetz HDPQ family, PowerXplorer, PowerGuide, PowerVisa, PowerGuia, Energy Platform, PP4300, 658 with CA4300 adapter.

Permanent instruments

Encore 61000 with 61MAC module, Signature System 55XX. Adapters are available for use with other instrument configurations; Please contact Customer Service for details.



AC/DC Current Probes

PR150-SP1B 150A CT
PR1500-SP7B 1500A CT
(Requires one PR9VUS AC adapter for each probe. UK, Euro plugs available.)



PR150-SP2B 150A CT
PR1500-SP8B 1500A CT
(9v battery powered only)



Model	Range		Amplitude Accuracy ±	Phase Accuracy +/-	Frequency Range	Maximum Conductor Size	Rated Voltage	Connector/ Output
PR150B	15A to 150A	15A to 150A	1%	3°	DC to 5KHz	52mm dia.	600V Max.	Dranetz 1.5V
PR1500B	150 to 1500A	150A to 1500A	1%	1°	DC to 5KHz	52mm dia.	600V Max.	Dranetz 1.5V

Note: These are guidelines only. Many other factors will influence the stated accuracy, including but not limited to, temperature, humidity, frequency, and conductor position. Model numbers and specifications subject to change without notice.

The current probes shown above have a 1.5V output, Dranetz Hypertronics connector, 2 meter cable and are directly compatible with the following Dranetz products:

Portable instruments

Dranetz HDPQ family, PowerXplorer, PowerGuide, PowerVisa, PowerGuia, Energy Platform, PP4300, 658 with CA4300 adapter.

Permanent instruments

Encore 61000 with 61MAC module, Signature System 55XX. Adapters are available for use with other instrument configurations; Please contact Customer Service for details.

PR9VUA AC Adapter (for PR Probes Only)



AC power adapter for the PR150 and PR1500 AC/DC probes

Current Probe Accessories

TR PROBE EXTENSION CABLE



TREXT5B	5' Long	TREXT20B	20' Long
TREXT10B	10' Long	TREXT25B	25' Long
TREXT15B	15' Long	TREXT30B	30' Long

ISO-65X-5



0-5A ISO CT Term Box (needs CA4300)

CA4300BNCB



TRTOREDEL



CA4300



Flexible Probes

AC only

Single Phase



Three Phase



DRANFLEX3000XLB 30A/300A/3000A Probe
DRANFLEX6000XLB 60A/600A/6000A Probe
 Available in 24", 36" and 48"

DRANFLEX3003XLB 30A/300A/3000A Probe
DRANFLEX6003XLB 60A/600A/6000A Probe
 Available in 24", 36" and 48"

Model	Range	Amplitude Accuracy ±	Phase Accuracy +/-	Frequency Range	Maximum Conductor Size	Rated Voltage	Connector/ Output
DRANFLEX3000XLB DRANFLEX3003XLB 24/36/48	3A to 3000A (3 Ranges)	3A to 30A	1%rdg, ±0.1A	1°	10Hz to 10KHz	8/11/17in dia.	1000V Max Dranetz 1.5V
		30A to 300A	1%rdg, ±0.1A	1°			
		300A to 3000A	1%rdg, ±1A	1°			
DRANFLEX 6000XLB DRANFLEX 6003XLB 24/36/48	6A to 6000A 3 ranges	6A to 60 A	1%rdg, ±0.1A	1°	10Hz to 10KHz	8/11/17in dia.	1000V Max Dranetz 1.5V
		60A to 600A	1%rdg, ±0.1A	1°			
		600A to 6000A	1%rdg, ±1A	1°			

NOTE: These are guidelines only. Many other factors will influence the stated accuracy, including but not limited to; temperature, humidity, frequency, and conductor position. Model numbers and specifications subject to change without notice.

MicroFlex Probes

AC only-Single phase



DRANFLEX300MHB 3A/30A/300A Probe
 Available in 6", 8" and 12"

Model	Range	Amplitude Accuracy ±	Phase Accuracy +/-	Frequency Range	Maximum Conductor Size	Rated Voltage	Connector/ Output
DRANFLEX300MHB6 DRANFLEX300MHB8 DRANFLEX300MHB12 6/8/12	0.3A to 300A 3 ranges	0.3A to 3A	1%rdg, ± 0.1A	1°	25Hz to 70kHz	2/2.75/4in dia.	1000V MAX Dranetz 1.5V
		3A to 30A	1%rdg, ± 0.1A	1°			
		30A to 300A	1%rdg, ± 0.5A	1°			

Note: These are guidelines only. Many other factors will influence the stated accuracy, including but not limited to; temperature, humidity, frequency, and conductor position. Model numbers and specifications subject to change without notice.

The current probes shown above have a 1.5V output, Dranetz Hypertronics connector, 3 meter cable (2 meters from probe head to Integrator box, 1 meter to instrument) and are directly compatible with the following Dranetz products:

Portable instruments

Dranetz HDPQ family, PowerXplorer, PowerGuide, PowerVisa, PowerGuia, Energy Platform, PP4300, 658 with CA4300 adapter.

Permanent instruments

Encore 61000 with 61MAC module, Signature System 55XX. Adapters are available for use with other instrument configurations;

Please contact Customer Service for details.



DranFlex Power Supplies

(Not required for use with the Dranetz HDPQ family, when Dranflex XLB (blue) probes are used.)

ISOFLEX-MHXL*



Isolated 3 volt power adapter for use with an Instrument's power supply. Does **NOT** include the RR/PS/4A cable for up to 4 probes.

ISOFLEX-MHXL4P*



Isolated 3 volt power adapter for use with an Instrument's power supply. Powers up to four probes

RR/PS/4A



Flex power cable for up to 4 probes.

ISOFLEX-MHXLU



Isolated 3 volt probe power supply. Does **NOT** include the RR/PS/4A cable for up to 4 probes.

ISOFLEX-MHXLU-US - ISOFLEX-MHXLU with a US 125V cord
ISOFLEX-MHXLU-EU - ISOFLEX-MHXLU with an European 250V cord
ISOFLEX-MHXLU-UK - ISOFLEX-MHXLU with a UK 250V cord
ISOFLEX-MHXLU-AU - ISOFLEX-MHXLU with an Australian 250V cord

ISOFLEX-MHXLU4P



Isolated 3 volt power supply with a RR/PS/4A cable for up to four probes.

Not suitable for use with LPC-4300.

ISOFLEX-MHXLU4P-US - ISOFLEX-MHXLU with a US 125V cord
ISOFLEX-MHXLU4P-EU - ISOFLEX-MHXLU with an European 250V cord
ISOFLEX-MHXLU4P-UK - ISOFLEX-MHXLU with a UK 250V cord
ISOFLEX-MHXLU4P-AU - ISOFLEX-MHXLU with an Australian 250V cord

*ISOFLEX-MHXL and ISOFLEX-MHXL4P Isolated power adapters are intended for use with an instruments power supply. Compatible with PX5, PX5-400, PowerGuide, PowerVisa, Energy Platform EP1, and 61STD instruments.





HDPQ Miscellaneous Accessories

USB-FLASH



USB flash drive (Micro)-8GB.

MM-HDPQ Magnetic Mounting Option



Magnetic Mounting Option for HDPQ. (HDPQ unit not included)

118308-G1



HDPQ battery door.

118313-G1 Keyhole Mounting Kit (Standard Accessory)



Keyhole mounting kit for HDPQ

HDPQ Batteries & Power Adapters

BP-HDPQ (Standard Accessory)



Battery for HDPQ-Xplorer400, HDPQ-Xplorer, HDPQ-Guide, and HDPQ-Visa.

PS-HDPQ AC Power Adapter (Standard Accessory)



Instrument power supply for HDPQ-Xplorer400, HDPQ-Xplorer, HDPQ-Guide, and HDPQ-Visa.

External Battery Charger



- XBC-HDPQ-US**
- XBC-HDPQ-EU**
- XBC-HDPQ-UK**
- XBC-HDPQ-AU**

- External battery charger XBC-HDPQ, and US 125V cord only
- External battery charger XBC-HDPQ, European 250V cord, and US 125V cord
- External battery charger XBC-HDPQ, UK 250V cord, and US 125V cord
- External battery charger XBC-HDPQ, Australian, 250V cord, and US 125V cord





HDPQ Measurement Accessories

VCS-HDPQ Voltage Cable Set (Standard Accessory)



Voltage cable set with 4mm connectors.
Compatible with portable and permanent systems with 4mm voltage connectors.

Includes:

- 8 - Six ft. (183cm) measurement cables:
4 Black (901963), 4 White (900370)
- 4 - White alligator clips (901962)
- 4 - Black alligator clips (901794)
- 4 - Black 25 cm stackable jumpers (114013-G1)
- Current and Voltage Wire Marking Kit (WMI-KIT, WMV-KIT)

CVCS-HDPQ Color Voltage Cable Set



Color Voltage cable set with 4mm connectors.
Compatible with portable and permanent systems with 4mm voltage connectors.

Includes:

- 11 - Six ft. (183cm) measurement cables:
4 White (900370), 1 RED (902159-LF), 1 YELLOW (902160-LF), 1 GRAY (902161-LF), 1 BROWN (902162-LF), 1 BLUE (902163-LF), 1 ORANGE (902244-LF) and 1 GREEN (902245-LF).
- 4 - White alligator clips (901962)
- 4 - Black alligator clips (901794)
- 1 - Green alligator clip (902246-LF)
- 4 - Black 25 cm stackable jumpers (114013-G1)
- 1 - Color Ring Label Set (4 white, 4 red, 4 yellow, 4 gray, 4 brown, 4 blue, 4 orange and 4 green)

WMI-KIT



Wire Marker kit for Current Probes, Snap-on, .218 DIA.

WMV-KIT



Wire Marker kit for Voltage Cables, Snap-on, .138 DIA.

WMFV-KIT



Wire Marker kit for Fuse Voltage Kit, Snap-on, .138 DIA.

CL-KIT-HDPQ



HDPQ colored V/I channel label Kit.

White Alligator Clip 901962

(Standard Accessory)



Black Alligator Clip 901794

(Standard Accessory)



Green Alligator Clip 902246-LF

(Supplied with CVCS-HDPQ)



114013-G1 (Standard Accessory)



- 1 - Black 25 cm stackable jumpers

FVA-1K1 Single Fuse Voltage Adapter



In-line fuse adapter for one voltage channel, 4mm connector, 1000V MAX.
Compatible with portable and permanent systems with 4mm voltage connectors.

FVA-1K4



Set of 4 in-line fuse adapters, 4mm connector, 1000V MAX.
Compatible with portable and permanent systems with 4mm voltage connectors.





HDPQ Communications

GPSMAKIT-HDPQ



HDPQ GPS receiver and *magnetic mount GPS antenna*.

USB-MCABLE (Standard Accessory)



USB male A to USB Micro B, 6 foot cable.

ETH-CABLE



Ethernet cable, CAT5, 10 ft.

PQ + Sentry



The Dranetz HDPQ Xplorer 400, Xplorer, and Guide are now capable of integrating with GoPro Hero4 video cameras. With this option, when a Dranetz HDPQ Power Quality Analyzer triggers an event, it then sends a message to the GoPro's camera via Wi-Fi to save a looped video to the GoPro's SD card. The GoPro video can then be viewed or edited by using GoPro Studio, available as a free download from GoPro.

USB-BLUETOOTH (Standard Accessory on HDPQ-Guide, HDPQ-Xplorer and HDPQ-Xplorer400)



USB Bluetooth 2.1 adapter, Class I

ETHX-CABLE



Ethernet crossover cable, CAT5, 10 ft.





HDPQ Carrying Cases and Enclosures

SCC-HDPQ Soft Carry Case



Soft carry case. Storage compartments for the instrument, CT's, voltage cables, and more.

Dimensions:

12" L x 18" W x 9" D

30.5cm L x 45.72cm W x 22.86cm D

RSC-HDPQ



Rugged shipping container with foam inserts and lid organizer. Retractable extension handle with strong polyurethane wheels.

(Does NOT include HDPQ).

Interior dimensions:

19.75" L x 11.00" W x 7.60" D

50.1cm L x 27.9cm W x 19.3cm D

FAA maximum carry on size

ENCL-HDPQ-US

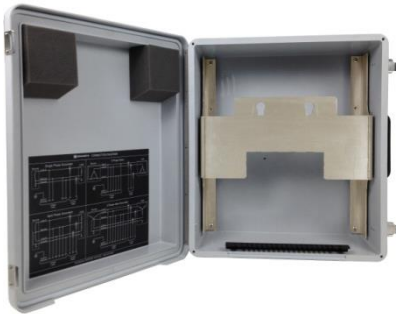

HDPQ weather resistant enclosure, includes 115 volt phase power cable.

Dimensions:

16.75" L x 12" W x 8" D

42.5cm L x 30.5cm W x 20cm D

"Also available with a 230 volt phase power cable:

ENCL-HDPQ-EU "

ENCL-HDPQ-PPA115

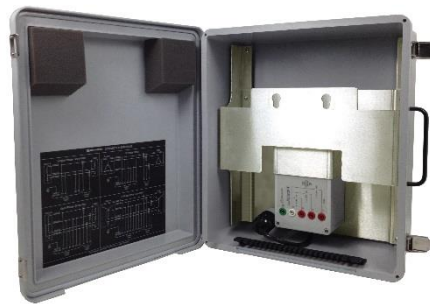

HDPQ weather resistant enclosure, includes a 115 Volt output Phase Power Adapter.

Dimensions:

16.75" L x 12" W x 8" D

42.5cm L x 30.5cm W x 20cm D

"Also available for 230 Volt output: ENCL-HDPQ-PPA230 "

AMPOLEMNT14

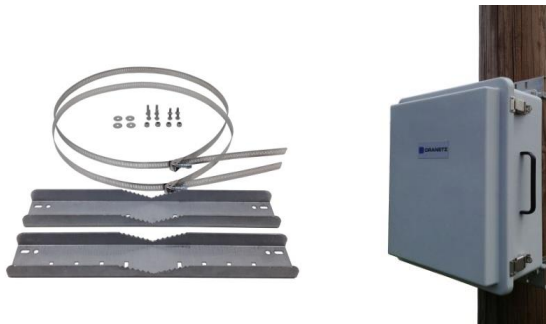

Pole mount kit for ENCL-HDPQ series enclosures, includes mounting hardware.





HDPQ Lockable Portable Carrying Case

LPC-HDPQ



Dranetz HDPQ IP65 enclosure. Includes: power cord and (4) 16" current probe adapter cables. **(Does NOT include HDPQ unit).**
Dimensions: 18.5" L x 14.06" W x 7" D, 46.99cm L x 35.71cm W x 17.8cm D

Models:

LPC-HDPQ-US

Includes: US power cord

LPC-HDPQ-EU

Includes: Euro power cord

LPC-HDPQ-UK

Includes: UK power cord

HDPQ Lockable Portable Carrying Case Optional Accessories

LPC-HDPQ-ETH

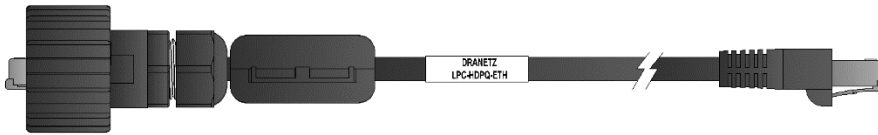

IP65 rated LPC-HDPQ Ethernet cable, 6.5' (2 meters).

LPC-HDPQ-USB



IP65 rated LPC-HDPQ USB cable (male), 6.5' (2 meters).

LPC-HDPQ-USBM

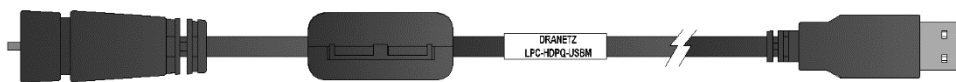

IP65 rated LPC-HDPQ Micro USB cable, 6.5' (2 meters).

LPC-HDPQ-TREXT6



IP65 rated LPC-HDPQ Current adapter extension cable, 6' (1.8 meters).





IP65 Flexible Probes

AC only, for use with LPC-HDPQ or HPPQ-SP.

Single Phase



Three Phase



DRANFLEX3000XLB-IP 30A/300A/3000A Probe
DRANFLEX6000XLB-IP 60A/600A/6000A Probe
Available in 24", 36" and 48"

DRANFLEX3003XLB-IP 30A/300A/3000A Probe
DRANFLEX6003XLB-IP 60A/600A/6000A Probe
Available in 24", 36" and 48"

Model	Range	Amplitude Accuracy ±	Phase Accuracy +/-	Frequency Range	Maximum Conductor Size	Rated Voltage	Connector/ Output
DRANFLEX3000XLB-IP DRANFLEX3003XLB-IP 24/36/48	3A to 3000A (3 Ranges)	3A to 30A	1%rdg, ±0.1A	1°	10Hz to 10KHz	8/11/17in dia.	1000V Max Dranetz 1.5V
		30A to 300A	1%rdg, ±0.1A	1°			
		300A to 3000A	1%rdg, ±1A	1°			
DRANFLEX6000XLB-IP DRANFLEX6006XLB-IP 24/36/48	6A to 6000A 3 ranges	6A to 60 A	1%rdg, ±0.1A	1°	10Hz to 10KHz	8/11/17in dia.	1000V Max Dranetz 1.5V
		60A to 600A	1%rdg, ±0.1A	1°			
		600A to 6000A	1%rdg, ±1A	1°			

NOTE: These are guidelines only. Many other factors will influence the stated accuracy, including but not limited to; temperature, humidity, frequency, and conductor position. Model numbers and specifications subject to change without notice.

IP65 MicroFlex Probes

AC only-Single phase, for use with LPC-HDPQ or HDPQ-SP.



DRANFLEX300MHB-IP 3A/30A/300A Probe
Available in 6", 8" and 12"

Model	Range	Amplitude Accuracy ±	Phase Accuracy +/-	Frequency Range	Maximum Conductor Size	Rated Voltage	Connector/ Output
DRANFLEX300MHB6-IP DRANFLEX300MHB8-IP DRANFLEX300MHB12-IP 6/8/12	0.3A to 300A 3 ranges	0.3A to 3A	1%rdg, ± 0.1A	1°	25Hz to 70kHz	2/2.75/4in dia.	1000V MAX Dranetz 1.5V
		3A to 30A	1%rdg, ± 0.1A	1°			
		30A to 300A	1%rdg, ± 0.5A	1°			

Note: These are guidelines only. Many other factors will influence the stated accuracy, including but not limited to; temperature, humidity, frequency, and conductor position. Model numbers and specifications subject to change without notice.

The current probes shown above have a 1.5V output, IP65 connector, 3 meter cable (2 meters from probe head to IP65 Integrator box, 1 meter to instrument) and are directly compatible with the following Dranetz products:

Portable instruments

Dranetz HDPQ-XPLORER400-A-SP, HDPQ-XPLORER-A-SP, HDPQ-GUIDE-A-SP and HDPQ-VISA-A-SP.

IP65 Lockable Portable Cases

LPC-HDPQ only.

Note: Custom ordered parts – Please contact the Factory for delivery information.





HDPQ Probe Packages

AC Current 4 Phase Flex Probe Packages, Without Power Supply (For use with Dranetz HDPQ only).



MFLEX6PKG-HD

4 – DRANFLEX300MHB6 Single phase flex probe 3/30/300Amp

3A to 300Amp (3 ranges), 1.5V output, Dranetz Hypertronics connector, 2" dia. maximum conductor size, 1000V Max rated.



FLEX3K24PKG-HD

1- DRANFLEX3003XLB24 Three phase flex probe 30/300/3000Amp

3A to 3000Amp (3 ranges), 1.5V output, Dranetz Hypertronics connector, 8" dia. maximum conductor size, 1000V Max rated.

1- DRANFLEX3000XLB24 Single phase flex probe 30/300/3000Amp

3A to 3000Amp (3 ranges), 1.5V output, Dranetz Hypertronics connector, 8" dia. maximum conductor size, 1000V Max rated.



FLEX3K36PKG-HD

1- DRANFLEX3003XLB36 Three phase flex probe 30/300/3000Amp

3A to 3000Amp (3 ranges), 1.5V output, Dranetz Hypertronics connector, 11" dia. maximum conductor size, 1000V Max rated.

1- DRANFLEX3000XLB36 Single phase flex probe 30/300/3000Amp

3A to 3000Amp (3 ranges), 1.5V output, Dranetz Hypertronics connector, 11" dia. maximum conductor size, 1000V Max rated.



FLEX3K48PKG-HD

1- DRANFLEX3003XLB48 Three phase flex probe 30/300/3000Amp

3A to 3000Amp (3 ranges), 1.5V output, Dranetz Hypertronics connector, 17" dia. maximum conductor size, 1000V Max rated.

1- DRANFLEX3000XLB48 Single phase flex probe 30/300/3000Amp

3A to 3000Amp (3 ranges), 1.5V output, Dranetz Hypertronics connector, 17" dia. maximum conductor size, 1000V Max rated.



FLEX6K24PKG-HD

1- DRANFLEX6003XLB24 Three phase flex probe 60/600/6000Amp

6A to 6000Amp (3 ranges), 1.5V output, Dranetz Hypertronics connector, 8" dia. maximum conductor size, 1000V Max rated.

1- DRANFLEX6000XLB24 Single phase flex probe 60/600/6000Amp

6A to 6000Amp (3 ranges), 1.5V output, Dranetz Hypertronics connector, 8" dia. maximum conductor size, 1000V Max rated.



FLEX6K36PKG-HD

1- DRANFLEX6003XLB36 Three phase flex probe 60/600/6000Amp

6A to 6000Amp (3 ranges), 1.5V output, Dranetz Hypertronics connector, 11" dia. maximum conductor size, 1000V Max rated.

1- DRANFLEX6000XLB36 Single phase flex probe 60/600/6000Amp

6A to 6000Amp (3 ranges), 1.5V output, Dranetz Hypertronics connector, 11" dia. maximum conductor size, 1000V Max rated.



FLEX6K48PKG-HD

1- DRANFLEX6003XLB48 Three phase flex probe 60/600/6000Amp

6A to 6000Amp (3 ranges), 1.5V output, Dranetz Hypertronics connector, 17" dia. maximum conductor size, 1000V Max rated.

1- DRANFLEX6000XLB48 Single phase flex probe 60/600/6000Amp

6A to 6000Amp (3 ranges), 1.5V output, Dranetz Hypertronics connector, 17" dia. maximum conductor size, 1000V Max rated.





HDPQ SP Miscellaneous Accessories

USB-FLASH



USB flash drive (Micro)-8GB.

USBMA-OTG USB Micro Adapter



USB Micro Adapter On the Go. (Standard Accessory)

TRTOIP65-EXT1



TR to IP65, 16 inch length, (Qty. 1) Current Probe Adapter Cables. (Standard Accessory)

TRTOIP65-EXT6



TR to IP65, 6 FT length, (Qty. 1) Current Probe Adapter Cables.

ETH-HDPQ-SP

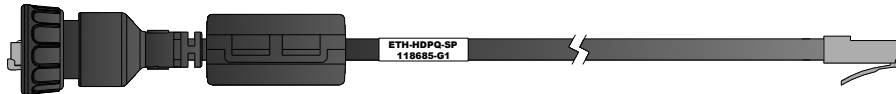

IP65 rated Ethernet cable to be used with HDPQ-SP-Xplorer400, HDPQ-SP-Xplorer, HDPQ-SP-Guide, and HDPQ-SP-Visa.

HDPQ SP Battery

BP-HDPQ-SP (Standard Accessory)



Battery for HDPQ-SP-Xplorer400, HDPQ-SP-Xplorer, HDPQ-SP-Guide, and HDPQ-SP-Visa.



HDPQ SP Measurement Accessories

118707-G1

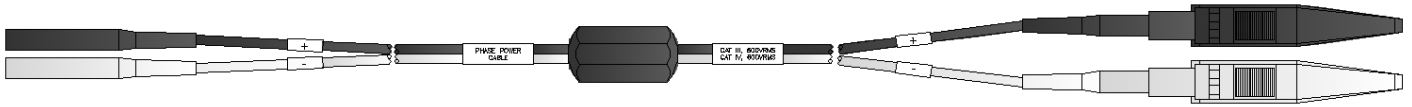

HDPQ-SP CAT IV Phase Power Cables/Clip- Use when powering from a CAT IV source. (Optional Accessory)

118708-G1

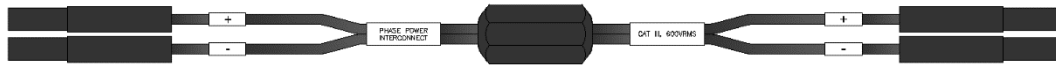

Phase Power Interconnect Cable. (Standard Accessory)

HDPQ-SPPWR-US

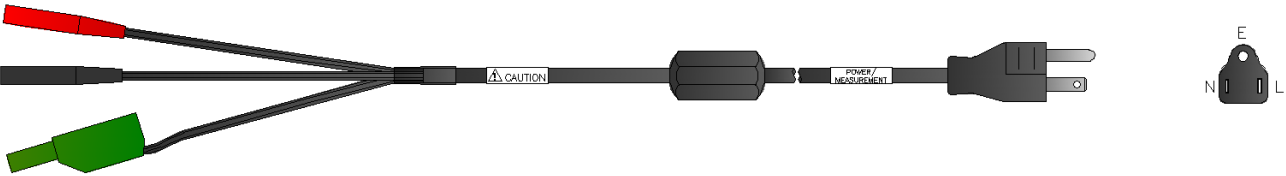

HDPQ-SP US Power Cord, for use when not powering from the phase. (Optional Accessory)

HDPQ-SPPWR-EU

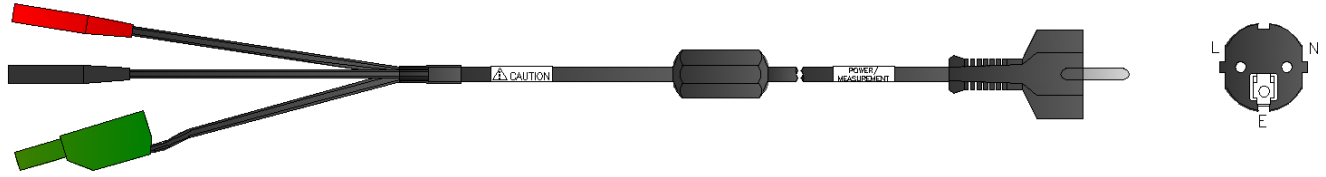

HDPQ-SP Euro Power Cord, for use when not powering from the phase. (Optional Accessory)

HDPQ-SPPWR-UK

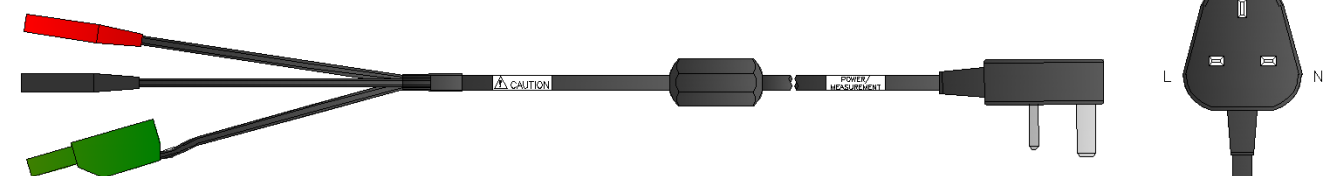

HDPQ-SP UK Power Cord, for use when not powering from the phase. (Optional Accessory)

HDPQ-SPPWR-AU

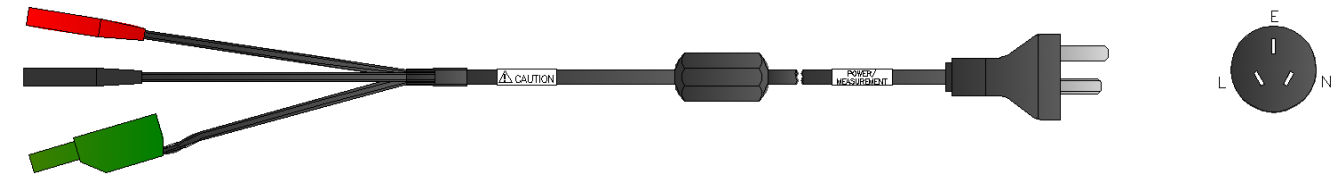

HDPQ-SP AU Power Cord, for use when not powering from the phase. (Optional Accessory)



HDPQ SP Measurement Accessories

VCS-HDPQ Voltage Cable Set (Standard Accessory)



Voltage cable set with 4mm connectors. Compatible with portable and permanent systems with 4mm voltage connectors.

Includes:

- 8 - Six ft. (183cm) measurement cables:
 - 4 Black (901963), 4 White (900370)
- 4 - White alligator clips (901962)
- 4 - Black alligator clips (901794)
- 4 - Black 25 cm stackable jumpers (114013-G1)
- Current and Voltage Wire Marking Kit (WMI-KIT, WMV-KIT)

CVCS-HDPQ Color Voltage Cable Set



Color Voltage cable set with 4mm connectors. Compatible with portable and permanent systems with 4mm voltage connectors.

Includes:

- 11 - Six ft. (183cm) measurement cables:
 - 4 White (900370), 1 RED (902159-LF), 1 YELLOW (902160-LF), 1 GRAY (902161-LF), 1 BROWN (902162-LF), 1 BLUE (902163-LF), 1 ORANGE (902244-LF) and 1 GREEN (902245-LF).
- 4 - White alligator clips (901962)
- 4 - Black alligator clips (901794)
- 1 - Green alligator clip (902246-LF)
- 4 - Black 25 cm stackable jumpers (114013-G1)
- 1 - Color Ring Label Set (4 white, 4 red, 4 yellow, 4 gray, 4 brown, 4 blue, 4 orange and 4 green)

WMI-KIT



Wire Marker kit for Current Probes, Snap-on, .218 DIA.

WMV-KIT



Wire Marker kit for Voltage Cables, Snap-on, .138 DIA.

WMFV-KIT



Wire Marker kit for Fuse Voltage Kit, Snap-on, .138 DIA.

CL-KIT-HDPQ



HDPQ colored V/I channel label Kit.

White Alligator Clip 901962

(Standard Accessory)



Black Alligator Clip 901794

(Standard Accessory)



Green Alligator Clip 902246-LF

(Supplied with CVCS-HDPQ)



114013-G1 (Standard Accessory)



- 1 - Black 25 cm stackable jumpers

FVA-1K1 Single Fuse Voltage Adapter



In-line fuse adapter for one voltage channel, 4mm connector, 1000V MAX. Compatible with portable and permanent systems with 4mm voltage connectors.

FVA-1K4



Set of 4 in-line fuse adapters, 4mm connector, 1000V MAX. Compatible with portable and permanent systems with 4mm voltage connectors.





HDPQ SP Carrying Cases and Enclosures

SCC-HDPQ Soft Carry Case



Soft carry case. Storage compartments for the instrument, CT's, voltage cables, and more.

Dimensions:
12" L x 18" W x 9" D
30.5cm L x 45.72cm W X 22.86cm D

RSC-HDPQ-SP



Rugged shipping container with foam inserts
(Does NOT include HDPQ SP UNIT and HDPQ SP cable pouch).

Dimensions:
20.62" L x 16.82" W x 8.12" D
52.4 cm L x 42.8 cm W x 20.6 cm D

HDPQ SP Communications

GPSMA-HDPQ



HDPQ-SP GPS Magnetic Mount GPS Antenna.

USB-BLUETOOTH-SP

(Standard Accessory on HDPQ Guide SP, HDPQ Xplorer SP and HDPQ Xplorer 400 SP)



USB Bluetooth 2.1 adapter, Class I

GPS-HDPQ-SP



HDPQ-SP GPS Receiver. Must be specified at time of order. (Factory Installed Option)

GPSMAKIT-HDPQ-SP



HDPQ-SP GPS Receiver plus a Magnetic Mount GPS Antenna. Must be specified at time of order. (Factory Installed Option)





HDPQ SP Mounting Options

HDPQ SP Magnetic Mount MM-HDPQ-SP

The Magnetic Mounting optional accessory **MM-HDPQ-SP** allows the Dranetz HDPQ-SP Instrument to be attached to ferromagnetic Metallic surfaces.

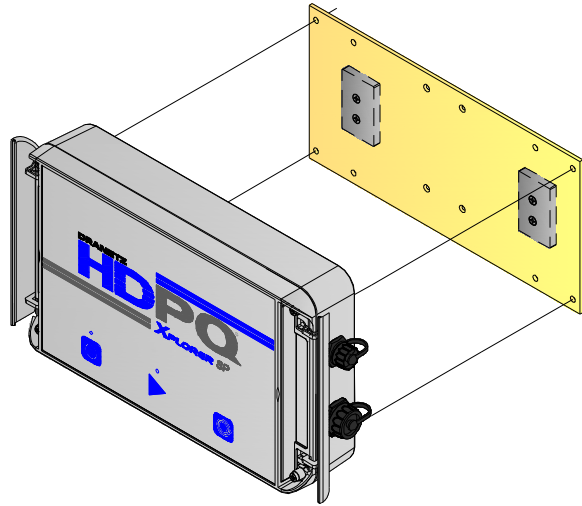

HDPQ SP Din-Rail Mount DIN-HDPQ-SP

The DIN Rail Mounting optional accessory **DIN-HDPQ-SP** allows the Dranetz HDPQ-SP Instruments to be attached to a 35mm wide Standard DIN rail mount.

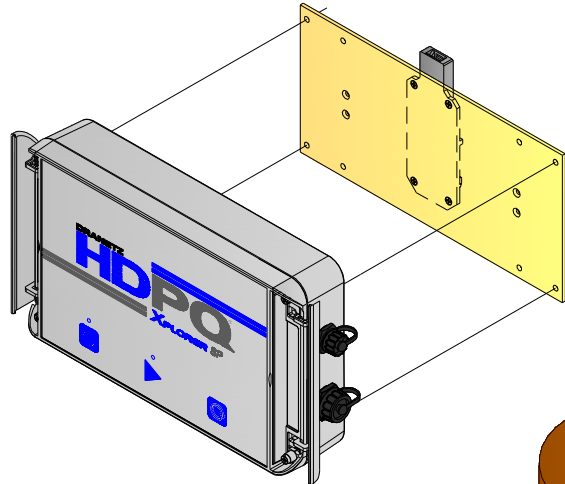

HDPQ SP Pole Mount PM-HDPQ-SP

The Pole Mounting optional accessory **PM-HDPQ-SP** allows the Dranetz HDPQ-SP Instruments to be attached to many pole shapes and sizes up through 15" diameter.

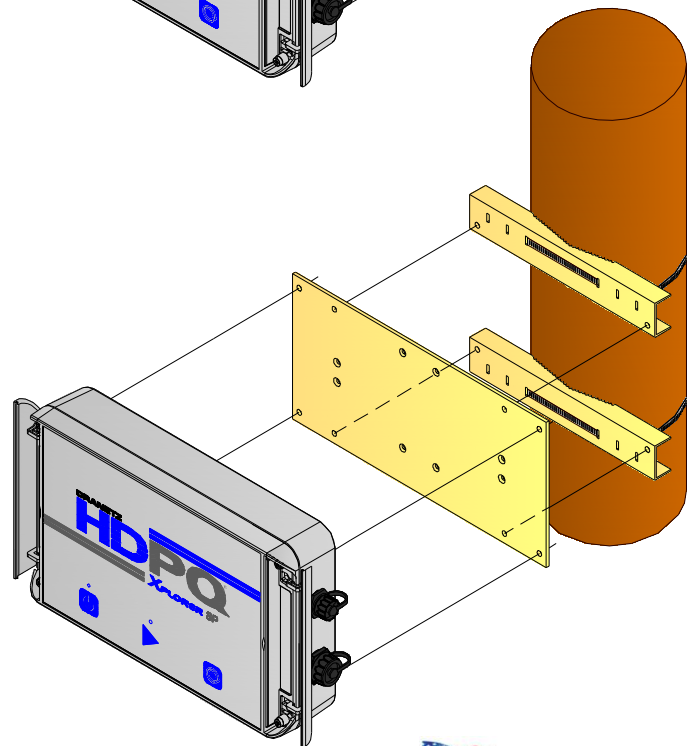



Portable PX5 Family Measurement Accessories

PX5 Cable Pouch (Standard Accessory) 116042-G3



Voltage cable set with 4mm connectors.
Compatible with portable and permanent systems with 4mm voltage connectors.

- Includes:**
- 8 - Six ft. (183cm) measurement cables:
1 Red (900366), 1 Yellow (900367), 1 Blue (900368), 1 Gray (900369), 4 White (900370)
 - 4 - Red alligator clips (900371)
 - 4 - Black alligator clips (900372)
 - 4 - Black 25 cm stackable jumpers (114013-G1)

EP1 Cable Pouch (Standard Accessory) 116042-G6



Voltage cable set with 4mm connectors.
Compatible with portable and permanent systems with 4mm voltage connectors.

- Includes:**
- 6 - Six ft. (183cm) measurement cables:
1 Red (900366), 1 Yellow (900367), 1 Blue (900368), 1 Gray (900369), 2 White (900370)
 - 4 - Red alligator clips (900371)
 - 2 - Black alligator clips (900372)
 - 1 - Black 25 cm stackable jumpers (114013-G1)

VCP-4300



- 1 - US voltage cable with 4mm connectors to measure one single phase circuit
- 4 - Black 25 cm stackable jumpers

114013-G1 (Standard Accessory)



- 1 - Black 25 cm stackable jumpers

FVA-1K1 Single Fuse Voltage Adapter



In-line fuse adapter for one voltage channel, 4mm connector, 1000V MAX.
Compatible with portable and permanent systems with 4mm voltage connectors.



**Red Alligator Clip
900371**
(Standard Accessory)



**Black Alligator Clip
900372**
(Standard Accessory)

114890-G1



Voltage safety clip set

FVA-1K4



Set of 4 in-line fuse adapters, 4mm connector, 1000V MAX.
Compatible with portable and permanent systems with 4mm voltage connectors.





Portable PX5 Family Single Phase Measurement Cables

114015-G1
US

114015-G2
EURO

114015-G3
UK

114015-G4
AUSTRALIA



Voltage cable with 4mm connectors to measure one single phase circuit.
Compatible with portable and permanent systems with 4mm Voltage connectors.

83003967



Phase Power AC cord with 4mm connectors .

Portable PX5 Family Batteries & Power Adapters

BP-PX5 (Standard Accessory)



Battery for PowerXplorer PX5, PowerGuide, PowerVisa, and EP1.

PX5 AC Adapter 117029-G1 (Standard Accessory)



Instrument power supply for PowerXplorer PX5, PowerGuide, PowerVisa, and EP1.

PPA-PP1R/115 Phase Power Adapter



Power the instrument from the phase being measured. For circuits from 90V to 530V rms.

Dimensions:
4.3"L x 7.1"W x 3.6"D
(10.9cm x 18cm x 9.1cm)

Compatible with portable and permanent systems.

PPA-PP1R/230 Phase Power Adapter



Power the instrument from the phase being measured. For circuits from 90V to 530V rms.

Dimensions:
4.3"L x 7.1"W x 3.6"D
(10.9cm x 18cm x 9.1cm)

Compatible with portable and permanent systems.





Portable PX5 Family Carrying Cases and Enclosures

SCC-4300 Soft Carry Case



Soft carry case. Storage compartments for the instrument, CT's, voltage cables, and more.

Dimensions:
12" L x 18" W x 9" D
30.5cm L x 45.72cm W X 22.86cm D

RSC-PX5



Rugged shipping container with foam inserts
(Does NOT include PX5 and PX5 cable pouch).

Dimensions:
20.62" L x 16.82" W x 8.12" D
52.4 cm L x 42.8 cm W x 20.6 cm D

LPC-PX5B



Dranetz LPC-PX5B IP65 enclosure. Includes: power cord and (4) 16" current probe adapter cables.

(Does NOT include PX5 unit or current probes).

Dimensions: 18.5" L x 14.06" W x 7" D, 46.99cm L x 35.71cm W x 17.8cm D

Models:

LPC-PX5B-US Includes: US power cord

ENCL-HH

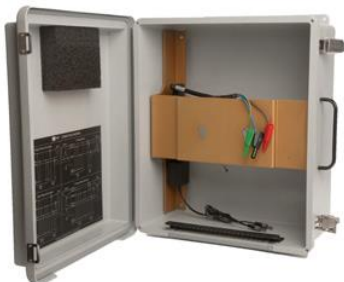

Weather resistant enclosure.

Dimensions:
16.75" L x 12" W x 8" D
42.5cm L x 30.5cm W x 20cm D

AMPOLEMNT14

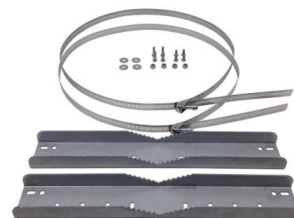

ENCL-HH Pole mount kit, includes mounting Hardware.





Portable PX5 Family Miscellaneous Accessories

CFDATA-DB CF Data Card



4 GB CF Data card
Compatible with portables only.

FlashReader-USB



USB CF card reader.

901122



PCMCIA Compact flash adapter.

117169-G1



PX5 dust cover door.

116037-G1



PX5 battery door.

Portable PX5 Family Communications

COMM-RS232



Fiber optic to RS232 adapter
(Not for use with the EP1)

COMM-OUA



Fiber optic to USB adapter
(Not for use with the EP1)





Encore 61000 Accessories



61STD mainframe shown using a DC3VFLEX cable to power 4 flex CT's

DC3VFLEX



Power supply cable to power up to 4 flex CT's from the 61000

TRTO55



TR Type Current cable adapter for Dranetz clamp & flex CT's

PODEXTKIT



Voltage & Current POD Extension Cable
Requires connector kit + wire (charged per foot) 50 ft max
116836-G1 Connector kit. One per cable
901084 Wire. Enter # of feet. (50 ft max)



61SG or 61SGD mainframe shown using a DC3VFLEX cable to power 4 flex CT's

FLEXPWRHUB



Hub to allow the 61000 to power up to 12 flex CT's. Must use with DC3VFLEX (117067-G1) cable

BNCTO55



Current cable adapter with BNC connector

116439-G1



Cable to use 8010 Current Modules with Encore Series

Voltage Cable Pouch 116042-G1

Voltage cable set with 4mm connectors. *Compatible with portable and permanent systems with 4mm voltage connectors.*

***FOR USE WITH 61MVB**

Includes:

- 8 - Six ft. (183cm) measurement cables:
1 Red, 1 Yellow, 1 Blue, 1 Gray, 4 White
- 4 - Red alligator clips
- 4 - Black alligator clips





Encore 61000 Batteries & Power Adapters

BP-61000



Battery for Encore 61000 Encore products.

61PSDC-SB



Encore 61STD Mainframe Power supply for substations. 120-300VDC Max, 60W.

61000 AC Adapter 117029-G3



Instrument Power Supply for Encore 61STD and 61STD-PQ.

61DINPWR12VDC Din Rail power supply



This power supply is supplied with a low voltage cable that plugs into the back of the Encore Series 61000 instrument. This power supply provides a 12 VDC output that powers the instrument and is capable of being secured to a DIN rail TS35/7.5 or TS35/15. 85-264VAC or 90-375VDC input, 12 VDC output

Power Supply Options for 61STD only

- 61PSAC-US** 100-250VAC Power supply, US AC Power Cord
- 61PSAC-EURO** 100-250VAC Power supply, EURO AC Power Cord
- 61PSAC-UK** 100-250VAC Power supply, UK AC Power Cord
- 61PSAC-AUST** 100-250VAC Power supply, AUST AC Power Cord

PPA-PP1R/115 Phase Power Adapter

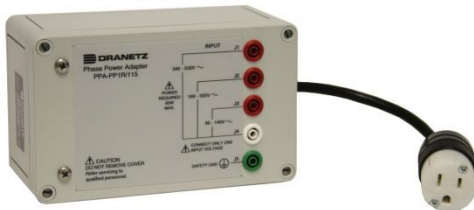

Power the instrument from the phase being measured. For circuits from 90V to 500Vrms.

Dimensions:
4.3"L x 7.1"W x 3.6"D
(10.9cm x 18cm x 9.1cm)

Compatible with portable and permanent systems.

PPA-PP1R/230 Phase Power Adapter



Power the instrument from the phase being measured. For circuits from 90V to 500Vrms.

Dimensions:
4.3"L x 7.1"W x 3.6"D
(10.9cm x 18cm x 9.1cm)

Compatible with portable and permanent systems.





Encore 61000 Voltage Pods

5536 Voltage Pod



5536VPOD

- 4 differential Inputs
- Accepts four 5 - 600 Vrms (AC/DC), 1000 Vpk
- Phase A, B, C voltage, plus neutral to ground
- Neutral to ground voltage range: 0.5 - 20 Vrms (AC/DC)
- Accuracy $\pm 0.1\%$ of reading $\pm 0.05\%$ full scale

5539 Voltage Pod



5539VPOD

- 4 differential Inputs
- Accepts four 5 - 1000 Vrms (AC/DC), 1414 Vpk
- Phase A, B, C voltage, plus neutral to ground
- Neutral to ground voltage range: 0.5 - 20 Vrms (AC/DC)
- Accuracy $\pm 0.1\%$ of reading $\pm 0.05\%$ full scale

Encore 61000 Current Pods

5533 Current Pod



5533APOD

- 4 differential Inputs
- Accepts four 0.01-5 Arms, 100 Apk
- Allows pass thru wire up to #10 AWG
- The current tube diameter is 0.215" (5.461mm)
- Accuracy $\pm 0.1\%$ of reading $\pm 0.05\%$ full scale
- 20X over current, High fault current application

5534 Current Pod



5534APOD

- 4 differential Inputs
- Accepts four 0.01-1 Arms, 5A pk
- Allows connection up to #12 AWG wire
- Accuracy $\pm 0.1\%$ of reading $\pm 0.05\%$ full scale

5537 Current Pod



5537APOD

- 4 differential Inputs
- Accepts four 0.01-5 Arms, 25A pk
- Allows connection up to #12 AWG wire
- Accuracy $\pm 0.1\%$ of reading $\pm 0.05\%$ full scale

5538 Current Pod



5538APOD

- Same as 5537APOD with one 'TR' connector for Ch. D
- 4 differential Inputs
- Accepts four 0.01-5 Arms, 25A pk
- Allows connection up to #12 AWG wire
- Accuracy $\pm 0.1\%$ of reading $\pm 0.05\%$ full scale
- Typically for DC Current measurement on a UPS





Encore 61000 Communication and Time Synchronization Options

GPS Antenna Cable Assembly



- 61GPSANT10** - GPS antenna 10' cable, only for use on mainframes with GPS receiver.
- 61GPSANT25** - GPS antenna 25' cable, only for use on mainframes with GPS receiver.
- 61GPSANT50** - GPS antenna 50' cable, only for use on mainframes with GPS receiver.
- 61GPSANT100** - GPS antenna 100' cable, only for use on mainframes with GPS receiver.

10BTSTD



10 Base T standard 6' cable

10BTNUL



10 Base T Null 6' cable

61MDM



External 56K modem

Encore 61000 Mounting Options

61RMTS

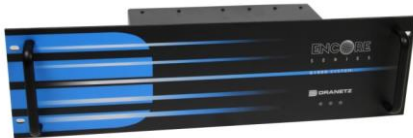

61STD 19" Rack mount without display

61RMTD



61STD 19" Rack mount with 1/4 VGA touch display

61SGRMT



Front view

61SG/61SGD 19" Rack mount



Back view

61BRKTS



61STD Wall mounting Brackets (pair)





Encore 61000 Enclosure Options

61QENCL

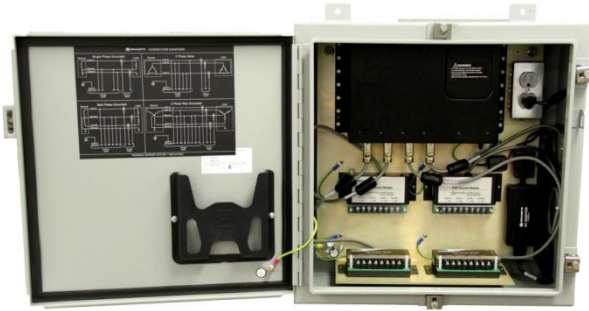

Metal weather resistant enclosure.
Fits one 61STD mainframe and up to 4 Voltage or Current Pods.
Dimensions:
20" L x 20" W x 8" D
(50.8cm x 50.8cm x 20cm)

61WENCL



Weather resistant enclosure.
Dimensions:
16.75" L x 12" W x 8" D
(42.5cm x 30.5cm x 20cm)

AMPOLEMNT14

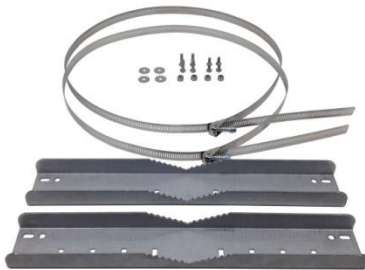

61WENCL Pole mount kit.



Dranetz Library

Power Quality Analysis

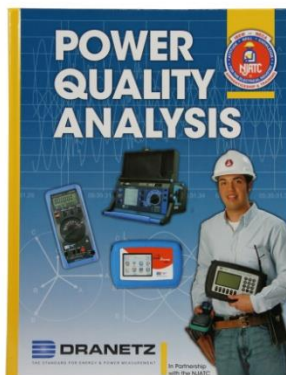

HB114416 Written in partnership with the NJATC, 228 pages.

The Dranetz Field Handbook for Power Quality Analysis

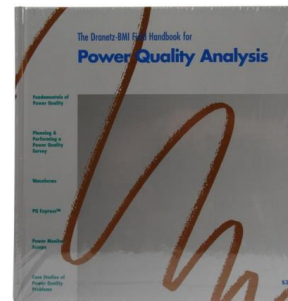

HB114414-S Learn the methodology for a successful power monitoring survey, as well as how to establish and maintain a power quality program, 283 pages.

The Dranetz BMI field handbook for electrical energy management

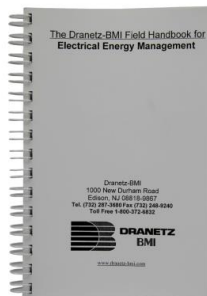

HB114415 This handbook explores proven energy management techniques useful in a variety of applications.

Handbook of Power Signatures

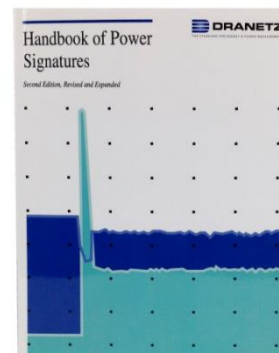

A-010S Learn to interpret and solve AC power problems, 290 pages.

Handbook Set

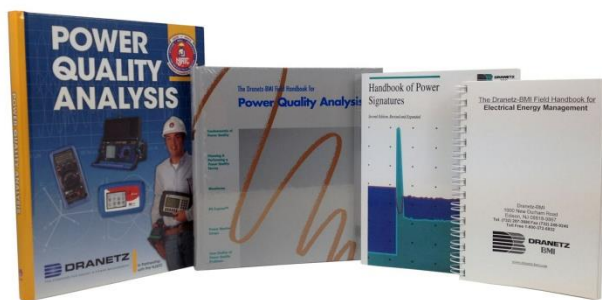

All 4 of the above handbooks.



Encore Series Software

The heart of Encore Series is its web browser-based Encore Series Software. This advanced, intelligent software is both a system controller and a user interface for your entire system. Encore Series Software can be used in any application, from small systems with a few instruments to very large multi-point, facility-wide or utility monitoring systems with 50 or more points. Encore Series Software automatically communicates with each instrument in your system via all supported communications methods to download and store data. Encore Series Software is also a password-protected web server that acts as the gateway to your Encore System. All user interactions with the system such as trending, reports, real time and setups are done using any web browser with connectivity to the system. The multi-user interface allows co-workers, engineers or consultants simultaneous access to analyze and share data and reports within a familiar web environment.



Encore Series Software

Encore Series Software for use with Encore Series or Signature System on a user supplied PC. Web server. HASP Key.

Encore Series Energy Software

Encore Series Energy Software for use with Energy Data Nodes only. Includes Energy Usage Answer Module, SW MODBUS, web server. HASP Key. For use on a user supplied PC only.

PQView® Software

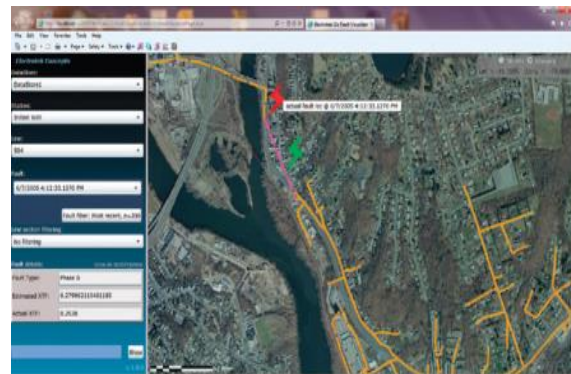
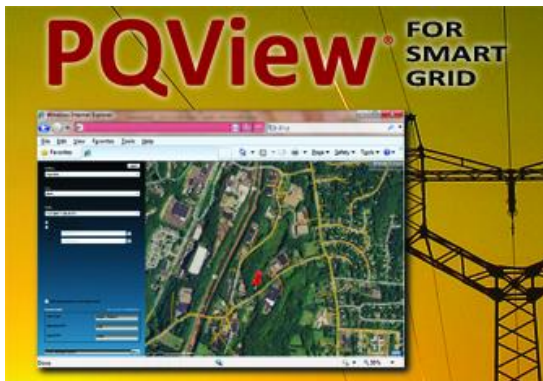

PQView®

PQView® is enterprise software available to expand the analytical capabilities of Dranetz Encore Series and/or manage multiple monitoring systems. Developed by Electrotek Concepts and EPRI®, PQView is a database software application designed to store and analyze large quantities of power quality-related disturbance and steady-state measurement data from hundreds of monitoring points. Featuring data management tools that can quickly characterize this data, PQView includes statistical analysis and plotting tools that can provide single- or multiple-site analysis for power systems. Encore Series, Signature System, PQNode family, Dranetz portable instruments, IEEE PQDIF, IEEE COMTRADE and many non Dranetz meters are PQView compatible. PQView® is a multi-component software system developed by Electrotek Concepts® and EPRI®. This industry leading software is used for building and analyzing databases of power, power quality, and energy measurements, and is available for use with Dranetz Encore instrument configurations. PQView also integrates data from microprocessor relays, digital fault recorders, power quality monitors, smart meters, and SCADA historians into an open relational database.



Portable Equipment Software



Dran-View 7 PRO for the following instruments: all Dranetz HDPQ products, PowerVisa, PG4400, PX5, PX5-400, EP1, 4300, PP1, 658, DRANLINK PP1/658, Measuring Pad. Includes DranSet 2.



Dran-View 7 ENTERPRISE for the following instruments: all Dranetz HDPQ Products, PowerVisa, PG4400, PX5, PX5-400, EP1, 4300, PP1 and 658 and DRANLINK PP1/658, PQDIF, COMTRADE, Text Files and includes DRANLINK PP1/658, Measuring Pad. Includes PQDIF Writer. Includes DranSet 2.

Dran-View® 7

Features and comparison of DV7 Professional with DV7 Enterprise

Description	DV7 Professional	DV7 Enterprise
User Interface		
Ribbon bar - Modern appearance	●	●
Scrollable (rubber band) chart axes	●	●
View Trends, Waveforms, Magnitude/Duration and DFT	●	●
Chart area marking tool	●	●
Format templates provides unified layout	●	●
Event filtering/sorting	●	●
Drag and drop charts, axes etc.	●	●
Insert pictures and photos	●	●
Floating notations (balloons) with user defined text or data	●	●
Customizable toolbars, keyboard shortcuts and menus.	●	●
File and System features		
64 bit program (Optimized for 64 or 32 bit systems)	●	●
Support for large data files	●	●
Automatic updates via Internet	●	●
Compatible with most Dranetz legacy products and Dran-View 6	●	●
Reads PQDIF and COMTRADE files	●	●
Reads tabulated text files	●	●
REMOVE partial data from measurement	●	●
Report Writing		
Basic report writer modules	●	●
Monitoring mode specific reports	●	●
Integrated text editor (RTF-editor)	●	●
Snapshots / Bookmarks	●	●
Add selected events and trends to report	●	●
Reports against EN, IEC, G5/4, NVE standards	●	●
Multi-Site Report Writing	●	●
Multi-Site Capabilities		
Presentation of up to 16 simultaneous data sets	●	●
Multi-Site events filter (find events occurred at several locations)	●	●
Multi-Site time synchronization	●	●
Mathematical comparisons between data sets (difference etc.)	●	●
Rescue Kit (Data repair)		
Adjust timestamps	●	●
Flip current probes	●	●
Change scaling factors	●	●
Change connection type	●	●
Mathematical		
Calculate trends and harmonics from waveform data	●	●
Separate harmonic scaling for voltage, current and power	●	●
Enhanced DFT features - Analyze harmonic spectra in the signal	●	●
Mathematical formulas (calculate leakage current etc)	●	●
Mathematical comparisons between multiple sites	●	●





Dranetz - The Standard for Energy & Power Management

For more than 50 years, Dranetz has been the leading provider of intelligent monitoring solutions for electrical demand, energy and power quality. With over 100,000 clients worldwide, Dranetz's scalable solutions range from portable power quality analysis equipment, to permanent energy management devices with data storage and web-based solutions. Dranetz provides a full suite of services, including personalized pre- and post-sales support, educational power quality seminars, consulting, customization and on-site assistance.

Dranetz corporate headquarters, located in Edison, New Jersey USA, includes sales, product support and manufacturing, with distributors and sales representatives located globally. Dranetz proudly manufactures their products in the USA, and is also a global supplier of [Gossen Metrawatt \(GMC-I\)](#) electrical test and measurement products.

View our power quality analyzers, energy monitoring systems, electrical safety testers, electrical digital multifunction meters and more at www.Dranetz.com (categorized by function to easily determine the Dranetz product that is the right tool for your needs).



N01